

# AN EVALUATION OF PERFORMANCE REQUIREMENTS FOR CROSS TIES AND FASTENERS

RECEIVED

OCT 9 1979

LIBRARY



DECEMBER 1978

INTERIM REPORT

This document is available to the public through  
The National Technical Information Service,  
Springfield, Virginia 22161

Prepared for  
**U.S. DEPARTMENT OF TRANSPORTATION**  
**FEDERAL RAILROAD ADMINISTRATION**  
Office of Research and Development  
Washington, D.C. 20590

#### NOTICE

The contents of this report reflect the views of Battelle-Columbus Laboratories, and Bechtel Incorporated, which are responsible for the facts and the accuracy of the data presented herein. The contents do not necessarily reflect the official views of the Department of Transportation. This report does not constitute a standard, specification, or regulation.

#### NOTICE

The United States Government does not endorse products or manufacturers. Trade or manufacturers' names appear herein solely because they are considered essential to the object of this report.

1. Report No. FRA/ORD-78/37		2. Government Accession No.		3. Recipient's Catalog No.	
4. Title and Subtitle AN EVALUATION OF PERFORMANCE REQUIREMENTS FOR CROSS TIES AND FASTENERS				5. Report Date December, 1978	
				6. Performing Organization Code DTS-744	
7. Author(s) Robert H. Prause,* James C. Kennedy,* and Robert C. Arnlund**				8. Performing Organization Report No.	
9. Performing Organization Name and Address *Battelle-Columbus Laboratories **Bechtel Inc. 505 King Avenue Columbus OH 43201  50 Beale Street San Francisco CA 94119 (Subcontractor)				10. Work Unit No. (TRAIS)	
				11. Contract or Grant No. DOT-TSC-1044	
12. Sponsoring Agency Name and Address U. S. Department of Transportation Federal Railroad Administration Office of Research and Development Washington, DC 20590				13. Type of Report and Period Covered Interim Report June 1977 - February 1978	
				14. Sponsoring Agency Code RRD-32	
15. Supplementary Notes *Under Contract to: U.S. Department of Transportation Transportation Systems Center Kendall Square Cambridge MA 02142					
16. Abstract:  This report was prepared as part of the Improved Track Structures Research Program managed by the Transportation Systems Center. This program is sponsored by the Office of Rail Safety Research, Improved Track Structures Research Division, of the Federal Railroad Administration. The report evaluates the technical basis for current tie and fastener specifications. Particular emphasis was placed on correlating track load data and service failure modes with tie/fastener strength requirements. This required a detailed review of the failure history and laboratory tests for the early, intermediate and new concrete tie designs used in several North American test installations. Limitations of current specifications are identified and specific modifications are recommended. A brief review of the development and performance of reconstituted timber ties and steel ties is also included.					
17. Key Words Track Loading, Track Design, Concrete Cross Ties, Track Components, Rail Fasteners, Steel Cross Ties, Concrete Tie Performance, Tie Specifications			18. Distribution Statement Document is available to the U. S. Public through the National Technical Information Service, Springfield, VA 22161		
19. Security Classif. (of this report) UNCLASSIFIED		20. Security Classif. (of this page) UNCLASSIFIED		21. No. of Pages 113	22. Price

0248i

TF  
256  
\*C6  
P72

## PREFACE

This report was prepared by Battelle's Columbus Laboratories (BCL) and Bechtel, Incorporated, under Contract No. DOT-TSC-1044 as part of the Improved Track Structures Research Program (ITSRP) managed by the Department of Transportation, Transportation Systems Center (TSC). This program is sponsored by the Office of Rail Safety Research, Improved Track Structures Research Division, of the Federal Railroad Administration, Washington, D.C.

The overall objective of this program is to conduct research necessary to evaluate and improve the safety and serviceability of railroad track. Work on this contract, which is part of the ITSRP, includes an evaluation of the technical and economic feasibility of using synthetic cross ties and rail fastener assemblies to obtain improved component life and long-term performance. This report includes an assessment of current design/performance specifications for tie/fastener systems based on the performance history of concrete tie track in the U. S. This is the fifth interim report for this contract.

The first interim report (FRA/ORD-77/03) was a planning document for a track measurement project. The second interim report (FRA/ORD-77/71) covered the review and selection of track analysis models for predicting track response and included a statistical description of concrete tie track loads from measurements made on the Florida East Coast Railway. The third interim report (FRA/ORD-77/75) was a parametric analysis of track response which included the effect of variations in the principal track design variables of tie size, tie spacing, and ballast depth. The fourth interim report was an economic analysis of wood and concrete tie track to determine the justifiable cost of concrete ties as a function of track and traffic conditions.

Dr. Andrew Kish and Mr. Donald McConnell of the Transportation Systems Center were the technical monitor and alternate technical monitor, respectively, for the work reported herein. Their cooperation and suggestions are gratefully acknowledged. Acknowledgement also goes to Mr. John Weber and Mr. Howard Moody for their many useful comments.

## METRIC CONVERSION FACTORS

### Approximate Conversions to Metric Measures

Symbol	When You Know	Multiply by	To Find	Symbol
<b>LENGTH</b>				
in	inches	2.5	centimeters	cm
ft	feet	30	centimeters	cm
yd	yards	0.9	meters	m
mi	miles	1.6	kilometers	km
<b>AREA</b>				
in <sup>2</sup>	square inches	6.5	Square centimeters	cm <sup>2</sup>
ft <sup>2</sup>	square feet	0.09	square meters	m <sup>2</sup>
yd <sup>2</sup>	square yards	0.8	square meters	m <sup>2</sup>
mi <sup>2</sup>	square miles	2.6	square kilometers	km <sup>2</sup>
	acres	0.4	hectares	ha
<b>MASS (weight)</b>				
oz	ounces	28	grams	g
lb	pounds	0.45	kilograms	kg
	short tons (2000 lb)	0.9	tonnes	t
<b>VOLUME</b>				
tsp	teaspoons	5	milliliters	ml
Tbsp	tablespoons	15	milliliters	ml
fl oz	fluid ounces	30	milliliters	ml
c	cups	0.24	liters	l
pt	pints	0.47	liters	l
qt	quarts	0.95	liters	l
gal	gallons	3.8	liters	l
ft <sup>3</sup>	cubic feet	0.03	cubic meters	m <sup>3</sup>
yd <sup>3</sup>	cubic yards	0.76	cubic meters	m <sup>3</sup>
<b>TEMPERATURE (exact)</b>				
°F	Fahrenheit temperature	5/9 (after subtracting 32)	Celsius temperature	°C

\*1 in = 2.54 (exactly). For other exact conversions and more detailed tables, see NBS Misc. Publ. 256, Units of Weights and Measures, Price \$2.25, SD Catalog No. C13.10286.

### Approximate Conversions from Metric Measures

Symbol	When You Know	Multiply by	To Find	Symbol
<b>LENGTH</b>				
mm	millimeters	0.04	inches	in
cm	centimeters	0.4	inches	in
m	meters	3.3	feet	ft
m	meters	1.1	yards	yd
km	kilometers	0.6	miles	mi
<b>AREA</b>				
cm <sup>2</sup>	square centimeters	0.16	square inches	in <sup>2</sup>
m <sup>2</sup>	square meters	1.2	square yards	yd <sup>2</sup>
km <sup>2</sup>	square kilometers	0.4	square miles	mi <sup>2</sup>
ha	hectares (10,000 m <sup>2</sup> )	2.5	acres	
<b>MASS (weight)</b>				
g	grams	0.035	ounces	oz
kg	kilograms	2.2	pounds	lb
t	tonnes (1000 kg)	1.1	short tons	
<b>VOLUME</b>				
ml	milliliters	0.03	fluid ounces	fl oz
l	liters	2.1	pints	pt
l	liters	1.06	quarts	qt
l	liters	0.26	gallons	gal
m <sup>3</sup>	cubic meters	35	cubic feet	ft <sup>3</sup>
m <sup>3</sup>	cubic meters	1.3	cubic yards	yd <sup>3</sup>
<b>TEMPERATURE (exact)</b>				
°C	Celsius temperature	9/5 (then add 32)	Fahrenheit temperature	°F

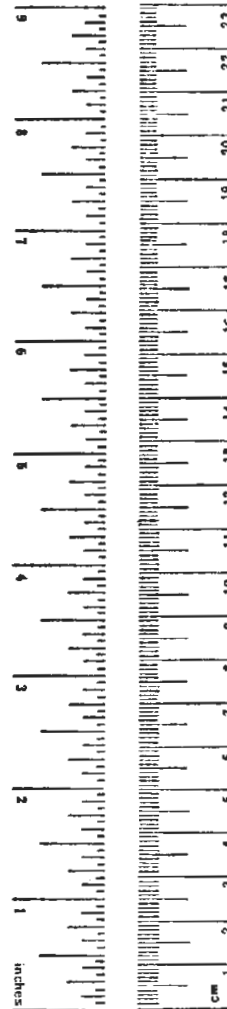
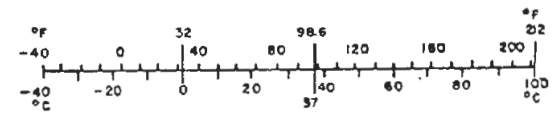

CONTENTS

	<u>Page</u>
1. INTRODUCTION . . . . .	1
2. SUMMARY OF RESULTS AND CONCLUSIONS . . . . .	2
2.1 Performance History of Concrete Ties and Fasteners . . . . .	2
2.2 Tie and Fastener Specifications . . . . .	3
2.3 Alternative Materials for Tie/Fastener Systems . . . . .	5
2.4 Future Research Requirements . . . . .	6
3. CONCRETE TIE AND FASTENER PERFORMANCE . . . . .	7
3.1 Concrete Tie Installations . . . . .	7
3.2 Tie/Fastener Failure Modes . . . . .	12
3.3 Early Tie Design and Performance . . . . .	16
3.4 Intermediate Tie Design and Performance . . . . .	21
3.4.1 C&O/B&O Tests at Noble, Illinois . . . . .	24
3.4.2 Sante Fe Tests at Laguna, New Mexico . . . . .	29
3.4.3 Western Pacific Tests . . . . .	29
3.4.4 Kansas Test Track . . . . .	30
3.5 New Tie Design and Performance . . . . .	33
4. TIE STRESS ANALYSIS . . . . .	41
4.1 Bending Stresses . . . . .	42
4.1.1 Analysis Model . . . . .	42
4.1.2 Analysis Results . . . . .	42
4.2 Torsion Stresses . . . . .	45
5. TIE AND FASTENER SPECIFICATIONS . . . . .	46
5.1 Vertical Load Distribution . . . . .	46
5.2 Impact Factor . . . . .	47
5.3 Tie Flexural Strength Requirements . . . . .	50
5.3.1 AREA Specifications . . . . .	50
5.3.2 Northeast Corridor Tie Specifications . . . . .	52
5.3.3 Tie Failure Criteria . . . . .	53
5.3.4 Design Reliability . . . . .	54
5.4 Tie Torsional Strength Requirements . . . . .	58
5.5 Rail Fastener Requirements . . . . .	59
5.5.1 Longitudinal Restraint . . . . .	59
5.5.2 Fastener Vertical and Lateral Loads . . . . .	60
5.5.3 Fastener Durability Evaluation . . . . .	64
6. ALTERNATIVE MATERIALS FOR TIE/FASTENER SYSTEMS . . . . .	67
6.1 Reconstituted Wood Crossties . . . . .	68
6.2 Steel Crossties . . . . .	71

CONTENTS  
(Continued)

	<u>Page</u>
7. FUTURE RESEARCH REQUIREMENTS . . . . .	76
7.1 Economic Benefits of Concrete Tie Track . . . . .	76
7.2 Influence of Track Design on Track Maintenance Requirements . . . . .	76
7.3 Rail Fastener Laboratory Tests . . . . .	77
7.4 Feasibility Demonstration of Flexible Rail Fasteners . . . . .	77
7.5 Concrete Tie Design Criteria . . . . .	78
7.6 Fastener Requirements for Timber Ties . . . . .	78
REFERENCES . . . . .	79
APPENDIX A PHOTOGRAPHS OF TYPICAL TIE FAILURE MODES AND BALLAST CONDITIONS . . . . .	85
APPENDIX B CONCRETE TIE STRESS ANALYSIS . . . . .	98
Tie Stresses From Bending . . . . .	98
Discussion of Results . . . . .	110
Tie Stresses From Torsion . . . . .	111
APPENDIX C REPORT OF NEW TECHNOLOGY . . . . .	115

ILLUSTRATIONS

Figure

3-1 Typical Tie/Fastener Failure Modes . . . . .	14
3-2 AAR Type E Concrete Tie . . . . .	18
5-1 Effect of Tie Spacing on Mean Rail Seat Loads for Locomotives . . . . .	48
5-2 Interference of Tie Load and Strength Distributions . . . . .	55
6-1 Typical Steel Tie Configuration for South Australian Railways . . . . .	72
B-1 Variable Width Plane Stress Model of Concrete Tie . . . . .	99
B-2 Summary of BCL Calculated, Mitre Calculated and WES Calibration Curve for Test Load and Strain Gage Locations Shown (Load Case 1) . . . . .	100



ILLUSTRATIONS  
(Continued)

<u>Figure</u>		<u>Page</u>
B-3	Pressure Distribution on Tie Base for Center Binding Load Case (Load Case 3) . . . . .	102
B-4	Pressure Distribution on Tie Base for Classical Load Case (Load Case 4) . . . . .	102
B-5	Pressure Distribution on Tie Base for Rigid Tie Load Case (Load Case 5) . . . . .	103
B-6	Pressure Distribution on Tie Base for Partial Center-Binding and Partial End-Binding Load Case (Load Case 6) . . . . .	103
B-7	The Effect of Load Configuration on Horizontal Strains at the Tie Centerline . . . . .	105
B-8	The Effect of Load Configuration on Horizontal Strains at Tie Rail Seat . . . . .	106
B-9	Estimated Bending Strains at Rail Seat Based on Load Case 5 Strain Distribution . . . . .	107
B-10	Horizontal Strain Remaining at Rail Seat After Subtracting Estimated Bending Strains . . . . .	108
B-11	Deformed Shape of a Twisted Bar of Rectangular Cross Section . . . . .	112
B-12	Shear Stress Distribution in a Twisted Bar of Rectangular Cross Section . . . . .	112

TABLES

<u>Table</u>		
3-1	North American Installations of Concrete Cross Ties . . . . .	8
3-2	Development of Specifications for U.S. Concrete Ties . . . . .	17
3-3	Design Flexural Requirements for "Intermediate" Prestressed Monoblock Ties . . . . .	22
3-4	Summary of Rail Seat Bending Strength (Inch-Kips) for Several Concrete Ties . . . . .	28
3-5	Bending Moment Tests of KTT Ties . . . . .	31
3-6	Flexural Performance Requirements for "New" Prestressed Monoblock Designs . . . . .	34

TABLES  
(Continued)

<u>Table</u>		<u>Page</u>
3-7	Record of Tie and Fastener Defects on Chessie Track at Lorraine, Virginia . . . . .	36
4-1	Load Cases for Model Analysis and Resulting Tie Bending Moments . . . . .	43
4-2	Hypothetical Distributions of Bearing Pressure and Corresponding Moment Diagrams for Tie . . . . .	44
5-1	Specifications for Vertical Tie Loads . . . . .	49
5-2	Summary of Typical Vertical and Lateral Rail Fastener Design Loads . . . . .	61
6-1	Results of Load Tests on Reconstituted Wood and Timber Ties . .	70
6-2	Relative Annual Track Costs . . . . .	75
B-1	Tie Center and Rail-Seat Moments for Unit Rail-Seat Loads . . .	104
B-2	Torsional Stress Parameters for Rectangular Cross Section . . .	113

## 1. INTRODUCTION

Foreign experience with concrete tie track has aroused considerable interest in using concrete ties for main-line use in North America. However, several tie and fastener problems on the first trial installations of concrete ties in the U. S. were discouraging. These early problems initiated a series of revised designs and a corresponding development of tie/fastener specifications. This has resulted in the development of several new concrete tie/fastener systems which are being tested in the Facility for Accelerated Service Testing (FAST) track in Pueblo, Colorado, and elsewhere, and a contract has been awarded for about 400 track miles of concrete ties to be installed as part of the rehabilitation of the Northeast Corridor (NEC).

The principal objective of the work discussed in this report was to evaluate the technical basis for current tie/fastener specifications. Particular emphasis was placed on correlating component strength requirements with available data on track loads and the failure modes which have occurred in service. This required a detailed review of the performance experience and available laboratory test data for concrete ties used in several different test installations. While the experience with ties made from concrete dominates this review, performance specifications can be used for tie/fastener systems of other materials, and a limited review of experience with reconstituted wood ties and steel ties is included.

As a result of this work, several specific research and development activities required to upgrade current capabilities for designing improved track and track components have been identified.

## 2. SUMMARY OF RESULTS AND CONCLUSIONS

### 2.1 Performance History of Concrete Ties and Fasteners

Concrete railroad ties have been in existence since the 1880's, and have undergone considerable development in Europe since the 1930's. Tie performance appears to be satisfactory for European rail traffic where maximum axle loads of 22 tons are considerably lower than the typical 33-ton maximum axle loads on track in North America.

U.S. interest in concrete ties began in the mid-1950's under the leadership of the Association of American Railroads (AAR), and more than 100 test installations existed by 1964. These early ties experienced flexural cracking in the center and rail seat regions, torsional cracking in the center region, and various fastener problems. Rail seat cracking was attributed to inadequate prestress, and tie designs were improved by using a greater number of smaller diameter wires, and by using wires with rough or rusted surface to improve the stress transfer at the maximum load location.

The first version of concrete tie/fastener specifications was issued by the American Railway Engineering Association (AREA) in 1971. Several test installations of ties designed to meet this specification (intermediate ties) began having unexpected ballast crushing, tie cracking, and fastener problems during the first year of service. With an objective of eliminating service-induced cracking, flexural strength requirements were nearly doubled in a 1973 revision of the specifications and the use of reduced tie spacing and more durable ballast were recommended for future installations. The major conclusions from this experience with the intermediate ties were:

a. Crushing and abrasion of soft ballast is definitely a problem with concrete ties where the particle stresses at the tie/ballast contact surface are much higher than they are for a timber tie, indicating the need for higher strength ballast.

b. Flexural cracking in the rail seat region persisted even for ties which exceeded the minimum strength requirements by a considerable margin. Limited measurements of tie bending moments did not exceed the strength

specifications, although it was conjectured that higher loads which could cause cracking might result from wheel-flat impacts which were not recorded during the measurement program. An alternative hypothesis is that small cracks are being initiated at moments much lower than the static cracking moment, and that these cracks increase in size from the repeated fatigue loading of normal traffic.

c. The necessity for eliminating tie cracking to obtain an acceptable design life has not been confirmed or refuted at this time. Cracked ties which were left in track at Laguna, New Mexico, and those which were moved from the Kansas Test Track (KTT) to the Facility for Accelerated Service Testing (FAST) track in Pueblo, Colorado, indicate that cracking may have a minimal effect on tie life in dry climates. Confirmation of this in different environments would indicate that increasing tie strength requirements was unnecessary.

Ties designed since 1973 to meet the higher strength requirements for 30-inch spacing appear to be performing satisfactorily when installed at maximum spacing of 26 inches on high-quality ballast. However, rail creep, tie skewing, and other fastener problems observed in the 5-degree curve with 2-percent grade at FAST and at other test installations of new ties, indicate that fasteners which meet the AREA test requirements are not performing as well as expected in service. The effects of high frequency vibration and the rocking motion of the rail relative to the tie during wheel passage should be investigated as potential improvements to simulated service tests for fasteners which are needed to develop an "optimum" tie/fastener design.

## 2.2 Tie and Fastener Specifications

The failure experience and historical development of current specifications are important background material for evaluating current requirements. The major results from this evaluation of current specifications are:

a. The vertical load distribution factor used to estimate maximum tie loads as a percentage of the wheel load for different tie spacings appears quite conservative for average loads, but the large variability in tie support conditions requires a conservative estimate for maximum loads.

b. Impact factors used to estimate increases in dynamic loads in the original tie specifications have now been increased by 3:1 to match the increase in flexural strength requirements and retain the simplified bending moment equations based on an assumed uniform tie support condition. Rail-seat loads based on these impact factors are unrealistically high, but lower loads have been used for fastener strength requirements.

c. Flexural strength requirements which exceed available data on tie bending stresses in service and which are intended to eliminate cracking increase tie size, weight, and cost to the detriment of concrete tie economics. Additional evaluation of the effect of cracking on tie life is needed to determine appropriate failure criteria for design.

d. Design reliability concepts which use realistic estimates of the statistical variations in tie strength and tie loading to estimate service performance in terms of an acceptable number of cracked ties per year are recommended to replace an unrealistic goal of zero failures. This approach can be applied to either fatigue or fracture failures when the appropriate failure mode is identified. However, to date these reliability concepts are still to be investigated and applied.

e. Current specifications include dimensional tolerances on rail seat differential tilt and prohibit narrow sections at the tie center to minimize tie torsional failures. The use of a minimum torsional load requirement based on typical measured data is recommended as an alternative requirement to permit greater freedom in designing ties to reduce center binding.

f. Differences between laboratory test and service performance of rail fasteners indicate the repeated load test is not an adequate simulation of the track loading environment. Also, either the minimum longitudinal restraint force needs to be increased, or preferably, the fastener-to-fastener variation in longitudinal restraint needs to be reduced to eliminate tie skewing, in conjunction with adequate ballast requirements.

g. Specifications for fastener uplift load appear excessive and should be based on expected track loads rather than on the fastener precompression load. It may also be necessary to reduce the vertical load for simultaneous vertical and lateral loading to produce a more realistic and conservative load requirement. This may be a factor contributing to unexpected service failures of rail clips.

h. It is difficult to evaluate fastener performance in repeated load tests which require 3-million constant-amplitude load cycles when an expected 25-year service life in track represents an excess of 30 million load cycles for typical annual traffic of 20 MGT.

### 2.3 Alternative Materials for Tie/Fastener Systems

Reconstituted timber ties and steel ties were reviewed as possible alternatives to solid timber or concrete ties. Design loads are not strongly dependent on tie materials, and material availability and cost are more important factors in material selection than are the technical requirements. However, historical performance has shown that compatibility between the tie and fastener is of major importance; this is a material-dependent design problem. Ties made from light materials such as wood or plastic and having rail fasteners which clamp the rail to the tie, will show greater pumping action than a heavy tie which can resist the uplift forces. Allowance for rail uplift is an important design decision for light ties and additional data on the effect of increased pumping on track surface deterioration is needed.

Data from laboratory tests indicate that it is possible to design reconstituted wood ties with adequate strength and resistance to wear comparable to timber ties. Sensitivity to moisture is a potential problem which requires service evaluation. Reconstituted ties installed at FAST are being evaluated with accelerated loading, but this will not duplicate severe moisture conditions.

There has been increased interest in steel ties in Australia since about 1973. Cost analyses indicate steel ties are less expensive than wood or concrete for light traffic and are only slightly more expensive than concrete for heavy traffic. Development of satisfactory rail fasteners, as indicated by premature failure at FAST and elsewhere, and demonstration of adequate strength for heavy axle loads are the major current problems. Steel ties may have considerable potential and the development efforts for the mining railroads in Australia should be followed closely.

## 2.4 Future Research Requirements

Several topics requiring additional research to support improved performance specifications and to refine economic evaluations of alternative tie/fastener systems have been identified during work on this contract.

These topics are:

a. Improved data on the relative performance of wood and concrete tie track are needed to refine life cycle cost estimates.

b. An improved track design/evaluation methodology is needed to provide quantitative predictions of the effect of track design variables on the frequency of track maintenance.

c. A laboratory test which provides a more realistic duplication of service experience is needed to reduce the development time for new and improved rail fasteners.

d. A demonstration of the technical feasibility and benefits of using more flexible rail fasteners with concrete ties is needed to encourage innovative designs by fastener suppliers.

e. The effect of structural cracking on tie life and the failure mechanism responsible for initiating tie cracking in service must be identified in order to justify current specifications or develop improved specifications.

f. Improved fasteners for timber ties should be evaluated to provide improved safety and maintenance for new and rehabilitated track.

Additional descriptions of these recommended research programs are given in Section 7 of this report.



### 3. CONCRETE TIE AND FASTENER PERFORMANCE

The development of concrete cross ties began in the 1880's in Europe, with major activity beginning in the 1930's when increased tie demand started to exceed wood and steel tie production. The performance of concrete ties and the price of concrete compared to wood, which is in relatively short supply in Europe, has resulted in the concrete tie now being in common use in many European countries. Many different European tie designs exist today, and they appear to operate quite satisfactorily for European rail traffic where maximum axle loads of 22 tons are considerably lower than the typical 33-ton maximum axle loads prevalent in North America.

The adequate supply of timber in North America limited development efforts of concrete ties, but there was considerable interest as evidenced by approximately 150 U.S. patents issued for reinforced concrete tie designs between 1893 and 1930 [3-1]. However, real activity started in the U.S. in the mid 1950's under the leadership of Ruble and Magee of the Association of American Railroads (AAR) Research Center. The details of this early work are described in several engineering reports [3-2, 3-3, 3-4] and in an overall status review of concrete ties in the United States [3-5].

#### 3.1 Concrete Tie Installations

Early in 1960 the concrete tie moved from the design and laboratory testing stage to "in-track" service evaluation in numerous test installations. In 1964, after 4 years of being in the service testing mode, the Portland Cement Association (PCA) reported the existence of some 100 installations [3-6]. These installations ranged from 2 ties to several thousand ties in tracks varying from yard tracks and industrial spurs to main tracks carrying over 20 MGT annually. Many installations consisted of around 40 to 60 ties, and these were attempts at eliminating specific problems such as the high rate of timber tie degradation in grade crossings, or to provide improved support for the buffer rails used between strings of continuous welded rail.

Table 3-1 [3-4, 3-6, 3-7, 3-8, 3-9] lists many of the concrete cross tie installations in the United States. Some recent installations in Canada

TABLE 3-1. NORTH AMERICAN INSTALLATIONS OF CONCRETE CROSS TIES

Owner	Date Installed	Location	Tie Type	Number	Spacing (In)	Annual Tonnage (MGT)
1. Atlantic Coast Line	1960	N.Carolina	AAR Type E	500	30	10
2. Seaboard Air Line	1960	Florida	AAR Type E	600	30	17
3. Western Pacific	1960	California	Gerwick	49	26,28,30	0.9
4. DM & IR	1960	Minnesota	AAR Type E	99	26	20
5. Central of N.J.	1961	Pennsylvania	French R.S.	10	21	--
6. Seaboard Air Line	1961	Florida	AAR Type E	163	21	10
7. U.S. Steel Corp.	1961	Wyoming	Gerwick	577	30	1
8. Atlantic Coast Line	1961	N.Carolina	AAR Type E	500	30	10
9. Canadian National	1961	Quebec	AAR Type E	800	30	16
10. Canadian National	1961	Quebec	French R.S.	1000	30	16
11. Atlantic & St. Andrews Bay	1961	Florida	AAR Type E	16	30	2.6
12. Seaboard Air Line	1962	Florida	AAR Type E	73	30	--
13. Atlantic Coast Line	1962	Florida	AAR Type E	108	30	15
14. Seaboard Line	1962	Florida	AAR Type E	180	30	--
15. Seaboard Air Line	1962	Florida	AAR Type E	67	30	--
16. Seaboard Air Line	1962	Florida	AAR Type E	62	30	--
17. Seaboard Air Line	1962	S.Carolina	AAR Type E	102	30	8.6

TABLE 3-1. (Continued)

Owner	Date Installed	Location	Tie Type	Number	Spacing (In)	Annual Tonnage (MGT)
18. Seaboard Air Line	1962	Florida	AAR Type E	78	30	--
19. Seaboard Air Line	1962	Florida	AAR Type E	78	30	7
20. Seaboard Air Line	1962	Florida	AAR Type E	69	30	7
21. Seaboard Air Line	1962	Florida	AAR Type E	164	30	--
22. Seaboard Air Line	1962	Florida	AAR Type E	50	30	7
23. Union	1962	Pennsylvania	AAR Type E	199	30	--
24. Seaboard Air Line	1962	S.Carolina	AAR Type E	120	30	8.6
25. St. Louis-S.Fran.	1962	Missouri	AAR Type E	1056	30	--
26. Seaboard Air Line	1962	Florida	AAR Type E	55	30	--
27. Seaboard Air Line	1962	Florida	AAR Type E	162	30	--
28. Western Pacific	1965	No.California	MR-3	300	28	15
29. Western Pacific	1965	No.California	MR-3	100	26	16
30. Western Pacific	1965	Utah	MR-3	100	26	16
31. Florida East Coast	1966 thru 1976	Florida	MR-2 Modified MR-2	292,683	24	20
32. Chessie System	1968	Illinois	Abex B66	--	27,25	25
33. BART	1969-70	No.California	2 Block,R.S. RT-2	-- 140,000	27 30	8
34. Western Pacific	1969	No.California	RT-7	150	28	16
35. AT&SF	1971	No.California	RT-7	500	29 1/2	16

TABLE 3-1. (Continued)

Owner	Date Installed	Location	Tie Type	Number	Spacing (In)	Annual Tonnage (MGT)
36. AT&SF	1971	So. California	RT-7	2250	24, 29	20
37. Southern Railway	1971	Tennessee	RT-7	1500	24	18
38. AT&SF	1971	New Mexico	RT-7	500	29	20
39. AT&SF D.O.T.	1971	Kansas Test Track	RT-7	1650	24, 27, 30	40
40. Salt River Project	1971-72	Arizona	RT-7	198,000	26-1/2	10
41. AT&SF	1972	No. California	RT-8	75	20	4.5
42. Western Pacific	1972	No. California	RT-8	75	20	16
43. D.O.T.-UMTA	1972	Colorado	RT-7	8000	30	1
44. U.S. Army	1972	Arizona	RT-7	120	120	Yard
45. Canadian National	1972	Alberta	CC241	10000	24	32
46. D.&R.G.W.	1973	Colorado	RT-7	75	24	Yard
47. Alaska	1973	Alaska	RT-7S	300	26	6
48. Western Pacific	1974	No. California	RT-7S	12	28	16
49. Chessie System	1974	Virginia	RT-7S, CC244	124	25	36
50. BART	1974	San Francisco	RT-2	6400	30	Yard
51. AT&SF	1974	Illinois	RT-7S, CC244C	200	24	20
52. Norfolk & Western	1974	Virginia	RT-7S, CC244C	&199 402 &400	&24 24, 26	50

TABLE 3-1. (Continued)

Owner	Date Installed	Location	Tie Type	Number	Spacing (In)	Annual Tonnage (MGT)
53. AT&SF	1975	New Mexico	RT-7S	24	29	20
54. BART	1975	San Francisco	RT-2	4200	30	Yard
55. Todd Shipyards	1975	So. California	CR-1	1300	24	Yard
56. Santa Fe Pomeroy	1975	No. California	RT-7& RT7S	700	24	Yard
57. U.S. Navy	1975	No. California	RT-7	50	20	Yard
58. DOT-FRA (FAST)	1976	Colorado	*	*	24	300
59. U.S. Navy	1976	No. California	RT-7	86	24	--
60. MARTA	1977	Georgia	RT-7	43,000	24	--

\* The approximately 3000 concrete ties installed at FAST include 6 different ties, 9 types of pads and 3 types of rail fasteners [3-10].

and several rapid transit systems are also included because these are substantial demonstrations of the use of concrete cross ties. Specifically omitted are installations in industrial tracks, the installation in the Kansas City Southern and the 1.5 million ties to be installed by the Canadian National Railroad during the next 5 years.

The data in Table 3-1 show that the initial tie installations were the AAR Type E tie. These were installed at a 30-inch spacing compared to the usual spacing of 19-1/2 to 22 inches for wood ties. Premature failures, which will be discussed in the following section, led to changes in tie shape, increases in tie size and prestress, and a reduction in tie spacing. Most recent installations of concrete ties use a tie spacing of 24 to 26 inches, and the ties are considerably larger and stronger than the original AAR designs.

### 3.2 Tie/Fastener Failure Modes

A previous report [3-11] under this contract included a review of the principal modes of track component failure and long-term track degradation. This was used to identify criteria for selecting track analysis models to predict the governing response parameters such as tie bending moments, fastener loads, and ballast and subgrade pressures. Results of this analysis were reported in [3-12].

The major tie and fastener failure modes observed in service are as follows:

- A. Tie Failures
  - a. Rail Seat Cracking
  - b. Tie Center Cracking
- B. Fastener Failures
  - a. Bolt Breakage
  - b. Rail Seat Spalling
  - c. Insert Pull-Out
  - d. Clip Breaking
  - e. Pad or Insulator Displacement, Deterioration and Failure.

Some of these failure modes are identified by their characteristic appearance, as shown in Figure 3-1, rather than by a term which describes the failure mechanism. For example, tie center cracking might be caused principally by bending, torsion or shear loads, and the failure mechanism could be either cumulative fatigue damage, an abrupt fracture due to a single high load such as from wheel flats, or a combination of these. The evaluation of available data in an effort to identify the governing failure mechanisms is a principal objective of this project.

In addition to these tie and fastener failure modes, severe deterioration of the ballast has occurred at several concrete tie test sites. This deterioration includes fouling of the ballast by windborne fines, locomotive sand and subgrade soils, degradation of the material through abrasion or crushing, and crushing due to rail corrugations. Appendix A contains selected photographs of tie/fastener failures and ballast conditions observed in various service test installations in the United States.

Of the tie failures observed, the most common appears to be rail seat cracking. In general these cracks initiate at the bottom of the tie directly under the rail. The cracks progress vertically upward to about the center of the rail seat side face where they generally split into a "Y" configuration and proceed to the top surface. Although probably varying with tie design, the point at which the vertical crack divides appears to coincide with the location of the top layer of prestressing tendons.

While no quantified population distribution of tie failures could be derived from the reports surveyed, photographs obtained and personal observations seem to indicate that tie center cracking due to negative bending is second in frequency of occurrence. Third is tie center cracking due to torsion. Center cracks exhibit an inverted "Y" configuration similar to the rail seat cracks while the torsional cracks exhibit the characteristic diagonal or spiral configuration. Examples of each type of cracking are shown in the photographs in Appendix A.

With respect to fastener failures, even less quantitative data were available. Except for Reiner's report on the Chessie test [3-13], discussed later in this report, published literature contained descriptions of the types of failures but generally no data on their population. Many fastener failures appear to result from either direct or indirect mismatch in

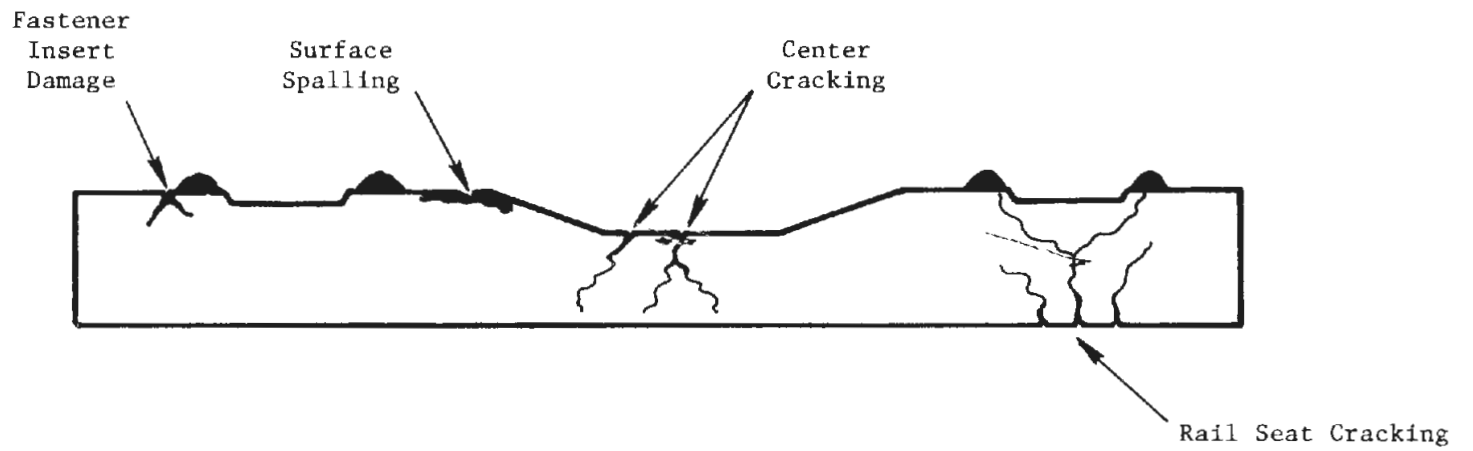

FIGURE 3-1. TYPICAL TIE/FASTENER FAILURE MODES

Note: Not to scale.



production tolerances of the components. Consider, for example, a rather common type of fastener which has a relatively rigid steel clip bearing on both the rail and a formed seat in the concrete tie and which is secured to the tie with a threaded bolt. Tolerances in production of clips and ties result in variations in the contact area at the clip/tie interface. This in turn can cause high contact stresses and spalling of the rail seat. Note that this report considers rail seat spalling to be a fastener failure since the rail seat is designed to be compatible with a specific fastener. As the rail seat deteriorates, the anchor bolt is required to resist lateral loads, and this causes bolt failures due to lateral bending. Due to the absence of quantitative data, no definitive comment can be made as to whether the failures are caused by the random nature of production tolerances or demonstrate an inherent design weakness. Several examples of these types of failures are shown in Appendix A. If the current interest in the use of "threadless" fasteners (which are relatively flexible) continues, these failures should decline because their design usually does not involve bearing of the clip on an intricately contoured concrete surface.

The most common types of fastener failure observed in both "threaded" and "threadless" type fasteners are pad displacement and deterioration, and excessive movement of clips and insulators. Various pad materials and configurations have been tried, and service reports show some degree of displacement with all designs. The same problem exists for insulators where the insulator is a separate piece between the clip and the rail. Some success has been achieved by bonding insulating material to the clip or by applying insulating material to the fastener insert which is then cast into the tie. Examples of component displacements are also shown in Appendix A.

Although not a tie/fastener failure mode, ballast is a critical component of the track system which can have an important influence on tie performance. Appendix A contains several photographs of ballast conditions in concrete tie installations. Conventional railroad practice has been to use the best available local materials for ballast. However, early experience with concrete ties showed that soft ballast materials which were acceptable with wood ties deteriorated rapidly with concrete ties, so that more stringent ballast selection criteria are needed.

The history of the development of concrete ties in the U.S. provides the major input for understanding tie performance and current design specifications. Weber [3-14, 3-15] discusses tie performance in terms of the early ties and intermediate ties, reflecting design changes made as a result of initial performance problems. This is a convenient format and it has been adopted for this brief review. Table 3-2 gives a brief description of the design features and design specifications which characterize tie development.

### 3.3 Early Tie Design and Performance

Early ties discussed herein include the AAR Type E shown in Figure 3-2 and the several modifications which resulted in the Type 3, or MR-3 design. These ties featured a wedge-shaped bottom in the tie center and four 7/16-in. diameter prestress strands. Earlier development efforts by the AAR were based on the ultimate strength of a center-bound oak tie of about 400 in.-kips and measured bending moments of about 100 in.-kips in the rail seat region for ties at 20-in. spacing. The wedge-shaped center section was introduced in an effort to reduce center bending moments by using a shape which would dig into the ballast.

Types D and E ties were developed early in 1959 for an increased spacing of 30 inches, and the design moments were increased to those listed in Table 3-2. A tie width of 12 inches was selected to provide approximately the same average ballast pressure of 65 psi that had been estimated for 9-in. wide wood ties at 20-in. spacing. Laboratory tests included both static and 2 million cycles of repeated load with no visible cracking permitted.

The AAR Type E tie was produced in at least 3 versions. Most of the ties in service are one of these modified designs, and all are commercially designated the MR-2. Continued field measurements and inspections reported in [3-2] showed that a large percentage of the initial version of E ties had hair-line cracks on the top surface of the tie center region and some rail seat cracks. Negative center bending moments sufficient to cause tensile stresses exceeding the prestress on the top surface had not been anticipated in the original tie design. It was recommended in [3-4] that the top center section of the tie be recessed by 1 inch, that the full 7-in. depth of the tie be retained in the recess area of the rail seat, and that the initial

TABLE 3-2. DEVELOPMENT OF SPECIFICATIONS FOR U.S. CONCRETE TIES

	Design Bending Moment, in.-kips <sup>(a)</sup>		Typical Ties
	Rail Seat	Tie Center	
I. Early Ties	+ 150 (Static)(b) + 200 (Cyclic)	+ 75 wedge bottom + 150 flat bottom	AAR Type E AAR Type MR-2 AAR Type 3 (MR-3)
II. Intermediate Ties (c)	+ 180 (Static) + 198 (Cyclic)	+ 110 - 185	AAR Type 4 Gerwick RT-7 MK37 and MK38 Dow-Mac
III. New Ties (c)	+ 300 (Static) + 330 (Cyclic) - 115 (Static)	+ 110 - 200	Gerwick RT-7S, <sup>(9')</sup> RT-7SS <sup>(8'6")</sup> Con-Force Costain CC244, CC244C Grinaker Westinghouse - Blakeslee WB-2 Dow-Mac

(a) Design moments intended for 30-in. tie spacing and 8'6" tie length.

(b) Criteria for early ties was no visible cracking.

(c) Criteria for intermediate and new ties was no cracking which extended to prestress tendons (structural cracking). Cyclic loading was applied to pre-cracked tie to evaluate bond strength.



preload for tye Type 3 tie be increased from 81.6 kips to 100 kips. The effective preload after shrinkage was assumed to be at least 80 percent of the initial preload for these designs.

It is of considerable interest that bending moment measurements from several instrumented ties confirmed the adequacy of the 150 in.-kips rail seat design moment, as stated in [3-5]. Also, despite the measurements of negative bending and observed cracking in the tie center region, a negative bending design moment was not recommended during this early development effort.

In addition to flexural cracking in the center and rail seat regions during the first year of service, torsional cracking characterized by a diagonal crack was also observed in the center region. Pull-outs of the fastener inserts also occurred frequently, and several non-structural problems were found; such as spalling of concrete shoulders adjacent to the heel of the rail fastening clip, broken clips and bolts, and displaced pads.

Torsional loads on ties were quite unexpected, and the wedge-shaped center section is particularly weak in torsion. The wedge bottom was eliminated in the AAR Type 4 tie, and all subsequent designs have used a flat bottom. However, some torsional failures persist in even much larger ties. Differential tilt of the rail seats in the direction of the rail can produce a torque due to edge loading of the rail on the tie. This is the generally accepted explanation for the source of torsional loads. These loads can be reduced by controlling construction tolerances or by using a rail pad of reduced width to reduce the effective lever arm for the off-center load. Other possible causes of torsional loads are skewed ties and non-uniform ballast support conditions.

The flexural cracking beneath the rail seats was the most serious problem, and the Portland Cement Association (PCA) did considerable investigation of this during late 1967 and early 1968. It was observed [3-14] that the rail seat cracks in early ties did not close when all load was removed. This indicated a loss in prestress at the failure location, which meant the bond between the strand and the concrete had failed in the tie end region. Subsequent investigation by PCA showed that the rail seat was within the transfer length over which the prestress is transferred from the strand to

the concrete tie. This means that the full prestress was not available at the maximum moment location under the rail. But this in itself is not a problem, because tests had shown the tie to have adequate strength for the design moments. However, when cracks do occur in the transfer zone and reach the prestress strands, bond deterioration is thought to occur at an accelerated rate because of the high shear stress. Considerable investigation by PCA [3-14, 3-16] showed that the transfer length could be reduced by using a greater number of smaller diameter wires, by using wire having rough or rusted surface, and by using a gentle release of the prestress during production. These measures would provide a more effective tie design with maximum utilization of the prestress at the maximum load location.

The explanation for why cracking of the early ties persisted even though the measured bending moments were less than the design moments is not discussed thoroughly in any of the available literature. However, it is implied that degradation of the ballast caused voids under the tie rail seat region, and this caused both center binding and excessive rail-seat bending moments--presumably at a time when measurements were not being made. As discussed previously, many of the early tie installations used soft limestone or slag ballast which deteriorated rapidly due to crushing and abrasion from the concrete. Leading users of the early ties, such as the FEC, switched to a much harder ballast and reduced tie spacing to about 24 inches. Also at this time, the American Railway Engineering Association appointed a special committee with a mission to prepare performance specifications for all types of concrete ties and track design configurations. The first version of these preliminary specifications was published in AREA Bulletin 634, September-October 1971 [3-17]. A discussion about their principles by George Way, Committee Chairman, was published in the December 1971 issue of Railway Track and Structures [3-18]. These specifications were used as the basis for a new series of tie designs, and the first of these intermediate ties were installed during the latter part of 1971.

### 3.4 Intermediate Tie Design and Performance

The specifications [3-17] used as the basis for the intermediate ties were based on the following assumptions:

- a. Maximum static wheel load of 41 kips
- b. Dynamic impact factor of 50 percent
- c. Maximum vertical tie load equal to 60 percent of the wheel load
- d. Maximum tie bending moments based on tie/ballast pressure being uniform over entire tie length.

These assumptions were used to compute the flexural strength requirements listed in Table 3-3 for various tie lengths and spacing. These requirements were increased by 10 percent to allow for long-term loss in prestress. A minimum positive moment of 150 in.-kips was established at the rail seat based on previous experience with the early ties. The rail seat moment required for an 8'6" tie at 30-inch spacing was increased by 20 percent to 180 in.-kips, and a negative bending moment requirement of 185 in.-kips was introduced for the first time, as shown in Table 3-2.

The various test installations of intermediate ties included locations on the Western Pacific, the Southern, and the Sante Fe railroads, and they are described in [3-14]. As reported in [3-15], the performance of ties on the Sante Fe, which were installed at a 29-inch spacing on slag or volcanic cinder ballast, began showing unexpected problems after about one year of service. Fastening problems included broken bolts, loose clips, and failed or displaced tie pads, all associated with the bolt and clip type of rail fastener. However, flexural cracking in the rail seat region of nearly 100 percent of the ties was the major problem revealed by detailed inspections. These were made during July and August 1972, at locations near Oklahoma City, Laguna, New Mexico, and at Cadiz, California. The RT-7 MK 38 ties at Laguna and Cadiz were of particular interest because their flexural strength in positive bending at the rail seat was approximately 230 to 245 in.-kips at first crack [3-15] and 380 in.-kips ultimate moment, which exceeded the strength requirements for 9-ft. long ties by a considerable margin.

TABLE 3-3. DESIGN FLEXURAL REQUIREMENTS FOR  
 "INTERMEDIATE" PRESTRESSED MONO-  
 BLOCK TIES (AREA BULLETIN 634  
 [3-17])

Tie Length	Tie Spacing	Required Flexural Capacity (Inch-kips) Without Structural Cracking		
		Rail Seat +	Center -	Center +
8' 0"	21"	150	185	90
	24"	150	205	90
	27"	150	225	90
	30"	150	245	90
8' 6"	21"	150	150	90
	24"	150	155	90
	27"	165	170	100
	30"	180	185	110
9' 0"	21"	165	150	100
	24"	185	150	110
	27"	200	150	120
	30"	220	150	135
9' 6"	21"	200	150	120
	24"	220	150	135
	27"	240	150	145
	30"	260	150	160



Observations at these test sites showed considerable crushing of the ballast and voids under the rail seat region of the ties. Subsequent analyses and measurements indicate that the pressure distribution under the tie and tie vibration can be more severe with concrete ties. These results reinforced previous experience that the non-yielding surface of concrete ties requires a much harder ballast than is necessary for wood ties where the local ballast/tie contact stresses are reduced by indentation of the tie.

The PCA conducted both static and repeated load tests on selected ties from the test sections and identical new ties. Static tests showed that the ultimate strength of the cracked ties was about 30 percent less than for the new ties. This was believed to be caused by a reduction in prestress due to a partial loss in bond, which would very likely reduce expected life [3-19]. It was, therefore, concluded that service-induced cracking should be eliminated completely by using stronger ties, reduced spacing, and/or improved ballast support. Based on support conditions that were assumed to have existed for a time in the track, it was estimated that bending moments on the order of 300 in.-kips might have occurred [3-15].

Repeated load tests on cracked ties with up to 10 million cycles of rail seat loads from 28 to 34 kips did not show any further deterioration, nor did subsequent field inspections about one year later show any substantial elongation of the original cracks. These results showed that cracked ties would have considerable useful life remaining, although the effect on total life, could not be estimated.

However, the cracking of intermediate ties, which were considerably stronger than the minimum requirements, led the specifications committee in December 1973, to increase substantially the rail seat and tie center flexural requirements, and to add a section on ballast requirements. These modifications were as follows [3-15]:

a. Rail seat positive bending moments were increased from 180 to 300 in.-kips for 8'6" long ties at 30-inch spacing. This increase was based on the service load estimate for the Sante Fe tests discussed previously.

b. A requirement for negative bending at the rail seat was added.

c. Tie center negative bending moments were increased from 185 to 200 in.-kips.

d. The rail fastener repeated load test was modified to include an uplift force based on fastener vertical stiffness.

e. The fastener lateral load restraint requirements were reduced so that the flexible type of threadless fasteners which had a good performance history could comply.

f. The impact factor used to calculate tie flexural requirements was increased from 50 percent to 150 percent. This increase was made so that previous methods for calculating tie bending moments that were based on a uniform ballast pressure over the tie length would give results matching the increase to 300 in.-kips in Item a. The decision to increase the impact factor rather than something else in the calculation procedure was probably justified by the reasoning that high bending moments which crack ties are probably caused by a combination of flat wheel impacts and poor support conditions.

g. An allowable differential tilt of the rail seats of 1/16-inch in the direction of the rail was restricted to apply to a width of 6 inches. This reduces the tilt tolerance by 50 percent for a tie which is 12 inches wide at the rail seat. This modification was made in lieu of adding torsional moment requirements for which there was little quantitative information.

These modifications were incorporated into a revised version of the specifications which was published in AREA Bulletin 644 [3-20], September-October 1973. This version, together with a number of minor modifications given in AREA Bulletin 650 [3-21], were the basis for what will be classified as the "new" ties.

Some additional experience with the intermediate ties is summarized in the following sections.

#### 3.4.1 C&O/B&O Tests at Noble, Illinois

The Chesapeake & Ohio/Baltimore & Ohio (C&O/B&O) railroad was also actively engaged in evaluating concrete ties. This work was initiated in 1966 with an engineering and economic comparison of wood and concrete ties by Reiner [3-22]. The economic comparison was based on using concrete ties spaced 4 inches wider than wood ties to provide equal maintenance costs. The selection of tie spacing to equalize subgrade pressure 10 inches below the

tie bottom was the basis for the assumption of equal maintenance costs for wood and concrete tie track. The economic study resulted in recommending track tests to verify the effect of tie spacing on maintenance costs and to compare the durability of concrete and wood tie track under heavy mainline service.

For test purposes, concrete ties were required to withstand 150 in.-kips positive bending at the rail seat and 200 in.-kips negative bending at the tie center, along with several other requirements for fastener loads and electrical insulation described in [3-23]. Several tie and fastener designs were installed in a section of track carrying about 20 MGT annual traffic with train speeds up to 50 mph for freight and 70 mph for passenger service. This test installation was near Noble, Illinois and it was opened for service in September 1968.

The Noble test track [3-23, 3-24] consisted of three, 1440-ft test panels of concrete ties and one test panel of wood ties as a control section. The concrete ties were a German B66 tie with Pandrol fastener, an Abex-Interpace tie with AAR fastener, and a French RS dual-block tie with RN fastener. The wood ties were spaced at 23 inches, the B66 ties were spaced at 25 inches, and the RS and Abex ties were spaced at 27 inches. This track was installed with new 122-lb CWR rail and blast furnace slag ballast with an initial depth of 6 inches. This was later increased to about 8 inches.

The Noble tests included several instrumental ties and other track instrumentation. Detailed results are given in Reference [3-25]; however, some interesting data and results are summarized briefly as follows:

a. Track deflection measurements showed an effective track modulus of 2500 psi for wood ties and 13,000 psi for concrete ties. This 5 to 1 ratio for identical road bed conditions is surprising considering the small difference in tie spacing and bearing area, but results from other concrete tie installations have been similar.

b. Early failure problems included the fracture of 21 Pandrol clips. This was attributed to faulty heat treatment. The B66 ties became skewed due to low longitudinal ballast resistance and nonuniform longitudinal fastener restraint. Also, 24 B66 ties showed center cracking during the first 7-1/2 months of service. These ties were designed for 200 in.-kips of

negative bending moment at the tie center. However, subsequent observations during the first 3 years of service showed that the cracks did not increase in size, and they were, therefore, classified as superficial.

c. Test results showed that the longitudinal restraint from AAR fasteners with polyethylene pads was marginal. The AAR fastener was not recommended for future use because of inadequate longitudinal restraint, many bolt failures, excessive maintenance of the threaded bolts, and excessive slippage of the rail pads. Data on rail fastener bolt tension in the form of histograms and the reduction in bolt tension with time were recorded.

d. Six ties were strain gaged at the rail seat and at the tie center to measure tie bending moments. Results after two months of service showed a few bending moment measurements to be close to the 150 in.-kips design strength at the rail seat. The bending moment in the tie center was very low and in most cases was positive rather than negative. It ranged from 10 to 30 in.-kips. It should be noted that the estimates of rail seat bending moments were based on strain measured under the rail near the top of the tie. Recent measurements have shown that the effects of local stresses in the rail seat region can cause large errors in the bending moments.

e. After eight months of service (11.2 MGT), the rail seat bending moments increased by about 10 percent. The bending moment at the rail center shifted toward a center binding condition with a negative bending moment, but the magnitude of the center bending moments were still very low. Tie bending moments showed a very wide variation in the six different ties.

f. Extrapolation of the statistical data for the highest loaded ties indicated that 1.5 locomotive axles per year would exceed the 150 in.-kips design bending moment in the rail seat area. Hence, the report concluded that this explains the presence of rail seat cracks that were observed during October 1972, which was four years after installation.\* These data were the basis for a recommendation to increase minimum rail seat moments for 8'6" long ties at 28-in. spacing from 150 to 255 in.-kips. It was suggested that tie center strength requirements could be reduced from 200 to 175 in.-kips.

---

\* Although the design requirement was for a minimum of 150 in.-kips, the actual strength of the installed ties could be considerably greater. No tie strength data were reported.

It was also recommended that concrete tie spacing should provide 325 in.<sup>2</sup> of bearing surface per linear foot of track, assuming 33 inches of tamped length on each end of 8'6" ties. This limits tie spacing to 27 inches for 11-1/4 in.-wide ties, and 25-in. spacing was considered preferable.

g. There were considerable problems with all of the rail fasteners and pads. None of the specific tie/fastener systems evaluated during the Noble tests were judged to be adequate for future use. It was recommended that the increased strength ties like the RT7S and CC244C ties with Pandrol 600 series fasteners be used for any future testing on the C&O/B&O railroad. It was also recommended that high quality ballast with no less than 8 inches depth be used under the tie bottoms and that a better tie pad is needed for all of the concrete ties fasteners.

h. A general conclusion from the track performance at Noble was that concrete ties settle less than wood ties so that maintenance costs for ballast and surfacing should be reduced. Gage retention was superior and it was believed that the greater weight of concrete ties would reduce the potential for track buckling under high thermal loads.

The experience at Noble prompted the C&O/B&O to conduct some additional laboratory tests [3-26] using modified fastener and tie designs during 1971 and 1972. Although these designs differed from those installed in the Noble test track, the tie strength data listed in Table 3-4 are of considerable interest. These results show that the initial cracking moments for these ties were considerably greater than the minimum design requirements listed in Table 3-3 for intermediate ties, and in many cases met or exceeded the higher requirements for "new" ties. The failure mode for the Costain ties was a diagonal crack running from the outer support on the tie bottom to the applied load point on the tie top. This cracking was quickly followed by bond failure, with the lowest row of prestressing wires being pulled in at the tie end. Failure apparently was caused by shear since the tie cracked in a region of low bending. This is an unusual failure mode for concrete ties and does not normally occur in service where the loading is distributed rather than concentrated at narrow supports.

Failure of the other two tie designs was characterized by a tensile crack originating in the tie bottom directly under the rail seat in the region of maximum bending moment. Loss of prestress bond was not apparent.

TABLE 3-4. SUMMARY OF RAIL SEAT BENDING STRENGTH (INCH-KIPS) FOR SEVERAL CONCRETE TIES [3-26]

Tie No.	Rail Seat	Costain Type 227, 228, & 229 <sup>(a)</sup>		Abex-Interpace Type III <sup>(b)</sup>			Santa Fe-Pomeroy Type RT-7 <sup>(c)</sup>		
		1st Crack	Ultimate	Tie No.	1st Crack	Ultimate	Tie No.	1st Crack	Ultimate
1	A	342	451	9	258	489	1	309	491
1	B	374		12	282	538	2	316	481
2	A	310		14	247	517	3	299	471
2	B	348	414	18	258	511	4	302	514
3	A	310		Average	261	514	5	281	463
3	B	299	546				6	302	494
4	A	348					Average	302	486
4	B	338	544						
5	A	320	468						
5	B	348							
6	A	338							
6	B	312	454						
	Average	332	480						

- (a) There was no significant difference in strength between tie types or rail seat configurations.  
 (b) This is a modified design of the Type I tie installed in B&O test track at Noble, Illinois. Results for 2 different rail seats showed little effect on strength.  
 (c) Results from 2 different rail seat configurations showed little effect on strength.

### 3.4.2 Sante Fe Tests at Laguna, New Mexico

The installation of 1500 concrete ties on the Sante Fe's main line at Laguna was viewed with little optimism because volcanic cinder ballast was used. This 1971 installation included 1000 Dow-Mac Portec ties and 500 Gerwick RT-7 ties, all on 29-inch centers and with a variety of fasteners, including standard rail anchors. As discussed previously, Weber [3-15] reported that nearly 100 percent of these ties were cracked in the rail seat areas after the first year of service. After 6 years of service, it is reported [3-37] that 53(5.3 percent) of the Dow-Mac and 1(0.2 percent) of the RT-7 ties have been removed, mostly from failure in the rail seat area.

The track was surfaced out of face immediately after construction. Due to heavy rains in the fall of 1972 and the spring of 1973, the track required additional lining and surfacing. In view of the unexpected high rate of surface degradation and the early cracking, the number of tie failures after 6 years does not seem excessive. A certain number of these can probably be attributed to "infant mortality" caused by manufacturing quality control or excessive loads during shipping or installation.

### 3.4.3 Western Pacific Tests

In the period from 1968 to 1972, Venuti [3-27] conducted tests on Gerwick RT-7, (MK37 and MK38) concrete ties on the Western Pacific railroad. Both types of RT-7 tie are 9'0" in length, with the MK37 tie having five 7/16" strands with 108,000 pound prestress and the MK38 tie having six 3/8" strands and 100,000 pounds of prestress. The RT-7, MK38 tie is the same as those used by the Federal Railroad Administration in the Kansas Test Track, and at the several locations on the Sante Fe discussed previously.

Venuti measured the following moments on ties at 30-in. spacing under 55 mph freight traffic (32,200 lb. wheel load):

- a. positive rail seat moment: 180 in.-kips
- b. negative rail seat moment: 112 in.-kips
- c. positive center moment: 60 in.-kips
- d. negative center moment: 50 in.-kips

Venuti's report makes no mention of tie failures in this field test. However, in his conclusions he does state that additional data is required on "dynamic loading, abrasive wear, tie pressure distribution, optimum tie spacing, anchor bolt fatigue, tie pads and other considerations".

#### 3.4.4 Kansas Test Track

Test sections at the Kansas Test Track (KTT) included 9' RT-7, MK38 ties at 24, 27, and 30-in. spacing on identical roadbed (10-in. ballast depth). As inspection of the concrete ties by PCA in November 1975, after the track had been closed in June, showed that all of the ties inspected (10 percent) were cracked under both rails. Subsequent inspection of the remaining ties showed that all of them were cracked similarly. It is not known when during the 6 months of traffic the cracking occurred, but it is conjectured that "the ties cracked shortly after they were put in service, perhaps during the initial 2 weeks shakedown period [3-28]".

Tie bending moments measured by PCA [3-29] during four visits to the KTT show that the center bending moments increased with time. However, a maximum value of 47.5 in.-kips recorded in the section with 30-in. spacing was only about 30 percent of the 150 in.-kip center cracking moment. The maximum recorded rail seat bending moment of 173 in.-kips was recorded in the same section. This is about 63 percent of the 275 in.-kip cracking moment. The maximum bending moments recorded in the other sections with reduced tie spacing did not exceed 80 in.-kips, but ties in all sections were cracked. It must be recognized that the KTT instrumentation included bending moments on only 2 ties in each section, and considerable tie-to-tie variations can be expected. Data were limited to the loads from locomotives for 3 to 5 trains during each trip, so somewhat higher loads might be expected from heavy freight cars with wheel flats.

Table 3-5 lists the results of laboratory strength tests on 4 unused ties from the KTT, together with the 1971 specifications for intermediate ties and the 1975 specifications for new ties. The 1971 specification was in effect when the KTT ties were manufactured, and they exceeded the rail seat bending moment requirements by a considerable margin. Ultimate strengths for unused and cracked ties were nearly identical. Four of the five ties exceeded



TABLE 3-5. BENDING MOMENT TESTS OF KTT TIES [3-29]

Type of Test	Specified AREA Moment Without Structural Cracking (Inch-kips)			Test Results (Inch-Kips)	
	1975 AREA, 24 in. Spacing	1975 AREA, 30 in. Spacing	1971 AREA, 30 in. Spacing	Moment At Initial Crack	Moment At Structural Crack
Positive Rail Seat, No. 1	300	350	220	261	275
No. 2	300	350	220	213	241
No. 3	300	350	220	282	296
No. 4	300	350	220	282	303
Avg.				<u>260</u>	<u>278</u>
Negative Rail Seat, No. 1	115	115	--	163	176
No. 2	115	115	--	176	195
No. 3	115	115	--	189	221
No. 4	115	115	--	221	234
Avg.				<u>187</u>	<u>206</u>
Positive Center, No. 1	105	125	135	122	135
No. 2	105	125	135	122	149
Avg.				<u>128</u>	<u>142</u>
Negative Center, No. 1	200	200	150	189	203
No. 2	200	200	150	189	203
Avg.				<u>189</u>	<u>203</u>

\* All specifications are for 9'0" tie length.

the 1971 requirements for 30-in. spacing and the other tie was 2 percent below the requirement. None of the KTT ties met the 1975 requirements for bond strength for 24 or 30-in. spacing.

Repeated load tests were conducted using one unused and two used pre-cracked KTT ties. The loading consisted of a 3 million cycles of a maximum moment of 330 in.-kips representing 1975 requirements (24 in.-spacing), and far exceeded the 242 in.-kips for 1971 design requirements (30-in. spacing). This higher load caused no extension of the initial structural crack in two of the ties and about 1-1/4-inch extension in the third tie.

Although the AREA repeated load tests used a pre-cracked tie, the PCA did conduct some fatigue tests using uncracked KTT ties on a laboratory ballast bed [3-30]. One tie supported on a 15-inch deep bed of slag ballast survived 8.25 million load cycles with rail seat loads as high as 39 kips without any visible cracking. Strain measurements at one rail seat indicated bending moments might have reached 260 in.-kips. However, these strains were 85-percent higher than at the other rail seat, which is somewhat suspicious. A similar test is planned for granite ballast.

As a further evaluation of tie integrity, several of the cracked RT-7 ties from the KTT were installed in the Facility for Accelerated Service Testing (FAST) track in Pueblo, Colorado. Preliminary results after 50 MGT [3-31] show that the cracked ties have not deteriorated further even though the 33-kips mean wheel load for FAST traffic is about 50 percent higher than the mean load for normal freight service, which includes many empty and lightly-loaded cars.

The performance experience with the intermediate ties leads to the following conclusions:

a. Premature crushing and abrasion of soft ballast is definitely a problem with concrete ties and either harder ballast or an intermediate material at the ballast/concrete interface is needed. A rubber pad bonded to the tie bottom has been tried with some successes in Japan.

b. Flexural cracking has persisted in the rail seat region of intermediate ties which exceed the flexural strength requirements by a considerable margin. Also, bending moment measurements do not show that the service-induced moments are excessive, although there has not been sufficient measurements to give an accurate statistical description of moments which would include the tie-to-tie variations for an extended period of time or the

infrequent occurrence of high moments from wheel flats or other anomalies. The apparent early cracking of all ties in the KTT, where the spacing varied from 24 to 30 inches, suggests that cracking from infrequent high loads may not be the principal cause of failure, and that alternative crack initiation mechanisms should be considered. One possible alternative is that small cracks are being initiated by moments much lower than the static cracking moment, and once initiated, these cracks grow from the repeated fatigue loading of normal traffic until they reach a detectable size.

c. The necessity for eliminating tie cracking has not been confirmed or refuted by service experience. The reason cited most frequently for the elimination of cracking is that a crack which reaches the prestress tendons will eventually cause bond failure from the cyclic loading of normal traffic. This may be more important for those early tie designs where the transfer of prestress is still occurring in the rail seat region. Experience with the intermediate ties, which are expected to have a relatively complete transfer of prestress in the tie end, indicates that the effect of cracking on total life may be minimal. Confirmation of this would indicate that increasing the strength requirements to eliminate cracking of new ties may have been unnecessarily conservative.

### 3.5 New Tie Design and Performance

The basis for further modifications to the Area specifications was discussed in the previous section, and ties which meet the requirements in AREA Bulletin 644 [3-20], September-October 1973, will be referred to as "new" ties. Bulletin 650 [3-21] contained some additional connections and the entire specifications were republished in Bulletin 655 [3-32] and recommended for inclusion in the AREA manual. Table 3-6 lists the flexural requirements for the new ties, and these have remained unchanged since their publication in Bulletin 644. The most recent changes to the specification include revisions to the ballast requirements, and some changes in the fastener tests for longitudinal restraint and uplift loads. These are published in Bulletin 660 [3-33].

Two ties were designed during 1973 to meet the revised specifications. These were the Gerwick RT-7S manufactured by Sante Fe-Pomeroy in

TABLE 3-6. FLEXURAL PERFORMANCE REQUIREMENTS FOR "NEW" PRESTRESSED MONOBLOCK  
DESIGNS (AREA Bulletin 655 [3-32])

Tie Length	Spacing, Inches	Required Flexural Capacity (Inch-Kips) Without Structural Cracking			
		Rail Seat +	Rail Seat -	Center -	Center +
8'0"	21	220	115	200	90
	24	220	115	220	90
	27	220	115	240	90
	30	220	115	260	90
8'3"	21	225	115	200	90
	24	235	115	210	90
	27	250	115	220	95
	30	260	115	230	100
8'6"	21	225	115	200	90
	24	250	115	200	90
	27	275	115	200	100
	30	300	115	200	110
8'9"	21	250	115	200	95
	24	275	115	200	100
	27	300	115	200	110
	30	325	115	200	120
9'0"	21	275	115	200	100
	24	300	115	200	105
	27	325	115	200	115
	30	350	115	200	125

California, and the CC244 (26 wires) and CC244C (28 wires) ties manufactured by Con-Force Costain Concrete Tie Company in Canada. Test installations were selected on the Alaska Railroad about 100 miles north of Anchorage, on the Chessie system at Lorraine, near Richmond, Virginia, on the Sante Fe at Leeds near Streator, Illinois, and on the Norfolk and Western at Kumis, near Roanoke, Virginia. Several different tie-fastener combinations are being evaluated for a variety of service and weather conditions. As shown in Table 3-1 (Items 47, 49, 51, and 52), the spacing varies from 24 to 26 inches. A more detailed description of these test installations is given in [3-15, 3-34] and [3-36] discusses the performance during the first years of service.

The Chessie test installation has been inspected periodically, and Reiner [3-13] reports the defects listed in Table 3-7 as of December 10, 1975, after some 51 MGT of traffic. Approximately 46 ties were examined on one side surface during each inspection. Although cracks are reported, Reiner describes them as minor hairline cracks and does not report any to be totally failed or unserviceable. General track condition, ballast condition, and tie and fastener conditions are reported as very good to good. The rate of growth of defects was also reported to be decreasing.

A latter inspection of the Chessie installation in October 1977, after about 105 MGT, showed only one rail-seat crack, one center flexural crack and one tie with possible torsional cracks. The slewing of CS-5 fasteners had stabilized. Some local soft spots were apparent and had required spot maintenance, but the overall condition of the track after 3-1/2 years service was quite good.

With regard to the Sante Fe test at Leeds, Weber and Ball [3-35] reported no visible flexural cracking during the first year of traffic, about 30 MGT. Bending moments measured on a total of 8 instrumented ties showed a maximum positive moment of 96 in.-kips at the rail seat and a maximum negative moment of 70 in.-kips at the tie center. These maximum values were reportedly only 32 percent and 36 percent of the AREA flexural strength requirements for rail seat and tie center, respectively. These ties were required to meet the flexural strength for 30-inch spacing, although they were installed on 24-in. centers.

Fastener defects such as slewing clips and pads and broken insulators also occurred at Leeds. Spalling of the concrete surface around the inserts

TABLE 3-7. RECORD OF TIE AND FASTENER DEFECTS ON CHESSIE TRACK  
AT LORRAINE, VIRGINIA

Date of Inspection	Number of Defects				
	Cracked Ties	Cracks	Broken Insulators	Skewed CS-5 Plates	Dislocated Pads
December 10, 1974	5	7	-	31	106
June 10, 1975	11	13	4	86	152
December 10, 1975	12	15	6	117	171

for the CS-5 fasteners was also noted, although no shoulder pullouts were reported.

The Norfolk and Western track at Kumis has carried approximately 125 MGT from its opening in December 1974, to a visual inspection data in October 1977. Detailed tie inspections have been omitted in order to avoid disturbing the ballast. No surfacing or lining had been performed during that interval and there was no noticeable difference between the track with 24- and 26-inch tie spacing. One tie was removed when a piece broke off that extended from one end, exposing the top of the prestress strands for 22 inches. An inspection in April 1977, showed two missing Pandrol insulators and 63 others which had moved enough to shear off one of the end projections. These were replaced with new, heavy-duty insulators. About a dozen Pandrol clips were also found to be loose.

Rail surface indentations caused by impacts from a wheel with a 13-inch broken section were quite evident. Detailed inspection of the ties directly under these indentations should provide a good indication of the effect of severe wheel-flat impacts on these concrete ties.

While the four main test installations were all constructed with high-quality ballast, 24 RT-7S ties were also installed at Sante Fe's test section at Laguna, New Mexico to determine performance with poor ballast. Previous experience with concrete ties on volcanic cinder ballast showed rapid deterioration of the support conditions. No results have been reported for this site.

The most extensive test of new concrete ties is at the FAST track where 6 tie designs, 3 fasteners, and 9 types of pads are being evaluated. Results reported for only 50 MGT of traffic [3-31] are insufficient to indicate any major conclusions. However, the bending moments measured at the rail seat and tie center compare well with previously reported results and are well within the current strength specifications.

The rail seat region of 90 FAST ties have been inspected, and minute cracks were located in 12 of these. Of these 12 ties, 10 were cracked RT-7 ties from the KTT. A total of 20 out of 450 ties inspected showed some hairline cracks on the top surface near the tie ends and 3 ties had surface cracks in the center portion. Two other ties were replaced due to transverse

cracking which has been attributed to heavy impacts on the fastener shoulder insert. In general, the concrete ties at FAST have shown good performance in terms of tie degradation and performance.

There has, however, been considerable movement and skewing of the FAST concrete ties, particularly in the 5-degree curve, 2-percent grade section where there has been considerable difficulty in maintaining adequate ballast in the cribs. It is also conjectured [3-31] that rail corrugations and rail plugs have excited tie vibration, and that this has increased ballast flow and crushing, creating local soft spots in conjunction with a probable inadequate grade of ballast.

The performance of the rail fasteners at FAST shows the same types of problems with loose clips, and excessive movement of the pads and insulators that have been observed at the other test locations. This has not been a critical maintenance or performance problem, but it does indicate that fastener performance could be improved. Available performance results indicate that fasteners which pass the AREA test requirements are not performing as well as expected under service conditions. This implies that the fastener tests, which are intended to simulate the service loading environment in sufficient detail to predict performance, are lacking in some way. For example, pad movement has been a continuing service problem that does not arise in qualification tests. Pad movement appears to occur even though the rail fastener maintains a compressive preload on the pad for all normal loading conditions. It is conjectured that the rocking motion of the rail relative to the tie during wheel passage may be a critical factor in pad performance that is not included in current tests. High frequency vibration has also been suggested as a possible contributor to unexpected pad and fastener performance.

Initial results from the several test installations of new ties indicate that ties which meet or exceed current AREA strength requirements for 30-in. spacing appear to be functioning adequately when installed with up to 26-in. spacing on high-quality ballast. Current recommendations of some AREA committee members are that ties meeting the 30-inch strength requirements should not be installed at spacing greater than 27 inches to provide an additional safety factor. Measurements of tie bending moments, although available data are insufficient to give a complete statistical characterization, continue to be considerably lower than the current strength requirements. As



discussed previously, this leads one to question if the mechanism responsible for crack initiation and propagation in service is being adequately addressed by the strength requirements and tests in current specifications.

Research on the tie failure mechanism question has been slowed by the absence of data on tie strength in available reports on tie service performance. A tie which reportedly meets certain specifications may actually exceed those specifications by a substantial margin, so that its service performance could give an inaccurate evaluation of the design requirements. Sufficient test data to provide a statistical characterization of the strength should be included as a part of any test program intended to evaluate tie performance. One example of this is the tie produced by the Railroad Concrete Crosstie Corporation (RCCC) for its parent company, the Florida East Coast Railway. RCCC specifications [3-38] require the following:

- a. concrete having a minimum ultimate strength of 8000 psi at 28 days;
- b. a minimum rail seat bending moment strength of 150 in.-kips, although a tie may be accepted if a crack appears above 140 in.-kips and the tie supports 150 in.-kips for three minutes and the crack disappears upon release of the load; and

By way of comparison, the following results were reported from a visit to the RCCC plant in Jacksonville, Florida:

- a. typical records of Pittsburgh Testing Laboratory tests showed concrete with granite aggregate having strengths of 7000 to 8000 psi after only 18 hours and 10,000 to 12,000 psi after 28 days;
- b. a RCCC production test requirement for rail seat bending strength of 158 in.-kips after only 18 hours;
- c. a sample 18-hour tie bending test in which 200 in.-kips was required to produce a crack with an ultimate load of 243 in.-kips. These results could not, of course, be expected for every tie.

This observed difference between the design specification and the actual tie characteristics substantiates the fact that minimum design speci-

cations cannot be used to describe a tie for performance evaluation purposes. Actual measurements of tie strength are needed, and these must include normal statistical variations.

#### 4. TIE STRESS ANALYSIS

As discussed in the previous section, cracking due to bending in the rail-seat region and either bending or torsion in the center region are the principal structural failure modes for concrete ties. Minimum allowable bending moment specifications are the key elements in tie design. However, the difficulty in determining the tie/ballast support condition is responsible for large uncertainties in estimating maximum design moments. For this reason, the instrumentation of ties to measure bending moments in service has been an important part of several recent tie evaluation projects, including the tie installation at FAST.

Tie instrumentation typically includes an array of strain gages located near the top and bottom surfaces. The output from the single gages, half-bridges, or full bridges are used to estimate bending moments using either the estimated material properties and neutral axis location or by a direct laboratory calibration using 4-point bending to impose a known bending moment at the gage locations. In the former case, it is necessary to assume a linear strain distribution across the tie depth in accordance with conventional beam theory. In the latter case, the laboratory calibration will include the effects of any local distortions to the linear strain distribution that are caused by the loading method. These local distortions will be small if the loading points are located away from the gages, by a distance at least equal to the tie depth. However, tie service loads originate from the localized pressure between the rail base and the tie surface and from the more distributed reaction of the ballast.

The investigation of these local strain distortions in the rail seat region and the overall influence of variable ballast support conditions was a major objective for this report. Appendix B gives the detailed stress analysis results for the concrete tie selected for demonstration purposes. A brief evaluation of torsion stresses is also included. Only the major results from this analysis are discussed in this section of the report.

## 4.1 Bending Stresses

### 4.1.1 Analysis Model

The stress analysis of the concrete tie used a 2-dimensional model with variable-width finite elements of the 8-node isoparametric type. Table 4-1 summarizes the 6 loading cases which were selected and the resulting moments (normalized) at the rail seat and the tie center. Load Cases 1 and 2 represent the 4-point loading arrangement used to obtain a constant bending moment at the rail seat for gage calibration or tie strength tests. Load Case 1 was used by the Waterways Experiment Station (WES) to calibrate the instrumented ties for FAST. Load Case 2 is similar to the test configuration for current AREA specifications except that a separation distance of 5 inches rather than 6 inches is used for the loading points.

Load Cases 3 through 6 cover a range of hypothetical ballast support conditions. These include center-binding (Case 3), a classical uniform elastic support with a relatively flexible tie (Case 4), a relatively stiff tie (Case 5), and a partial center-binding support condition with voids under the rail seats (Case 6). Bending moments for a uniform load support condition are also shown for reference, because this is the model used as a guide for the AREA tie specifications. Talbot [4-1] described an even greater variety of hypothetical pressure distributions and these are included in Table 4-2 for comparison purposes. Talbot's measurements of wood tie deflections in 1919 led him to conclude that a great variety of bending moment distributions would occur in service and that the uniform load condition cannot be expected.

### 4.1.2 Analysis Results

As expected, the strain distribution in the center region of the tie showed a linear variation and agreed with beam theory within 6 percent. There should be no difficulty in using strain gage data to determine tie center bending moments provided that the loading points for laboratory calibration are no closer than 8-10 inches from the gages. A single active gage is probably adequate for this measurement because axial forces should be relatively small.

Load Case	Simulated Load	Tie Bending Moments (Inch-Kips) per Kip of Rail Seat Load P	
		Rail Seat	Tie Center
1 4-Point Load		2.6	0
2 4-Point Load		5.6	0
3 Center-Bound		0.5	-12.2
4 Flexible Tie		3.5	-2.0
5 Rigid Tie		4.8	-2.5
6 End- and Center-Bound		2.7	-8.6
7 Uniform Support		4.3	-4.5

TABLE 4-1. LOAD CASES FOR MODEL ANALYSIS AND RESULTING TIE BENDING MOMENTS

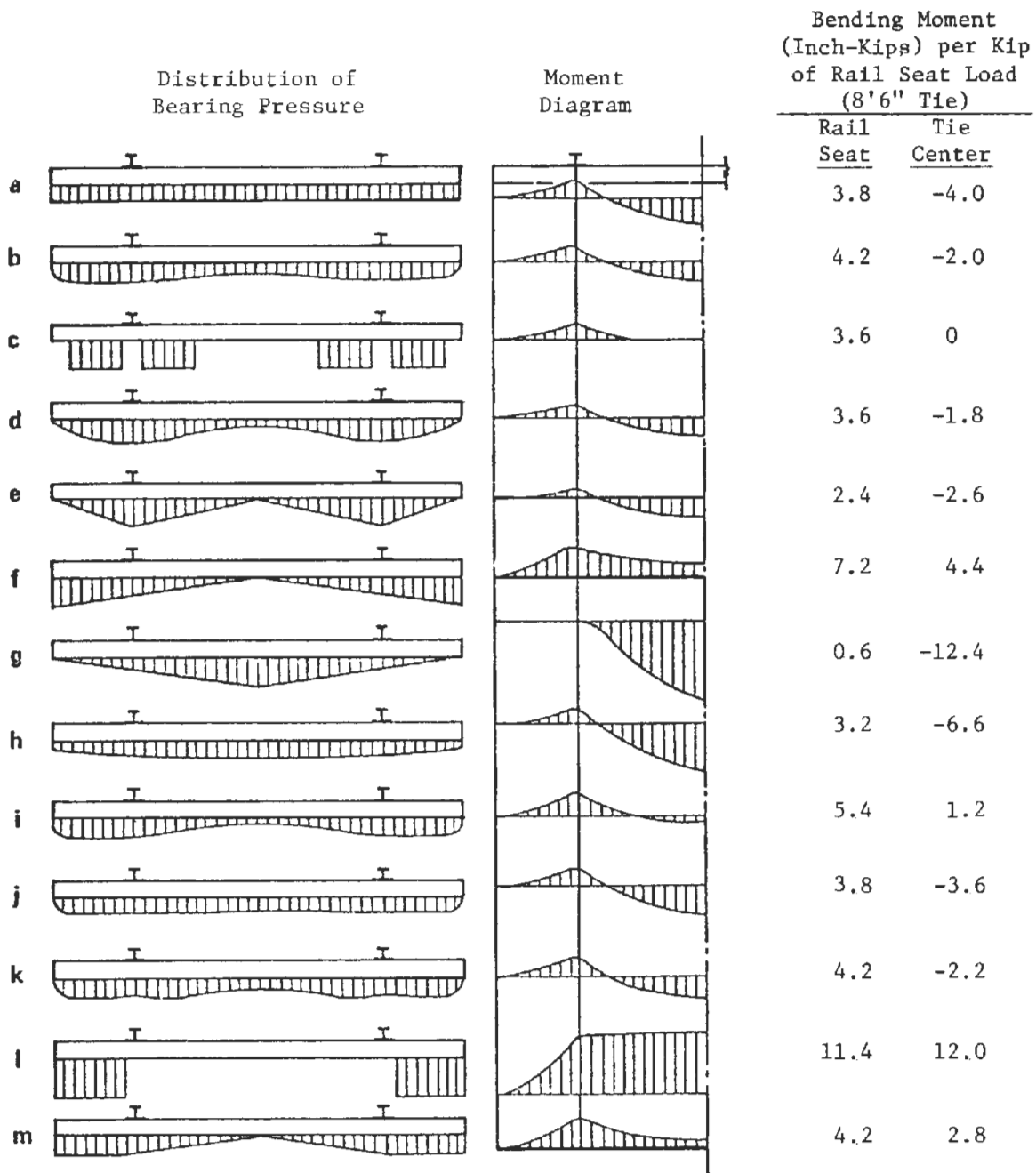

TABLE 4-2. HYPOTHETICAL DISTRIBUTIONS OF BEARING PRESSURE AND CORRESPONDING MOMENT DIAGRAMS FOR TIE [4-1]

Local stresses from the rail seat load can cause a significant difference in the strain distribution from what would be expected for pure bending. The center-binding support condition shows the greatest variation because the bending strain in the rail seat region is quite small relative to the local strain. Strain gages located near the top surface of the tie should not be used to estimate tie bending moments. Gages located near the bottom of the tie are less influenced by the local contact stresses on the rail seat and the effect of the support reaction on the bottom gages is also small. Strains predicted by the finite-element model ranged from 85 to 100 percent of beam theory, except for Load Case 3 (center-binding) where the predicted strains were about 60 percent. This reduction in tensile strain near the tie bottom will cause bending moments estimated from field strain data to be under-estimated using linear beam theory or calibration factors from pure bending tests.

The finite element predictions showed that differences in assumed modulus for concrete had a negligible effect on tie stresses (less than 3 percent) because of the nearly plane-stress loading conditions. But varying the modulus from  $3.6$  to  $4.75 \times 10^6$  psi caused a 25 percent change in predicted strains. Therefore, it is important to actually calibrate instrumented ties in the laboratory instead of using assumed material properties to convert strain data into stress or bending moment estimates.

#### 4.2 Torsion Stresses

As discussed in Appendix B, torsional moments on ties cause one of the principal stresses to be tensile. This tensile stress can be reduced by prestressing, but it cannot be eliminated. Therefore, the allowable torsional stress should be based on the tensile strength of concrete with an appropriate safety factor. If it is decided that no tensile stress should be allowed, transverse reinforcement would be required in the tie center section where torsional stresses are maximum.

## 5. TIE AND FASTENER SPECIFICATIONS

The performance history and corresponding development of specifications for concrete ties and fasteners were discussed in Section 3, and additional details about tie stresses were discussed in Section 4. The objective of this section is to utilize this background, and to provide an evaluation of parts of current tie and fastener specifications which failure experience has shown to be the most important. This evaluation is not intended to cover rigorously the entire current AREA specifications, as given in Bulletins 655 [5-1] and 660 [5-2].

The intent of the AREA specification is to provide minimum performance requirements as a guide to the design, manufacture, and use of concrete ties and fasteners to obtain satisfactory performance in U.S. mainline railroad service. The philosophy of the specifications, as discussed by Way [5-3], is to give performance rather than design requirements to avoid inhibiting originality in design or manufacturing. However, it was recognized that the specifications must include sufficient laboratory tests or other requirements to insure that a design would be capable of withstanding the loading and environmental conditions for an adequate service life (frequently specified as 50 years). The specification of 7000 psi minimum concrete compressive strength is an example of this conflict between performance and design requirements. The flexural strength specifications give performance requirements which can be met by an unlimited number of tie design and concrete strength combinations. However, the seemingly redundant concrete strength requirement is intended to provide the long-term resistance to weathering and abrasion for which an adequate short-term laboratory test is not available. The current AREA specifications include many examples where it has been necessary to supplement performance specifications with design requirements to overcome a lack of suitable performance data or laboratory test procedures.

### 5.1 Vertical Load Distribution

Vertical loads are a major element in tie and fastener specifications. Wheel loads applied to the rail are distributed to several ties and fasteners. The percentage of wheel load carried by a single tie, a distribution factor, depends principally on tie spacing, rail size, and the rigidity of the track roadbed. Current specifications include a distribution factor which varies



from 45 to 60 percent for concrete tie spacing from 20 to 30 inches, respectively, compared to a distribution factor of 40 to 55 percent for the same spacing of wood ties. The higher distribution factor for concrete ties reflects the increase in stiffness which occurs when concrete ties are used instead of wood ties on identical roadbed. These load distribution factors only show the effect of tie spacing, using a conservative estimate for the effects of other parameter variations.

Data from tests on many different types of railroad track show that the percentage of wheel loads carried by individual ties varies considerably from tie to tie. Consequently, the load distribution factor, like all track load variables, would be described more accurately by statistics which include spatial (tie-to-tie) and traffic variations.

Figure 5-1 from Reference 5-4 shows data from the Florida East Coast (FEC) and Kansas Test Track (KTT) test. Spatial variations cause considerable scatter, but it appears that the design for concrete ties gives a reasonable conservative estimate for the effect of tie spacing on the maximum mean load distribution factor. Average mean load distribution factors are consistently below the design guidelines.

The principal use of the tie load distribution factor in current specifications is to establish flexural strength and rail seat vertical load requirements for tie spacings less than 30 inches. These are calculated from the load requirements established for 30-inch spacing, which in turn have been developed from tie performance experience, as discussed in Section 3.

## 5.2 Impact Factor

Current specifications relate vertical wheel load, P, and tie rail-seat loads, Q, by the relation:

$$Q = P(1 + IF/100)(DF/100), \quad (5-1)$$

where

IF = impact factor in percent

DF = tie load distribution factor.

The impact factor is intended to estimate the dynamic effect of wheel and rail irregularities in increasing actual track loads above maximum static wheel loads. Table 5-1 shows the rail seat load estimates used in the original and current AREA specifications. Current specifications are based on IF = 150 percent, whereas the original specifications used IF = 50 percent based on

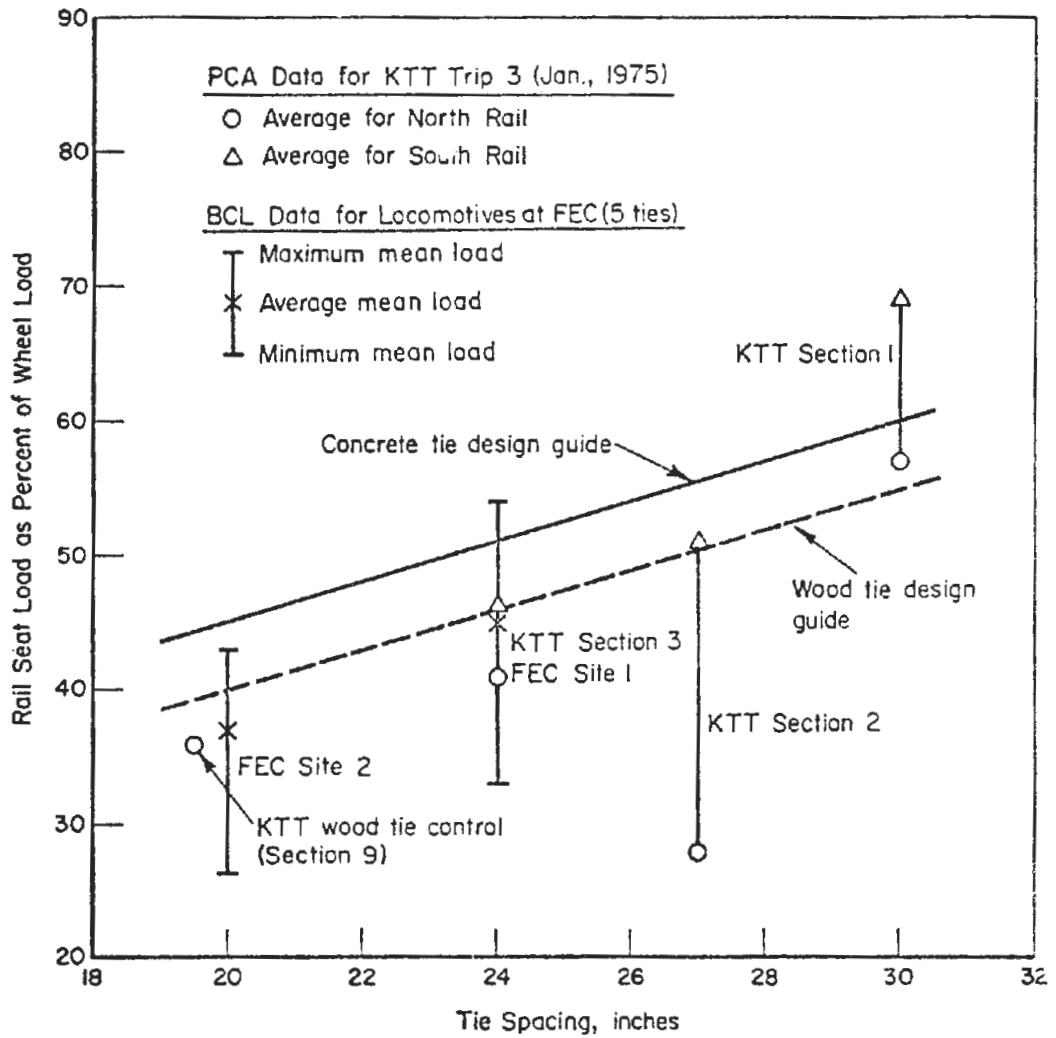

FIGURE 5-1. EFFECT OF TIE SPACING ON MEAN RAIL SEAT LOADS FOR LOCOMOTIVES [5-4]

TABLE 5-1. SPECIFICATIONS FOR VERTICAL TIE LOADS

Tie Spacing, inches	Distribution Factor, percent	Original Specifications		Current Specifications	
		Impact Factor, percent	Rail-Seat Load, kips	Impact Factor, percent	Rail-Seat Load, kips
30	60	50	37	150	61.5
27	55.5	50	34	150	57.05
24	51.0	50	31	150	52.6
21	46.5	50	28	150	48.15

Note: Based on P = 41 kips maximum estimated static wheel load.

conventional railway engineering practice for train speeds up to about 60 miles per hour (see Section 3.5 of Reference 5-4 for additional details). This 3:1 increase in impact factor increases the estimated tie loads by 67 percent. If one were limited to reviewing only the published specifications, these results would indicate that some recent measurements of rail or tie loads must have shown a substantial increase over the original estimates. However, this is not the case. The changes in the specifications have been based on tie performance history which seemed to justify increasing tie rail-seat positive bending moments from 180 to 300 in.-kips (67 percent). Since the specifications also include some equations relating wheel loads, tie loads, and tie bending moments based on a uniform tie support condition, it was necessary to either change the tie support condition assumption or increase the assumed loads to keep the calculations in agreement with the modified bending moment requirements. It was decided to retain the original bending moment equations and increase the loads by a 3:1 increase in the estimated impact factor - a decision supported by the reasoning that tie service failures are probably caused by impact loads from wheel flats, and that these infrequent occurrences have been missed in the track measurement project conducted to-date. Since it is the bending moment requirements rather than the impact factor or the rail seat loads which are of principal interest for tie design, concern for the latter is of less importance. However, the rail-seat loads listed in Table 5-1 for the current specifications exceed any available measured data by a wide margin and must be interpreted as representing a maximum design load with a very low probability of occurrence. Typical data from the FEC railroad [5-4] show that only about 1 of every 1000 axles causes a rail seat load greater than 31 kips on the high rail on a curve.

The maximum vertical loads required for fastener strength tests are considerably lower than those listed in Table 5-1. This will be discussed in a later section of this report.

### 5.3 Tie Flexural Strength Requirements

#### 5.3.1 AREA Specifications

The major flexural strength requirements in current AREA specifications for prestressed concrete monoblock ties are listed in Table 3-6. The acceptance tests are summarized as follows:

a. The rail seat and tie center regions are tested to the required static flexural strength for both positive and negative bending. Acceptance is based on the absence of any structural cracking. Structural cracking is defined as a crack which extends from the tension surface of the tie to the outermost layer of prestressing tendons and which increases in size with increasing load. Limited data in Table 3-5 show that the moment required for a structural crack is about 7 to 11 percent greater than the initial cracking moment, but visual detection of an initial crack in a prestressed tie is very difficult.

b. A positive bending repeated-load test is conducted on the rail seat of a tie which has been precracked from its bottom surface up to the lowest layer of prestress tendons. This test includes 3 million cycles of load varying from 4 kips to 1.1 P, where P is the load corresponding to the rail-seat positive bending moment requirement in Table 3-6. Acceptance is determined by supporting the load of 1.1 P after 3 million cycles. The intent of the repeated-load test is to test the bond strength of the prestress tendons under cyclic load and thereby insure an added safety margin. Ties with large numbers of small diameter wires will generally have greater bond durability than those with a few large-diameter wires. It is generally believed that the major failure mode for a cracked tie is a gradual deterioration of the concrete bond around the prestress strands due to tie flexing. This is considered to be a greater hazard for cracked ties than corrosion of the tendons or deterioration from freeze-thaw cycles.

c. Prestressed ties are also tested for bond strength and ultimate strength using a static positive bending moment applied to the rail seat region. A total load of 1.75 P is applied if initial cracking occurs at a load below 1.1 P. A total load of 1.5 is applied if initial cracking occurs at or above 1.1 P, which is the more usual case. Maximum strand slippage as measured by dial gages is limited to 0.001 inch. The load is then increased to record the ultimate failure load, but there are no specific acceptance requirements for ultimate load.

It is clear that the AREA specifications accept structural cracking at the maximum specified loads and include repeated-load and bond strength tests of cracked ties to provide added durability. However, the historical development of the specifications, as described in Section 3, has been based on the philosophy of increasing the load specifications until they are sufficiently greater

than maximum service loads so that cracking of ties in service is essentially eliminated, or at least restricted to an undefined, low-probability occurrence. It is also important to realize that most tie manufacturers are designing ties to meet or surpass the load specifications for 30 in. tie spacing, whereas they are typically being installed at 24 to 26-in. spacing - an additional load margin of 12 to 20 percent in the rail seat region.

### 5.3.2 Northeast Corridor Tie Specifications

The Federal Railroad Administration (FRA) has prepared technical specifications [5-5] for concrete ties and fasteners which will be installed in the Northeast Corridor (NEC) track at different locations between Washington D.C. and Boston, Massachusetts. These specifications are restricted to ties of 8-1/2-foot length weighing less than 800 pounds. A design service life of 50 years is intended for the concrete ties and fastener inserts and 25 years for other fastener components. The tie strength and test requirements follow closely the current AREA specifications except for a few notable exceptions discussed herein.

a. The static strength tests for design qualification are the same as those required by AREA specifications for 30-inch spacing, although the ties will be installed at 24-inch spacing. A more conservative acceptance criteria permits no "cracking", where cracking is defined as that which is detected visually using an illuminated 5-power magnifying glass. This may not represent a large change in strength based on the limited data in Table 3-5 which show that the moment required for "initial cracking" is only about 7 to 11 percent lower than the "structural cracking" moment.

b. The rail-seat repeated-load test is substantially different and is evidently intended to conservatively simulate service fatigue-loading conditions. The repeated-load test is applied to an uncracked tie and includes both positive and negative bending moments cycling between +235 and -90 in.-kips. These amplitudes are 77 and 75 percent of the static positive and negative moment requirements, respectively. Acceptance is based on withstanding 3 million cycles with no detectable cracking, as described previously.

c. Revision 4 of the NEC specifications includes a tie-center repeated-load test which is not in the AREA specifications. This test includes bending moments cycling between +83 and -153 in.-kips. These amplitudes are 75 and 73

percent of the static positive and negative moment requirements, respectively. Acceptance is based on withstanding 3 million cycles with no detectable cracking.

It is apparent that these repeated-load tests are intended to simulate the alternating stresses from either the vertical uplift forces during wheel passage (typically about 5% of the maximum compressive load), or tie vibration which can be excited by the impact from wheel flats. Although there is no evidence that this type of fatigue loading has caused previous tie failures, the possibility that cumulative fatigue damage might initiate cracking at loads considerably less than those required to initiate a crack under static loads has been conjectured [5-4]. Results from the initial test with NEC ties should demonstrate if fatigue is an important crack initiation mechanism for concrete ties. This possibility has been omitted from current AREA specifications.

d. A combination torsion and tie-center negative moment static load test was also added in Revision 4 of the NEC specifications. This requires a bending moment of  $-153 \text{ in.-kips}$  and a torsional moment of  $20T \text{ in.-kips}$ , where  $T$  is the width of the top of the tie at the rail seat in inches.

e. No ballast requirements were included in the concrete tie specifications for the NEC.

### 5.3.3 Tie Failure Criteria

An evaluation of current tie specifications presents a dilemma with regard to appropriate failure criteria. Specifications intended to eliminate cracking have required several increases in design strength and this produces a corresponding increase in tie size, width, and cost; all of which are detrimental to concrete tie economics. Additional evaluation of the effect of cracking on tie life is needed to determine appropriate failure criteria for tie specifications. A demonstration that early cracking does not lead to excessive service failures or reduced life would permit cracking and therefore the use of smaller ties and the formulation of specifications emphasizing fatigue strength rather than static strength. An additional consequence of this change in failure criteria is that tie designs based on fatigue strength might have different trade-offs in material selection from those for static strength. Steel selection where those with increased ultimate strength frequently have lower fatigue strength is an example from structural design which shows how failure criteria can have an important influence on optimum design. No

specific examples of how concrete properties would be selected differently for fatigue have been identified in this project, but this seems like a viable opportunity once the objective has been established. There are several concrete tie installations including the intermediate ties on the Santa Fe, the KTT ties installed at FAST, and ties on the FEC where the long-term performance of cracked ties can be monitored.

#### 5.3.4 Design Reliability

Results discussed in previous sections indicate that there are sufficient questions about the failure criteria governing concrete tie performance to make further development or modifications of performance specifications difficult. However, the concept of design reliability can be applied to the two basic failure mechanisms of:

- a. initial cracking due to a single occurrence of a load which exceeds the tie strength, and
- b. cumulative fatigue damage which causes a gradual loss of bond and results in a structural failure to determine the appropriate loading criteria for each.

Reliability with regard to a fracture failure where the applied load exceeds the tie design strength is evaluated conceptually as shown in Figure 5-2. Tie bending strength in terms of initial cracking moment varies from tie to tie due to manufacturing tolerances in geometry, prestress, and material properties. Table 3-4, for example, lists initial cracking moment data for both rail seats of six ties. These ties show a mean strength of 332 in.-kips and a standard deviation of 22 in.-kips.

Deriving statistical tie load data suitable for a reliability analysis is more complex than the strength data. Bending moments on each tie show statistical distributions from the train traffic, but these loads change during the tie's life due to variations in support conditions. Spatial variations in roadbed conditions and track layout (curves, spirals, grades, etc.) will also cause additional tie-to-tie loading variations. The load distribution which is needed for a failure analysis must be presented in terms of the number of ties (frequency of occurrence) which are subjected to one occurrence of a given maximum bending moment during a selected design life. When this is compared to the strength distribution in terms of number of ties (frequency of occurrence) having a given strength, the cross-hatched interference region where the maximum



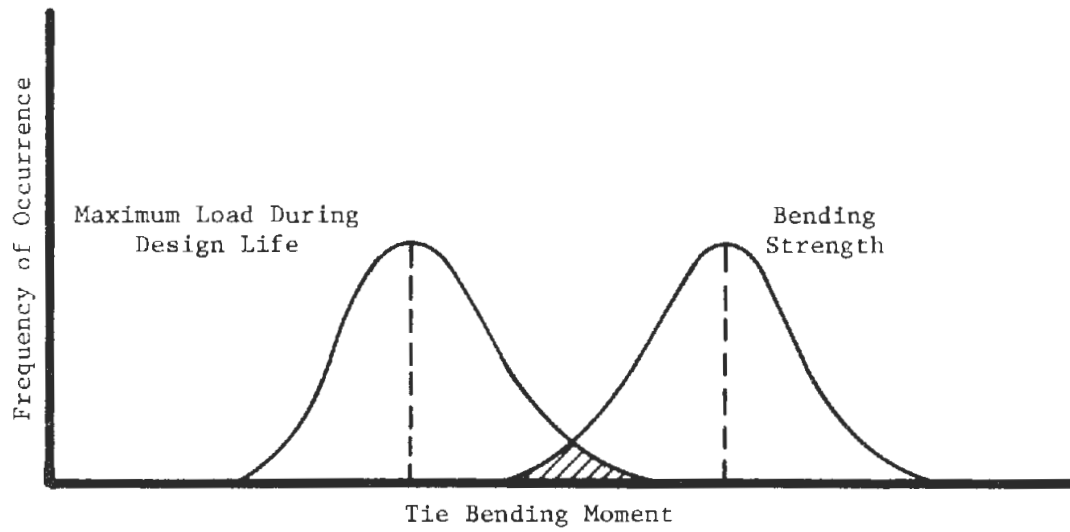

FIGURE 5-2. INTERFERENCE OF TIE LOAD AND STRENGTH DISTRIBUTIONS

load exceeds the tie strength represents the number of ties which will be cracked during the design life. If failure is caused by fatigue rather than fracture from a single load, the interference analysis requires a comparison between fatigue strength data for a specified life (number of cycles) and load data in the form of number of ties versus "equivalent fatigue load". The equivalent fatigue load represents a bending moment of constant amplitude that would cause tie failure at the same life obtained by applying the actual service load spectrum. This requires the use of fatigue data and a cumulative damage criteria such as Miner's rule.

The benefit of evaluating tie failures from a reliability basis is that design criteria can be established to achieve an acceptable and realistic service performance in terms of number of failed ties per year instead of striving for an unrealistic goal of zero failures. The difficulty with this approach is that it requires data on the statistical description of tie loads over a design life and statistical descriptions of tie strengths, which are not readily available. However, these data can be obtained once the appropriate failure mode is identified.

The application of interference theory to predicting failure rates has been relatively well developed and is described in tests on statistical analysis, such as Reference 5-8. The complexity of the mathematics depends on whether the statistical distributions for loads and strength can be approximated by mathematical formulations or require numerical analysis. Tabular results are available for Weibull and normal distributions, which are frequently used to approximate results for fracture and fatigue. Following are two examples to demonstrate typical results which can be obtained from a reliability prediction.

#### Example 1

Assume tie bending strength can be represented by a normal distribution with a mean  $\mu_x = 332$  in.-kips and a standard deviation  $\sigma_x = 22$  in.-kips. Determine the allowable mean loading,  $\mu_y$ , to limit tie failures due to initial cracking to 1 percent per year for a traffic level of 20 MGT. Assume that tie loading, in terms of frequency of occurrence of ties which exceed a specified load once per year for this traffic density, can be represented by a normal distribution with  $\sigma_y = 20$  in.-kips.

This problem is one of interference of two normal distributions. The difference between the strength,  $x$ , and load,  $y$ ,  $z = x - y$ , is also a normal distribution with mean value  $\mu_z = \mu_x - \mu_y$  and variance  $\sigma_z^2 = \sigma_x^2 + \sigma_y^2$ . The probability of failure [5-8] is given by the integral of the normal curve over the region  $(-\infty, 0)$ , where the standardized normal variate is given by:

$$z_\alpha = \frac{(x - y) - (\mu_x - \mu_y)}{\sqrt{\sigma_x^2 + \sigma_y^2}} = \frac{z - \mu_z}{\sigma_z} \quad (5-2)$$

The solution is obtained by entering a normal distribution table at  $\alpha = .01$  (1 percent) and locating  $z_\alpha = -2.33$ . When  $z = 0$  or negative, tie load exceeds tie strength and failure results.

$$z_\alpha = -2.33 = \frac{\mu_y - \mu_x}{\sqrt{\sigma_x^2 + \sigma_y^2}} = \frac{\mu_y - 332}{29.75}, \quad (5-3)$$

$\mu_y = 262$  in.-kips, which is 79 percent of the mean tie strength.

#### Example 2

Assume that over a 1-year period each tie in a section of track will have been subjected to the same load spectrum so that the maximum load experienced by all ties is identical and equal to  $\mu_y = 205$  in.-kips ( $\sigma_y = 0$ ). Assuming the same strength distribution in Example 1, we want to predict the expected number of cracked ties:

$$z_\alpha = \frac{262 - 332}{22} = -3.18 \quad . \quad (5-4)$$

Normal probability tables show that the failure probability is 0.048 percent, or 1 tie of every 2083 will crack during a 1-year period. This is about 1-1/4 ties every mile for a 24-inch tie spacing. This is substantially less than the 26 tie failures per mile for 1 percent failure rate in Example 1.

These examples illustrate the sensitivity of failure rate to the variation in tie loading as quantified by the standard deviation. They also demonstrate how realistic failure expectations can be used to evaluate tie loading and strength requirements.

#### 5.4 Tie Torsional Strength Requirements

Current AREA tie specifications do not include any torsional strength requirements. However, a restriction on the maximum differential tilt of the rail seats (1/16 inch over a width of 6 inches) is included to minimize torsional loads, and dimensional requirements restrict the minimum width and bearing area of the tie bottom to effectively eliminate the wedge-shaped section that resulted in torsional failures in early tie designs. As discussed in Section 5.3.2, a torsional load requirement of 20T in.-kips was added to the NEC tie specifications.

Although it has not been verified that differential tilt of the rail seats is the principal cause of torsional loads, this seems to be a reasonable explanation. A quantitative relationship between rail seat geometry and torsional load must also include the width of the rail pad, the stiffness of the pad and fastener, and the torsional restraint provided by the track foundation. The use of measured data to establish design loads is recommended rather than pursuing an analytical solution of this type of problem. Data from the FEC measurement program [5-4] showed that from 18 instrumented ties, the highest loaded tie had a mean torsional moment of 8.5 in.-kips, a standard deviation of 4.7 in.-kips, and a 0.1 percent exceedance load of 25 in.-kips.

An extrapolation to the  $10^{-6}$  percent probability exceedance level using a normal distribution gives a maximum moment of  $8.5 + 5.6(4.7) = 34.8$  in.-kips. A design limit of 40 to 50 in.-kips would probably be adequate for the FEC tie configuration but a higher load would be required for greater tolerances in rail seat alignment and/or wider tie pads. The NEC specification would require a 180 in.-kips torsional moment for the 9-in. wide FEC tie.

It is recommended that a torsional strength requirement be used in tie specifications in place of requiring a minimum tie width in the tie center section to insure adequate strength. Tie center binding is an important track problem and design innovation, such as the wedge-shaped center section, should be encouraged. It is unfortunate that this design was eliminated because of the unexpected torsional failures before its effectiveness in reducing center binding could be fully determined.

## 5.5 Rail Fastener Requirements

The sections which follow include a review and evaluation of the basis for current specifications for rail fasteners used with concrete ties. The major elements are longitudinal restraint requirements, vertical and lateral design loads, and fastener durability.

### 5.5.1 Longitudinal Restraint

The longitudinal restraint characteristics of rail fasteners on concrete ties replace the role of the rail anchor commonly used with wood ties. This restraint is needed to react the longitudinal loads from traction and braking of trains, and from thermal expansion and contraction of continuous welded rail. A typical design requirement is to maintain a minimum rail gap for safe wheel passage when a rail fractures at temperatures below the mean rail-laying temperature. In tie-ballast track, the fastener longitudinal restraint should exceed the holding power of the concrete tie in the ballast, but there is no advantage in providing greater restraint.

Some measured data indicate that the longitudinal restraint characteristics of concrete ties in ballast typically have a linear load-deflection characteristic for loads below a slip of about 1800 lbs. per rail per tie (3600 lbs. per tie), and that slip begins when the tie has moved about 0.2 inch in the ballast. However, recent results from experiments on the South African Railways (SAR) [5-9] indicate that rail fasteners should provide a minimum longitudinal restraint force of 2700 to 3100 lbs. per rail to avoid rail creep and tie skewing on grades and curves. Results from the FAST track at Pueblo, Colorado confirm that rail creep and tie skewing are a problem in these areas. Current AREA specifications require a longitudinal restraint (with no vertical load) of 2400 lbs. per fastener, with a maximum deflection of 0.25 inch. The longitudinal restraint capability is measured after the fastener is subjected to 3 million cycles in a repeated-load test. Therefore, the adequacy of the longitudinal restraint evaluation depends on the adequacy of the minimum restraint load and on whether or not the condition of the fastener is representative of its true service condition following the repeated-load test.

Differences between the field and test performance of fasteners indicate the repeated-load test is not a realistic simulation of the service environment. This will be discussed in the following section.

It also appears that the minimum longitudinal restraint load needs to be increased, which can be accomplished by increasing the fastener clamping force (toe load) or using a rail pad with a higher coefficient of friction. But increasing the restraint force to a value of 6,000 to 10,000 pounds, which is typical of rail anchors, while retaining fastener resilience is difficult. A better approach may be to reduce tie skewing by reducing the variation in fastener restraint force that can result from dimensional tolerances in ties, pads, and clips. Having fasteners with a somewhat low, but equal longitudinal restraint force may maintain tie alignment better than having a higher restraint force but with fastener-to-fastener variations sufficient to initiate slewing. A device to quickly measure fastener toe loads in track is needed to correlate fastener performance with longitudinal restraint.

#### 5.5.2 Fastener Vertical and Lateral Loads

Vertical fastener loads include a large compressive load when a train wheel is directly over, or close to, a fastener, and an "uplift" force that both precedes and follows wheel passage. In conventional wood tie track, the spikes permit relatively free upward motions of the rail. But a resilient rail fastener which clamps the rail to the tie must be capable of withstanding the compressive and uplift forces continuously.

In addition to the vertical loads, large lateral loads are developed by trains on curves, by vehicle hunting, and also by the rail forces due to thermal expansion and contraction. Fasteners must be designed to withstand these loads and to prevent excessive lateral motion of the rail head in order to avoid derailments due to excessive gage or rail rollover.

Table 5-2 summarized some typical fastener design loads for "maximum" and "frequent" loading conditions. The "maximum" condition relates to the ultimate strength of the fastener for a single load application; the frequent loading condition is intended to represent a reasonable service load for fatigue design and endurance tests.

The column labeled conventional design is based on a maximum expected vertical wheel load of 72 kips (36 kips static with a dynamic load factor of 2) and a 60 percent distribution factor to estimate maximum fastener loads for 30-inch spacing. The frequent compressive load is based

TABLE 5-2. SUMMARY OF TYPICAL VERTICAL AND LATERAL RAIL FASTENER DESIGN LOADS

	Design Loads, kips		
	Conventional Design <sup>(a)</sup>	AREA Specifications	NEC Specifications
<u>Vertical Rail-Fastener Load</u>			
Maximum Compressive	43.2	35.5	44
Maximum Uplift	2.2	1.5P <sup>(b)</sup> (10 kips limit)	1.8
Frequent Compressive	16.2	28.2	30
Frequent Uplift	0.8	0.6P	4
<u>Simultaneous Vertical/Lateral</u>			
Maximum	43.2/39	35.5/20.5	--
Frequent	16.2/9.7	28.2/10.3	30/10

(a) 30-inch tie spacing.

(b) P is the uplift load required to just overcome the fastener assembly preload (i.e. decompress tie pad). Typical values for P are 3.2 to 5.4 kips.

on the same 60 percent distribution factor and a 27 kip wheel load representing an RMS (mean +1 standard deviation) value from measured data on the FEC railroad. Approximately 15 percent of the wheel loads will exceed this value. This represents about 0.2 million cycles/year for 20 MGT annual traffic. Uplift loads are estimated as 5 percent of the fastener compressive load based on beam-on-elastic-foundation track analysis models. Track load measurements have verified that this is a realistic estimate.

Lateral loads are more difficult to predict than vertical loads. However, frequent lateral wheel loads equal to 40 percent of the vertical wheel load ( $L/V = 0.4$ ) and a maximum lateral wheel load equal to 60 percent\* ( $L/V = 0.6$ ) of the maximum expected vertical load are reasonable estimates. Previous BCL analyses [5-6] indicated that 80 to 90 percent of the lateral wheel load can be transmitted through a single fastener, so the 90 percent factor was used to estimate frequent lateral loads for Table 5-2.

Fastener load requirements from current AREA specifications and the NEC specifications are also listed in Table 5-1 for comparison. The AREA fastener requirements for vertical and lateral loads are summarized as follows:

a. A static uplift test using a maximum load of  $1.5P$ , where  $P$  is the load required to overcome the fastener preload, is used to evaluate ultimate strength.

b. A repeated load test with simultaneous vertical and lateral loading of 28.2 and 10.3 kips and a separate uplift force of  $0.6P$  is used to evaluate fastener endurance for 3 million cycles.

c. A static lateral load-restraint test using simultaneous vertical and lateral load components of 35.5 and 20.5 kips, respectively, applied by using a 41 kips fixed load ram at an angle of 30 degrees from vertical. Translation of the rail base must be less than  $1/8$  inch. A second test is made with a 20.5 kips ram load with the rail head free to move laterally. Rotation at the rail head must be less than  $1/4$  inch.

The NEC specifications for fasteners are considerably different than the AREA specifications. The major requirements are:

a. The vertical spring rate over the initial 1800 lbs. of uplift must be between 200,000 and 900,000 lb. per in. The maximum allowable spring

---

\* A lateral wheel force equal to 80 percent of the vertical wheel force is a frequently quoted lower bound on the wheel-climb derailment criteria.



rate was originally 350,000 lb. per in., but this was increased because the requirement cannot be met using the thin, stiff tie pads which are generally preferred for current fastener designs.

b. A static uplift test is used to determine the load P required to overcome the precompression, and this is continued to a maximum deflection of 0.1 inch to check ultimate strength.

c. A static compressive load of 55 kips plus the normal precompression load is applied to the tie pad, and permanent set must be less than 0.001 inch.

d. A 44-~~kip~~ compressive load and a 1.8-~~kip~~ uplift load are applied to a complete rail fastener assembly while variations in the rail clip toe load and pad thickness are measured. With the maximum compressive load applied, the toe load is not permitted to be reduced by more than 75 percent and the pad deflection cannot exceed 25 percent of its original, uncompressed value. At least 25 percent of the original pad compression deflection must be retained with the 1.8-~~kip~~ uplift load, so the fastener preload must exceed 1.8 kips by a substantial margin. The loads used for this test appear reasonable based on typical calculations of maximum uplift loads.

e. A repeated load test with simultaneous vertical and lateral loading of 30 and 10 kips, respectively, and an uplift force of 4 kips, is very similar to the AREA requirement for a 3 million cycle evaluation. However, the NEC specification originally included vertical vibration of 100 g's at 1000 Hz and the vertical loads are applied in a manner intended to simulate the longitudinal rocking of the rail relative to the tie during wheel passage. The 1000 Hz vibration was deleted in later revisions of the specifications because it proved to be a very difficult laboratory test. These modifications were made to the AREA repeated load test in an effort to include the critical elements from service loading that have caused poor field performance of fasteners which passed the AREA tests. An evaluation of this modified repeated load test should be based on a comparison of field and test performance. It is not clear if including the rail rocking motion will adequately simulate fastener loading, or if it may also be necessary to add a longitudinal rail force. Although rail vibrations as high as 100 g's at 1000 Hz can be excited by impacts from wheel flats, the estimated displacement of 0.001 inch is quite small compared to that caused by wheel passage. Therefore, it does not appear that this type of vibration would be expected to be an important factor in fasteners.

f. A fastener push-pull test using a cycling longitudinal load of +2400 lbs. for 1 million cycles provides an additional evaluation of fastener durability. Assuming that this type of longitudinal load cycling must be caused by thermal cycles, the number of load applications appears excessive. A cyclic rate of one per day over a 25-year life produces less than 10,000 cycles, and this is a very conservative assumption for thermal loads.

An overall review of the loads listed in Table 5-2 shows that the major differences are in the uplift load and in the frequent vertical and lateral loading used in the repeated load test. AREA and NEC uplift load specifications appear excessive. The AREA procedure of basing the uplift load on the fastener precompressions rather than expected track loads does not seem reasonable and may penalize some fastener designs.

Specifications for frequent vertical and lateral loading are in close agreement on a maximum lateral load of 10 kips. However, the lower vertical load of 16.2 kips based on typical track load data produces a more severe fastener loading condition than the combination of a 30-kips vertical and 10-kips lateral load. This unusual condition occurs because the higher vertical load reduces the overturning moment and stabilizes the fastener, so that maximum deflections and fatigue loads on the clips will usually be reduced. This effect should be verified in a test, but it may be one of the factors contributing to unexpected service failures of rail clips.

### 5.5.3 Fastener Durability Evaluation

The previous section discussed the fastener load environment and current specifications by using conventional track design practice to estimate maximum loads appropriate for ultimate strength criteria. Statistical data from the FEC railroad were also used to develop "frequent" load occurrences based on an arbitrary choice of the RMS level to compare with the load requirements prescribed by repeated-load tests in current specifications. However, an important observation about the current repeated-load test requirements is that there is no way to relate the performance of a fastener in the test to its expected service life in track.

Neglecting environmental effects, fastener service life in track is determined by the fatigue life of the metal components and the durability of the elastomeric elements under the variable amplitude, cyclic loading from passing trains. It is well established that fatigue is a cumulative damage

process involving localized plastic strains. Accurate fatigue life prediction for complex histories of track loads involves either (1) an experimental approach in which the load history is duplicated as closely as possible, or (2) an analytical approach in which damage is accumulated theoretically using a realistic description of the local stress-strain patterns at critical regions of fastener components. The testing approach should be based on a representative statistical load spectrum that can be implemented in several ways:

a. Programmed constant amplitude tests in which the load spectrum is subdivided into individual blocks of constant amplitude cycles can be used to simulate the service history. The exact sequencing of the load blocks sometimes has an important effect on the fatigue life.

b. A service duplication test in which a tape-recorded load history or a synthesized random input is used for the test. Test time and complexity are important disadvantages of this approach. Test time can be reduced by judicious truncating of lower load cycles or increasing the higher loads, but the effect of these load-history modifications on service life is difficult to predict.

The technical requirements for these procedures are summarized in Appendix B of a previous report [5-7] on rail fastener evaluation. However, it is clear that a fatigue test using 3 million cycles of a constant amplitude load is not intended to be an accurate simulation of a realistic service life. A 25-year life represents approximately 34 million load cycles based on an estimated 3700 axles per day for 20 MGT annual traffic. Therefore, the 3 million cycles of the repeated load test represents a life of about 2.2 years if it is assumed that the specified load will produce the same damage as the total load spectrums.

Another interpretation of the constant amplitude test is that the specified loading conditions are intended to represent an accelerated test, and that all damage from load cycles less than the test load can be neglected--a very questionable assumption unless the test load is below the endurance limit. The 3 million cycles represents about 9 percent of the total load cycles of the 25-year life example. In this case, the test load represents a truncation to the 91 percent exceedance level (higher loads are reduced to the specified load) and damage from the 31 million cycles of loads lower than the test load are assumed to be negligible.

Perhaps a more realistic interpretation of the fastener repeated-load test is that it represents a sufficiently severe evaluation to discriminate between those fastener designs which have some chance of good service performance and those which should be improved before any service evaluation. The validity of this type of screening process depends directly on performance experience. Results from FAST, which provides an accelerated fastener load test under relatively realistic conditions, can be used to further evaluate this testing philosophy as a replacement for a more realistic service life evaluation based on load spectra.

## 6. ALTERNATIVE MATERIALS FOR TIE/FASTENER SYSTEMS

In addition to wood and concrete, there are several other materials which have progressed through various stages of development for railroad ties. The performance requirements for tie/fastener systems are based largely on providing an adequate restraint for the rails and distributing the train loads onto the track roadbed. This requires a structural member with a specified bearing area and it must be sized to provide adequate strength and durability over the design life. Design loads are not strongly dependent on tie materials, although results from a parametric analysis [6-1] show that the tie bending stiffness does have some effect on the pressure distribution under the tie and the tie bending moments. However, since bending stiffness is determined by both material properties (Young's modulus) and size (area moment of inertia), this allows considerable flexibility in material selection. In practice, material availability and cost are more important factors in the choice for tie materials than are the technical requirements.

Historical performance has shown that compatibility between the tie and fastener is of major importance, and this is a material-dependent design problem. For example, wood ties are capable of withstanding impact loading and abrasion in the rail seat region. Concrete ties, however, will suffer considerable spalling and rapid deterioration unless some type of cushioning material is used between the rail and tie.

Another example of tie/fastener compatibility is the vertical uplift restraint requirement. Wood ties with cut spikes permit the rail to lift freely from the tie in response to the wave action during train passage. When a fastener which restrains uplift is used with wood ties, the entire tie is lifted and this increased pumping may require more maintenance of track surface. This pumping action can be essentially eliminated by increasing the tie resistance to uplift by increasing tie weight and/or designing the tie with sloping sides or other configurations which improve the vertical restraint from the ballast. Concrete ties weighing in excess of 700 pounds reduce vertical uplift to a negligible amount, so there would be little advantage in using a "rail-free" fastener design. Allowance for rail uplift is an

important fastener design consideration for light ties or for concrete ties which will be intermixed with wood ties using cut spikes.

While a variety of materials have and can be considered for tie design, the principal U.S. interest in materials other than concrete has been with various methods for recycling wood ties. Steel ties have also received some interest in the U.S. and are undergoing considerable development in foreign countries, so they also will be discussed briefly in this report.

### 6.1 Reconstituted Wood Crossties

Crosstie designs using wood from discarded ties have been developed by the U.S. Forest Products Laboratory (FPL) and by the Cedrite Corporation. Work by the FPL on the development of a laminated particle board tie is summarized in Reference 6-2. Because there were no performance specifications for timber crossties, the properties of a typical red oak tie having near maximum defects permitted by AREA 645 Chapter 3 were used to estimate the following minimum design requirements:

Bending Strength	3100 psi minimum (228 in.-kips for 7 in. x 9 in. tie)
	4500 psi average (331 in.-kips for 7 in. x 9 in. tie)
Shear Strength:	180 psi minimum
Modulus of Elasticity (MOE):	$1.1 \times 10^6$ psi average

Note that the minimum bending strength is approximately equal to current rail-seat bending moment requirements listed in Table 3-6 for 8-1/2 foot concrete ties at 21 inch spacing, which is about the maximum spacing normally used for timber ties.

Other properties such as fatigue, spike withdrawal, tie plate wear and cutting, dimensional stability, durability, and loading characteristics under high moisture content are also important.

The FPL tie design utilized multiple thin laminated boards having different properties for the inner and outer layers to achieve an overall MOE goal of  $1.1 \times 10^6$  psi and an adequate combination of high hardness, strength, and durability of the outer layers, and adequate shear strength of

the inner layers. Investigations of the effects of wood type, resin content, particle geometry and orientation, and density on board physical properties are reported in Reference 6-2. The freedom to engineer a tie for efficient utilization of materials is an important advantage for a reconstituted product.

Initial tests by the FPL showed that MOE ranged from about  $1.0 \times 10^6$  to  $1.13 \times 10^6$  psi and modulus of rupture ranged from 4100 to 5000 psi, which is considerably greater than the minimum design goal. Further tests by the AAR [6-3] were based on concrete tie specifications plus a tie wear test to determine spike pull-out force and resistance to tie-plate cutting.

The Cedrite tie is a solid tie made from a homogeneous resin and wood chip mixture. Four different designs evaluated by the AAR [6-4] had various internal reinforcing of steel and wood. Table 6-1 summarizes results from load tests on the FPL laminated tie, the strongest of the four Cedrite designs, and standard timber ties from pine, red oak, and white oak. The standard timber ties were tested by the AAR [6-5] to provide a comparison for the reconstituted ties.

Table 6-1 shows that a bending failure of the FPL tie occurred at 307 in.-kips and a shear failure occurred with cyclic shear loading of  $45,000/2 = 22,500$  pounds. The bending moment tests for concrete ties are not intended to test shear strength, because this is not a usual failure mode in service. Therefore, the validity of this test for wood ties is questionable. The bending moment failure at 307 in.-kips showed strength exceeded the 228 in.-kips design goal by a considerable margin.

The Cedrite tie was not as strong in bending and also showed a possible shear failure in the rail-seat region, although it is difficult to conclusively determine the failure mode. In general, bending failures should originate in the middle of the loaded tie section, where the bending moment is a maximum, and propagate in a perpendicular direction to the tie. Failures which originate at the outer support points, where bending is low and shear is maximum, and propagate at an approximately 45-degree angle are clearly shear failures. Irregular failure patterns indicate a mixed failure mode.

Data from timber tie failures shown an ultimate load ranging from 346 in.-kips for pine to 521 in.-kips for white oak, although [6-4] indicates

TABLE 6-1. RESULTS OF LOAD TESTS ON RECONSTITUTED WOOD AND TIMBER TIES

	Required Moment (in.-kips)	Failure Load		Comments
		Vertical Force (kips)	Bending Moment (in.-kips)	
<b>I. FPL Laminated Tie (7" x 9" x 8'6")</b>				
1. Tie Center Positive Moment	90	22.75	307	Bending failure
2. Rail-Seat Positive Moment	225	>45	>248	No failure at maximum load
3. Rail Seat Repeated Load (3 x 10 <sup>6</sup> cycles)	248	45	248	Apparent shear failure at 1068 cycles
<b>II. Cedrite Tie (7" x 9" x 8' 11-3/4")*</b>				
1. Tie Center Positive Moment		14.35	194	Bending failure
2. Rail-Seat Positive Moment		26	179	Possible shear failure
<b>III. Standard Timber Tie (7" x 9" x 8'0")</b>				
1. Tie Center Positive Moment (Average)				
a. Pine		25.7	346	Shear failure
b. Red Oak		36	486	Shear failure
c. White Oak		38.6	521	Bending failure
2. Rail-Seat Positive Moment				
a. Pine		36.9	180	Shear and bending failures
b. Red Oak		51.0	234	Shear failure
c. White Oak		58.9	287	Bending failure

70

\*Data are for tie having 1-1/2" x 1-1/2" wood diagonal reinforcement.



that even failures at the tie center might have been shear. One would expect the bending strength of a uniform size timber tie to be identical in the center and rail seat regions. Therefore, differences in failure strength indicate the presence of shear, which is higher in the rail-seat test than it is in the center bending test. This results in the ultimate bending moment being much lower in the rail seat region.

The data from these laboratory tests show that it is possible to develop reconstituted wood ties with what appears to be adequate strength. Tie plate wear and spike pull-out tests also show results that are comparable with solid timber ties. However, there was some tendency for the reconstituted ties to swell and delaminate from the cyclic loading and moisture applied as part of the tie wear test. Evaluation in service is needed to determine if this type of failure from moisture or from freeze-thaw cycles is significant. Some reconstituted ties are installed in the Facility for Accelerated Service Testing (FAST) track in Pueblo, Colorado. This will give an accelerated loading test, but will not duplicate severe moisture or freeze-thaw conditions.

## 6.2 Steel Crossties

While experience with steel crossties is very limited to the U. S., use for mainline service in England, Australia, Switzerland, Germany and many African countries began in the late 1800's. Early tie performance was mostly unsatisfactory because of the difficulty in developing a compatible rail fastener.

Figure 6-1 shows the inverted tough configuration that is typically used for steel ties. Proceedings of a seminar [6-6] on steel ties sponsored by the Broken Hill Proprietary Company (BHP) in Australia in March 1977, provides the most recent literature on tie performance. The major technical problems with steel ties are summarized as follows:

- a. It is difficult to pack ballast underneath the ties and this causes high initial vertical settlement rates and low lateral restraint compared to wood or concrete ties. This also makes it inadvisable to insert

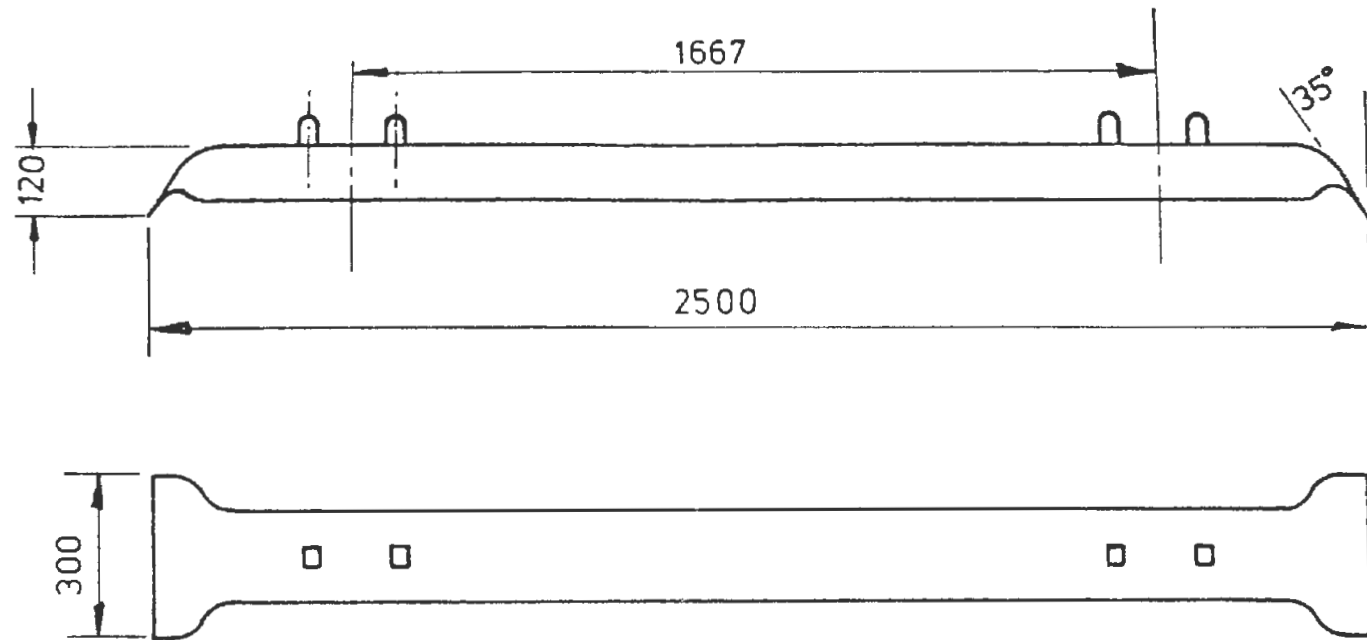

72

AREA 1800 mm<sup>2</sup>  
 MASS/LENGTH 14.14 kg/m  
 I 1.34 × 10<sup>6</sup> mm<sup>4</sup>  
 Z TOP 43.2 × 10<sup>3</sup> mm<sup>3</sup>  
 Z BOTTOM 24.2 × 10<sup>3</sup> mm<sup>3</sup>

NOT TO SCALE

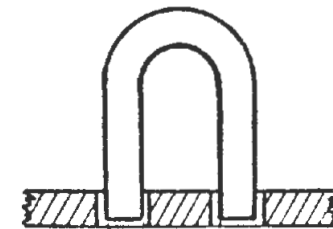
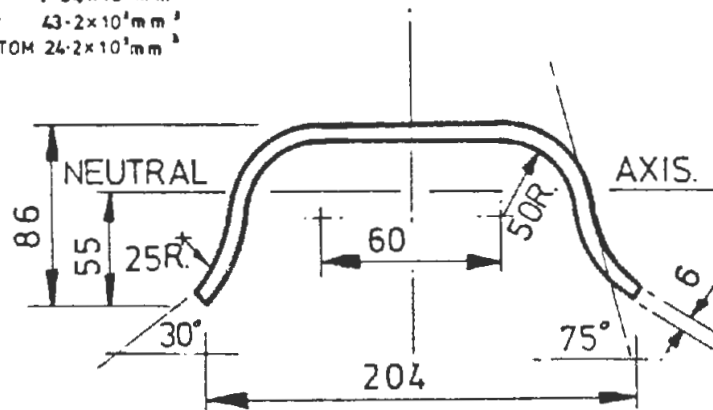

Fastener Lug Detail

FIGURE 6-1. TYPICAL STEEL TIE CONFIGURATION FOR SOUTH AUSTRALIAN RAILWAYS

Note: Unless otherwise specified all dimensions are in mm.

steel ties in an existing wood or concrete track. It is not known if the use of modern tamping equipment, instead of hand tamping, can fully overcome this problem.

b. Tie structural failures usually occur due to corrosion, cracking, and local deformation (dishing) at the rail seats. Fatigue cracks usually initiate at holes or openings used to attach rail fasteners. The rail seat region is highly stressed and any cutouts or welds require careful design.

c. Fasteners which hold the rail firmly in place and provide effective insulation for track signalling have not been available. Development problems with steel tie fasteners are very similar to those for concrete tie fasteners where the design requirements are much more complex than they are for wood ties.

Despite these historical design problems, interest in steel ties by the South Australian Railways has continued and increased about 1973 due to curtailments in the supply of timber ties. The principal advantages of steel ties are:

a. Longer life than timber ties. Experience on German railways shows estimated average life to be 45 years for main line service and 57 years for secondary lines. Switzerland claims an average life in excess of 50 years.

b. Discarded ties can be readily recycled with a high salvage value. One estimate gives the scrap value as about 25 percent of the new steel cost at the time it becomes scrap. With high inflation rates, this could equal the original tie cost.

c. The light weight (compared to concrete) and stackable shape reduce shipping and storage costs and handling problems. The inverted trough shape also reduces ballast by 4 to 5 inches over the entire track because the effective ballast depth for pressure distribution is near the tie top rather than at the bottom as for a solid tie.

d. Many structural failures can be repaired in the field by welding, and derailment damage is not severe when adequate ballast is maintained in the cribs.

e. Resistance to environmental problems such as fire and insects is desirable for selected locations.

It is important to realize that the experience with steel ties in Australia and other foreign countries has, until recently, been limited to traffic with maximum axle loads from 10 to 20 tons, so these ties could not be expected to be suitable for North American service with axle loads up to 36 tons without considerable modifications. However, in 1975 the Mt. Newman Railroad, which operates unit trains of ore cars with North American load limits, in conjunction with the BHP's Melbourne Research Laboratories (MRL), initiated a steel tie/fastener development program. This program has included the following investigations and results [6-6]:

a. Six steel ties were strain gaged on the South Australian Railways line between Adelaide and Northwest Victoria, near Lameroo. These ties weighed 88 lbs (40 kg) each and were installed at a mean spacing of 28.3 inches (720 mm) with a 14 percent standard deviation. Strains were recorded during passage of a ballast train with axle loads of 20 tons (180 kN). Maximum strains of 620  $\mu\epsilon$  were recorded in the transverse direction near the rail fastener lugs. The maximum longitudinal strain was 270  $\mu\epsilon$ . Transverse strains are the most severe in steel ties where vertical loading causes local bending from the spreading of the tie sides as the tie is pushed down into the ballast.

b. The Rainflow stress counting method and Miner's Rule were used to analyze the fatigue life of the tie based on the structural welding code of the American Welding Society. Predictions of about  $2.1 \times 10^6$  cycles to failure represented an expected life of about 80 years for the low traffic density on that particular line.

c. The measured strain data and an analytical model of tie bending were used to conduct a tie design study for a 50-year fatigue life with the heavier axle loads and higher traffic density of the Australian National Railways.

d. Tests at MRL showed that the lateral resistance of a trough shaped tie with wedge shaped ends was approximately 3 times its dead weight, so buckling resistance was judged to be at least as good as timber tie track.

e. MRL is continuing tie design and fastener development work for a tie/fastener system for the mining line. Some ties have been installed in

test sections on the Mt. Newman line, and the results will be directly applicable to North American service.

In addition to these technical development efforts, results from life cycle cost analyses [6-6] shown in Table 6-2 showed that steel ties were the best economical choice for lines with very light traffic, and were only slightly more expensive than concrete ties for heavy traffic. Some of the basic assumptions used in this cost analysis were:

- a. Concrete ties track requires surfacing only 1/2 as often as timber or steel tie track.
- b. Timber tie life was assumed to be 30 years and concrete and steel tie life was assessed to be 40 years. A project life of 30 years was used for the cost analysis. A 25 percent residual value was assigned to the steel ties.

TABLE 6-2. RELATIVE ANNUAL TRACK COSTS

Tie Type	Light to Medium Traffic (1.5 MGT with 19 tonne axle loads)	Medium to Heavy Traffic (15 MGT with 25 tonne axle loads)
Concrete	1.17	1.0
Steel	1.0	1.01
Timber	1.04	1.15

While a more detailed evaluation of the economic feasibility of steel ties for North American use may give somewhat different results than those reported in Australia, it appears that steel ties may have considerable potential as an alternative to timber or concrete. Fastener failures on steel ties at FAST after 29 MGT of traffic and similar foreign experience show that fastener design will require additional development work, but experience from the Mt. Newman line will be of particular interest. The ductile properties of steel should provide a tie which has greater overload capability than do concrete ties, and this is desirable for the unpredictable type of loading that is a characteristic of railroad service.

## 7. FUTURE RESEARCH REQUIREMENTS

The several research tasks summarized in this section have been identified during the reported work on the design and performance of crosstie track. These include several specific research and development activities required to improve performance specifications and refine economic evaluations of alternative tie/fastener systems. The following brief summary of research tasks is not intended to be exhaustive, but it does contain the major topics which have been identified, and these are discussed in descending priority.

### 7.1 Economic Benefits of Concrete Tie Track

The technical feasibility of using concrete ties and fasteners for freight and passenger traffic in North America has been demonstrated in several test sections in the U.S. and Canada and at the FAST track. Economic studies indicate that track life-cycle costs can be reduced by using concrete ties in place of wood ties for track having high traffic density and sharp curves. However, improved data on the relative performance of wood and concrete tie track are needed to refine these life-cycle cost estimates.

Expanded use of concrete ties in North America offers a potential improvement in railroad service and viability by reducing track-related derailments, by reducing maintenance costs for track and rolling stock, and by reducing train fuel consumption. Quantification of these benefits is needed to provide an accurate economic evaluation of concrete tie track for assessment by railroad management.

### 7.2 Influence of Track Design on Track Maintenance Requirements

An improved track design/evaluation methodology is needed to provide quantitative assessments of the influence of track design variables such as tie size, tie spacing, ballast depth, and subgrade properties on the frequency of track surfacing and alignment maintenance. Quantitative relationships between track design and maintenance requirements for a selected

level of service can be used to establish specifications for track construction or rehabilitation that will minimize life-cycle costs and provide a sound economic basis for maintaining and upgrading track.

### 7.3 Rail Fastener Laboratory Tests

The poor performance of rail fasteners designed for new tie concepts such as concrete and steel ties has historically been the major technical hindrance to the acceptance of new tie/fastener systems. A laboratory test procedure is needed to provide realistic accelerated service evaluations of rail fasteners.

A laboratory test which duplicates the essential loads and motions transmitted to rail fasteners can substantially reduce the development time and costs for new and improved rail fasteners, and thereby stimulate increased design innovation. While the FAST track represents a major improvement in capabilities for accelerated service testing, an improved laboratory test is needed to screen candidate tie/fastener systems for FAST and, thereby, reduce the costs and time delays incurred by prematurely manufacturing and installing a batch of components in FAST, or other test tracks, before they have been evaluated adequately in the laboratory.

### 7.4 Feasibility Demonstration of Flexible Rail Fasteners

A demonstration of the technical feasibility and benefits of using more flexible rail fasteners with concrete ties is needed to encourage fastener suppliers to develop improved fastener designs. The rigidity of concrete tie track is typically 2 to 5 times greater than wood tie track. Current fasteners used with concrete ties in the U.S., although they include some elasticity, do not add significant resilience to the overall track structure.

Analytical studies show that more flexible rail fasteners can reduce static loads and dynamic impact loads from wheel flats, rail welds, and rail joints. These loads are important contributors to high track and rolling stock maintenance. Increased rail fastener flexibility may also reduce rail corrugation; a problem which may be more prevalent on concrete tie track.

## 7.5 Concrete Tie Design Criteria

Current tie design specifications are based on satisfying minimum static bending moment requirements intended to prevent structural cracking in service, and this has resulted in substantial increases in tie size and cost. The effect of structural cracking on tie life and the failure mechanism responsible for initiating tie cracking in service must be identified in order to justify current specifications or develop improved specifications.

If it can be demonstrated that structural cracking does not significantly reduce tie life, this would permit the use of smaller, less expensive ties and expand the range of track and traffic conditions for which concrete ties can be used to reduce track costs. The identification of the crack initiation mechanism may also lead to improvements in tie design that provide equal or better performance at reduced cost.

## 7.6 Fastener Requirements for Timber Ties

Several different types of fasteners have been designed as replacements for cut spikes on timber ties. Differences in vertical uplift restraint for the rail range from varying degrees of free uplift to a rigid restraint which also eliminates the need for rail anchors. The advantage of rail fasteners which are intended to reduce tie plate cutting, eliminate spike killing, improve gage retention and prevent rail rollovers versus the disadvantages of increased tie pumping from fasteners which restrain rail uplift need quantification. Improved rail fasteners for timber ties offer considerable potential for improved safety and maintenance for new and rehabilitated timber tie track.



## REFERENCES

### Section 3.0

- [3-1] Weber, J., "Concrete Crossties in the United States", J. of the Prestressed Concrete Institute, 14(1), February 1969, pp 46-61.
- [3-2] "Prestressed Concrete Tie Investigation", Association of American Railroads Engineering Report No. ER-20, AAR Research Center, Chicago, Illinois, November 1961.
- [3-3] "Rail Slippage Tests--Concrete Ties", Association of American Railroads Engineering Report No. ER-22, AAR Research Center, Chicago, Illinois, June 1962.
- [3-4] "Prestressed Concrete Tie Investigation--Second Report", Association of American Railroads Engineering Report No. ER-58, AAR Research Center, Chicago, Illinois, April 1965.
- [3-5] Magee, G.M., "Current Status of Prestressed Concrete Ties on Railroads in the United States", AREA Bulletin No. 600, Vol. 67, June-July 1966, pp 621-640.
- [3-6] "Concrete for Railways", Portland Cement Association, Chicago, Illinois, 1964.
- [3-7] "Concrete Crosstie Installations", Santa Fe-Pomeroy, Inc., September 1976.
- [3-8] Weber, John W., "The latest concrete-tie test sections: What has been their performance?", Railway Track and Structures, August 1976.
- [3-9] Reiner, I.A., "Testing Concrete Ties", Paper given at 12th Annual Railroad Engineering Conference, 1975.
- [3-10] Kish, A., McConnell, D., McCafferty, R., Moody, H. and Sluz, A., "Track Structures Performance--Comparative Analysis of Specific Systems and Component Performance", Report No. FRA/ORD-77/29, prepared by the U.S. Department of Transportation, September 1977.
- [3-11] Prause, R., Harrison, H., Kennedy, J., and Arnlund, R., "An Analytical and Experimental Evaluation of Concrete Cross Tie and Fastener Loads", Report No. FRA/ORD-77-71, prepared for U.S. Department of Transportation by Battelle-Columbus Laboratories and Bechtel, Inc., December 1977.
- [3-12] Prause, R., and Kennedy, J., "Parametric Study of Track Response", Report No. FRA/ORD-77/75 prepared for U.S. Department of Transportation by Battelle-Columbus Laboratories, December 1977.
- [3-13] Reiner, I. A., "Concrete Tie In-Track Performance Test", Report No. DOT-FRA-20015-L-3, Federal Railroad Administration, May 1976.

- [3-14] Weber, J., "Concrete-Technology: Past, Present and Future", Railway Track and Structures, April and May 1972.
- [3-15] Weber, J., "Development of the Prestressed Concrete Tie in the USA", Railroad Track Mechanics and Technology, edited by A. D. Kerr, Pergamon Press, 1978, pp 265-282.
- [3-16] Hanson, N., "Influence of Surface Roughness of Prestressing Strand on Bond Performance", J. of the Prestressed Concrete Institute, 14(1), February 1969.
- [3-17] "Preliminary Specifications for Concrete Cross Ties (and Fastenings)", American Railway Engineering Association - Bulletin 634 Proceedings Volume 73, September-October 1971, pp. 99-139.
- [3-18] Way, G., "New Aspects of Concrete-Tie Track", Railway Track and Structures, December 1971, pp. 22-25.
- [3-19] Weber, J., "The Concrete Tie: What Can Be Expected from It?", Railway Track and Structures, December 1973, pp. 20-21, 36.
- [3-20] "Preliminary Specification for Concrete Ties (and Fastenings)", American Railway Engineering Association - Bulletin 644, Proceedings Volume 75, September-October 1973, pp. 83-131.
- [3-21] "Manual Recommendations - Special Committee on Concrete Ties", American Railway Engineering Association - Bulletin 650, Vol. 76, November-December 1974, pp. 238-240.
- [3-22] Reinor, I.A., "Engineering and Economic Analysis of Wood Tie versus Concrete Tie Track" C&O-B&O Railroad, Research Planning Services Department, February 1966.
- [3-23] "On the C&O/B&O: Main-Line Test of Concrete Crossties", Railway Track and Structures, January 1969, pp. 22-24.
- [3-24] Way, G., "Service Testing Concrete Ties in the Search for Optimum Track", Dynamics & Economics of Railway Track Systems, Railway Systems and Management Association, Chicago, Illinois, February 1970, pp. 155-168.
- [3-25] Way, George, H., Jr., "Progress Report - Concrete Tie Track at Noble, Illinois, C&O-B&O Railroad, Research Services Report No. 73-102, March 15, 1973.
- [3-26] Way, George H., Jr., "Developmental Tests of Concrete Tie and Tie Fastening Systems", Report No. 73-106 prepared for DOT/FRA by C&O/B&O Railroad, May 4, 1973.
- [3-27] Venuti, W.J., "An Investigation of Concrete Ties and Rail Fasteners", Proceedings from the International Symposium on Prestressed Concrete Pipes, Poles, Pressure Vessels and Sleepers, February 14-16, 1972.

- [3-28] Hanson, N., Ball, C., and Weber, J., "Kansas Test Track Instrumentation", Report Prepared for U.S. Department of Transportation by Portland Cement Association, July 1976.
- [3-29] Ball, C., Hanson, N., and Weber, J., "Collection and Analysis of Test Data from Kansas Test Track", Report prepared on U.S. Department of Transportation Contract DOT-FR-90043 by Portland Cement Association (To be published).
- [3-30] Ball, C., April , 1977, "Progress Report - Kansas Test Track - Contract DOT-FR-90043". Portland Cement Association, June 2, 1977.
- [3-31] Kish, A., McConnell, D., McCafferty, M., Moody, H., and Sluz, A., "Track Structures Performance -- Comparative Analysis of Specific Systems and Component Performance", U.S. Department of Transportation Report No. FRA/ORD-77/29, September 1977.
- [3-32] "Manual Recommendations -- Special Committee on Concrete Ties", American Railway Engineering Association -- Bulletin 655, Vol. 77, November-December 1975, pp. 193-236.
- [3-33] "Manual Recommendations -- Special Committee on Concrete Ties", American Railway Engineering Association -- Bulletin 660, Vol. 78, November-December 1976, pp. 133-137.
- [3-34] Weber, J., "For the Concrete Tie: New Round of Service Tests", Railway Track and Structures, August 1974, pp. 17-19.
- [3-35] Weber, John W. and Ball, Claire, G., "Performance Evaluation of Concrete Tie Test Section on the Santa Fe at Leeds, Illinois", Portland Cement Association, October 1976.
- [3-36] Weber, J., "The Latest Concrete Tie Test Sections: What has been Their Performance", Railway Track and Structures, August 1976.
- [3-37] "This Concrete-Tie Test Features Conventional Rail Anchors", Railway Track and Structures, August 1977, pp. 28-29.
- [3-38] "Specifications for MR-Modified Prestressed Concrete Railway Ties", Railroad Concrete Crosstie Corporation, October 17, 1973.

#### Section 4.0

- [4-1] Talbot, A. N., et al, "Second Progress Report of the Special Committee on Stresses in Railroad Track", AREA Proceedings, Volume 21, 1920, pp 760-762.

## Section 5.0

- [5-1] "Manual Recommendations - Special Committee on Concrete Ties", American Railway Engineering Association Bulletin 655, Vol. 77, November-December 1975, pp 193-236.
- [5-2] "Manual Recommendations - Special Committee on Concrete Ties", American Railway Engineering Association Bulletin 660, Vol. 78, November-December 1976, pp 133-137.
- [5-3] Way, G., "New Aspects of Concrete-Tie Track", Railway Track and Structures, December 1971, pp 22-25.
- [5-4] Prause, R., Harrison, H., Kennedy, J., and Arnlund R., "An Analytical and Experimental Evaluation of Concrete Cross Tie and Fastener Loads", Report No. FRA/OR&D-77/75 prepared for U.S. Department of Transportation by Battelle-Columbus Laboratories and Bechtel, Inc., December 1977.
- [5-5] "Concrete Tie Technical Provisions", Northeast Corridor Project, Federal Railroad Administration, U.S. Department of Transportation, Revision 4, November 8, 1977.
- [5-6] Meacham, H., and Prause, R., "Studies for Rail Vehicle Track Structures" Report No. FRA-RT-71-45 prepared by Battelle Memorial Institute for the U.S. Department of Transportation, April 1970.
- [5-7] Prause, R., and Harrison, H., "Data Analysis and Instrumentation Requirements for Evaluating Rail Joints and Rail Fasteners in Urban Track", Report No. UMTA-MA-06-0025-75-8, prepared by Battelle's Columbus Laboratories for the U.S. Department of Transportation, February 1975.
- [5-8] Lipson, C., and Sheth, N., Statistical Design and Analysis of Engineering Experiments, McGraw Hill Book Company, New York, 1973, pp 311-344.
- [5-9] "Newsletter 77-Track Development Projects", Report No. R 204/13 prepared by Chief Civil Engineers Office, South African Railways, Johannesburg, October 1977.

## Section 6.0

- [6-1] Prause, R. and Kennedy, J., "Parametric Study of Track Response", Report No. FRA/OR&D-77/75, prepared by Battelle's Columbus Laboratories for the U.S. Department of Transportation, December 1977.
- [6-2] Heebink, B., Superfesky, M., Geimer, R., and Chem., J., "Recycling the Wood Crosstie: Researchers Develop and Test Laminated Particle Tie:", Railway Track and Structures, Chicago, Illinois, July 1977, pp. 26-30.

- [6-3] Griffin, F., "Laboratory Evaluation of Particle Wood Crossties Submitted by Forest Products Laboratory", Association of American Railroads Report No. LT-408, February 1976.
- [6-4] Griffin, F., "Laboratory Evaluation of Particle Wood Crossties Submitted by Forest Products Laboratory", Association of American Railroads Report No. LT-409, February 1977.
- [6-5] Knoblock, O., "A Comparative Study of Physical Properties of Various Types of Wood Used in Railroad Crossties", Association of American Railroads Report No. R-255, December 1976.
- [6-6] Proceedings of Seminar on Steel Rail Sleepers, Sponsored by Broken Hill Proprietary Company, Australia, March 1977.



APPENDIX A

PHOTOGRAPHS OF TYPICAL TIE FAILURE MODES  
AND BALLAST CONDITIONS

## TIE FAILURE MODES



Photo #1 - Rail Seat Crack - completely through tie showing typical "Y" configuration (outlined in black) (1)\*

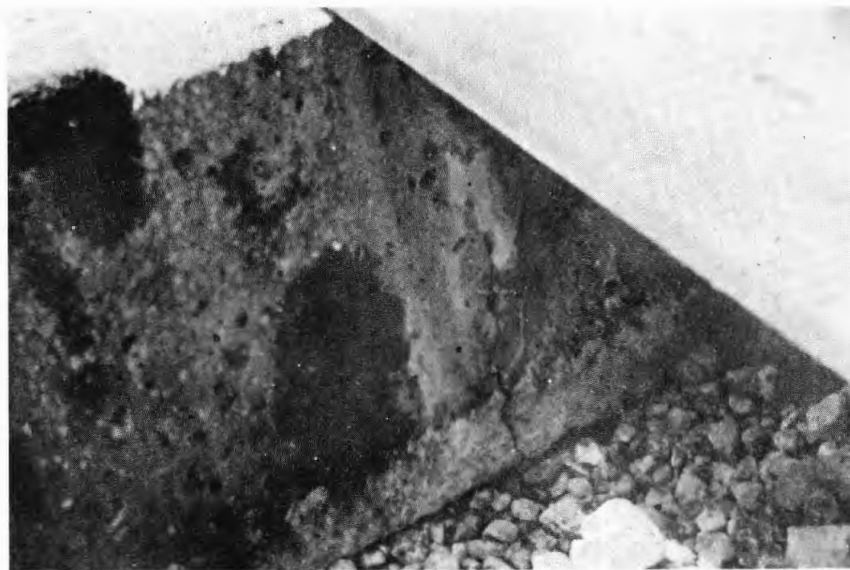

Photo#2 - Rail Seat Crack - partially through tie (1)

\* Number in parenthesis indicates photo source.



TIE FAILURE MODES (Continued)



Photo #3 - Rail Seat Crack - also showing bolt failures, tie pad deterioration and fines from ballast degradation. Tie removed from track during ballast replacement operation (2)



Photo #4 - Rail Seat Crack - through rail fastener bearing surface (1)

TIE FAILURE MODES (Continued)

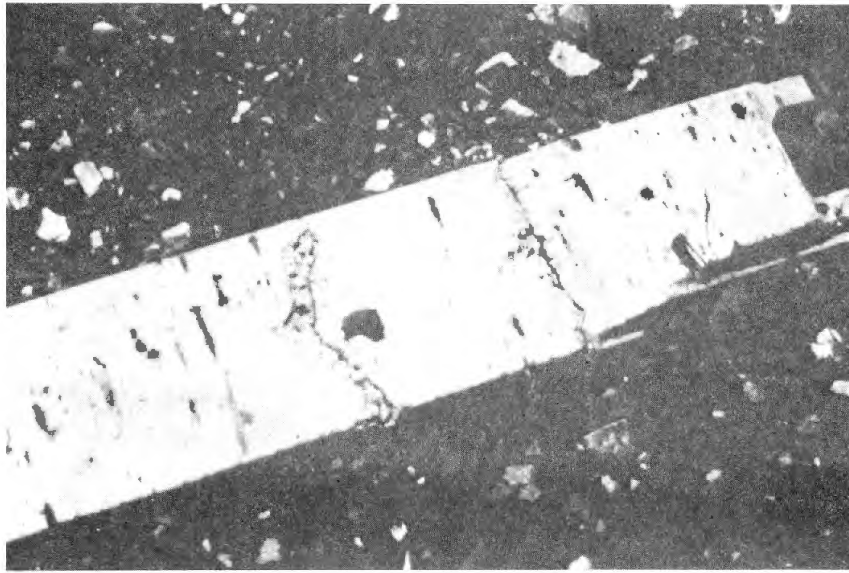

Photo #5 - Tie Center Cracks - apparently due to center binding. Ballast is reported as volcanic cinders. (1)

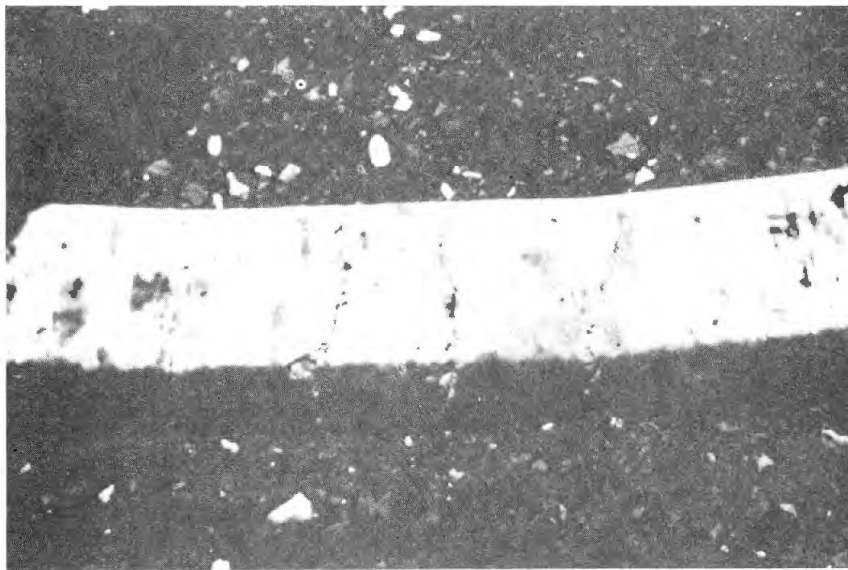

Photo #6 - Tie Center Cracks due to bending - volcanic cinder ballast (1)

## TIE FAILURE MODES (Continued)

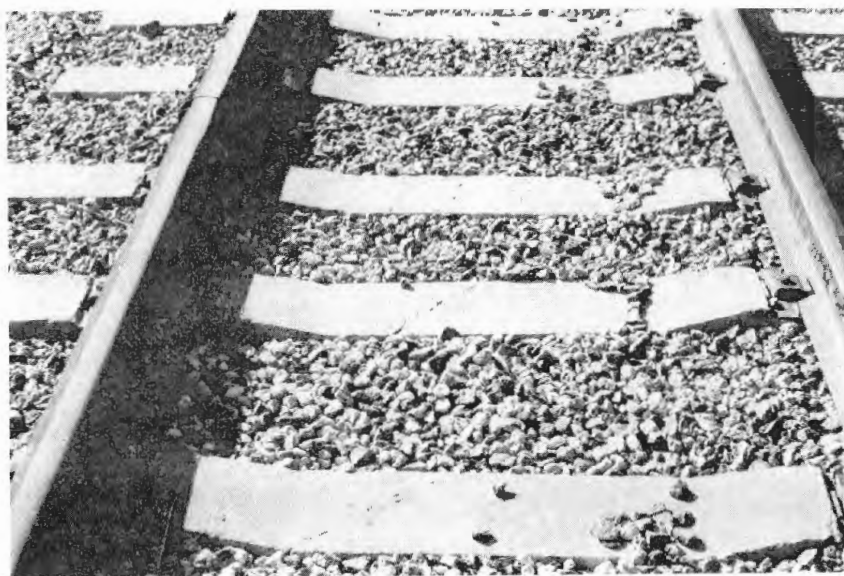

Photo #7 - Tie Center Cracks - two ties in foreground show torsional cracks, third tie shows bending cracks (2)

## FASTENER FAILURE MODES

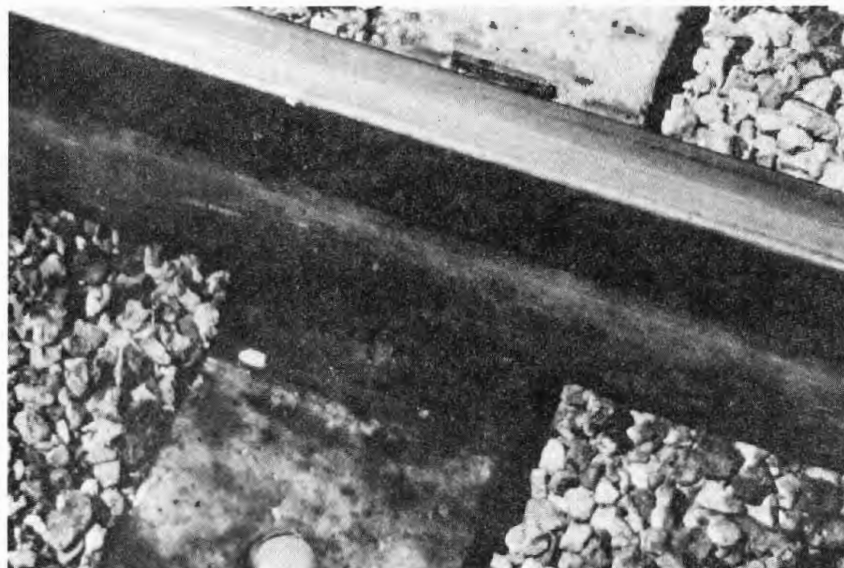

Photo #8 - Bolt Failure - showing some rail pad distortion (1)

FASTENER FAILURE MODES (Continued)

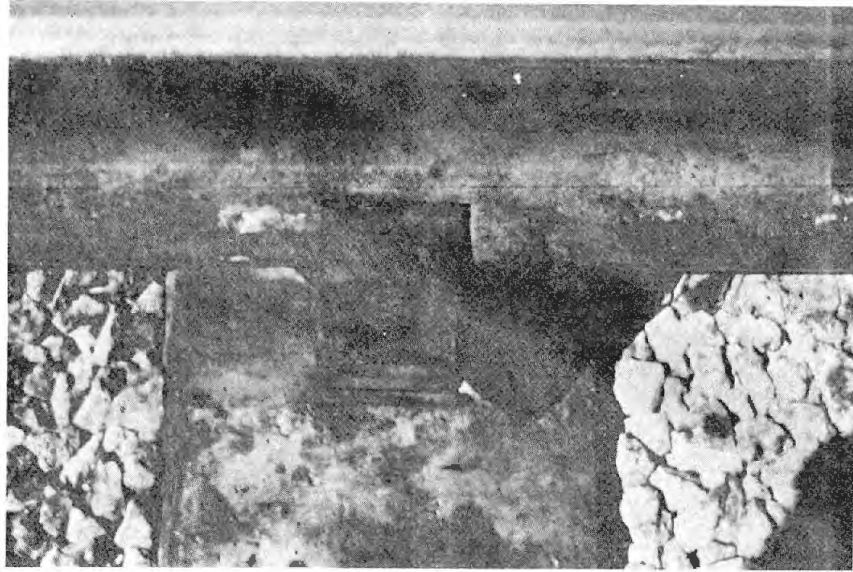

Photo #9 - Rail Seat Pad Displacement (1)

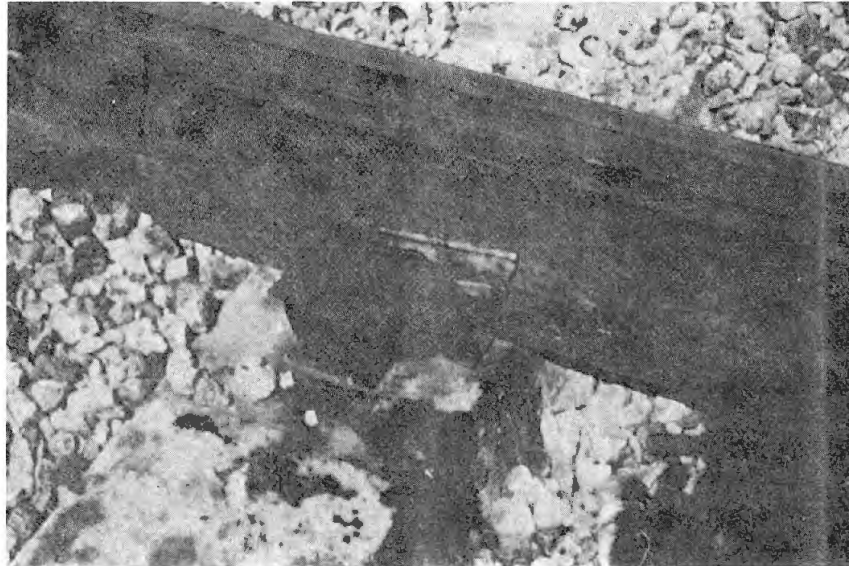

Photo #10 - Insulator Displacement (1)

BALLAST CONDITIONS OBSERVED AT VARIOUS CONCRETE  
TIE INSTALLATIONS IN THE UNITED STATES

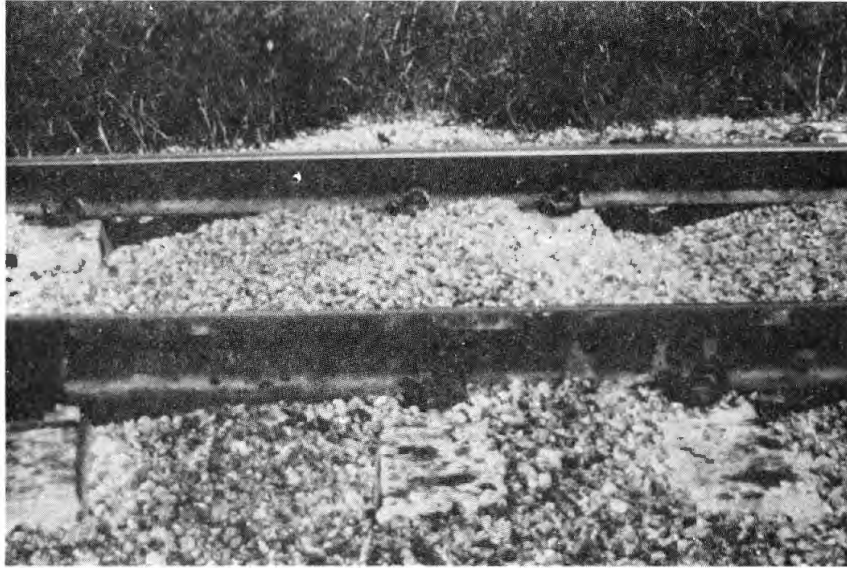

Photo #11 - Displacement of Ties - apparently due to longitudinal movement of rails and insufficient restraint of ballast and fasteners. Fastener was a lighter version of that currently used in the United States.(1)

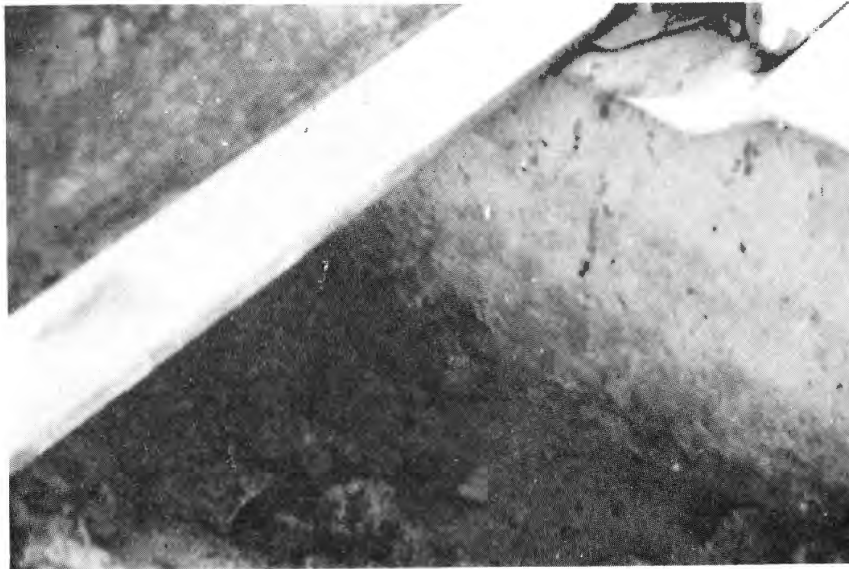

Photo #12 - Infiltration of fines into ballast causing variation in tie support from that provided by "clean" ballast (1)



BALLAST CONDITIONS (Continued)

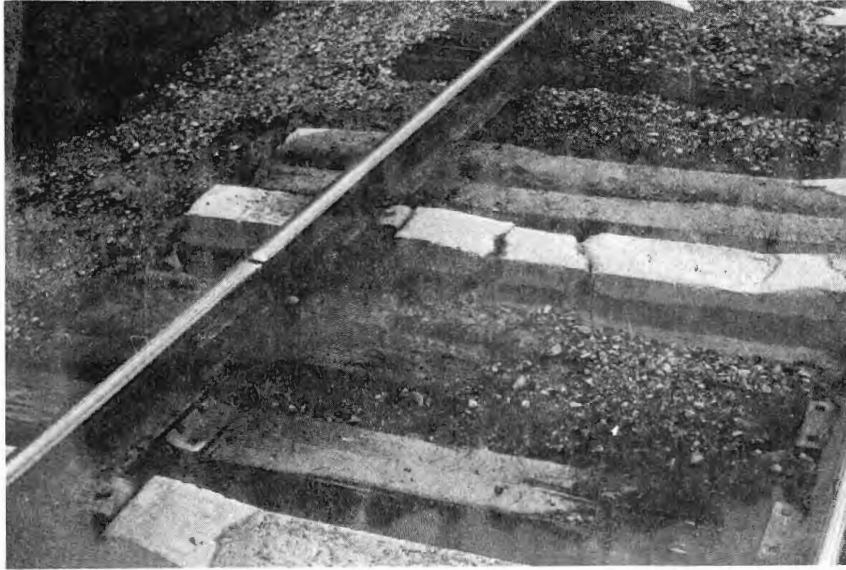

Photo #13 - Spot replacement of wood ties with concrete ties causing degradation of "soft" ballast and resulting in pumping. Ties cracked due to loss of support (2)

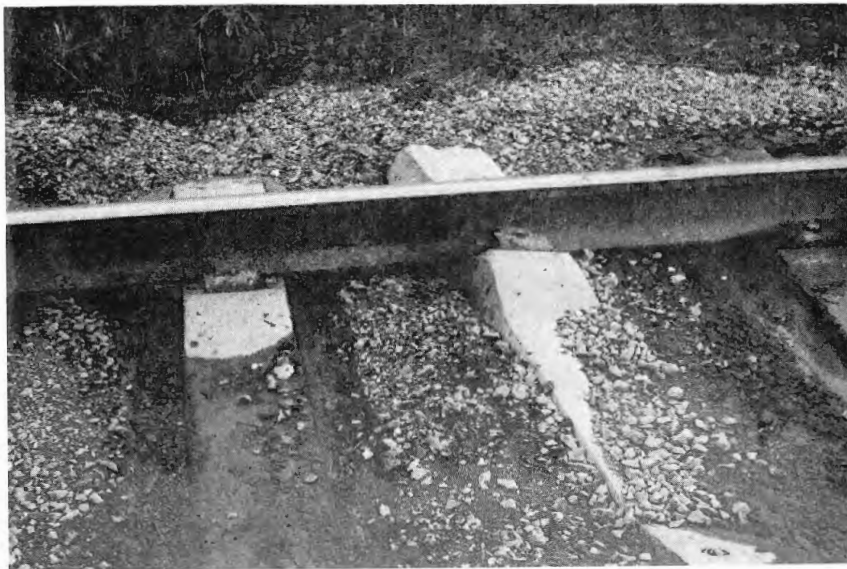

Photo #14 - Deterioration of ballast around alternate ties installed on first pass of tie renewal operation. Center tie installed on second pass forced to carry excessive load and cracked. (2)

BALLAST CONDITIONS (Continued)



Photos #15 thru #19 show process of ballast deterioration in the same section of track.

Photo #15 - Typical shape and size of ballast as installed in track. (2)



Photo #16 - Tie shifted by tie spacing machine to show well tamped ballast under rail seat. No deterioration. (2)

BALLAST CONDITIONS (Continued)



Photo #17 - Tie shifted by tie spacer showing beginning of ballast deterioration under rail seat. Note fines in ballast surface not present in previous photo. (2)



Photo #18 - Tie shifted by tie spacer. Note large amount of fines being generated under tie. (2)



BALLAST CONDITIONS (Continued)

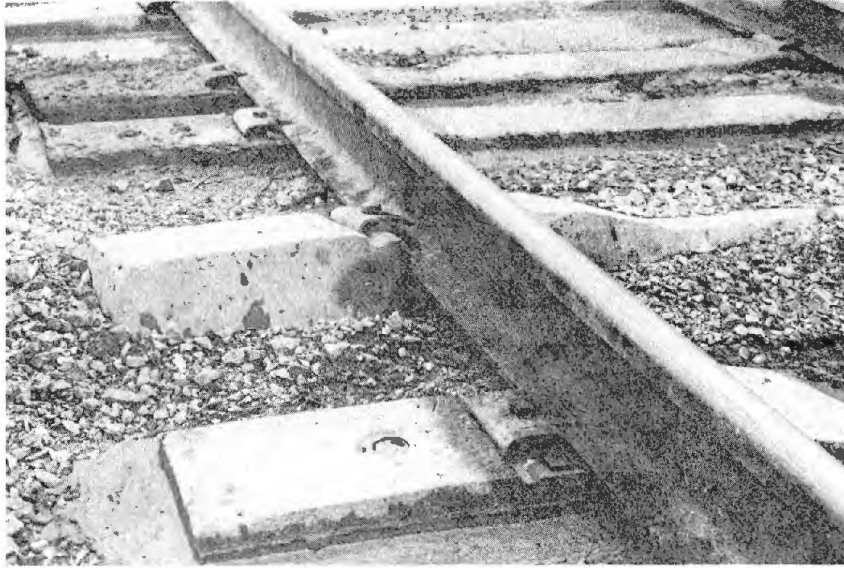

Photo #19 - Fines generated by ballast degradation foul ballast initiating pumping and loss of tie support. (2)

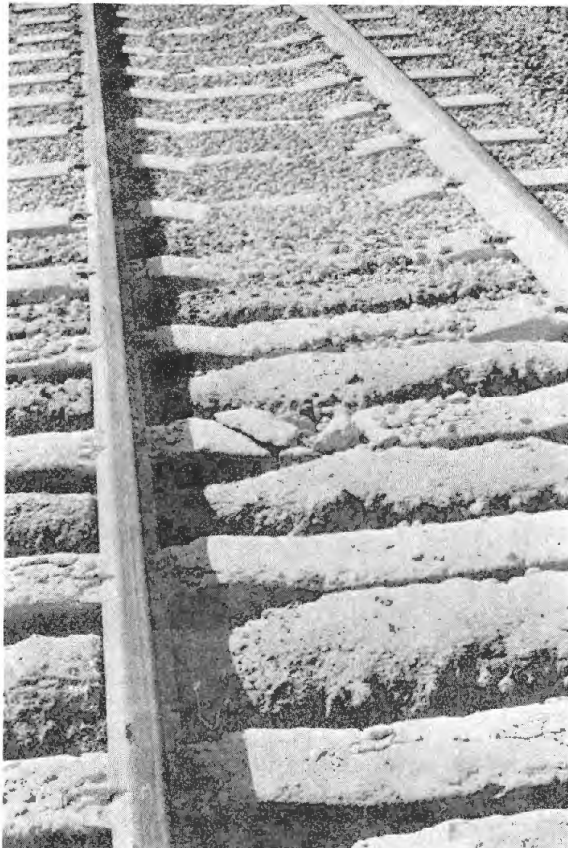

Photo #20 - Advanced state of ballast degradation as seen in another track. (2)

BALLAST CONDITIONS (Continued)



Photo #21 - Replacement of soft and degraded ballast on one U.S. railroad. (2)

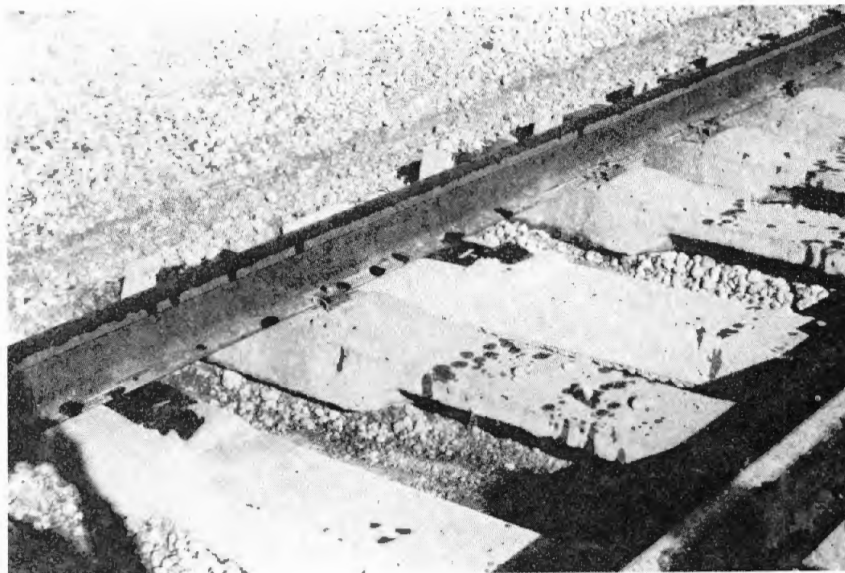

Photo #22 - Some early ties had a wedge shaped center section in an attempt to reduce or avoid center binding. Wedge section ties were more susceptible to torsional failures and are replaced with ties having a trapezoidal center section. (2)



Photo #23.- Migration of Subgrade Fines Into Ballast,  
Concrete-Tie Subsection E (3)

- (1) - Photo from FRA, OR&D files.
- (2) - Photo by R. C. Arnlund.
- (3) - Photo by Transportation Test Center.

## APPENDIX B

### CONCRETE TIE STRESS ANALYSIS

One of the most recent concrete tie configurations was used to demonstrate a typical tie stress analysis. This tie meets current AREA specifications and several instrumented ties are installed in FAST. Available data from load calibrations by the Waterways Experiment Station (WES) and from stress analyses by MITRE were used for comparison with the analysis results reported herein. This analysis includes a detailed finite element model to predict stress distributions due to bending and local loading in the rail seat region. A separate section discusses stresses from torsional loads.

#### Tie Stresses From Bending

The concrete tie was modeled as a two-dimensional structure of variable width. One half of the tie was considered, with the center-line boundary conditions being those stipulated by symmetry. The finite-element model contained 94 eight-node isoparametric elements and 337 nodes, which resulted in 666 degrees of freedom. The geometry of the finite-element model is shown in Figure B-1.

As a check on the model, the first load case which was analyzed was the one shown in Figure B-2, which had been examined previously by MITRE to check WES calibration data. The two Battelle curves represent the use of two different sets of elastic material constants. The set with the lower elastic modulus is that which was measured by WES. The other set is that which was used by MITRE in their finite element calculations.

In addition to this check case (load case 1), five other load cases were examined. Load case 2 was similar to load case 1, except that the load was applied three inches on either side of the rail seat centerline instead of nine inches. This simulates the loading required by current AREA specifications. The remaining four load cases consisted of a uniform pressure on the rail seat with various pressure distributions on the base of the tie corresponding to different tie and ballast interactions. Load case 3 was a typical

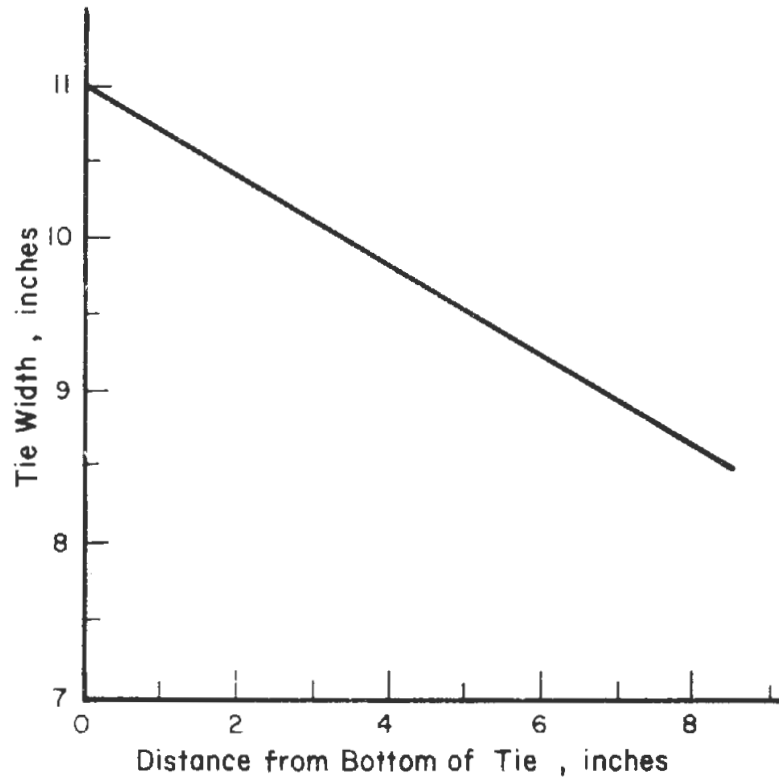
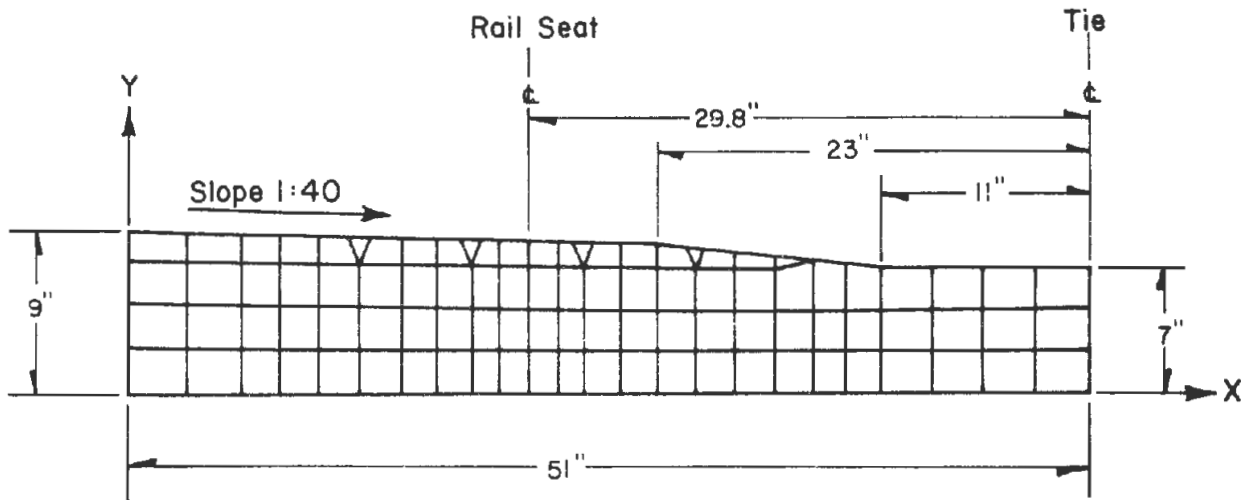

FIGURE B-1. VARIABLE WIDTH PLANE STRESS MODEL OF CONCRETE TIE

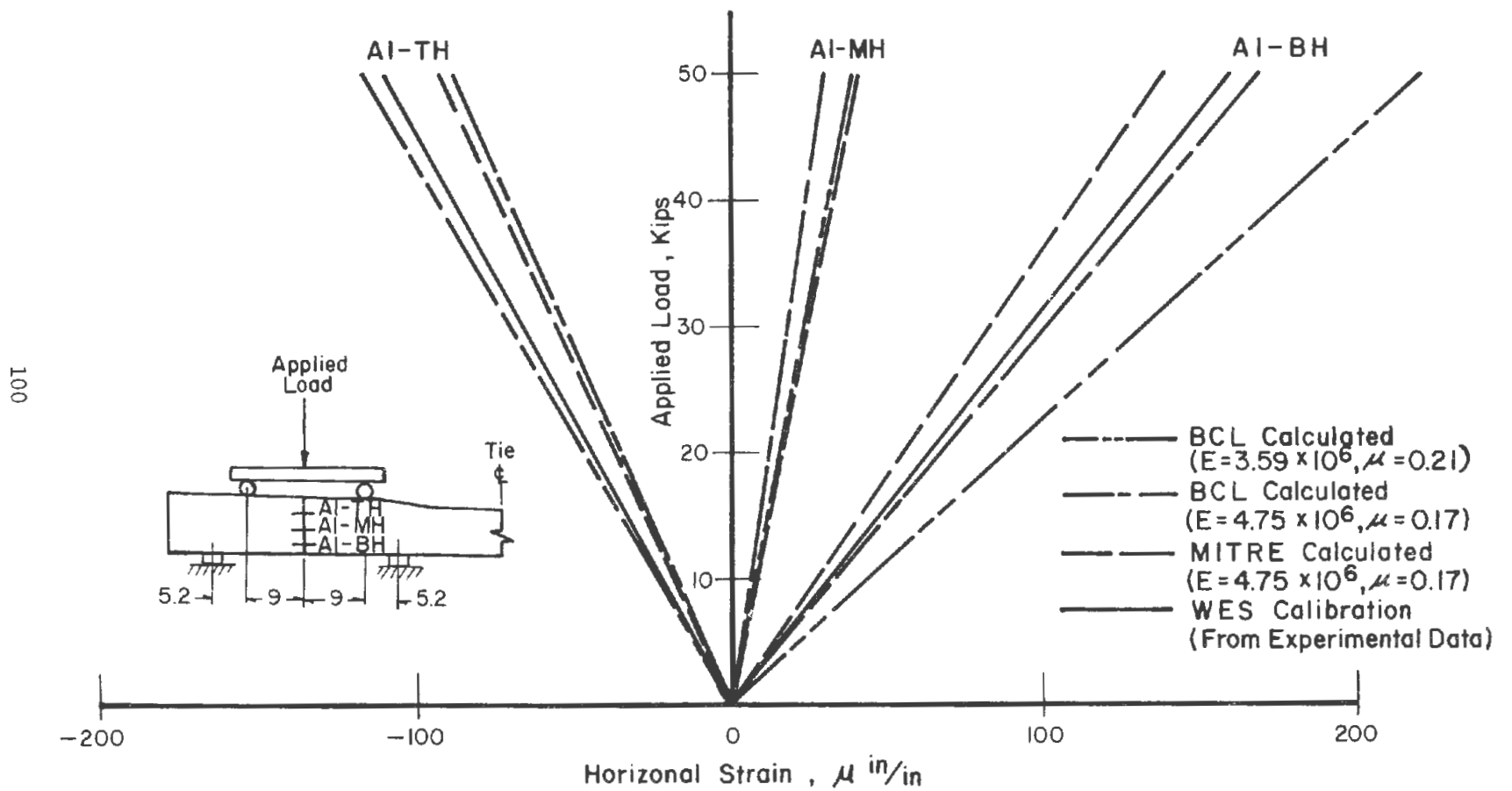

FIGURE B-2. SUMMARY OF BCL CALCULATED, MITRE CALCULATED AND WES CALIBRATION CURVE FOR TEST LOAD AND STRAIN GAGE LOCATIONS SHOWN (LOAD CASE 1)

centerbinding pressure distribution based on data measured on the Florida East Coast Railway. The pressure distribution assumed to simulate this condition is shown in Figure B-3.

In the fourth load case the tie and ballast interact to give a classical type of load distribution for a uniform elastic support and a relatively flexible tie. This pressure distribution is shown in Figure B-4.

The fifth load case considered the pressure distribution shown in Figure B-5. This simulates a relatively rigid tie on a uniform elastic support.

The final load case considered that the tie is part end-binding and part center-binding. The assumed load distribution for this load case is shown in Figure B-6.

In order to determine the adequacy of beam theory to predict tie stresses, the bending moments and horizontal strains at the rail seat centerline and tie centerline were examined for all six load cases. The moments at these two sections were determined from the force input to the finite element calculations and are given in Table B-1. Strains were determined for two sets of elastic material properties. For the sake of completeness, the results for both sets are included in Figures B-7 through B-10. The locations of the strain gages on the instrumented ties in FAST are also shown for reference.

The strain distributions at both the rail and tie centerlines were normalized with respect to the calculated bending moment at that section. These normalized curves are shown in Figure B-7 and B-8, for the rail centerline and tie centerline, respectively. Also included on these figures are curves calculated from the rectangular beam formula,

$$\epsilon = \frac{MZ}{IE} \quad (B-1)$$

or

$$\frac{\epsilon}{M} = \frac{12Z}{bh^3 E} \quad (B-2)$$

where M = bending moment

Z = distance from neutral axis to reference location

I = section moment of inertia

E = Young's modulus

b = beam width

h = beam depth.

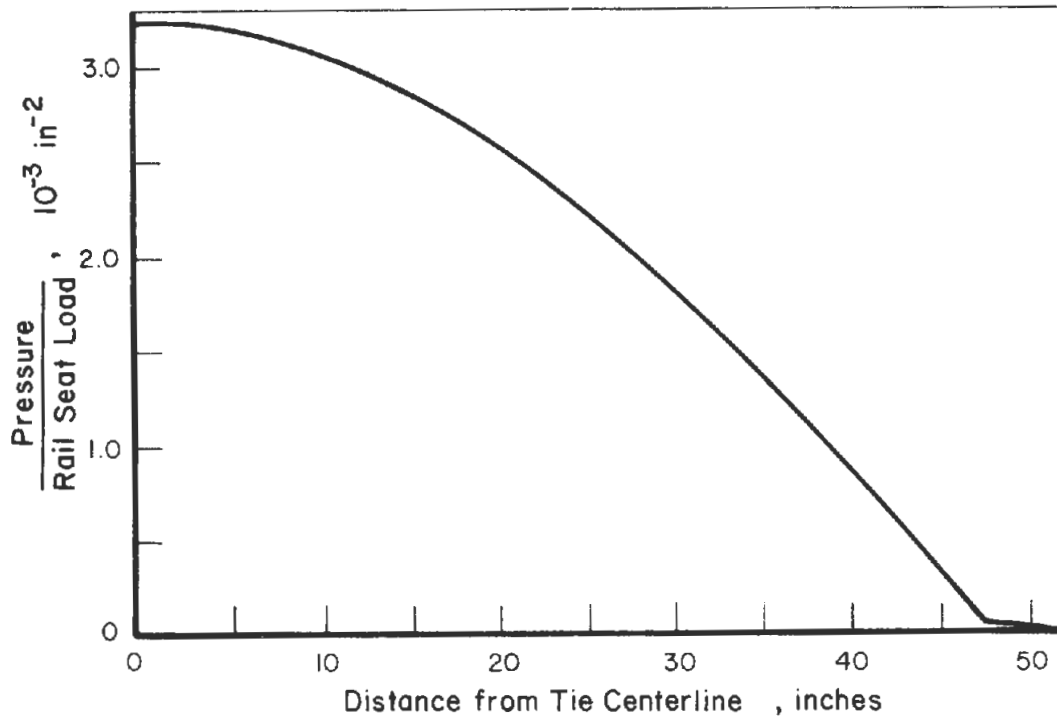

FIGURE B-3. PRESSURE DISTRIBUTION ON TIE BASE FOR CENTER BINDING LOAD CASE (LOAD CASE 3)

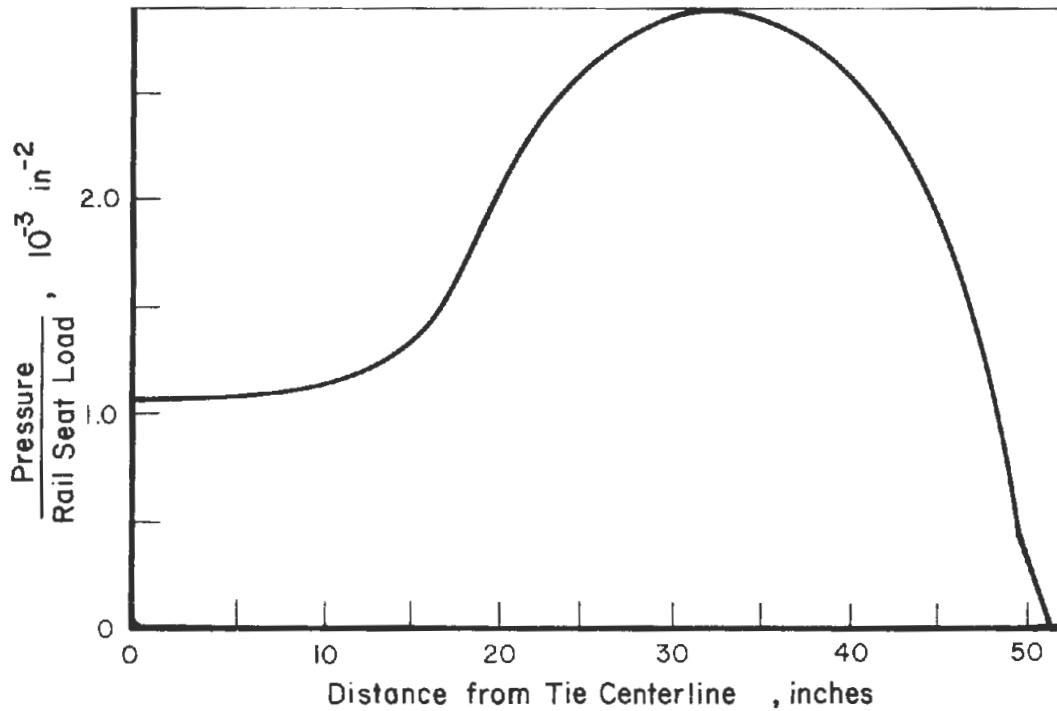

FIGURE B-4. PRESSURE DISTRIBUTION ON TIE BASE FOR CLASSICAL LOAD CASE (LOAD CASE 4)



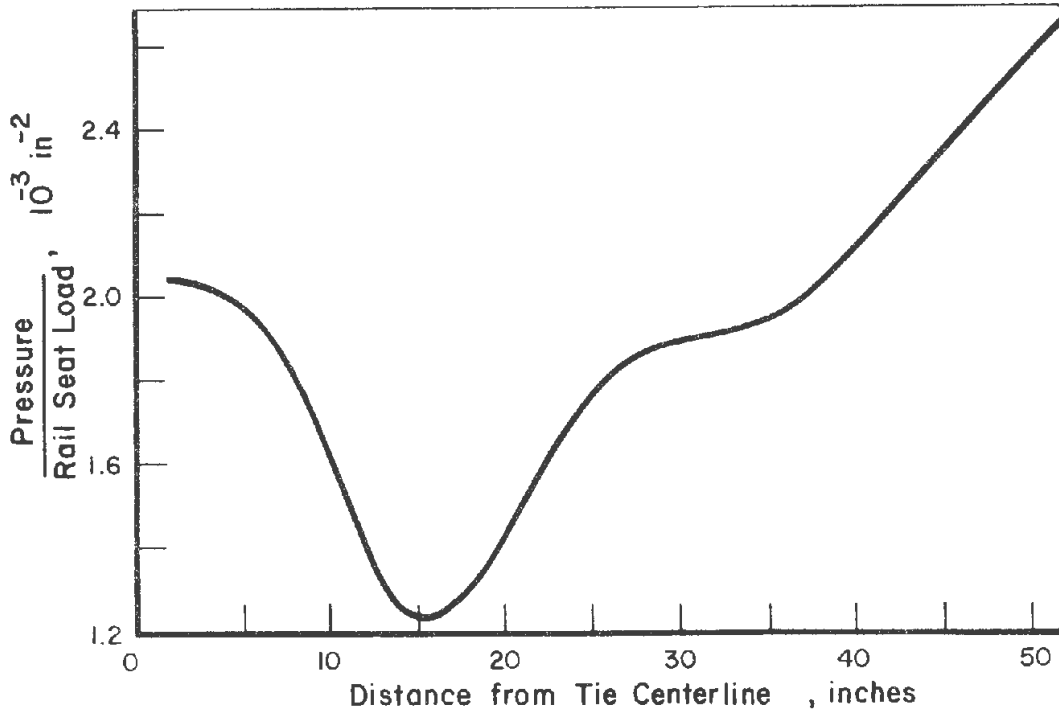

FIGURE B-5. PRESSURE DISTRIBUTION ON TIE BASE FOR RIGID TIE LOAD CASE (LOAD CASE 5)

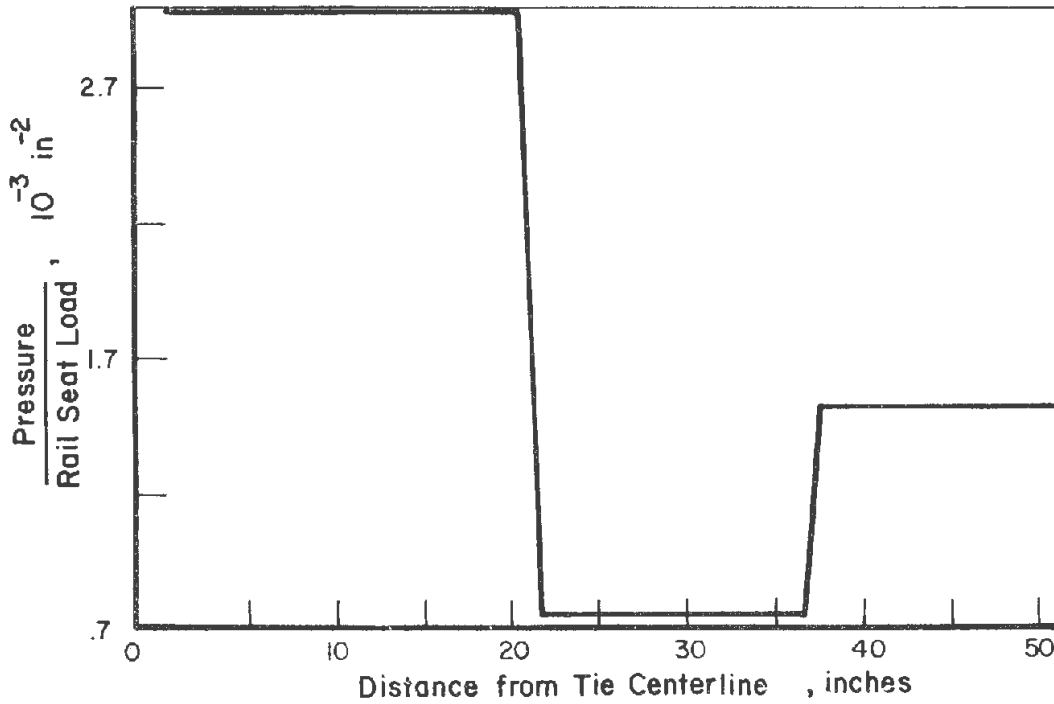

FIGURE B-6. PRESSURE DISTRIBUTION ON TIE BASE FOR PARTIAL CENTER-BINDING AND PARTIAL END-BINDING LOAD CASE (LOAD CASE 6)

TABLE B-1. TIE CENTER AND RAIL-SEAT MOMENTS  
FOR UNIT RAIL-SEAT LOADS

LOAD CASE	1	2	3	4	5	6
TIE CENTER MOMENT $\frac{\text{in-lb}}{\text{lb}}$	0	0	-12.2	-2.0	-2.5	-8.6
RAIL-SEAT MOMENT $\frac{\text{in-lb}}{\text{lb}}$	2.6	5.6	0.5	3.5	4.8	2.7

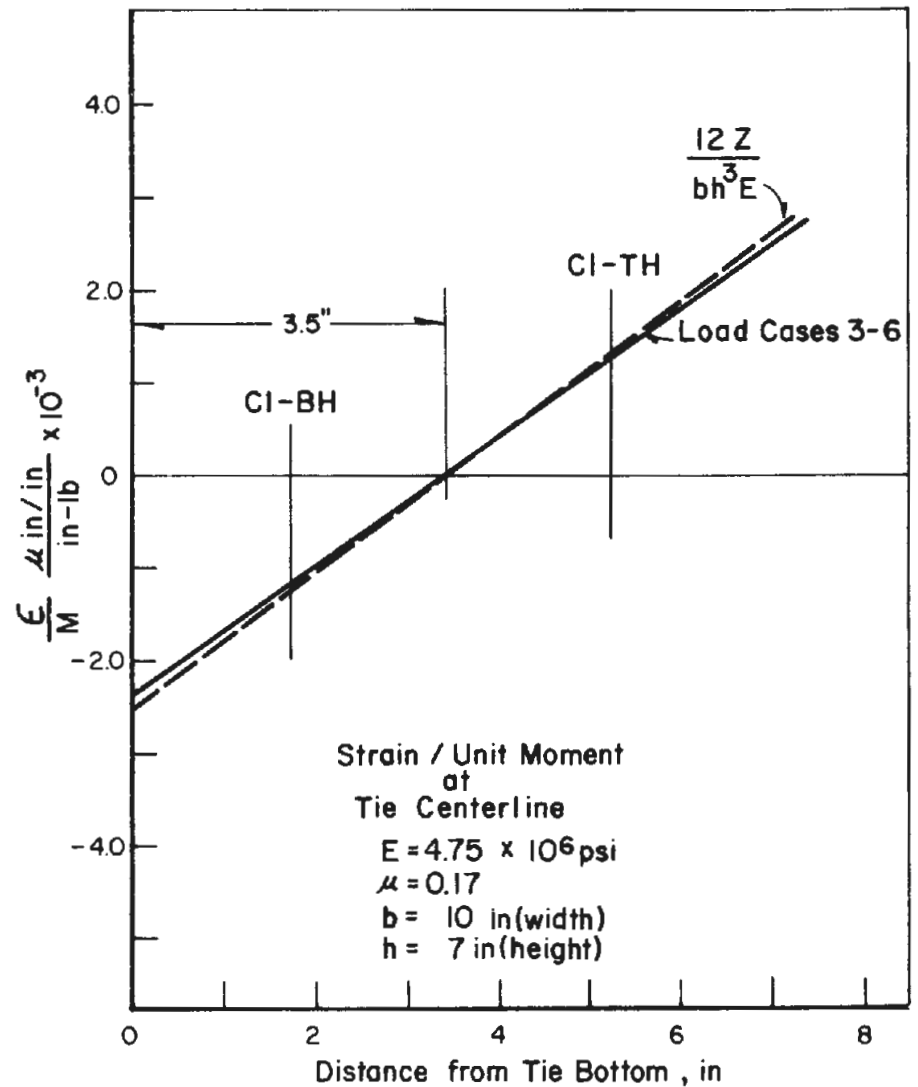
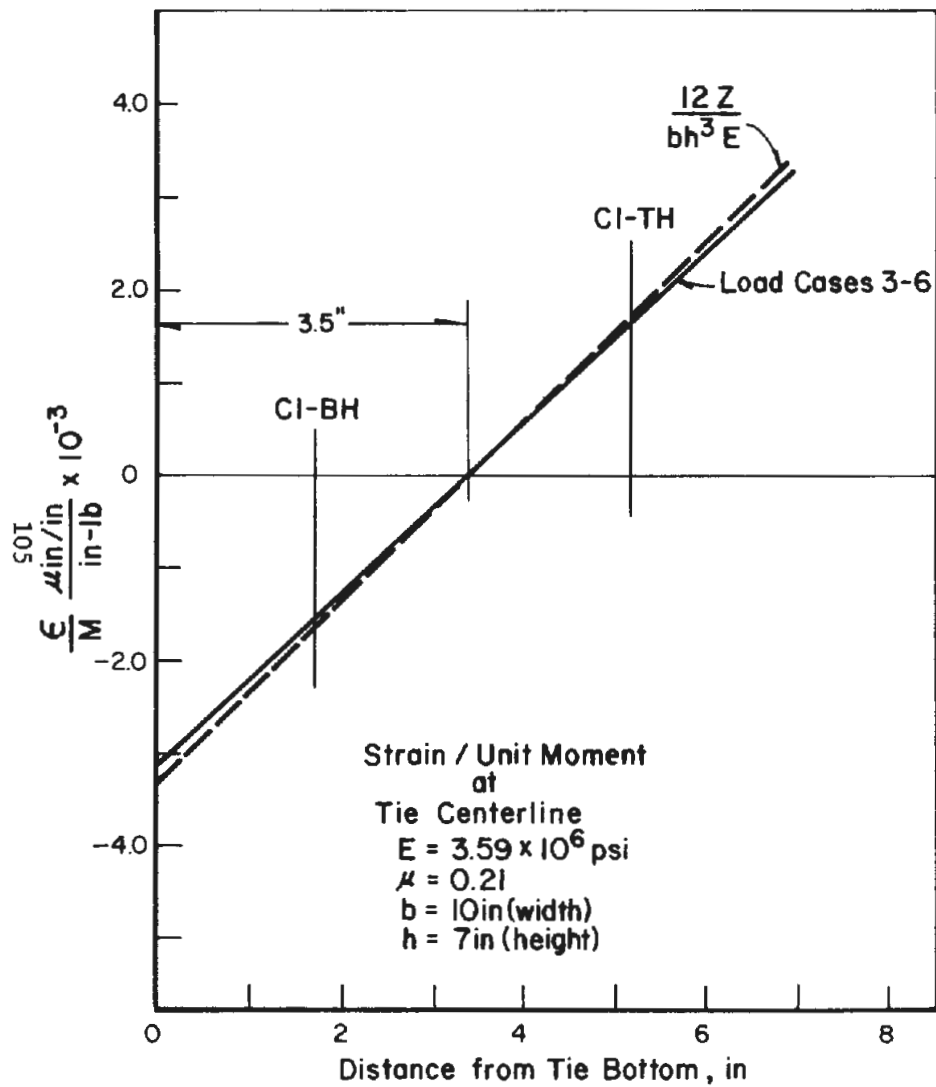

FIGURE B-7. THE EFFECT OF LOAD CONFIGURATION ON HORIZONTAL STRAINS AT THE TIE CENTERLINE

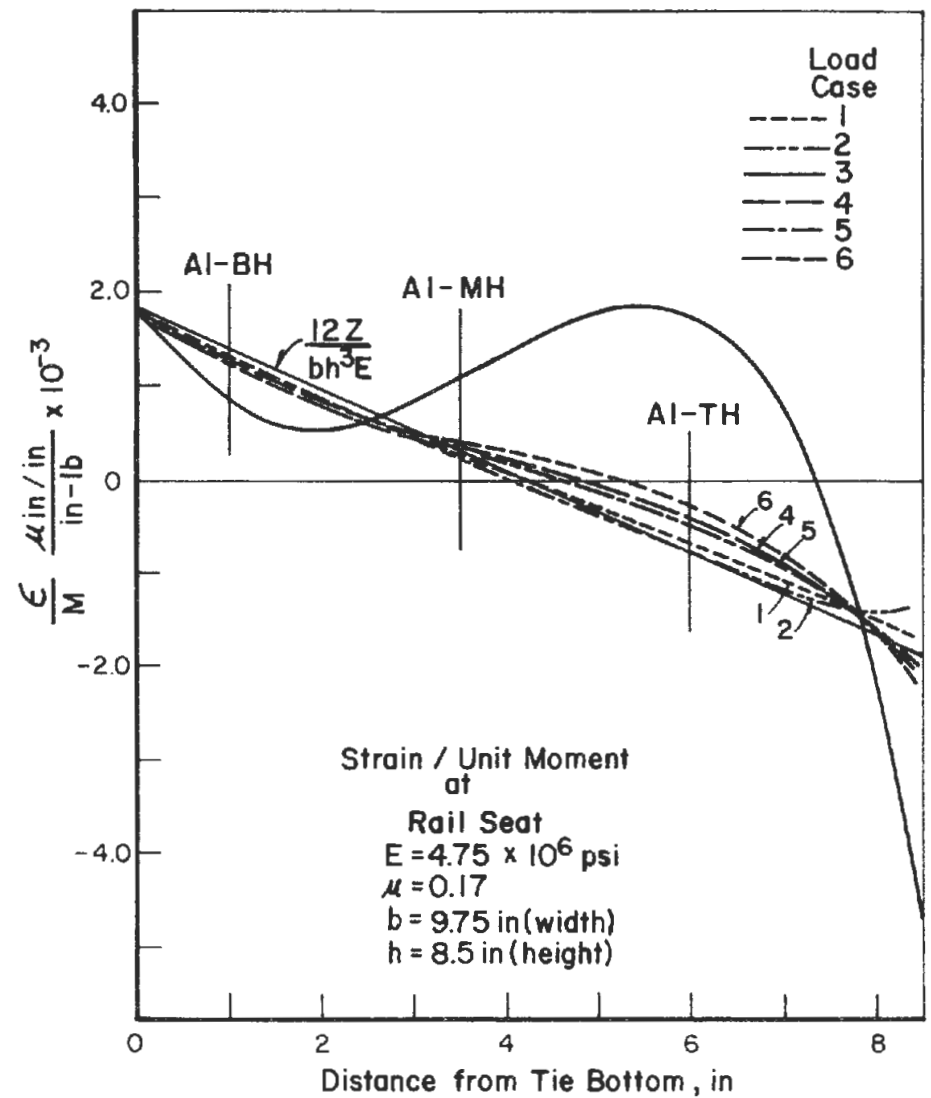
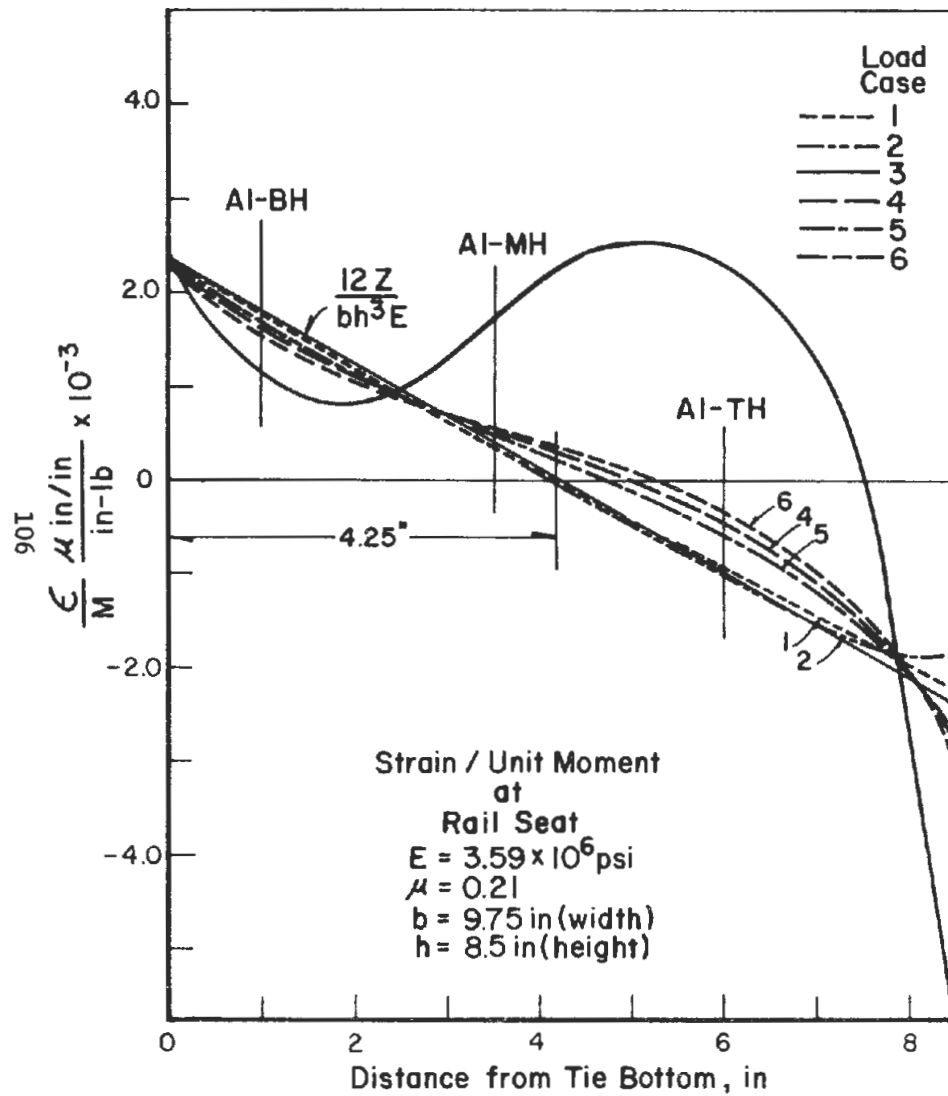

FIGURE B-8. THE EFFECT OF LOAD CONFIGURATION ON HORIZONTAL STRAINS AT TIE RAIL SEAT

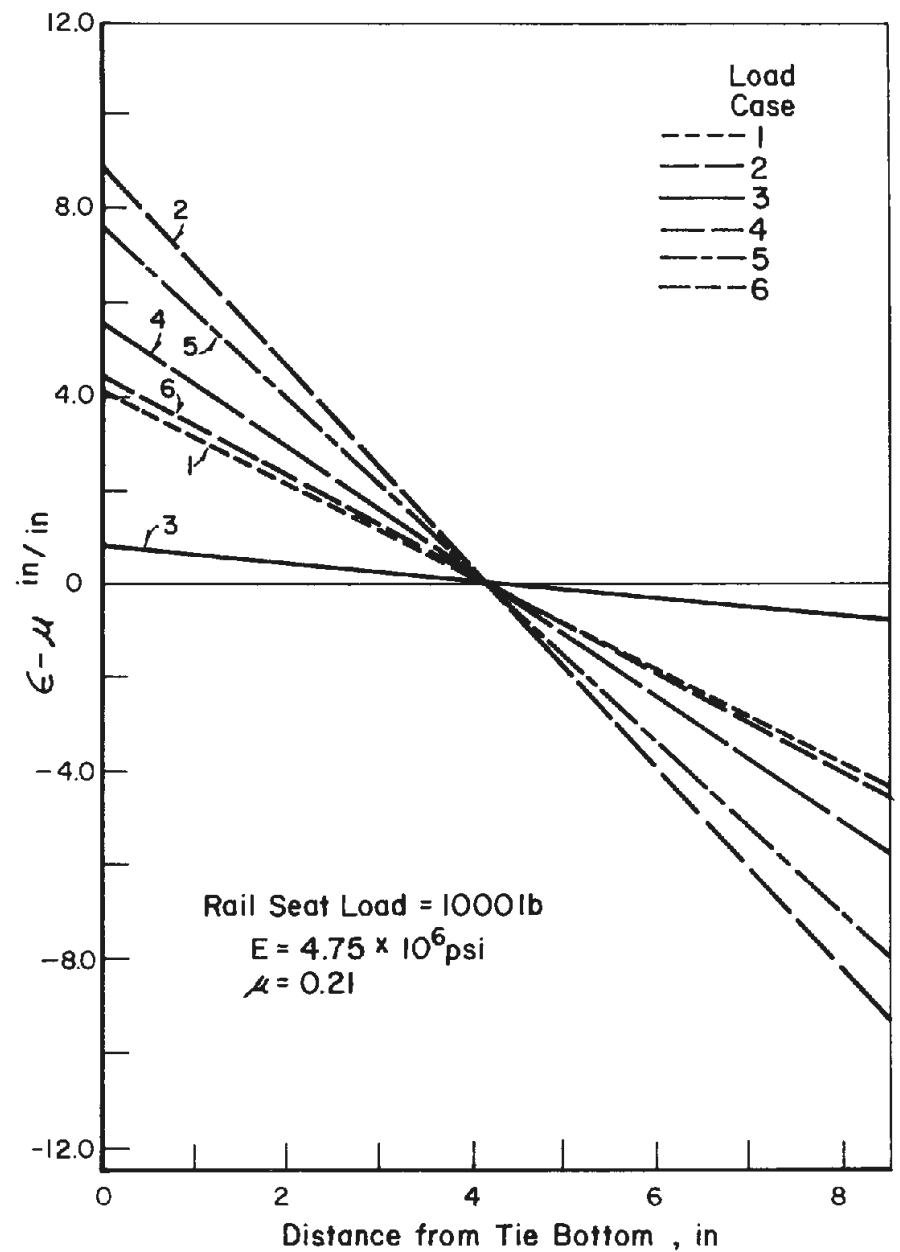
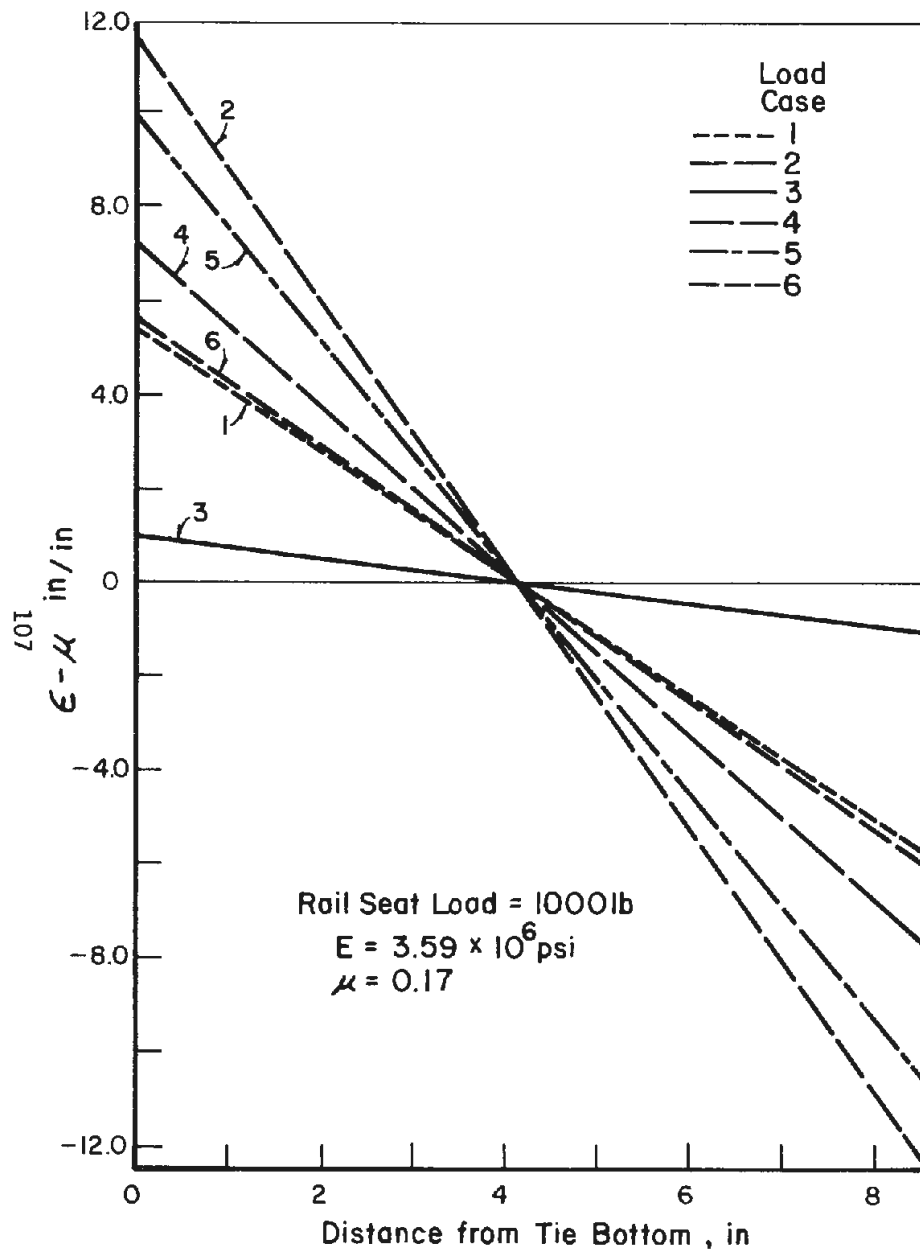

FIGURE B-9. ESTIMATED BENDING STRAINS AT RAIL SEAT BASED ON LOAD CASE 5 STRAIN DISTRIBUTION

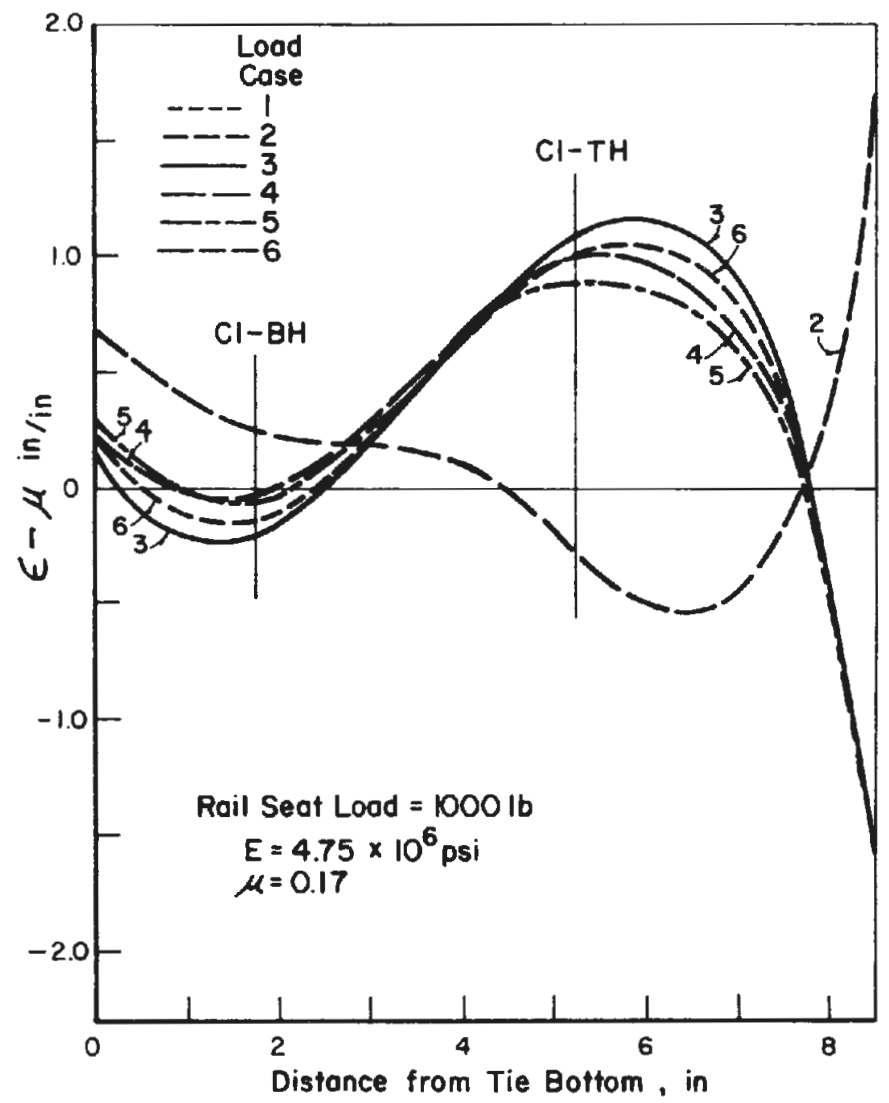
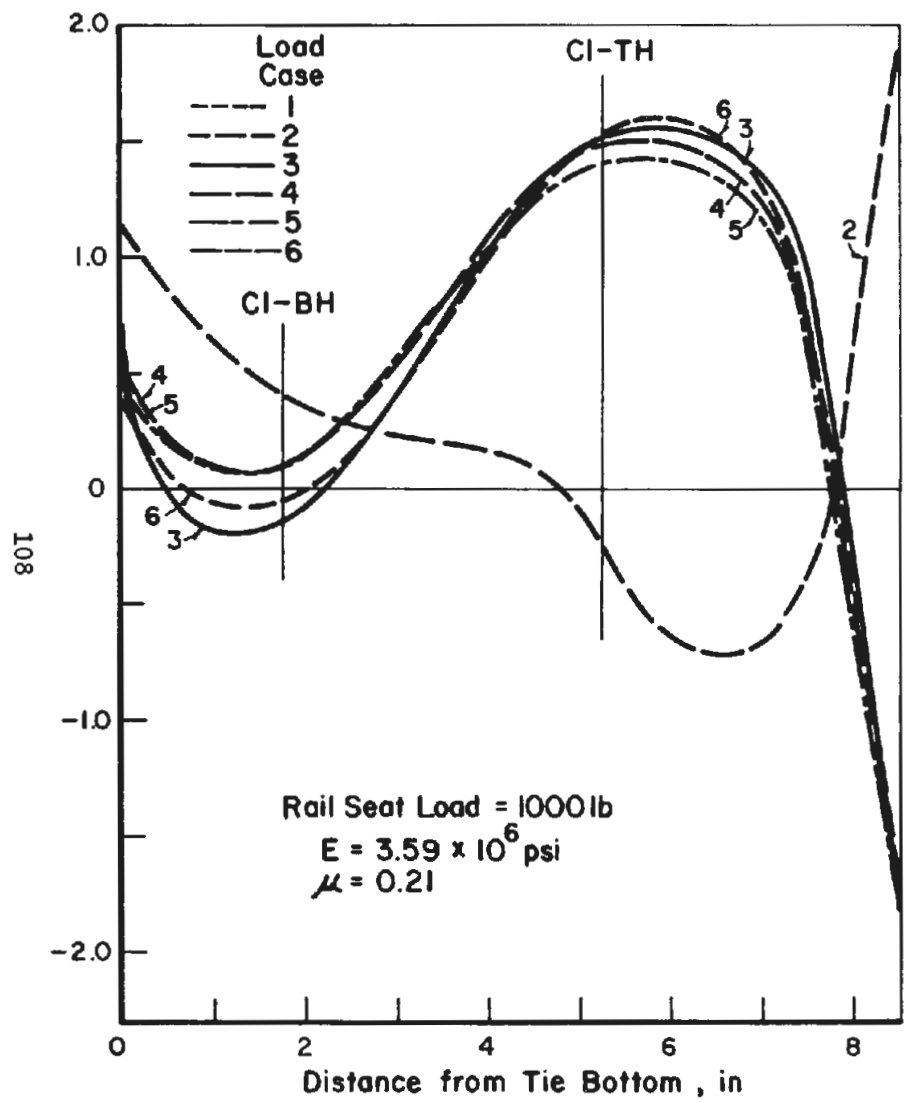

FIGURE B-10. HORIZONTAL STRAIN REMAINING AT RAIL SEAT AFTER  
 SUBTRACTING ESTIMATED BENDING STRAINS

The average tie section width was used in applying this formula.

As can be seen in Figure B-7, the strains vary linearly across the tie center section for all the load cases which resulted in moments at the tie center. The neutral axis occurred at mid height and agreement with rectangular beam theory is within 6 percent. For the rail centerline data shown in Figure B-8, it can be seen, however, that there are significant variations from the linear strain distribution.

The curves in Figure B-8 for load cases 3 through 6 can be seen to vary from the linear curve in a similar manner, with the magnitude of the variation being the distinguishing feature. Furthermore, it can be seen by referring to Table 1 that the magnitude of this variation is directly related to the rail seat centerline bending moment. The load case with the smallest bending moment (load case 3) differs the most, and the load case with the largest bending moment (load case 5) differs the least. Since the strains in Figure B-8 are normalized with respect to bending moment, this type of behavior indicates that a mode of loading other than bending predominates when the bending moments become small.

In order to determine the form of this nonbending type of loading, the rail seat centerline strains were plotted with the linear bending strains shown in Figure B-9 subtracted. These strain distributions with the bending component deleted, are shown in Figure B-10. The distributions for load cases 3 through 6 can be seen to be nearly identical. Because of this, and because these four load cases had exactly the same load applied to the rail seat, it is believed that these strains are due to the rail seat contact stress field.

The curves in Figure B-8 for load cases 1 and 2 can be seen to differ from the linear curve in the opposite sense from load cases 3 through 6. Furthermore, the curve for load case 2 can be seen to differ substantially more from the linear distribution than the curve for load case 1. This difference is attributed to the remoteness of the load application to the rail seat for load case 1. For load case 2, the loading on the top surface of the tie was applied on both sides and adjacent to the rail seat. As before, the bending component of strain was subtracted from load case 2. The resultant strain distribution is shown in Figure B-10. As can be seen, the remaining strain

distribution for load case 2 is significantly different from those for load cases 3 through 6. Therefore, the contact stress field is very sensitive to the manner in which the rail seat load is distributed on the tie.

The strain distribution at the rail seat centerline for load case 1 can be seen to be nearly linear in Figure B-8. Because of this, the bending components of strain (shown in Figure B-9) for all the load cases were based on the strains for load case 1. This linear behavior in load case 1 would have resulted in no strains being left after the bending strains were subtracted, and therefore, no curve for load case 1 was included in Figure B-10.

### Discussion of Results

If the loading which was used for this planar representation of the concrete tie was entirely in terms of surface pressures, planar elasticity theory indicates that the tie stresses should be independent of the elastic material properties. Although the use of symmetry boundary conditions at the centerline and variable width elements to represent the side taper of the tie could compromise the validity of this theory, it was found that the stresses calculated using the two sets of material constants differed by less than 3 percent. When these two sets of material properties are used to convert the elastic stresses to elastic strains, the difference becomes significant with the differences being approximately 25 percent.

It was found that significant variations from beam theory could exist at the rail seat centerline for ballast reactions which cause relatively small bending moments at the rail seat section. For the load cases considered in this study, the center-binding load case illustrates this effect most clearly. The reason for this deviation from beam theory is believed to be the contact induced stress distribution resulting from the rail seat loads. Because these contact stresses may be largely dependent on the manner in which the rail seat is loaded, the variation from linear behavior will not always be the same.

The bending strains at the tie centerline were found to be in good agreement with beam theory. This is consistent with the behavior at the rail seat centerline since there are no contact loads in the vicinity of the tie centerline.



When making strain measurements in the field, the type of ballast reaction is generally unknown. Because of this, and the general method of using at most three strain gages across the section of the tie, it will be difficult to determine very accurate bending moments at any section which is within 6 to 8 inches of the rail seat. Strain variations from the different loading cases cause less error at the bottom gage location used for FAST than at the other gage locations. It appears that this gage location may be the most reliable for determining bending moments in service.

#### Tie Stresses From Torsion

The deformed shape of a twisted bar, or tie, having a rectangular cross section is shown in Figure B-11. The stress state is characterized by the absence of a normal stress. The shear stress diagram is shown in Figure B-12. The maximum shear stress occurs at the middle of the long side of the rectangle and equals

$$\tau_{\max} = \frac{T}{W}, \quad (\text{B-3})$$

where T is the twisting moment, and

$$W = \alpha hb^2, \quad (\text{B-4})$$

The parameter  $\alpha$  is dependent on h/b and is tabulated in Table B-2 from [B-1].

The stress at the middle of the short side is given by

$$\tau = \lambda \tau_{\max}, \quad (\text{B-5})$$

where  $\alpha$  can be found in the same table.

The stress fields resulting from torsion and prestressing can be determined separately and then they can be combined by superposition within the limits of linear elasticity. This can be done for concrete as long as cracking does not occur. Since cracking is not permitted in prestressed concrete elements subjected to a dynamic load, the use of superposition is justified.

The prestressing results in a longitudinal normal stress which must be superposed with the stress field due to torsion. This is done by

---

B-1 Timoshenko, S., and Goodier, J., "Theory of Elasticity", 2nd Edition, McGraw-Hill Book Company, Inc., New York, N. Y., 1951, p 275-280.

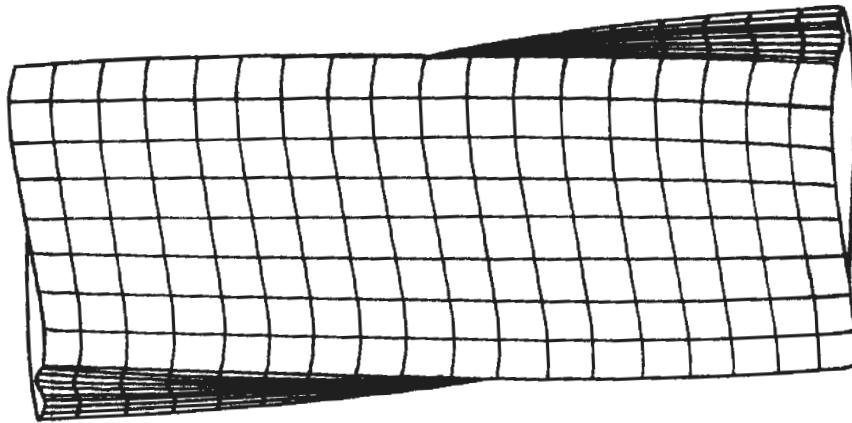

FIGURE B-11. DEFORMED SHAPE OF A TWISTED BAR OF RECTANGULAR CROSS SECTION

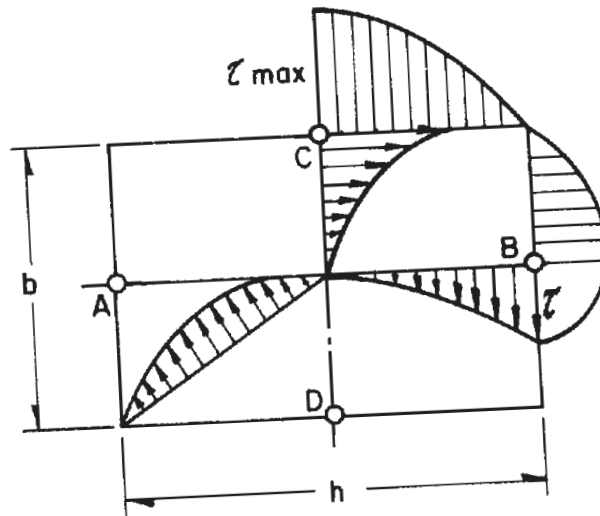

FIGURE B-12. SHEAR STRESS DISTRIBUTION IN A TWISTED BAR OF RECTANGULAR CROSS SECTION

TABLE B-2. TORSIONAL STRESS PARAMETERS FOR RECTANGULAR CROSS SECTION [B-1]

$\frac{h}{b}$	1	1.5	1.75	2.0	2.5	3.0
$\alpha$	0.208	0.231	0.239	0.246	0.256	0.267
$\beta$	0.141	0.196	0.214	0.229	0.249	0.263
$\gamma$	1.000	0.859	0.820	0.795	0.766	0.753

combining both stress distributions and determining the principal stresses which are responsible for the strength of the tie. One of the three principal stresses ( $\sigma_1$ ) is zero, while the remaining two are given by

$$\sigma_{2,3} = \frac{\sigma_o}{2} \pm \sqrt{\frac{\sigma_o^2}{4} + \tau^2} . \quad (B-6)$$

Here  $\sigma_o$  is the normal stress induced by bending and prestressing. The compressive stress from prestressing is negative in sign and probably varies from point to point across a given cross section. The maximum and minimum principal stresses which are of primary interest are likely to occur at the middle of one of the sides of a rectangular tie (depending on both the normal and shear stress at this point).

It follows from the Equation (B-4) that twisting causes one of the principal stresses to necessarily be tension. The tensile stress can be reduced, but it cannot be avoided by any compressive prestressing.

The maximum allowable shear stress from Equation (B-4) is given by

$$\tau_{\max} = \sigma_a \sqrt{1 - \frac{\sigma_o}{\sigma_a}} , \quad (B-7)$$

where  $\sigma_a$  is the allowable tensile design stress. The tensile strength of concrete, with appropriate safety factors, can be used as an allowable stress for design. However, some standards prohibit tension in concrete elements which are subjected to dynamic loads. If this type of standard were applied to railroad ties, it would be necessary to use transverse reinforcement to resist torsional shear stresses in addition to using compressive prestress to resist bending stresses.

The torsional moment also causes a twisting of the tie. The relative angle of twist  $\theta$  per unit length is given by

$$\theta = \frac{T}{GH} , \quad (B-8)$$

and  $G$  is the shear modulus of concrete,

$$J = \beta hb^3 , \quad (B-9)$$

and  $\beta$  is given in Table B-2.

## APPENDIX C

### REPORT OF NEW TECHNOLOGY

This report contains a comprehensive technical evaluation of current tie and fastener specifications. After a diligent review of the work performed under this contract, it is concluded that no inventions, discoveries, or improvements of inventions were made. However, several specific modifications to the tie/fastener specifications and testing procedures were recommended. These recommendations are reported in detail in Section 5 and include the following:

- a. Additional investigation of tie failure mechanisms to justify current strength requirements.
- b. The use of reliability concepts to provide a more realistic evaluation of service performance and design.
- c. The addition of a torsional load requirement for tie design.
- d. An improved fastener test to provide a more realistic simulation of fastener service performance.

A concise summary and evaluation of the history of concrete tie/fastener development is given in Section 3 and future research requirements are summarized in Section 7. A brief review of the development and performance of reconstituted timber ties and steel ties is provided in Section 6.









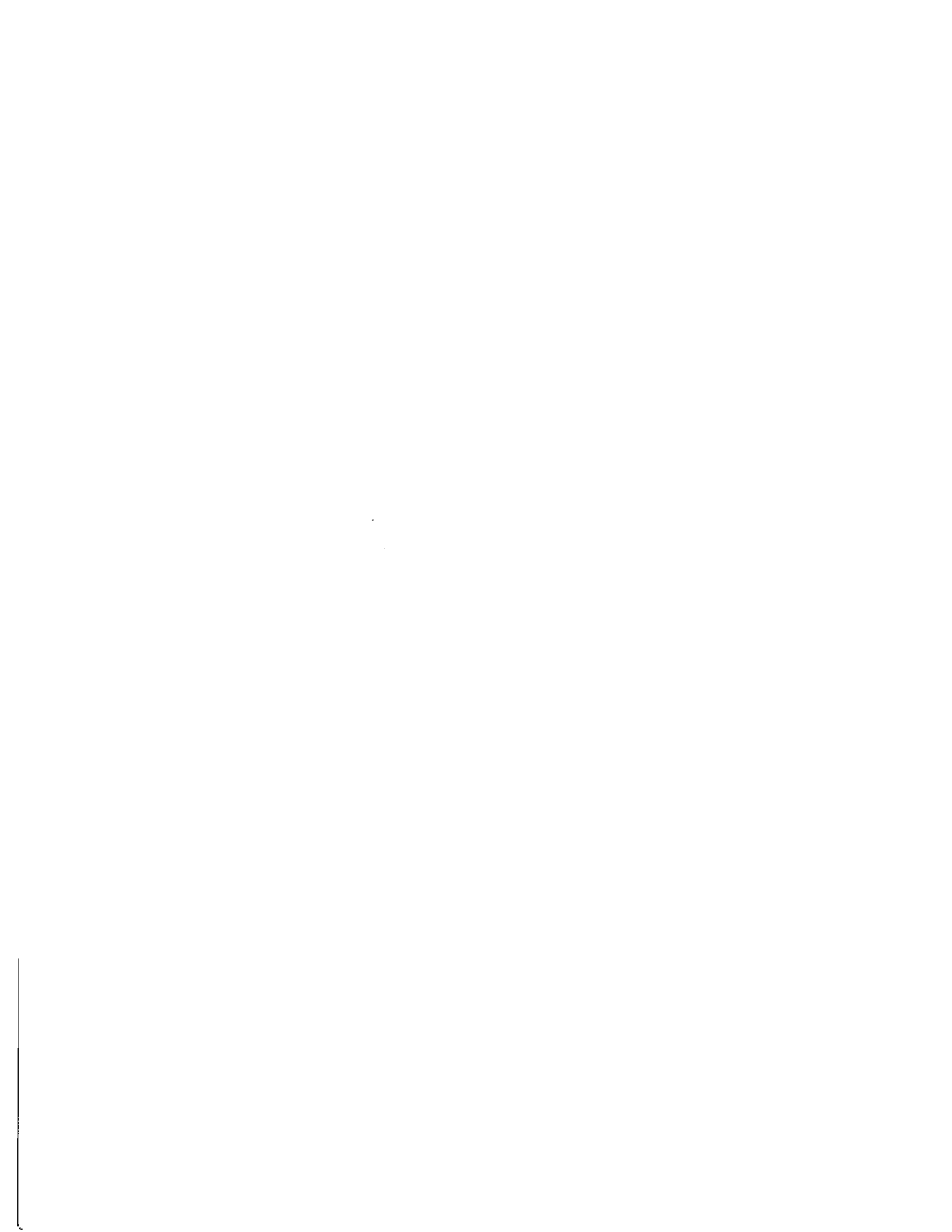

64.

SCIENCE LIBRARY