

THE TROLLEY COACH DEVELOPMENT & STATE OF THE ART

TASK I REPORT
FOR THE
ELECTRIC TROLLEY BUS FEASIBILITY STUDY
DOT-UT-80037
UMTA-IT-06-0193-79-1

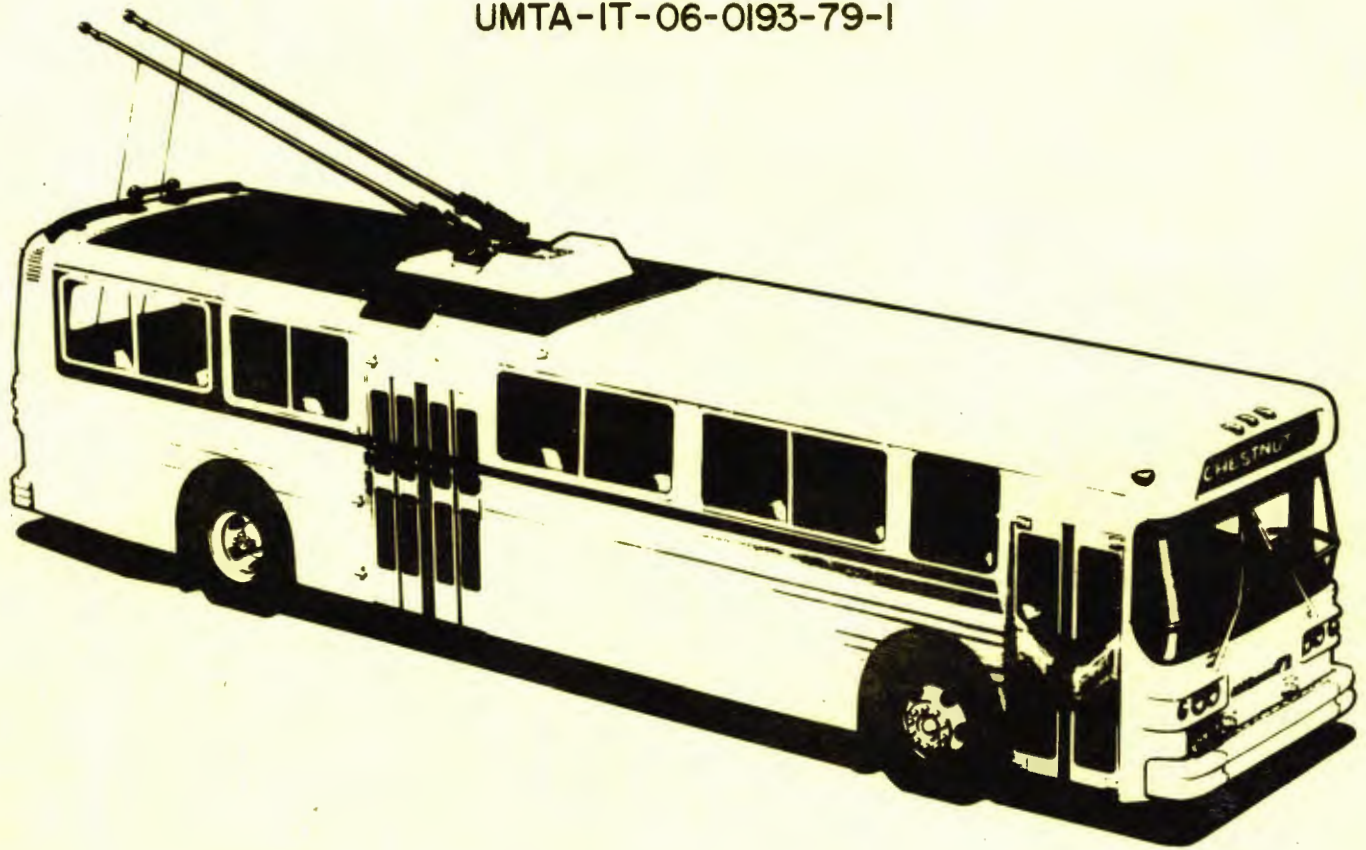

OCTOBER 1979

U.S. DEPARTMENT OF TRANSPORTATION
Urban Mass Transportation Administration
Office of Policy, Budget and Program Development
Washington D.C.



1F
920
W50
1
C.2

RECEIVED

OCT 10 1979

D I S C L A I M E R

The work described in this report has been sponsored by the U. S. Department of Transportation, Office of Policy, Budget and Program Development. The contents of the report, however, reflect the views of Chase, Rosen & Wallace, Inc. They are fully responsible for the facts, the accuracy of the data, and the conclusions expressed herein. The contents should not be interpreted as necessarily representing the official views or policy of the Department of Transportation of the United States Government.

1. Report No. UMTA-IT-06-0193-79-1	2. Government Accession No.	3. Recipient's Catalog No.	
4. Title and Subtitle The Trolley Coach Development and State of the Art		5. Report Date October 1979	
		6. Performing Organization Code	
7. Author(s) John D. Wilkins, Arthur Schwartz, Tom E. Parkinson		8. Performing Organization Report No.	
9. Performing Organization Name and Address Chase, Rosen & Wallace, Inc. 901 North Washington Street Alexandria, Virginia 22314		10. Work Unit No. (TRAIS) IT-06-0193	
		11. Contract or Grant No. DOT-UT-80037	
12. Sponsoring Agency Name and Address U.S. Department of Transportation Urban Mass Transportation Administration 400 Seventh Street, S.W. Washington, D. C. 20590		13. Type of Report and Period Covered Task 1 Final Report	
		14. Sponsoring Agency Code	
15. Supplementary Notes This report provides the results of the first task, of a two-task project, on the feasibility of electric trolley buses (trolley coaches). The Task 2 report for this project will contain the results of an evaluation of the viability of this mode for U.S. cities (i.e., marketability, costs, impacts, etc.).			
16. Abstract This report contains a brief history of trolley coach operation in the United States and descriptions of currently operating trolley coach systems. Trolley coach technology is described and illustrated, including vehicles, propulsion and control systems and overhead wire and fittings. European and North American practice is contrasted. Operational characteristics of the trolley coach are described, including its suitability for applications in various situations and requirements for trolley coach system design. Environmental effects of trolley coach operation are analyzed, as are user impacts. Research needs are indicated.			
17. Key Words Trolley coach Electric vehicle Overhead wire Public transit		18. Distribution Statement Available to the public through the National Technical Information Service Springfield, Virginia 22161	
19. Security Classif. (of this report) Unclassified	20. Security Classif. (of this page) Unclassified	21. No. of Pages 264	22. Price

01304

18
9.10
10.10
11.10
12.10

THE TROLLEY COACH
DEVELOPMENT & STATE OF THE ART

TASK 1 REPORT
FOR THE
ELECTRIC TROLLEY BUS FEASIBILITY STUDY
DOT-UT-80037
UMTA - IT-06-0193-79-1

October 1979

U.S. DEPARTMENT OF TRANSPORTATION
Urban Mass Transportation Administration
Office of Policy, Budget and Program Development
Washington, D.C. 20590

Prepared by:

CHASE, ROSEN & WALLACE, INC.
901 North Washington Street
Alexandria, Virginia 22314

ACKNOWLEDGEMENTS

This project involved the cooperation and assistance of many individuals in the Urban Mass Transportation Administration and in the transportation industry here and abroad.

We would like to express our appreciation to Ms. Yvonne Griffin, Program Analyst, of the Office of Program Evaluation in the Urban Mass Transportation Administration, for her guidance and assistance in overall project direction. We also wish to thank Mr. Jimmy Yu of the Office of University Research and Training and Mr. Robert L. Abrams of the Office of Transit Assistance, in the Urban Mass Transportation Administration for their interest and support throughout this study.

We are grateful to Messrs. Authur Schwartz and Edward A. Mierzejewski and to Tom E. Parkinson, consultant to the project, who provided considerable assistance in the preparation of this report.

Lastly, we wish to acknowledge the many representatives of manufacturing firms and transit operators who generously gave their time and shared with us their professional knowledge. Although these individuals are not identified in this report, their contributions to this project are substantial.

John D. Wilkins, Project Director

TABLE OF CONTENTS

CHAPTER 1.1 - DEVELOPMENT AND STATUS OF THE TROLLEY COACH

	<u>Page</u>
Introduction	1
Early Development	2
Early Transit Applications	3
Adaption by the Transit Industry	4
Decline from the Summit	15
Background to Case Histories	21
Boston	22
Dayton	25
Philadelphia	26
Seattle	30
San Francisco	33
Edmonton	34
Vancouver	38
Toronto	42
Hamilton	45
Calgary	47
The European Experience	48
Trolley Coach Situation in Other Locales	50
Summary of Trolley Coach Experience and Prospects	51
Specific Factors Influencing Trolley Coach Retention and Conversion	51
References	54

CHAPTER 1.2 - STATE OF THE ART

Introduction	55
Motor Voltage Control Systems	55
Introduction	55
System Basics	55
Switched Resistor Control	57
Thyristor Chopper Control	58
Pulse Width Modulation with AC Motors	60
Specific Control Systems	61
North American Designs	61
European Trolley Coach Control Designs	69
Trolley Coach Motors	79
Trolley Coach Braking Systems	81
A Comparison of Trolley Coach Energy Consumption	84
Conclusions	84
Future Technical Trends	84
Off-wire Trolley Coach Operation	86
Battery Operation	88
Flywheels	90
Petrochemicals	90
Combinations of the Above	92
Summary	92

Table of Contents (continued)
 Chapter 1.2 - State of the Art

	<u>Page</u>
Vehicles	95
Principal Differences	95
New Generation Vehicles - U.S. and Canada	100
New Generation Vehicles - European	101
Articulated Vehicles	105
Transbus Requirements	133
Power Distribution - Contact Wire System	133
Background	133
Components of the Contact Wire System	134
Typical Wire Configuration	141
Rigid and Elastic Contact Wire Systems	144
Ohio Brass (OB) System	147
Kummler & Matter (K&M) System	157
Furrer and Frey (F&F)	164
Delachaux	167
Comparison of OB and K&M Systems	167
Current Collection System	170
Automatic Retriever System	176
Power Supply for Trolley Coaches	178
Power Requirements	179
Feeder Type	182
Voltage Regulation	182
Substation Spacing	186
Substation Reliability	187
Protective Relaying	187
Supervisory Control	188
Regeneration	189
References	190

CHAPTER 1.3 - OPERATIONAL AND ENVIRONMENTAL EVALUATION

Operating Performance and Speed	191
Introduction	191
Performance Characteristics	192
Street Performance	195
Conclusions	197
Reliability	199
Availability	199
Service Failure	199
Vehicle Requirements and Capacity	202
Vehicle Requirements	202
Capacity	203
Air Pollution Characteristics	204
Noise Characteristics	206
Energy Characteristics	211
References	213

TABLE OF CONTENTS

CHAPTER 1.4 - INTEGRATION AND POTENTIAL FOR UPGRADING

	<u>Page</u>
Introduction	215
Service Design	215
Route Configuration	218
Express Operation	220
System Flexibility	223
Operations and Maintenance	225
Vehicle Maintenance	225
Servicing	232
Storage	234
Power Distribution, Operation and Maintenance	235
Training of Operating Personnel	238
Scheduling	240
Organizational Changes	240
Feasibility of Trolley Coaches for Exclusive Right of Way	241
Background	241
Differences in Right of Way Requirements	241
Suitability of TC's for Different Right of Way Configurations	243
Variations Due to Usage Level	246
Conversion of Trolley Coach Rights of Way to Rail Operation	247
References	248

CHAPTER 1.5 - IDENTIFICATION OF RESEARCH NEEDS

Introduction	249
Off Wire Capability	249
Current Collection for High Speed Operation	251
Propulsion Control Systems	252
Routing Control	253
Passenger Preference	254

LIST OF FIGURES

CHAPTER 1.1 - DEVELOPMENT AND STATUS OF THE TROLLEY COACH

<u>Figure</u>		<u>Page</u>
1.1-1	New Trolley Coach Systems, 1928-1952	5
1.1-2	Mode Application, Pre-World War II Era	8
1.1-3	Comparison of Maximum Load Checks Before and After TC Conversion, Milwaukee, Wisconsin	13
1.1-4	Abandonment of Trolley Coach Systems, 1945-Present	16
1.1-5	Life Span of Selected Trolley Coach Operators	17
1.1-6	Trolley Coach Routes of Boston	24
1.1-7	Trolley Coach Routes of Dayton	27
1.1-8	Trolley Coach Routes of Philadelphia	29
1.1-9	Trolley Coach Routes of Seattle	32
1.1-10	Trolley Coach Routes of San Francisco	35
1.1-11	Trolley Coach Routes of Edmonton	37
1.1-12	Trolley Coach Routes of Vancouver	40
1.1-13	Trolley Coach Routes of Toronto	44
1.1-14	Trolley Coach Routes of Hamilton	46

LIST OF TABLES

CHAPTER 1.1 - DEVELOPMENT AND STATUS OF THE TROLLEY COACH

<u>Table</u>		<u>Page</u>
1.1-1	Surface Transportation Vehicles in the United States	6
1.1-2	Comparison of Operating Cost by Mode	10
1.1-3	Comparison of Trolley Coach and Motor Coach Operating Costs	10
1.1-4	Ridership Increases Attributed to New Trolley Coach Services	12
1.1-5	New Increase in Ridership Due to Conversion Milwaukee TC Lines	12
1.1-6	Trolley Coach Purchases Since 1970	21

LIST OF FIGURES

CHAPTER 1.2 - STATE OF THE ART

<u>Figure</u>		<u>Page</u>
1.2-1	General Electric Type MRC Control	62
1.2-2	Control Pedal Positions - GE MRC Control	63
1.2-3	Control Schematics - GE MRC Control	64
1.2-4	Randtronics Chopper Controller TBC 500-600 Power Circuit Diagram	67
1.2-5	BBC/Secheron Chopper Installed Under Body	69
1.2-6	Brown Boveri Chopper Control Simplified System for Vancouver, Canada	71
1.2-7	Oy Stromberg Ab. Schematic Circuit for a PWM System	72
1.2-8	CEM-Oerlikon (France) Basic Control Circuit for Berliet ER100 Trolley Coach	74
1.2-9	Siemens Trolley Coach Propulsion Control (Lucerne)	77
1.2-10	Equipment Layout for a Flywheel Augmented Trolley Coach	91
1.2-11	BBC/Secheron Auxiliary Power Plant Using Volkswagen Engine	93
1.2-12	Esslingen (West Germany) Transit Route Structure	94
1.2-13	Pre- and Post-War Trolley Coaches	98
1.2-14	AM General Two Axle, Trolley Coach	106
1.2-15	Flyer Two Axle Trolley Coach	108
1.2-16	Swiss Standard Two Axle Trolley Coach	110
1.2-17	Swiss Standard Articulated Trolley Coach	112
1.2-18	M.A.N. Two Axle Trolley Coach	114
1.2-19	M.A.N. Articulated Trolley Coach	116
1.2-20	Berliet Two Axle Trolley Coach	118
1.2-21	Finnish Two Axle Trolley Coach	120
1.2-22	Ikarus Articulated Trolley Coach	122
1.2-23	Skoda Two Axle Trolley Coach	124
1.2-24	Russian Two Axle Trolley Coach	126
1.2-25	Daimler-Benz Articulated All Service Coach	128
1.2-26	Daimler-Benz Two Axle All Service Coach	130
1.2-27	DUO-Bus Propulsion System Configuration	132
1.2-28	Grooved Wire Cross Sections	135
1.2-29	Tangent Section	135
1.2-30	Tangent Section - Bracket Arm	136
1.2-31	Curve Alignments	138
1.2-32	Facing Point Switch	140
1.2-33	Crossover	140
1.2-34	Turning Movements	142
1.2-35	Terminal Loops	143
1.2-36	Shared Wiring in Garages	143
1.2-37	Collector Path at Rigid Suspension Point	146
1.2-38	Wire Wear - Rigid vs. Elastic Suspension	148
1.2-39	OB Tangent Construction	150
1.2-40	OB Curve Segments	140
1.2-41	OB Switches	152
1.2-42	OB Routing Control	153

List of Figures (continued)
 Chapter 1.2 - State of the Art

<u>Figure</u>		<u>Page</u>
1.2-43	Inductive Control	155
1.2-44	OB Crossovers	156
1.2-45	K&M Tangent Construction	158
1.2-46	K&M Curve Segments	160
1.2-47	K&M Switches	162
1.2-48	K&M Crossovers	162
1.2-49	F&F Tangent Construction	165
1.2-50	F&F Curve Segments	166
1.2-51	F&F Switches	168
1.2-52	Delachaux Line Hardware	169
1.2-53	Current Collection System	172
1.2-54	Current Collectors	173
1.2-55	Trolley Base	175
1.2-56	Trolley Coach Power Supply Feeder vs. Feederless System	183

LIST OF TABLES

CHAPTER 1.2 - STATE OF THE ART

<u>Table</u>		<u>Page</u>
1.2-1	Trolley Coach Traction Motors	80
1.2-2	Energy Consumption by Control Type	85
1.2-3	Energy Storage System Comparison	90
1.2-4	Typical Specifications for Pre-War Trolley Coaches	96
1.2-5	Typical Specifications for Post-War Trolley Coaches	97
1.2-6	Clearances for Pole Attachments and Crossings	141
1.2-7	Trolley Coach Diversity Tabulation - Flyer Coach with MRC Controls	179
1.2-8	Substation Capacity	181
1.2-9	Cable and Wire Data	184
1.2-10	Substation Spacing - Feederless System Two-Way Wire	186
1.2-11	Distance to Substation from End of Line - Feederless System - Two-Way Wire	186

LIST OF FIGURES

CHAPTER 1.3 - OPERATIONAL AND ENVIRONMENTAL EVALUATION

<u>Figure</u>		<u>Page</u>
1.3-1	Trolley Coach Operating Characteristics - Single Motor, 48-50 Passenger Coaches	193
1.3-2	Gradeability Curve - Trolley Coach GE 1213 Motor	194
1.3-3	Comparison of Running Times in Seattle	196
1.3-4	Comparison of Running Times in San Francisco	198
1.3-5	North American Reliability Districts	207
1.3-6	Vehicular Noise Ranges	210

LIST OF TABLES

CHAPTER 1.3 - OPERATIONAL AND ENVIRONMENTAL EVALUATION

<u>Table</u>		<u>Page</u>
1.3-1	Trolley Coach and Motor Coach Performance	192
1.3-2	Trolley Coach Availability	199
1.3-3	Trolley Coach Service Failures	200
1.3-4	Motor Coach Service Failures	200
1.3-5	Non-Vehicular Trolley Coach Service Failures	201
1.3-6	Urban Motor Coach Emissions	205
1.3-7	Trolley Coach Emissions	205
1.3-8	Relative Toxicity of Air Pollutants	206
1.3-9	Power Generation Fuel Source in the Various Reliability Districts	208
1.3-10	Sound Intensity Above Ambient	209
1.3-11	Reported Fuel and Power Consumption	211

LIST OF FIGURES

CHAPTER 1.4 - INTEGRATION AND POTENTIAL FOR UPGRADING

<u>Figure</u>		<u>Page</u>
1.4-1	Radial Routes with Central Garage Location	217
1.4-2	Radial and Crosstown Routes with Garage on Crosstown Route	217
1.4-3	Bus Route with Suburban Extensions	219
1.4-4	Local and Express Trolley Coach with Feeder Bus Routes	219
1.4-5	Local Trolley Coach and Express Bus Routes	219
1.4-6	Operation of Passing Section on a Trolley Coach Route	221
1.4-7	Sample Downtown Area with Emergency and Turnback Wire	224
1.4-8	BC Hydro Inspection Procedures	227
1.4-9	Organization of the Maintenance Department for Trolley Coach Operations	240

LIST OF TABLES

CHAPTER 1.4 - INTEGRATION AND POTENTIAL FOR UPGRADING

<u>Table</u>		<u>Page</u>
1.4-1	Major Unit Components	228
1.4-2	Distribution of Trolley Coach Vehicle Mileage in Vancouver	228
1.4-3	Current Life of Brakes in Service	229
1.4-4	Average Life of Major Unit Components	231
1.4-5	Trolley Coach and Motor Coach Servicing Activities	232
1.4-6	Personnel Employed for Overhead Wire Maintenance	236
1.4-7	Configuration 1 - Cost Comparisons	245
1.4-8	Configuration 2 - Cost Comparison	245
1.4-9	Configuration 3 - Cost Comparison	246

CHAPTER 1.1

DEVELOPMENT AND STATUS OF THE TROLLEY COACH

Introduction

The deployment of the Trolley Coach (TC) can be traced through five distinct periods. The first period, extending from approximately the late 1880's to 1915, witnessed the birth of TC technology and its first deployment in an operating situation. The second period commenced in 1921, following a seven year hiatus, and extended through the late part of that decade. This period witnessed the first utilization of TC technology by transit operators. Typically, it was employed in situations where passenger volumes did not warrant the investment in a full fledged street railway line.

The third period extended from approximately the late 1920's through the early 1950's. During this period of time, the trolley coach achieved its maximum deployment in North America. At the beginning of this period, the TC was used largely to feed existing street railway lines, or was placed on routes which did not warrant the investment in street railway facilities. This was rather quickly followed, however, by using TC technology to replace street railways. TC's became the predominant mode on many of the country's major transit systems. With the exception of the war years, 1941 through 1945, the number of TC's employed grew steadily.

The fourth period extended from the early 1950's, overlapping the previous period to some degree, through the early 1970's. During this twenty year period, the trolley coach disappeared as fast as it had appeared in the previous twenty years. The availability of larger high performance diesel buses, the overall decline of the transit industry, and the changing economics of trolley coach operations all combined to retire this mode from all but a handful of North American cities. By the end of the fourth period, only ten systems in North America still retained TC operation. In the United States these included Boston, Philadelphia, Dayton, Seattle and San Francisco; in Canada, Toronto, Hamilton, Edmonton and Vancouver; and in Mexico, Mexico City.

The fifth and current period of TC's can be characterized as one of rekindled interest in TC technology. During the last several years, every TC operator in the United States and Canada has purchased new vehicles. This period has also seen the introduction of new technology in propulsion system hardware, the complete rebuilding and expansion of an existing system, and the installation of an entirely new system in North America.

The following discussion will deal with each of these periods, although the greatest emphasis will be placed on those periods which cover the timespan between the 1930's and the present time.

Early Development

The authors of Transit's Stepchild - The Trolley Coach 1/ cite the first experimentation in trolley coach technology as occurring in 1882. At this time the German firm of Siemens and Halske developed what was essentially a wagon with an electric motor. The vehicle obtained power by means of a flexible cable. Concurrently, there were numerous other attempts throughout the western world to develop alternatives that would replace horse-drawn transit vehicles.

The first demonstrations of trolley coach technology in this country were reported as early as 1887. These demonstrations, occurring largely in New England, were conducted by promoters trying to encourage investment in trolley coach technology. They were in direct competition with similar interests seeking to encourage the development of street railway technology which was considered more appropriate by transit properties that were attempting to update their operations.

This era witnessed the installation of two trolley coach operations. Although these installations were of a special nature, they can be considered as the birth of TC technology in this country. The first installation occurred in the suburban Los Angeles community of Bungalowtown, which was located in the Laurel Canyon area. The developer of this town, Laurel Canyon Utilities Company, could not convince either of the area's public transportation companies to extend into the new development. This required the developer to provide the necessary link between the community and the existing transportation systems. The developer first tried a motor coach service, which proved to be unsuccessful due to the hilly terrain. The company's president had become acquainted with a trackless electric vehicle which operated in similar terrain in Switzerland. He quickly seized this concept and in 1910 this country's first trackless trolley was placed in operation. The vehicles employed were two 16 seat Oldsmobile motor coaches which had been rebuilt for electric operation. They were open sided and had the appearance of a large touring car. The electrical current collectors were mounted on the roof in the forward part of the bus. Overhead lines were installed using standard street railway fittings, though switches or turnouts were not provided. Passing movements required that one of the vehicles remove current collectors from the wire. The adaptation appears to have been a success, but the vehicles were withdrawn in 1915 at the end of their useful life.

The second significant TC installation occurred at Merrill, Wisconsin in 1913. This installation was part of Merrill Railway and Lighting Company, and was the first such by a transit operator. Merrill Railway was not seeking a technological breakthrough, but was rather seeking a solution to a very specific problem it faced. The company wanted to extend one of its streetcar lines to an unserved portion of the city. The extension would have required strengthening a bridge and installing grade crossings with several busy railroad companies. The rail extension would have required a substantial capital outlay. In looking for alternatives, the company decided upon the installation of the trackless trolley system. Wires were quickly strung, one vehicle was purchased, and the service was instituted. It continued for approximately one year until the whole enterprise went bankrupt.

Although both of these operations were short lived, they had proven that trolley buses would work and that the technology was viable. Although a seven year hiatus followed, the experience of these two pioneers encouraged transit operators to seriously consider this mode.

Early Transit Applications

The first major TC application occurred in New York City's Borough of Staten Island in 1921. The Staten Island Municipal Railway went into default and ceased all operation. The borough was sparsely populated, which led to the company's default and to a decision by the city not to reopen streetcar service to the lesser developed areas. The city had planned to substitute motor coach service but was confronted with a statute that prevented this course of action. The statute did not refer to TC's and such a system was quickly put into operation. The system was to grow from its initial seven vehicles to a maximum of twenty two. Unfortunately, the system was short lived and all service ended in 1927.

The Twin City Rapid Transit Company (TCRT) opened a TC line in 1922. The line was intended to provide service to a developing area which did not warrant street railway service. Patrons on Bloomington Avenue between 38th and 48th Streets would board the TC and then transfer to a streetcar to finish their journey. This line was also short lived and in 1923 TCRT extended streetcar service into the area.

Similar applications were witnessed in other cities. Toronto installed TC's on its Mt. Pleasant route in 1922 as a result of citizen pressure for transit service. The TC's were abandoned in 1925 when the St. Clair car line was extended, only to be reinstalled several years ago. Baltimore used TC's on a line that extended from Gwynn Oak Junction via Liberty Road to Randallstown. The selection of this mode was a compromise with the town's developer who had wanted streetcar service. The operation lasted until 1931 when the vehicles were worn out.

Other early examples can be cited in such cities as Rochester, New York and Windsor, Ontario. None of these early systems lasted more than a decade. The first permanent installation occurred in 1923 when the Philadelphia Rapid Transit Co. placed TC service on its Oregon Avenue route in South Philadelphia. The installation was considered as a permanent part of its grid route network in that section of the city. It remained as a TC route until 1961. It is quite likely that the Philadelphia experience influenced the growth in TC usage that was to occur through the 1930's.

Several reasons can be cited for the short life of the early systems. These include:

- o Many operators had preconceived ideas that the TC's role was transient in nature and it would be followed by the installation of street railway services.
- o The vehicles were primitive. Many were simply streetcar bodies on hard rubber tires. Automotive technology was in its infancy and could not provide either long mileage vehicles or a ride quality equal to that provided by streetcars.

- o The vehicles were small with an average seating capacity of 25 persons. This restricted their use to feeder routes.
- o Operating costs were often high. This resulted from the extra maintenance required by the bumpy, often unpaved, streets and roads that had to be used. Despite these failings, the experience obtained was used to improve TC technology and made possible future applications.

Adaption by the Transit Industry

The late 1920's and early 1930's witnessed several significant TC installations. Salt Lake City and New Orleans installed TC routes to replace street railway operation. Unlike earlier operators they were able to purchase vehicles with forty or more seats which made their TC much more comparable to streetcar capacity. The largest installation occurred in Chicago between 1930 and 1931. During this time forty seat vehicles were placed in service on seven routes in the northwestern section of the city. The routes served an area where population density was increasing and provided feeder service to streetcar and rapid transit networks. However, Chicago Surface Lines did not yet feel that TC's were the equal of its streetcar.

Chicago's experience was to the contrary, since many transit operators were considering the replacement of street railway systems with TC's. Smaller cities such as Flint, Michigan; Kenosha, Wisconsin; and Greenville, South Carolina, replaced their entire rail system with TC's during the 1930's. The motor coach was also gaining respectability and became the conversion vehicle in many cities. Its importance in replacing streetcars would far exceed that of the TC's. Figure 1.1-1 indicates the number of new TC systems that came on stream during the period of 1928 through 1952.

As shown in Figure 1.1-1, U.S. transit properties installed TC's in significant numbers during the early thirties. The deep depression years of 1933 and 1934 curtailed activity to some extent, but the pace began to pick up in the late 1930's. The greatest number of conversions occurred in 1937 when seven systems began TC operation. The activity continued until it was interrupted by World War II. Following the end of hostilities, additional systems were added but most of the activity shifted to Canada.

The trolley coach as shown in Table 1.1-1 never became the major surface transit mode. At its peak in 1950, only 6500 vehicles were in operation and it accounted for only 8.5% of all surface vehicles. In 1955 the number of vehicles had slipped to approximately 6150, but the percentage of total surface fleet went up to 9.6%. This resulted from the fact that between 1950 and 1955 the number of motor coaches and streetcars decreased at a greater rate than TC's. The rate of decrease for motor coaches was 6.7%, street cars 59.9% and TC's 5.3%.

Figure I.1-1
New Trolley Coach Systems, 1928-1952*

United States Canada Mexico
□ ▨ ▩

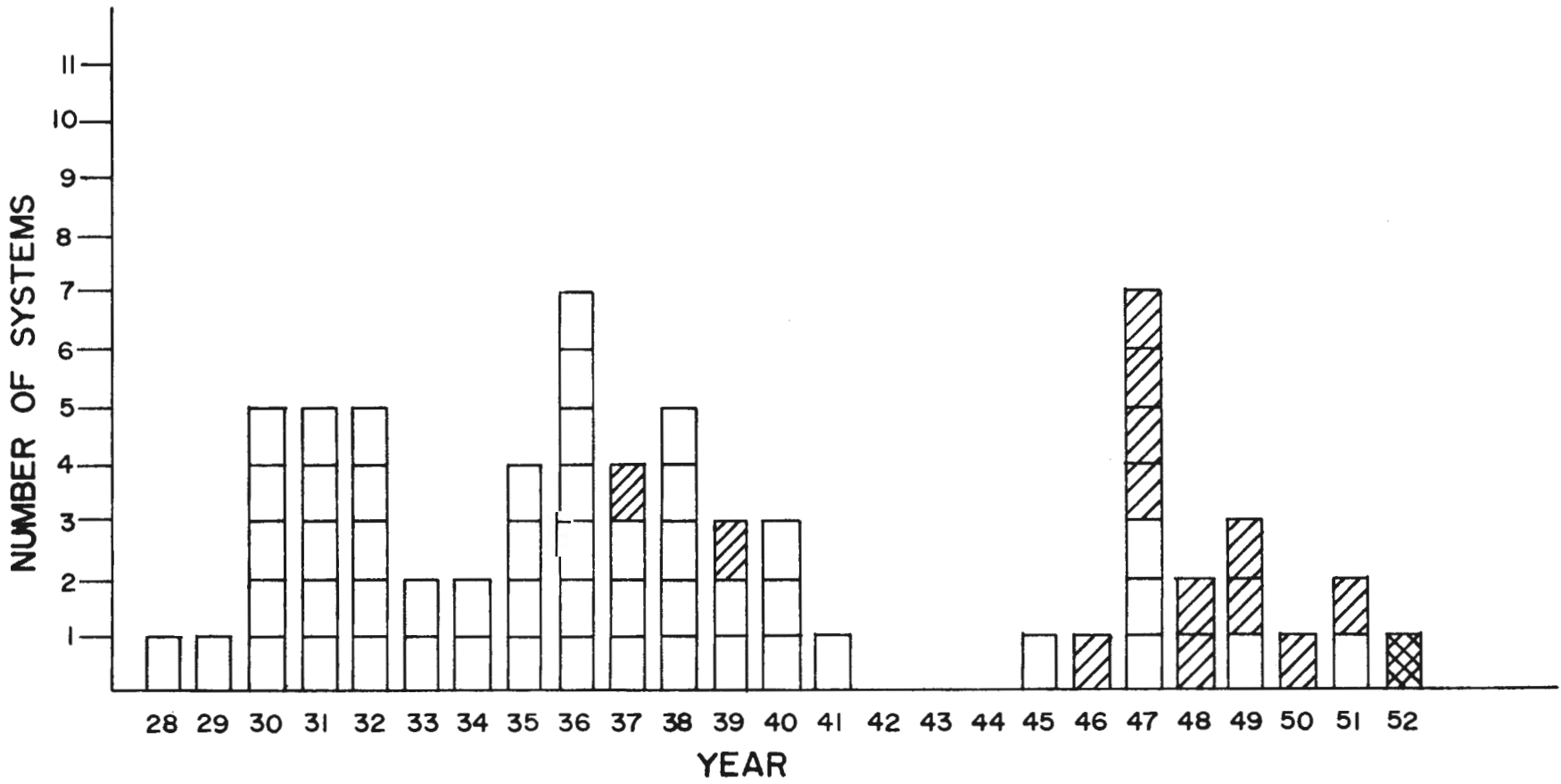

* Reference I

Table 1.1-1

Surface Transportation Vehicles in the United States *

<u>Year</u>	<u>Streetcars</u>		<u>Trolley Coaches</u>		<u>Motor Coaches</u>		<u>Total</u>
	<u>Number</u>	<u>Percent</u>	<u>Number</u>	<u>Percent</u>	<u>Number</u>	<u>Percent</u>	
1930	55,150	72.0	173	0.2	21,300	27.8	76,623
1935	40,050	62.2	578	0.9	23,800	36.9	64,428
1940	26,630	41.3	2,802	4.3	35,000	54.3	64,432
1945	26,160	33.0	3,711	4.7	49,670	62.3	79,541
1950	13,228	17.3	6,504	8.5	56,820	74.2	76,552
1955	5,300	8.3	6,197	9.6	52,400	82.1	63,857
1960	2,856	5.1	3,826	6.8	49,600	88.1	56,282
1965	1,949	2.9	1,493	2.8	49,600	94.3	52,602
1970	1,262	2.4	1,050	2.0	49,700	95.6	52,012
1975	1,061	2.0	703	1.3	50,811	96.7	52,575
1977	992	1.9	645	1.2	51,968	96.9	53,605

* Reference 2

One reason the TC did not make greater inroads into the surface vehicle market was its failure to become a predominant surface mode in the populous cities of the Northeast. Only in Boston, Providence, and Baltimore was it used in significant numbers. In cities such as New York and Philadelphia it never played a major role. The TC was widely used in the Midwest, but even in Chicago it did not operate on the heavier routes, such as Archer Avenue. The TC never comprised more than about 22% of Chicago's total surface fleet. Cities such as St. Louis and Minneapolis/St. Paul did not consider the TC in the Thirties or Forties.

The principal question yet to be answered is why did sixty-five transit operators decide to install trolley coach operations. The documentation, that is readily available, provides a good picture of the major reasons. The discussion which follows deals with the various aspects of this question.

Life-expired Street Railway Systems

Throughout the 1930's many street railway systems reached the end of their economic life. Major expenditures were required in track and rolling stock if profitable operations were to continue. Unfortunately the transit industry was not in a position to raise sufficient funds for rail system rehabilitation. Passenger volume was dropping and the country was in the midst of the Depression. Each company had to consider its own financial environment and select a course of action which would either maximize profit or minimize losses. Many operators converted directly to motor coach, some employed trolley coaches while others, such as Pittsburgh, set about modernizing their railway systems.

Indianapolis entered upon an improvement program which encompassed all three alternatives. Indianapolis Railway (IR) had inherited an obsolete rail system from its predecessor, which was badly in need of modernization. IR developed a plan which placed new streetcars on the four heaviest routes, TC's on secondary routes and motor coaches on feeders and the weaker trunk routes. IR became one of the first operators to "fit the mode to the job," a practice that was soon to be employed by other operators. Figure 1.1-2 indicates one application of this approach as envisioned by Marmon-Herrington, one of the major TC builders.

Many street railway companies were also faced with the need to extend routes into developing areas. They lacked sufficient resources to extend streetcars and turned instead to cheaper rubber-tire vehicles. Many individual streetcar routes were converted for this reason.

Smaller streetcar systems were sometimes forced to convert because of the impact of highway construction, repaving projects, or other circumstances beyond their control. They did not possess the necessary funds to reconstruct and conversion was often their only option. For example, Kenosha, Wisconsin, converted its entire system because it was faced with extensive track relocation to accommodate the grade separation of a major railroad through the city.

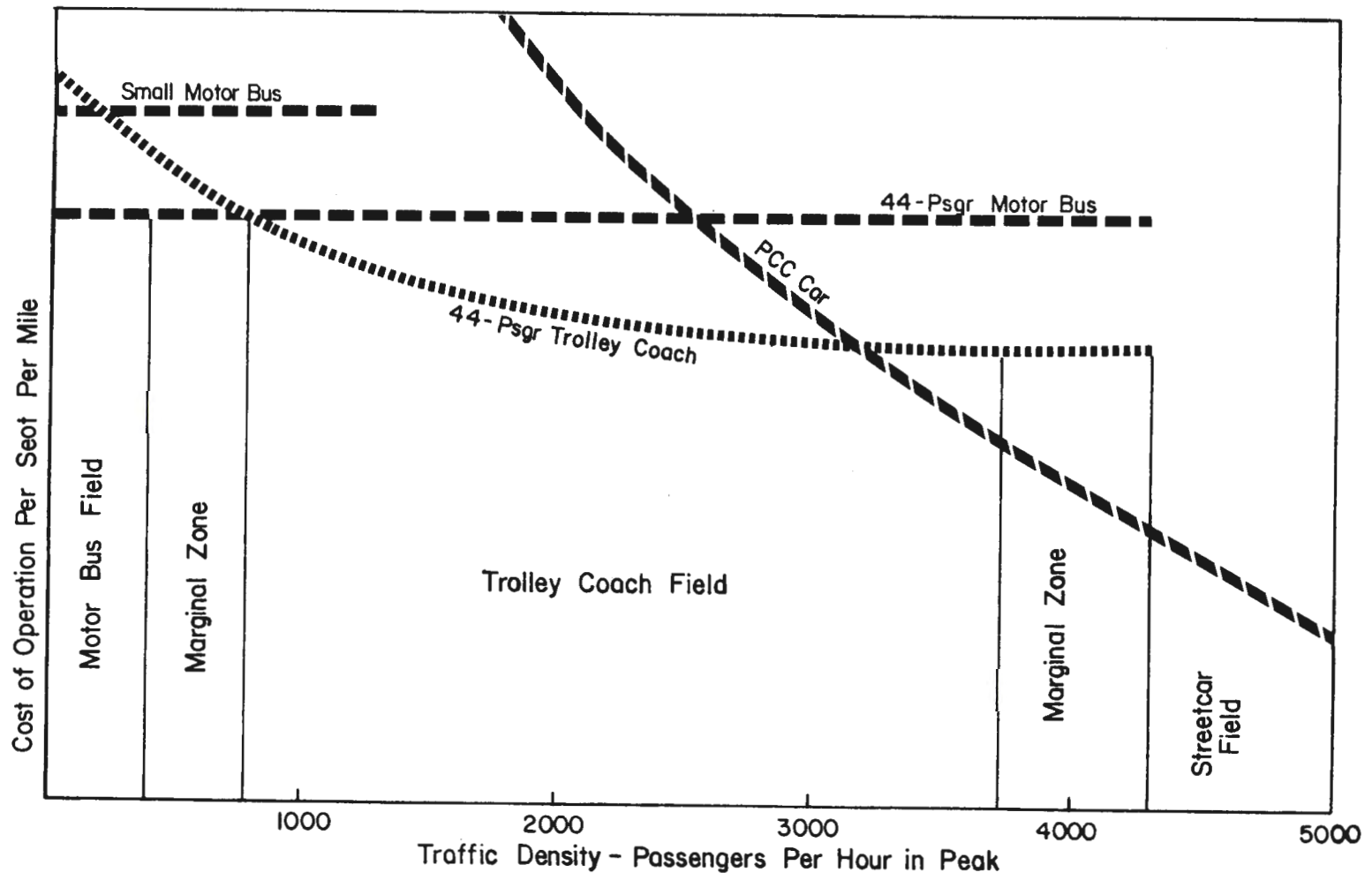

Figure I.1-2
 Mode Application, Pre World War II Era*

*Reference I

Performance

In the late Twenties and early Thirties the TC really had no competitor when it came to performance. The older streetcars of that time lacked similar performance characteristics or were restricted by worn out track. Many cities reported greatly improved performance after converting to TC's. Columbus, Ohio proclaimed them to be a faster vehicle, while Baltimore and Youngstown cited running time improvements of 5.6 and 8.5 percent, respectively.

Capital and Operating Costs

Capital Costs - The capital costs associated with the trolley coach include such items as vehicles, overhead lines, substations and feeder network, and maintenance and storage facilities. The rail transit operator considering TC's was not faced with the need to procure all these assets. New vehicles were required and overhead lines had to be modified to allow two wire operation. The remaining facilities were in place and often required little or no modification.

TC's in the 1930's cost more than comparably-sized motor coaches although the difference was often as low as \$1000 per vehicle, about 5 percent of the total price. The TC's had a longer life and were depreciated over a greater number of years. The average financial life for TC's and motor coaches was fourteen and ten years, respectively. When expressed as an annual depreciation cost, TC's compared quite favorably with motor coaches.

Modifications to the overhead lines did represent a capital outlay which could be avoided if motor coaches were employed. The necessary alterations included:

- o Installation of a negative return wire,
- o Special work at curves and intersections, i.e., switches, crossover and curve segments had to be changed to accommodate TC's,
- o Loops had to be re-wired,
- o New wire had to be installed for extensions and in those areas where TC's did not follow the old streetcar route.

Much of the line hardware used for street railways could be employed on TC systems reducing the need for such funds. The greatest cost was for the labor required to make the modifications.

The maintenance and storage facilities were not generally subjected to major modifications for TC operations. If outdoor storage was employed for rail cars TC's were usually stored in a similar fashion. Motor coaches, on the other hand, necessitated indoor storage in northern climates to avoid frozen engines. Further, the servicing facilities required by the TC's were less than those of the motor coaches. The latter required fuel, water and lube oil facilities which were not necessary for the TC.

Inventory was another point of consideration. The amount of stock required to support TC operation was far less than motor coach. This was principally due to the simplicity of the electric propulsion system.

Investment in maintenance staff training was an additional item. Conversions to motor coaches required a training program to acquaint staff with automotive technology. This did not represent a major cost but was a point of consideration.

Operating Costs - The cost savings realized when streetcars were converted to TC operation were usually quite significant. Maintenance of way costs were eliminated and, in the case of the TC, superior performance characteristics often resulted in reduced transportation costs. There were situations, however, where streetcars could not be replaced on a one for one basis due to their greater capacity. This situation reduced the savings which could be realized, since additional TC's were required to handle the same passenger levels. The cost per mile figures shown in Tables 1.1-2 and 1.1-3 reflect the cost situation of many operators.

Table 1.1-2

Comparison of Operating Cost by Mode
Pre-World War II*
(Cost Per Mile)

City	New York City (a)	Rockford, Ill.
Year	1927	1930
Rail	29.55¢	17.82¢
TC	20.95¢	12.32¢
Motor Coach	24.30¢	14.72¢

(a) Borough of Staten Island

* Reference 4

Table 1.1-3

Comparison of Trolley Coach and Motor Coach Operating Costs
14 Systems - 1951 *

Cost Category	Cost per Vehicle Mile	
	Trolley Coach	Motor Coach
Maintenance - Coach and Garage	5.85¢	10.25¢
- Overhead	1.67	--
Fuel	--	4.28
Power	5.22	--
Depreciation - Coach	3.70 (a)	5.55 (b)
- Overhead	.67	
Total	17.11¢	20.08¢

Difference Favoring Trolley Coach - 2.97¢ per vehicle mile

(a) Based on an original cost of \$20,000 and 15 year life.

(b) Based on an original cost of \$20,000 and 10 year life.

* Reference 4

The comparison between TC and motor coaches is more subtle than the rail-TC comparison. The TC was usually more economical in the following areas:

- o Maintenance - The TC's electric propulsion system, the principal difference between the two vehicle types, was much simpler and required less maintenance.
- o Servicing and garaging - TC's did not require the same level of servicing as motor coaches and fewer maintenance personnel were required.
- o Operation - On heavy lines with frequent stops the TC with its superior performance could cover the same route with fewer vehicles, lowering the total transportation cost.
- o Power - During the 1930's and 1940's comparisons of power costs usually favored the TC. This was especially true if the comparison was with gasoline powered motor coaches.

These cost savings mentioned above were partially offset by maintenance costs of the overhead wire system. On systems with dense service patterns, the cost per vehicle mile was reduced since total costs were spread over a large mileage base.

Utilization of Existing Facilities

The power distribution systems that supported railway operation were extensive and represented a sizeable investment. The TC allowed the operator to protect this investment in those situations where its useful life had not been depleted. Conversions from railway to TC in many cases involved no more than a change of mode with actual routings remaining unchanged. Even when expansions were required, the older route segment was very seldom altered. This meant that the substations and feeder lines which had served railway line routes also served the TC. Many systems even used the existing contact wire making necessary modification as noted above. One system, Cincinnati, used both positive and negative overhead wires for streetcar operations further minimizing modifications necessary for TC operation. The staff to maintain the power distribution system was also in place and needed only minimal training to work on TC overhead.

There was no need to install new facilities for motor repair, control system repair and other electrical work since they already existed. The personnel needed for these activities were also readily available. If motor coaches had been chosen these capabilities and resources would have become obsolete and it would have been necessary to re-equip maintenance facilities and re-train the work force.

Passenger Acceptance

There were many examples of ridership improvements when TC services were installed. This was in part due to the poor condition of many street railway systems but also due to the superior performance provided by new TC's. Many systems boasted of the improvements attributable to this new mode. Table 1.1-4 indicates the increases posted in some cities.

Table 1.1-4

Ridership Increases Attributed to
New Trolley Coach Services *

<u>City</u>	<u>Year</u>	<u>% Increase</u>	<u>No. of Routes</u>
Indianapolis	1933	33	1
Providence	1935	28	8
Shreveport	1935	42	1
Kansas City	1938	12	2
Baltimore	1938	46	1
Dallas	1946	10	2
Birmingham	1947	26	2
Memphis	1948	10-15	All TC Routes
Johnstown	1951	25	1

* Reference 5

It should be noted that there is no control on these figures, so it is impossible to tell what portion of the increase is attributable to a general system increase. It is also possible that some of the increase represents trips diverted from competitive car lines.

The City of Milwaukee commissioned a study in 1948 to determine what impact would result when streetcars were converted to TC's. As part of this study a comparison was made of certain TC routes before and after conversion. The results are shown in Figure 1.1-3. It was the conclusion of this report that most of the TC's increased traffic resulted from auto diversion rather than diversion from streetcars. Some diversion from Route 22 did occur when Route 21 was converted. When Route 22 was converted both routes posted increases. These routes were parallel crosstown lines.

Table 1.1-5 indicates the percentage increase per line at the time of conversion. This amount is adjusted to reflect average system increases. It can be clearly seen that conversion has a significant impact.

Table 1.1-5

New Increase in Ridership Due to Conversion
Milwaukee TC Lines *

<u>Route</u>	<u>Total Increase</u> (percent)	<u>Net Increase</u> <u>Due to Conversion</u> (percent)
21	62.8	61.1
35	43.1	57.8
14	69.0	60.1
20	43.9	29.5
22	76.1	42.5

* Reference 5

The industry average increase in ridership when TC's replaced streetcars was 15 percent. The percentage posted in Milwaukee was clearly above the norm.

Figure I.1-3

Comparison of Maximum Load Checks
Before and After TC Conversion
Milwaukee, Wisconsin *

*Reference 5

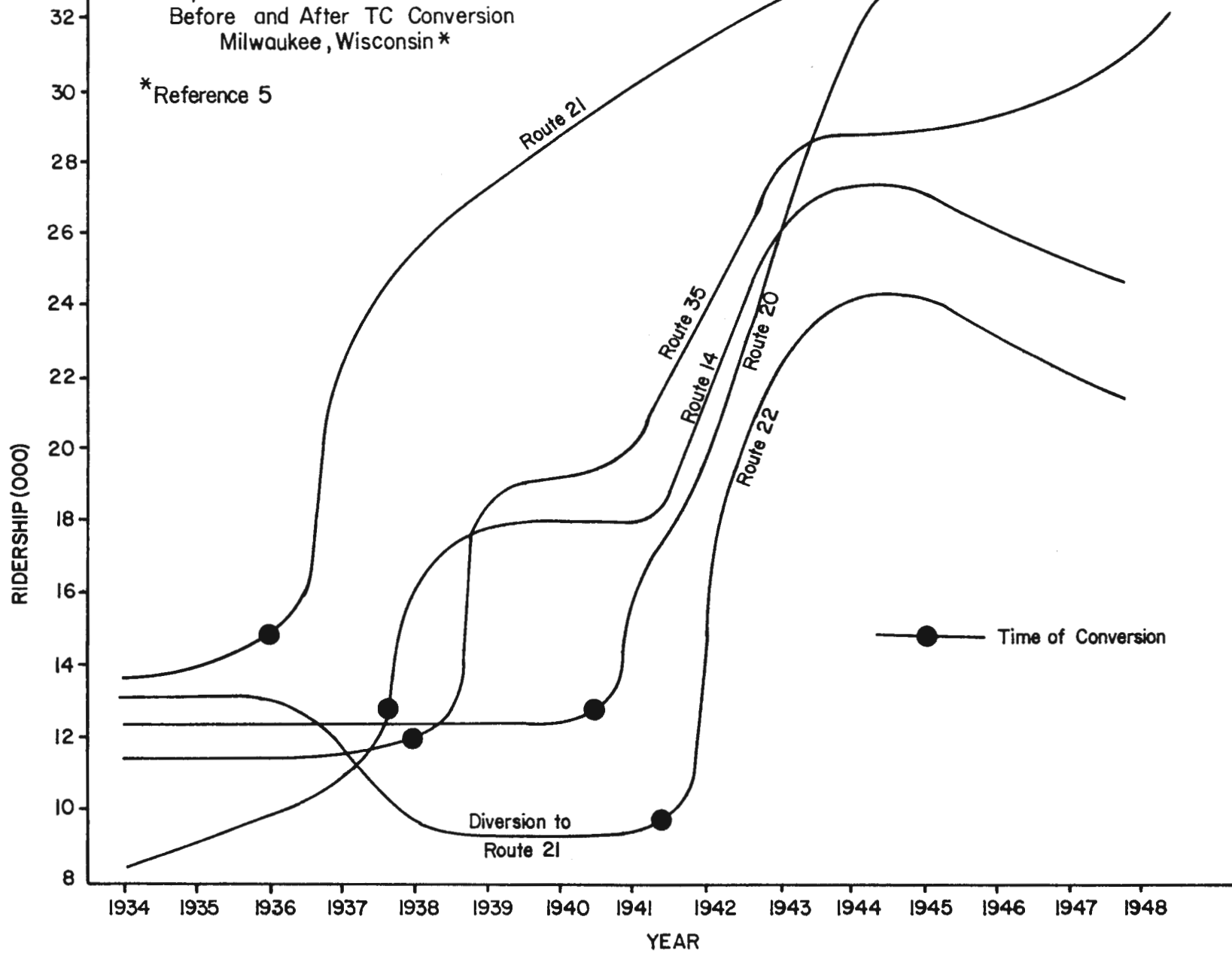

Large Vehicles

The forty passenger TC was introduced in the late 1920's and was employed in Salt Lake City and New Orleans to replace streetcars. As additional systems converted car lines to TC's in the early 1930's the industry began to realize its potential for such applications. In addition to greater capacity, the vehicle also had double stream doors similar to streetcars. This kept dwell time to a minimum and meant stops could be serviced in a manner similar to streetcars.

TC's and diesels rarely had a size advantage over one another. Twin Coach and Brill, for example, used the same coach body for both vehicle types. Marmon-Herrington did offer a forty-eight passenger coach in 1946, a few years before GMC made its TDH 5100 series available. Double stream doors was the only advantage the TC body had over its rival. Dwell time for TC's was less because of this feature. This in turn resulted in shorter running times than could be realized with motor coaches.

The TC also enjoyed a performance edge over the motor coach in that its rate of acceleration was significantly greater. In situations where stops were quite frequent, the TC would out-perform the motor coach. This advantage disappeared with the advent of the 8V-71 diesel engine and both vehicles now have similar performance characteristics.

Electric Company Ownership

Electric utility companies can often trace their origins back to a street railway that decided to sell power commercially. In the 1920's and early 1930's the utility companies assumed prominence and the street car companies became subsidiaries. There was still a strong affinity between the two organizations which was to last until ridership declines made transit ownership more risky or divestment was required by the Securities and Exchange Commission. When the question of conversion was considered by a utility owned transit company there was a natural tendency to think electric. Certain departments, such as power distribution, were closely linked and many job responsibilities fell in both transit and utility areas. Transit management personnel often had worked their way through the utility organization and then switched to transit. The diesel was an alien technology in such an environment.

Reduction in Fees and Franchise Related Costs

Many transit companies were required by their franchise to pay various taxes and perform certain services for the privilege of operating a street railway. The last item was most significant in that street railways were normally required to maintain the street surface between their rails. This was a significant cost which could be eliminated through conversion. There were also property taxes on real estate that could be eliminated through conversion. This related principally to off street right of way and other real estate not required after conversion.

The TC in most states is not considered to be a motor vehicle. A slight advantage over the diesel resulted in that registration and other motor vehicle fees did not have to be paid for this vehicle type.

Decline from the Summit

Trolley coaches achieved their greatest level of use in the early 1950's when over 6500 vehicles were employed on 54 systems. Even before peak usage had occurred, as shown in Figure 1.1-4, many systems were dropping their use of this vehicle. The first abandonment of a post 1930 system was in Topeka, Kansas. The situation was static until after World War II when many of the smaller systems such as Salt Lake and Peoria converted to motor coaches. A small number of systems dropped out in the early 1950's but in the latter part of this decade, nineteen systems abandoned all TC operation. The trend continued up to 1975 when the number of systems in the U.S. and Canada became static. Most of the abandonments in the 1970's occurred in Canada.

The TC's tenure had been a short one and the mode almost became extinct in the 1970's. Had it not been for Toronto's desire to obtain new equipment, the efforts of various industry proponents and countless community groups, it is quite likely that TC's would have disappeared in North America. There are a variety of reasons for the TC demise and most relate to the economics of the time. In the discussion which follows the various reasons will be set out and discussed.

Life Span

TC systems, when installed, could be expected to have a life span of twenty to twenty-five years. Many systems were pushed well beyond this point. Seattle's original system lasted for over thirty-five years, but at the expense of greatly increased maintenance costs. Figure 1.1-5 shows the life span of selected TC systems. At the end of the normal life span, which generally occurred when the systems were still operated by private corporations, the decision was made to minimize needs for capital funds and to purchase diesel buses to replace the TC's.

The poor financial position of many transit companies in the late 1950's precluded borrowing of sufficient funds to renew TC operation. In some instances the salvage value of the TC system was the down payment on replacement diesels. Lending institutions were also reluctant to finance TC vehicle purchases since there was a very limited resale market, whereas motor coaches could easily be sold in the case of loan default. Another factor was the favorable credit or leasing terms offered by major motor coach manufacturers. This minimized down payment requirements but did so at the expense of higher carrying charges.

Numerous systems fell into this category, with Calgary being the most recent. The system was installed in 1948 and converted in 1975, when the entire system was 27 years old. Similar situations occurred in Fort Wayne, Indiana, Duluth, Minnesota, Thunder Bay, Ontario, to name a few.

Figure I.1-4

Abandonment of Trolley Coach Systems, 1945-Present*

United States

Canada



Not Shown - One Abandonment 1940

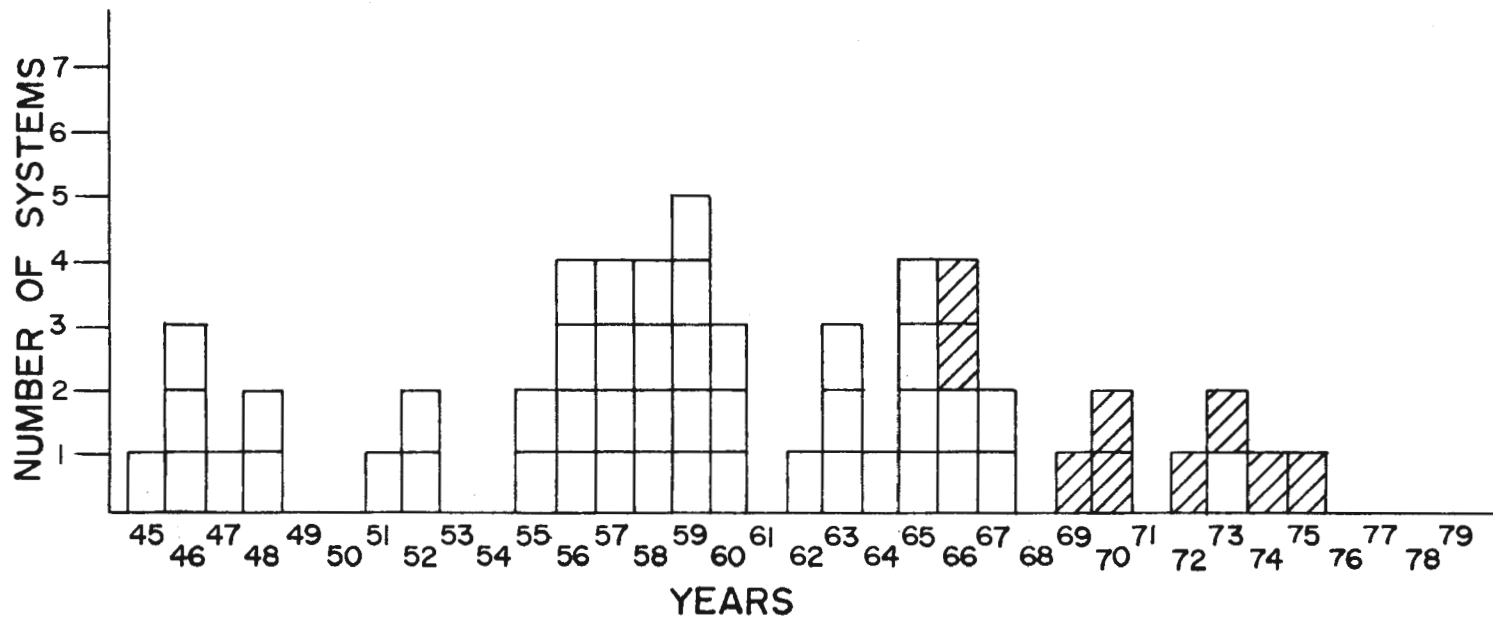

* Reference I

Figure 1.1-5

Life Span of Selected Trolley Coach Operators *

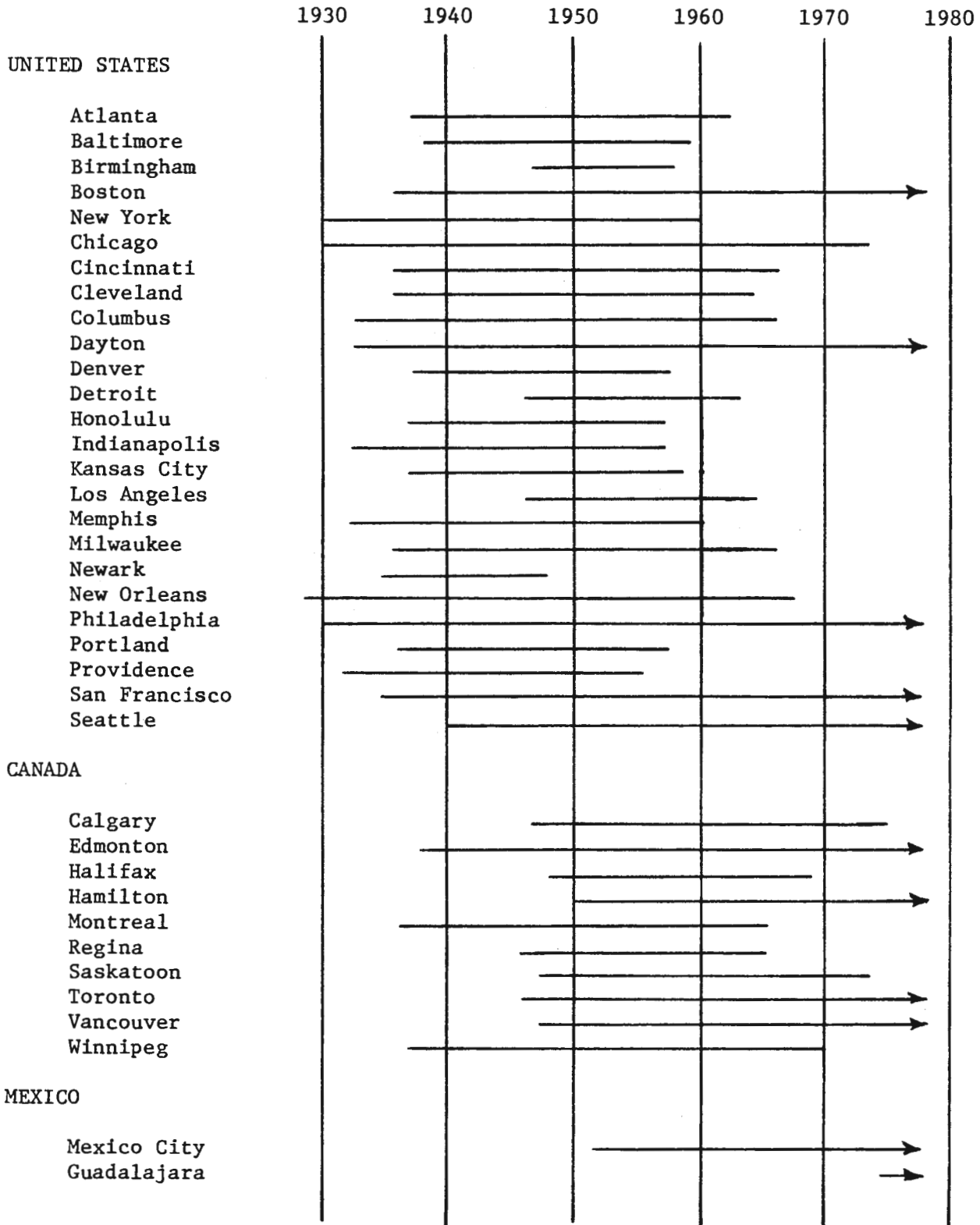

* Reference 3

Change of Management

The Securities and Exchange Commission forced many utility companies to divest themselves of all transit assets. This process started in the late Thirties and continued after World War II. The new transit managements were not committed to the operational philosophies of the older regime and a reevaluation of TC operation was often undertaken. This process included:

- o A reappraisal of overhead wire maintenance costs. Under utility company ownership the costs incurred in power conversion and distribution were often shared costs and arbitrary allocations were made to apportion them between the two companies. When separation occurred, these costs were clearly defined for the transit operator.
- o An objective appraisal of TC operation which was not clouded by preference for electric vehicles.
- o A determination of the need to protect their investment in TC operation. The decline in ridership after World War II reduced the market value of transit systems and many were sold for far less than book value. The new owners did have to contend with the same level of capitalization and had greater leeway to consider alternatives.

The ability to purchase transit operations for less than book value prompted several holding companies to purchase transit companies around the country. Some systems were purchased from utility companies, but many were also bought from private interests whose owners wanted to leave the transit business. The new management would often abandon fixed facility rail and TC systems using the salvage value to cover a significant portion of the purchase price. If the dismantled facilities had book life remaining, tax credits were generated and future earnings could be protected.

Highway Related Changes

The increased use of the auto gave rise to increased traffic problems in central city areas. Traffic engineers sought to correct these problems by installing one way street pairs. Although traffic problems were eased, transit systems were required to realign significant portions of the CBD overhead wire network. In some situations the easier and cheaper course was to convert TC lines rather than to expend funds to make the network changes.

In the 1950's and 1960's a similar situation occurred as highway planners pushed expressways through densely populated urban areas. Routes had to be changed necessitating relocation of overhead lines. It was not unusual to find that the new highway had completely obliterated the community served by a given transit route. Again the easiest course of action was to convert TC routes so affected.

Costs

As ridership and revenue declined, operators sought ways to reduce costs and remain profitable. The TC was usually a prime target.

Overhead maintenance costs - As indicated above true overhead costs were first realized by some operators when utility ownership was severed. Within limits, these costs are fixed and do not decrease as vehicle miles drop. The lower utilization caused the mileage base to drop and the cost per vehicle mile to increase. When comparisons based on cost per mile were made between TC and motorcoach, the TC's former advantage began to disappear.

Vehicle maintenance costs - The last major order of TC's was delivered in the early 1950's. When operators were making cost comparisons in the late Fifties and the years thereafter, the average age of TC's was usually greater than the motor coaches they were competing against. Maintenance costs are age sensitive and it was not unexpected to see comparisons which favored motor coaches. In this same period diesels were replacing gasoline engines in motor coaches. Diesels were much easier and cheaper to maintain further reducing the TC cost advantage.

Power costs - Many TC operators benefited from power rates that provided lower energy costs than motor coach operation could realize. This advantage was reduced when diesel motor coaches were manufactured. Diesels provided improved fuel consumption, and diesel fuel at that time was cheaper than gasoline. Motor coach fuel cost was further reduced when transit operators were excused from excise fuel taxes.

Replacement parts - The major builders of trolley coaches either left the field or went out of business by the early 1950's. Replacement parts became harder to obtain and more expensive. Operators were forced to cannibalize coaches or have parts manufactured locally at inflated prices. Fortunately, suppliers of overhead hardware and propulsion systems continued to offer spare material. The shrinking number of orders forced prices up as these items became specialty products for the firms involved.

Manufacturers' pressures - It has often been stated that during the 1950's some TC operators fell prey to the pressures exerted by the bus manufacturers. The pressure was generally economic in nature and affected the cost relationship of motor coach vs. trolley coach operation. The results are alleged to have witnessed both the selection of motor coaches over TC's when routine vehicle replacements were required, as well as premature conversions to TC's.

Changing Growth Patterns

The automobile made it possible to develop the suburban areas surrounding the country's cities. Transit properties, already fighting declining patronage, were also forced to follow riders to the suburbs. This meant extending existing lines and creating branches to reach the new residential areas. Unfortunately these extensions did not generate heavy service densities. When riders moved to the suburbs, essentially all but work trips were lost to the auto. Many operators were faced with either a lack of resources to extend services or with traffic densities that did not warrant an extension.

The result was to operate two modes in the corridor. Although this is practical in heavy corridors it often results in a greater number of vehicle miles than if only one mode were employed to provide the same level of service. Faced with this situation, the easiest course was to discontinue the trolley coach.

Performance

As discussed previously, the TC lost its performance advantage over time. The replacement of gasoline engines by diesels followed by the introduction of the 8V-71 diesel engine reduced the TC advantage. This has enabled many operators to replace TC's on a one for one basis with motor coaches.

Saleable Assets

While certain operators were still expanding their TC fleet, others were projecting that TC costs would exceed or at best equal motor coach costs. The desire of operators in such places as Mexico City, Dayton and various Canadian cities to purchase additional vehicles created a secondhand market which provided reasonable prices. Systems in Detroit, Birmingham and Indianapolis withdrew TC's prematurely because they could find willing buyers.

Standardization

During the late Forties and early Fifties, a motley assortment of vehicles was employed by transit operators. Many transit systems still operated all three surface modes. The greatest variety was often found in motor coach fleets. There was a mixture of gasoline and diesels which bore the trademarks of five major suppliers and numerous minor ones. In the quest for cost savings, fleet standardization became a major theme. Standardization witnessed the replacement of TC's, street cars and the older motor coaches with shiny new diesel motor coaches. TC's were very vulnerable in systems where they represented only a small portion of the total fleet. Although TC operation might be less costly on a per vehicle mile basis, the difference was small and could be overcome by the benefits of standardization. This was one of the major reasons for their demise in Brooklyn. The Board of Transportation was replacing all surface vehicles with the GMC 5100 series motor coach.

Surplus vehicles

Due to the decline in ridership many transit operators found themselves with a vehicle surplus. On large systems which employed only a small number of TC's, the surplus often grew to a number that was greater than the current TC vehicle requirement. The opportunity was at hand to completely replace TC's without the need to purchase new vehicles. Chicago found itself in such a situation in 1973 and all TC operation was suspended.

Background to Case Histories

Renewed interest in the trolley coaches began in 1969 when Toronto undertook a feasibility study that indicated it was economical to replace its existing fleet. Several additional systems soon followed with their own replacement programs, but others were convinced of the trolley coaches' continued liability and abandoned their operations. The last abandonment occurred in 1975, and the situation has since been static, with the exception of a new system in Guadalajara, Mexico.

The remaining U.S. and Canadian systems have all purchased new equipment and undertaken other system improvements. Table 1.1-6 below indicates the vehicles purchased since 1970. At the present time in this country, only Dayton is operating trolley coaches built before 1970. The most recent order of vehicles, those built by AM General, have incorporated a new propulsion control technology. A solid state chopper will replace the contactor system in use since the late 1930's.

Table 1.1-6

Trolley Coach Purchases since 1970 *

<u>City</u>	<u>Number of Vehicles</u>	<u>Manufacturer</u>	<u>Year</u>
<u>UNITED STATES</u>			
Boston	50	Flyer	1976
Dayton	65	Flyer	1974
Philadelphia	110	AM General	1977
San Francisco	343	Flyer	1976
Seattle	109	AM General	1977
<u>CANADA</u>			
Edmonton	37	Flyer	1973
Hamilton	46	Flyer	1972/1978
Toronto	151	Flyer	1972
Vancouver	50	Flyer	1974

* Reference 6

New routes have been installed by existing operators and others are planned. Hamilton has recently extended its King Street line and plans to extend the Barton line in the near future. Toronto recently converted its Bay Street motor coach line to TC and Seattle is rehabilitating and extending its network. San Francisco and Boston are presently considering several motor coach conversions and/or expansions of the trolley coach service.

The current activity is limited solely to existing operators. The resurgence of interest in this mode has not led to the installation of new systems. Portland studied the possibility of conversions in 1976, but the results were inconclusive, and the matter has apparently been dropped. A similar study was undertaken in Milwaukee and its conclusions favored retention of motor coaches. At this time it is not known if any other systems are seriously considering this mode.

A new system has been brought on-line in Guadalajara, Mexico. Local authorities had for some time been considering the need of underground rapid transit systems and actually undertook the construction of a short subway segment. Sufficient funds were not available to construct a full rail network and the subway segment was too short for single route operation. The trolley coach provided an answer, since it could operate both in the tunnel and then use surface operations to reach various parts of the city. The use of motor coaches would have required that the tunnel be equipped with a ventilation system. Initial service started in late 1976 and full operation commenced in 1977. Used vehicles were purchased from Chicago and extensively reconditioned.

The present status of the trolley coach operations in this country and Canada is best portrayed by reviewing the recent and past history of the present operators. The sections that follow provide a case study of each U.S. and Canadian operator. A similar study is also provided for Calgary, the last system to abandon trolley coaches in North America.

Boston

Growth, Development and Decline

Boston's association with the trolley coaches commenced in 1936 with the operation of a route between Harvard Square and Lechmere Station in the City of Cambridge. Following its successful operation on this route, several streetcar and bus routes in Somerville, Malden, Everett, Chelsea and Revere were converted to trolley coach operation prior to World War II. Following World War II the conversion program resumed and trolley coaches were introduced into new areas that included East Boston, Dorchester, Hyde Park and Roxbury.

At the peak of trolley coach operation, Boston employed in excess of 460 vehicles and was the third largest system in North America. Approximately 38 lines were equipped for electric operation. Due to Boston's topography and the layout of its rapid rail system, none of the trolley coach routes operated to the CBD. All routes fed rapid transit or streetcar routes, which provided the final link to the CBD. Trolley coaches operated in three distinct groups (the area north of the Charles River, Dorchester and Hyde Park). There was no interconnection among them.

The first major discontinuance of trolley coaches occurred in 1953 when a route in East Boston was converted due to the extension of a rapid transit line. In the late 1950's two additional lines were converted. These conversions may have resulted from a multi-mode equipment shuffle that was designed to free up streetcars for the new Riverside streetcar line.

Streetcars were made available by removing them from the Watertown, Waverly and North Cambridge routes that radiated from Harvard Square. Trolley coach service was then required on these routes because of the underground operation at Harvard Square. Since there was not a sufficient number of available trolley coaches, a number of routes had to be motorized.

The early 1960's witnessed a change in transit management and an almost complete withdrawal of trolley coaches. Between 1961 and 1963 all trolley coaches, excepting the new Harvard Square routes and the Huron Avenue route, were replaced with diesels. Only the tunnel operation spared these remaining routes.

During the next decade the remaining handful of routes continued to operate without major changes. In the early 1970's, it was clear that some changes would have to be made. The equipment was beginning to show its age and plans would have to be made for its replacement. Complete abandonment was considered, but tunnel operation again precluded the trolley coach removal. Plans were made to purchase 50 new Flyer trolley coaches, and delivery was taken during 1976. The coaches were delivered with an additional door on the left side to accommodate unloading in the Harvard Square tunnel station and along Aberdeen Avenue on the Huron Avenue route.

The Situation Today

The new coaches have been in service for over two years and they have experienced only minimal problems. They have been more reliable than expected, creating a surplus of about 15 vehicles. The vehicles are housed at Bennett Street Garage and a yard at North Cambridge.

Currently the vehicles operate on four routes, as shown in Figure 1.1-6. Service on Route 77 operates in conjunction with a diesel route of the same number. The trolley coaches operate locally over Massachusetts Avenue, while the diesels run express from North Cambridge to Harvard Square. On Sundays and holidays, Bennett Street Garage, which accommodates only TC's, closes for economy reasons. Surplus diesels operate the routes at these times.

The Future

The current situation will probably continue into the foreseeable future. The extension of the Cambridge rapid transit line to Arlington in the 1980's will require some changes in the surface transit system. The continued operation of diesel route 77 from Arlington Heights to Harvard Square will become redundant. Thought has been given to putting surplus trolley coaches in service by extending wires north to Arlington Center and abandoning diesel route 77 south of this point. Revision has also been considered in route 72 service, including the possibility of extension.

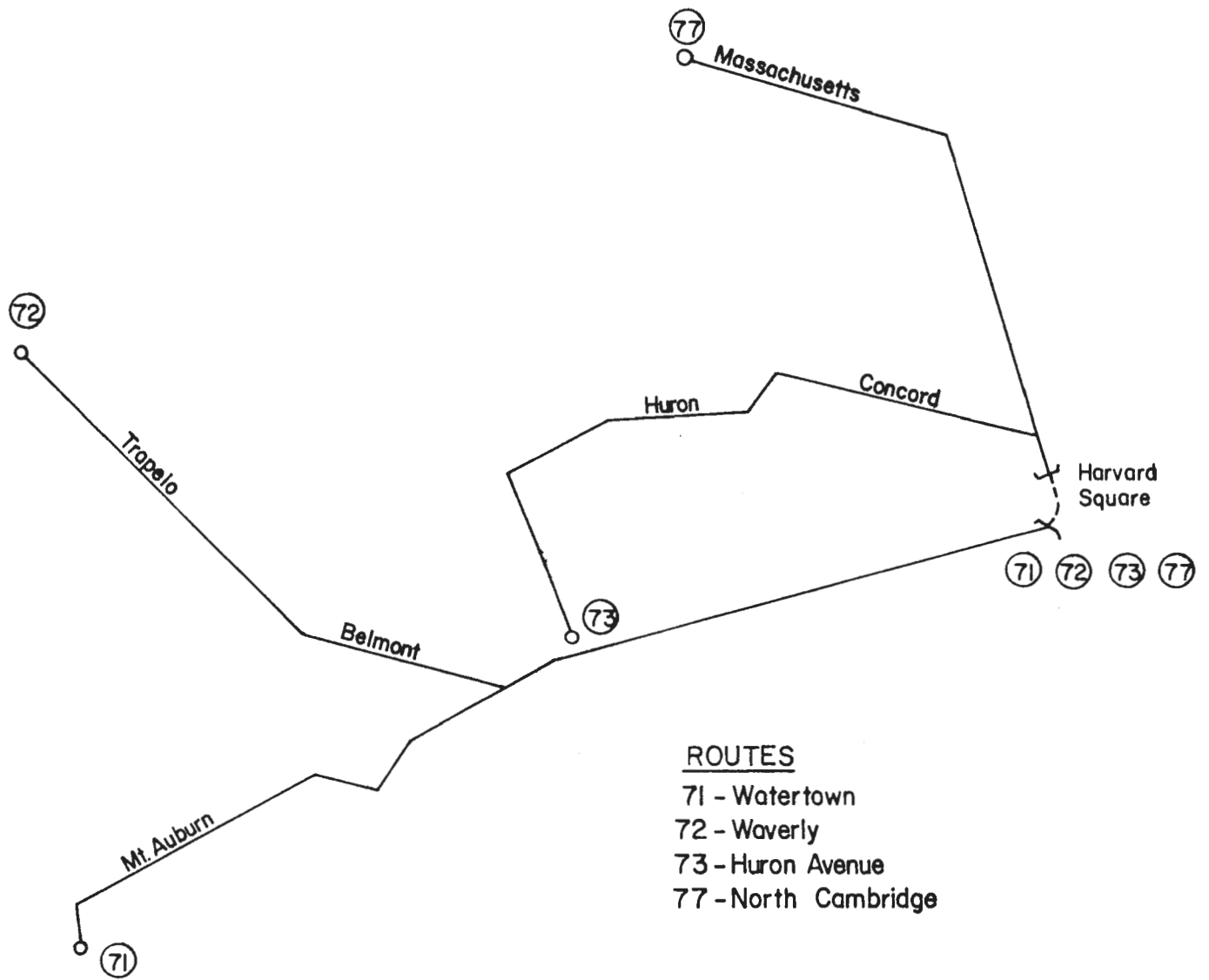

Figure I.1-6
 Trolley Coach Routes of Boston

- 1 - Third - Drexel
- 2 - Home - Fifth
- 3 - Lexington - Wayne
- 4 - Delphos - Hearthstone
- 5 - Salem - Far Hills
- 7 - Main - Watervliet
- 8 - Leo - Lakeview/Nicholas
- 9 - Cincinnati - Valley

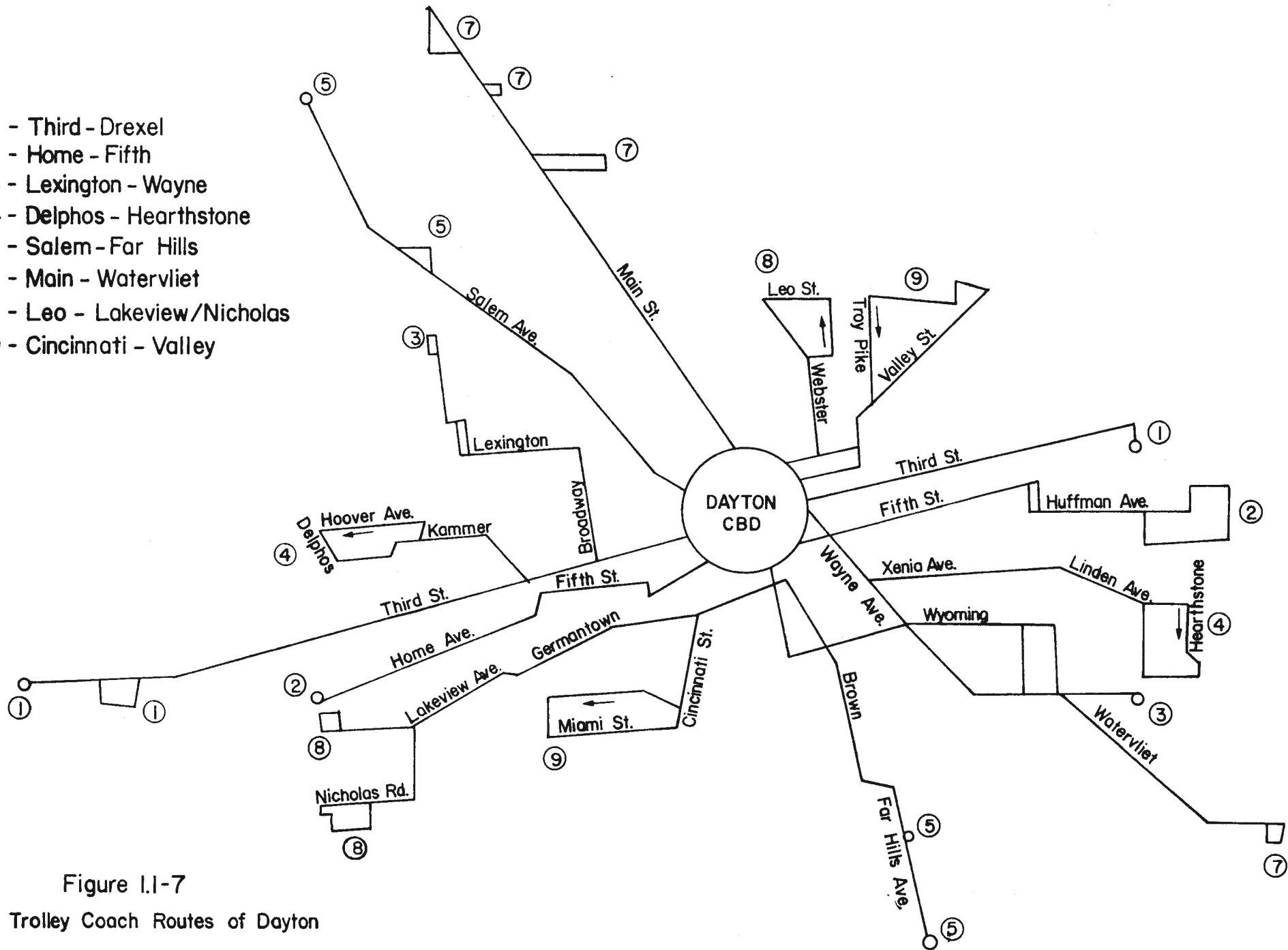

Figure I.I-7
Trolley Coach Routes of Dayton

For many years after this installation, the Philadelphia Rapid Transit Company and its successor, the Philadelphia Transportation Company, were primarily streetcar operators. Motor buses were used on new lines, but the basic streetcar system remained intact. No additional trolley coach routes were installed until 1941, when the Ridge Avenue route was converted from rail operation. This route was selected as it was on a very narrow two way street and was always a performance problem with streetcars. This route was followed in 1947 by the Tasker-Morris route, for similar reasons, and by the Wyoming Avenue route, which was done in order to extend the route over a section that never had streetcar service.

In 1950, the City of Philadelphia, owner of the Bustleton rail line, decided to reequip it with trolley coaches, in order to eliminate a capacity limitation caused by a section of single track. Presumably, this decision was partially based on the longstanding policy of utilizing electric vehicles on high volume routes wherever the infrastructure was available.

A similar decision was made on the Frankford Avenue line in 1955. This was unusual in that the diesel bus had by then been accepted in Philadelphia as a suitable substitute for the streetcar. However, in this case the city government was asserting its preference for electric vehicles over the preference of the privately owned transit system. This city preference was also asserted in the early 1960's, when it forced the PTC to install trolley coaches on Snyder Avenue, as a condition for abandoning the Ridge Avenue and Oregon Avenue routes. The City's position was that the Ridge Avenue route could be abandoned as the 1941 vintage coaches were due for retirement and a garage could be closed. Oregon Avenue, by modern standards, had insufficient volume for trolley coaches. However, a use would have to be found for all of the postwar trolley coaches, which the City felt still had several years of life. As a result, Snyder Avenue was converted from motor bus to trolley coach operation. This line was chosen as it was near an existing trolley coach garage, and having been converted from streetcar to bus only five years previously, still had most line poles in place.

Since 1961, the trolley coach system has remained unchanged. The existing routes are shown in Figure 1.1-8. The PTC was purchased by the Southeastern Pennsylvania Transportation Authority (SEPTA) in 1968 and the new management has remained committed to electric transit vehicles. SEPTA has been slow to modernize the trolley coaches and remaining streetcar routes because of funding problems as well as an initial decision to concentrate efforts on commuter railroad modernization.

The Situation Today

As has been mentioned, SEPTA is firmly committed to electric transit vehicles. The first of an order of 110 new trolley coaches was recently delivered. However, usage on the trolley coach lines has declined substantially in recent years, as has ridership on much of the rest of the transit system. Currently, the system requires only 71 trolley coaches for service, as compared to the 136 retained for service on the same five routes after 1961. These routes are still heavy by comparison with transit in most other cities.

Dayton

System Development

Dayton's first TC route was placed in operation in 1933 as a replacement for streetcar service. During the period prior to World War II seven additional routes obtained TC's. Unlike most cities the TC routes were operated not by one company but by five. This situation continued until 1941 when the fifteen year process of merging all companies into a single unit was begun. In 1947 the last two car lines were converted and Dayton was completely dependent upon the TC.

Approximately 200 TC's were operating on ten routes after the last conversions were made. The system's route structure became stable at this point and did not decline as was the case in other cities. During the 1960's the reverse was true and extensions were made to keep pace with the city's outward growth. Between 1962 and 1970, seven additions were placed in operation. Some of these additions required extensive lobbying on the company's behalf to overcome the objections outlying communities had with overhead lines. Only one major withdrawal of service occurred and that was required by freeway construction.

The rehabilitation and growth of Dayton's TC system can be directly attributed to two situations. First, City Transit, the system operator, had firmly embraced the TC. Through the efforts of its president, Mr. W.W. Owen, the company resisted various pressures to convert and adapted to changes in its operating environment. For example, the downtown routings and overhead facilities had to be restructured to conform with a new one way street pattern. Second, City Transit was able to turn the TC's national decline to its benefit. Vehicles and hardware systems were purchased for a fraction of their total original cost from other systems that were phasing them out. City Transit was able to replace its older coaches and extend service for less than the cost of a new diesel fleet.

The general decline in transit usage in the late 1960's forced City Transit into the familiar pattern of raising fares and cutting service. Despite these financial problems the company ordered one Flyer E700 and had the Toronto Transit Commission install electrical equipment from a retired coach. It arrived in 1971 and was dubbed the "1971 Trolley Bus."

The final solution to City Transit's financial problems was the formation of the Miami Valley Regional Transit Authority (MVRTA) which assumed control in November of 1972. Prior to the actual takeover there was a controversy over MVRTA's position on the future of trolley coaches. Newspaper articles stated a decision for diesel had been made but the authority refused to issue either a confirmation or a denial. Whether the articles were correct or if it was simply a maneuver to lower the cost of purchasing the TC system is not known. Clearly if diesels were to be employed the trolleys would be worth little more than scrap value. Regardless of the reasons for the controversy, several citizen groups came out in favor of retention.

The MVRTA moved quite quickly on the TC vs. motorcoach question. A public hearing was held during March of 1973 and the response was overwhelmingly in favor of TC's. In April MVRTA decided to purchase 25 new vehicles. The energy crisis intervened and the number of new TC's was increased to 64. The dilemma was not over for when the single bid from Flyer Industries was opened in late 1974 the asking price was 75% higher than MVRTA's estimate, \$104,961 vs. \$60,000. The Authority then decided to order only 40 TC's, but UMTA said it would have to solicit new bids. UMTA's bid stated it would increase the Federal grant to cover 80% of Flyer's quote for 64 vehicles. Resoliciting the bids would have delayed the arrival of new buses for several years. Wishing to avoid any further delay it was decided to accept Flyer's bid. Two years later the new buses were arriving in Dayton.

The Situation Today

Presently Dayton's TC network, as shown in Figure 1.1-7, is serviced by the 64 new coaches and 15 older coaches which had been retained. MVRTA's route network is unchanged, but the outer portions of many TC routes now have only rush hour service. MVRTA is a regional operation in name only. Many suburban communities are not part of the Authority and do not contribute to deficits. MVRTA may ultimately remove service in those areas that do not provide financial support. This situation also precludes extension of service to regional commercial centers which have drained business away from the CBD. Until the Authority becomes a true regional carrier the transit system will service only that portion of its market which relies on the CBD.

The Future

Maneuvering continues in the effort to transform MVRTA into a regional authority. Success is not in sight, but when it does come, the TC system must be extended if it is to retain its usefulness. The long term outlook for a system constrained from serving a new growing market is hardly optimistic. Rumors also persist from time to time that Route 1 will be extended and that additional vehicles will be purchased. The final outcome is a matter of wait and see.

Philadelphia

System Development

Philadelphia has the distinction of operating trolley coaches longer than any other city in North America. It had the only trolley coach line installed in the early Twenties that survived as a permanent part of the transit system: the Oregon Avenue line, started in October of 1923. Oregon Avenue was considered to be impractical for streetcar operation by the transit company due to the large amount of special trackwork that would be required to fit a streetcar line in with railroad spurs that already occupied much of the street.

Figure I.1-8

Trolley Coach Routes of Philadelphia

ROUTES

- 29 - Morris and Tasker Streets
- 59 - Castor Avenue
- 66 - Frankford Avenue
- 75 - Wyoming Avenue
- 79 - Snyder Avenue

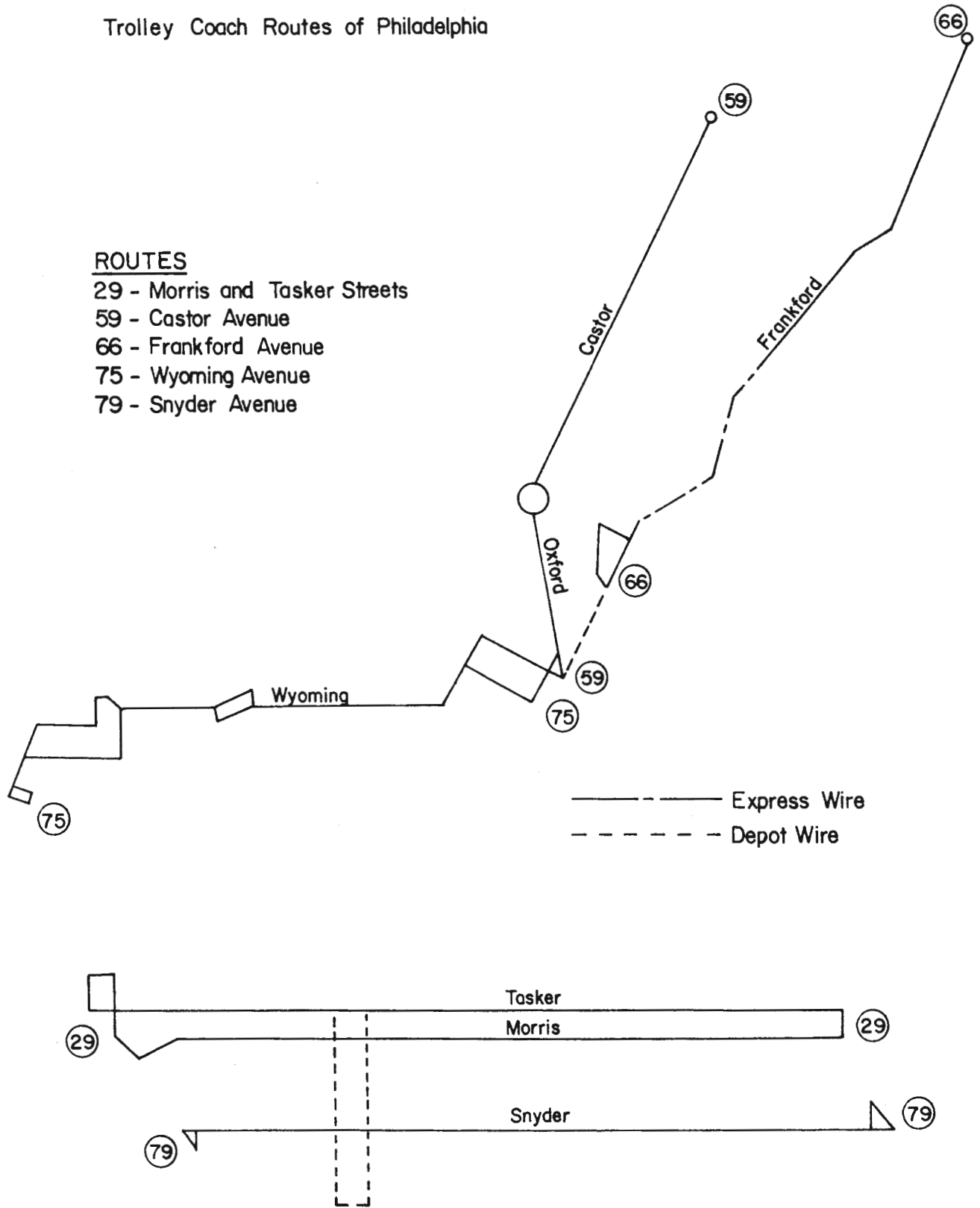

The Future

With 110 trolley coaches on order and only 71 required for service, there appears to be a substantial incentive to adding new routes. However, no firm plans are being made, and it is likely, based on recent Philadelphia history, that the status quo will persist for several years. The power system exists for a sizeable electric vehicle operation, so that route expansion would be relatively low cost.

Seattle

System Development

The first attempt to utilize trolley coaches in Seattle occurred in 1937 when the city sought to replace its aging street railway system. Replacement funds were to be raised through a bond issue but it failed at referendum and the matter came to a standstill. The status quo prevailed until 1939 when sufficient funds were raised to purchase 235 trolley coaches and necessary support facilities. The conversion program moved quite quickly with 28 trolley coach lines in operation by late summer of 1942. During 1943 and 1944, 72 additional coaches were purchased principally to meet traffic demands imposed by World War II. Following these purchases the system was essentially stable until the 1960's.

The Seattle Transit System (STS) started a campaign in 1959 to phase out the trolley coaches and replace them with motor coaches. STS sought to convince the public that trolley coach costs were higher than diesel costs, and that replacement would reduce the total cost of providing transit service in Seattle. The campaign was soon joined by a citizen committee called the Committee for Modernization of Electric Transportation (COMET), which sought to provide counter arguments. The views of STS prevailed and during August of 1963, 11 routes were converted. This move displaced about two-thirds of the total trolley coach fleet and left only the shorter inner-city routes in operation.

COMET took the issue to the public in the form of a ballot issue in 1964. They sought full restoration of the abandoned lines and attempted to convince the public that trolley coaches would prop up the financial losses STS was starting to encounter. The public failed to endorse COMET's viewpoint and STS's financial plight served to strengthen its conviction that all trolley coach lines should be converted. The ballot issue served to polarize the community into pro- and anti-trolley coach forces. It was during this time that such groups as the Seattle Chapter of Washington Society of Professional Engineers and the Taxpayer's Investigative Committee entered on the side of the pro-trolley forces.

Pro-trolley coach forces attempted to turn STS's financial plight to their advantage by claiming that the mounting losses resulted from prior trolley coach abandonments. Their message to the press and public was simple: bring back the trolley coaches and STS's financial problems would no longer exist. The city council in 1970 entered the controversy and expressed its desire that STS retain and refurbish the remaining trolley coaches. The council's position was without force since STS was a separate body insulated from political pressures. Several weeks after the council had taken its position, STS abandoned two additional routes.

Evidently frustrated by STS's continuing financial problems and its ability to act independently, the city council, late in 1970, took steps to bring the transit system directly under its control. Simultaneously, it commissioned a study to determine the fate of the city's remaining trolley coaches. The study recommendation struck a compromise between the opposing trolley coach forces. It advocated retention of the remaining routes and expansion of the system to approximately twice its current size. It did not recommend a return to the pre-1963 system sought by COMET and others.

Although the city had regained direct control of STS, the Municipality of Metropolitan Seattle (METRO) was positioning itself for a takeover of STS and other area transit operators. COMET was still advocating its proposals that also called for placing STS under the city light department. Both issues were brought to the public in a referendum vote in late 1972. The voters approved METRO's desire to assume control of the area's transit operations, but once again rejected COMET's proposals. It was not a total loss for COMET since METRO had pledged to retain trolley operations. They also had pledged to exclude diesels from any future motor coach purchases and would instead secure vehicles propelled by LNG or other non-polluting fuels.

After its takeover, METRO's engineering staff conducted numerous experiments to determine what steps should be taken to modernize its TC system. A Swiss standard articulated TC was borrowed and tested for several weeks. One of the older coaches was outfitted for battery auxiliary operation in conjunction with a Keipe automatic retriever system. Arrangements were also made to test the Kummeler & Matter overhead system, but unfortunately the test section was never completely installed.

The Situation Today

In 1973 METRO developed its initial programs to improve transit in Seattle. They included purchase of 50 articulated TC's, an expansion of the system, and purchase of an assorted number of motor buses. Unfortunately when bids were requested there were no respondents. In the interim, METRO purchased a fleet of diesel motor coaches, and was forced to renege on its original no-diesel pledge. Bids were again requested in 1974 for both TC and diesel articulated buses. Manufacturers did respond this time but the prices quoted for TC's were prohibitively high and only the diesels were purchased. In order to secure a better TC price, METRO and the Southeastern Pennsylvania Transportation Authority jointly solicited bids for a regular 40 foot TC. Bids were opened in March of 1977, and it was agreed to purchase 109 new TC's from AM General.

Concurrent with its attempts to secure new vehicles, METRO was finalizing plans to rehabilitate and expand the trolley system. After several iterations, the final plan was adopted in late summer of 1977. It is interesting to note that certain routes, such as East Madison Street, were considered for rewiring and then rejected due to community opposition. The final plan is shown in Figure 1.1-9.

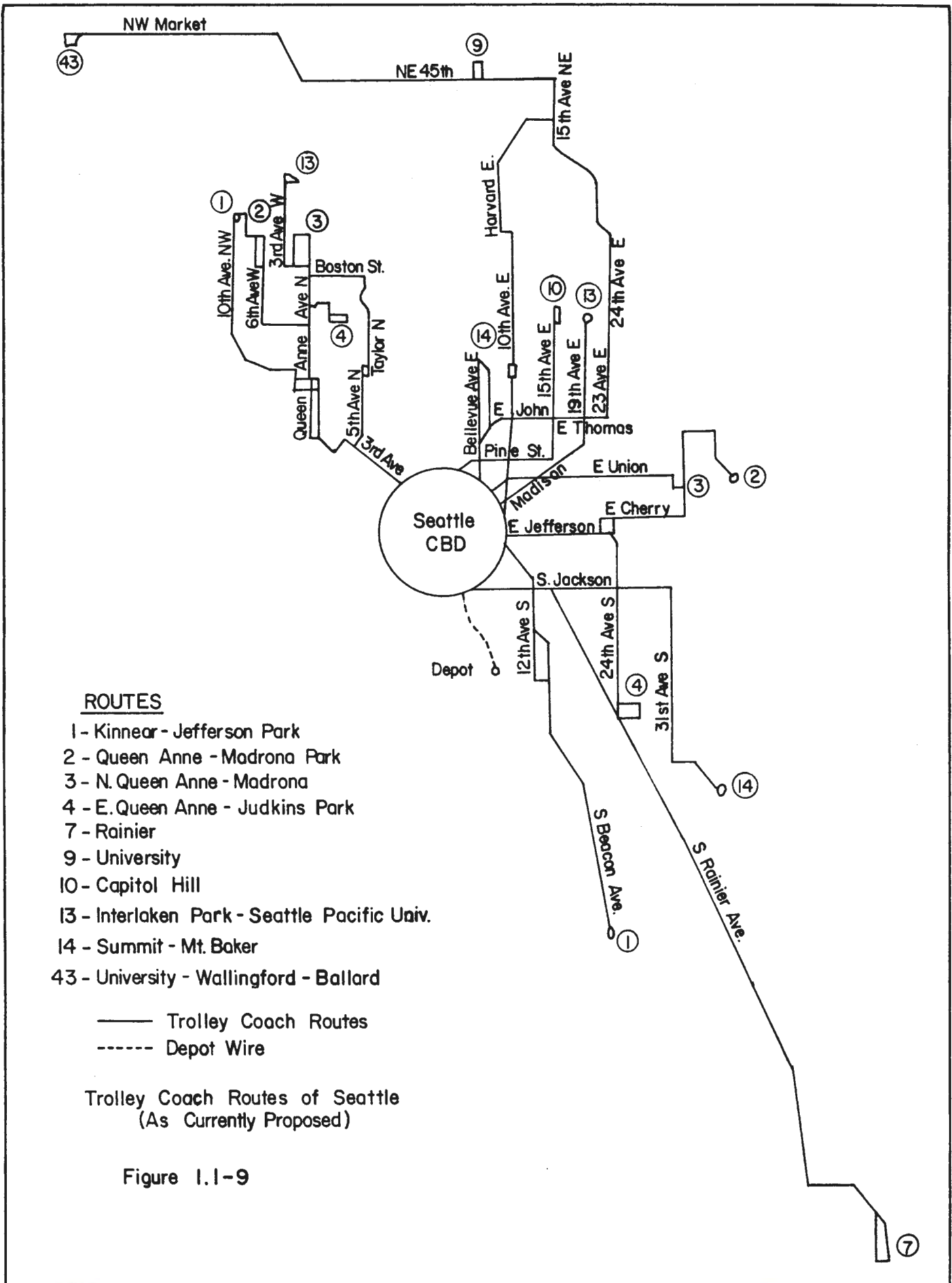

ROUTES

- 1 - Kinnear - Jefferson Park
- 2 - Queen Anne - Madrona Park
- 3 - N. Queen Anne - Madrona
- 4 - E. Queen Anne - Judkins Park
- 7 - Rainier
- 9 - University
- 10 - Capitol Hill
- 13 - Interlaken Park - Seattle Pacific Univ.
- 14 - Summit - Mt. Baker
- 43 - University - Wallingford - Ballard

—— Trolley Coach Routes
 - - - - Depot Wire

Trolley Coach Routes of Seattle
 (As Currently Proposed)

Figure I.1-9

METRO concluded that the best method for rehabilitation of its electrical system was to remove the old facilities and to install a completely new system. On January 20, 1978, all TC service was suspended. Shortly thereafter, contractors removed the existing power supply and contact wire system and proceeded to replace it with new hardware. It was METRO's initial desire to resume limited TC service in early 1979 with the arrival of its first new AM General vehicles.

The Future

At the time of this writing the new vehicles are being delivered and reinstallation of the electrical system is running behind schedule. Operation of the new system with new TC's is scheduled for late 1979 or early 1980.

San Francisco

System Development

Trolley coaches in San Francisco commenced operation in 1935 under the auspices of the Market Street Railway (MSR). The first line, 33 Ashbury, replaced a streetcar line which operated over 6% grades and incorporated a switchback operation. The TC provided a solution to a difficult operational situation. Although additional conversions were contemplated by MSR they never materialized. It was not until 1940 that Municipal Railway (MUNI) added another TC line when streetcar service on South Van Ness Avenue was converted.

The MSR and MUNI were merged in the last year of World War II. MUNI was faced with the task of both unifying the city's transit system and rehabilitating MSR's worn-out physical plant. After considering several options, MUNI decided to convert much of its street railway system to TC operations. Conversions started in 1947 with the Union Street Line which was merged with the South Van Ness Route to form Route 41. Thirteen additional routes were added during the next five years. When the Ocean Avenue Line was converted in 1952, the system reached its greatest size.

From that time until now the system has remained relatively stable. During the 1960's there were moments when the TC's future was in doubt. The advent of BART required MUNI to consider restructuring much of its surface system. The Northern California Transit Demonstration Report, issued in 1966, recommended that all TC lines except those on the hilly routes north of Market Street be converted to avoid conflict with BART construction. The idea generated considerable citizen opposition which led to the defeat of a bond issue that would have financed the conversion. In the same time period, TC routes on Sutter and Folsom Streets were temporarily converted due to the inauguration of one way streets.

MUNI made a decision in 1969 to retain all TC routes. Service on Sutter Street was reinstated in 1971 when new wire was installed on Post Street. MUNI also began considering the need for new equipment. The existing fleet was over twenty years old and suffered from deferred maintenance. In 1972 two Flyer demonstrators were acquired for tests.

The Situation Today

MUNI's experience with the two Flyer demonstrators led to orders for 343 new coaches which were delivered in 1976. The decision to purchase new TC's did not eliminate moves to curtail their use. Pressure was applied by Market Street beautification interests to remove all overhead wires at the time the street cars commence operation in the new Market Street subway. This would have required the conversion of all Market Street routes or their relocation to Mission Street. The first course of action would have greatly increased street noise and local pollution - hardly what the beautification interest really desired. The second would have removed transit service from the main commercial district and increased walking distances. MUNI was in favor of retention and generated a report that concluded TC's should remain on Market Street. The City Council agreed and voted not to make any changes. The current TC network is shown in Figure 1.1-10.

The Future

The existing power system generally dates from the days of initial installation and is badly in need of rehabilitation. MUNI has developed plans to completely modernize both the power conversion and distribution systems. A grant application to U.S. Department of Transportation has been filed to secure funds for this effort, to allow for system expansion and to reinstitute service on the southern portion of Route 41.

MUNI has just completed a comprehensive study of its system. In their report the consultants recommend a number of new TC routes plus other changes to improve route performance. The new TC routes proposed are:

- 24 - Divisadero
- 33 - Parker
- 55 - Sacramento (combined with 1-California)

Presently, MUNI's TC routes require 251 vehicles. Allowing for an 8 percent maintenance float, vehicles are available for expansion and new routes.

Edmonton

System Development

Edmonton operates the oldest surviving TC system in Canada. Prior to World War II, the Edmonton Radial Railway converted one of its street-car lines to TC's using Leyland vehicles imported from England. The route originated downtown, crossed the Low Level Bridge and terminated in South Edmonton. After World War II, the conversion program continued and within ten years four new TC routes were added. The street railway last operated in 1951.

Between the late 1950's and mid-1960's the system was fairly static although the original TC route via the Low Level Bridge and Whyte Avenue was discontinued in 1965. The TC system formed the backbone of the system during this period of time. Beginning in the 1950's and continuing

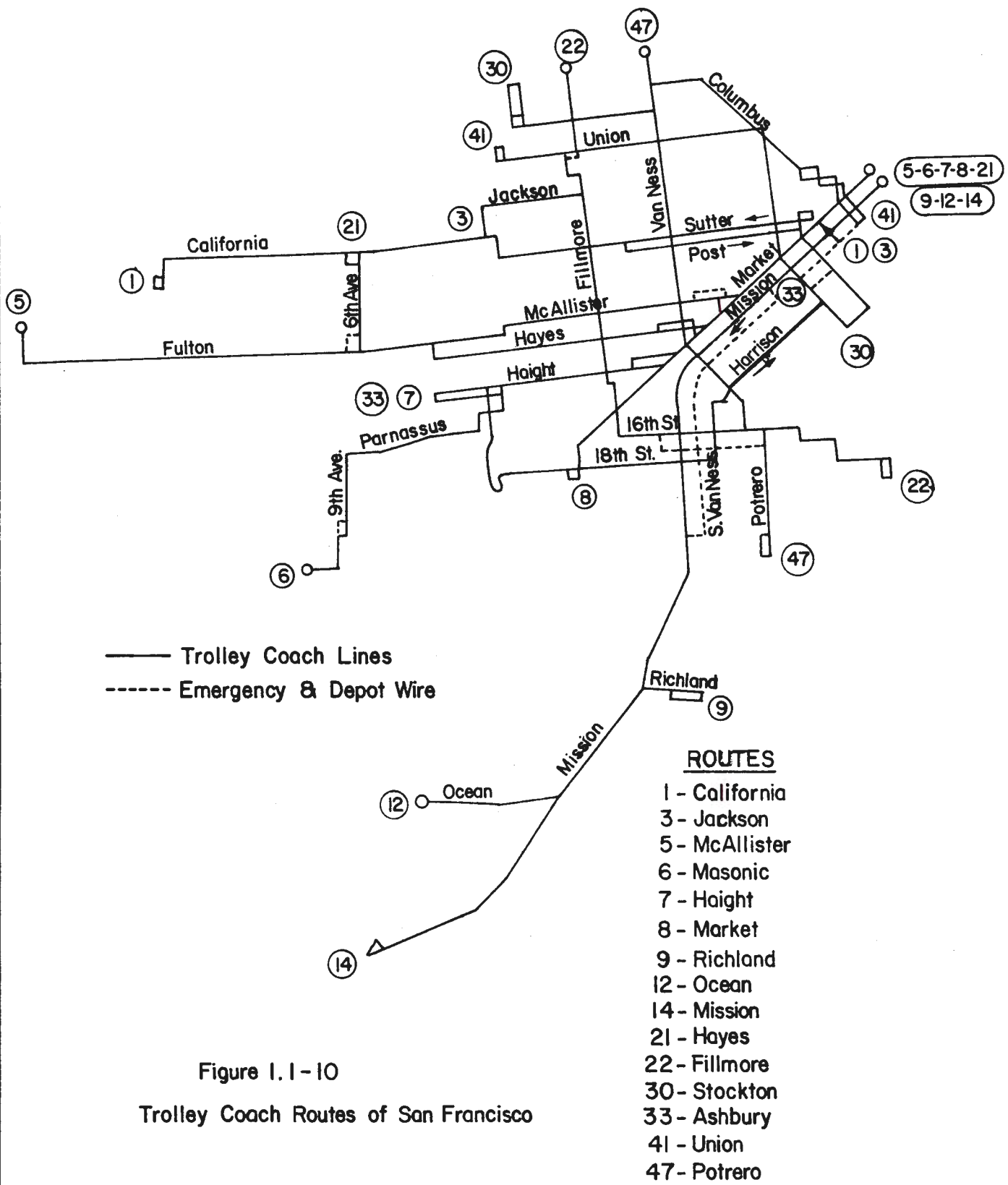

Figure I.1-10
Trolley Coach Routes of San Francisco

to date, Edmonton experienced a rapid rate of growth. The Edmonton Transit System (ETS) focused its attention on meeting the service demands that this growth generated. ETS's response was to initiate a suburban time transfer at regional transit centers. A transit patron would board a major trunk route in the CBD and would transfer at the center to one of a number of routes serving the surrounding residential areas. During peak hours express service is provided between the regional center and the CBD.

The TC was soon incorporated into this concept. During the early 1970's the western terminal of Route 1 at Jasper Place became a regional center. This was followed in 1975 by an extension of Route 5 on 124th Street and 114th Avenue to a center at Westmount. The newest center, South Gate, required the extension of TC service on 109th Street, 57th Avenue and 114th Street. Service over this route by TC Route 9 was begun in 1978. The existing route network is shown in Figure 1.1-11.

Two interesting situations developed as a result of the extensions of service to Westmount and Southgate Transit Centres. First, 114th Avenue, which was part of the Route 5 extension was not a through street. It was necessary to make arrangements with a local hospital to obtain a right of way across their property. The agreement reached provided the necessary right of way, on the condition that its use was limited to trolley coaches. General traffic and diesel coaches were excluded. The second situation occurred on 57th Avenue which is a part of the 9 route. This street had not seen transit service previously and local residents agreed to its use only if TC's were to be employed.

With the institution of Route 9 service on 101st Street north of the CBD, wire was placed on Kingsway and 106th Street to a terminal near Westwood Garage. Routes 41 and 42 were then relocated from 101st Street to the new route. Another milestone was reached in 1978 when ETS opened its new light rail line from the CBD through the Northeast section of the city to Belvedere.

To keep pace with the extensions ETS had previously placed an order for 37 Flyer E800 in 1973. Two years later they were all in service. A planned followup order of 38 coaches did not materialize.

The trolley coach has demonstrated in Edmonton that it can readily be integrated into a changing transit environment if the desire is present. The last and proposed extensions of TC lines to transit centers attests to this fact. The TC system was also easily integrated with the new light rail line. From a physical point of view the existence of a traction power distribution capability aided both the installation of light rail service and its continuing maintenance requirements. From a service point of view the TC system will feed the light rail line in the CBD and to a smaller extent at the 118th Avenue light rail station.

The Situation Today

The planning and development staff have endorsed the trolley coach and plans have been developed for further extensions. These plans include:

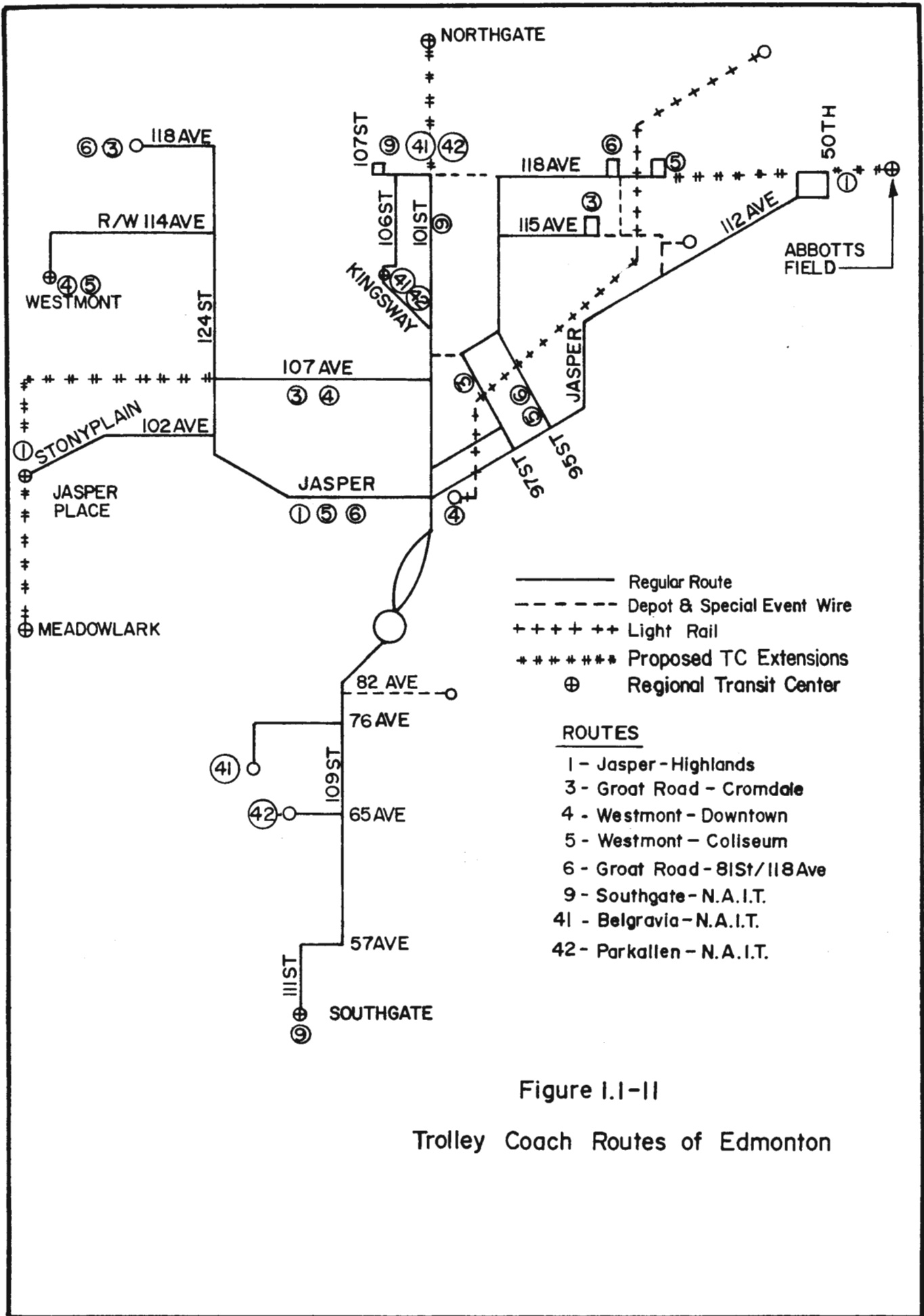

Figure I.1-II

Trolley Coach Routes of Edmonton

- o Placement of wire on 107th Avenue and 156th Street west of 124th Street, first to Jasper Place and subsequently to Meadowlake Road.
- o Extension of wire on 118th Avenue east to 32nd Street.
- o Extension of Route 9 north to Northgate Regional Transit Center. This is a somewhat longer range plan.

The maintenance staff has charted an opposite course of action. The number of TC's has continually shrunk as the older coaches are taken out of service due to age and deferred maintenance. Presently there are insufficient coaches to cover all routes, and diesels are required to meet all service requirements. First priority for TC's goes to Routes 1, 3 and 5. No TC services are provided on Saturday or Sunday. By the end of 1978 all old coaches were retired, leaving only the 37 new Flyers.

The overhead wires are also in need of repair. Many of the older wire sections in the city's Northeastern section are in poor condition and must be improved in the near future. Overhead materials have been purchased from Kummeler & Matter of Switzerland and some material was placed in service on Stony Plain Road.

The Future

Time has eliminated some of the options once open to ETS to improve and retain its TC system. The opportunity to re-equip when other systems were in the market has now passed. Inflation has increased costs and economically priced TC's may only be available by means of a joint order with Vancouver or by purchasing a nearly identical vehicle from the same manufacturer. It is quite evident that ETS cannot continue TC operation with only 37 vehicles.

Subsequent to the initial draft of this report, ETS has announced plans to purchase by means of a joint order with Vancouver, 100 new TC's and is currently seeking to locate potential suppliers throughout the world. The new TC's would be sufficient for existing needs and also allow for the extensions discussed above. The new vehicles plus the proposed extensions will once again make this TC the backbone of ETS's surface system.

Vancouver

Growth and Development

Vancouver, like many Canadian cities, did not seriously consider the conversion of its street railway systems until after World War II. British Columbia Electric Railways (BERC), the operator of Vancouver transit services in that era, announced a program in 1948 to convert practically all streetcars to trolley coach operation. Like many other operators, BERC found itself with a deteriorated track network and a power distribution system that was adaptable to TC operation. Late that

year the first trolley coaches were placed in operation. The system continued to grow and by 1953 all but one car line had been converted. The final conversion occurred in 1955 when all local rail operations ceased.

At its peak the trolley coach provided service to all major routes in Vancouver proper, except the McDonald/Knight line. Over 350 vehicles were purchased to accommodate traffic on these lines. The system has remained substantially unchanged up to the present time. One route was given over to diesels in 1966 because the University of British Columbia (UBC) would not allow overhead wires to be erected on campus grounds. On the other hand, the Cambie line was extended in 1970 to replace a diesel shuttle. The most significant improvement in recent years occurred in 1977. At this time, trolley coach operations were incorporated in a shopping mall on Granville Street. Practically all trolley coach routes in the CBD were switched to the mall route.

With the exception of two diesel routes, all service on the Granville Mall is provided by trolley coaches. Those familiar with similar malls in Minneapolis and Portland would notice a significant decrease in noise and pollution. The inclusion of trees minimizes the usual intrusion of the overhead wires.

Presently, British Columbia Hydro and Power Authority operates 19 routes and approximately 285 trolley coaches. With the exception of two crosstown routes, all are through routed radial routes. A map of the current system is shown in Figure 1.1-12. The route on Hastings East includes a section between Main Street and Kootenay Loop, which is equipped with four sets of wires to accommodate express service.

The Situation Today

Routing and equipment problems constitute two main problems that must be dealt with in the immediate future. Currently, four of the system routes (34, 9, 19 and 41) terminate at the Eastern boundary of the city. This has resulted from the city of Burnaby's refusal to allow overhead wires. For years this was not a serious drawback, but with Burnaby's development the arbitrary ending of these lines at a political boundary has made little sense. It is now an operational obstacle and an impediment to quality service. The same situation exists with routes (9, 4 and 41) that terminate on the western boundary between the city and the University's Endowment Lands managed by UBC.

The following extensions are in the planning stage and would address most of the routing problems indicated above:

- o Blanca to UBC via University Boulevard - This extension will permit the through operation of the 4 Fourth and 9 Broadway TC's to the University providing better direct service and eliminating the duplication of service in the West Broadway area. The 14 Hastings diesel bus, presently through worked with the 10 Tenth (UBC), can become a trolley coach route, since all wire is in place.

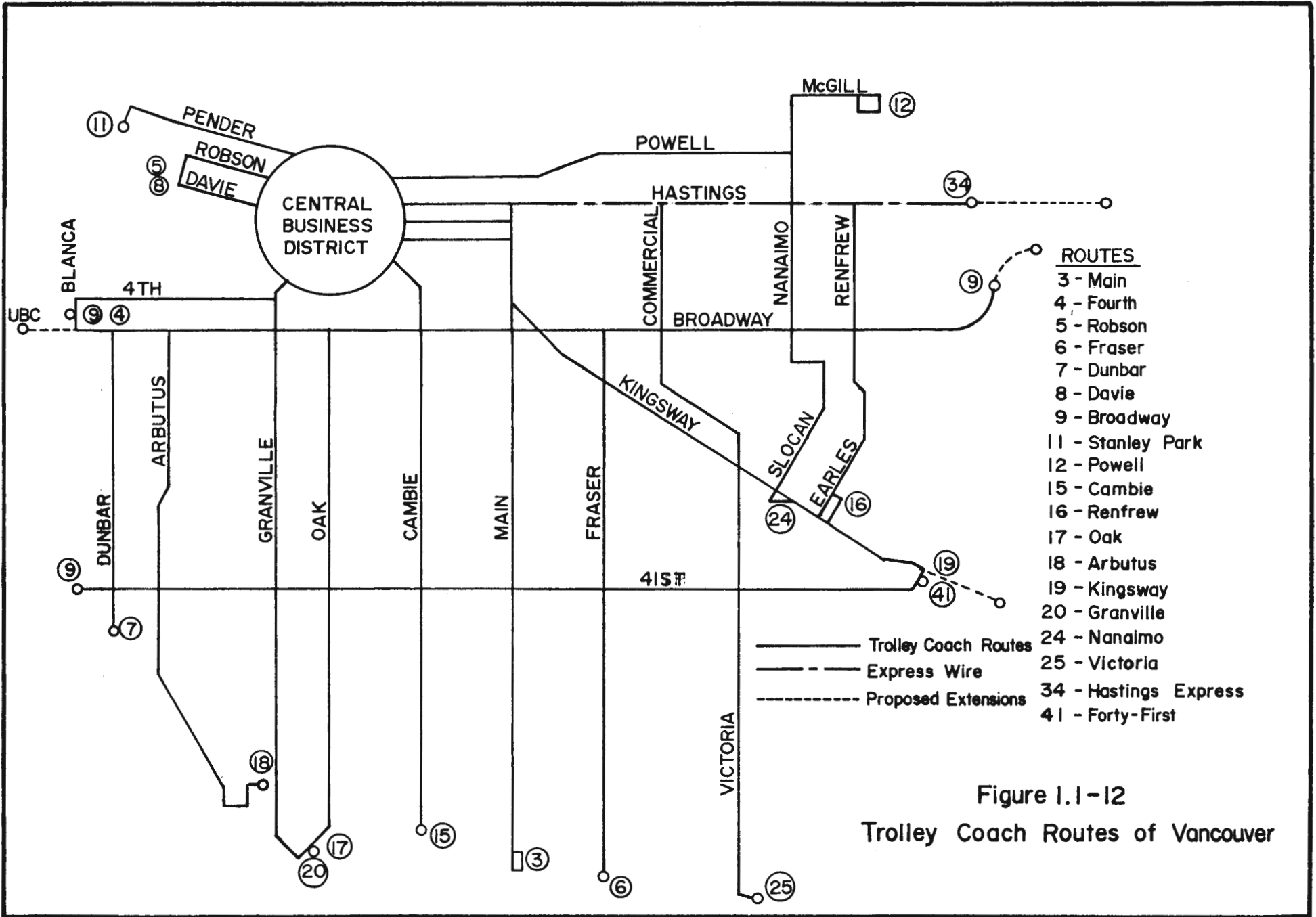

Figure I.1-12
Trolley Coach Routes of Vancouver

o Broadway East extension from Boundary Road to Brentwood Mall - This logical extension would eliminate the short motor coach shuttle that currently requires a transfer to connect with several major routes and a patronage generator at Brentwood Mall.

o Hastings Corridor - An extension east from the congested Kootenay Loop to the vicinity of Sperling will provide a logical focal point for North Burnaby routes and a terminal point for off-peak suburban services.

o Metrotown (Burnaby at Kingsway and Willingdon-Nelson) - The 19 Kingsway and 41-41st Avenue trolley coaches now terminate at Joyce Road close to the city boundary. The development of the Metrotown shopping area will require the extension of these routes.

The current fleet includes most of the vehicles that were originally purchased in the late 40's and early 50's. There have been several purchases of secondhand TC's, but the only major purchase in recent years occurred in 1974 when 50 Flyer Coaches were purchased, employing remanufactured propulsion equipment. The fleet is impeccably maintained when comparisons are made with transit properties in this country, but failure rates during the infrequent snows are high.

A decision was made in 1979 to retain the trolley coach network, purchase 150 new 40' TC's with options for 70 more, and retrofit the 50 1975 Flyer TC's with chopper controls. A study of articulated trolley coaches and route extensions will follow. The economic study that led to this decision indicated trolley coaches had a 12-20 percent life cycle cost advantage over diesels with probability that future oil prices would increase this advantage.

BC Hydro has conducted several demonstrations in recent years in order to define their equipment needs. Together with Seattle METRO, a Swiss articulated TC was brought to North America and demonstrated on a Brown Boveri simplified chopper propulsion control system. This system has provided smoother operation and consumes 15-25 percent less power, depending upon application.

The overhead wire system appears to be in good condition when comparisons are drawn with other systems. Many curves are strung using wood strain insulators, a practice not commonly encountered today, which accommodates a faster than normal operation. Coaches trailed on the Granville Bridge and other portions of the system were often clocked at or over 40 mph/64 kmph; a true testimony of the condition of the overhead lines.

Transit in Vancouver has been an anomaly for many years being operated by a Provincial Crown corporation, British Columbia Hydro and Power Authority, with no municipal investment. Transit deficits were first experienced in 1971 and have rapidly risen to over \$50 million in 1978. These are borne by BC Hydro and thus subsidized by electric power and natural gas consumers with the exception of some Provincial provision of capital and operating funds. New legislation was enacted

in 1978 setting up the Urban Transit Authority of British Columbia (UTA), which will jointly plan and fund transit with the various municipalities. Transit operations will be contracted out in each of the various BC cities to a low bidder, in a three-party agreement between the UTA and the municipality(ies). However, it is impractical to expect competitive bids on as large a system as Vancouver, and separate legislation was enacted in 1979 to divest transit from BC Hydro to a new Crown Corporation, "Metro Transit Operating Company." The new arrangements are expected to be in full effect by late 1980.

In the meantime the UTA Board has approved the retention of the trolley coach network and the fleet replacement based on strict economic grounds of lower life cycle costs. The 150 new trolley coaches, together with the 50 1975 Flyers retrofitted with modern controls, will constitute 70 percent of the fleet. Replacement of the remaining old TC's will depend on the outcome of studies on articulated TC's and route extensions, plus the current LRT study which, if implemented, could reduce the service needed on certain trolley coach routes.

In the longer term, examination of further route extensions and diesel route conversions may be made, and consideration could be given to truncating suburban diesel routes during off-peak hours, transferring passengers onto trolley coaches. Economic savings would result, albeit with impairment in the quality of service for some passengers.

Toronto

System Development

The first TC route appeared in Toronto in 1921, shortly after the Toronto Transit Commission (TTC) was formed. TC service was installed on the Mt. Pleasant route since the degree of development did not require streetcar capacities. The level of development continued to increase and in 1925 streetcar service was installed.

TC's did not make a reappearance until after World War II. During 1947 TTC converted three heavy crosstown rail routes, Lansdowne, Annette and Ossington. This was followed in 1948 by the Weston Line conversion. In 1954 the North Yonge car line and Nortown Bus Line were converted to TC's. The last conversion, until the present time, occurred in 1966 when the Junction Line was formed by converting the western end of the Dumas car line. During this period of time, TC route changes were also made to accommodate the growing subway system. The TC was easily adapted to the needs of the rail system, and many stations are served by TC routes acting as feeders.

In 1969 the average TC fleet age was in excess of twenty years. TTC was actively considering their replacement and commissioned an in-house study to determine the merits of TC's vs. motor coaches. The study was completed in October and it concluded that TC's were less costly to operate than motor coaches. TC costs were found to be 28.5% or 6.39 cents per mile less than motor coaches.

This report soon led to a decision to purchase approximately 150 new TC's. Unfortunately there were no manufacturers actively soliciting orders. TTC sought to encourage potential suppliers by offering to purchase prototypes. It was felt that this approach would provide the experience necessary to build TC's and improve supplier interest. Arrangements were finally made to purchase two prototypes, one to be built by Western Flyer (presently Flyer Industries) and the other by Robin-Nodwell. The latter firm subsequently withdrew and the TC's were built by Flyer.

Toronto thus initiated the trolley coach renaissance in North America, which soon spread to other Canadian and U.S. cities. TTC's approach involved rehabilitating the electrical equipment, i.e., motors and control equipment, from the older coaches and reinstalling it in new bodies. It was felt that the electrical equipment had many years of remaining life and that its reuse would significantly lower the cost of the new fleet.

The new TC's entered service in 1972. Shortly thereafter one of the busiest TC routes, North Yonge Street, was withdrawn when the Yonge Street subway was extended over its route. This move created a surplus of 35 vehicles, but plans for their reuse were quickly formulated. Initially it was thought that TC's would replace streetcars on certain routes as this mode was gradually withdrawn. The initial conversion would have placed TC's on the St. Clair route. Citizen protest forced TTC to drop its streetcar withdrawal plans and new steps were required to find a home for the surplus TC's.

TTC did manage to convert its Rodger Road car line and replace it with a branch of the Ossington TC route. This conversion required only two additional TC's and barely made a dent in the available surplus. In 1975 plans were made to convert the Bay Street Motor Coach Line to TC and this was accomplished in 1976. In 1977 TTC was faced with extensive track and bridge work on the Mt. Pleasant end of the St. Clair route. Rather than incur the costs associated with this work, the route east of Yonge Street was converted in 1977 returning TC's to their original route in the city. This last expansion of the TC network also occurred in 1977 when the Ossington route was extended one-half mile to the new Spadina subway.

The Situation Today

Presently TTC is experiencing a major maintenance problem with the new fleet. The problem is structural in nature and principally relates to the following facts:

- o The fleet was one of Flyer's first major orders, and
- o Road salt has had seven years to work on the vehicles' tubular frame.

It is also felt that the problem is unrelated to the type of propulsion. A map of the current system is shown in Figure 1.1-13.

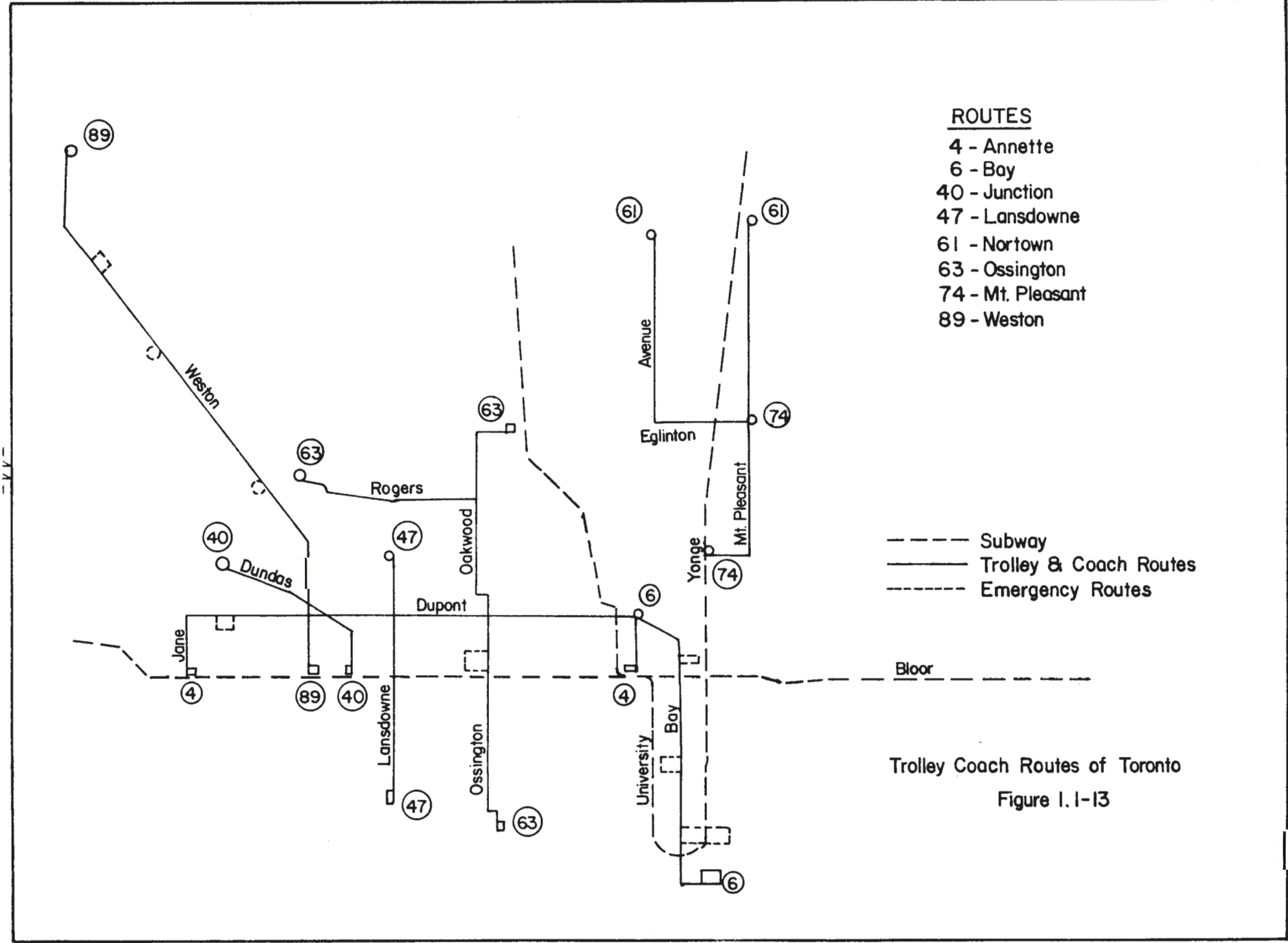

ROUTES

- 4 - Annette
- 6 - Bay
- 40 - Junction
- 47 - Lansdowne
- 61 - Nortown
- 63 - Ossington
- 74 - Mt. Pleasant
- 89 - Weston

- Subway
- Trolley & Coach Routes
- - - Emergency Routes

Trolley Coach Routes of Toronto
Figure I.1-13

The Future

Upon resolving the current maintenance problem, TTC will be in a position to consider a modest conversion to TC. Presently there are about 18 surplus vehicles that could be put to work on a short high density route or on a route extension. The decision to retain and improve the streetcar network will in all probability greatly limit the potential for future major conversions.

Hamilton

System Development

Hamilton was one of the last cities in Canada to embrace the trolley coach. In 1950 Hamilton Street Railway (HSR) converted its Cannon Motor Coach Line to TC operation. During the following year streetcars were withdrawn on both the King and Barton routes and replaced with TC's. During the ensuing years, each line was extended eastward to accommodate new development.

Following Toronto's lead, Hamilton was the second system to purchase new TC's. In 1972 HSR ordered 30 Flyer E700 coaches that were fitted with remanufactured electrical propulsion and control equipment. Deliveries were made in 1972 and 1973 and a number of the older Canadian Car and Foundry/Brill TC's were retired.

HSR contemplated further extensions to its TC system in the early 1970's. The city's developed area was continuing to extend beyond the three TC routes, requiring the institution of motor coach extensions to serve these new areas. HSR commenced planning an extension of the King TC route in 1974 that would provide single line service to the city of Stoney Creek. Construction of the overhead and a new substation started in 1975. Problems immediately arose that were to delay the opening of the new route for more than two years. Agreement could not be reached with Stoney Creek as to the location of the route's new terminal. The land selected by HSR was rejected by the local council. Certain council members also voiced concern that the overhead wires would be an "eyesore" and that TC's were not as "nimble" as motor coaches. HSR finally purchased land at the Hamilton city line and installed a loop at that location cutting short further argument. Service was begun on September 4, 1977.

In the Fall of 1977, HSR announced plans to purchase 16 Flyer E800 coaches. The new coaches were to replace older coaches and to allow an extension of the Barton line. All deliveries were completed by the Spring of 1979.

The Situation Today

HSR is currently in the process of extending the Barton Line to the city line in order to replace an existing motor coach shuttle. Owing to problems that developed during the King extension, the Barton line will not serve Stoney Creek. It is presently thought that the new line will enter service later this year. A map of the current system is shown in Figure 1.1-14.

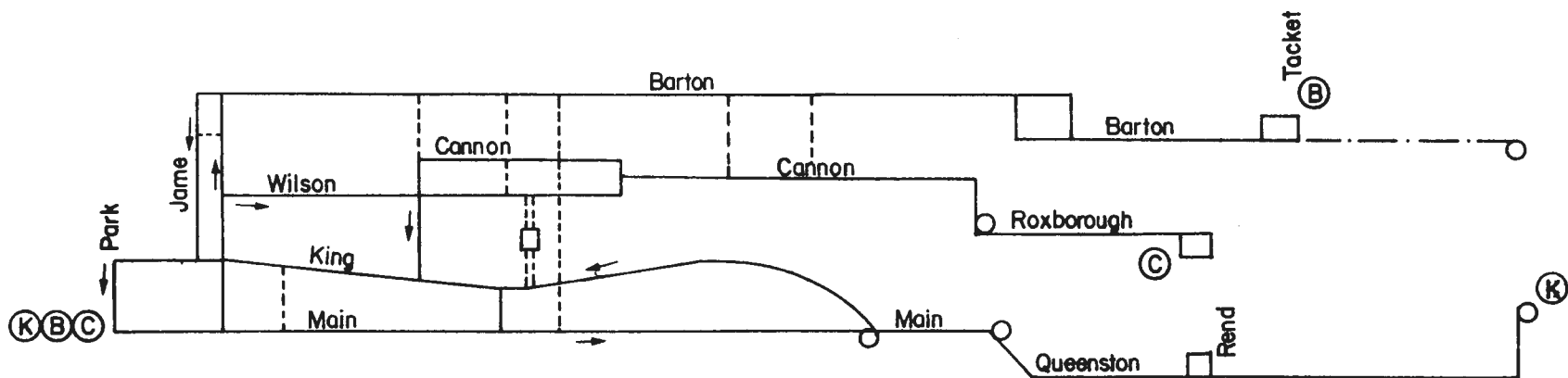

K - King East
 B - Barton
 C - Cannon

————— Trolley Coach Lines
 - - - - - Depot & Emergency Wire
 - Barton Extension Now Under Construction

Trolley Coach Routes of Hamilton
 Figure I.1-14

The Future

TC's in Hamilton will enjoy a safe but somewhat static future. HSR does not contemplate the conversion of any motor coach routes but the King Line could be extended if the problems with Stoney Creek can be resolved. Indications are that the Cannon Line might also be extended a short distance to effect a tie-in with the King Line.

Calgary

System Development and Decline

1947 was the first year for trolley coach operation in Calgary. The Calgary Municipal Railway and later the Calgary Transit System (CTS) embarked on a program to convert all rail routes to either TC or motor coach. Three years later, in the latter part of 1950, all rail operations ceased. At this point, eight TC Lines were in operation.

Starting in the 1950's and continuing to-date Calgary has been a growth city. The TC system kept pace with numerous extensions. To augment the original 60 coaches, 25 new and 20 secondhand coaches were bought. The need to expand continued and CTS soon had all of its TC's committed. At this point it appears that certain routes were abandoned to permit the extension of others. This process went forward with each conversion and extension providing a net loss for the TC system. During the mid-1960's a major portion of the TC network was abandoned. The remaining three routes (Routes 2, 3, and 7) retained 51 vehicles, slightly less than one-half of the total fleet size.

Following the system's contraction several additional extensions were made. The last extension was made in 1970 on Route 3. CTS began to raise questions about continued TC operation and in 1973 commissioned a report to settle the TC's fate. The decision was rendered in the latter part of the year and it called for cessation of all TC operations by 1975. All service north of the Bow River was converted in 1974, due to bridge reconstruction, and finally, with only a few hours advance notice, all service was abandoned March 8, 1975.

Reason for Curtailment

There were a variety of forces at work which finally culminated in a decision to end all TC service. These points are as follows:

- o Calgary is a dynamic city which has grown quite rapidly since the early 1950's. The route network has not been static but has had to adapt to the constant outward growth of the city's developed area. The TC system kept pace for a time, but by the mid-1960's major extensions were required. Route 1, for example, has more than doubled in length since conversion to motor coach. The trolley coach proved to be too inflexible to meet the system's changing needs.
- o The cost of the trolley coach exceeded that of the motor coach. The 1973 report indicated that motor coaches had a 6.3¢ per vehicle mile operating cost advantage.

- o The TC system was 23 years old in 1973 and was in need of substantial improvement. The vehicles would soon require replacement, and the power system needed refurbishing. These improvement costs would add 5.1¢ per vehicle per mile above the cost of new motor coaches.
- o This TC operation had become a much smaller portion of the total transit operation. In 1973 the TC's accounted for only 20% of the total fleet and about 17% of the total annual vehicle miles.

It is probably fair to say that no single problem led to the TC's downfall, but collectively their weight was force enough to cause complete abandonment.

The European Experience

Trolley coach technology developed in Europe at about the same time it did in this country. The earliest installations occurred just after the turn of the Century. European transit systems quickly endorsed the new mode, unlike their U.S. counterparts, and numerous systems were in operation by 1910. England had several operational systems at this time and petitions were on file for further installations. Italy had over 50 TC route miles, of which 15 had been in service since 1902. The Italian government so liked the new technology that it subsidized the operation of trolley coach lines in areas that did not have rail or streetcar service. TC systems were also known to be operating in Germany, Austria, Norway, France, Switzerland and Hungary. Permanent installations appeared much earlier in some European countries. England, installed 18 systems during the 1920's and all but four lasted until the 1950's. There was also a great deal of activity following World War II. Over 40 new systems commenced operation in Germany during this time. Many of these systems were no doubt replacing street railway lines destroyed during the war.

The Fifties and Sixties witnessed the withdrawal of many systems. Conversions in England proceeded at a fairly quick rate. When the Bradford system closed in 1972, all trolley coach service disappeared from the British Isles. The systems in Germany once numbered over 70 and by 1977 only six remained, three in West Germany and three in East Germany. Italy has retained many of its TC lines, but a number are relatively small systems and almost all are now in need of immediate upgrading. Switzerland has retained virtually all of its trolley coach operations and new Swiss standard vehicles are being purchased to upgrade the country's fleets. Other West European countries, such as Austria, France, Greece, Netherlands, Norway, Portugal and Spain continue to operate a small number of TC systems.

Little is known of the early history of East European trolley coach operations, but it is probably quite parallel to that experienced in the West. The number of systems seems to have remained constant in recent years, with two exceptions. East Germany has been withdrawing its trolley coach services while the Soviet Union has installed new systems and greatly expanded those previously established. It has been estimated that over 20,000 trolley coaches are in daily use on Russian systems.

The current direction in some of the countries where the TC continues to operate is set out below.

Austria - The trolley coach serves three cities. Two of these cities, Kapfenberg and Salzburg, have been purchasing new vehicles from Graf and Stift. Former TC routes have been reconverted in Kapfenberg and new routes have been initiated in Salzburg. The third city, Linz, plans to withdraw trolley coaches in the near future for economic reasons.

Czechoslovakia - The number of systems has been static in recent years, but extensions are made as traffic warrants. Current plans called for Skoda to construct 80 new TC in 1978 and 140 for 1979. This represents about 15 to 20% of the country's total TC fleet. A new chopper propulsion control system will be incorporated in the 1979 deliveries.

France - There are presently five TC operators in France. In 1978, based largely on environmental considerations, Grenoble, Lyon and St. Etienne decided to rehabilitate their systems. The three cities ordered 185 of the new Berliet ER100 trolley coaches. Recently Marseille placed an order for 50 ER100 and will reopen a former TC route when delivery has been accomplished.

Greece - The city of Athens has just received an order of 124 Russian ZIU-682 trolley coaches. These coaches will be employed on new extensions and to replace motor coach service.

Hungary - The Budapest system has purchased a fleet of Ikarus 280 articulated and Russian ZIU-682 two-axle trolley coaches. One motor coach route has been converted and others may follow.

Italy - The rebirth of the trolley coach has barely been noticed in Italy. This country has more systems than its western neighbors, but they are small and badly in need of rehabilitation. Many cities have overhead networks in place, but lack both serviceable vehicles and sufficient funds to enter the equipment market. Milan's Azienda Transporta Municipal, the largest TC operator in Italy, has recently stated that it will retire all TC's except the articulated vehicles that work on circumferential routes 91 and 92.

The firms of Mauri, Volvo and Ansaldo are currently marketing a new generation TC (model B59-59) in Italy. The only buyer to date has been the Adriatic city of Rimini.

Netherlands - This country's single system in Arnhem purchased new vehicles in the mid-1970's and has extended its routes. Future conversions from motor coach are also contemplated. Plans are now underway to determine the feasibility of a TC operation in Amsterdam on the north shore of Het Is. TC's would replace motor coaches and enter the city centre via an existing vehicular tunnel.

Norway - Bergen is continually upgrading its TC operation. In 1972 Bergen purchased 20 Skoda 9Tr vehicles and last year purchased four TC's built by Volva/Hess/Secheron. Future plans are to purchase a few vehicles each year and to extend the system as traffic warrants.

Sweden - The Stockhom City Council is developing plans for an experimental TC route in 1980. A successful demonstration could witness a large scale introduction of TC service.

Switzerland - The number of Swiss systems has remained very stable over the years. The TC has always been popular because of the abundance of hydro power and a desire to minimize dependence on imported petroleum. The current worldwide interest in trolley coaches is partially due to Swiss efforts to improve and rehabilitate their systems. Since 1970, practically all Swiss systems have purchased new TC's. Additionally, new routes have been placed in service in cities such as Bern, Neuchatel and Zurich and many systems have made extension as traffic warrants. The Swiss have also advanced TC technology by introducing the chopper and improving the overhead wire system.

West Germany - Only three systems remain in this country, but the situation now appears stable. Kaiserslautern purchased new equipment in the mid-Seventies and has recently converted a Daimler Benz O-305 diesel to electric operation. If this conversion is successful, new bodies will be bought and equipped for TC operation. Solingen, the largest German operator, has been rebuilding its fleet in recent years. System performance is also being improved with the upgrading of the wiring system and the installation of high speed switches. Esslingen has been participating in the DUO-Bus Project and will soon be the recipient of five prototype vehicles.

Trolley Coach Situation in Other Locales

The rebirth of the trolley coach has not been limited to North America and Europe. Presently, San Paulo, Brazil is contemplating the expansion and renewal of its system and is currently in the market for 200 new trolley coaches. The initial order will be used to convert three motor coach lines. Subsequent orders will be used to replace the existing fleet of 600 vehicles and for further extensions. Other recent activity includes:

- o Wellington, New Zealand is currently in the market for new vehicles. Bids are being sought for new TC's and inquiries are being made for the rehabilitation of the overhead system.
- o Johannesburg, South Africa, after years of threatening complete conversion, has also sought bids for new trolley coaches.
- o Calcutta, India is contemplating the construction of a TC test line. The interest in TC's stems from a desire to convert certain street railway lines.

Summary of Trolley Coach Experience and Prospects

In general, recent North American and European experience with trolley coaches has been very similar. For a 20 year period, up to approximately the last five years, the trolley coach was considered as obsolete by most transit systems. This was largely due to relatively narrow cost considerations. In many cases, the decision to discontinue the use of trolley coaches was based primarily on the comparison of the capital cost of fleet renewal or overhead wire modernization as compared with the replacement of motor coaches. During this time, transit systems were generally short of capital funds, and it was necessary to minimize investments.

In the last five years, the situation has generally stabilized. Most fleets have been replaced and Edmonton and Vancouver have just entered the equipment market. There are even expansion programs under way or in consideration in several cities. The cause for this change in attitude is largely a perception by transit management of the wider issues that tend to be more favorable to trolley coaches, as well as the greater availability of capital. The particular issues that have influenced the decision to retain trolley coaches vary from area to area. They range from environmental concerns and community acceptance to a desire to reduce the dependence of the transportation system on potentially scarce oil. This last factor seems to be more influential in Europe than in North America. Several systems have decided to retain trolley coaches due largely to the efforts of outside organizations concerned with environmental issues.

The potential for expansion of trolley coach operation is likely to depend to a large extent on the value placed on use of energy sources other than oil. It is worth noting that the countries, other than the Soviet Union, that have emphasized trolley coach development are those that are highly dependent on oil imports but have domestic sources for other forms of energy.

Specific Factors Influencing Trolley Coach Retention and Conversion

Boston

The small TC system in Boston has survived primarily for the following reasons:

- o Environmental - The Massachusetts Health Department has set limits on the use of the tunnel at Harvard Square by diesel coaches for reasons of air pollution. This restriction requires that TC's be retained on the present routes.

Dayton

The reasons for Dayton's retention of TC's is less clear and may center on the following:

- o Citizen Support - At public hearings the response was overwhelmingly in favor of the TC.
- o Scale of System - The TC was not a small part of the total system but represented almost three quarters of the total vehicle fleet and served most of the principal transit routes.
- o UMTA - The solicitation of 64 new TC's resulted in a bid that was approximately 70% over the expected price. Dayton sought to scale back the order but UMTA indicated that new bids would have to be solicited if this route were taken. UMTA countered by stating that it would increase the Federal grant to cover the higher price. It is quite likely that a resolicitation of bids would have prompted a closer look at diesels.

Philadelphia

Philadelphia's decision to retain TC's resulted from an in-house study. This study indicated the following reasons for retaining TC's.

- o Cost - The cost of operating TC's on Philadelphia's existing system is cheaper than operating diesels. This is partially due to the existence of a power conversion net and trained maintenance personnel.
- o Environment - TC's were shown to be more acceptable than diesels in terms of both air and noise pollution.

Seattle

This city went through a protracted period of time when it was not known if the TC would survive. Its survival probably was dependent on the following points:

- o Citizen Participation - Citizens groups were formed for the express purpose of retaining the TC.
- o Environment - Prior to assuming control of the city transit system, METRO had positioned itself in a pro-environmental role. In this role it lent support for TC retention and expansion.

San Francisco

The retention of TC's in this city appears to have been the result of several factors:

- o Operating Terrain - Several routes in this city operate over streets that have sizeable grades. Even when a cutback in the

TC system was proposed in 1966, most of the hilly routes north of Market Street were to be retained.

- o Citizen Support - The proposed conversion of a significant portion of the TC fleet was to be financed by a bond issue. Considerable public opposition lead to the bond issue's defeat.
- o Staff Support - The maintenance function at MUNI has separate staff for diesel and electric vehicles. This provides an in house constituency for the TC.
- o Environmental - Proposals had been made to remove all electric overhead on Market Street as part of a beautification program. Diesel buses would have been substituted. MUNI's planning staff prepared a report showing that diesels would have increased both noise and air pollution as the cost for reduced visual pollution. The decision was made to retain TC's.

Toronto

The pioneer in North American TC rehabilitation appears to have made its positive decision based on:

- o Costs - The TC was shown to be a cheaper vehicle to operate on Toronto's existing routes. Again partially because of the existing power facilities and overhead line maintenance capabilities.

Calgary

This was one of the few cities to discontinue TC's in the 1970's. The principal reasons appear to be:

- o Cost - In Calgary's case the TC was shown to be more expensive to operate than diesels. This was due partly to the fact that the city had grown very rapidly requiring frequent changes and extensions to the TC system and TC's had become a smaller portion of the Calgary transit system when the decision to convert was taken. The TC was judged to be too inflexible for the expanding route network.
- o Life - The system had achieved its life expectancy and required renewal.

Thunder Bay

This small system was not discussed in a case history but its reasons for conversion represent a situation not otherwise included. They are:

- o Life - The system had attained its economic life and required rehabilitation.
- o Scale - The total transit sytem is very small compared to the other systems discussed above. As such, it was felt economies of scale would be achieved if the entire fleet were composed of diesels.

REFERENCES

CHAPTER 1.1

1. Transit's Stepchild - The Trolley Coach, Sebree and Ward, Cerritos, California, 1974.
2. Transit Fact Book, American Public Transit Association, Washington, D.C., 1978.
3. The Trolley Coach in North America, Sebree and Ward, Cerritos, California, 1974.
4. Trolley Coach vs. Bus, Ohio Brass, Mansfield, Ohio, 1952.
5. "The Effect on the Interests of the City of Milwaukee of the Eventual Conversion of Existing Streetcar Lines to Trackless Trolley or Motor Bus Lines," Coverdale & Colpitts, New York, New York, 1948.
6. "Trolley Coach News," North American Trackless Trolley Association, (various volumes), Louisville, Kentucky, 1974-1978.
7. The Trackless Trolleys of Boston, Bradley Clarke, Boston, 1979.
8. "Northern California Transit Demonstration Project Report," Simpson-Curtin, Philadelphia, Pennsylvania, 1966.
9. "The Environmental and Economic Feasibility of Trolley Coach Expansion," San Francisco Municipal Parkway, Carl Natvig, San Francisco, California, 1978.
10. "Planning, Operations and Marketing," Wilbur Smith & Associates, San Francisco, 1977.
11. "Trolley Bus Magazine," National Trolley Bus Association, (various issues), Rochester, Kent, England, 1977-78.

CHAPTER 1.2

STATE OF THE ART

Introduction

This chapter provides a description of trolley coaches and trolley coach facilities now in use in North America and Europe. The initial portions of this chapter are devoted to vehicles and vehicle systems. The electric propulsion system is described first. This includes propulsion or motor voltage control, motors and braking. A description of the various types of power supply for off wire capability is included.

The other characteristics include both auxiliary mechanical components and vehicle bodies. Emphasis is placed on variations between trolley coaches and motor coaches.

The concluding sections of the chapter describe the facilities and equipment for delivering power to the vehicle. Power supply including associated load control equipment is covered. The section on power distribution includes the characteristics of several types of overhead wire support systems, as well as vehicle mounted current collection equipment.

Motor Voltage Control Systems

Introduction

There are three basic types of control equipment:

1. Switched resistor with direct current (DC) motor
2. Thyristor chopper with DC motor
3. Pulse width modulation into an alternating current (AC) motor.

Certain permutations and combinations are available between switched resistor and thyristor chopper, as well as between compound and series wound DC motors.

In this section the basic types will be described and their advantages and disadvantages listed. Regeneration (the return to the overhead line of electric power while braking) will be discussed. Thereafter, each manufacturer's equipment will be described.

System Basics

Trolley coach propulsion systems involve a very simple arrangement whereby overhead power at a nominal 600 volts DC is fed to a 600 volt DC motor. Note that the nominal voltage of systems ranges from 550 to 750 volts DC with a specification of +20 percent to -30 percent. At 600 volts, this is a range of 420 to 720 volts. However, on infrequent but regular occasions, such as two TC's starting at approximately the same time from a terminus distant from a substation, voltage will drop to under 400 volts.

In emergencies with a substation out of service, adjacent substations can still provide power but with longer supply distances and hence greater voltage drops. Voltages as low as 200 to 250 volts have been experienced on rare occasions and service maintained, albeit with substantially impaired performance, i.e., lower acceleration and maximum speed.

The control system must adjust the voltage across the motor to a low level for starting and then raise it in stages to full voltage at operating speeds, while providing means to vary speed up and down. A significant advantage of TC's is that the motor can be used as a generator to provide braking, thus reducing wear and maintenance on the pneumatic or hydraulically actuated friction brakes. The nature of this electric braking is such that it reduces with vehicle speed so that the friction brakes must be smoothly phased in at low speeds to bring the vehicle to a full stop and hold it there. The degree of electrical braking varies with control design. The lower the speed at which electrical braking remains effective the better. Most systems are effective to around 6 mph/10 kmph, with some to significantly lower speeds. Note that a separate electric brake system is used on some European TC's to further reduce use of friction brakes. The Telma eddy current electric brake is now being offered for TC applications in North America and can be fitted or retrofitted on both motor coaches and TC. The electrical power produced is dissipated as heat within the device.

The main electric brake using the traction motor requires control, and one criterion of different motor control systems is the ability to use as many components and circuits from acceleration control for braking control, thus reducing cost and weight.

The electrical energy generated during braking can be either returned to the overhead line - termed regenerative or recuperative braking or be dissipated in resistors - termed dynamic braking. Regenerative braking is not common on trolley coaches because of the problem of accommodating reverse polarity and the extra control complexity necessary to deliver power back to the line at the correct voltage and only when the line is receptive. The overhead line is termed receptive when it will accept regenerative energy from a braking coach at the voltage offered (partly variable with the control equipment, partly dependent on coach speed). This means that another load (an accelerating TC) must be in the same overhead section within a reasonable distance, depending on the resistance of the line between coaches, the regenerative voltage and substation location. In addition, the regenerated power will supply the auxiliary (hotel) load in the coach. Overhead lines can have their receptivity increased if the substation is reversible, that is, will accept as well as deliver power. This is discussed in the section on power supply. Several manufacturers claim that the cost of this complexity, both capital and maintenance, cannot be justified by the modest energy saving, as trolley coach overhead lines are only receptive to returning power for a moderate proportion of time. On all present system designs, dynamic brake energy is burnt in resistors and returned to the outside as heat. Options do exist to duct this heat and use it inside the coach. This can produce a substantial savings in northern climates, where up to 25 percent of total coach power consumption is used for internal heat on cold days. However, the extra cost and complications of duct and component location has overruled this savings.

All TC propulsion systems have certain common elements. A lightning arrester is usually placed between the positive and negative circuits on the roof. This is usually a pair of electrodes in a controlled atmosphere such that any discharge will jump the gap between the electrodes. It is important that no 600 volt circuit or component has an easier path to ground than through this device. All 600 volt circuits must be doubly insulated and/or provided with adequate clearance to both grounded or conducting vehicle components. This clearance is typically set at better than 2.5 cm (1 inch).

A radio interference suppressor may also be installed across the incoming 600 volt circuit except in certain chopper control systems where the input capacitance and choke can be arranged to provide inherent protection. Such steps will eliminate interference with all RF frequencies including onboard radios and domestic television.

All systems use a line breaker which will disconnect positive and possibly negative circuits as close as possible to the trolley poles. This breaker is a remotely controlled single or double pole (two-circuit) switch, which will automatically disconnect power when an excessive current is detected (an overload). The breaker can be manually or automatically reset and can be manually opened if necessary to isolate the vehicle from the overhead lines. The speed of opening under overload conditions is important to prevent equipment damage. Breakers may also be equipped to open (disconnect) if the line voltage is too high.

Auxiliary circuits are required for lighting, heating, air conditioning, the air compressor (for brakes, doors and possibly the suspension system), and control circuits including battery charging. These are termed the auxiliary or hotel load. The lowest cost arrangement of operating as many such items directly from 600 volts DC has now been superseded with the use of static power convertors so that most auxiliary circuits are at battery voltage. Thus interior lighting will not momentarily go out as the vehicle passes under a section insulator. (A gap in the positive or negative overhead line where no power is available.) Heating and some other heavy loads such as the air compressor frequently remain at line voltage (600 volts). Low voltage operation of auxiliaries has advantages in avoiding the insulation and safety aspects of 600 volts. However, 600 volt devices, in particular contactors (remote switches) and other switches will operate correctly when dirty, where low voltage units may not.

Switched Resistor Control

Over 90 years of electric transportation of all types has relied on switched resistor motor control. Basically a set of resistances is placed in series with the motor and sequentially switched out of the circuit (short circuited) as the vehicle speed increases. The voltage across the motor is thereby sequentially increased to the full line voltage. The switching can be manual requiring the skill of the driver to select the correct amount of resistance without pulling too high a current and tripping the line breaker (as in old streetcar controllers). However, in all trolley coach control systems, automatic processes are used to sequence the switching. These rely on monitoring the motor

current and cutting resistors out of the circuit only when the current at each resistance level has reduced to a pre-set level. This level is often adjustable by the driver to accommodate different grades and vehicle loads. In effect the position of the accelerator pedal need not relate to the amount of resistance in the motor circuit but to a set point determining the motor current and hence acceleration rate. In some designs the resistor sequencing will not go beyond the stage represented by the position of the accelerator pedal, thus providing a degree of speed control in the lower speed range.

The disadvantage of switched resistor control is that the identical current is flowing through the resistors as through the motor and substantial energy is wasted in the resistors during acceleration. To minimize this waste, circuits are designed to cut out the resistors as early as possible. In rail vehicles, this is usually handled by controlling motors in pairs with a transition from series to parallel at an intermediate speed. Resistors are cut out at the end of both the series and parallel phases giving two speed ranges without power waste. Two motors are undesirable in trolley coaches and therefore a special motor has been developed with both a series and parallel (called shunt) field. This allows the accelerating resistances to be cut out at an intermediate speed (15 to 17 mph/24 to 27 kmph) while the shunt field regulates both acceleration and braking above this speed with relatively high efficiency.

The resistor switching sequence can be performed by contactors - electromagnetic or electro-pneumatic, switched and interlocked by logic circuitry and/or mechanically, or by a cam control where a pilot motor sequences a parallel row of cam operated contactors. In all cases contactors operate under load and their contact points (fingers) require regular if simple maintenance. To avoid this on-load switching, designs are available using thyristors (solid-state electronic switches). Such designs that may or may not involve a chopper as part of the control system are termed "hybrid."

Thyristor Chopper Control

Thyristors (previously called SCR's for silicon-controlled rectifiers) are solid-state switches which will pass current in only one direction. When a control voltage (or pulse) is applied, they will switch on and remain on until the principal voltage drops to zero. They turn on and off very rapidly and are relatively efficient. However, small losses are produced as heat inside the device and as with all solid state devices this heat must be removed before they self destruct. For high-current traction applications the thyristors must be mounted on an insulated heat sink and force ventilated with dry clean air. The devices must also be protected from current overloads and excess voltages to which they are much more sensitive than electromechanical components.

An arrangement of thyristor(s), diodes(s) - (a device which passes current in only one direction) and control circuits can switch the 600 volt DC input to a trolley coach on and off very rapidly hundreds of times per second and is called a chopper. The resultant output is a

square wave which when integrated (in effect smoothed) has a lower voltage than the input. This output voltage can be adjusted from zero to just below the input voltage, by varying the time the chopper is turned on to the time it is turned off. A domestic light dimmer works on the same principle.

Smoothing the output of the chopper before it is fed to the motor requires a series choke (a coil of wire which limits current flow in proportion to its magnitude) and in certain cases parallel capacitors. Both capacitors and chokes are heavy and bulky. At the chopper input, a similar arrangement is necessary to smooth current into the chopper and to prevent the injection back into the overhead line of frequency components that could cause over voltages, radio frequency interference, or in extreme cases affect the control of adjacent vehicles.

A chopper control can also regulate the motor field during braking. This can be a separate unit or utilize some of the same components as the accelerator chopper.

Choppers operate at audible frequencies and it is a difficult task to ensure that all vehicle components involved in or connected to the chopper can accept these frequencies and their harmonics (lower voltage odd multiples of the basic frequencies) without vibrating and emitting noise. Some chopper designs do emit noise and can cause distress to any member of the public sensitive to the specific frequencies.

Chopper control has been available for just ten years. Reliable designs have evolved for rail vehicles and trolley coaches although there have been excessive teething problems in U.S. built rail choppers. The first U.S. trolley coach chopper design has yet to enter revenue service so that it is not possible to anticipate its performance and reliability in real terms. Chopper control equipment weighs more than comparable resistor switching control, which can add 10 to 20 percent to the propulsion system weight. In Europe, it costs about 20 to 25 percent more, adding about 10 percent to total vehicle price. In the March 1977 Seattle/Philadelphia bid opening, a new U.S. chopper design was priced at only 1 percent above resistor control (Randtronics versus the General Electric MRC control).

The advantages in power saving range from 10 to 25 percent depending on the specific application. In theory, maintenance should be lower with fewer moving parts and the remaining contactors switched without load. However, in the rail transit field, chopper maintenance has been substantially higher due to teething problems and the need for more highly trained and specialized maintenance staff. European experience with chopper control has indicated few if any such problems, but maintenance overall is costing 5 to 10 percent more than resistor switching control for units of comparable power and age. It will be some time before actual maintenance costs of chopper controlled trolley coaches on order for Seattle and Philadelphia are obtained. In the meantime, rather uncertain theoretical data indicate that a life cycle cost comparison places current U.S. chopper and resistor controls on a stand off basis.*

* Reference 3

Only in territory unfavorable to resistor controls, where steep hills or heavy traffic holds vehicles in the less energy efficient speed range, does the chopper gain positive advantage.

Apart from cost savings, the reduced energy consumption can permit higher powered vehicles or more vehicles on a route without necessitating changes to the system power supply. Counteracting this is the possibility that chopper equipped vehicles may have higher power surges and higher auxiliary loads which can impact on both substations and the overhead switch contactors. (These contactors operate the switches at overhead junctions, setting them for turns or straight through running depending on the vehicle's current draw. High auxiliary currents can give a false setting requiring either adjustment or replacement of the current sensing device.)

Only revenue experience with the new chopper equipped fleets in Seattle and Philadelphia will provide valid information on the actual cost benefits of chopper versus resistor switching. Such information will not be available until into 1980, allowing for the correction of problems, the establishment of maintenance procedures and the collection of statistically significant data. With maintenance and power consumption data for a range of operating conditions, it will be possible to perform a reliable system specific evaluation of chopper versus resistor switching. This evaluation must include an estimate of the operating properties' ability to provide the more specialized maintenance required by chopper control. In European urban rail transit applications chopper control has not become as well established as in North America despite the availability of well proven designs. Partly this reflects the conservatism of the operators, but partly a wait and see attitude toward more advanced and more advantageous electronic solid state control techniques which have recently entered revenue service on four rail systems. This is pulse width modulation or inverter control of a three phase AC motor. One manufacturer has developed this control for trolley coaches and prototype vehicles are in service in two cities.

Pulse Width Modulation with AC Motors

Pulse width modulation (PWM) is a power conversion technique with many similarities to chopper control. The principal difference is that the output is three phase alternating current with variable frequency and voltage. This theoretically permits the use of a standard AC induction motor which is a mass produced item in common use. This motor is lighter, cheaper and requires less maintenance than a DC motor. However, in practice the mass produced motor is not durable enough for transit applications, and the weight and cost advantages are mainly lost when a special heavy duty motor is required.

Pulse width modulation techniques use thyristors to chop the incoming DC power but with control pulses of varied timing so that the output when smoothed approximates an alternating current wave form. Three sets of choppers are controlled to operate 120 electrical degrees apart thus providing a three phase supply to the motor. This control generally uses a similar number of high current solid state devices to the chopper control but has a substantially more complex low current solid state control system. However, this control circuitry, as with the chopper,

uses modular exchangeable printed circuit boards and should have comparable power conversion maintenance requirements, coupled with lower motor maintenance. AC induction motors have no electrical connections to the rotating component (a squirrel cage rotor) and therefore do not require a commutator or slip rings to transfer power through replaceable brushes. They can be completely sealed and thus are not affected by dust, dirt, humidity or water, a valuable feature in the hostile transit vehicle environment.

Although pulse width modulation and inverters were experimentally applied to several Cleveland rapid transit cars in the late 1960's with an UMTA grant and WABCO as prime contractor, this development was not pursued. European manufacturers have taken advantage of improved component performance and reduced costs. They have developed several systems for rail applications where a lighter more robust motor has special advantages due to a portion of the motor weight being unsprung (riding directly on an axle). Any advantages in trolley coach applications are less obvious and must await the empirical evidence of revenue operation. However, in the rail transit field there are indications that pulse width modulation with inverters may become the dominant technology in the next decade. Several European properties have made the jump from resistor switching to PWM, omitting the intermediate chopper technology. Further reductions in electronic component costs coupled with a move up the development curve, operating experience and longer production runs of PWM controls may reduce the present cost premium of PWM over chopper control. In this event, given the effectively equivalent energy efficiency and smoothness of the two control schemes, PWM will become the preferred mode.

Specific Control Systems

North American Designs

General Electric Type MRC Control - (Magnetic, Rheostatic, Compound)
The original General Electric MR control was produced in 1932 and after refinement and improvements became type MRC in 1940, as shown in Figure 1.2-1. This control in conjunction with the highly respected GE type 1213 motor became almost the standard North American trolley coach control and was manufactured up to 1955. Modest changes were made in the early 1970's to increase power and reduce starting jerks and the control system re-entered production, winning orders for 343 trolley coaches in San Francisco, 50 in Boston, and 64 in Dayton. All 550 trolley coaches in Canada use the MRC control,* ranging from 30 year old vehicles to new ones fitted either with new controls or more commonly the 1940's control remanufactured and installed on a new (diesel) body. This control system has an excellent reputation for reliability and low maintenance.

The MRC Control is a cam-controlled switched resistor design with automatic acceleration and a compound DC motor. There are fourteen positions on the power pedal, shown in Figure 1.2-2. When starting the driver pushes the pedal down selecting one of 9 points which gives a variable rate of acceleration as the resistance is progressively cut out up to the point selected. The control system uses a compound motor to

* Except one Brown Boveri chopper equipped demonstration TC in Vancouver (1977).

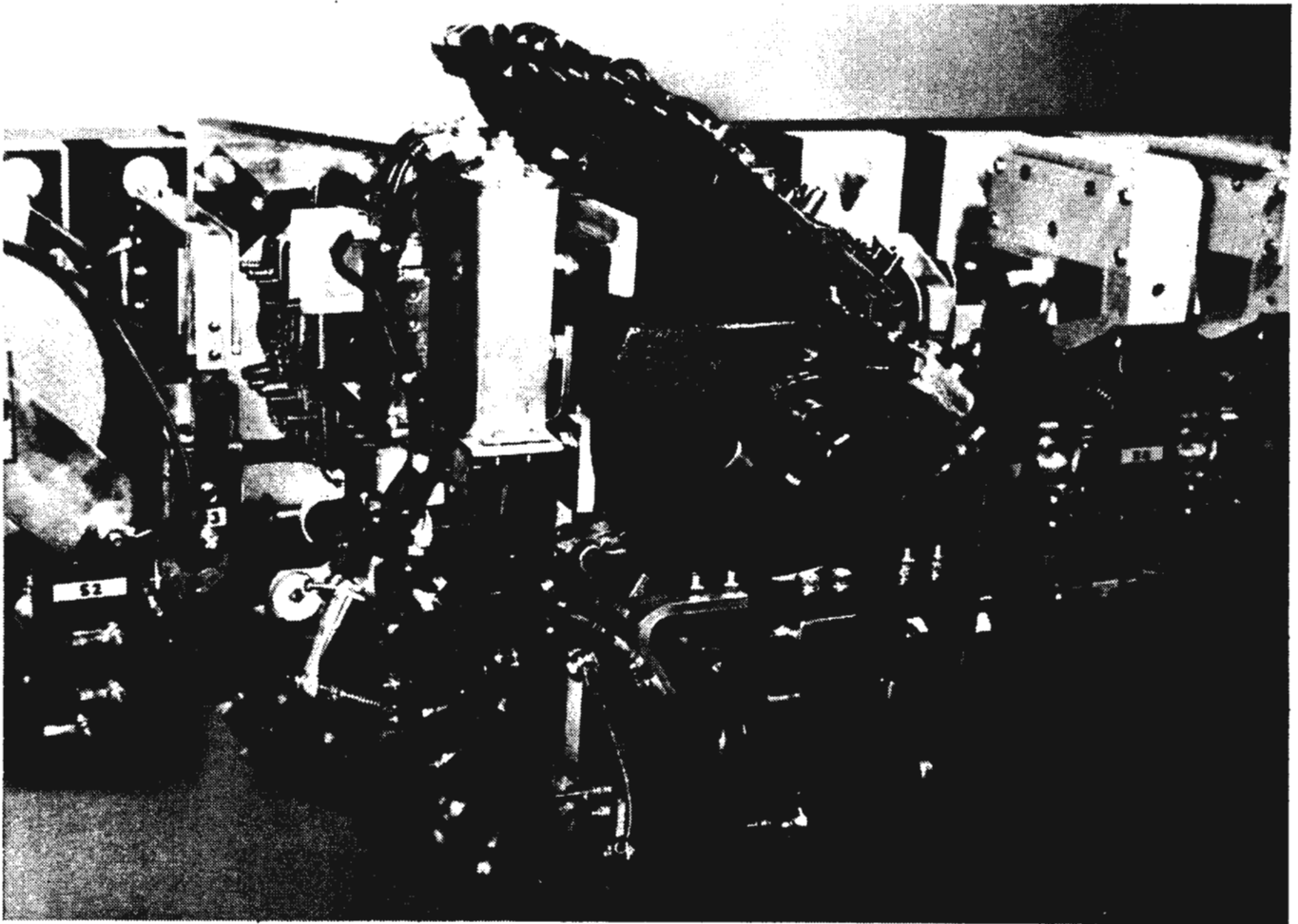

Figure 1.2-1

General Electric Type MRC Control

reduce the proportion of operation in the inefficient range where power wasting resistors are in the main series circuit, shown in Figure 1.2-3, Step 1 to 9. With an average load, 550 volt supply and level terrain all resistors are cut out by 17 miles an hour (27 kmph) and the control moves into a speed control range (steps 10-14) where efficiency is as high, or in certain circumstances higher than chopper or PWM control. It is obviously desirable to maximize the time in this range. The steps at 550 volts, level road correspond to:

Step:	10	17 mph (27 kmph)
	11	20 mph (32 kmph)
	12	24 mph (39 kmph)
	13	30 mph (48 kmph)
	14	40 mph (64 kmph)

In this range, speed may be adjusted up and down. When the accelerator is lifted and held at a lower step the traction motor field is strengthened and a modest amount of regeneration takes place, returning power to the overhead line. An over-voltage detector will trip the line breaker if a section gap, reverse polarity or non-receptive nature of the line causes too high a voltage, but any resultant jerk is small as the nature of the speed control is in small increments and the amount of regenerative retardation is small. In this speed control range the control will automatically adjust between regenerative braking and light motoring depending on the grade traversed by the vehicle.

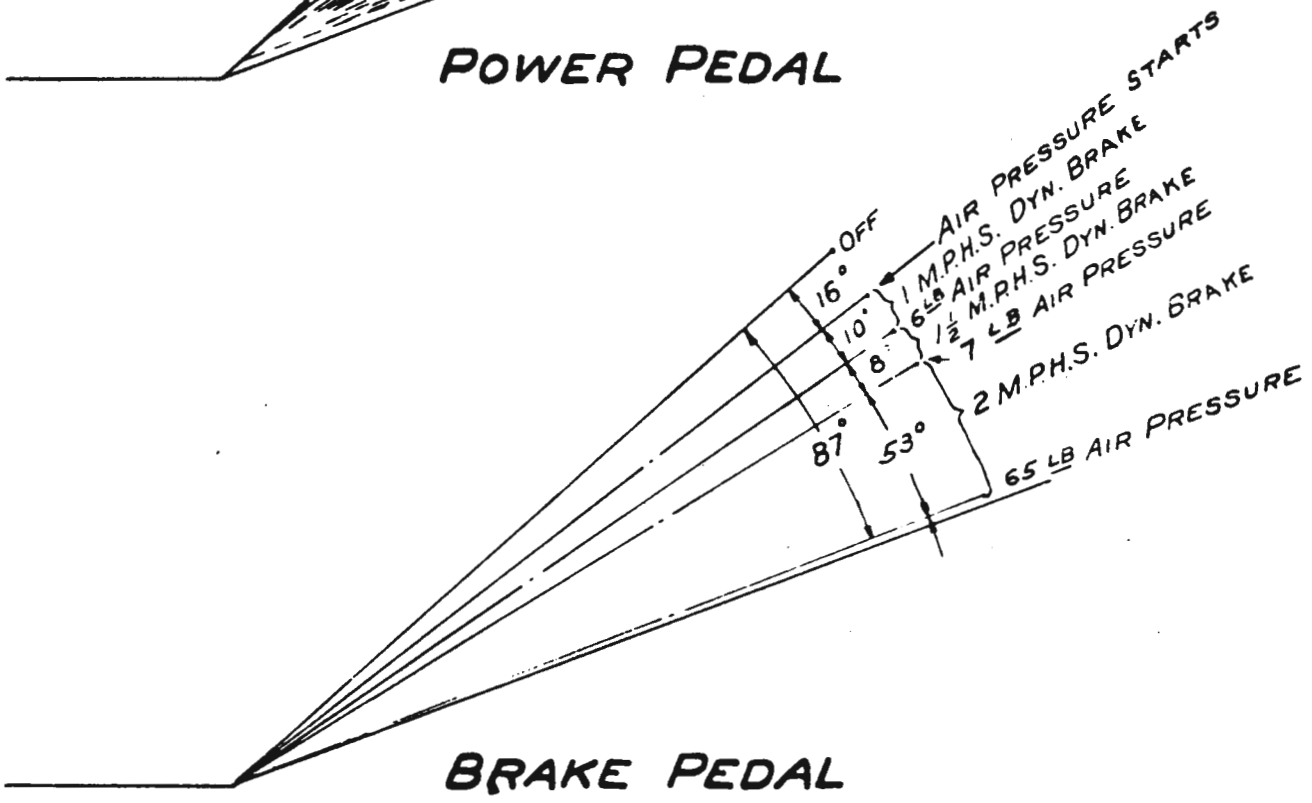
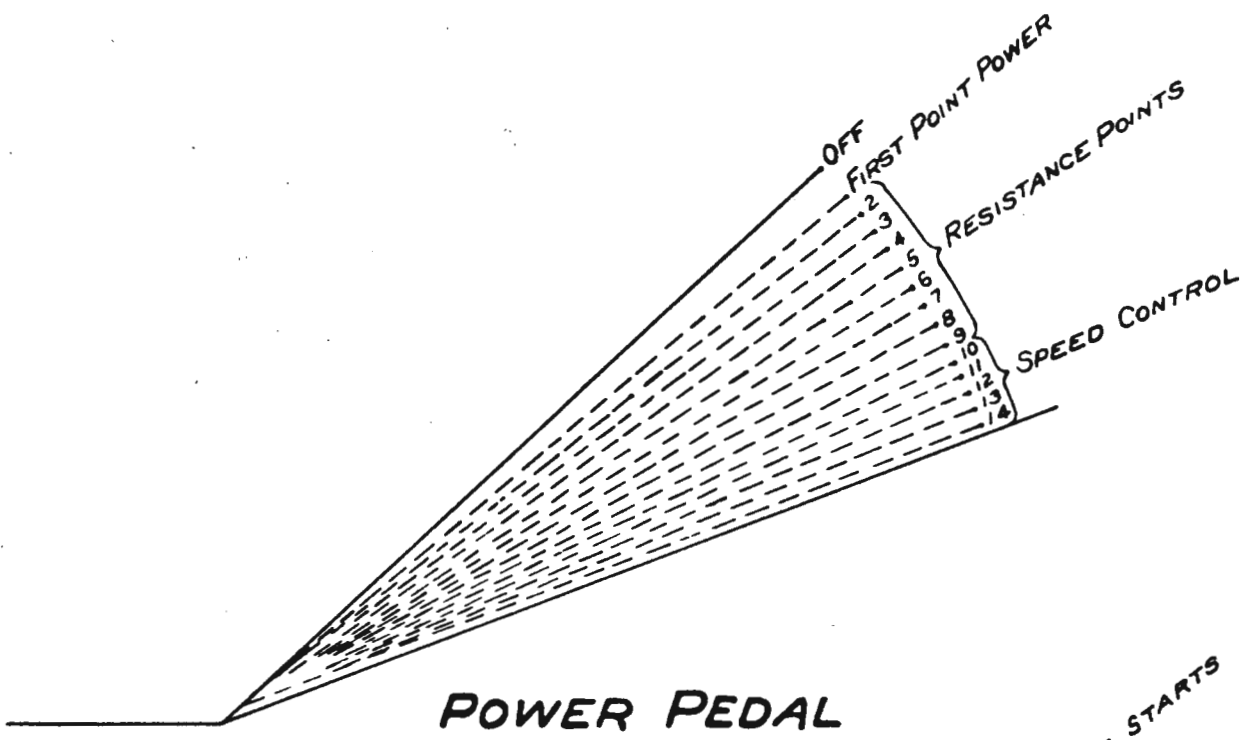

NOTE:- ANGLES INDICATE
MOVEMENT AT BRAKE
CONTROLLER & BRAKE
VALVE SHAFTS.

Figure 1.2-2
Control Pedal Positions
GE MRC Control

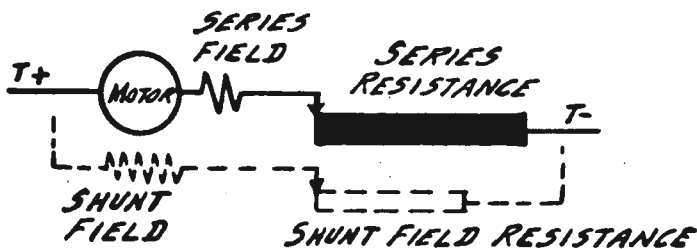

ACCELERATION

STEP NO. 1

SERIES MOTOR - FULL SERIES RESISTANCE - NO SHUNT FIELD

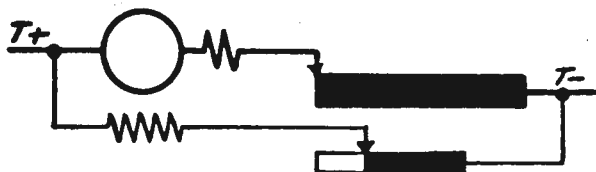

STEP NO. 2

CUMULATIVE COMPOUND MOTOR FULL SERIES RESISTANCE PARTIAL SHUNT FIELD RESISTANCE

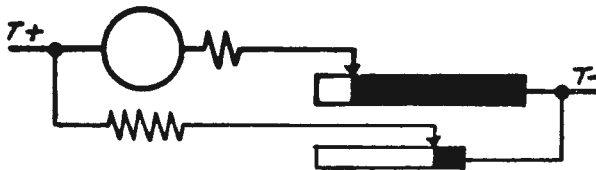

STEP NO. 3

CUMULATIVE COMPOUND MOTOR PARTIAL SERIES RESISTANCE PARTIAL SHUNT RESISTANCE

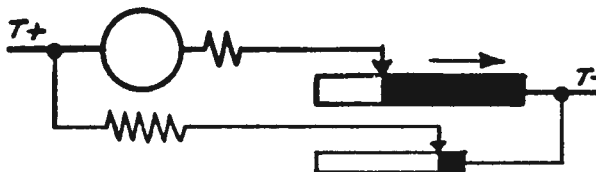

STEPS NO. 4 TO NO. 10 INCLUSIVE

CUMULATIVE COMPOUND MOTOR SERIES RESISTANCE GRADUALLY CUT OUT, FULL SHUNT FIELD

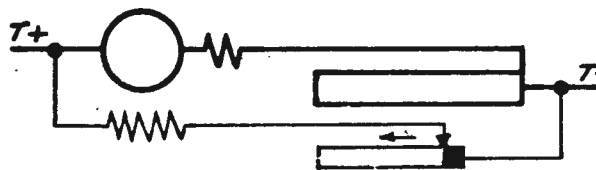

STEPS NO. 11 TO NO. 14 INCLUSIVE

CUMULATIVE COMPOUND TO SERIES MOTOR NO SERIES RESISTANCE SHUNT FIELD GRADUALLY REDUCED TO ZERO

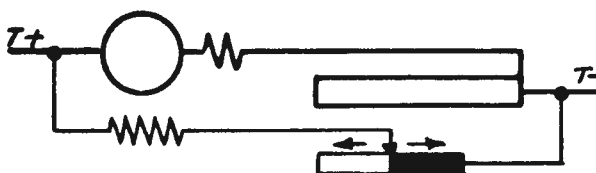

SPEED CONTROL

STEPS NO. 10 TO NO. 14 INCLUSIVE

CUMULATIVE COMPOUND, DIFFERENTIAL COMPOUND OR SERIES MACHINE NO SERIES RESISTANCE SHUNT FIELD VARIED

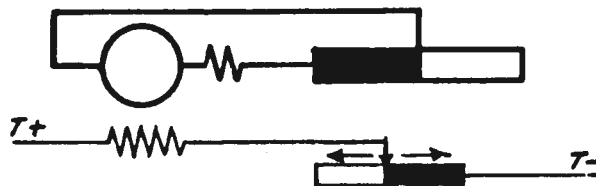

DYNAMIC BRAKING

POSITIONS NO. 1 TO NO. 5 INCLUSIVE

DIFFERENTIAL COMPOUND MACHINE FIXED SERIES RESISTANCE, SHUNT FIELD VARIED

Figure 1.2-3

Control Schematics - GE MRC Control

The control circuits operate at line voltage (nominal 600 volts DC) providing sufficient voltage to cut through any contact resistance due to dirt or oxide, thus contributing to the high reliability. When the accelerator pedal is completely released there is an inherent cushioned power shutoff when the starting resistance is reinserted in the circuit before the line breaker is opened.

In moving from acceleration to braking there is a uniform application of dynamic braking, irrespective of speed or any coasting delay. Dynamic braking is controlled by a braking cylinder of cam contacts which is part of the master controller. This cylinder is mechanically connected to the brake pedal. It controls the contactors which establish a fixed resistance across the motor armature and energizes the shunt field. As the shunt field is excited from the line, dynamic braking builds up smoothly and uniformly with no overshooting. The dynamic brake is set for approximately 2 mphps/3.2 kmphps maximum and is graduated in three rates by changing the shunt field excitation in response to movement of the brake pedal. Maintenance of a nearly constant rate over the dynamic brake speed range is achieved by "differential" action of the series and shunt fields eliminating the need for a notching control.

The dynamic braking cylinder is provided with the same angular movement as the self-lapping brake valve, hence both this valve and the braking controller can be connected directly to the brake pedal mechanism. As the brake pedal is pressed down, the dynamic braking rate increases until it reaches its maximum at about one-half the brake pedal travel. Depression of the pedal beyond this point, results in increasing air pressure while maintaining the full amount of electric braking. This arrangement insures immediate response of the air brake when required and provides a smooth blending of the electric and air brakes.

The shunt field circuit is de-energized, while the vehicle is stationary, regardless of the brake pedal position. The MRC control can operate on grades to 12 percent in the efficient speed control range (typical 31,000 lb/14 MT trolley coach and load, 550 volt line, no traffic to hold the speed below optimum). At grades of 12 to 16 percent, less efficiency is obtained. A special hill climbing 'Boost' feature is available whereby the driver can activate a button which temporarily allows higher motor currents. Additional resistors must be fitted to the coach. The control then permits speeds up to 15 mph/24 kmph on grades of up to 23 percent, with lower speeds being available for up to a 30 percent grade. However, motor heating limitations restrict such a boost to only a proportion of the duty cycle. This is not a problem in application, such as on certain heavily graded routes in San Francisco.

The discrete notch feature of the MRC control can cause jerky operation particularly if the control is poorly maintained and incorrectly set-up and if the driver (operator) is inadequately trained, or careless and operates under power through a section gap (or special work).

No control can be jerk free, if a driver is under a section gap while accelerating hard, due to the inevitable large loss - then return of torque. (Theoretically a flywheel equipped TC could minimize this problem; see section on off wire operation.) The solution is not necessarily technical but rather one of correct driver training and supervision.

This jerk problem has been compounded on TC's built in recent years due to Motor Vehicle Safety Standard #124 which requires a pneumatic accelerator linkage rather than a mechanical one. Operators are unable to 'feel' the control positions on what is discrete positioning rather than the analogue fuel control of diesel coaches. The need for this standard on trolley coaches is doubtful as electrical interlocks are (or can be) easily provided to shut off control power as soon as braking commences. Edmonton, Vancouver and Boston have installed a modification to the accelerator linkage which eases the problem but does not eliminate it.

Randtronics Series TBC-500-600 Thyristor Chopper Control - Randtronics is a small company with a successful record in applying solid state devices to adjustable speed drives for industrial and numerous small vehicle (PRT or GRT) transportation systems including the Morgantown and Dallas-Fort Worth airport systems. They entered the trolley coach market in 1974 and 1975 following a desire expressed by operators for chopper control. At that time the only such controls were European and bid openings in Vancouver plus other inquiries had indicated an excessively high price for the foreign manufactured units. Only the GE MRC control was offered by North American manufacturers.

The European chopper design (Swiss), while successful, required a special DC motor with a laminated core to accommodate the less than ideal output wave form (even with smoothing techniques some ripple remains). Randtronics took a pragmatic and novel approach to use the existing, well proven and economical GE 1213 motor. They designed a two phase chopper with substantially reduced output ripple. Laboratory tests with the 1213 motor and street operation of a test coach in San Francisco evolved a final design that successfully won the July 1977 bids for propulsion equipment on trolley coaches for Seattle and Philadelphia. Despite the specifications allowing a \$10,000 premium for chopper control, their price (on a total coach basis) was only \$1,250 above the MRC control.

The Randtronic controller consists of the following major components shown schematically in Figure 1.2-4.

- Armature Chopper Module
- Field Regulator Module
- Input Power Diode Bridge Module
- Logic Module
- Contactator Module
- Reverser Module
- Pedal Transducers
- Isolation and Smoothing Reactors
- Dynamic Braking Resistors

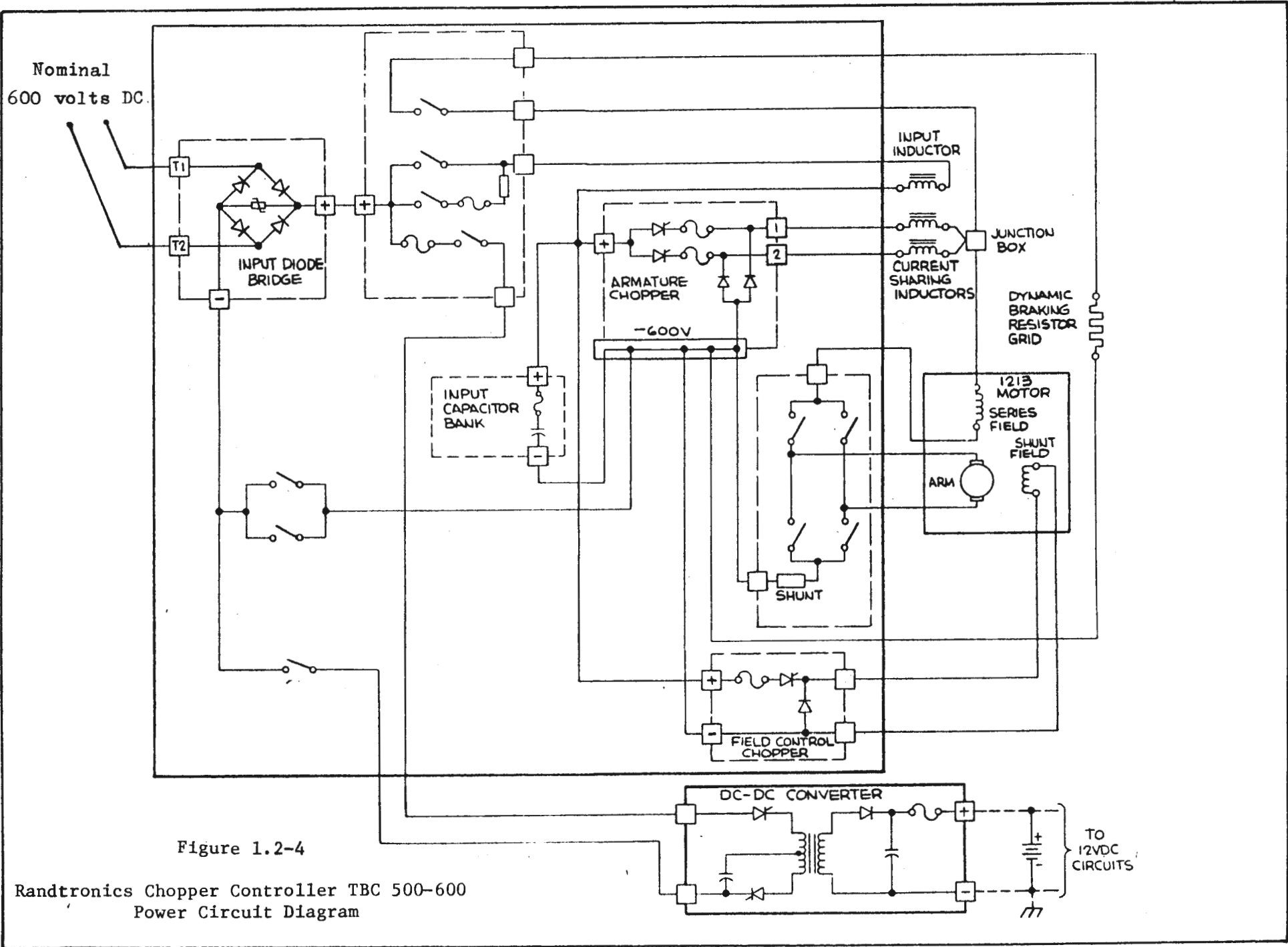

Figure 1.2-4

Randtronics Chopper Controller TBC 500-600
Power Circuit Diagram

Input power passes first through a line breaker (T1-T2) which does not switch under load except in emergencies. An input diode bridge ensures correct polarity to the chopper. This device, which is much cheaper and more reliable than polarity reversing contactors makes it impossible to return power to the line. Following switches and fuses, incoming power is applied to the armature chopper through a series inductor and a parallel capacitor bank.

The armature circuit controller is a two-phase variable frequency/variable pulse width modulation unit which utilizes two separate choppers operating 180 degrees out of phase with each other. A common commutator circuit services the turn-off requirements for both phases. The outputs of the two phases are summed through isolating inductors to the motor armature circuit.

The major advantages of a two-phase system are that the motor ripple current, heating and noise are greatly reduced (by a factor of 8 or more) in comparison with a single phase chopper; there is no ripple current at all at 50 percent duty cycle and the commutator components only have to handle half the current which would be present in a single phase chopper of equal output rating. Although the smoothing reactors are required to sum the outputs of the individual phases, each inductor only carries half the current, therefore the total inductor weight is no greater than for a single phase chopper.

Traction power supply is noted for high levels of transients. These are large voltages of short duration (spikes), created when high currents are switched on and off abruptly. Solid state components are particularly sensitive to failure with high voltages. Even very short duration spikes can cause internal flashovers and failures inside the components. The Randtronics design includes multiple protection from such transients. The components are conservatively rated and, with the protective input capacitor banks and inductors (chokes), will tolerate transients to levels determined in UMTA tests of 2,500 volts with total energy content of 1,500 watt seconds. Thereafter individual high speed semiconductor fuses and conventional circuit breakers offer additional protection, albeit by stopping operation. The control design permits an impaired level of operation should one arm of the chopper fail, permitting a coach to be driven out of service.

The armature chopper substitutes for the resistor switching in a conventional controller and smoothly increases voltage to the motor up to about 17 mph/27 kmph. Thereafter a similar, but single phase, field chopper provides the basic speed control by regulating up and down the shunt field voltage (and hence current).

Control logic receives input from the operator's accelerator and brake pedal transducer assemblies. These are highly reliable linear voltage differential transducers which work on a variable-induction principle without contacting electrical parts, and with a failsafe design. The logic devices subsequently control the choppers so that the system closely duplicates that of the MRC controller, except that lifting

the accelerator pedal will not cause regenerative braking. Dynamic braking only occurs when the brake pedal is actuated. The use of a diode bridge to correct overhead line polarity inherently precludes any regenerative braking with the Randtronics design. To provide regenerative braking would require substantially more complex and costly equipment similar to that of the CEM (France) design described later.

As with the MRC control, electrical (dynamic) braking can be held to the maximum allowed by the motor current above 10 mph/16 kmph. Below 10 mph/16 kmph, dynamic braking reduces in proportion to the coach speed and the mechanical brakes are phased in through a direct pedal linkage.

European Trolley Coach Control Designs

Brown Boveri/Secheron - Brown Boveri (BBC) is an international company headquartered in Baden, Switzerland. Secheron, a subsidiary firm located in Geneva, Switzerland, is a pioneer in trolley coach chopper control. The Swiss were among the first to determine that they wished to retain and modernize trolley coach services. BBC evolved and tested a prototype chopper controlled trolley coach for St. Gallen, Switzerland, in 1968-9 and delivered 8 coaches through 1971. A total of 132 coaches have now been supplied for Zurich, Bern, Geneva, Lausanne, Basel, Neuchatel in Switzerland, four for Bergen, Norway and single demonstration units for Budapest, Hungary and Vancouver, Canada. A typical underbody installation is shown in Figure 1.2-5.

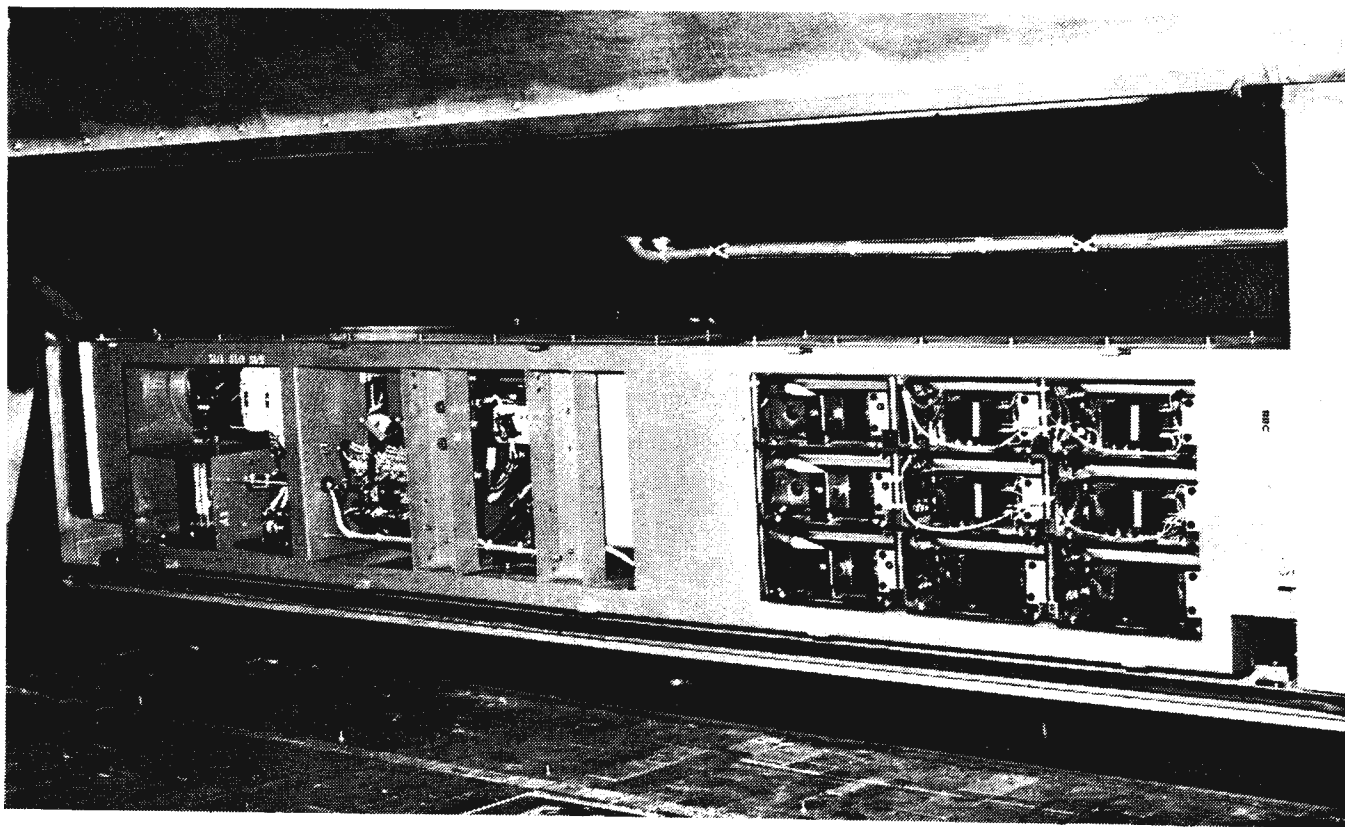

Figure 1.2-5

BBC/Secheron Chopper Installed Under Body

The system uses a four-pole series traction motor with laminated cores to tolerate chopper ripple. The configuration is similar to that of Randtronics but with only one chopper phase and no shunt field on the motor. The incoming supply has the usual line breaker and a full wave rectifier bridge to ensure correct polarity. Input capacitors and a choke serve as a filter to protect the chopper and prevent undesirable feedback to the line. The single chopper adjusts voltage to the motor working at a fixed frequency of 400 Hertz, with field weakening starting automatically beyond a certain firing angle.

In braking the chopper is disconnected from the line circuit and is used to vary the braking resistance. The chopper and the excitation winding of the motor are connected in parallel with part of the braking resistor. Automatic field weakening is retained. The system provides full dynamic brake to about 10 mph/16 kmph thereafter tapering off to zero at 5 mph/8 kmph as the mechanical brake is blended in.

Most of the Swiss trolley coaches are equipped with a limited performance off wire capability using a small automobile gasoline engine. The same chopper is used to control this power to the motor but it adds substantial additional complexity and cost. Off wire systems will be discussed in a later section.

BBC's early chopper design produced a well received, reliable system but both due to advances in solid state devices and the complexity desired by Swiss trolley coach operators, it did not appear to be commercially viable for other countries. It was too expensive, particularly when the relative value of the Swiss franc is taken into account. BBC has thus far designed a second generation chopper control.

This simplified BBC design was installed in a Vancouver coach late in 1977. No field weakening is used. Rather, the chopper has the capability to adjust voltage to the motor over the full speed range, thus requiring that the motor be designed to attain its full voltage at a higher speed. This design, which uses a reversing contactor rather than rectifier bridge to correct line polarity, has only four power semiconductor devices and has reduced weight and price compared to earlier Swiss units. Manufacture in North America with some domestic components is planned. The circuit components are shown schematically in Figure 1.2-6.

BBC also supplied control systems for Ikarus coaches built in Hungary for the City of Budapest, and is the parent company of CEM-TCO whose hybrid control system for the Berliet ER100 Trolley coach is described below.

Oy Stromberg Ab. Finland - Stromberg, capitalizing on their successful pulse width modulation (PWM) control for subway and light rail cars has designed a trolley coach control using this principle. Two prototype coaches have been supplied to Helsinki, Finland and Winterthur, Switzerland. The basic circuit is shown in Figure 1.2-7. Overhead power at the standard 600 volts DC is collected (1) and passes through a double pole line breaker (2) which is not normally operated under power. A polarity contactor (3) connects for any reversal in the overhead positive supply which may occur on some systems at special work or in emergencies with

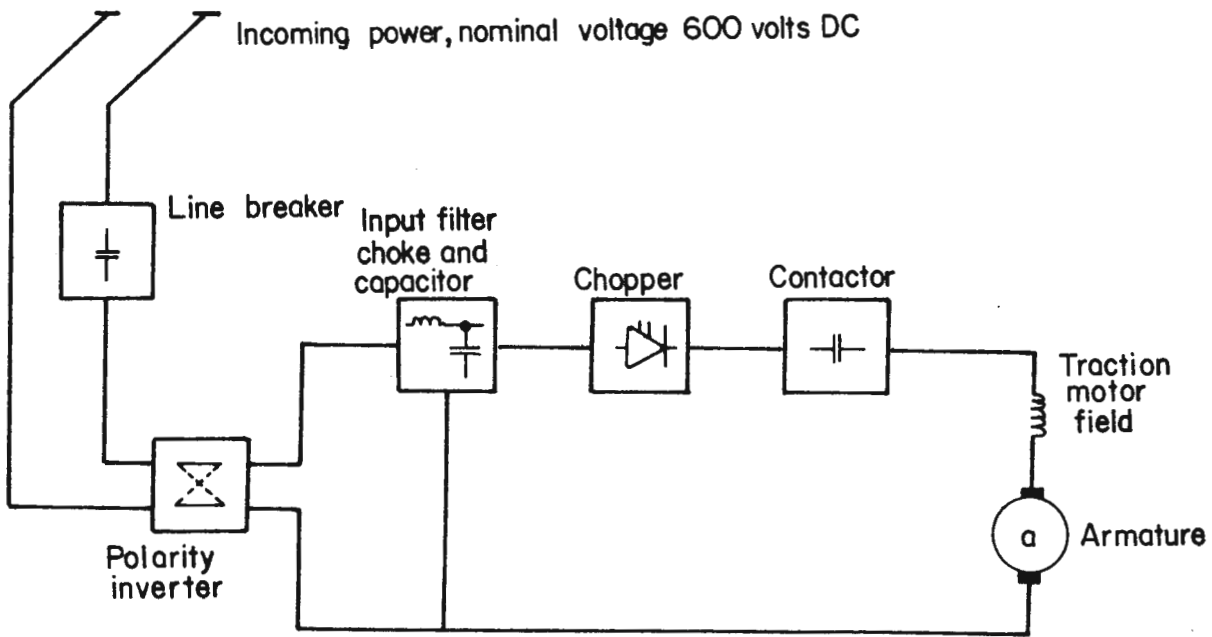

A Motoring circuit

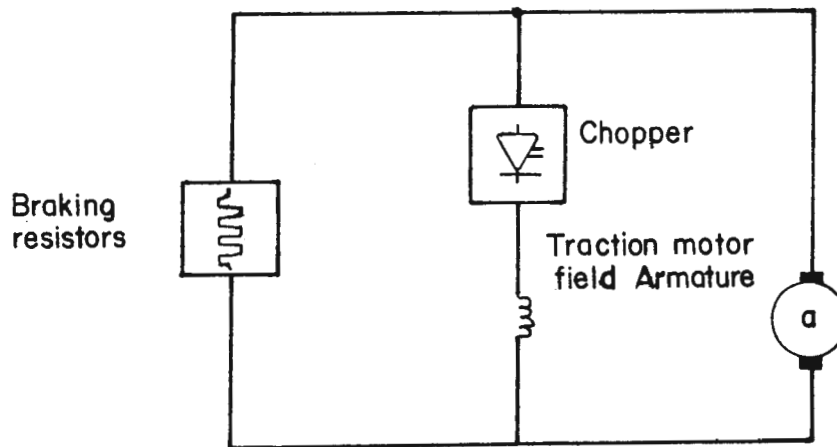

B Braking circuit

Figure 1.2-6

Brown Boveri Chopper Control
Simplified System for Vancouver, Canada

Figure I.2-7

Oy Stromberg Ab. Schematic Circuit for a PWM System

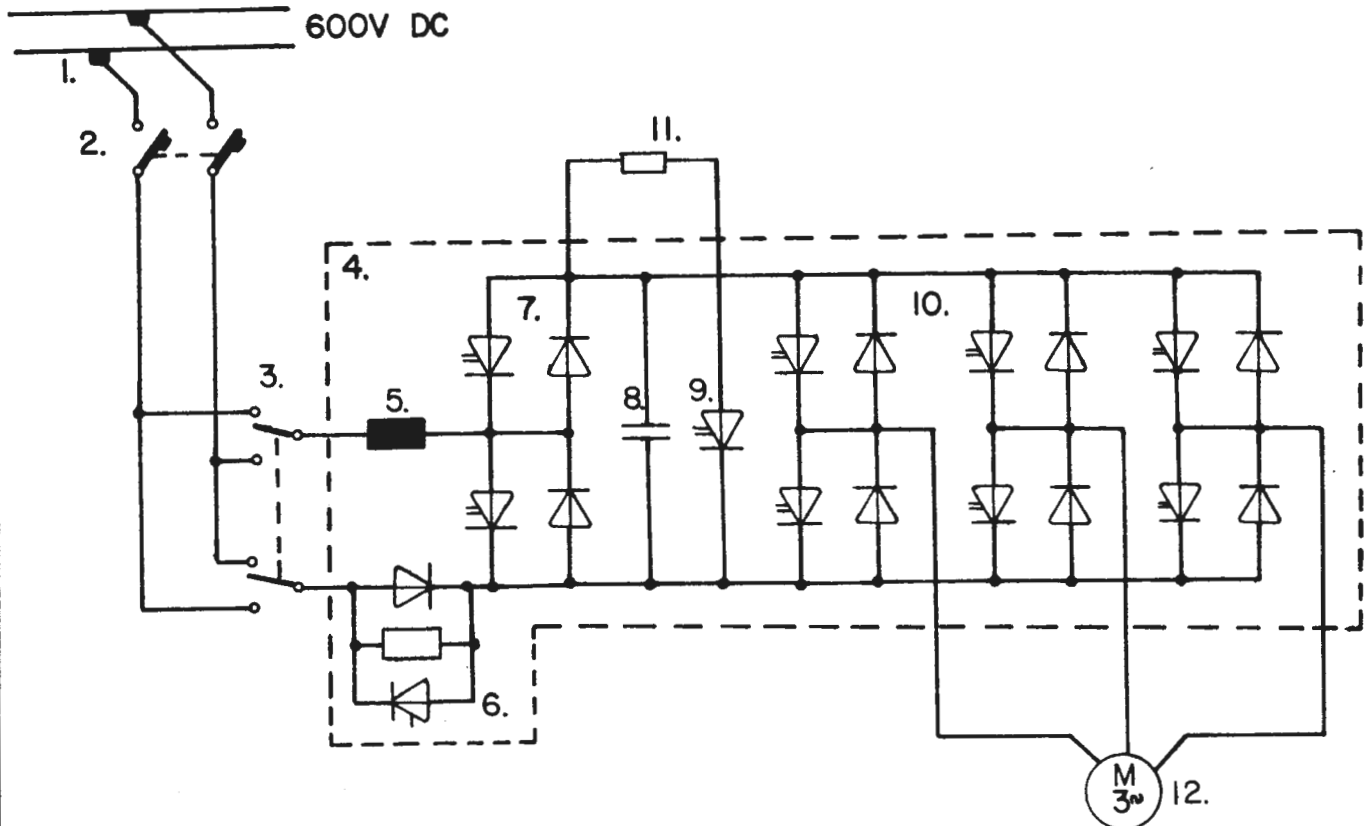

- 1. Current collectors
- 2. Main circuit breaker
- 3. Polarity switches
- 4. Drive unit
- 5. Line reactor
- 6. Charging devices

- 7. Line chopper
- 8. Filter capacitor
- 9. Braking chopper
- 10. PWM-inverter
- 11. Braking resistor
- 12. Traction motor

wrong-way wire operation. A line reactor or choke (5) smoothes incoming current to the line chopper (7) whose thyristors are turned off by charging devices (a commutating circuit) (6) and whose output is filtered by a capacitor bank (8).

This line chopper adjusts the DC voltage to the inverter during motoring and to the line during regenerative braking, allowing full performance in both motoring and braking regardless of line voltage - within the range of 420 to 750 volts. The inverter (10) makes a 3-phase AC voltage out of the DC voltage by using six forced-commutated thyristors acting as three alternating switches. Every half wave of the AC voltage consists of one or more voltage pulses of variable width, which together determine the effective amplitude of the half wave. This is the pulse-width modulation (PWM) principle. The frequency of the AC voltage is determined by the number of pulse groups per time unit. At low speeds the amplitude and frequency of the AC voltage are varied proportionally to each other. This is the "constant flux range" of the motor operation.

At higher speeds the voltage is constant and only the frequency is varied. Then the motor is said to operate in the "field weakening range," since the flux of the motor is reduced. The inverter can transfer power in both directions. Reversing the motor is accomplished by exchanging the electronic control of two phases of the inverter.

In the braking mode the inverter controls and rectifies the braking power which is returned to the line via the line chopper. When the line is not receptive a separate braking chopper (9) controls power flow to the braking resistors (11) which are usually naturally ventilated, roof mounted units. The electric braking power is thus blended between regenerative and dynamic modes as required thus maximizing the amount of regenerative power. This control system permits full electric braking effort down to speeds below 1 mph/1.6 kmph. Particular attention has to be paid with a variable frequency control to avoid electromagnetic interference. The choke/capacitor line filter (5&8) plus other radio-frequency filtering devices at the input to the control reduce any interference to an acceptable level. The two prototype Stromberg PWM control trolley coaches are also equipped with 68 hp/50 kw diesel generators to provide off wire capabilities.

TCO - Societe de Traction CEM-OERLIKON - This company is the French subsidiary of Brown Boveri. The French followed the Swiss, Canadians and Americans in planning trolley coach replacements. Four hundred trolley coaches are in service in Lyon, Grenoble, Saint-Etienne, Marseille, and Limoges. Berliet, a division of Renault Vehicules Industriels, has produced a new design, model ER100 with a CEM hybrid switched resistor control. There have been 185 new coaches delivered in 1977 and 1978.

The French operating companies expressed a desire to reuse certain electrical components from the old coaches. The resulting control design is a hybrid using both solid state control, thyristor switched resistors and a chopper controlled shunt field. The basic circuit is shown in Figure 1.2-8.

Figure 1.2-8

CEM-Oerlikon (France)

Basic Control Circuit for Berliet ER100 Trolley Coach

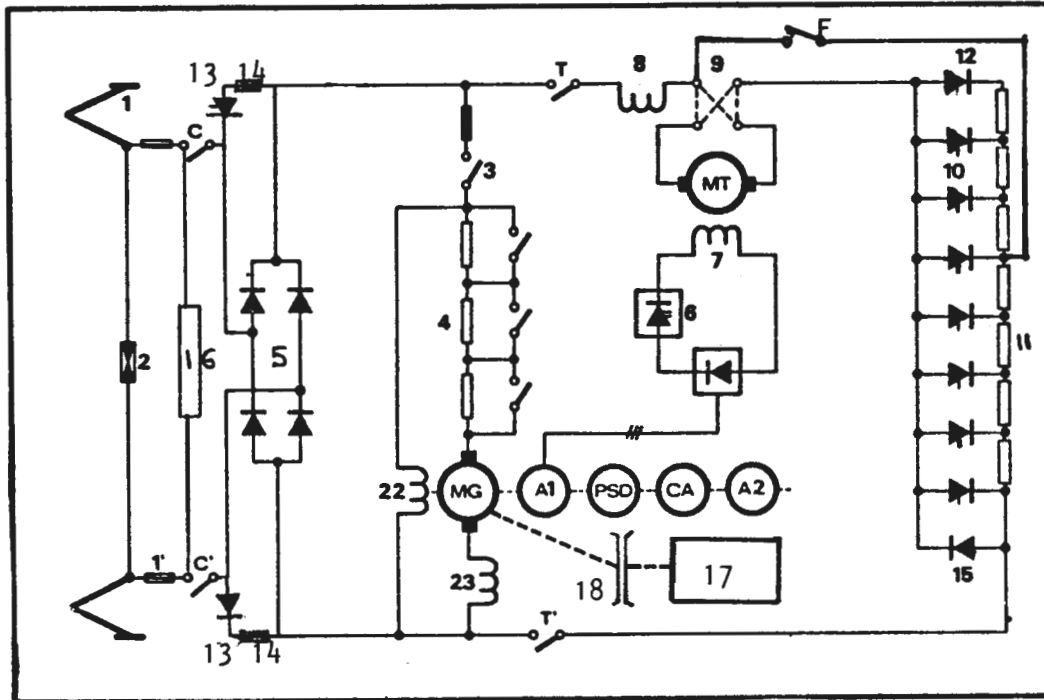

- | | |
|--|--|
| 1. Main fuse | A1. Excitation alternator |
| 2. Lightning arrester | A2. Battery charge alternator |
| 3. Contactor for starting generator motor | PSD Main power steering pump |
| 4. Rheostat for starting generator motor | CA Air compressor |
| 5. Rectifier bridge | MG Generator motor for driving auxiliaries |
| 6. Excitation chopper | MT Traction motor |
| 7. Shunt coil of traction motor | CC' General switch |
| 8. Standard coil of traction motor | TT' Rheostatic braking contactor |
| 9. Running direction reverser | F Braking contactor |
| 10. Main resistors | |
| 11. Rheostat for starting and braking the traction motor | |
| 12. Anti-brake diode | |
| 13. Thyristor for regenerative braking | |
| 14. Protective fuse | |
| 15. Braking diode | |
| 16. Line sensor | |
| 17. Diesel drive engine | |
| 18. Electromagnetic clutch | |
| 22. Shunt coil of generator motor | |
| 23. Standard coil of generator motor | |

Incoming 600 volt DC power, has the usual lightning arrester (2), main line breaker and fuses (C) and polarity connection rectifier bridge (5). A compound wound motor (MG) drives a series of auxiliary power devices (A1, PSD, CA and A2), of which the excitation alternator (A1) provides power for the main traction motor (MT) shunt field (7) through a controlling chopper-rectifier (6). The main traction motor circuit serially contains the series field (8) a reversing contactor (9) and the main resistor bank (11). Resistors are sequentially cut out of circuit by thyristor switches (10).

The control has many similarities to the GE MRC design. The series resistors are sequentially removed with speed control above about 17 mph/27 kmph using a separate field control. The CEM design differs from the GE in using a chopper circuit (6) to adjust voltage to the shunt field fed from a motor/alternator set (MG/A1), and by offering regenerative brake over a wide range. Braking is regulated by the same shunt field (7).

Regenerative braking is provided when the driver releases the accelerator slightly while in the shunt field speed control range. Thyristors (13) and protective fuses (14) bypass the input polarity control rectifier (5) when and only when the line sensor (16) determines correct polarity in the overhead line. The chopper fed shunt field (7) controls the rate of regenerative braking. Dynamic braking is provided when the brake pedal is depressed. Contactors (T) open separating the motor circuit from the line while contactor (F) closes, isolating a proportion of the starting resistances (11). Dynamic braking control uses the same shunt field excitation chopper (6).

The Berliet ER100 trolley coach is equipped with a 56 hp/42 kw diesel generator (17) for off line operation, which drives the normal auxiliary motor (MG) as a generator through an electromagnetic clutch (18). The separate control circuits for off line operation are not shown.

The Berliet ER100 control design is interesting due to its hybrid nature and the bypassing of the incoming polarity rectifier to return regenerative power to the line. It is very much a compromise design to use certain components rebuilt from old coaches. As such it combines the disadvantages of high current solid state components with the inefficiency of resistor switching and very limited regenerative braking. The control manufacturer also offers two full chopper control systems, and it is unlikely that this hybrid design will have any application in North America.

Siemens AG. West Germany. Siemens has been in the forefront of light rail and rapid transit propulsion technology, however given the limited German market for trolley coaches, development work on trolley coach control systems had been modest. Siemens offered an electronically controlled contactor switched resistor system with a separately excited rheostatic brake in the early Seventies, and with the resurgence of interest in trolley coaches, has announced in 1979 a series of trolley coach control options.

The Siemens hybrid design as installed in 3 axle articulated trolley coaches in Lucerne, Switzerland, uses contactor switched resistors sequenced by a solid state 'Simatic' electronic control unit. The basic component arrangement is shown in Figure 1.2-9. A reversing contactor is used to ensure current polarity. This permits regenerative or dynamic braking depending on whether the overhead line is receptive or not. Additional electrical braking is provided by a Telma eddy current brake, as described in the section on braking. A thyristor control unit controls the main motor braking. This hybrid circuit is very similar in function to that on the Berliet ER100 as described above except that contactors rather than thyristors are used to switch the main resistors.

The new series of Siemens controls starts with a modification of the above design.

- A Modified Contactor Switched Resistor. Switched resistor controls incrementally remove resistors in series with the traction motor. The more steps (or notches) the smoother the acceleration but the greater the cost. This control system uses a small thyristor DC module to slightly adjust the motor field excitation as the contactors switch. This temporary field weakening reduces any notching surge. The technique has been successfully employed on subway cars in Nuremberg, West Germany. It permits a reduction in the number of resistance steps and thus employs fewer contactors with an ensuing cost reduction. The first installation on an articulated trolley coach built by MAN/Graf and Stift in Vienna, Austria, took place in early 1979. The system incorporates self-excited dynamic braking.
- B Chopper control. A similar system to that of the Hanover, Linz and Graz light rail cars is offered for trolley coaches. Regenerative braking is provided. Capital cost is estimated at approximately 30 percent more than the simplified resistor switching (A) and it is anticipated that the potential energy saving of 30 percent or less will only justify this premium on dense systems (where the line is receptive for a high proportion of time) or where a high premium is placed on electrical energy conservation.
- C Simplified chopper control. This offers a similar control system to (B) but without any dynamic or regenerative braking. Instead electric braking is provided by separate self-contained eddy current brakes. Equipment cost is approximately 20 percent higher than the resistor system (A) but with reduced energy consumption (8 to 15 percent) due to the elimination of resistors in the starting circuit.
- D AC motors with inverter control. This system is similar to the control on the light rail cars in Mulheim. Siemens recommends that regenerative and dynamic brake be omitted and replaced with eddy current brakes. Electric braking via the motor adds substantially to the complexity of the control system adding capital and maintenance costs that in general life cycle cost analysis appear not to justify the energy saved. The Siemens

Figure 1.2-9

Siemens Trolley Coach Propulsion Control (Lucerne)

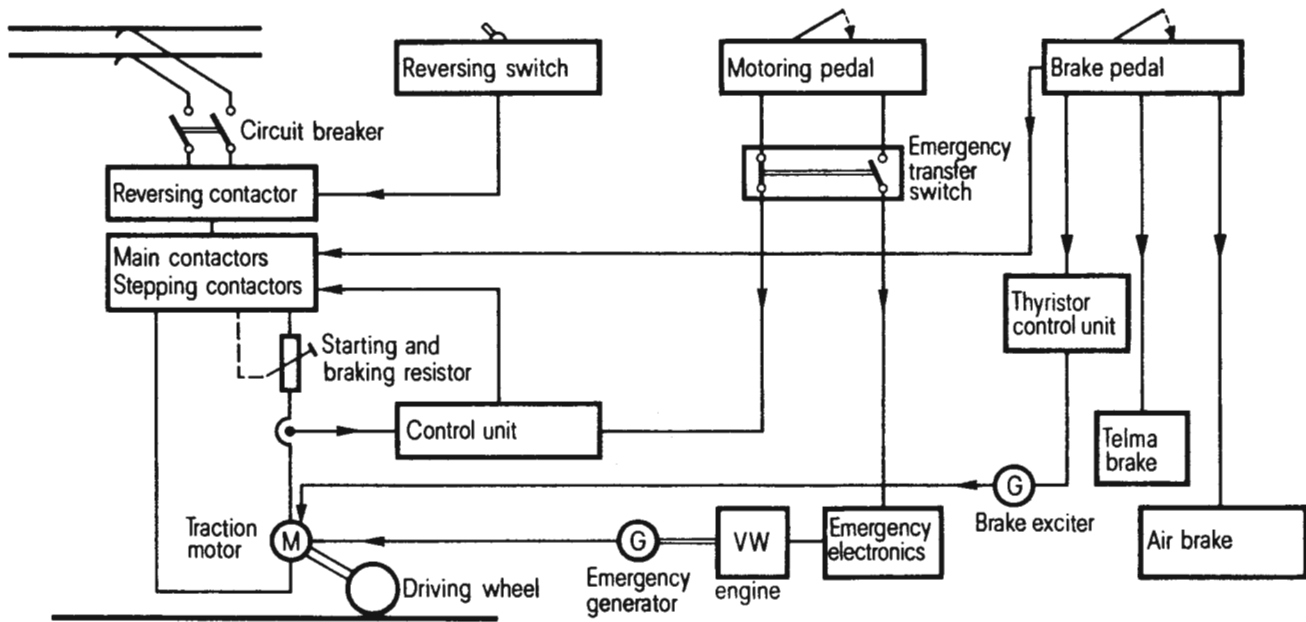

inverter differs from the Stromberg pulse width modulation concept by combining a chopper with a phase sequence convertor. Despite using a lower cost AC motor, this control system is still an estimated 50 percent more expensive than option A or C.

Italian trolley coaches - Coaches are offered by Mauri with switched resistor control. A chopper control option is said to be in development. No details are available.

Austrian trolley coaches - Osterreichische Automobilfabrik-Graf and Stift AG of Austria in conjunction with MAN of W. Germany offer 2 axle or 3 axle articulated trolley coaches custom fitted with electrical equipment from different manufacturers including the BBC and Siemens systems described above.

Czechoslovakian trolley coaches - The Skoda Plzen Corporation is a large builder of trolley coaches for Eastern Europe. Their vehicles operate in over 70 cities including sites in the Soviet Union, India, and Norway. Two axle coaches of models 9Tr, 9TrH, and 9TrHT are in production. In 1977, 280 TC's were produced, 192 for the Soviet Union (17 cities) 86 for Kabul, Afghanistan and 2 for Czechoslovakia. Production of 90 trolley coaches in 1978 and 140 in 1979 were scheduled for Czechoslovakia plus others for the Soviet Union. The 1979 production is scheduled to see the first chopper control vehicles model 9TrHT.

The control equipment on Skoda trolley coaches is of their own manufacture. The resistor control uses contactor switching while the chopper control uses a series DC motor with full range voltage control. Dynamic braking is controlled via the same chopper. Skoda has also introduced a solid state DC-DC convertor to produce the 24 volt DC auxiliary power.

Hungarian trolley coaches - Eastern Europe's largest transit coach manufacturer, Ikarus, offers a trolley coach based on a diesel model equipped with Brown Boveri controls.

Soviet Union - Central government policy in the Soviet Union dictates the maximum use of electrically powered transit. As a result the USSR has the world's largest fleet of light rail vehicles and trolley coaches on systems in over 200 cities. Moscow alone has over 2000 trolley coaches. Soviet trolley coaches are either of domestic manufacture or made by Skoda in Czechoslovakia and imported under the Conecon Trade arrangements. The Soviets have recently bid on western trolley coach requirements with their model ZIU-9. This has very conventional switched resistor controls but chopper controls are stated to be under development.

A recent tour of a Soviet trolley coach installation showed new ZIU-9 vehicles to be attractive high performance trolley coaches, but under the massive overloading and abuse common in many Soviet cities they were experiencing structural failures within 12 months of delivery.

A unique feature in the Ukrainian city of Kiev is the alleviation of staff shortages by use of multiple-unit operation of imported Skoda 9Tr trolley coaches. The coaches are mechanically coupled by a rigid drawbar with the steering of the second bus directly coupled to this drawbar to enable it to track the lead TC according to the off-centre angle of the drawbar. Only the lead TC has its trolley poles up. Power is train lined through 600 volt connectors to the rear coach. (A maximum of two coaches can be coupled.) The coaches accelerated, braked and tracked smoothly.

Trolley Coach Motors

Basic motor parameters are listed by manufacturer and model in Table 1.2-1.

There is only one specific trolley coach motor manufactured in North America, the GE 1213. This is a long established design with compound fields to provide suitable characteristics for single motor trolley coaches. The motor has been improved through the years as more advanced materials and manufacturing processes became available. As a result power has increased from 123 hp to 155 hp (92 kw to 116 k2) using the same size motor, (continuous rating) and the insulation has improved from class "B" to "H" which permits higher internal temperatures without damage. The armature coils are now welded to the commutator by the tungsten inert gas process allowing momentary commutator overload temperatures without damage and simplifying rewinds. The design permits a minimum of three rewinds during the motor life.

Motor ratings, like the ratings of many other electrical components, are dependent on the duty cycle to which they are subjected. Unlike internal combustion engines - with a definite output power - electric motors can provide substantial output beyond their rated power. The ruling factor is the internal temperature which is closely dependent on the ventilation provided. Motors can have forced ventilation in which an external fan blows air (which must be clean and dry) into and through the motor. Self ventilated motors are common for trolley coach applications. They have an axial fan - usually at the opposite end from the commutator - which moves air from an intake to an outlet. In traction applications ducting is commonly used to connect this intake to a high position on the vehicle - or to the passenger compartment - to ensure dry, clean air. AC induction motors are usually both self ventilated and totally enclosed. The internal fan distributes air through the motor and heat is dissipated through fins on the motor case. This is an advantage in that neither ducting and the associated filters nor an external fan is needed.

Given a specific degree of heat removed, a traction motor can produce two to three times its rated power for short periods. This is ideal for transit applications which call for high starting torque coupled with inactive periods at stops. Long grades have to be taken into account in application studies as they may not only subject the motor to overheat during the climb but also add a large thermal load due to the electric braking during the descent.

Table 1.2-1

Trolley Coach Traction Motors

<u>Manufacturer</u>	<u>Motor</u>	<u>Type</u>	(1) <u>Continuous hp/kw</u>	(2) <u>Class Insulation</u>	<u>Weight lb./kg.</u>	<u>Notes</u>
GE	1213	DC Compound	155/116	H	1430/650	
BBC/Secheron	4-ELG-2553	DC Series	197/147	F/H	--	Partially laminated
	4-ELC-2330T	DC Compound	160/120	F/H	1818/825	CEM/Berliet ER100
	4-ELO-2052K	DC Series	201/150	F/H	1818/925	For 2-axle buses with chopper but no field weakening
	4-ELO-2030G	DC Series	176/131	F/H	1410/640	For 2-axle buses with resistor control and field weakening
Siemens	1KB2010	DC Series	127/95	F	----	For 2-axle buses
	1KB2021	DC Series	201/150	F	----	For articulated buses
Stromberg	HXUR562 G2	3-phase induction	134/100	N/A	1430/650	Totally enclosed
Soviet	DK-207 G3	DC Compound	148/110	N/A	1600/725	
Skoda	ZAL-2943-N	DC Series	155/116	N/A	N/A	

Notes

All motors are self ventilating. They have an axial fan at one end of the armature within the casing.

The DC motors require clean/dry air ducted from a suitable location on the coach.

The AC motor is totally enclosed and the fan internally distributes air within the housing, which has external cooling ribs.

- (1) DC motor ratings are relative. In addition to the continuous rating, they can provide outputs of about 8% more for one hour ratings, plus double and triple the continuous power for periods of short duration, for example, starting on a hill. Ratings increase with voltage; stated values are for 600 volts. At 500 volts downgrade 17%, at 700 volts increase 17%.
- (2) Insulation class improves alphabetically, e.g., H is better than F.

Trolley coach motors fall into three types. One is the traditional DC compound motor which has series and shunt fields to minimize power waste during acceleration. The shunt field with relatively low current demands is used to regulate speed once the series field has been incrementally brought to its maximum current. This is a special motor and with the exception of the GE 1213 carries a premium price representing the relatively small market for trolley coaches divided among numerous manufacturers. As a result, new control designs attempt to make use of as many standard components as possible including motors that have industrial or other traction (LRT or rapid transit) applications. Among these are series wound DC motors. Many series wound motors are available that require the energy efficiency of chopper control to avoid excessive starting losses, not having a shunt field. Using resistance control, there would be power wasting resistors in series for most of the acceleration cycle. Chopper controls introduce their own special demands. Unless unacceptably heavy electrical filters are provided, their output contains the desired direct current with a superimposed alternating current ripple. This ripple requires that the motor be downrated. Randtronics has surmounted this problem with a two phase chopper with reduced ripple. Most European manufacturers take an alternative approach and use a specifically designed motor.

It is ironic that attempts to provide a special motor have resulted in another - albeit less special - motor. The third motor type is the AC induction motor described in the Stromberg control section. Ideally a standard mass produced induction motor would be used, but to provide durability Non-standard AC motors are required which do not fully reflect the cost and weight saving potential. They do have exceptionally low maintenance requirements. However for all the theoretical advantages of a totally enclosed design without commutators, these features on DC machines have low maintenance demands, particularly on the GE 1213 motor.

A final classification of motors is the insulation class, expressed in an ascending alphabetic scale. The higher the letter the higher the temperature the insulation can stand and hence the higher the power for a given size or weight of machine. Most designs use class F and/or H insulation. The higher value 'H' is used for the higher temperature areas of the motor.

Trolley Coach Braking Systems

A major advantage of trolley coaches is that much of the braking effort uses the motor. This reduces mechanical brake maintenance to about one third that of an equivalent size diesel coach. This alone is not a massive saving - about 2¢ per vehicle mile - but it does reduce down time and reduce an unpleasant maintenance duty.

The electric braking provided on trolley coaches is an integral part of the motor control system and has been described in this section. Electric braking in most cases uses the traction motor as a generator. The main differences between control systems are in the manner in which the generated power is disposed of, the magnitude of the electric braking effort, usually expressed as the lowest speed at which such braking can provide the principal means of retardation before diminishing in proportion to TC speed, and the means of braking control.

The electrical energy generated during braking can be returned to the overhead line and so be reused. However this return is only possible when the line is receptive. Receptivity is a function of the closeness of another power absorbing source, usually an accelerating trolley coach, although reverse flow substations are possible, as described in the supply section. The regenerating TC must return power to the line at a voltage higher than that of the line to 'force' power into the line, but this voltage must not be allowed to get too high as it may damage components both on the generating TC and on any adjacent vehicle. Arrangements must therefore be made to detect the line voltage and if it rises too high (when the line is termed unreceptive, the braking energy must be switched from the line to the on-board resistors. i.e., from regenerative to dynamic braking). Trolley coaches, unlike rail vehicles where line gaps are infrequent, have frequent sections of the overhead line at switches, crossovers and isolation points where there is no power. Further momentary reversal of line polarity is possible at special work or in emergencies where the trolley poles must be switched to the opposing pair of wires to run around an obstacle. Regeneration is not possible at these points and the braking energy must be switched into on-board resistors again, except in arrangements where automatic polarity reversal contactors are provided.

Regenerative braking therefore requires polarity reversal and return voltage control and a nearby receptive load if power is to be returned. When power cannot be returned to the line it must be absorbed on board or mechanical braking used. This former alternate is universally used and power is burnt in a bank of resistors carried below the floor in North American coaches and on the roof of European coaches. This energy is wasted to the atmosphere except in older coach designs where it was used to heat the coach. No current vehicle designs retain this feature, as they are based on a diesel coach body and cannot easily have their heating/air conditioning ducting reworked to accommodate traction resistors - an inherent result of the small trolley coach market.

Braking with the energy returned to a resistor bank is termed dynamic braking and has simpler control requirements than regenerative braking. Although the control of both dynamic and regenerative braking is more readily available with recent developments in control technology--thyristor choppers and inverters/AC motors, it is not necessarily cost effective. Only the Stromberg inverter offers full regenerative braking, and Stromberg is now offering a more economical design without regeneration. The general attitude among manufacturers and operators is that the regenerative feature is not cost effective.

Life cycle costing can indicate the value of regeneration but it is not possible to produce definitive costing without detailed system specific data. Three items dominate the potential savings--the cost of power including any demand charges (which can vary from a total of 1 to 6 cents/KWH in North American traction properties), the terrain, (grades present more opportunity for regeneration) and the density of service (headways and network). There are two conflicting philosophies on regeneration. There is an attitude that electrical energy should be conserved at all costs. This can place an undue burden on the transit operator and fails to acknowledge that transit per se has a positive impact on energy use. Any coach saves substantial energy relative to the alternative of the private car and the trolley coach in particular maximizes the savings of

petroleum resources. The other attitude is one of a return to the basics with the simplest most reliable, most economical transit equipment. To this end certain manufacturers are proposing trolley coach control systems without motor braking, replacing this type of electrical braking with another--the eddy current brake.

Eddy current brakes are a type of electro-dynamic retarder. They make use of the principle that if any electrical conductor is forced to rotate in a magnetic field, turbulence-induced currents (known as Foucault or eddy currents) will oppose the rotation. The resultant energy absorption is dissipated as heat. This type of brake (and other retarders) evolved in the mid-Fifties in Europe where the heavier weights and higher speeds of highway trucks were causing concern, particularly with mechanical brake fading on steep gradients. The eddy current brake offers high energy absorption with modest weight and cost and is available in a variety of configurations with flexible control options. Retarders are required by statute in certain European countries including France and Switzerland. They are used in transit vehicles not specifically to augment brakes or improve safety, but to reduce overall life cycle costs. One company is pre-eminent in the design and manufacture of electro-dynamic brakes - Compagnie Francaise Telma.

An eddy current brake suitably sized for a coach can extend the life of friction brake linings by 3 times or better. That is, it can give a diesel motor coach the same brake lining life as a trolley coach or can replace the electrical braking on a trolley coach.

The Telma retarder uses two mild-steel disks directly driven by the coach transmission to revolve in a magnetic field created by stationary electromagnets energized from the vehicle's battery. Control can use a separate 4 or 5 position switch to give different braking rates or can be integrated into the brake pedal. The 'Focal' type suitable for buses weigh 125 kg/275 lbs. to 171 kg/376 lbs. and offer 115 mkgf/832 lb.f.ft. to 170 mkgf/1,229 lb.f.ft. of braking torque.

Articulated trolley coaches have provided the first specific application of retarders. Although it is possible to use two motors and drive both rear and center axles thus allowing a full range of traction motor braking, economics dictated single motor propulsion. Although it is possible for a single motor to drive two axles, and indeed preferable in certain circumstances for reasons of weight distribution and adhesion, a single drive axle is more economical. This means that traction motor braking can be provided on only one axle. To maintain the advantages of electric braking a Telma retarder is fitted on the second and third axles on the Volvo/ Hess/Siemens articulated coaches for Lucerne, Switzerland. Siemens has indicated that it may be more economical overall to use a simple control system with no regenerative/dynamic braking and install electro-dynamic retarders. This novel 'basic' approach merits a more detailed examination.

Electric braking from the traction motor has been described as either regenerative (returning energy to the line) or dynamic (burning energy in resistors). Other options to utilize braking energy are the use of on-board energy storage either with batteries or flywheels. Both alternatives provide coaches with off wire running capabilities and are described in that section.

A Comparison of Trolley Coach Energy Consumption by Control Types

Energy consumption is so system specific that direct comparisons are difficult if not meaningless. However, a theoretical exercise does permit a comparison of the basic control types. This comparison is shown in Table 1.2-2. A coach weighing 31,000 pounds/14 metric tons is assumed operating on level terrain with six evenly spaced stops per mile.

Conclusions

Future Technical Trends

After decades of dependence on resistor switched control, DC traction has moved rapidly into the application of new solid state technology, ranging from DC-DC choppers to DC-AC pulse width modulation inverters, with complexity ranging from a basic design to full regeneration. These new systems rely on thyristor devices to switch and chop power and thyristors have followed diodes along the increasing power per dollar curve. However, thyristors are a one way switch, they can only be controlled externally to turn-on, and their circuit must be 'commutated' to force them to turn off. This adds complexity to the circuitry and limits their application flexibility. New variations of the base thyristor and diode are now being introduced. These include the controlled avalanche element, breakover diodes and reverse conducting thyristors.

In industrial applications high powered transistors are now playing an increasing role. Transistors have a faster switching capability, lower internal losses and can be externally turned off and on. Devices with 500 volt 300 amp capability are available and higher voltages, higher power and lower prices can be anticipated. These devices can be expected to have a positive impact on rail and trolley coach traction applications in future years. On another front energy storage devices are being developed suitable for these applications. While high technology batteries appear to be some years away from transit applications, flywheels are being specifically developed for transit under a current UMTA contract with Garrett Air Research. There is too much uncertainty to be able to recommend any control type at this time.

- o Switched resistors are proven, economical and carry only a small energy penalty of 5 to 15 percent.
- o Choppers can save 70 to 80 percent of this penalty. The Randtronics chopper has not accumulated revenue experience. Given the appalling history of chopper applications in U.S. rapid transit and light rail vehicles, where maintenance increased as high as three times that of previous resistor switched vehicles and availability dropped in half, further chopper purchases should not be made until Seattle and Philadelphia have adequately demonstrated this new design.
- o European choppers have developed a good track record but carry a cost premium that does not necessarily justify their energy saving except with system specific examinations. Certain European equipment is now being manufactured in North America.

Table 1.2-2

Energy Consumption by Control Type

<u>System</u>	GE-MRC Switched <u>Resistor</u>	Randtronics Two phase <u>Chopper</u>	Stromberg Inverter (1) _____
Motor	1213	1213	HXUR 562 G2
Type	DC Compound	DC Compound	3 phase AC induction
Motor Weight	1430 lbs./ 650 kg.	1430 lbs./ 650 kg.	1430 lbs./ 650 kg.
Motor Rating	155 hp/116 kw	155 hp/116 kw	134 hp/100kw
Theoretical Power Consumption - No regeneration	3.47 kwh/mile 2.2 kwh/km.)	3.1 kwh/mile (1.9 kwh/km.)	3.3 kwh/mile (2.1 kwh/km)
With 25% regeneration	Not available	Not available	2.95 kwh/mile (1.8 kwh/km)
With 50% regeneration (2)	Not available	Not available	2.55 kwh/mile (1.6 kwh/km)
With 100% regeneration (3)	Not available	Not available	1.80 kwh/mile (1.1 kwh/km)

Notes

- (1) Theoretical conditions slightly different with 5.3 stops per mile.
- (2) 50% regeneration is the best attainable on dense systems.
- (3) Not attainable in practice.

Source: Various manufacturers' published data.

- o Three phase AC motors with inverters have several advantages-- in theory. Practical experience is only just starting. As with European choppers the Stromberg design has a cost penalty that may not be balanced by energy and maintenance savings. New simplified designs need to be proven.
- o Regeneration is an altogether uncertain issue. Power savings at any price is nonsense given the minute consumption of all urban electric vehicles in North America and the transit industry's poor track record of applying and maintaining more complex vehicles. The simpler and the more basic a vehicle, the better. Theoretical savings have so far not been translated into practice and one of the transit passengers' most important concerns - reliability - has been allowed to deteriorate.
- o New technology, particularly on-board energy storage with flywheels or batteries, may offer both regeneration and off line capability which will make the trolley coach economically applicable on many heavy diesel coach routes with a real if small impact on natural petroleum demand.

Off wire Trolley Coach Operation

An undoubted but often overstated disadvantage of the trolley coach is its need to be captive to overhead wires, with a resulting lack of flexibility. Various options are available to permit differing degrees of off wire capability but at economic penalties that are not always commensurate with the supposed advantages. This section examines the various options from a technical standpoint, but within the context of operational advantages.

The necessary flexibility of any transit coach is a point of contention. Coaches are a fixed route service and deviations from this fixed route can be undesirable. A coach may deviate from its route onto streets that could involve turns that are difficult, hazardous and sometimes impossible. Missed stops on the fixed route, at any deviation, can leave patrons without service. Reliability of service is one of the 'quality of transit' factors that users rate highly. Consequently, some operators do not permit route deviations without specific authority of a supervisor. Others permit greater latitude to drivers. In this former case diesel coaches can be as functionally inflexible as trolley coaches.

Nevertheless, trolley coaches have greater restrictions if wire is torn down, commonly at intersections, if an accident or fire blocks a route, or if there is a major power outage. North American properties, where trolley coaches have no off wire capabilities, have successfully coped with many of these problems. Partial blockages are often bypassed by trolley coaches transferring to the opposite direction wires, or for short distances coasting with their poles down. This requires a supervisor or the driver of the following coach to handle the retriever ropes, pulling and holding them down after the coach has accelerated.

More serious blockages or power failures can be handled by route diversions. Many systems maintain sections of non-revenue wire to provide this flexibility particularly in the CBD. Diesel motor coaches can give shuttle coverage over the affected section or in extensive emergencies can substitute for the entire trolley coach route. The handling of such emergencies would be simplified with off wire capabilities. The difficulty comes in equating the additional cost with the very limited anticipated use.

Off wire capabilities can be classified into three groups.

1. Limited coach movement with impaired performance - This minimal off wire capability would permit trolley coaches to bypass route blockages, cross wire gaps or intersections, move around the garage without wire, move if stalled on a section gap, and have a very small off-route capability, e.g., around one block or up to half a mile (.8 km.). This can accommodate almost all operational problems except power outages, route blockages or wire failures longer than one block. It could permit a garage without overhead and the necessary complex and expensive special work.

Although the impaired (low speed) performance could slow garage moves, this need not be serious since such moves are generally short and vehicle speed is limited by safety requirements and overhead special work. This advantage would be limited to new garages as existing garages already have all the necessary special work which with limited use has an almost indefinite life.

Theoretically, this capability would also allow removal of unsightly special work at intersections. However the constraints and time delays on lowering and raising trolley poles by any of the three currently available methods may be unacceptable both to the transit operator and other traffic.

2. Moderate coach movement with slightly reduced performance - This off wire capability includes all the possibilities of group 1 off wire movement above plus regular off wire revenue movement for short turns, major emergency detours and route extensions, provided there are only limited grades and distances.

3. Extensive off wire operation with full performance - This capability includes the above two groups, plus extensive off wire revenue operation. A vehicle for this type of service is termed a hybrid coach.

The technology for off wire operation must involve some form of energy storage:

- o battery
- o flywheel
- o petrochemical.

In off wire operation, except for flywheel operation where the Garrett Air Research study data are used, it is assumed that a minimal auxiliary or hotel load will be imposed on the coach. Indeed air-conditioning and heating can be turned off for emergency moves where the

off wire power supply is limited. Over 80 percent of the trolley coaches in North America do not use air conditioning; San Francisco, Seattle, Boston, Vancouver, Edmonton, Hamilton, Toronto, Mexico City, Guadalajara versus Philadelphia and Dayton. Where desired, air conditioning imposes an average load of 7.2 KW. The preferred design for heating is to supplement primary sources with waste heat from the propulsion and braking systems. Unfortunately this ability is compromised in most present trolley coach designs where diesel coach bodies are used.

All off wire systems limit the grade climbing ability of the trolley coach as they cannot call on the high overload power available from the overhead line. Any significant grade represents a reduction (or a trade-off) in the travel range.

Battery Operation

Battery energy storage can cover a wide power range. The most basic concept and one used on several European properties is to increase the normal 24 volt coach battery by 3 or 4, 24 volt units. These batteries would normally be connected in parallel and be constantly charged by the regular auxiliary supply. When required for traction, a contactor changes the connection from parallel to series giving a 72 volt or 96 volt supply which can be fed to the motor through a simple control to give limited class 1 mobility. Speed and range are severely restricted, with typical values of 0.5 to 1.0 miles (0.8 to 1.6 km.) at speeds below 5-10 mph, (8 to 16 kmph) but the space and weight of the additional batteries are only modest, at about 400 to 800 pounds, (180 to 360 kg.) depending on capacity.

Batteries to provide significant off wire capabilities present major difficulties for transit applications. Although several high technology batteries have been developed with impressive energy densities and power to weight ratios, only the conventional lead acid battery is expected to be commercially available in the near future. Two types of new technology batteries supplied for aircraft use have been withdrawn or restricted due to failures resulting in fires or explosions. The weight and volume necessary to give reasonable performance cannot be accommodated in a North American transit coach without major redesign. The only full size (in fact slightly less than full size at 36 feet/11 meters) transit coach with adequate performance is the West German M.A.N. Electrobus which carries a 13,200 pound/6 MT battery pack in a 10 foot/3 meter trailer behind the coach. This provides sufficient energy for approximately 30 miles/48 km. of urban stop and go operation with a curb weight of 36,400 lbs. (16 MT). This coach has its batteries exchanged at a wayside station. If the coach were to operate under wires the battery could be recharged while in service. The 30 mile/48 km. range would not be necessary for most off wire applications and a smaller battery would suffice and could be sized according to the specific system requirements. For example, a 5 mile/8 km. range would require approximately 2,500 pounds/1.1 metric ton of batteries which could be fitted under the floor on a 40 foot/12 meter bus.

This capacity could provide a very attractive trolley coach/battery operation whereby only transit trunk routes are equipped with wire. The

coaches operate on the batteries in suburban areas and even downtown if overhead wires are prohibited. The only constraint is that the coach must spend adequate time under wire during each circuit to recharge the battery. In the above case with a 5 mile/8 km. range, a common section of 3 to 5 miles/5 to 8 km. could serve three branches of 2 to 2½ miles/3 to 4 km. each, and up to 2 miles through downtown. Thus with about 25 route miles/40 km. only 5 miles/8 km. or 20 percent of overhead would be required.

Greater battery capacity could be provided, but a vehicle redesign would be required to accommodate the additional weight. With a 10 mile/16 km. range, 5 mile/8 km. branches without wire are feasible. This would be a common situation on many North American radial transit networks. Two miles/3 km. through downtown (no overhead), a 5 mile/8 km. common section with overhead and three or more 5 mile branches could be operated. Only 15 percent of the route miles need be electrified.

If only emergency off wire capabilities are needed then a lesser battery capacity would be appropriate ranging down to the limited triple/quadruple auxiliary battery operation used in Europe. In emergency operation it is acceptable to have the trolley poles removed and replaced manually by the operator. In regular revenue service automatic trolley pole handling is desirable. Several systems are currently available or have been developed and are discussed in a subsequent section.

Trolley coaches with suitably tailored battery capability have potential on new systems where overhead wire does not yet exist. While new battery technology is anticipated in the longer term, the lead acid batteries carry a weight and cost penalty. They have a deep discharge cycle life of 500 to 1500 and, depending on the application, would require replacing every 2 to 6 years.

The use of trolley coaches with off wire battery operation in revenue service is a fairly new concept. There is no North American experience but the West Germans are pursuing this concept and operation of the DUO-Bus demonstration in Esslingen, West Germany is described at the end of this section.

In all cases of battery propulsion the use of chopper or AC inverter controls with regeneration can extend the range. Auxiliary power consumption is usually minimized. For short off wire operation the air brakes can use the storage capability of the air reservoirs. On longer off wire operations the air compressor will be required but heating loads can be reduced or eliminated. A system of storage heaters has been developed for the Esslingen DUO-Bus.

Flywheels

At the present state of the art for full size systems, the flywheel offers the best combination of energy density, power density as shown below.

Table 1.2-3

Energy Storage System Comparison

<u>Characteristics</u>	<u>Batteries</u>	<u>Flywheel</u>
Energy Density W-hr/lb.	8-14	3-12
Power Density W/lb.	10-30	100-200
Deep discharge cycle life	500-1500	> 1,000,000

The referenced UMTA study examines a hybrid trolley coach with a 6 KW-hour flywheel, which has a one mile/1.6 km. range between charges. This provides adequate emergency range but is limited for off wire revenue service.

The flywheel has other advantages as it serves at a receptive load at all times (up to full charge) rather than the partial receptivity of the overhead. This can conserve up to 30 percent of total vehicle energy demands. During acceleration, the flywheel augments overhead power, reducing the size requirements of substations, reducing voltage drops, and reducing the demand charge and kilowatt hour charges for power.

The proposed layout for a flywheel-augmented trolley coach is shown in Figure 1.2-10. The equipment has a total weight of 4,650 lbs./2 MT, slightly more than double a non-augmented propulsion system. The study of life cycle cost indicates that the cost-per-mile of an augmented bus is 89 percent of a standard trolley coach. (Based on 6.5 percent inflation and net present value costing over a 23 year life.) However, no contribution is included for research and development, and the flywheel costing is based on the production of 10,000 units. This may be an unrealistic expectation of mass production. UMTA is funding the development of the 6KW-hr. flywheel for a diesel-flywheel coach. The expanded market for a device common to both diesel and trolley coaches may make it possible to amortize the development and tooling costs over a reasonable number of units. This flywheel is identical with the trolley coach version. However, additional development work will be necessary to design electrical control equipment shown in Figure 1.2-10 before a trolley coach application is possible. A realistic costing of the flywheel based on the average production cost of units over an initial number of years could eliminate the above cost advantage.

Petrochemicals

Gasoline engines are fitted in many Swiss trolley coaches to provide off wire service. These are used for emergency moves and not for regular off wire revenue service. The engines therefore do not accumulate many

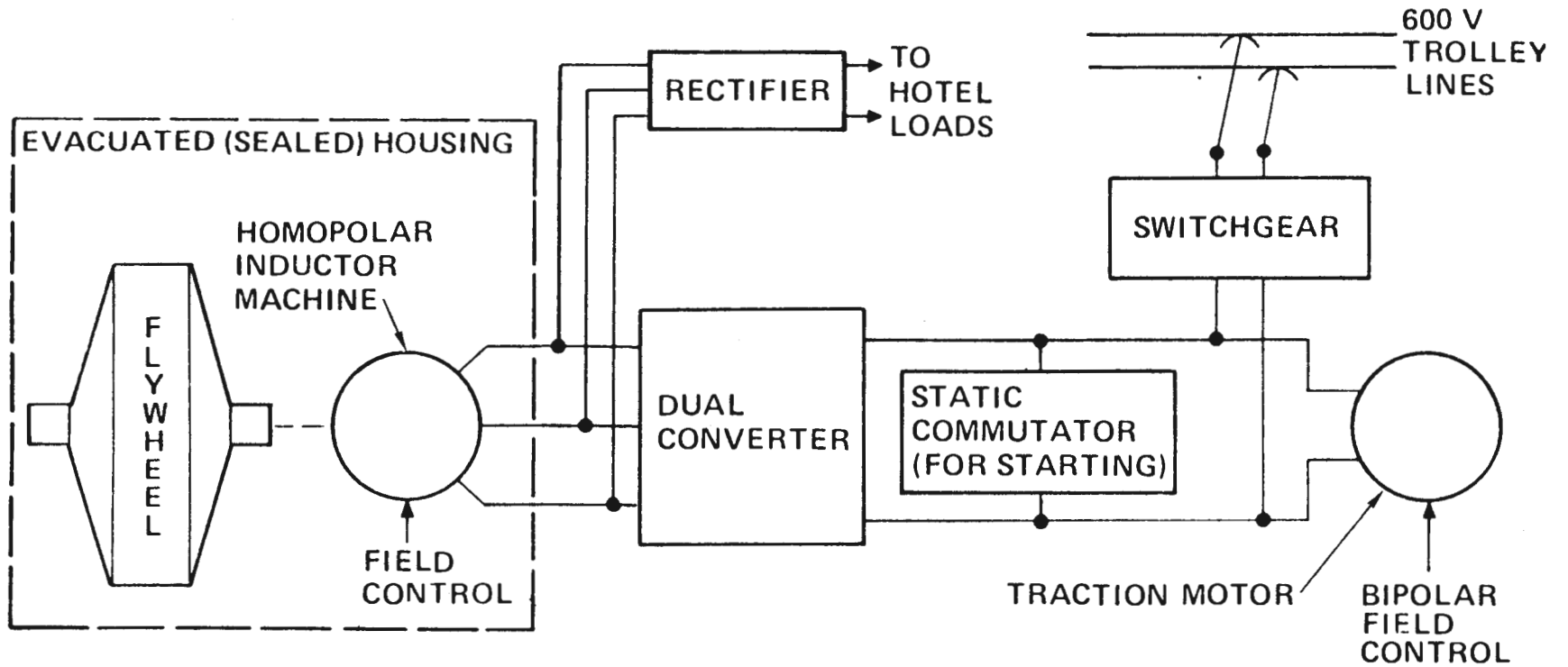

Figure 1.2-10

Equipment Layout for a Flywheel Augmented Trolley Coach

operating hours and their maintenance cost is modest with a long life. In all cases coach performance is impaired and grade climbing capabilities reduced. Range is dependent only on fuel capacity, but to avoid hauling around unnecessary weight, this is typically quite modest with ranges of 50 km/30 miles or less.

Diesel engines are employed by the French on their new Berliet ER100 coaches. Although these engines are intended for emergency use, some systems are using the off wire capability on a scheduled basis. Lyon, for example, has removed trolley wire on a portion of one route to aid Metro construction. Trolley coaches operate over that route section under auxiliary power.

Diesel generators - The Berliet ER100 trolley coach is equipped with a 43 kw/58 hp air cooled diesel engine model KHD F3L912, which drives the normal auxiliary motor as a generator through an electromagnetic clutch. A special off-wire control circuit provides excitation to this motor and controls power to the main traction motor through the same thyristor switched resistors used in overhead operation. This equipment permits the coach to attain a maximum speed of 24 mph/40 kmph, climb grades up to 8 percent with a level terrain range of 50 km/30 miles.

The Stromberg AC inverter trolley coach supplied to Helsinki and Winterthur is equipped with a 51 kw/68 hp diesel engine driving a 40 kw/54 hp three phase alternator. This permits a maximum speed of 45 kmph/27 mph. During off-line operation all non-essential auxiliary loads are removed to maximize power for traction.

Gasoline engines - Several Swiss trolley coach operators specify Volkswagen air cooled automobile engines, as shown in Figure 1.2-11, as auxiliary power supplies for off wire emergency operation, sometimes in addition to facilities to use the TC battery for short moves. This arrangement minimizes use of the internal combustion engine. The Volkswagen engine has been supplied in conjunction with electrical control equipment from both Siemens and Brown Boveri. The engine drives a 34 kw/46 hp three phase alternator which permits a maximum speed of 25 kmph/15 mph on the level with a full passenger load. Range is limited only by the size of the gasoline tank but is usually only modest.

Combinations of the Above

Combinations of these devices are possible, for example, batteries plus internal combustion engines so that the engines need not be started for short moves. However, any combination adds to the cost, weight and complexity of a vehicle and it is preferable to choose but one off wire system most suitable for the specific application. Combining diesel and flywheel or battery creates another type of hybrid coach which need not have any overhead sections, i.e., is no longer a trolley coach.

Summary

Off wire operating systems are readily available for a wide range of performance and travel distance. Most systems, so equipped, provide limited performance and limited range strictly for emergency use. There

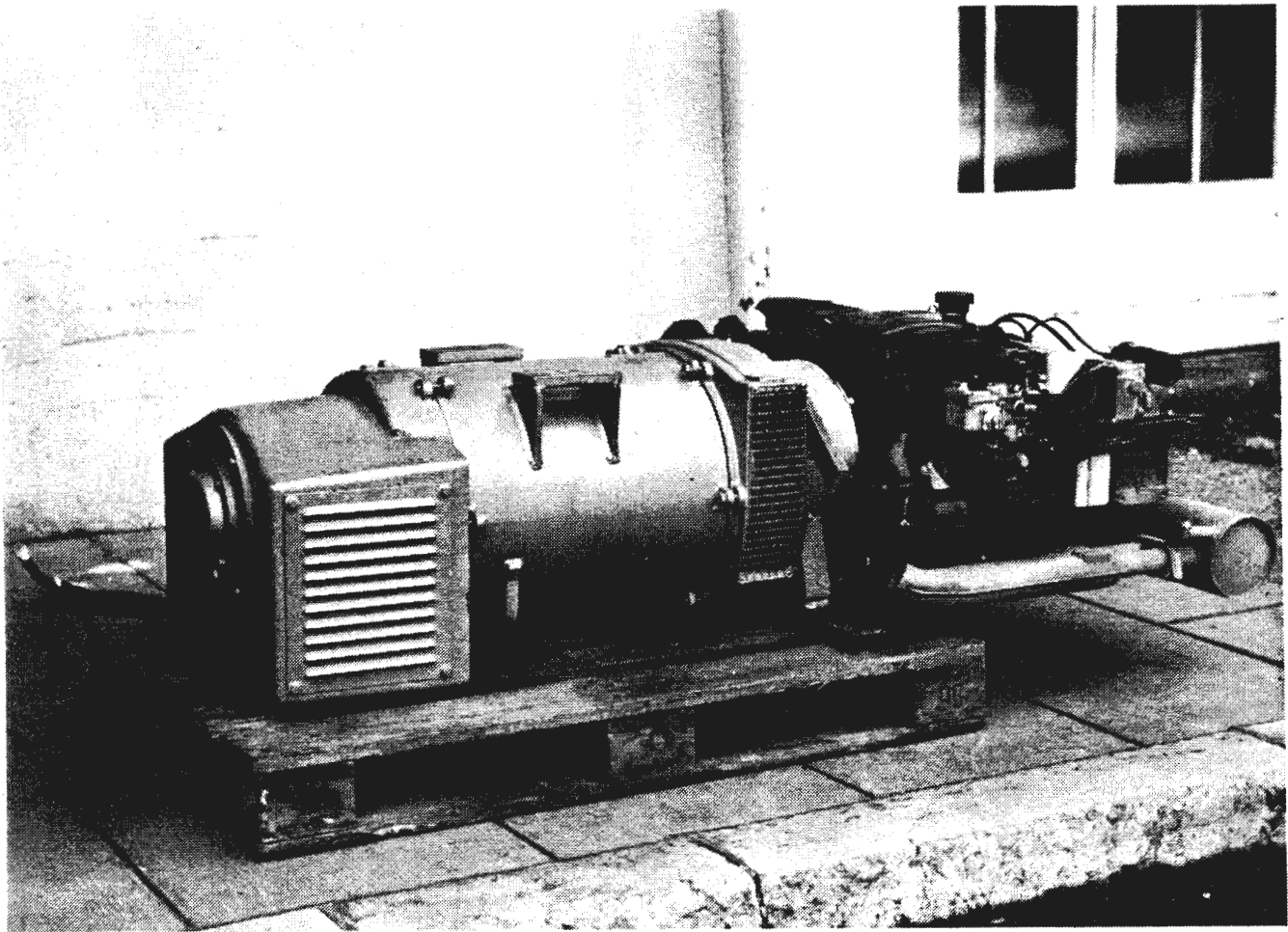

Figure 1.2-11

BBC/Secheron Auxiliary Power Plant
Using Volkswagen Engine

is controversy over the merit of providing off wire capabilities particularly the class two versions, which involve additional cost, weight and complexity of either a moderate sized battery, a flywheel, or a separate internal combustion engine generator. In part, the merits of an auxiliary system depend upon the value that operators place on increased reliability. Swiss trolley coach operators and to a smaller extent, those of other European countries, place a higher value on this than is common in North America.

The greater off wire capabilities provided with large batteries offer interesting possibilities for new applications. In addition to providing flexibility for emergency operation, it is possible to operate a network with only a small percentage of the routes equipped with overhead wire.

The West German Federal Minister of Research and Technology, beginning in 1975, has sponsored a development program in Esslingen with the Robert Bosch, Daimler-Benz and Dornier companies. One Daimler-Benz (Mercedes) OE 302 standard coach has been equipped with electrical propulsion and a 360 volt 210 ampere hour lead acid battery which adds about 3,000 lbs/1360 kg, some 15 percent, to the weight of the coach.

Dornier automatic trolley pole, controls described in a subsequent section of this chapter, are fitted to the DUO-Bus, which has a 10 km/6 mi. off wire range with an equal distance required under wire for recharging. Dornier has also developed a low power system which stores heat during travel under the wires and releases it at a controlled rate during travel off the wires.

The route network in Esslingen, shown in Figure 1.2-12, shows that DUO-Bus operation on ten routes is possible with wire on an 8 km/5 mi. of a total of 33 km/20 mi. of network. In terms of total duplicated route miles (the 8 km/5 mi. section is common to several routes), less than 15 percent would be equipped with overhead.

The West Germans indicate that compared with diesel coaches using un-taxed fuel, and discarding any environmental benefits, the Duo-Bus is not fully competitive. However with a premium given to the saving of petroleum, a DUO-Bus or similar system could have a positive value. Certainly with potential future improvements in energy storage, high technology batteries or high capacity flywheels, the DUO-Bus concept has merit for more study.

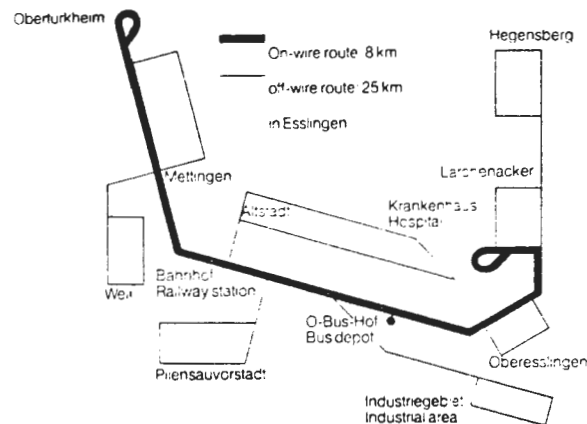

Figure 1.2-12

Esslingen (West Germany) Transit Route Structure, showing entire operation by DUO-Bus with one route only equipped with overhead. (Note that this route is wired terminal to terminal and could operate with conventional trolley coaches.)

Vehicles

The TC's offered by many American manufacturers in the period from 1930 to 1955 were a mixture of vehicle types. Some were designed from the ground up as trolley coaches, while others were modified motor coach designs. Firms such as Pullman, St. Louis Car and Marmon-Herrington designed and built only trolley coaches and did not enter the motor coach market. ACF Brill, Twin Coach and Mack built both vehicle types. These firms supplied a majority of the TC's ordered by the transit industry. The first two firms were also major suppliers of street railway vehicles and trolley coach production was a natural extension of their manufacturing expertise. The trolley coach was really a blend of existing street railway technology and the developing technology of the growing automotive field.

Street railway technology was most obvious in the electrical propulsion system where a rather significant technology transfer occurred. The vehicle body also reflected some street railway influence. Generally the bodies were wider than motor coaches of the same era. Width in excess of 96 inches/245 cm and lengths of 35 feet/10 meters were quite common in the early 1940's. The most striking resemblance was door widths (up to 3'10"/120 cm) which allowed for double stream entry and exit. Typical specifications for both pre- and post-war TC are shown in Tables 1.2-4 and 1.2-5. The vehicles are portrayed in Figure 1.2-13.

Current generation vehicles have not been designed specifically as TC's but instead employ modified motor coach bodies. Present TC fleets in the United States and Canada employ E700 and E800 vehicles from Flyer Industries and the E-10240 from AM General which were initially offered as motor coaches. The same can be said for TC's built in Europe by Berliet, M.A.N. (Graf and Stift) and FBW/HESS, and others. Differences do exist between TC's and motor coaches and are discussed in the section that follows.

Principal Differences

This section will deal with the significant differences, excluding propulsion and current collection systems, that exist between the two vehicle types. The systems excluded are dealt with in the following section.

Body Structure - The body structure for the two vehicles is essentially the same with two major exceptions. First, recent practice has been to attach the DC motor directly to the frame using conventional motor mounts. The configuration of the frame has to be altered to the motor's mounting points and normally requires strengthening to contend with the higher torque generated. The coaches currently being built by AM General employ a different approach. The DC motor and related propulsion control equipment have been placed in a cradle very similar to that used for diesel engines. The method of attachment to the vehicle frame is also similar. Alterations to the frame in this situation depend upon total weight placed on the cradle, approximately 2,400 pounds/110 kg for the AM General configuration, and the motor's torquing characteristics.

Table 1.2-4

Typical Specifications for Pre-War Trolley Coaches *

BUILDER	BRILL	PCF-BRILL	TWIN COACH
Year	1921	1940	1941
Model No.	Rail-less Car		
<u>DIMENSIONS (ft/mm)</u>			
Length	22/6710	33.8/10,300	33.5/10,210
Width	7.5/2290	8.3/2530	8.6/2620
Height	9.5/2900	10.5/3200	10.5/3200
Wheel Base	10.0/3050	18.0/5490	20.0/6100
Floor Height	2.8/850	N/A	N/A
Door Openings	N/A	N/A	N/A
Turning Radius	20.0/6100	41.0/12,500	43.0/13,110
WEIGHT (lb/kg)	9300/4218	20,800/9433	21,000/9524
CAPACITY (seats)	20	40	41
<u>PROPULSION EQUIPMENT</u>			
Motor	N/A	GE 1213	WH 1442
Rating of Motor (hp/kw)	25-50/19-37	140/104	125/93
Motor Control	Controller	Contactor	Contactor
Top Speed (mph/kmph)	20-30/40-48	40/64	40/64
Acceleration (mphs/mpsps)	N/A	N/A	3.5/1.6

* References 23 and 24

Table 1.2-5.

Typical Specifications for Post-War Trolley Coaches *

BUILDER	ACF-BRILL	MARMON	MARMON	PULLMAN	ST. LOUIS
MODEL NO.	TC-44	TC-44	TC-49	700	1947
<u>DIMENSIONS (ft/mm)</u>					
Length	35.2/10,730	36.5/11,130	39.8/12,130	40/12,190	37.2/11,340
Width	8.5/2590	8.5/2590	8.5/2590	8.5/2590	8.5/2590
Height (to roof)	10.0/3050	9.4/287-	9.4/2870	9.75/2970	--
Wheel Base	20.75/6320	19.6/5970	22.5/6860	22.1/6740	20/6100
Floor Height	2.8/850	2.8/850	2.8/850	2.9/880	--
Door Openings	2.4/730 (A)	4/1220 (B)	4/1220 (B)	4/1220	--
Turning Radius	45/13,720	41/12,500	43/13,110	43/13,110	42/12,800
WEIGHT (lbs/kg)	20,700/9387	17,250/7823	20,340/9224	21,350/9682	20,600/9342
CAPACITY (seats)	44	44	49	43	44
<u>PROPULSION EQUIPMENT</u>					
Motor	GE1213 or WH-1442	GE1213 or WH-1442	GE1213 or WH-1442	GE1213 or WH-1442	GE1213 or WH-1442
Rating of Motor (hp/kw)	140/104	140/104	140/104	140/104	140/104
Motor Control	Contacto (GE or WH)	Contacto (GH or WH)	Contacto (GE or WH)	Contacto (GE or WH)	Contacto (GE or WH)
Top Speed (mph/kmph)	40/64	40/64	40/64	40/64	40/64
Acceleration (mphs/mpsps)	3.6/1.6	3.6/1.6	3.6/1.6	3.6/1.6	3.6/1.6

* Reference 23 and drawings from the Massachusetts Bay Transportation Authority and the Chicago Transit Authority.

Notes

- A - Scaled dimension.
B - Front door only.

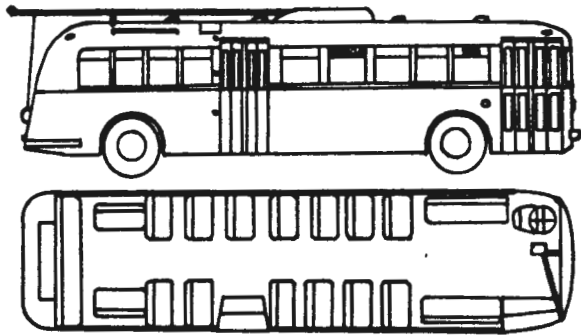

Seattle Twin Coach

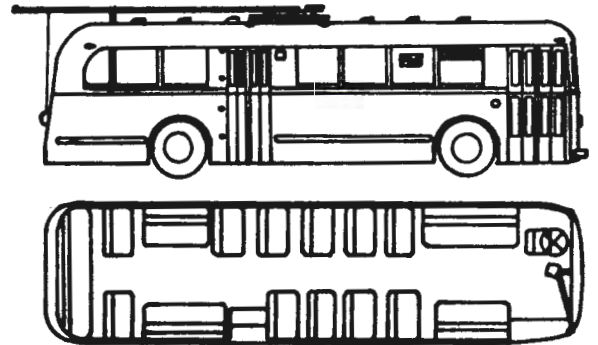

Seattle PCF Brill

Pre-War Trolley Coaches

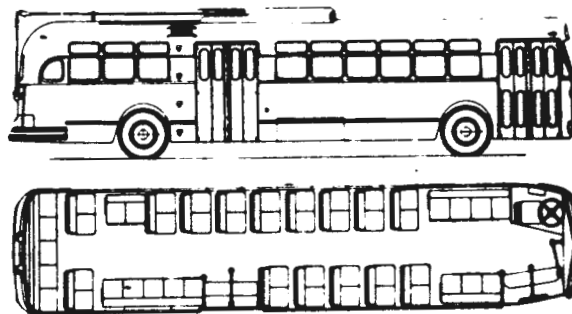

CTA Marmon Herrington
Post-War Trolley Coaches

Figure 1.2-13
Pre-and Post-War Trolley Coaches

The second difference relates to structural changes that have to be made in the roof structure of the vehicle to accommodate current collection equipment. The roof must be able to support the additional weight and the moment forces generated by spring tensioning in the current collection equipment. The moment forces are variable and depend upon the initial tension and the height of the poles. The force is greatest when the poles are in the down position. Pole bases are generally located at or slightly to the rear of the center doors. Location at the center door line on certain coaches can minimize or eliminate the need for modifications. Hold down devices for the trolley poles are located at the rear of the coach and must be strong enough to contend with the moment forces.

Rear Axle Assemblies - The rear axle on a motor coach has been especially designed to accommodate a Detroit-Diesel-Allison engine and transmission. It is an angle drive design and available with ratios of 6.14:1 and 5.59:1. The rear axle employed on trolley coaches has a 90 degree angle design, similar to that of an auto, a ratio of 11.59:1 and is designed to absorb the high torque of a DC motor.

Brake System - The air brake system on current trolley coaches is identical to that of a motor coach. The air compressor, rather than being directly driven by the diesel engine, has its own 3 hp 600 volt DC motor. Additionally, trolleys have a dynamic braking system which is described elsewhere.

Low Voltage Power - Motor coaches utilize either a 12 or 24 volt electrical system to provide for battery charging, lights, engine starting and other service needs. The system incorporates a generator which is driven by the diesel engine. Low voltage on TC's was originally provided by motor generator sets, but they have since been replaced by static convertors (a solid state electronic device) which reduce 600 volt DC to 13.7 volt DC.

Heating and Air Conditioning Systems - The heating system on diesel coaches utilizes engine generated heat. The engine's coolant is piped to a heating core (a heat transfer device) where outside air is heated and then ducted into the coach interior. On current generation trolley coaches the heater core has been replaced with a 600 volt electrical resistance unit of the radiant heat type. TC's also have the ability to use brake and accelerator resistance heat but complexity of adapting existing heat duct systems has mitigated against its use. If air conditioning is required, a small DC motor will have to be installed to operate the compressor.

Insulation - Since a trolley coach is a rubber tired vehicle, it can develop an electrical potential to ground. Shocks can be obtained as passengers enter or alight from the coach. This problem is overcome in two ways. First, doors and all handrails reachable while standing outside the TC must be insulated. Second, the TC can be equipped with a meter that measures potential to ground. The coach can then be removed from service when unsafe levels are recorded.

New Generation Vehicles - U.S. and Canada

Following the delivery of TC's to Philadelphia in 1954, no TC's were manufactured for 17 years. During the period all of the previous manufacturers went out of business or were no longer willing to build TC's. The first transit operator in North America to express an interest in new TC's was Toronto Transit Commission (TTC). In 1971 the two new coach bodies were equipped with rehabilitated electrical equipment taken from older coaches. TTC was seeking to determine if it could replace the existing TC fleet at a reasonable cost and the feasibility of reusing existing electrical equipment. The experiment was a success and a decision was made to reequip the existing fleet. TTC purchased 150 Flyer E700 bodies and installed electrical equipment in its own Hillcrest Shops.

Several other Canadian properties soon followed suit as Hamilton, Edmonton and Vancouver opted for new bodies with rebuilt electrical equipment. Flyer Industries supplied these vehicles and became the sole manufacturer of TC's in North America. Dayton was the first US transit operator to test a new TC. A Flyer E700 body was purchased and also employed with rebuilt electrical equipment.

Systems in the U.S. began to consider new fleets and decisions were made to reequip. San Francisco, Boston and Dayton purchased 457 vehicles from Flyer Industries, (345, 64 and 50, respectively). This was followed by a combined order for 219 vehicles for Seattle and Philadelphia (109 and 110 respectively) which are to be supplied by AM General. The new vehicles built by Flyer for U.S. properties have all incorporated GE 1213 motors and GE MRC (contactor) propulsion control equipment. The propulsion technology is very similar to that employed during the 1930's and 1940's. The AM General buses, shown in Figure 1.2-14, will use a chopper propulsion control system, developed by Randtronics, in connection with GE 1213 motors. Flyer and AM General are the only North American builders of TC's. In an earlier bidding process in Philadelphia, which did not go to contract, the Flxible Company had indicated its willingness to enter the market. General Motors has not recently indicated it has any interest in manufacturing TC's.

Presently it is difficult to state which U.S. companies would respond to bid requests for new TC's. AM General has indicated it will no longer build the type of coaches now being delivered to Seattle and Philadelphia. Flxible and GMC are not supplying "new look buses" and have switched production to the Advanced Design Bus (ADB). Both of these vehicles appear to be adaptable to TC operation. If existing regulations issued by the Department of Transportation continue in force, a totally new coach, designed in accordance with the Urban Mass Transportation Administration's Transbus standards, will have to be supplied after 1979. These standards will require a 22 inch/156 cm. floor height and a ramp for wheelchair access. The willingness of manufacturers to build TC's after 1979 will depend upon the size of the order and the extent to which these vehicles will have to be modified to accommodate electrical propulsion.

Flyer Industries is currently offering an E900 model TC, shown in Figure 1.2-15. It is similar to the E800 except for external body style changes. Although currently available, this vehicle does not conform to the Transbus standards.

New Generation Vehicles - European

European trolley coach designs are mostly derived from motor coach designs in a manner similar to North American designs. Unlike light rail equipment design, the state of the art of trolley coach design is parallel in both Europe and North America. The only significant difference is the greater use of articulated vehicles in some European countries. Again, this is not unique to trolley coaches, but follows the acceptance of articulated motor coaches in these countries. Also, auxiliary power systems have been widely accepted in Europe, but are almost unknown in North America.

Swiss Standard - While Toronto was contemplating new TC's, a similar effort was under way in western Europe. During the late 1960's and early 1970's the numerous Swiss TC operators, through their trade association, Association of Swiss Transit Operators (VST), approached suppliers to develop a standard trolley coach. Standards were to cover both 2 axle and 3 axle coaches. The carrot, which was provided to the suppliers, was a market of 500 vehicles to be used for replacement and expansion. In Switzerland a market of that size is quite significant.

The suppliers responded and by late 1974 orders were in hand for over 100 vehicles. A description of these vehicles appears at the end of this section in Figures 1.2-16 and 1.2-17. These new TC's were a significant departure from their predecessors. Apart from the body style and the incorporation of an auxiliary thermal motor, the major change was the addition of a chopper propulsion system. Earlier trials in St. Gallen had shown that choppers reduced power consumption 15 to 20 percent, depending on traffic conditions, and maintenance costs.

The new generation trolley has also witnessed a change in vehicle preference. Prior to 1970 2 axle vehicles were favored over 3 axle vehicles by a ratio of four to one. New orders have reversed the ratio which is now one to five. This situation reflects the Swiss desire to improve vehicle and driver productivity. Typically, articulated vehicles have four doors and operate in conjunction with a self-service fare system.

Lausanne has opted to purchase only 2 axle TC's. These vehicles are used with trailers which provide greater capacity than 3 axle vehicles. Lausanne is a hilly city and there is concern about the ability to operate articulated vehicles on heavy grades in ice and snow conditions. The trailer operation provides the flexibility of returning to straight 2 axle operation when conditions warrant. Available capacity is diminished but the system can still deliver service.

The use of trailers is not widespread in either Switzerland (they are used only in Lausanne and St. Gallen) or elsewhere in Western Europe. Their use appears to be limited to special situations, such as that

sited above, and some countries, Germany for example, presently prohibit their use. Vehicle safety does not appear to mitigate against their use since they are subject to very restrictive safety regulations in Switzerland. The use of trailers in the U.S. does not appear feasible for the following reasons:

- o The use of trailers would first require the implementation of a self-serve fare system since they would be unmanned.
- o The unattended vehicle would increase concern for a rider's personal safety since the driver does not have direct access.
- o Articulated technology supplanted the need for trailers except in special cases.

Switzerland has no one firm that accepts responsibility for total coach production. Transit operators must deal with three different firms to secure a trolley coach. These firms are as follows:

Chassis and Drive Components
Franz Brozincevk & Co. - (FBW)

Bodies and Interiors
Carrosserie Hess (Hess)
Ramseyel & Jenzer (R&S)

Propulsion Equipment
Secheron - BBC

The chassis is manufactured in Wetzikon and then moved to either Bern (R&S) or Bellach (Hess) where the body is outfitted. The vehicle then moves to Geneva for outfitting of the electrical equipment. In certain cases it is returned to Hess or R&S for final interior appointments.

New coaches, which have been ordered by Lugano and Lucerne, have utilized the following manufacturers:

Chassis and Drive Components
Volvo (main chassis only)
Schenk (articulated chassis)

Body and Interior
Hess

Propulsion Equipment (contactor type)
Siemens

These vehicles appear to accommodate most of the Swiss standard features but employ the more conventional Siemens contactor propulsion control system.

M.A.N./Graf & Stift - M.A.N., in connection with its subsidiary Graf & Stift (G&S) offer both 2 axle and articulated TC's. The articulated are available in both 16.5 and 18 meter lengths. The articulated will accommodate four doors and the 2 axle three doors. Doors may be

installed behind the rear axle. Both types of coaches have recently been delivered to the Austrian cities of Kappenberg and Salzburg. In appearance they closely resemble the M.A.N. Articulateds being delivered in this country. The most recent orders of G&S coaches have included a Keipe contactor propulsion on the system. At the present time M.A.N. is considering the possibilities of the pulse width modulation system and may decide to bypass chopper technology. The vehicles are described in Figure 1.2-18 and 1.2-19.

M.A.N.'s current association with AM General makes it possible to consider the importation of articulated TC technology. Many of the existing TC routes in this country have the necessary route density to support this type of equipment. G&S is also familiar with the American market, having been a participant in the original bidding for articulates in Seattle.

Berliet - The French firm of Berliet, a subsidiary of Renault Vehicles Industries, has entered the TC market by redesigning its PR100 coach, as shown in Figure 1.2-20, to accommodate electrical propulsion. Presently 185 vehicles have been delivered to the French cities of Grenoble, Lyon and St. Etienne. The propulsion equipment has been remanufactured by Traction CEM Oerlikon from older retired coaches. A hybrid switched resistor control is employed and fully described in a previous section. One interesting design feature of this coach is its floor height of 25.8 inches/66 cm. at the front door. The floor rises and height at the rear most door is 26.8 inches/68 cm. Seats are installed on pedestals which necessitate a further step prior to sitting down. The coach design will accommodate 3 doors. A door behind the rear axle is precluded due to under floor equipment.

Berliet has not yet sold any vehicles in this country but has entered into an agreement with Trans-Diesel, Inc. of California to market this vehicle in the U.S. The vehicle has been modified to meet the U.S. standards.

Sumen/Wiima/Stromberg - The transit operator in Helsinki has been seeking to purchase new TC's to restore service on an existing trolley line and for expansion purposes. One prototype is being built for testing and it is described in Figure 1.2-21. The coach body is similar to present generation diesel buses now in service. Like the Berliet vehicle, the Finnish coach has a low floor but it is level between the front door and the rear door. All seats in this section of the coach are on pedestals reflecting the need for underfloor space. Access to the area behind the rear door requires use of an internal step riser.

The important feature of this vehicle is the incorporation of a pulse width modulation propulsion control system which permits the use of AC motors. This system is described in a previous section. Experience with this system in several rail system applications indicates that it may become the dominant propulsion technology.

The Finnish vehicle is not currently being marketed in North America and it is doubtful that any will be imported. The propulsion system

technology is a different matter. If this system proves out in the trials currently underway, transit operators and suppliers in North America may want to consider it for possible application should the need for additional TC's arise.

Ikarus - The Ikarus coach is produced in Hungary in both 2 axle and articulated versions. The articulated version, type 280TB, shown in Figure 1.2-22 is currently in service in Budapest. Ikarus had tried to enter the U.S. market in early 1970's when it entered the bidding for vehicles in Seattle. Ikarus is currently marketing its type 286 articulated in this country through Crown Coach of California. This vehicle is similar to the 280TB except that modifications have been made to meet U.S. standards. The vehicle is available in 16.5 and 18 meter lengths and can be obtained with varying door arrangements and a wheelchair option.

Skoda - This coach is built in Czechoslovakia and is marketed primarily to Eastern Block countries. Some sales have been made to China, Norway and India. The current model is the 9Tr shown in Figure 1.2-23. This particular model has been built since 1961, with some alterations, and over 5,500 have been placed in service. The vehicle is 36 ft./11 meters long and is available in 2 or 3 door configurations. Skoda has not marketed articulated vehicles.

Orders for 200 9Tr vehicles were placed in 1977, but it appears that construction may be switched to a new 2 axle TC type 14Tr. This vehicle is much closer in appearance to newer Western European TC's. Presently 2 vehicles of this type are in service in Marianske Lazne, Czechoslovakia.

Energomach Export (USSR) - Russia is today the world's largest operator of TC and has built literally thousands of vehicles. Formerly, Russian built vehicles were used principally on domestic systems. Presently Russian vehicles are being marketed in Eastern European countries in competition with Skoda and Ikarus. A recent order was purchased by Athens, Greece. The current vehicle is the ZIV-9 and is described in Figure 1.2-24. The vehicle is 12 meters long and it is not known if an articulated version is available.

There have been several attempts by the Russians to market their new vehicle in the West but without success. They did participate in the 1975 bidding for new TC's in Vancouver.

Daimler-Benz - A part of the DUO-Bus Project, being undertaken by the German Federal Republic, Daimler-Benz, in conjunction with Robert Bosch and Dornier, have built five prototype all-service vehicles. Two of the vehicles will employ battery/TC coach propulsion and the remaining 3 will use diesel/TC propulsion. The diesel/TC coaches will use a torque convertor in both the electric and diesel modes. The electric motor will not provide direct drive and is in constant rotation when it is the prime mover. Driving speeds will be obtained by field controlling the motor. Figure 1.2-27 indicates the configuration of the propulsion equipment. All five of these coaches have had the Dornier automatic retrievers installed, which is described in a subsequent section.

The five all-service vehicles will employ the following body types:

Battery/TC - Daimler Benz 0-305 - two vehicles
Diesel/TC - Daimler Benz 0-305 - two vehicles
Diesel/TC - Daimler Benz 0-305-G - one vehicle

These vehicles are further described in Figures 1.2-25 and 1.2-26.

The 0-305-G employs a different design concept. The engine is in the trailer and the drive is through the rear axle. The articulated joint is electro-hydraulically controlled to prevent jack-knifing and unstable driving. The rear placement of the drive units has permitted the coach floor to be lowered to 28.7"/729mm. Normal floor heights on articulated vehicles vary between 32"/813mm and 36"/914mm. A rear door is precluded and only one door is allowable in the trailer section.

Daimler-Benz, in conjunction with Secheron and Siemens, is assembling an 0-305 trolley coach as a demonstrator. This vehicle will be used to promote sales in the South American market.

Articulated Vehicles

Owing to the widespread use of articulated TC's in Europe, a few comments are required concerning its deployment and functioning. The articulated vehicle is one part of an overall program to increase operating staff productivity. The other elements of the program are:

- o Vehicle entry and exits must occur throughout the length of the vehicle and door openings must be maximized.
- o A self-service fare system must be implemented.
- o A high percentage of fare payments must be converted to bulk purchases, and appropriate sales outlet provided.

The driver duties are reduced to driving the vehicle and he is no longer required to verify that patrons have paid the correct fare.

It would not be feasible to place a standard European articulated TC in service on a typical urban route in this country without changes in the fare system. The driver is not in a position to verify fare payment when more than one door is available for entry. A reduction in this number of doors would solve this problem, but dwell time would increase due to increased passenger movement within the vehicle and the necessity to have all passengers enter via the front door. The increase in dwell time will negate the articulated's contribution to productivity. Most American operators of this vehicle type purchase two door versions and will employ them primarily in suburban express service. In this situation, average trips are longer, and passenger turnover is low, thus reducing dwell time problems. The articulated light rail vehicles currently operated in Boston, and soon to be operated in San Francisco, overcome these problems since fares are collected at stations in central city areas.

Figure 1.2-14 AM GENERAL TWO AXLE TROLLEY COACH

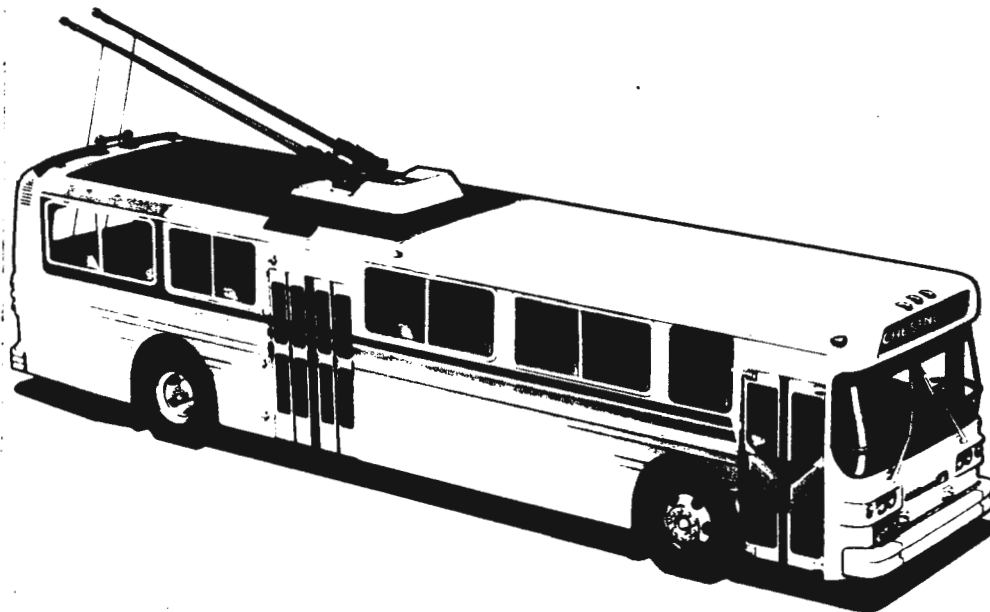

BUILDER: AM GENERAL

MODEL NO. 10240-E

ELECTRICAL EQUIPMENT SUPPLIER: RANDTRONICS/GE

DIMENSIONS (ft/mm)

Length - overall	40/12192
Width - overall	8.5/2591
Height - overall	10.3/3139 (1)
Wheel Base	23.7/7224
Floor Height	2.8/853
Door Openings (between handrails)	2.5/762 (2)
Minimum Turning Radius	37.2/11339

WEIGHT EMPTY (lbs/kg)	23500/10657
-----------------------	-------------

CAPACITY (seats/standees)	50
---------------------------	----

PROPULSION AND PERFORMANCE

Motor	GE 1213. Compound 600 Volts DC
Rating of Motor (hp/kw)	155/116
Motor Control	Randtronics Chopper
Top Speed (mph/kmph)	37/60
Acceleration (mphs/mpsps)	3.5/1.6

AUXILIARY POWER

Top Speed (mph/kmph)	Not included
----------------------	--------------

STATUS	Production Model
--------	------------------



NOTES FROM SPECIFICATIONS:

1. Height is from road surface to the top of the roof.
2. Center door is 2.2 feet/670mm.

SOURCE OF INFORMATION:

AM General Corporation
32500 Van Born Road
Wayne, Michigan 48184

Figure 1.2-15

FLYER TWO AXLE TROLLEY COACH

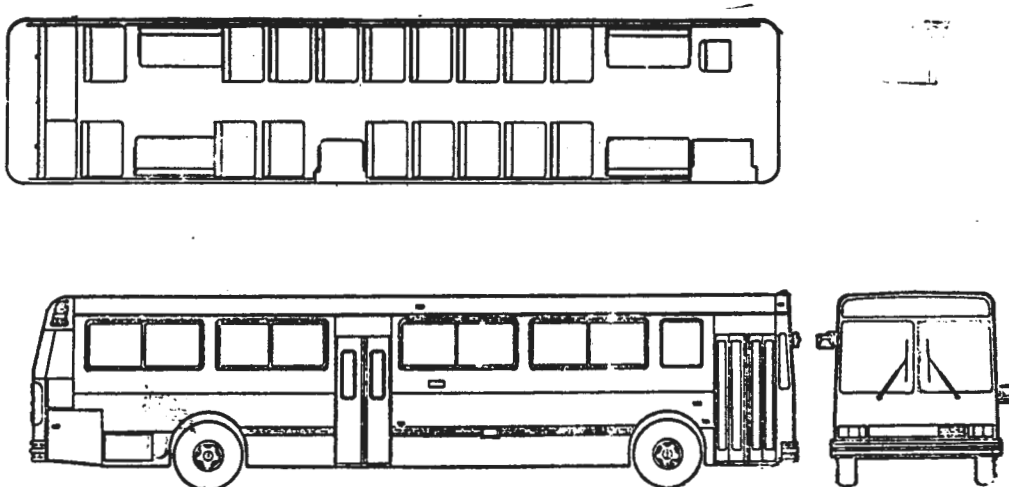

BUILDER: FLYER
 ELECTRICAL EQUIPMENT SUPPLIER: GENERAL ELECTRIC (2)

MODEL NO. E900-10240
 (1)

DIMENSIONS (ft/mm)

Length - overall	40/12192
Width - overall	8.5/2590
Height - overall	10.2/3109 (3)
Wheel Base	23.7/7224
Floor Height	2.9/884
Door Openings (between handrails)	2.5/762 (4)
Minimum Turning Radius	37.2/11339

WEIGHT EMPTY (lbs/kg) 23000/10431

CAPACITY (seats/standees) 51

PROPULSION AND PERFORMANCE

Motor	GE 1213 Compound 600 Volt DC
Rating of Motor (hp/kw)	155/116
Motor Control	Cam control switched resistor (5)
Top Speed (mph/kmph)	40/67
Acceleration (mphs/mpsps)	3.5/1.6

AUXILIARY POWER

Top Speed (mph/kmph) Not included

STATUS Production Model



Photo is of an E800 coach which is similar except for the front end exterior design.

NOTES FROM SPECIFICATIONS:

1. This coach is similar to E800 TC except that certain exterior body changes have been made.
2. Electrical supplier can be specified.
3. Height from road surface to top of roof.
4. Front door only. The center door has a clear opening of 2.2ft/672mm. A double stream center door can be provided.
5. Chopper system can be specified.

SOURCE OF INFORMATION:

Flyer Industries Limited
64 Hora Street
Winnipeg, Manitoba R2C-2Z4

Figure 1.2-16

SWISS STANDARD TWO AXLE TROLLEY COACH

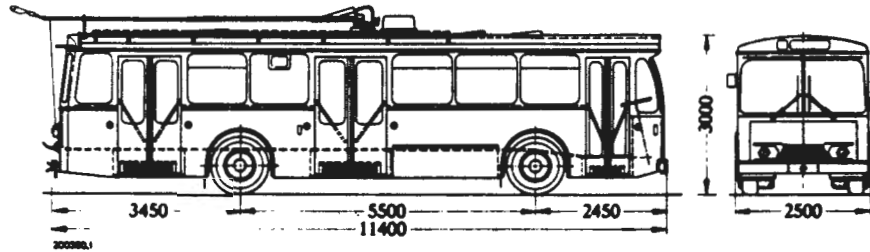

BUILDER: FBW/HESS or R&S (1)

MODEL NO. Swiss

ELECTRICAL EQUIPMENT SUPPLIER: Secheron-BBC

Standard FBW 91T

DIMENSIONS (ft/mm)

Length - overall	37.4/11400
Width - overall	8.2/2500
Height - overall	9.8/3000 (2)
Wheel Base	18/5500
Floor Height	2.6/785 (3)
Door Openings (between handrails)	N/A
Minimum Turning Radius	N/A

WEIGHT EMPTY (lbs/kg) 26019/11800

CAPACITY (seats/standees) 29/60

PROPULSION AND PERFORMANCE

Motor	Secheron 4EL62553 Series 600 Volt DC
Rating of Motor (hp/kw)	197/147 (continuous - hp/kw)
Motor Control	Chopper
Top Speed (mph/kmph)	37/60
Acceleration (mphps/mpsps)	N/A

AUXILIARY POWER

Top Speed (mph/kmph) 16/25 (15.535)

STATUS Production Model

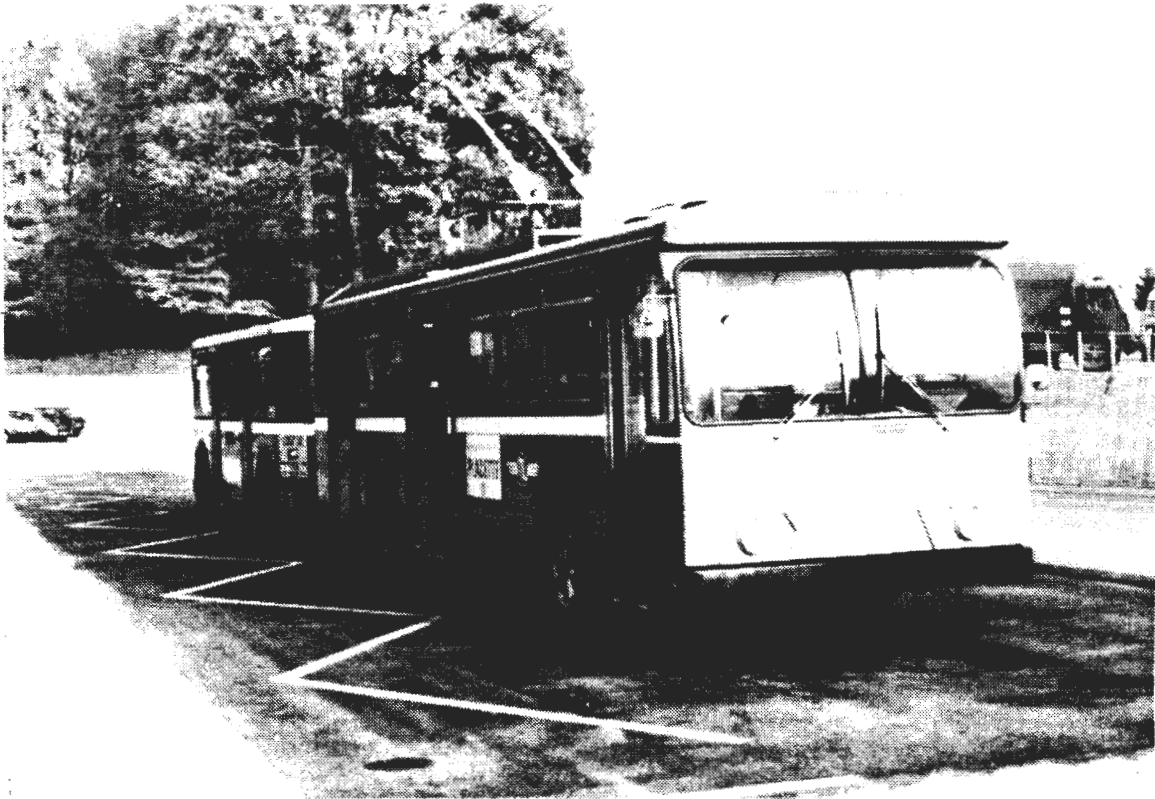

Photo is of a two axle trolley coach
with a trailer in Lausanne.

NOTES FROM SPECIFICATIONS:

1. FBW manufactures the chassis. Hess or R&S manufactures the body.
2. Height from the road surface to top of roof.
3. Scaled dimension at the front door. The floor height varies and increases in the rear portion of the coach.

SOURCES OF INFORMATION:

Secheron Works Ltd.
CH 1212 Geneva, Switzerland

Franz Brozincevic & Co. Ltd.
Motorenstrasse 100
CH 8621 Wetzikon, Switzerland

Figure 1.2-17 SWISS STANDARD ARTICULATED TROLLEY COACH

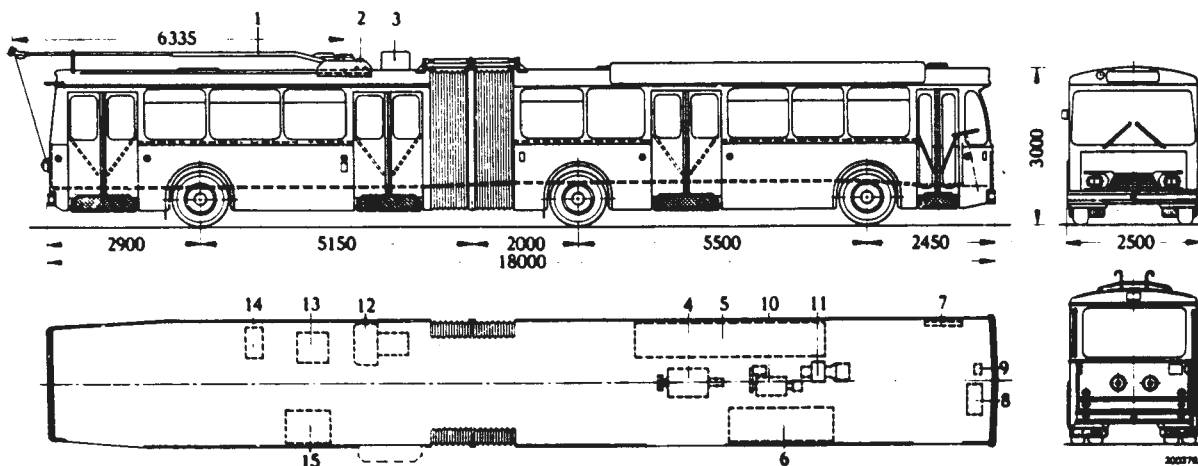

BUILDER: FBW/HESS or R&J (1)
 ELECTRICAL EQUIPMENT SUPPLIER: Secheron - BBC

MODEL NO. Swiss
 Standard FBW 91GTL

DIMENSIONS (ft/mm)

Length - overall	59.0/1800
Width - overall	8.2/2500
Height - overall	9.9/3000 (2)
Wheel Base	18-23.5/5500-7150
Floor Height	2.6/785 (3)
Door Openings (between handrails)	N/A
Minimum Turning Radius	N/A

WEIGHT EMPTY (lbs/kg) 34177/15500

CAPACITY (seats/standees) 44/115

PROPULSION AND PERFORMANCE

Motor	Secheron 4ELG2553 Series 600 Volts DC
Rating of Motor (hp/kw)	197/147
Motor Control	Chopper
Top Speed (mph/kmph)	37/60
Acceleration (mphs/mpsps)	N/A

AUXILIARY POWER

Top Speed (mph/kmph)	16/25
----------------------	-------

STATUS



NOTES FROM DRAWING:

- | | |
|-----------------------|---|
| 1. Trolley | 8. Control Electronics |
| 2. Lightning Arrestor | 9. Angle Transmitter |
| 3. Protection Unit | 10. Motor/Compressor/Generator Set |
| 4. Traction Motor | 11. Chopper Fan |
| 5. Chopper | 12. Thermoelectric Emergency Power Unit |
| 6. 600V Switch Gear | 13. Control Gear - Emergency Power Unit |
| 7. 24V Switch Gear | 14. Petro Tank - Emergency Power Unit |
| | 15. Storage Battery |

NOTES FROM SPECIFICATIONS:

1. FBW manufactures chassis; Hess or R&J manufactures the body.
2. Height from road surface to top of roof.
3. Scaled dimension at the front door. Floor height varies in drive unit.

SOURCE OF INFORMATION:

Secheron Works Ltd.
CH 1202 Geneva, Switzerland

Franz Brozincevic & Co. Ltd.
Motor Entrasse 100
CH 8621 Wetzikon, Switzerland

Figure 1.2-18 M.A.N. TWO AXLE TROLLEY COACH

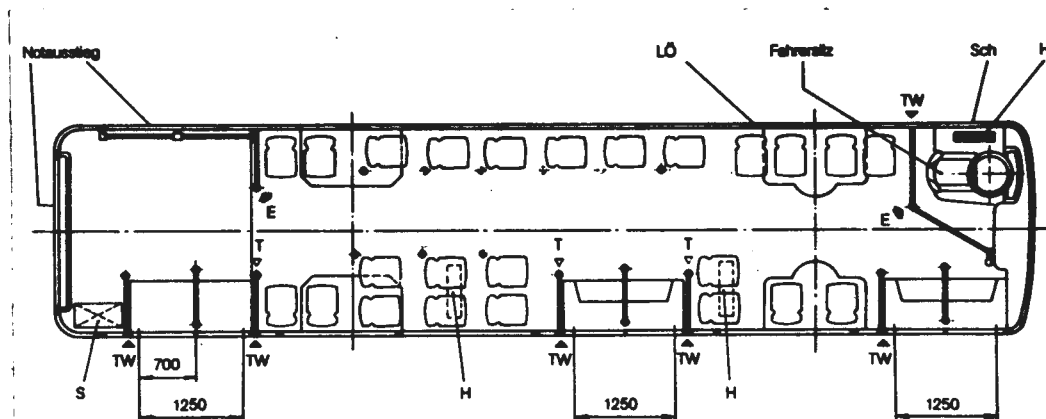

BUILDER: MAN (GRAF & STIFT)
 ELECTRICAL EQUIPMENT SUPPLIER: KIEPE ELECTRIC

MODEL NO.
 OE-110/54/A

DIMENSIONS (ft/mm)

Length - overall 38.0/11565
 Width - overall 8.2/2500
 Height - overall 11.3/3460 (1)
 Wheel Base 17.9/5450
 Floor Height 2.8/855
 Door Openings (between handrails) 4.1/1250
 Minimum Turning Radius 34.1/10382

WEIGHT EMPTY (lbs/kg) 21609/9800

CAPACITY (seats/standees) 24/83 (2)

PROPULSION AND PERFORMANCE

Motor Keipe, Compound 600 Volt DC
 Rating of Motor (hp/kw) N/A
 Motor Control Contactor
 Top Speed (mph/kmph) 51/60
 Acceleration (mphs/mpsps) N/A

AUXILIARY POWER

Top Speed (mph/kmph) Not included

STATUS Production Model



NOTES FROM SPECIFICATIONS:

1. Height including the current collection equipment in the secured position.
2. Standees based on $1.6\text{ft.}^2 / .15\text{m}^2$ per person.

SOURCES OF INFORMATION:

Graf & Stift A.G.
A-1211 Wein
Brunner Strasser 72

American M.A.N.
1114 Sixth Avenue
New York City 10036

Figure 1.2-19 M.A.N. ARTICULATED TROLLEY COACH

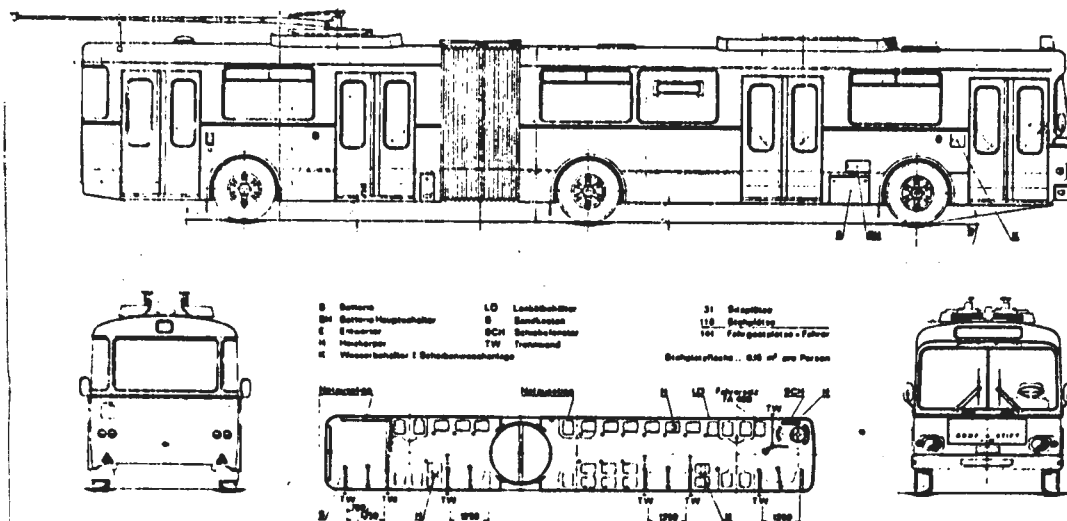

BUILDER: M.A.N. (GRAF & STIFT)

ELECTRICAL EQUIPMENT SUPPLIER: KIEPE ELECTRIC

MODEL NO.

GE-110/54/57 A

DIMENSIONS (ft/mm)

Length - overall	54.1/16500 (1)
Width - overall	8.2/2500
Height - overall	11.3/3460 (2)
Wheel Base	18.8-17.9/5745-5450
Floor Height	2.8/855
Door Openings (between handrails)	4.1/1250
Minimum Turning Radius	34.1/10400

WEIGHT EMPTY (lbs/kg) 28665/13000

CAPACITY (seats/standees) 31/100 (3)

PROPULSION AND PERFORMANCE

Motor	Keipe, Compound 600 Volt DC
Rating of Motor (hp/kw)	N/A
Motor Control	Contactora (other types available)
Top Speed (mph/kmph)	37/60
Acceleration (mphs/mpsps)	N/A

AUXILIARY POWER

Top Speed (mph/kmph) Not included

STATUS Production Model



NOTES FROM SPECIFICATIONS:

1. Also available in 59ft/18000mm length.
2. Height including the current collection equipment in the secured position.
3. Capacity of the 18 meter vehicle is 41/118. Optional seating arrangements available.

Standees based on $1.6\text{ft.}^2 / .15\text{m}^2$ per person.

SOURCES OF INFORMATION:

Graf & Stift A.G.
A-1211 Wein
Brunner Strasser 72

American M.A.N.
1114 Sixth Avenue
New York City 10036

Figure 1.2-20 BERLIET TWO AXLE TROLLEY COACH

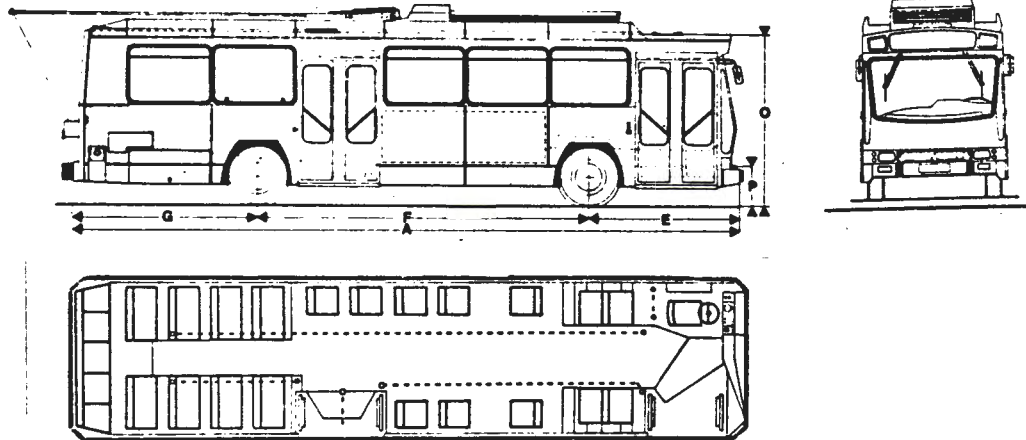

BUILDER: BERLIET
 ELECTRICAL EQUIPMENT SUPPLIER: TRACTION CEM OERLIKON

MODEL NO. ER100

DIMENSIONS (ft/mm)

Length - overall	37.0/11280
Width - overall	8.2/2500
Height - overall	9.6/2930 (1)
Wheel Base	18.4/5600
Floor Height	2.1/655 (2)
Door Openings (between handrails)	3.9/1200 (3)
Minimum Turning Radius	34.4/10500

WEIGHT EMPTY (lbs/kg) 23891/10835

CAPACITY (seats/standees) 33/65 (4)

PROPULSION AND PERFORMANCE

Motor	Oerlikon 4ELC 2330-T Compound 600 Volt DC
Rating of Motor (hp/kw)	168/125
Motor Control	Modified contactor (5)
Top Speed (mph/kmph)	37/60
Acceleration (mphs/mpsps)	2.1/1.0

AUXILIARY POWER

Top Speed (mph/kmph) 25/40

STATUS Production Model



NOTES FROM SPECIFICATIONS:

1. Height from road surface to top of roof.
2. The floor height rises from the front door to the rear door.
The floor height at the rear door is 2.2ft/680mm.
The gradient rises to the rear of the TC to provide clearance
for underbody propulsion equipment.
Seats are placed on pedestals to overcome the floor slope
and to provide room for propulsion equipment.
3. The body can be equipped with a third door.
4. Capacity with three doors is 28/66.
5. Please refer to the section on propulsion control equipment
for full details.

SOURCE OF INFORMATION:

Berliet
Renault Vehicules Industriels
33 Quai Gallieni
92153 Sureshes Cedex

Figure 1.2-21 FINNISH TWO AXLE TROLLEY COACH

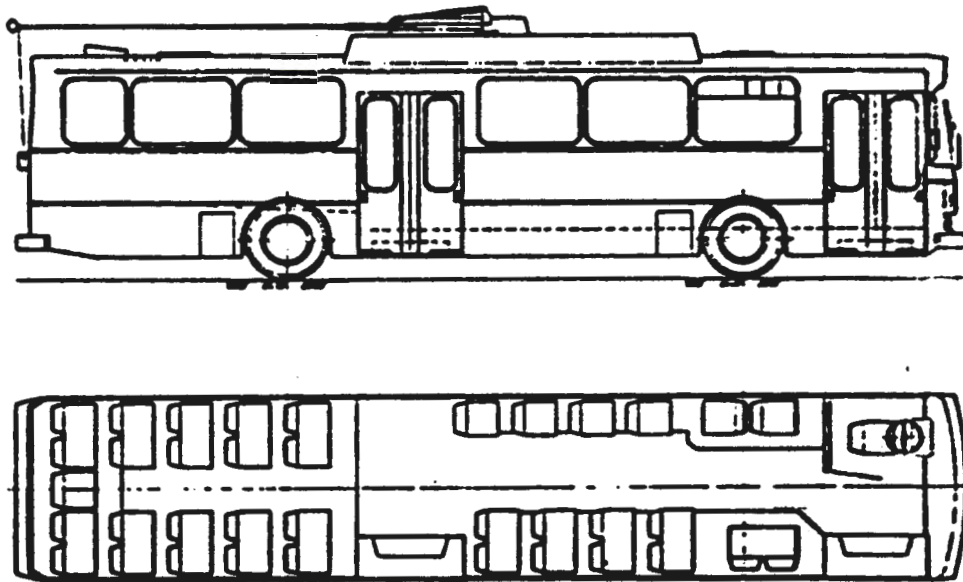

BUILDER: SUOMEN AUTOEOLLISUUS Ab/WIIMA Ab (1)
 ELECTRICAL EQUIPMENT SUPPLIER: STROMBERG Ab

MODEL NO. N/A

DIMENSIONS (ft/mm)

Length - overall 39.3/12000
 Width - overall 8.0/2440
 Height - overall 11.5/3500
 Wheel Base 19.4/5900
 Floor Height 2.2/670 (2)
 Door Openings (between handrails) N/A
 Minimum Turning Radius

WEIGHT EMPTY (lbs/kg) 31,090/14100

CAPACITY (seats/standees) 37/30

PROPULSION AND PERFORMANCE

Motor Stromberg, HXUR56262, 3-phase induction
 Rating of Motor (hp/kw) 134/100
 Motor Control Pulse width modulation (3)
 Top Speed (mph/kmph) 37/60
 Acceleration (mphs/mpsps) 3.5/1.56

AUXILIARY POWER

Top Speed (mph/kmph) 28/45

STATUS Prototype

NO PHOTOGRAPH AVAILABLE

NOTES FROM SPECIFICATIONS:

1. Suomen Autoteollisuus manufactures the chassis and Wiima the coach body.
2. Floor height is constant between front and center doors. An internal step rider is provided to reach the rear of the bus.
3. See the propulsion control section for details.

SOURCES OF INFORMATION:

Oy Stromberg Ab
Office of Technical Planning
Helsinki, Finland

Figure 1.2-22 IKARUS ARTICULATED TROLLEY COACH

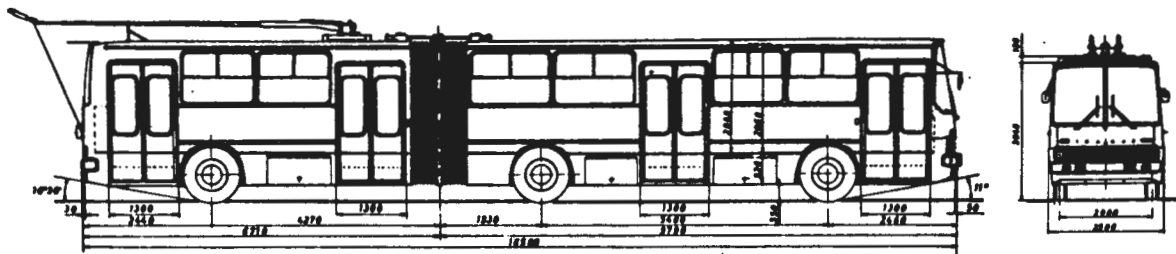

BUILDER: IKARUS
ELECTRICAL EQUIPMENT SUPPLIER: SECHERON-BBC

MODEL NO. 280T3

DIMENSIONS (ft/mm)

Length - overall	54.1/16500
Width - overall	8.2/2500
Height - overall	10.4/3160 (1)
Wheel Base	17.7-30.3/5400-6200
Floor Height	2.9/890 (2)
Door Openings (between handrails)	4.1/1250
Minimum Turning Radius	N/A

WEIGHT EMPTY (lbs/kg) 26901/12200

CAPACITY (seats/standees) 35/104 (3)

PROPULSION AND PERFORMANCE

Motor	Secheron 4ELO 2052, Series 600 Volts DC
Rating of Motor (hp/kw)	224/167
Motor Control	Chopper (4)
Top Speed (mph/kmph)	37/60
Acceleration (mphps/mpsps)	N/A

AUXILIARY POWER

Top Speed (mph/kmph) Not included

STATUS Production Model

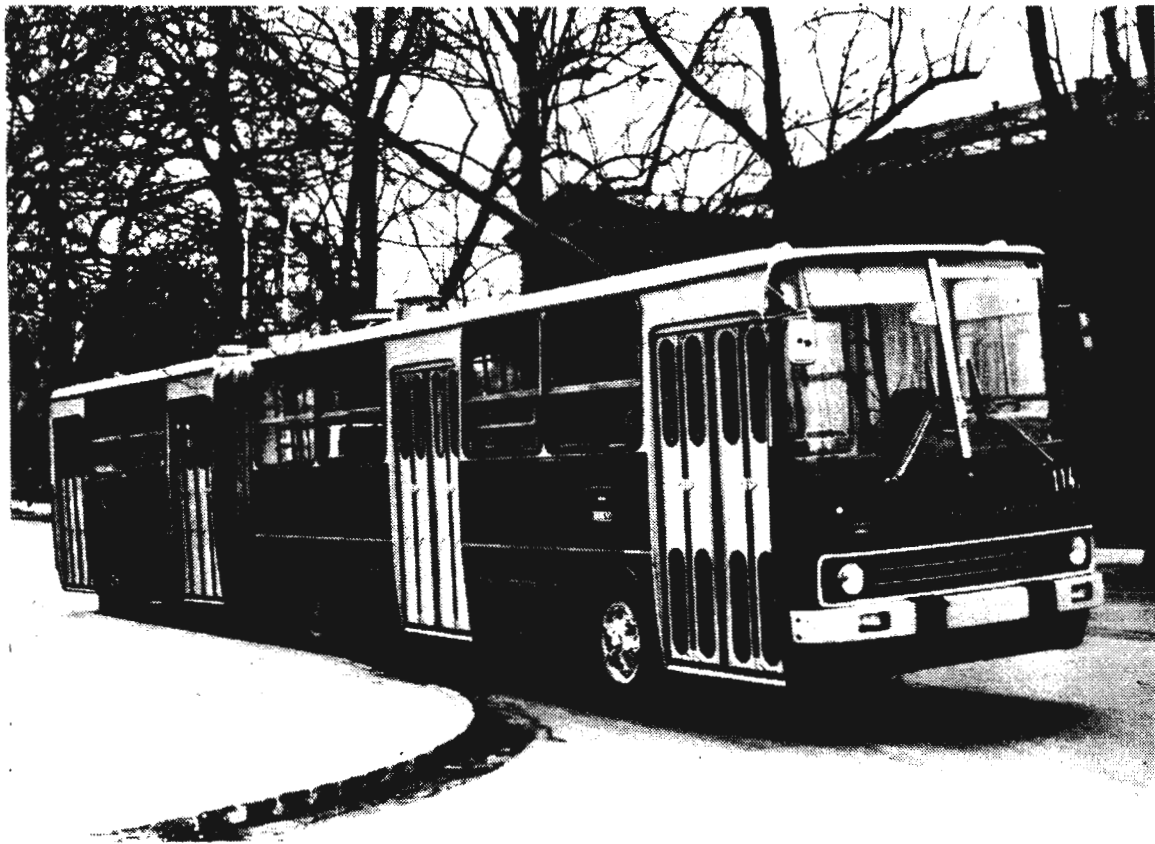

NOTES FROM SPECIFICATIONS:

1. Height from road surface to top of roof.
2. Scaled dimension.
3. 15.63 square meters available for standees. 104 persons were calculated by dividing 15.63 square meters by .15 square meters per standee.
4. All electrical equipment by Secheron.

SOURCE OF INFORMATION:

Mogurt
Hungarian Trading Company for Motor Vehicles
H - 1391 Budapest POB 62/249

Figure 1.2-23 SKODA TWO AXLE TROLLEY COACH

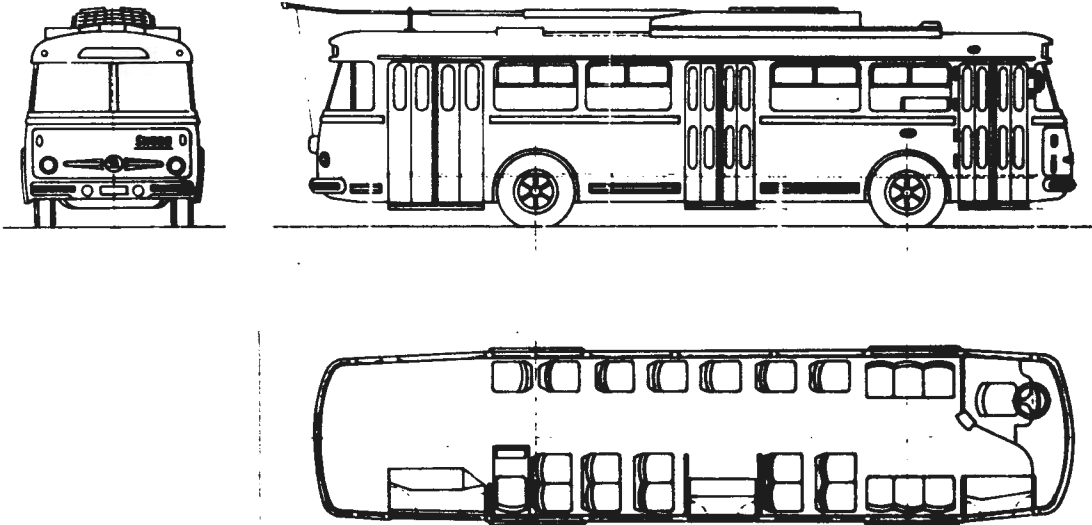

BUILDER: SKODA
 ELECTRICAL EQUIPMENT SUPPLIER: SKODA

MODEL NO. 9Tr

DIMENSIONS (ft/mm)

Length - overall	36.1/11000
Width - overall	8.2/2500
Height - overall	10.6/3240 (1)
Wheel Base	17.7/5400
Floor Height	2.5/750
Door Openings (between handrails)	4.1/1250 (2)
Minimum Turning Radius	36.7/11200

WEIGHT EMPTY (lbs/kg) 19669/8920

CAPACITY (seats/standees) 28/72 (3)

PROPULSION AND PERFORMANCE

Motor	2AL 2943rN, Series 600 Volt DC
Rating of Motor (hp/kw)	154/115
Motor Control	Contactors (4)
Top Speed (mph/kmph)	37/60
Acceleration (mphs/mpsps)	N/A

AUXILIARY POWER

Top Speed (mph/kmph) Not included

STATUS Production Model (5)



NOTES FROM SPECIFICATIONS:

1. Height including the current collection equipment in the secured position.
2. Front and center doors have an opening of 2.6ft/805mm.
3. The capacity of the two door design is 41/29.
4. It is reported that choppers will be employed in the 1979 models.
5. In 1980 it is expected that production will be switched to the 14Tr.

SOURCE OF INFORMATION:

Skoda Export
Vaclavske n.56
Praha, Czechoslovakia

Figure 1.2-24 RUSSIAN TWO AXLE TROLLEY COACH

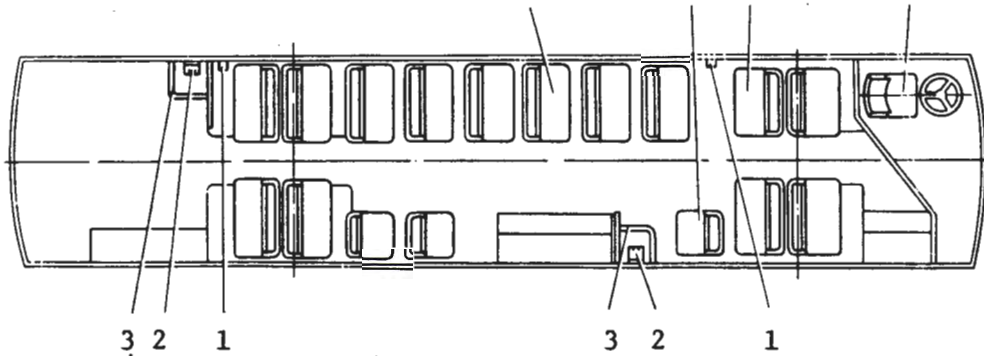

BUILDER: ENERGO MACH EXPORT (USSR)

MODEL NO. ZIU-9

ELECTRICAL EQUIPMENT SUPPLIER: Same as builder

DIMENSIONS (ft/mm)

Length - overall	39.3/11980
Width - overall	8.2/2500
Height - overall	10.4/3160 (1)
Wheel Base	19.7/6000 (2)
Floor Height	N/A
Door Openings (between handrails)	N/A
Minimum Turning Radius	36.1/10000

WEIGHT EMPTY (lbs/kg) 22050/10000

CAPACITY (seats/standees) 31/59 (3)

PROPULSION AND PERFORMANCE

Motor	K-207 -3, 550 volts DC
Rating of Motor (hp/kw)	148/110
Motor Control	Contactora
Top Speed (mph/kmph)	42/68
Acceleration (mphps/mpsps)	2.9/1.3

AUXILIARY POWER

Top Speed (mph/kmph) Not included

STATUS Production Model



NOTES FROM DRAWING:

1. Ticket punch
2. Fare box
3. Handrail

NOTES FROM SPECIFICATIONS:

1. Height including the current collection equipment in secured position.
2. Scaled dimension.
3. Crush load will accommodate 95 standees.

SOURCE OF INFORMATION:

Energomach Export
Moscow, USSR

Figure 1.2-25 DAIMLER-BENZ ARTICULATED ALL SERVICE COACH

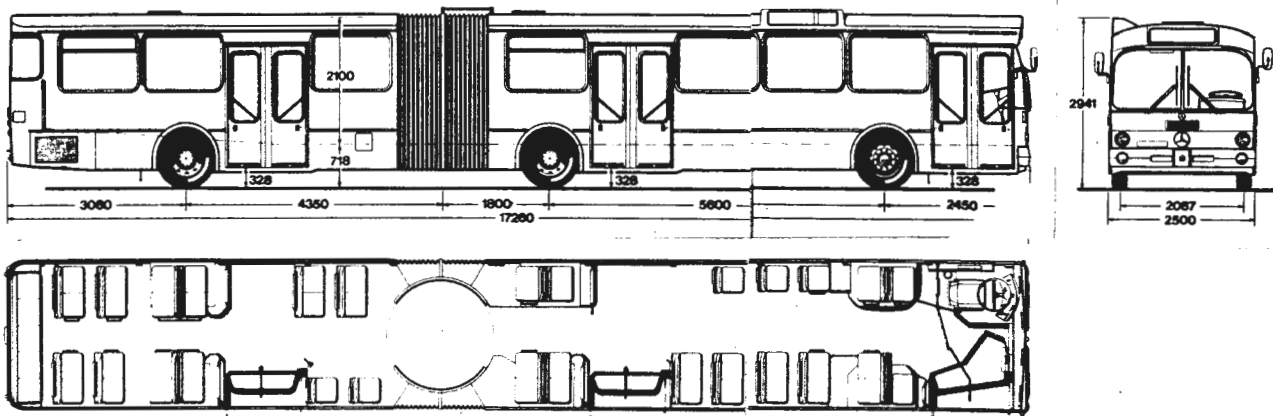

BUILDER: DAIMLER-BENZ
 ELECTRICAL EQUIPMENT SUPPLIER: ROBERT BOSCH
 MODEL NO. OE-305G
 TC-Diesel

DIMENSIONS (ft/mm)

Length - overall 56.6/17260
 Width - overall 8.2/2500
 Height - overall 9.6/2940 (1)
 Wheel Base 18.4-20.2/5600-6150
 Floor Height 2.4/718
 Door Openings (between handrails) 4.1/1250
 Minimum Turning Radius 34.4/10500

WEIGHT EMPTY (lbs/kg) 29856/13540

CAPACITY (seats/standees) 49/135

PROPULSION AND PERFORMANCE

Motor (diesel/electric) OM 407h/AZ07 107000 (2)
 Rating of Motor (hp/kw) 197/147//241/180 **
 Motor Control (electric) Field Control
 Top Speed (mph/kmph) 43.5/70
 Acceleration (mphs/mpsps) 4.0/1.8

AUXILIARY POWER

Top Speed (mph/kmph)

STATUS Prototype

** Diesel hp/kw//Electric hp/kw

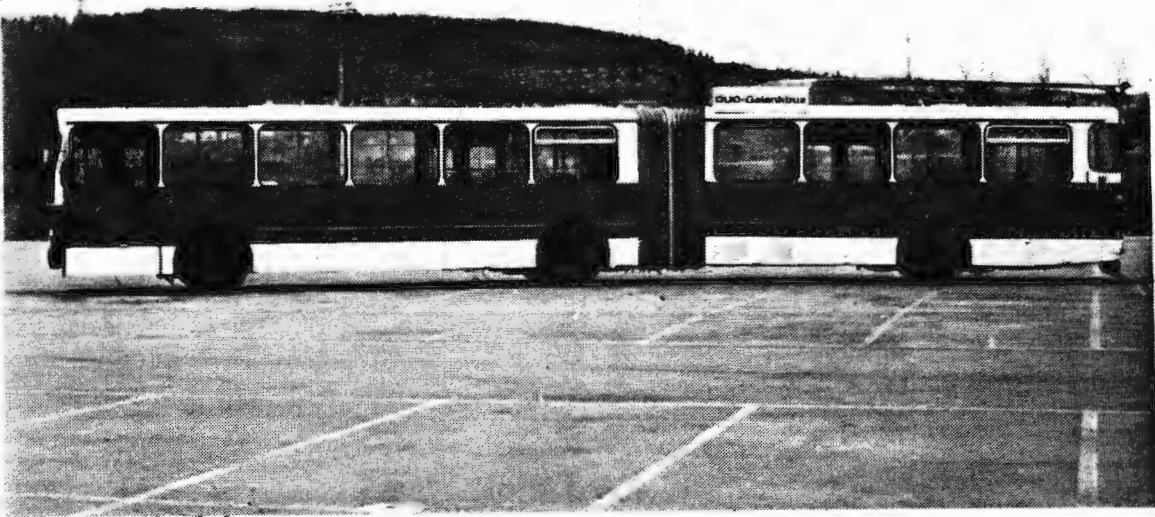

NOTES FROM SPECIFICATIONS:

1. Height is from road surface to the top of the roof.
2. Electric motor is 600 volts DC.

SOURCE OF INFORMATION:

Daimler-Benz
7000 Stuttgart 60
West Germany

Figure 1.2-26 DAIMLER-BENZ TWO AXLE ALL SERVICE COACH

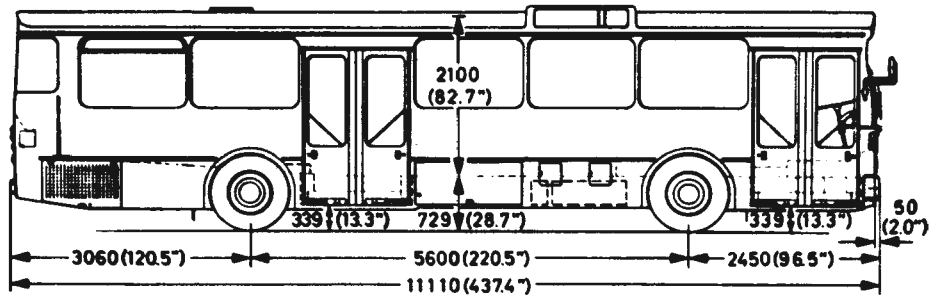

BUILDER: DAIMLER-BENZ

MODEL NO. OE 305

ELECTRICAL EQUIPMENT SUPPLIER: ROBERT BOSCH

TC/Diesel and TC/Battery

<u>DIMENSIONS (ft/mm)</u>	<u>TC/Diesel</u>	<u>TC/Battery</u>
Length - overall	36.4/11100	36.4/11100
Width - overall	8.2/2500	8.2/2500
Height - overall	9.6/2940 (1)	9.7/2940 (1)
Wheel Base	18.4/5600	18.4/5600
Floor Height	2.4/718	2.4/718
Door Openings (between handrails)	4.1/1250	4.1/1250
Minimum Turning Radius	34.4/10500	34.5/10500
WEIGHT EMPTY (lbs/kg)	24271/11010	24271/11010
CAPACITY (seats/standees)	44/61	44/61
<u>PROPULSION AND PERFORMANCE</u>		
Motor (Diesel/Electric)	98/74//241/180 (2)	99/94//240/180 (2)
Rating of Motor (hp/kw) **		
Motor Control (Electric)	Field Control	Field Control
Top Speed (mph/kmph)	43.5/70	42/70
Acceleration (mphs/mpsps)	4.0/1.8	3.9/1.8

STATUS

Prototype

Prototype

** Diesel or Battery hp/kw//Straight Electric hp/kw



NOTES FROM SPECIFICATIONS:

- (1) Height is from road surface to top of roof.
- (2) Electric motor is 600 volts DC.

SOURCE OF INFORMATION:

Daimler-Benz
700 Stuttgart 60
West Germany

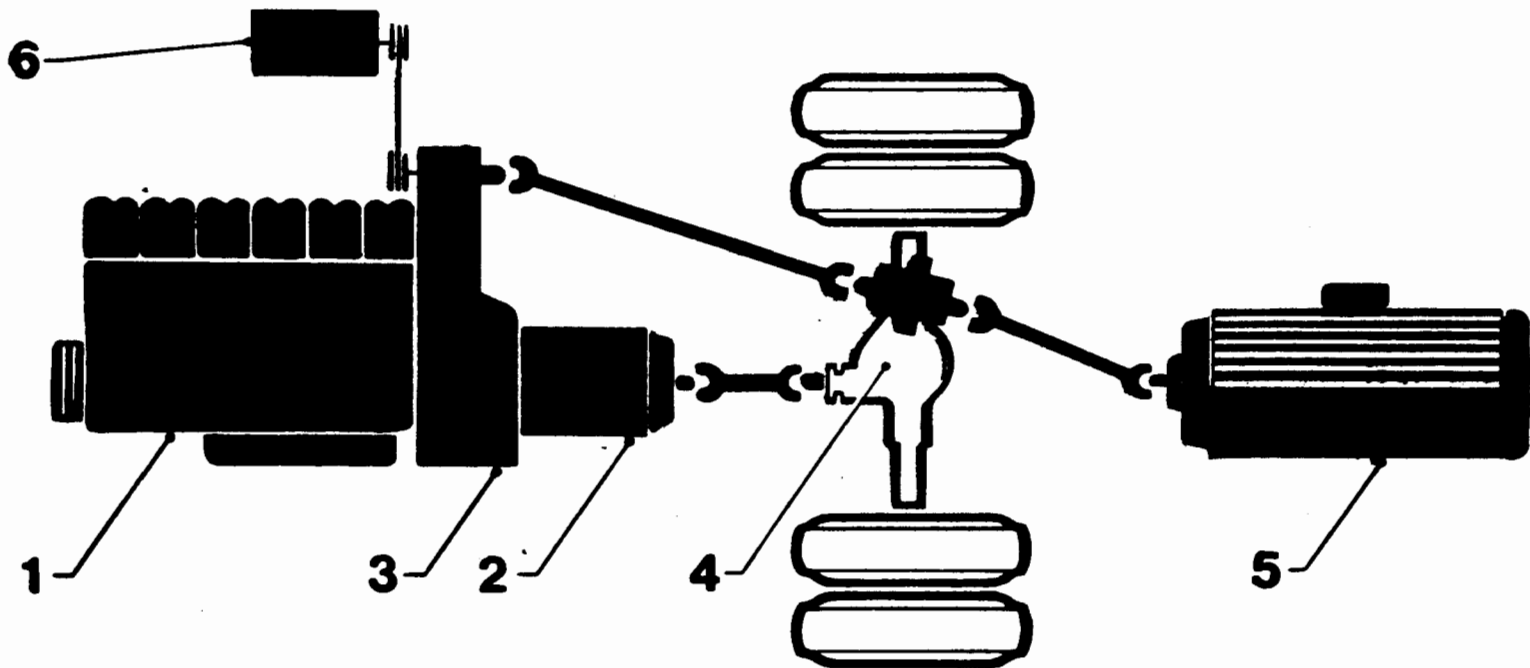

- 1 Diesel Motor
- 2 Automatic Transmission
- 3 Transfer Mechanism
- 4 Driving Axle
- 5 Electric Motor
- 6 Auxiliary Generator

DUO - Bus Propulsion System Configuration

Transbus Requirements

The requirement for a 22 in./560mm. floor height in the Transbus specification could be easier to design into a trolley coach than into a motor coach. In addition, a trolley coach designed to this floor height standard may have significantly more interior space available for passenger accommodations than a motor coach. Both of these possibilities are due to the greater flexibility of component location inherent in a trolley coach. The only component that must be mechanically linked to the driving axle is the traction motor. The motor is 21 in./530mm in diameter and this will fit under a rear seat which provides an additional 15 in./380mm. of height. However, a raised floor would be required to accommodate the driveshaft. The driveshaft requires approximately 26 in./660mm. clearance above the pavement line at the motor end. Alternatively, a gearbox and offset driveshaft could be used.

The rear axle would require extensive redesign. A lower gear ratio is required due to the wheels and tires being significantly smaller than those used on current equipment. The lower gear ratio will simplify designing a rear axle that will fit under the floor. However, it may be necessary to use the gearbox and offset driveshaft described above to obtain the required total gear ratio.

Considerable flexibility is available for the location of other equipment. The primary constraint, aside from space requirements, is weight distribution. In the past, air-conditioning and resistor groups have been roof mounted, while control contactors have been installed in the front dash. It is possible to roof mount the entire control package using GE contactor control, as it weighs only 540 lbs/245 kg. However, access to the equipment for maintenance would be made more difficult.

Power Distribution - Contact Wire System

Background

Contact wire systems were standardized in this country during the 1930's and, with a few exceptions have remained essentially unchanged. Prior to that time a number of systems were employed although all used the two wire system. The principal differences included:

- o Distance between wires - Variations ranged between 6 and 24 inches (152 to 610mm.).
- o Position of wires - Practically all systems used the horizontal position, but an early European system positioned the wire vertically with the negative wire on top.
- o Height of Wire - Variations ranged between 16 and 22 feet (5 to 6.7 meters).
- o Type of Current Collector - Each system had its own unique collector.

The principal standards developed in this country relate to wire spacing, which is 2 feet/610mm., wire height, which is normally 18

feet/5.5 meters, and the type of collector employed. Considerable latitude has been witnessed outside these standards in such areas as the type of suspension hardware employed, specifications for wire installations at intersections and hardware employed for curves. Since the market for such hardware has decreased, the sole manufacturer has reduced the number of items available. This has forced a further degree of standardization on the remaining TC operators.

Components of the Contact Wire System

There are various components which comprise an overhead system. In addition to the contact wire, special hardware must be provided for tangent and curve alignments and to accommodate switches, crossovers, and sectionalization. The discussion which follows will address these various items.

Contact Wire - Early systems employed round wire, since that was the type used in street railway service. Grooved wire was available in the mid-Thirties and operators quickly incorporated it in their systems. The groove allows the wire to be held with clamps that do not touch the contact surface. This feature permitted the use of a more sophisticated current collector and reduced dewirements and wire maintenance costs. The common sizes of grooved wire are 4/0 and 2/0, although 3/0 was used in some systems. The crosssections are shown in Figure 1.2-28.

The materials commonly used are hard drawn copper and phosphor bronze. The latter material will wear longer and not lose its strength when it is subjected to an electrical overload. Hard drawn copper will lose strength when overloaded, necessitating its replacement. A further tradeoff involves initial installation costs. Bronze is more expensive, but has lower conductivity. The lower conductivity may require additional feeders and alter substation spacing. Bronze will reduce subsequent maintenance costs since its replacement frequency is less.

Tangent Alignment - Straight wire accounts for the majority of all installed wire and requires a minimum amount of special hardware. Typically the contact wire is suspended from span wires which are spaced between 110 feet to 140 feet (33 to 43 meters), depending upon the suspension system employed. The spans are suspended by poles at a height of 18 to 19 feet (5.5 to 5.8 meters) as shown in Figure 1.2-29. The height of the attachment point must take into account a slope of one to ten feet between the pole and the contact wire. Poles must be raked (degree of offset from vertical) to take account of the moment forces caused at the attachment of the span wire. The contact wire is attached to the span wire using hangers and clamps (hardware that connects the hanger with the contact wire).

In certain instances, it may be beneficial to use bracket arms as shown in Figure 1.2-30. Pole requirements are reduced by one-half and visual clutter can be reduced. Typically, bracket arms are employed when one directional wire is required or on very narrow streets that have two directional wires. Bracket arms may also be used on wide streets where span wires are not practical. The span wire is used with

Figure I. 2-28
Grooved Wire Cross Sections
(Enlarged Detail)

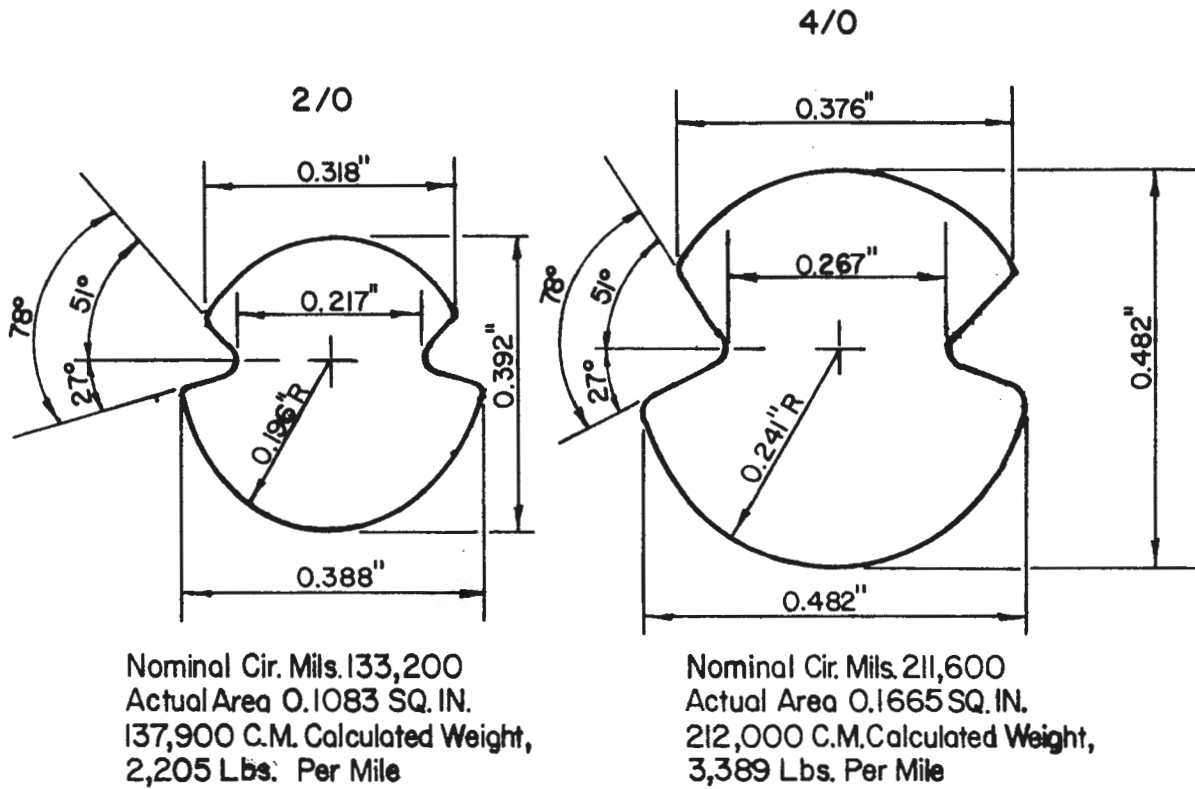

Figure I. 2-29
Tangent Section

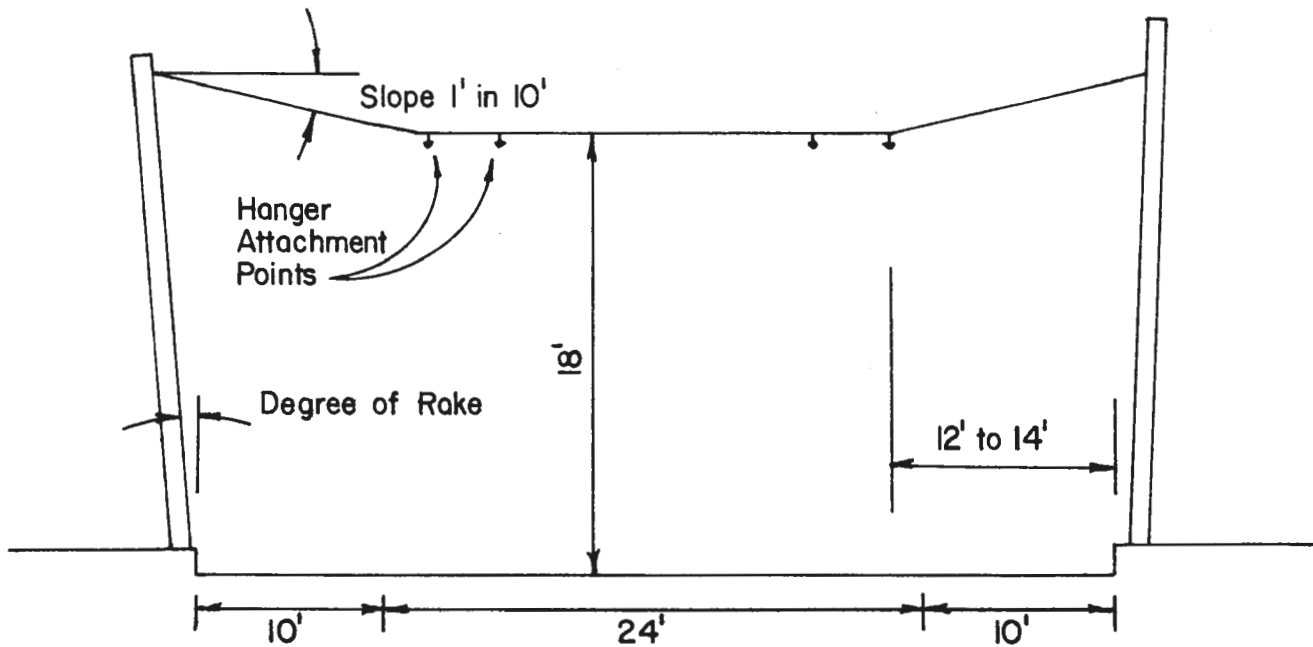
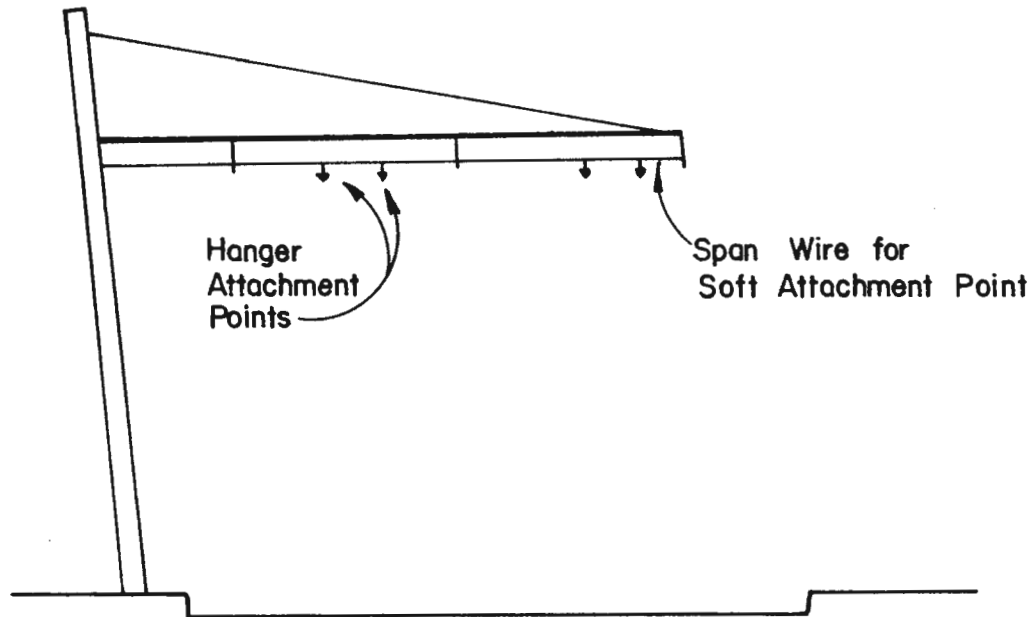

Figure I.2-30
Tangent Section - Bracket Arm



the bracket arm to provide a soft suspension point which will minimize wear on the contact wire and dampen oscillation which can cause wire fatigue.

The actual position of the wires is a function of street width. Its position on streets with two 12 foot/4 meters traffic lanes and two 10 foot/3 meter parking lanes is approximately 12 to 14 feet (4 to 4.3 meters) from the curb. If the street has two traffic lanes in each direction the wire would be installed over the righthand traffic lane to provide access to the lefthand for passing and the curb lane for bus stops.

The touring distance for TC's on tangent wire is between 12 and 15 feet (4 and 4.5 meters) from the trolley wire. The exact distance is a function of:

- o Length of trolley pole
- o Height of trolley wire
- o Speed of travel.

Maximum speed can be maintained provided the horizontal angle between the wire and the trolley pole does not exceed approximately ten degrees. Operation at angles in excess of ten degrees greatly increases the chances of dewirement when:

- o The driver does not accelerate and brake in a smooth manner
- o The driver makes sudden turning movements
- o Rough pavement is encountered.

The placement of positive and negative wires is standardized on most systems. The latter are placed on the curb side and the former in the middle. Electrical feed spans that supply current are provided every 500 to 800 feet (152 to 244 meters) depending upon travel density.

Curve Alignments - The first TC installations used typical street railway construction for curves. This system employed numerous pull-offs, strain insulators, (tensioned insulators) and a backbone as shown in Figure 1.2-31. This configuration added greatly to the aerial clutter and was opposed by many on that grounds. It did provide a smoother curve for faster circulation, but was usually located in areas where this feature could not be utilized.

In the late Thirties, curve segments became popular. These were easier to install and reduced the amount of material in the air. The curve segment can be installed prior to the installation of the trolley wire and normal 90 degree turns require only three segments, each accommodating 30 degrees of deflection as shown in Figure 1.2-31. As the number of degrees accommodated by each segment increases, the allowable speed decreases. Usually, speed on simple curves is limited by traffic and intersection geometry and the overhead restrictions do not come into play. Curve segments can be employed to accommodate degrees of deflection varying from 2 degrees to 47 degrees. The larger segments are installed in turning loops where speed is not a consideration.

Figure I.2-31
Curve Alignments

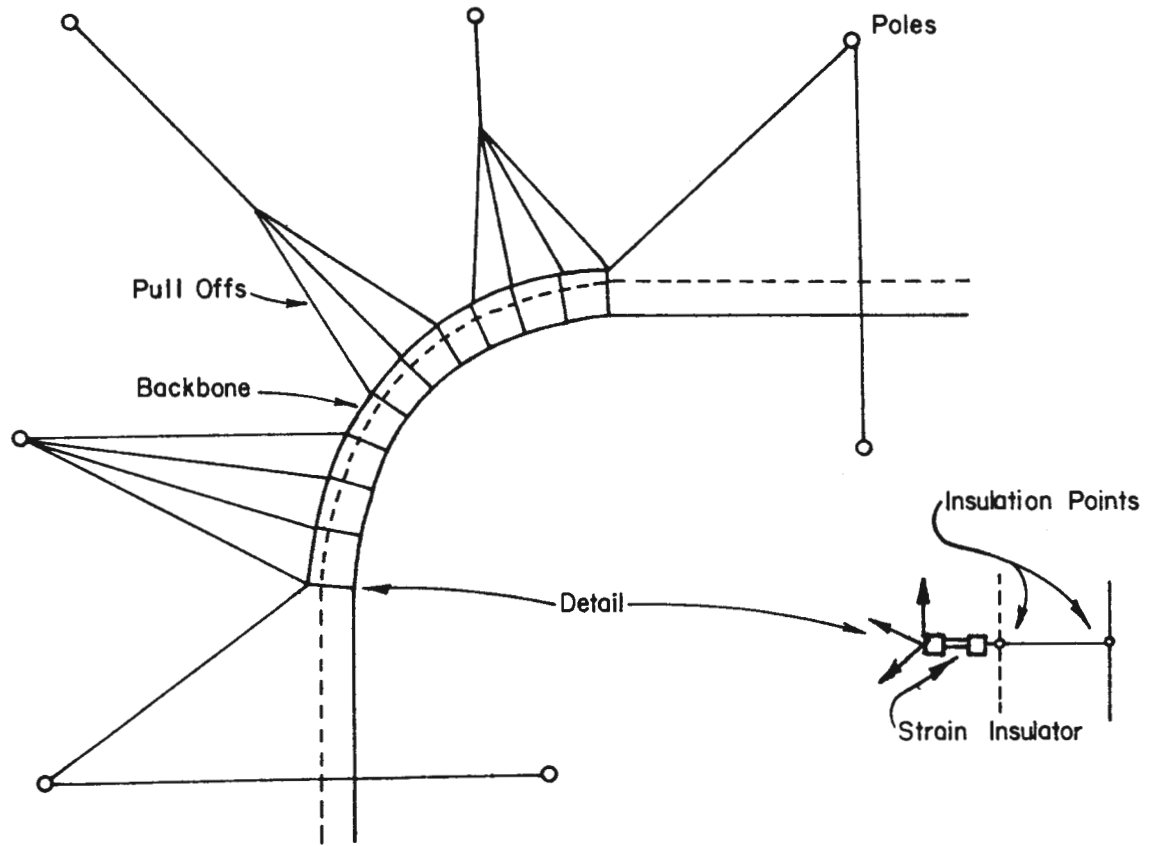

Typical Curve Using Pull Offs, Strain Insulators and a Backbone

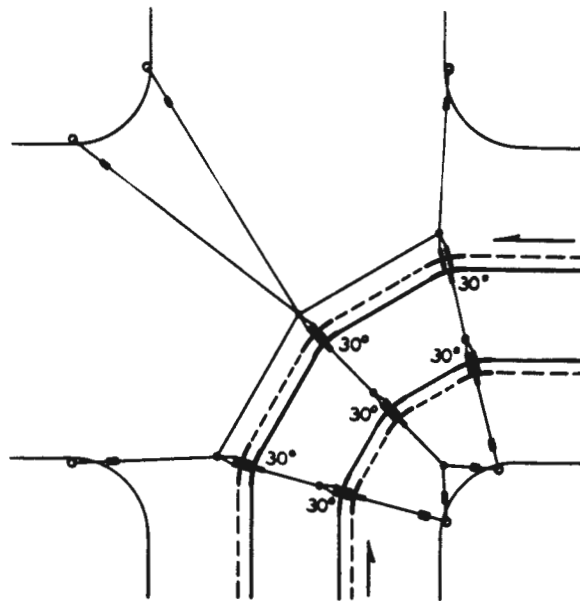

Typical Curve Using Curve Segments

Switches - Switches are a necessary component of any TC system and allow for diverging routes, turn back loops, emergency turns and so forth. There are two types, facing point and trailing point. Each switch consists of two frogs (the device which allows the current collector to take an alternate route) and one insulated crossover to allow the positive and negative wires to cross. Figure 1.2-32 shows a typical facing point switch.

Facing or diverging switches are built with a movable runner which can align itself for straight or branching movement of the current collector. The position of this runner is controlled by the driver or coach positioning that will be explained in a subsequent portion of this section. The angle of deflection accommodated by the frog is between 6 and 12 degrees. The crossover will accommodate angles varying from 15 to 45 degrees.

Trailing switches, used for converging movements, are configured in a similar manner but do not require a movable runner which is externally controlled. Its position is governed by the movement of the collector. Movable runners are not provided with small angle frogs in this type of switch.

Both switch types are available in right hand, left hand and wye configurations. Wye switches are normally used at "T" intersections where one pair of wires diverges to the right and the other to the left.

Crossover Assemblies - This piece of hardware is essential whenever one set of wires must cross another. The crossover can accommodate angles varying from 10 to 90 degrees. Each assembly requires four crossovers and two points of insulation. A typical assembly is shown in Figure 1.2-33. Crossing assemblies have no moving parts unless the crossing angle is 15 degrees or less. In such instances, movable runners are used to insure the proper movement of the collector.

Sectionalization - Overhead systems are separated into a number of electric circuits similar to domestic wiring. Circuits are provided to insure proper operating voltages and to localize problems such as short circuits. Sectionalization is accomplished by positioning section insulators in a manner that equalizes current draw on each circuit.

Clearances - The contact wire system must interface with lines owned by an electric utility, the telephone company and possibly a cable TV company. Standards govern the distance between the attachment points on common use poles and between contact lines and crossing wires. The following table indicates the clearances used in Seattle.

Figure 1.2-32
Facing Point Switch

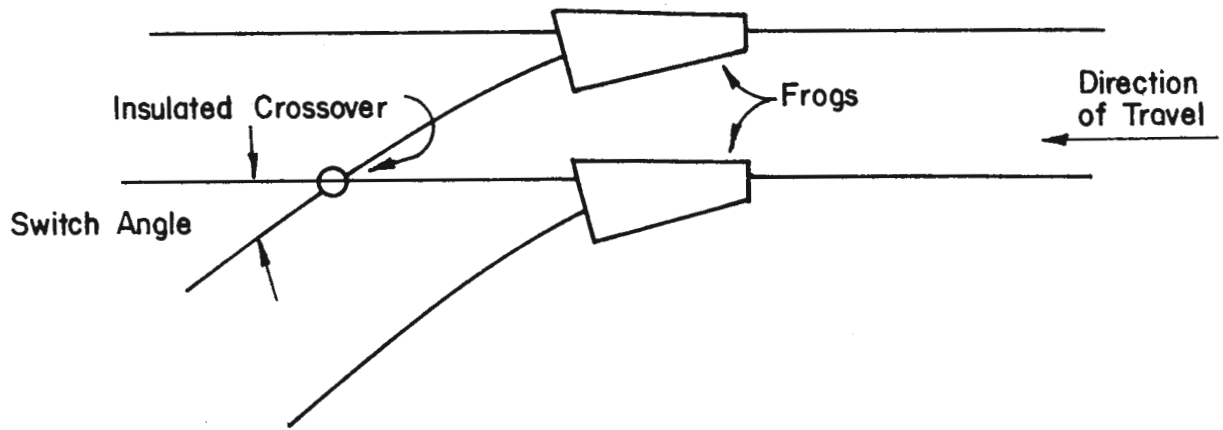

Figure 1.2-33
Crossover

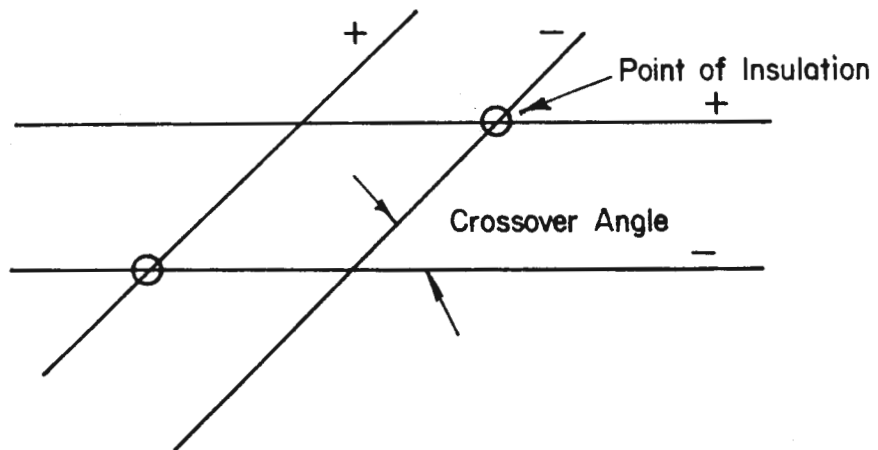

Table 1.2-6

Clearances for Pole Attachments and Crossings *

Crossing Clearance (Distance from Contact Wire)

0 - 750 Volts	4 feet/1.2 meters
750 - 8,700 Volts	6 feet/1.8 meters
Communication	4 feet/1.2 meters
Guys and Span Wires	4 feet/1.2 meters

Pole Attachments (Distance from Span Attachments)

0 - 8,700 Volts	6 inches/15 cm.
Communication Cable	12 inches/30 cm.
Communication Brake, Dropwire	2 inches/5 cm.
Street Light Bracket	0

* Reference 22

Typical Wire Configuration

Turning Movements - The various items described in the above section can be employed to accommodate any overhead configuration. The more complex configurations occur at intersections. At such locations, they can range from a full grand union (a configuration allowing for all possible movements), shown in Figure 1.2-34 to a simple curve illustrated above.

TC turning movements can often represent problems on multi-lane streets if switches are installed within or very near intersection boundaries. A vehicle on a diverging route must wait until all preceding vehicles have moved through the intersection before it can proceed. Time is lost because preferential left turns cannot be made, through moves must wait for left hand turns to be completed and so forth. The solution is to move the switches away from the immediate area or the intersection thereby giving each movement (through and diverging) its unique set of wires. This principle is illustrated in Figure 1.2-34. Both sets of wires can be placed in a manner that will accommodate a near side stop.

Loops - Off street loops are often used in TC operation to reverse direction. The use of 45 degree curve segments can accommodate the tightest turn the TC is able to make. Figure 1.2-35 shows a typical tight loop. Although not shown in this figure, it is advantageous to install a siding at all loops especially if they are served by more than one route. Vehicles can pass without the need to remove and rewire poles.

Flexibility also dictates the ability to turn vehicles short of their normal terminals to accommodate emergencies or to return a late vehicle to its schedule. Wyes can be used at this type of turnback point to reduce the costs involved, provided a ground man is supplied. Typically, turn-back facilities should be provided every 3 to 4 miles/5 to 6 km.

Figure 1.2-34
Turning Movements

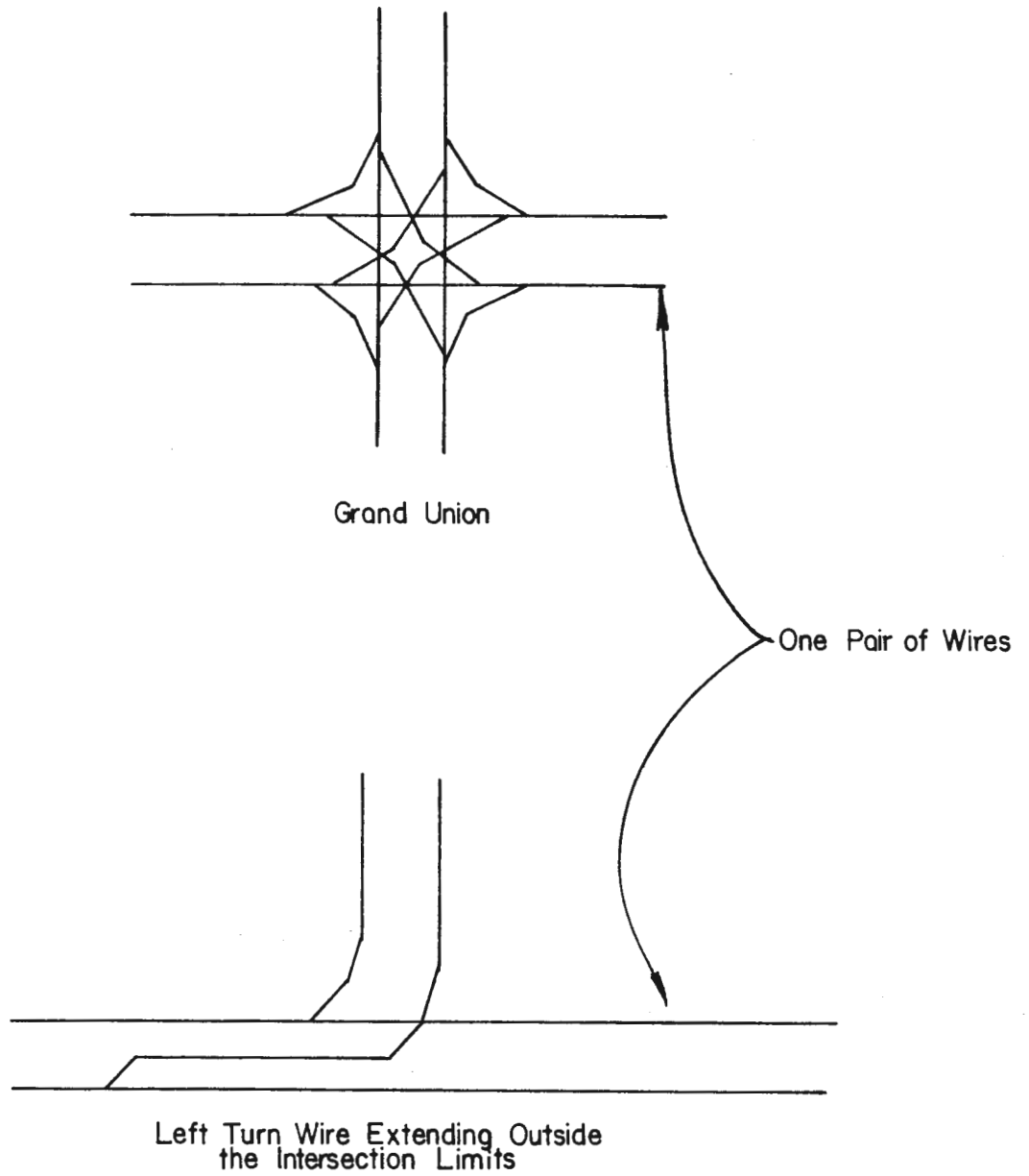

Figure I.2 - 36
Shared Wiring in Garages

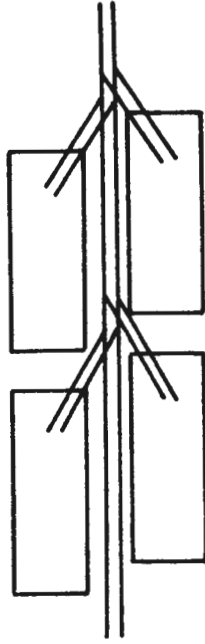
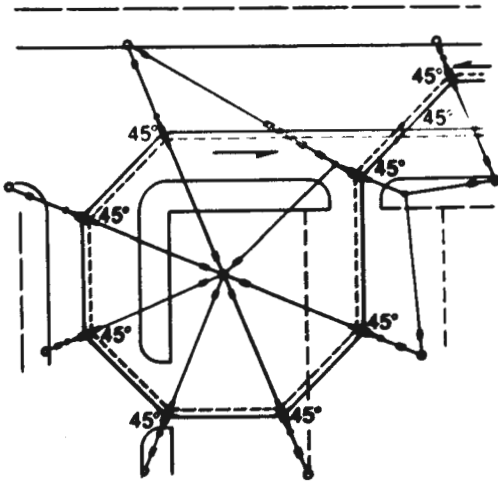

Figure I.2 - 35
Terminal loops



Emergency Routings - Emergency downtown routings are also quite helpful. A wire break, fire or major accident on the main CBD thoroughfare can shut down an entire TC system. Such routings are also beneficial when occasional parades are scheduled. This subject of emergency CBD routings is more fully discussed in Chapter 1.4.

Interconnections between routes should also be employed when the opportunity exists. Their use can greatly increase system flexibility and the ability to deal with emergency situations. Without this flexibility, TC services would have to be suspended for the duration. The practice in North America has been to provide both facing and trailing switches for connections of this sort. In Europe the facing point switch is often omitted. This practice reduces capital costs and related maintenance expense, but does require a ground man or additional driver time.

Garage Wiring - Garage overhead can consume a vast amount of special work (switches, crossover assemblies, curve segments, etc.) if every necessary movement were to be wired. The amount of wiring can be reduced by having two or three storage lanes share one set of wires as shown in Figure 1.2-36. The disadvantage of this arrangement is that each vehicle must be taken out in sequence or poles on adjoining vehicles have to be lowered.

Switches leading to storage lanes can be remotely controlled from a yard master's booth. Lights can also be employed to indicate where a vehicle is to be stored. Such a system can reduce both coach maneuvering and dewirements.

Express Wires - Express service using TC's, can be accomplished in several ways. They are:

- o Passing sidings can be installed at intervals allowing expresses to pass locals. This system was also employed in the past but unexpected service delays can cause a disruption and a loss of time savings.
- o A third wire can be installed for one directional express service. This arrangement is quite workable provided the street is not excessively wide. Philadelphia currently uses such a system on Route 66.
- o Two additional sets of wires can be installed to allow bidirectional express service. This arrangement is necessary on wide streets and when reverse peak express service is necessitated. Hastings Street in Vancouver is currently equipped with four wires and express service is operated in both peak and base periods.

Operational considerations associated with express wires are discussed in Chapter 1.4.

Rigid and Elastic Contact Wire Systems

The overhead wiring systems currently marketed fall into one of these two categories. The categorization relates to the method of

suspension and the wiring's ability to work with the current collector to avoid loss of contact at suspension points. Rigid systems have universally been employed in this country and Canada and were supplied by either Ohio Brass or Westinghouse. Only the former company is currently marketing overhead materials. In Europe, a number of companies have supplied wiring hardware but the two most prominent firms are Kummeler & Matter (K&M) of Zurich, Switzerland and Furrer & Frey (F&F) of Bern, Switzerland. Only the K&M firm markets a completely elastic system.

Rigid Systems - Figure 1.2-37 indicates, in exaggerated form, the vertical configuration of a contact wire at the point of suspension. Between two suspension points the wire assumes a parabolic shape. Starting at midpoint in a span, the wire is flat and then rises at an increasing angle as the suspension point is approached. The exact configuration of the wire is dependent upon the length of the span (distance between suspension points) and the tension in the contact wire.

Between suspension points the current collector will exert sufficient force to deflect the wire and remain in contact. As the suspension point is reached the collector must accelerate upward to overcome the angular rise of the wire. When an angle of sufficient magnitude is encountered the collector cannot accelerate fast enough and will momentarily leave the wire. Since the suspension point is rigid the wire cannot deflect downward to meet the collector. The amount of disengagement between the wire and the collector is a function of:

- o The speed of the collector
- o The configuration of the wire and the amount of tensioning
- o The length of the span
- o The pressure exerted by the collector.

At points where the collector leaves and then returns to the wire, small welding pearls are formed and subsequently will cause wear on the collector. Wear will also occur on the wire at the point of return.

Elastic Systems - The vertical configuration of the wire in an elastic system is very similar to that of the rigid system. The behavior of the wire and the current collector is also similar until the collector reaches the immediate vicinity of the suspension point. When the pressure between the collector and wire decreases, due to the angular ascent of the wire, the suspension system senses this difference and the wire descends to prevent momentary dewirement. The elastic system can be employed on both tangent and curve alignments.

There are several advantages this system has over its rigid counterpart:

- o Higher speeds are possible, in excess of 50 mph/83 kmph
- o Dewirement potential is minimized
- o Radio disturbances are minimized
- o Wire wear is decreased
- o Collector wear is decreased.

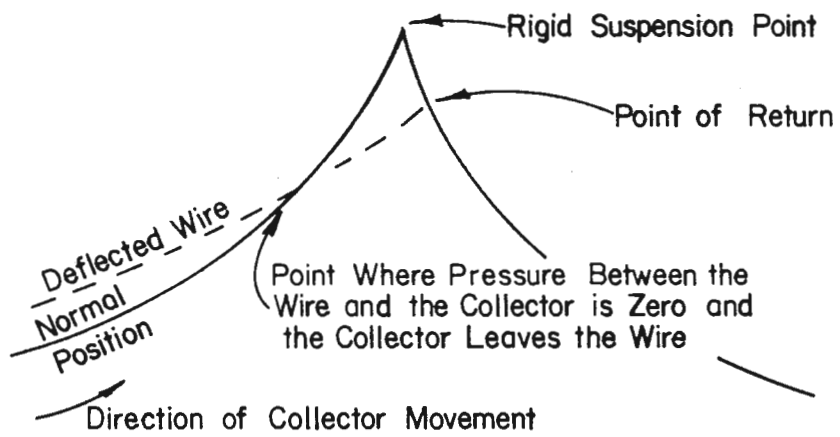

Figure I.2-37
 Collector Path at Rigid Suspension Point

If the TC system is being considered for busway or other limited stop applications, the first two points are very critical. Rigid systems generally allow speeds of 35 to 40 mph/56 to 64 kmph, which would be too restrictive in such situations. Decreased wire wear has been documented and is shown in Figure 1.2-38.

Ohio Brass (OB) System

This firm has been a major supplier of street railway wiring systems and developed a similar system for TC's during the growth period of the Thirties. The technology was fully developed by the late Thirties and has remained substantially the same until the present. Presently, every TC system in Canada and the U.S. employs the OB system. The current expansion and rehabilitation of the Seattle system is being accomplished with OB hardware.

Tangent Alignment - OB is a rigid system owing to the type of suspension employed. A typical tangent span is shown in Figure 1.2-39. Attachment requires an eyebolt for wood poles, a clamp for steel poles, and an anchor bolt for the exterior wall of a building. Strain insulators are employed to insulate the span wire from its attachment point. Hangers attach to the span and provide insulation between positive and negative wires. The wire clamp secures to the hanger stud. Normal distance between spans is 100 feet/305 meters.

This arrangement is semi-flexible at low speeds when pressure can be maintained between the collector and wire. At higher speeds this suspension is rigid since the wire cannot deflect downward to meet the collector. The collector is limited by its mass inertia and forward motion from accelerating upward at a rate sufficient to retain contact. Speeds ranging between 35 and 40 mph/56 to 64 kmph are possible with this system, but at the expense of increased wire and collector wear.

Curve segments - OB curve segments are installed without parting the contact wire. In Type DL, which is employed for deflections ranging between 1 and 10 degrees and Type DR for deflecting in excess of 10 degrees, the wire is clamped to the bottom of the runner as shown in Figure 1.2-40. The runners are connected by strain plates and an insulated strain spacer, which has four eyelets for span wire attachment.

A type C-2 is also available for deflection angles in excess of 5 degrees. This segment is similar to those above but the contact wire is not attached to the runner. The wire is pulled to the back of the strain plate and a runner is used by the current collector. All curve segments can be installed prior to stringing the contact wire.

Curve segments are rigid when installed. The weight of the assembly plus short span lengths used in curve construction minimizes its ability to deflect.

Switches - OB switches require the contact wire to be parted prior to installation. The contact wire attaches to frogs or runners (a casting or tube which replaces the contact wire) by means of anchor tips

Figure 1.2-38
 Wire Wear - Rigid vs. Elastic Suspension *

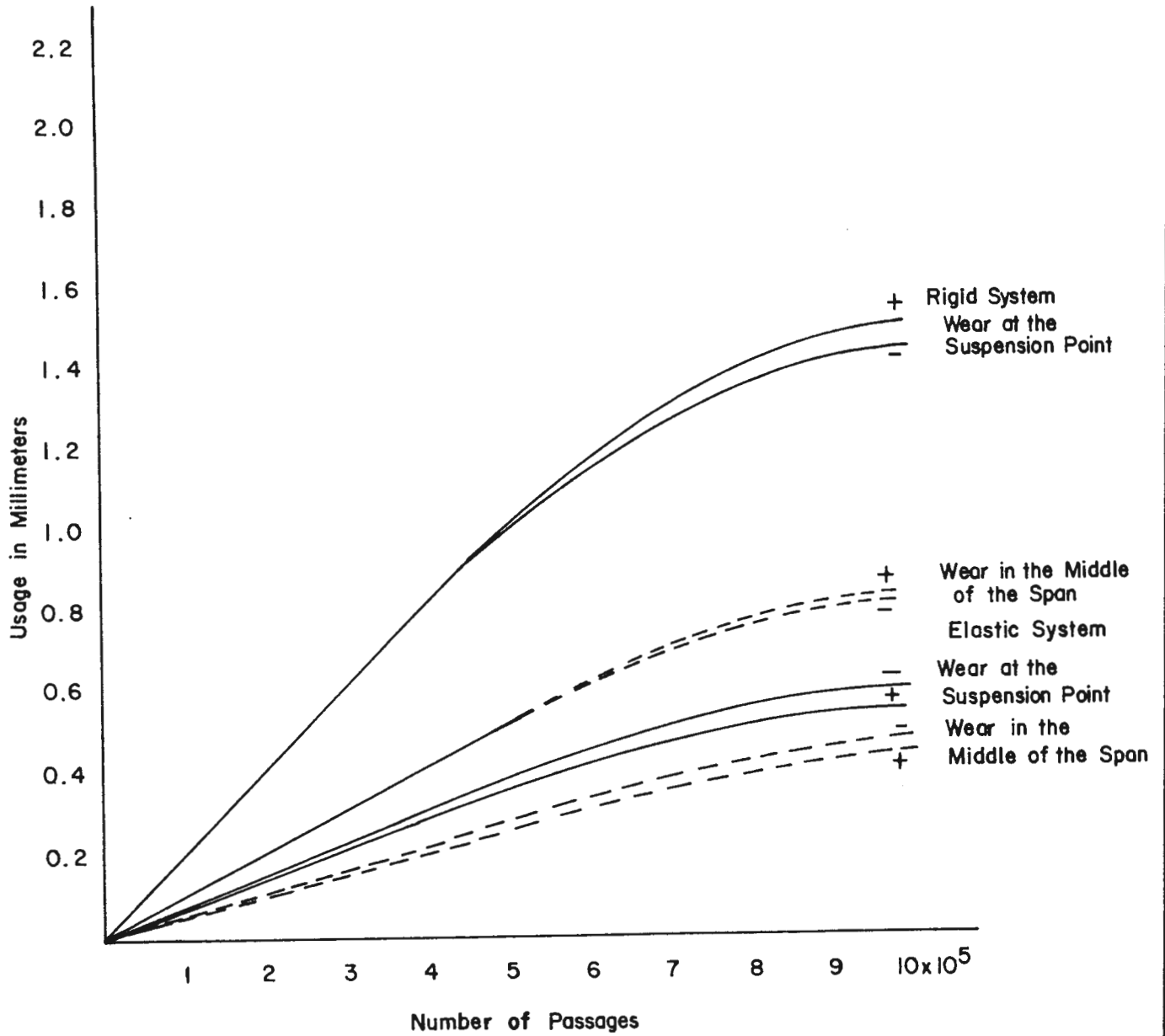

* Reference 18

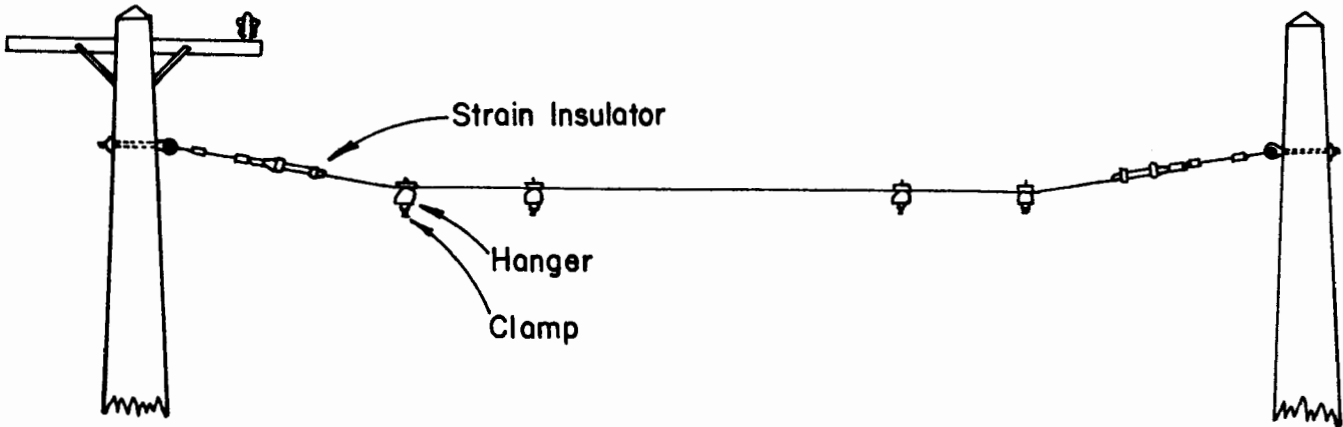

Typical Tangent Support

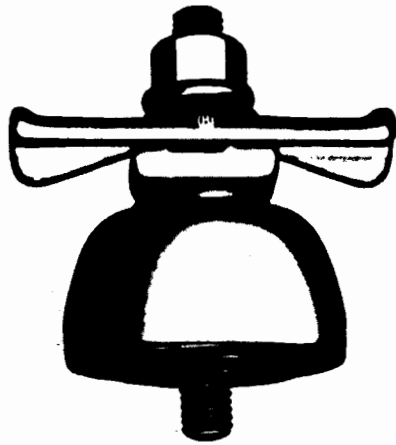

Hanger



Clamp

Figure 1.2 - 39
OB Tangent Construction

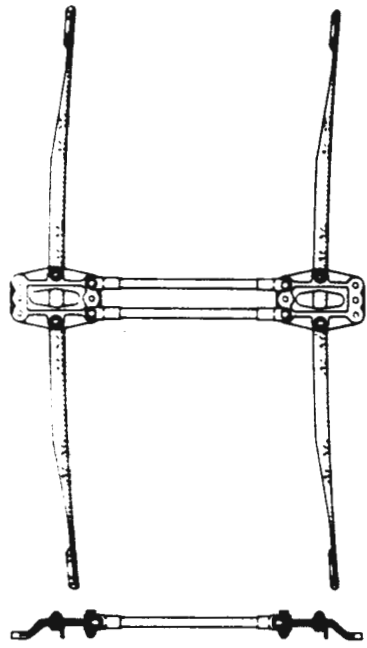

Type DL Segment

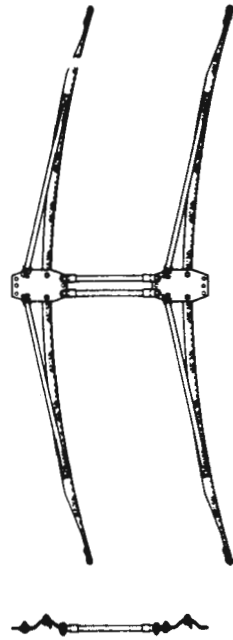

Type DR Segment

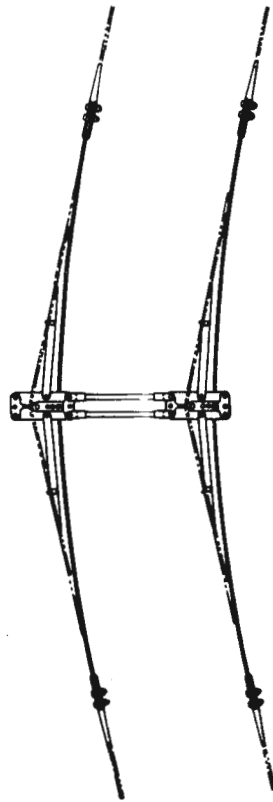

13-27-degree Type C-2 Segment

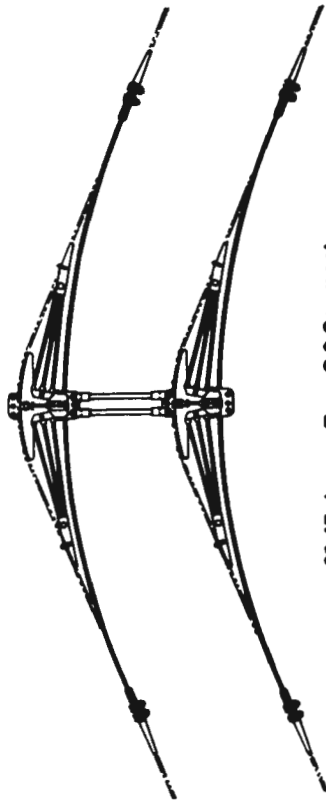

28-47-degree Type C-2 Segment

OB Curve Segments

Figure 1.2 - 40

as shown in Figure 1.2-41. Runners are employed on all curve portions of the switch and between the crossover and the frog. The frogs are held in place using insulated strain spacers. The OB frog angle is 12 degrees, the crossover angles can vary from 10 to 45 degrees, and 30 degree assemblies appear to be the most popular. When employed as part of a 90 degree intersection turn, two or more curve segments will be required.

The switches are held in place with span wires, which are attached to eyelets in the frog castings. Generally four attachments are required to provide stability and overcome the assembly's heavier weight. Intersections that have significant amounts of special work may require additional catenary support.

The length of the assembly is a function of the crossover angle. The distance between the frog point and the center of the crossover for selected angles is as follows:

<u>Angle (degrees)</u>	<u>Distance (inches/mm)</u>
15	136/3450
20	125/3170
25	110/2790
30	102/2590
45	90/2285

Facing point switches are equipped with movable runners. The movement of these runners must be controllable to accommodate TC movements. There are three principal means of control when OB systems are employed.

- o Selectric Switch. When a coach negotiates a normal 90 degree intersection turn, the collectors are in a staggered position on the wire and form a line that is parallel to the rear body line of the coach. When contactors (electrical sensing devices) are also installed in a staggered fashion, as shown in Figure 1.2-42, they have the ability to detect a turning coach and properly align the movable runners. Parallel movements will not simultaneously activate the contactors and the runners will remain aligned for the through movement. Normally, a diverging collector will automatically reset the runner for through movement. Selectric switches can only be used where the switch assembly angle is 23 degrees or more.
- o Power On-Power Off. When switch angles are less than 23 degrees, an alternative to the selectric must be employed. This control system places two contactors on the wire immediately ahead of the frogs, as shown in Figure 1.2-42. If there is a significant current draw while the collectors and contactors are in contact, the runners will align for the curve. The runners will remain aligned for a through movement if there is a small or insignificant current draw. Current draw is driver-controlled, simply by depressing the power pedal or by drawing current through a resistor.

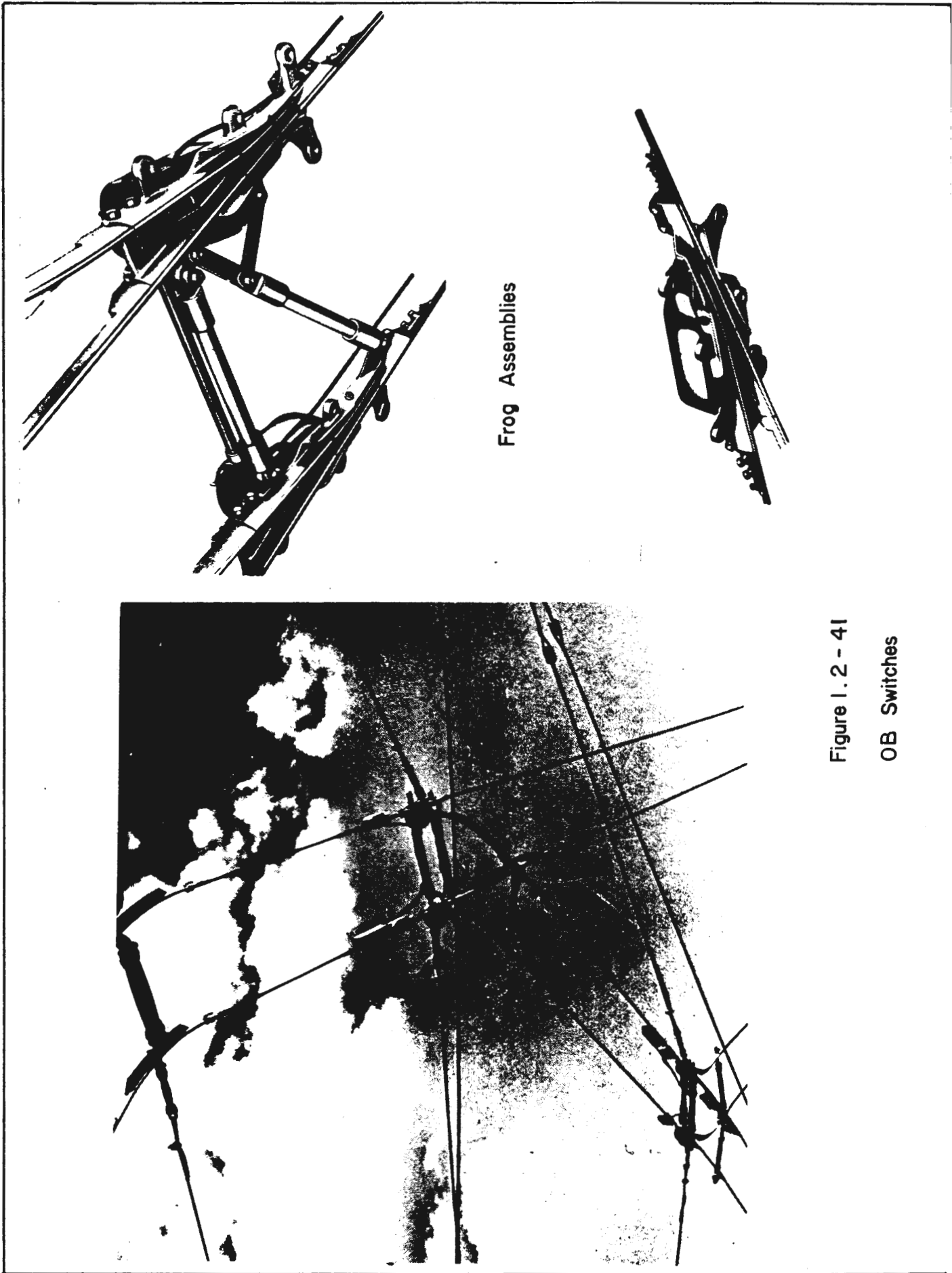

Frog Assemblies

Figure 1.2 - 41

OB Switches

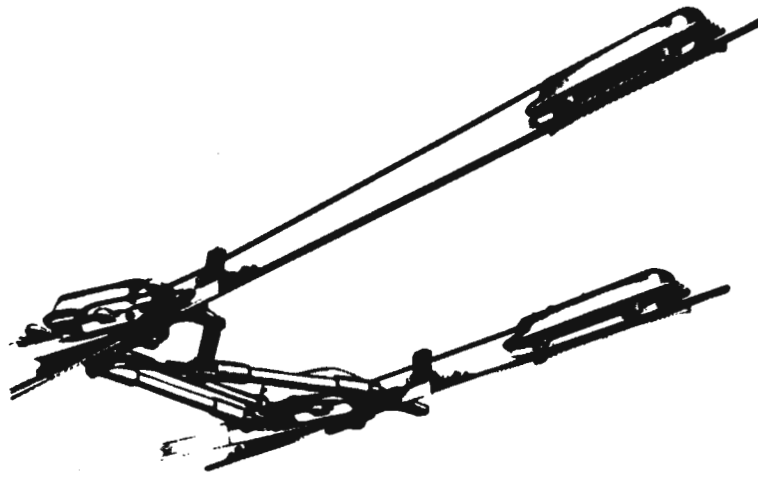

OB Selectric Switch

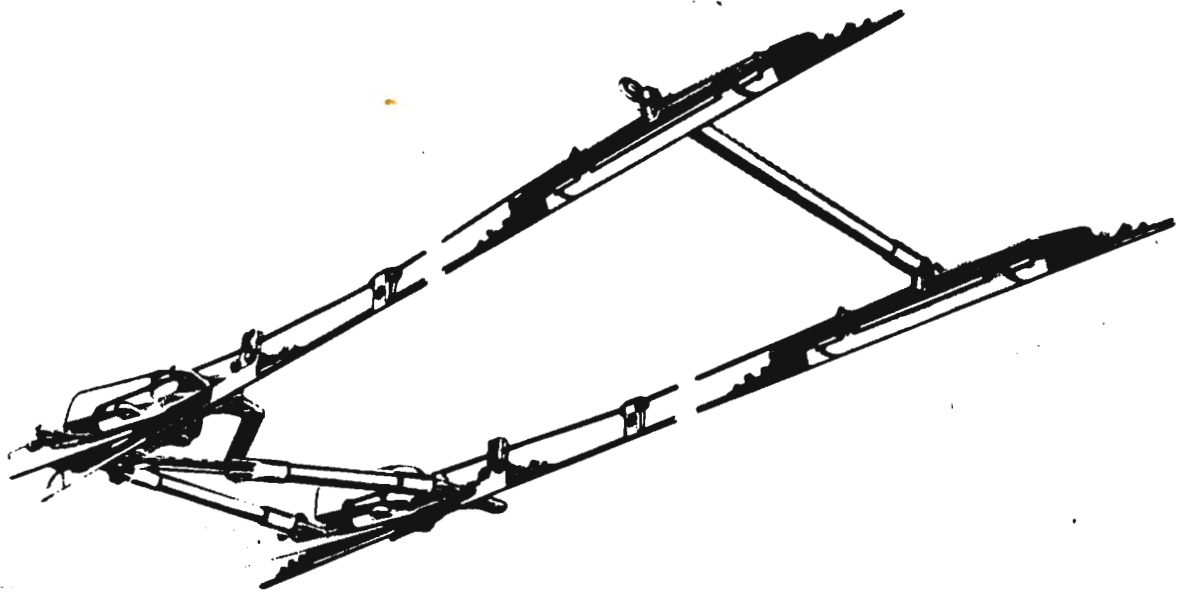

OB Power On - Power Off Switch

Figure 1.2-42

OB Routing Control

This system is being displaced when chopper controlled trolley coaches are used. The constant current draw for propulsion control ventilating and other onboard uses is significant enough to activate power-on/power-off switches when such action is not desired.

- o Radio Control. This system is being installed by Seattle and is currently in use in several European systems and it replaces the one discussed above. Each vehicle is equipped with a transmitter and antenna that will operate inductively. The antenna is mounted on the outer end of the trolley pole. Wayside hardware consists of an antenna and a receiver. The antenna is mounted on the trolley wire as shown in Figure 1.2-43 and the receiver can be on an adjacent pole. In Seattle the route will be selected through the use of the vehicle's directional turn indicator.

Crossover Assemblies. OB crossover assemblies are shown in Figure 1.2-44. Two types are currently available:

- o Fixed runner crossovers that accommodate crossing angles varying from 17 to 90 degrees, and
- o Mechanical crossovers that accommodate 10 to 15 degree angles and are equipped with movable runners that are activated by the current collector.

Four insulators are inserted as shown, to accomplish the necessary insulation where positive and negative wires cross. Current continuity is provided for by installing by-pass wires around the insulators.

The approximate distance between crossovers (distance A on Figure 1.2-44) for various angles is as follows:

<u>Angle (degrees)</u>	<u>Distance (inches/cm)</u>
10	272/691
15	183/465
20	134/340
30	89/226
50	51/130
70	34/86
90	24/61

Section Insulators - Insulators are also employed to sectionalize the contact wire system. The OB insulator incorporates a fiberglass tension rod and a glass melamine runner.

Materials - OB employs malleable iron for many of its castings including frogs, crossovers, curve segments, switch runners, and clamps. All ferrous material is galvanized to protect against rust. Such items as anchor tips and movable runners are made from hard bronze.

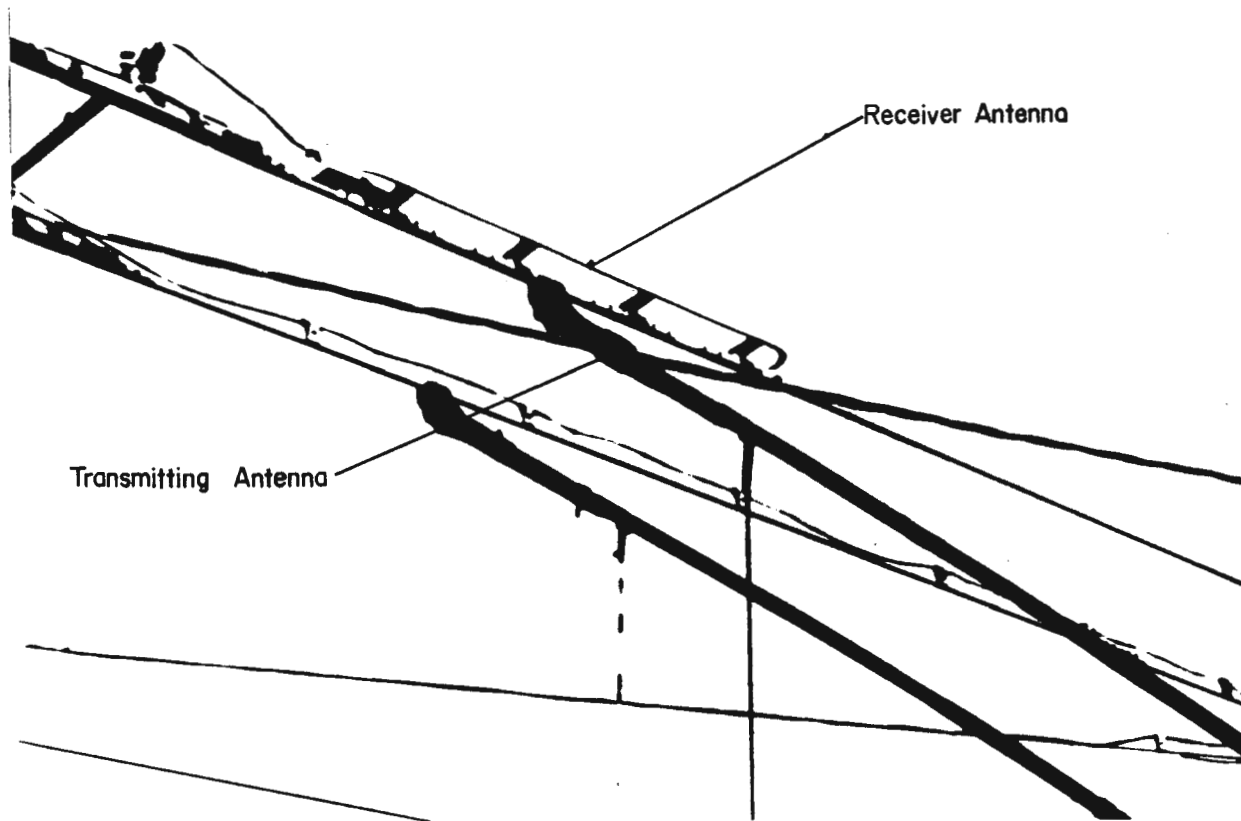
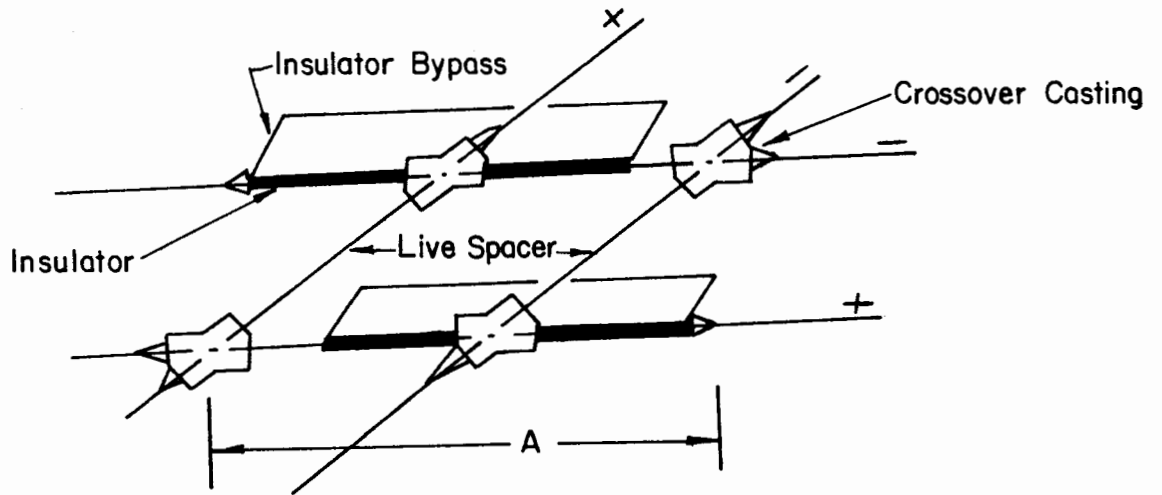
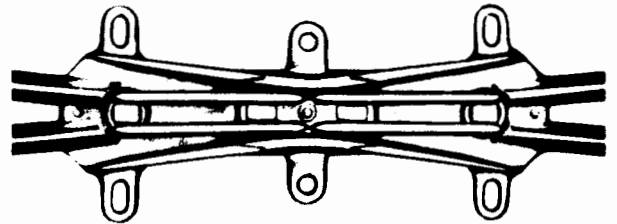

Figure 1.2-43
Inductive Control



Crossover Assembly



10 Degree Crossover Casting
With Movable Runners

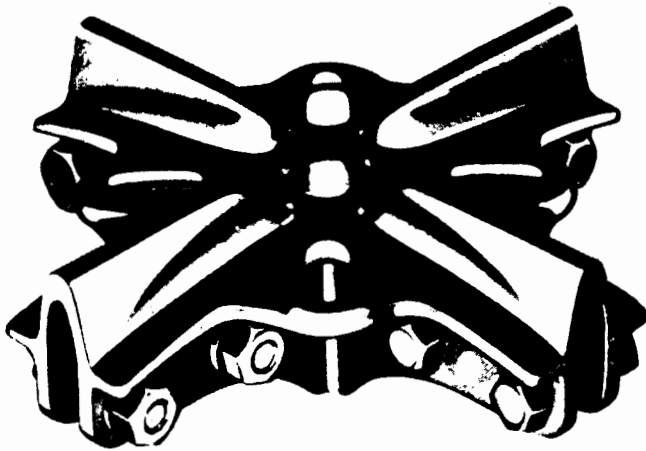

90 Degree Crossover Casting

Figure 1.2-44
OB Crossovers

Contact Surfaces - When current collectors move through OB frogs and crossovers, contact is made between the collector's flanges and casting. In all other situations, contact is made with the collector's carbon insert. This feature, which will be more fully described in the next section, limits the TC's ability to move through special work at normal operating speeds. Slower movement is required to avoid dewirements and damage to both the contact wire system and the collector.

Kummler & Matter (K&M) System

K&M has been a supplier of overhead distribution systems for both street railway and TC systems for many years. During the late Thirties K&M delivered an elastic overhead system for TC's and it was first marketed in the early Forties. The new system advanced distribution system technology and reduced the radio disturbances associated with rigid systems. Since its introduction, K&M has continuously sought to improve its flexible system. The most recent improvements have witnessed the introductions of high speed frogs.

There have been no installations of the K&M system in the U.S. or Canada. Seattle contemplated installing about one mile of K&M hardware as a test, but the project was cancelled. Edmonton has purchased some material but it has not been installed. The new TC system in Guadalajara, Mexico, has been the exception in North America. K&M materials were used exclusively for this new operation.

K&M, in its literature, stresses the "whole system" approach to overhead lined systems. Their approach incorporates the following concepts:

- o The interaction of the collector and the wire system is a pure kinematic design.
- o Suspension system design must be cognizant of the forces generated by such interaction.
- o System components must be installed in a correct manner to insure proper working of the system.

K&M has its own Technical Development and Planning Department and is in a position to turnkey installations of its contact wire systems.

An interesting feature of the K&M system is revealed in statistics kept by Zurich Transit System. In 1977 they had 93 dewirements at switches, or 1.27 dewirements per switch. They experienced 271 dewirements at all other locations for an incidence rate of 8,340 revenue miles/13,343 revenue kilometers per dewirement. Unfortunately, similar data are not available on other systems.

Tangent Segments - K&M achieves an elastic suspension through its use of the slanting pendulum shown in Figure 1.2-45. The slant is maintained by alternating its direction between span wires. This causes a slight zigzag in the contact wire when viewed horizontally. The maximum angle of deflection is limited to about two and one-half degrees and varies according to ambient temperature.

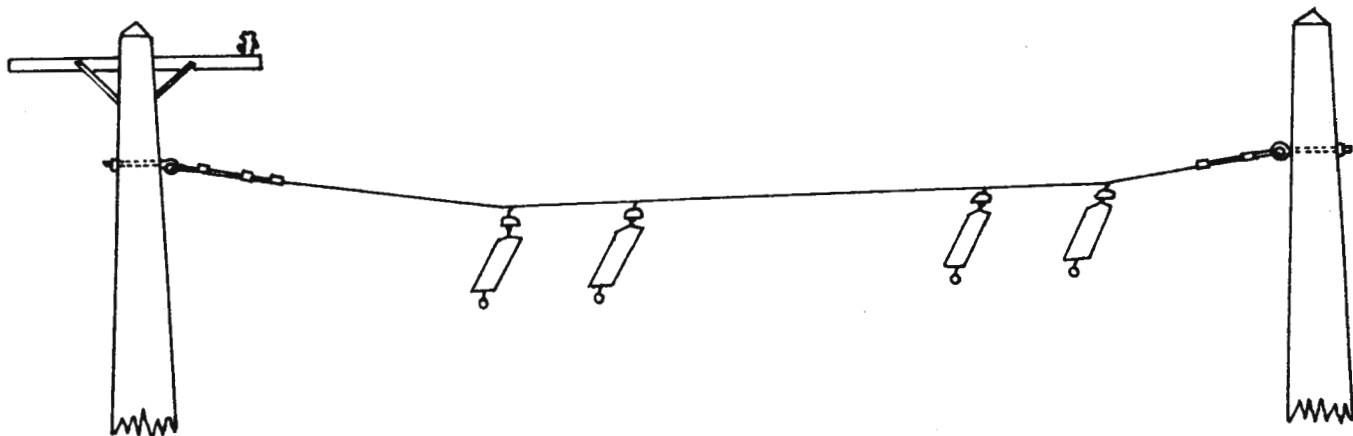

Tangent Construction

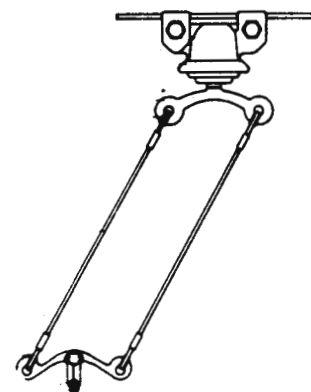
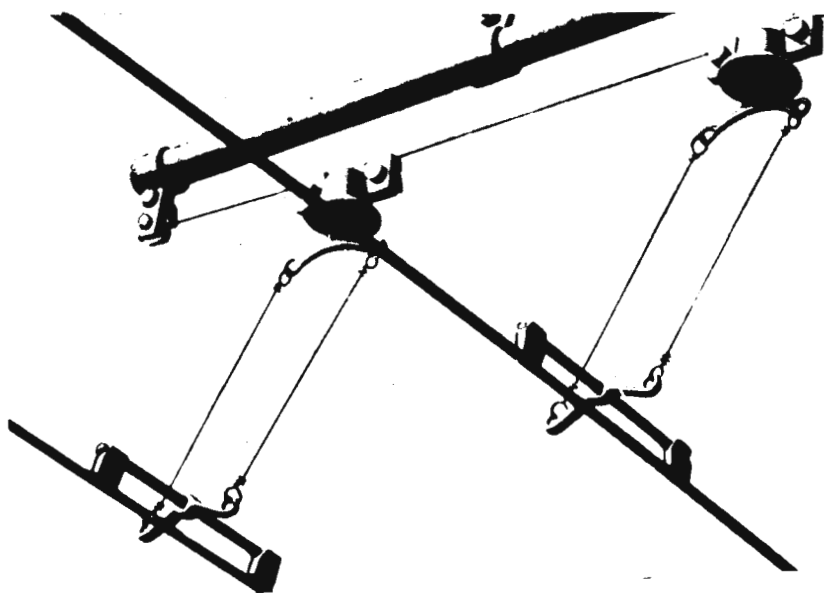

Pendulum Hanger

Figure I. 2-45
K&M Tangent Construction

The pendulum has two forces acting on it, the weight of the suspended wire, which acts downward, and a horizontal pull, which is a function of the deflection angle described above. The downward force decreases as this current collector approaches the suspension point and supports a greater portion of the weight. The decrease of the vertical weight component causes the pendulum to rise. As the contact wire rises in the immediate vicinity of the pendulum, the pressure between collector and wire decreases in the manner described above. A greater amount of wire weight is transferred back to the pendulum and it descends to maintain contact and thus avoids the momentary dewirement experienced in rigid systems. The increase in pressure that occurs when the collector passes the suspension point is absorbed by the upward movement of the pendulum.

The movement of a collector over the wire causes it to oscillate. Oscillation will dampen at suspension points in a rigid system and can lead to wire fatigue. In an elastic system, dampening is accomplished by the movement of the pendulums. The likelihood of material fatigue is greatly reduced.

Span wire construction and insulation are very similar to that employed on OB systems except that the span cannot vary from a right angle crossing by more than 18 degrees. The pendulum assemblies clamp to the span wire and provide insulation in the same manner as OB hangers. The pendulum is attached to the contact wire using two clamps. If the standard height and normal span slope are to be maintained, pole attachment points must be higher to account for the vertical height of the pendulum. The span slope can be reduced to compensate for some of this additional height, but this will increase the moment force on the pole. Movement of the suspension point may also introduce clearance problems with other utility lines using the same poles. The distance between spans can range up to 130 feet/40 meters.

The K&M system will accommodate speeds in excess of 50 mph/83 kmph. An interurban system located near Torino, Italy routinely schedules vehicles at this speed.

Curve Segments - K&M curve segments are elastically suspended. They utilize one to three supporting pendulums depending on the degree of curvature, as shown in Figure 1.2-46. The degree of curvature accumulated by each type is as follows:

1. 3 - 7 1/2 degrees
2. 8 - 14 degrees
3. 14 1/2 - 30 degrees

The pendulums are designed differently to account for an increased slant angle and operator tension. An adjustment is provided to insure proper contact wire attitude.

K&M also provides a tube curve segment as shown in Figure 1.2-47. It is intended for use in areas where space is limited and for deflection angles in excess of thirty degrees. The contact wire is held by strain plates, and copper tubes are provided for the current collector. The tubes provide a smooth curve for the collector to follow. A transition ramp is provided to connect the contact wire with the ramps.

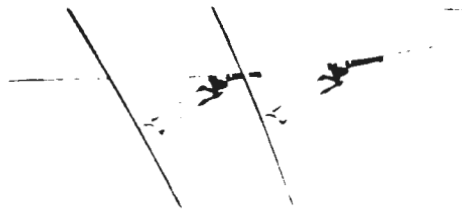

3 to 5 Degrees

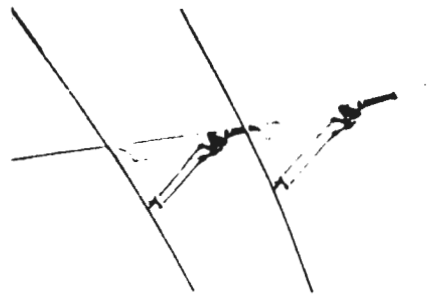

8 to 14 Degrees



14 to 30 Degrees

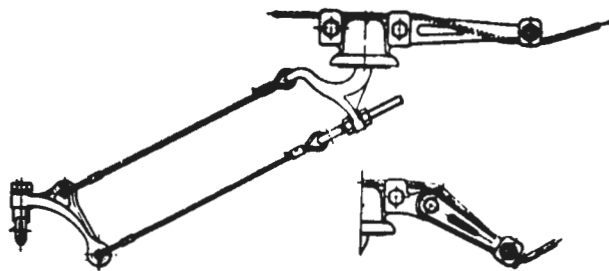

Adjustable Pendulum Hanger



Tubular Curve Segment for Larger Angles

Figure 1.2-46

K&M Curve Segments

Switches - K&M switches do not require that the contact wire be parted. The frogs, crossover and tubes are all hung below the contact wire, as shown in Figure 1.2-47, and can be easily removed when maintenance is required. The standard frog angle is 6 degrees and the crossover angle is 20 degrees. The distance between frog and crossover is approximately 11 feet/3.4 meters.

All movement through the switch is on copper tubes and transition ramps are provided. When the collector moves through a frog, contact is made with a carbon insert. Crossover movements require flange contact. Insulation of crossover wire is accomplished by wrapping one of the wires and inserting fiberglass tubes on either side of the crossover.

When a K&M switch is employed as part of a 90 degree intersection turn, the usual practice is to employ four additional curve segments. These segments will accommodate between 6 and 25 degrees of deflection. This type of construction has two effects:

- o The total length of the curve is longer than a typical OB installation and extends a significant distance outside the intersection. Additional supporting poles and guying will be required in some instances.
- o The wire follows a more natural path, which approximates a parabola. This causes centrifugal force of the shoe to gradually increase entering the curve and decrease in a similar manner leaving the curve. This feature, coupled with shorter spans, minimizes oscillations and decreases dewirement potential.

Unlike OB installations, a sling is installed about 3 feet/914mm above the switch and supports the assembly's full weight. The sling in turn is secured by means of four guys attached to adjacent poles. Wire hangers are hung from the sling and attached to the frog and crossover castings. The switch assembly is free to move upward, but its weight minimizes such deflections.

K&M has recently introduced a high speed frog that allows through movements at unrestricted speeds and diverging moves at 25mph/40 kmph. The principal improvements that make increased speeds permissible include:

- o The deflection angle of the frog has been reduced to two and one-half degrees.
- o The crossover angle was reduced to 10 degrees and movable runners were installed. The runner position is electrically controlled and is linked to frog position.
- o All contact in the assembly is with the collector's carbon insert. There is no contact between the collector's flanges and the assembly.

The length of the switch is increased but the same sling and guying are employed.

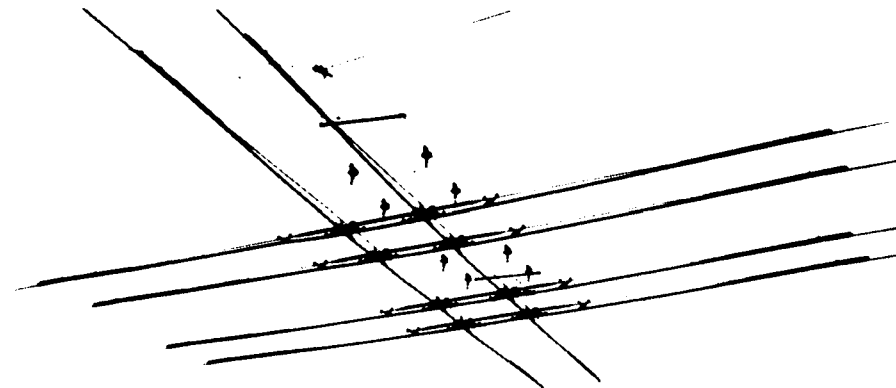

Frog Assembly

Figure 1.2-47

K&M Switches

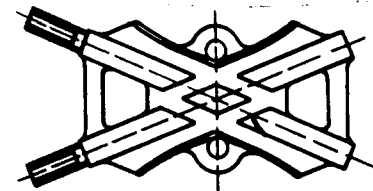

Crossover Casting

Figure 1.2-48

K&M Crossovers

The control of K&M switches is similar to OB with the exception of a new system recently introduced. The systems include:

- o Power-on/power-off - This type of control is identical to the same named OB System.
- o Inductive control - This system is similar to the radio system to be employed in Seattle. The principal differences are:
 - the antenna mounted on the overhead system is replaced by a coil in the pavement, similar to that used to activate traffic signals.
 - the antenna on the vehicle is mounted on its underside. Diverging movements require that the driver activate the switch simply by pressing a button. On many Swiss coaches the button is located in the middle of the driving column. Through movements require no action.
- o Micro Processor - This system is completely automatic and requires no driver action while the vehicle is in revenue service. Each switch in the system has its own unique identity. The processor has on file the correct position for all switches on a given line. Each route has its own unique identification card which is inserted into the processor. When a switch is encountered, the system recognizes its identity, determines the proper switch setting and executes the appropriate command. K&M has just recently marketed this system and it currently is used in Bern, Switzerland.

Crossovers - K&M crossovers do not require the parting of contact wires. Crossover castings and tubes are installed below the wires and transition ramps are provided, as shown in Figure 1.2-48. Insulation is provided at positive and negative crossings by wrapping one of the wires. Fiberglass tubes are also installed on each side of the crossover casting. The entire assembly is supported by a sling in the manner described above for switches.

Angles ranging from 10 to 90 degrees can be accommodated. The 10 degree crossover utilizes movable runners, but all others are rigid castings. The carbon surface is in continual contact with castings.

Section Insulators - Unlike the OB system K&M uses insulators only to sectionalize the overhead system. The insulator has a low profile and is shaded like an upside down "U." The insulating material bolts to a clamp which in turn is secured to the contact wire.

Materials - K&M utilizes bronze for its major castings, e.g., frogs and crossovers. Tubes and other related fittings are made with copper. Galvanized steel is used for pendulums and curve segments.

Furrer and Frey (F&F)

The F&F overhead system has been marketed for many years and is employed on numerous European systems. It is marketed in some areas by the Brown-Boveri organization. The system does not appear to be as flexible as K&M's but neither is it as rigid as OB's. This subject will be further appraised as individual components are discussed. Design improvements have been made over the years. The most recent improvement witnessed the introduction of "UNICOP" high speed switches.

Tangent Segments - F&F employs its own unique suspension system for tangent alignments as shown in Figure 1.2-49. The hanger assembly is attached to the span with two bronze rods and clamps. The rods attach to a spacer bar which in turn supports the insulators and wire clamps. The assembly normally is installed without any slant angle. If the contact wire has any horizontal deflection at the suspension point a slant angle will occur.

Since there is no slant angle the assembly is less flexible than that made by K&M. The fittings allow for some degree of upward movement but additional movement requires the assembly to move sideways and up at the same time. The OB hanger has no latitude for vertical displacement without raising the span wire. Although this system is not fully flexible, it cannot be classed as a rigid system.

The depth of the assembly is about 18 inches/455 mm requiring higher attachment points on support poles if standard span slope and wire height are to be maintained. The span must be installed at an angle of 90 degrees to the contact wire.

Curve Segments - Typical curve segments are as shown in Figure 1.2-50. All segments employ a spacer bar which supports hangers, clamps and runners. The contact wire is clamped to runners in all cases and is the contact surface. The segment which accommodates curves varying from 3 to 9 degrees is soft suspended but all others are attached directly to the span wire. Deflection angles in excess of 15 degrees require two pull-offs to support the proper angle.

Switches - The contact wire must be parted for the installation of F&F frogs and crossovers. The standard deflection angle on the frog is 5 degrees and the crossover angle is 10 degrees. The crossover is equipped with movable runners which are electrically controlled and synchronized with the frog runners. Insulators are installed on each side of the crossover to accommodate the crossing of positive and negative wires. All movement through the switch assembly is on the contact wire except for the moveable runners. The contact wire is brought directly into the main body of the casting.

The switch is supported by a sling similar to the K&M assembly. The castings also have eyelets and can be supported or held in position by span wires. Lateral restraint is often required since the assembly does not use tubes or runners which add some degree of rigidity. The length of the switch is similar to K&M's and its installation in a 90

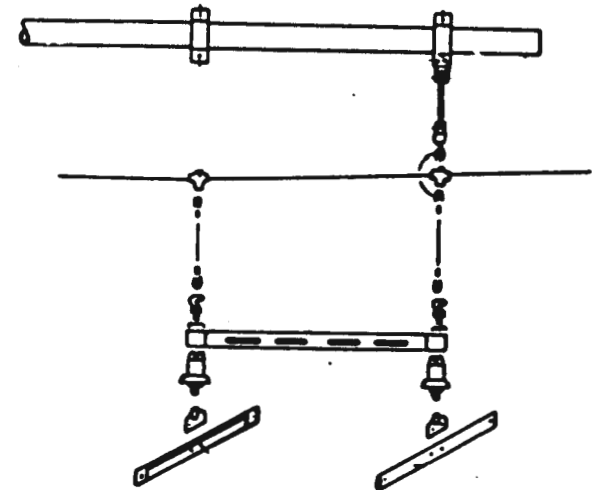
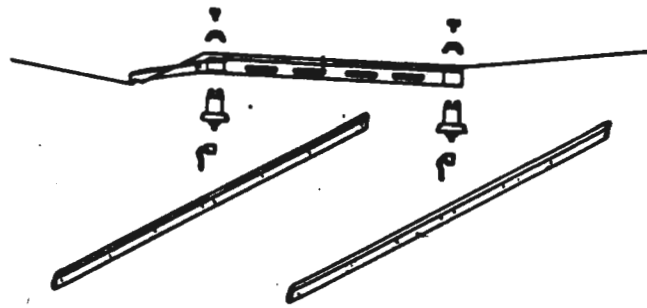
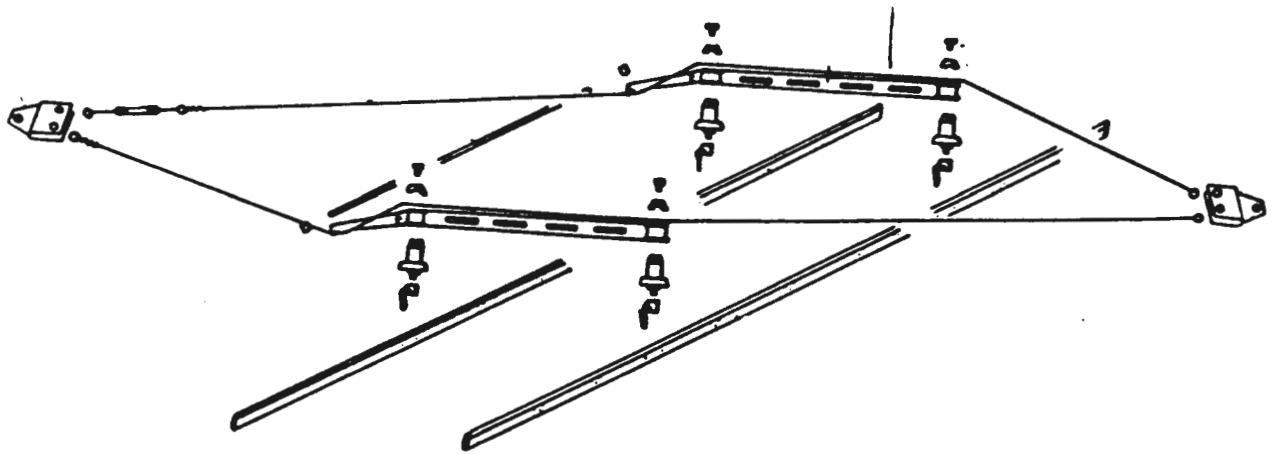

Figure 1.2 - 49
F&F Tangent Construction



F&F - Curve Segments for Angles 3 to 9 Degrees



F&F - Curve Segments for Angles 9 to 15 Degrees

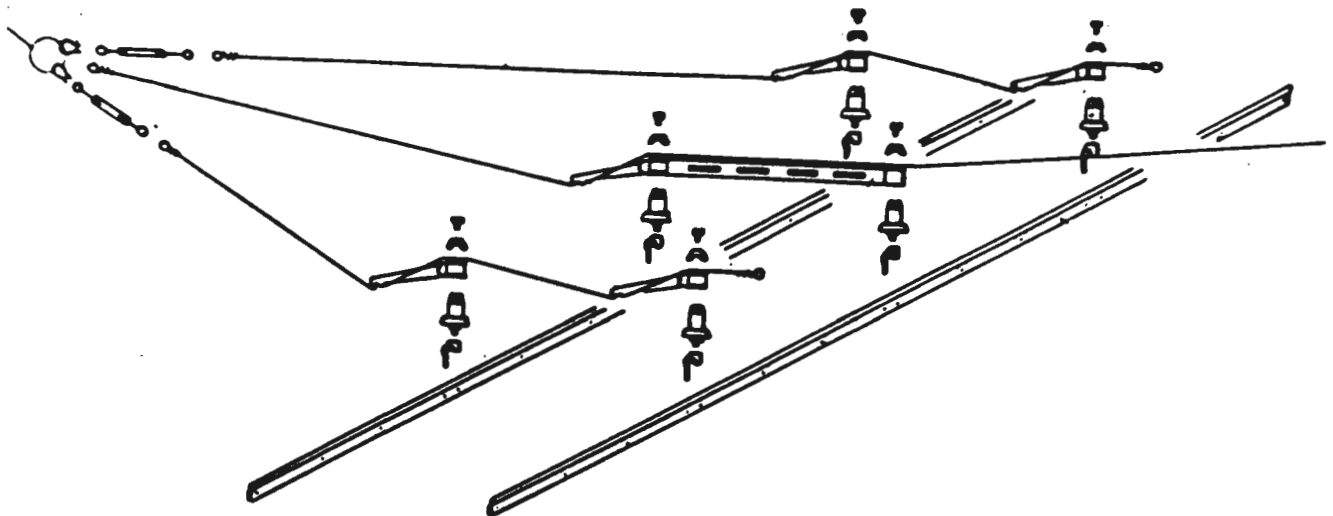

F&F - Curve Segments for Angles in Excess of 15 Degrees

Figure 1.2-50

F&F Curve Segments

90 degree intersection turn will lengthen the curve and increase the number of curve segments required. The switch is shown in Figure 1.2-51.

Control of the frog runners can be accomplished by employing several of the systems mentioned above. These systems include power on/power off, inductive control and radio control.

Crossovers - F&F crossovers are very similar to OB. The wire must be parted and four insulators are required to insulate positive and negative wires. A bypass wire is provided to ensure current continuity. Crossing angles vary from 10 to 90 degrees. The 10 degree casting has moveable runners and the others have the runners cast in place. The 10 degree crossover can also function as a double slip switch. The entire assembly is supported by a sling.

Delachaux

Delachaux has marketed an overhead system for many years, and it is employed on numerous French and Swiss systems. It is very similar to the OB's and can be classed as a rigid system. The following discussion will deal only with the principal differences between the two systems.

Tangent Segments - Delachaux has designed a flexible hanger for use on tangent sections of wire. It is pictured in Figure 1.2-52. The hanger consists of a span wire clamp which is attached to a circular insulator. The insulator supports four rods that are in turn attached to two wire clamps. The depth of the hanger is 7.4 inches/188 mm. and the distance between the clamps is 41.1 inches/1040 mm.

The rods that attach to the circular insulator have been fashioned into oblong shapes at the point of attachment. This feature allows for vertical movement of the wire without the need to raise the hanger body and the span wire. Thus, the hanger imparts some degree of flexibility. It does not appear to be as flexible as the K&M system, since the amount of vertical contact wire deflection is more restricted. The hanger is made of galvanized steel.

Curve Segments - The curve segments offered by Delachaux are pictured in Figure 1.2-52. The contact wire is attached to a steel bar with clamps that produce a smooth curve. The steel bar is attached to an insulated pull-off using a "Y" shaped attachment member. The Y section is hinged allowing some degree of vertical movement. The hanger can be used for angles varying between 4 and 30 degrees.

Comparison of OB and K&M Systems

A detailed and factual comparison of these two systems is yet to be made. Perhaps the best comparison is the experience of LES Transport Publics de Lausanne (TPL) of Lausanne, Switzerland which employs both

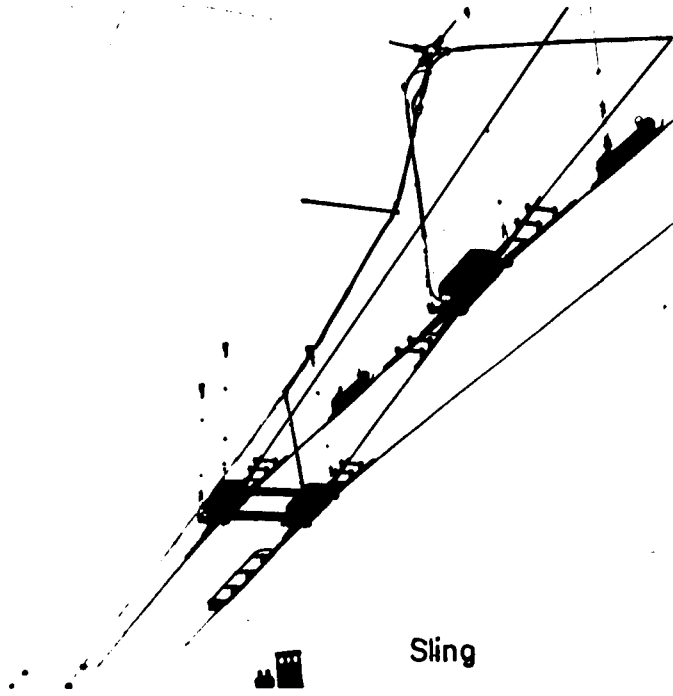

Sling

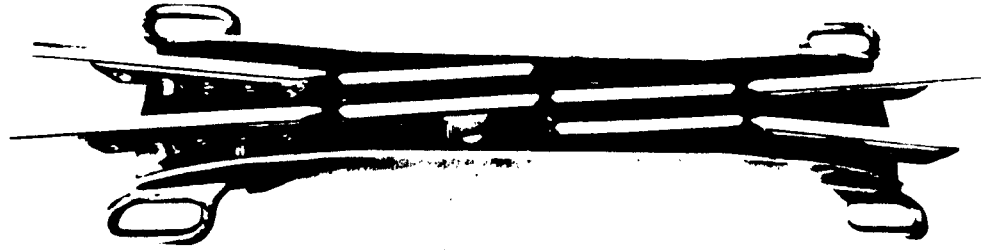

F&F - Crossover Casting With Movable Runners

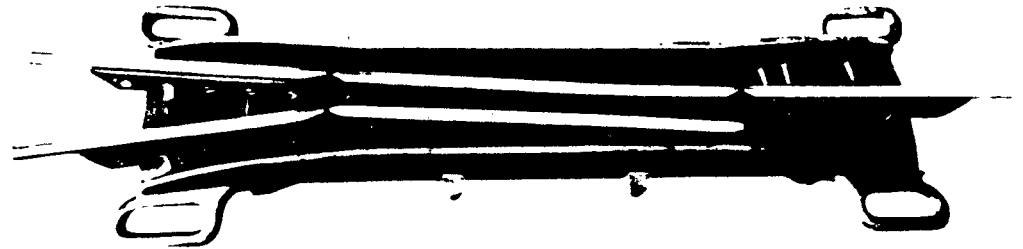

F&F Frog

Figure I. 2-51
F&F Switches

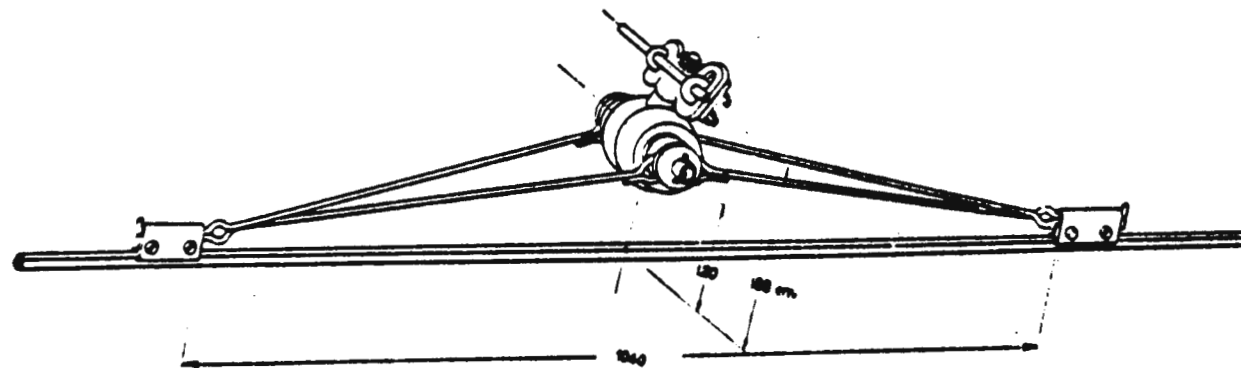

Delachaux Flexible Hanger

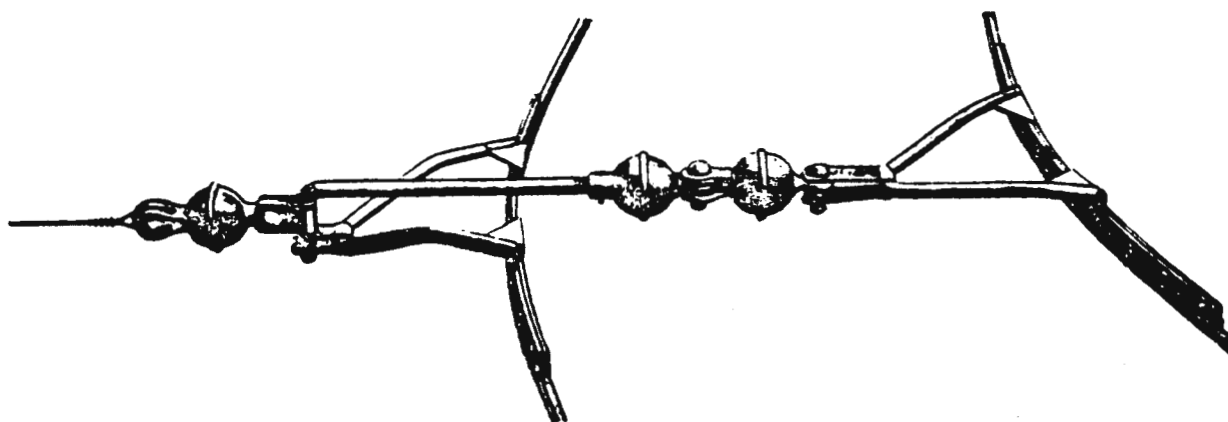

Delachaux Curve Segment

Delachaux Line Hardware

Figure I. 2- 52

systems. Their comments on the two systems are as follows:

- o Speed - The K&M system is faster and has been installed on suburban routes where high speeds can be realized. OB hardware is used in the city center but it has no effect on speed of operation since most restrictions are due to traffic and street geometry.
- o Maintenance - It is very difficult to say which system is easier to maintain. A significant proportion of the total maintenance effort is directed toward problems which are not related to system type. Included are such items as the effect of weather, trees that damage the overhead and vehicles that collide with support poles. It was stated that one long section of K&M wire, installed 27 years ago, required no significant maintenance until this year.
- o Room for installation - OB switches and curve segments require less space. TPL uses OB material in the center city where streets are narrow and intersection space is restricted. K&M switch assemblies have been used in suburban areas where greater room exists and higher speeds are desired.
- o Emergency situations - Wire breaks with OB hardware are localized and only adjacent spans have too much slack to accommodate traffic. In such a situation, the TC will use its auxiliary battery power to operate around the break. Breaks with K&M hardware will cause a loss of tension over far more spans necessitating temporary motor coach service.
- o Temporary wire construction - OB hardware can be moved or installed temporarily much easier than K&M hardware.
- o Cost - It was TPL's opinion that K&M material was more expensive. This is partially due to the current exchange rate between the dollar and the franc.
- o Future use of K&M and OB Systems. TPL foresees no change and will continue to use both systems.

Clearance problems would exist for either system in areas that have not had TC's previously. This problem is mitigated in many cities, particularly on major arterials, owing to the practice of undergrounding utilities. The problems on existing U.S. and Canadian TC operations may be greater for K&M since all clearances are sensitive to characteristics of the O-B system. Changes would have to be made to accommodate the additional height of K&M hardware.

Current Collection System

The function of the system is to collect current from the overhead system and transmit it to the propulsion and other electrical systems onboard the vehicle. The system has four principal components:

- o Current Collector - referred to numerous times in the previous section,
- o Trolley Pole - supports the collector and allows coach touring,
- o Trolley Base - supports the trolley pole and exerts the pressure required to keep the collector on the wire, and
- o Trolley Retriever - protects the overhead in case of a dewirement.

The system is currently in use in the U.S. and Canada, and has remained essentially the same since the mid-Forties and is offered by OB. Figure 1.2-53 illustrates the current collector system.

Current Collector - Early trolley coach operations employed a variety of current collectors. Some were similar to four-wheel carts that rode on top of the trolley wires and were tethered to the vehicles with a flexible cable. Others employed a single trolley pole holding a crude sliding collector. In the early Thirties some operators employed trolley wheels similar to streetcars of that time. Presumably the wheels were used to be compatible with round wire hardware.

The collector currently marketed by OB is shown in Figure 1.2-54. It consists of four principal subgroups: the carbon insert, the shoe, the saddle and the body. Normally the carbon insert provides all contact with the wire system except for special work when the shoe's flanges are in contact with frog and crossover castings. The carbon insert is held in place by a set screw in the shoe. The life of a carbon insert varies by operator and ranges between 500 and 2800 vehicle miles (800-4,500 vehicle kilometers).

The shoe, in addition to holding the carbon, provides overall guidance for the collector. The flanges provide contact in special work and prevent lateral forces from dewiring the collector. The shoe must be replaced after the flanges have worn .25 inches/6.3mm. The worn shoe can be rebuilt.

The saddle holds the shoe and is free to rotate in both the horizontal and vertical planes. The horizontal movement allows the TC to tour without dewirement. The vertical movement allows the collector to conform to changing wire scope and retain contact over the length of carbon insert.

The body casting provides a seat for the saddle and attaches directly to the trolley pole. The socket pin on the bottom of the casting holds the saddle in place. The forward portion of the body is shaped in a manner that will minimize the chances of catching in the overhead should dewirement occur. An eyelet is provided on the back of the body for the attachment of the retriever rope.

ARRANGEMENT OF CURRENT COLLECTION EQUIPMENT For Trolley Coaches

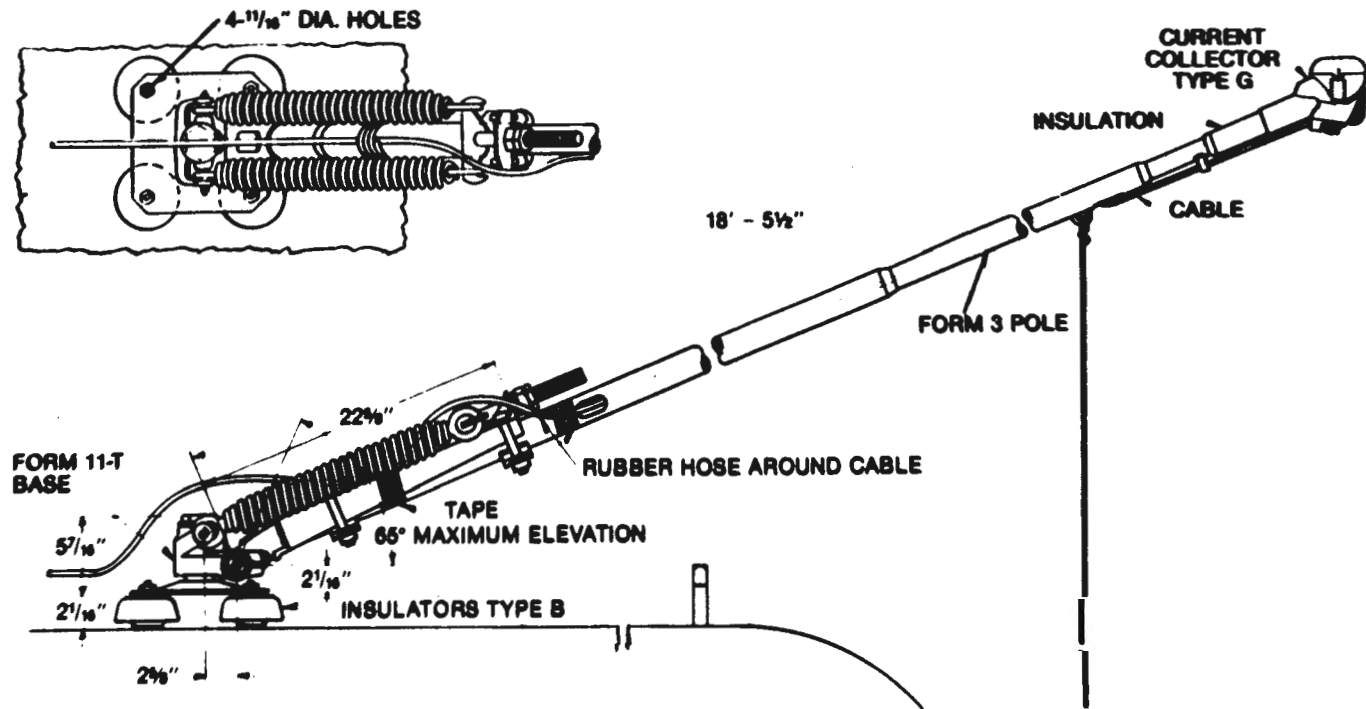
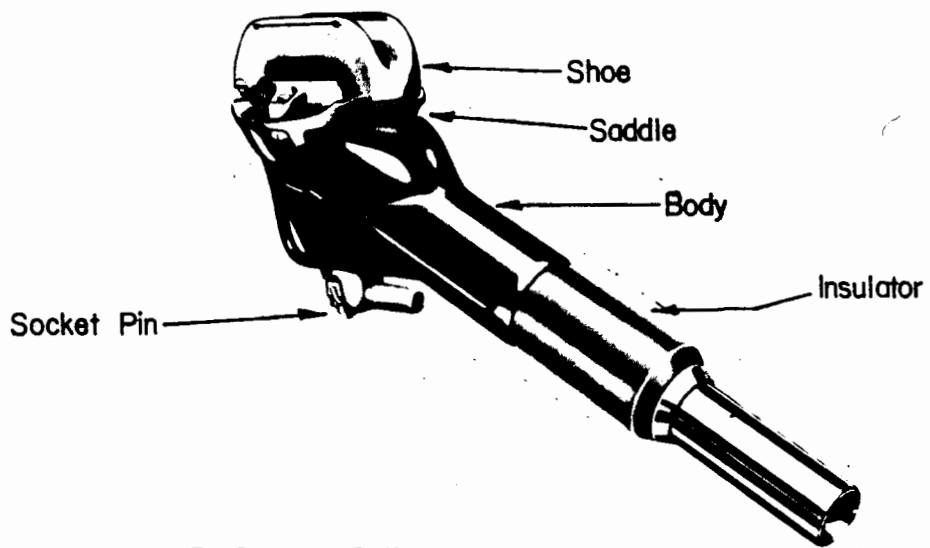

Figure I.2-53
Current Collection System



OB Current Collector



Delachaux Current Collector

Figure 1.2-54
Current Collectors

The collector used on the K&M system is more sophisticated than its OB counterpart. This collector, one version of which is supplied by Delachaux, has the following improved features and is shown in Figure 1.2-54.

- o The body is hinged and acts like a shock absorber. When the collector changes direction, lateral forces are induced. The collector will deflect at the hinge to absorb this force and then right itself for straight wire operation. This feature allows fast speeds on curves and reduces the possibility of dewirement and minimizes oscillations in the overhead.
- o The carbon inserts are tapered from front to back with the wide end forward. No set screws are required and old carbons can be removed simply by prying them loose with a screwdriver. New carbons are seated and pressed in place with a thumb.
- o The saddle is held by a pin which will shear when the collector is caught in the overhead. The saddle will then detach itself from the collector's body, thereby preventing damage to both the collector and the overhead system.

Each system suggests the use of the appropriate collector if maximum performance is to be achieved. This is normally a valid recommendation and is followed by most operators. Lausanne, on the other hand, uses OB collectors and operates them over special wire supplied by K&M, apparently without major adverse effects.

Trolley Pole - Trolley poles are seamless steel tubes that vary in length according to operator preference, but are usually 17 feet/5.2 meters long and tapered to account for the movement forces which insure proper contact pressure at the wire. The diameter varies from 1.25 inches/32mm to 2 inches/51mm. A conductor is placed inside the pole and is the principal path for current between collector and vehicle.

Fiberglass trolley poles have been experimented with but original designs were so flexible that dewirements increased. Their cross section is larger and problems have arisen in designing suitable adaptors to allow the use of existing trolley bases.

Trolley Bases - This piece of hardware supports the pole and imparts the force needed to maintain pressure between collector and contact wire. As seen in Figure 1.2-55, the force is imparted using two springs. The spring can be tensioned to suit individual needs. The base also rotates and enables the TC to tour. Bases are insulated from the coach when installed.

Retrievers - This device is employed to protect both overhead and current collector in case of dewirement. The retriever is sensitive to sudden vertical movement of the pole when the distance is in excess of about 3 feet/914mm. When dewirement occurs, the pole is pulled down to the roof line. The driver must then release the retriever and rewire

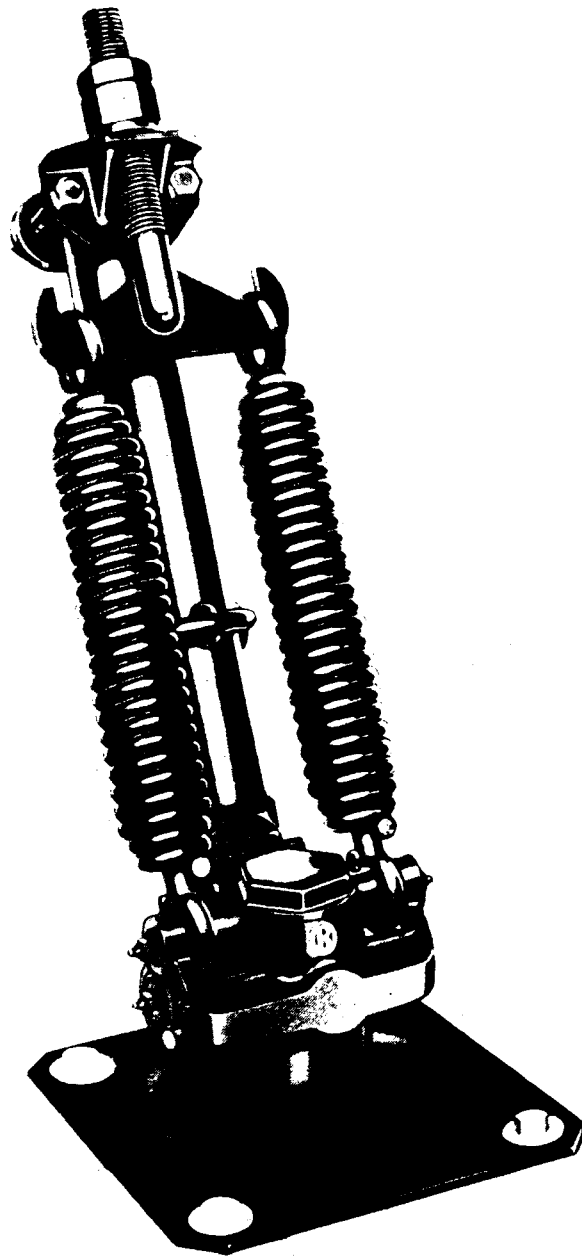

Figure 1.2-55
Trolley Base

the pole. When contact wire is installed, the transitions between varying wire heights should not be too steep. If they are the retriever will sense the rise as a dewirement and pull the poles down.

The practice of using the retriever has always been universal in this country. A number of European operators, principally in England and Germany, have not employed this hardware.

Automatic Retriever System

Retrievers of this type are used to raise and lower trolley poles without driver aid. Normally this feature has been used by all service vehicles, although it has been used in conjunction with auxiliary power systems where wire could not be installed for short distances. Examples of this system are as follows.

Public Service System - Public Service Coordinated Transport, now known as Transport of New Jersey, operated an all-service system in Northern New Jersey. The retriever system they employed consisted of the following components.

- o Motorized retrievers - Two retrievers were installed with electric motors that would raise or lower the trolley poles. They were located on the backside of the coach in normal fashion and were controlled by the driver.
- o Pole securement devices - When the poles were lowered, they were automatically pulled into this device and locked down. The driver would unlock the device when he desired to rewire the poles.
- o Wire pan - The pans are horizontal and "V" shaped at their exit end. The driver positions the coach very precisely to rewire the poles. When each pole is on its respective pan, the TC pulls forward and the V channels the collectors onto the contact wire. The TC then switches to electric operation, the pans are not energized, and it proceeds on its way.

Keipe System - This system was used in Germany to overcome the absence of wire at crossings with electrified railroads. Seattle purchased a secondhand system for experimentation purposes. The system is similar to the one described above with the following exceptions.

- o The motorized retriever is mounted on the TC roof.
- o The pan is shaped like an upside down "V" and requires precise vehicle spotting. As the pole rises, the collector will contact the side of the V, which will guide it to the contact wire. The wire in the pan is energized and the vehicle can proceed immediately under electric propulsion.

Dornier System - In conjunction with the DUO-Bus project, Dornier has developed an automatic system that does not require exact positioning of the vehicle. The equipment employed by this system consists of normal components with the following exceptions and modifications:

- o Trolley bases - the bases are equipped with two motors which control vertical and horizontal movement.
- o Antenna - Each current collector has one antenna which is in the up position during the rewiring process.
- o Retrievers - No retrievers are employed having been replaced by the motorized trolley bases.
- o Memory unit - This equipment makes it possible for the system to accomplish rewiring when the coach is in different positions.

The functioning of this system is best explained on a step by step basis. Let it be assumed that the coach is to right of the wire in a bus stop. The operator initiates the rewire procedure simply by activating a button. The poles first move down out of the securement hangers and the antennas rise. The poles then move toward each other, to clear the securement device and start to rise. As the poles rise, they spread and swing to the left. At the end of this cycle each pole is about 3 feet/914mm horizontally from the wire. The vertical distance must be less than the height of the antenna. In the final cycle the poles move toward the wire until the antennas make contact. The poles then move up, contact the wire and the antennas drop to their storage position. The entire process takes less than 20 seconds and the vehicle must be standing when both wiring and dewiring take place.

The automatic settings can be preselected to correspond to the routine positions the vehicle will be in when rewiring is necessitated. If it is necessary to rewire the vehicle in a non-standard position, the process can be accomplished manually by manipulating two dials on the driver's console.

This system is very sensitive to wire height and reprogramming is required to overcome the seasonal variation in wire heights. This problem can be minimized by installing short spans at normal rewire locations. The pavement at rewire locations must be flat and should not be rutted or have other surface irregularities.

The system was used in daily service on one bus in Esslingen, Germany. Initial problems were encountered but corrections have been made. The antenna hinge had to be redesigned because it had a tendency to stay in the up position after rewiring and foul the overhead. Alterations are to be made which will allow dewiring to take place while the vehicle is in motion. Testing will continue on five second generation DUO-Buses.

Power Supply for Trolley Coaches

The design of a power supply for trolley coach operations is a simple engineering task with few design options. There is a universal supply standard of 600 volts direct current (DC) although existing systems can range from 550 volts to 750 volts DC and one Swiss system has a 1000 volt DC supply because of a previous streetcar operation at that voltage. Substations may be adjusted to produce slightly higher voltages, typically 650 volts, possibly as high as 750 volts, because of local conditions, e.g., grades, long feeder circuits or high power demands which increase the voltage drop during distribution.

Although alternating current propulsion systems are now available for trolley coaches, they operate from 600 volts DC through a solid state inverter. Alternating current power supply is not feasible for urban transit applications. While AC supply would reduce substation costs, it would produce unbalanced loads on the three phase incoming supply and suffer higher distribution losses. Experiments with single phase and three phase alternating current supplies for rapid transit have indicated that they are not cost competitive with a direct current supply.

Trolley coaches are designed to operate at 600 volts DC plus 20 percent, minus 30 percent for a range of 400 to 720 volts. However many designs of propulsion systems will operate at 750 volts DC with higher performance or as low as 300 volts DC with impaired performance. Certain solid state control systems (thyristor chopper or AC inverter) cannot function below a cut-off voltage of between 400 and 500 volts. Normal design practice is to ensure that the voltage drop where the feeder connects to the overhead line is not less than 85 percent of the nominal system voltage. Buses are equipped with lightning arrestors that can accommodate transient energy surges to 2,500 volts with an energy content of 1500 watt seconds.

Present substation designs use transformers to drop voltage from any nearly three phase supply of suitable capacity to a six or twelve phase low voltage alternating current which is then rectified by a silicon diode bridge with comparable phases. The rectifier further reduces the voltage to the nominal 600 volts DC. Substations are usually a standard industrial package design.

Principal options include the type of distribution:

- o large substations with multiple feeders
- o small substations with few feeder circuits
- o feederless systems

and whether to use any form of remote monitoring and control (supervision).

Power Requirements

The power requirements for a trolley coach power system can be determined from:

- o Headways
- o Scheduled speed
- o Diversity curve - an empirical factor that determines the mean power demand of a number of TC's
- o Street grades - percentage and length in section
- o Off schedule factor - provides increased capacity to allow for irregular operation
- o Growth factor.

The power network must be divided into sections which can be served by a specific substation or feeder. Information on headways and scheduled speeds will provide the number of TC's in any sector at the peak time. This can then be referred to the diversity curve, tabulated below, based on the standard North American trolley coach with General Electric MRC resistor switched control. The per coach current demand can be adjusted for other types of coaches or control systems. Articulated or heavier coaches will require more power, as will DUO-Buses that must charge batteries while on the wire for later off wire operation. Coaches equipped with regenerative braking will have lower current demands while those with regenerative braking and on-board energy storage will have still lower demands.

Table 1.2-7

Trolley Coach Diversity Tabulation
Flyer Coach with MRC Controls
(derived from Ohio Brass data)

<u>No. of Coaches on Overhead Section</u>	<u>Current "load swing" in Amperes</u>	<u>Average Current per Coach in Amperes</u>
1	200	200
2	400	200
3	530	177
4	640	160
5	730	146
6	810	135
N	$80N + 810$ <i>(N-5)</i>	$\frac{80N + 810}{N}$

Grade compensation is tabulated below. Where grades extend for only a part of the overhead section the increased power demand can be adjusted in direct proportion.

<u>Grade on section In Percent</u>	<u>Current Per Coach</u>	<u>Increase In Percent</u>
5-9	240 amperes	20
10-14	300 amperes*	50
15-17	400 amperes*	100
18-20	450 amperes*	125

* Requires hill climbing boost feature and extra resistors.

The addition of an off schedule factor compensates for irregularities in headway, for example, two coaches running together, extra trips or special services. This factor is 30 percent for 1 to 20 coaches on the section, which is the scheduled number of TC's in the section times 1.3. For 21 to 40 coaches in the section the off-schedule factor is 25 percent but not less than 6 coaches (480 amp). For 41 or more coaches per section, 20 percent is used but not less than 10 coaches (800 amps). This does not accommodate the exceptional power demands for the start-up of a row of coaches after a blockage. Operating rules must restrict such a start-up. Typically they require a coach to be 400 feet/122 meters away before the next coach in the line starts.

The final compensating factor is for growth. Normal practice is to increase current demand by 25 percent. However if the route serves a stable neighborhood or projections do not indicate any anticipated increase in transit use this factor of 1.25 can be reduced or eliminated. Alternately the factor can be built-in by assuming that future coaches will be more energy efficient i.e., with solid state controls and/or substantial amounts of regenerative braking.

This average coach current demand is converted into substation capacity by calculating the internal power losses and feeder losses. While this is a system specific item, typical figures for substation losses are between 3.5 and 4.5 percent of coach kilowatt capacity. Feeder losses are higher and vary more widely. Typical losses range between 15 and 25 percent of coach kilowatt capacity and occasionally higher figures are experienced.

The resultant substation capacity in kilowatts therefore becomes, for Flyer Coaches equipped with GE MRC controls,

$$\begin{aligned} \text{Substation capacity (kw)} &= \left(L + \text{Increase for grades} \right) \times \text{Off-schedule factor} \times \text{Growth factor}^{**} \\ &\quad \times \frac{\text{System voltage}}{1000} \times \left(1 + \frac{\text{Substation Losses} + \text{Feeder Losses}}{\text{Losses}} \right) \end{aligned}$$

where L represents the number of scheduled coaches in section applied to Table 1.2-7 to obtain ampere load swing.

** Solid state controls with regeneration can be substituted for no growth factor and a no growth situation can be assumed.

As an example for the supply of one section with N coaches where N is between 5 and 20, there are no grades, and system voltage is 600.

Substation
 capacity (kw) = $730 + (N-5)80 \times 1.3 \times 1.25 \times 0.6 (1 + \text{losses})$

Assuming losses at 4 percent for substation inefficiency and 20 percent for feeder losses the calculation may be simplified to:

Substation
 capacity (kw) = $400 + 97N$ with growth factor*.

Substation
 capacity (kw) = $320 + 78N$ without growth factor.

Table 1.28

Substation Capacity (see text for assumptions)

Number of scheduled coaches in section(s)	2	5	10	15	20
Capacity (kw) with growth factor*	487	885	1370	1855	2340
Capacity (kw) without growth factor	390	710	1100	1490	1880

This capacity tabulation can be clarified by relating the number of coaches in a section to headway. Assume a one mile (1.6 km.) section (both directions) typical of the feederless power system. Then at 12 mph/19 kmph there will be 5 coaches in the sector on 2 minute headways, 2 on 5 minute headways and 1 on 10 minute headways. If the speed drops, to 6 mph/10 kmph, then the number of coaches per section doubles.

Thus with a five minute headway, a feederless station would require a 400 to 500 kw substation approximately every mile. On longer headways of say every 7-10 minutes with thyristor chopper coaches, no regeneration and a reduced growth factor, 300 kw substations would be typical.

Feeder design requires the conversion of the average coach current per section into root mean square (RMS) amperes by application of a form factor based on a coaches speed-current characteristics over a typical 700 foot/213 m. start to stop plus dwell run. The form factor will be between 1.4 and 1.5. Once the RMS current demand by section has been determined, substation size, location and feeder type can be selected. This is an interactive process and it may be necessary to rearrange the sections and recalculate current demand to produce the optimal system.

* Solid state controls with regeneration can be substituted for no growth factor or a no growth situation can be assumed.

Feeder Type

Early substation technology used attended rotating convertors and switch gear and it was desirable to design for large substations feeding a number of overhead sections. The most economical feeder system uses heavy overhead cables that are visually obtrusive, particularly with multiple feeders close to a substation. Feeders can be placed underground at considerable extra expense, depending on the availability of existing spare conduits.

Modern silicon diode rectifiers can be used in small compact 'package' substations with little diseconomies of scale. These can be used to feed just two sections connected directly to a heavier overhead line without feeders, designated a feederless system. The small substations do not require land and buildings as they can be installed in a vault under the roadway or sidewalk or as a self-enclosed pad mounted unit. A feederless system requires a heavier contact wire (or contact wire plus messenger wire) to avoid excessive voltage drop or uneconomically close substation spacing.

Recent studies in Seattle have recommended a hybrid system for the almost all new trolley coach supply. This system is under construction and uses the feederless system in suburban areas with feeders downtown where an existing site and underground ducts were available. Such a hybrid system is likely to be optimal for other networks where a number of routes converge into one area. Typical feeder and feederless systems are shown in Figure 1.2-56.

Regardless of the type of feeder system, the same ground rules apply to the regulation of voltage. Regulation is the permissible voltage drop under load and is a function of the current draw and the resistance of the overhead and feeders.

Voltage Regulation

The first voltage drop in a supply network is that of the substation. This is countered by making the output voltage under a normal load condition the desired level, i.e., 600 volts. In this situation, an unloaded substation would produce typically 630 volts. Thus, substation voltage drop need not be taken into account in network design.

With a feeder system, the next voltage drop is in the feeders. These are heavy insulated copper or aluminum cables and trolley wire as listed in Table 1.2-9.

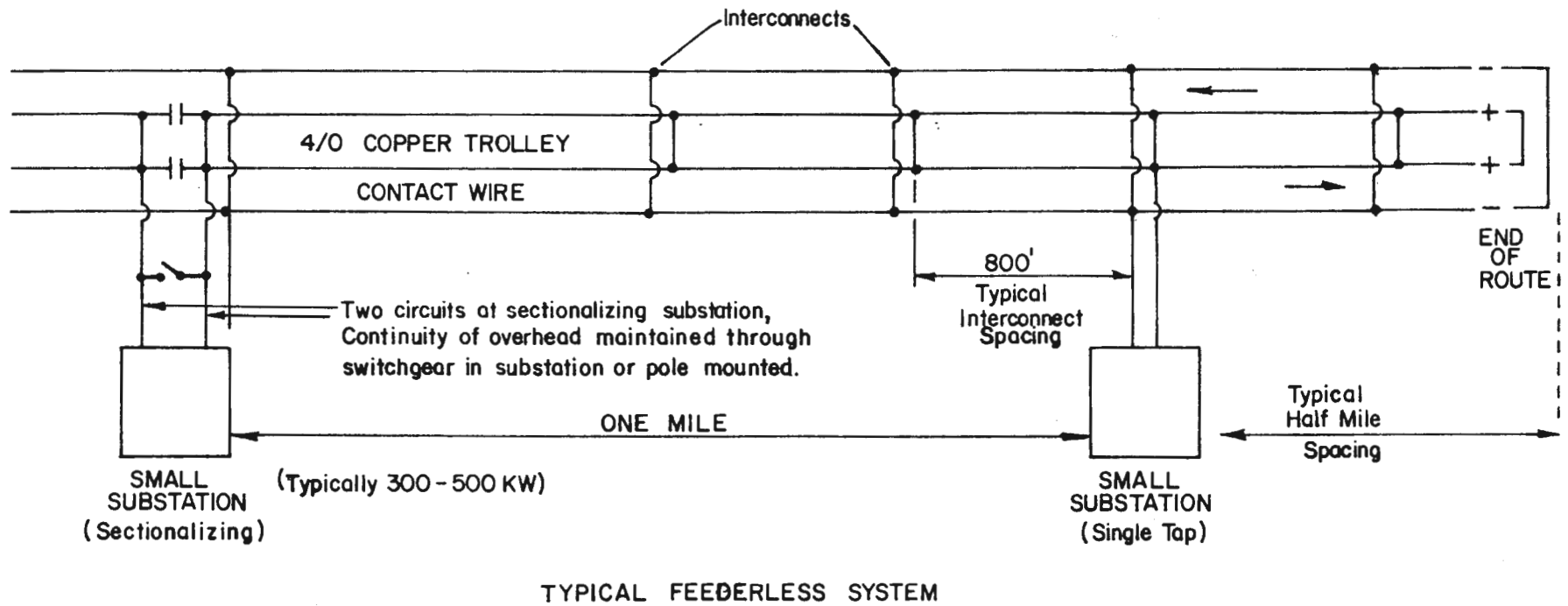
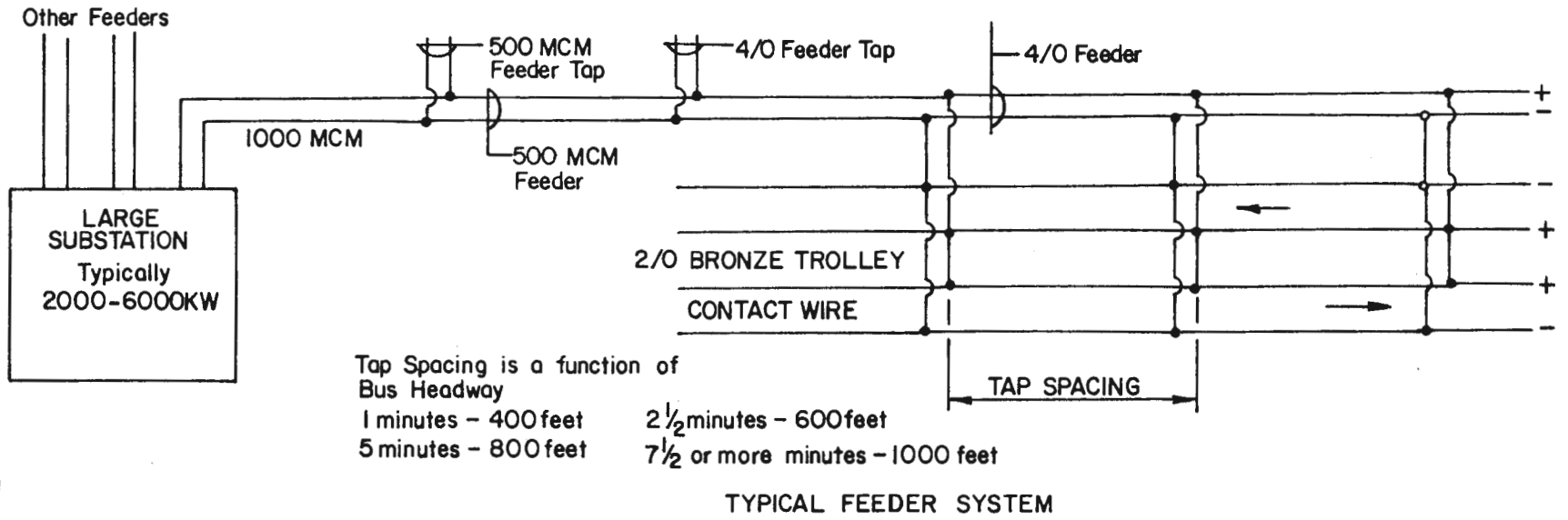

Figure 1.2-56
Trolley Coach Power Supply
Feeder vs. Feederless System

Table 1.29

Cable and Wire Data

<u>Size</u>	DC Resistance in Ohms/1000 feet at 20 degrees C.		
	<u>Hard Drawn Copper</u>	<u>Bronze 80% (1) Conductivity</u>	<u>Aluminum</u>
T 2/0 AWG	.0774	.0940	---- (2)
T 3/0 AWG	.0638	.0775	---- (2)
TF 4/0 AWG	.0507	.0611 (3)	.0831(2)
TF 300 MCM	.0358	.0432 (3)	.0586(2)
F 500 MCM	.0215	----- (3)	.0350
F 1000 MCM	.0108	----- (3)	.0176

(1) Will vary with alloy,

(2) Aluminum is not suitable as trolley wire although it has been used (and is still used) in some cities as an economy measure or due to shortages,

(3) Bronze is not used as feeder cable as the extra strength and better wear properties are not important,

T - Sizes available as grooved trolley wire suitable for overhead contact wire 2/0 and 4/0 are the most commonly used sizes,

F - Sizes appropriate for feeder cable

AWG = American Wire Gauge, MCM - one thousand circular mils

The voltage drop along a circuit is a simple calculation:

Voltage drop = ohms/1000 feet x total bus RMS amperes x distance.

Note that the resistance in the circuit reflects the circuit length from the substation to the load and return. Feeder resistance will therefore reflect twice the geographic distance. The contact wire on a two way route will be connected in parallel at a number of points and its effective resistance will be equivalent to the geographic distance resistance.

The resistance of a parallel circuit is added as the inverses of the constituent resistances. Thus a 2/0 hard drawn copper trolley wire with a 500 MCM feeder in parallel has a resistance R where:

$$\frac{1}{R} = \frac{1}{0.0774} + \frac{1}{(.0215 \times 2)}$$

therefore:

$$R = 0.0276$$

Thus, with a 100 amp load the voltage drop will be 27.6 volts per 1000 feet/305 meters or 146 volts/mile (91 volts/km.).

There are two major criteria for voltage regulation.

- 1 - In normal circumstances, but allowing for off schedule operation as outlined in substation capacity requirements, the line voltage should not drop more than 15-20 percent of its nominal value, i.e., it should not go below 480-510 volts.
- 2 - In emergency circumstances with a substation out of service, line voltage may be allowed to drop 30-40 percent below its nominal value, to 360-420 volts, unless coaches with solid state controls have a cut out voltage above this value.

Substation Spacing

There are too many system specific criteria to provide details on substation spacing. The locating of large substations on a system using feeder will be a tradeoff between the DC feeder costs with the cost of land for a site, the availability of a location acceptable to the community, and the cost of providing AC power to the site.

On a feederless system, substation location is determined by the ampere load and size of the overhead trolley wire. Table 1.2-10 below shows substation spacing for 3/0 and 4/0 hard copper grooved trolley wire. Table 1.2-11 provides the special case for the last substation on a route. In this case, the overhead is only fed from one end. At all other locations a section will be fed from substations at each end which will share the load.

Table 1.2-10

Substation Spacing - Feederless system - Two-way wire

<u>Load</u>	<u>Contact Wire</u>	<u>Substation Spacing (feet/meters)</u>		
		<u>10% drop</u>	<u>15% drop</u>	<u>20% drop</u>
1000 amperes	3/0 copper	3800/1158	5600/1707	7500/2286
1000 amperes	4/0 copper	4800/1463	7100/2164	9500/2896
700 amperes	3/0 copper	5400/1646	800/2438	10700/3261
700 amperes	4/0 copper	6800/2073	10000/3048	13500/4115

Note: Spacing is inversely proportional to both ampere load and wire resistance.

Use of an overhead contact system with a messenger wire (catenary system) requires the effective resistance of both contact and messenger wires to be taken into account.

Table 1.2-11

Distance to Substation from End of Line Feederless System - Two-Way Wire

<u>Load</u>	<u>Contact Wire</u>	<u>Distance (feet/meters) from last substation to end of line</u>		
		<u>10% drop</u>	<u>15% drop</u>	<u>20% drop</u>
700 amperes	3/0 copper	1400/427	2100/640	2800/853
700 amperes	4/0 copper	1800/549	2700/823	3600/1097

This table assumes two coaches accelerating at the end of the line drawing 350 amperes each and the use of hard drawn copper contact wire. Thus in a feederless system with 4/0 copper two-way wire, three accelerating coaches midway between substations will draw 1000 amps, and require approximately 1 mile/1.6 km. spacing to provide 15 percent regulation. This case approximates a 5 minute headway with one off schedule coach. However for the same regulation the last substation must be 2700 feet/823 meters from the end of the line, to accommodate two simultaneously accelerating coaches. This is a common situation when a scheduled coach leaves the terminal followed by a coach returning to the garage.

In emergency conditions with one of the feederless substations out of service in the above example voltage may drop below the 15 percent regulated level of 510 volts to 450 volts. However if the last substation is out of service the voltage at the end of the line will drop to 450 volts with one accelerating coach, 300 volts with two. Service can still be maintained in this circumstance unless solid state controls drop out at the lower voltage.

Substation Reliability

Solid state substations are highly reliable with low maintenance requirements. Transformers and silicon diode rectifiers are usually designed for cooling without forced ventilation. Typical mean time between failures for a small unit suitable for a feederless system is four years or greater and it is often possible to detect impending failures by temperature rises or transformer oil analysis.

Larger substations on feeder systems will incorporate redundant components with two incoming power supplies (preferably from separate sources) two or more transformers and rectifiers and banks of AC and DC switch gear with spare units. Three bus bars (internal interconnection circuits) with appropriate switch gear will allow the selection of the incoming circuit plus disconnection of components at the low voltage AC and the DC bus bar. Reliability will then exceed that of normal power utility service except in total outages (System power failures). However certain component failures will reduce the substation's capacity. It is no longer usual to supply spare transformers or rectifier banks except in very large substations.

Protective Relaying

Protective relaying is provided on the AC and DC switch gear in substations to trip circuits under certain circumstances including over and under voltages and overloads. On large substations, automatic transfer systems can be installed to isolate faulty components or select the incoming supply.

The DC breakers that feed the overhead will be equipped with instantaneous series trips set for both reverse and forward currents at about 20 percent above the load swing current for the particular section and between 100 and 200 percent of the breaker coil rating. When a fault is detected the breaker will automatically trip and then automatically reclose after a short delay. This will be repeated for 3 or 5 times. If the fault that caused the excess current has not cleared the breaker will remain open (switched off).

There can be difficulties in differentiating between a fault current and a legitimate demand such as several coaches starting at once. Rate-of-rise relays are available which can distinguish between certain types of overload. However their application must be system specific as they can reduce fault protection.

Where two or more substations feed the same section protective relays must be coordinated or interconnected. This is necessary to prevent a fault being fed from a more distant substation with the inherent overhead resistance reducing the fault current to below trip levels.

It is rarely necessary to deenergize overhead as almost all maintenance except installing new wire is carried out with the overhead 'live' or 'hot.' However to control fault currents the overhead must be separated into discrete sections. In order to continue operation with a defective substation, switch gear is used to bridge certain section gaps (an insulator about 18 inches/46cm. long inserted into the overhead positive wire). While these switches can be equipped for remote operation, this is an unnecessary luxury, as their use is exceptionally rare.

Supervisory Control

Large DC power networks such as those in subway systems use remote supervisory control to monitor and operate circuit breakers in substations. DC supplies for trolley coaches may not need supervisory control, as there is less importance in continuity of supply with respect to the safety of passengers, who cannot be trapped underground between stations. In addition, there is no ventilation or emergency power supply to monitor. Modern substations are highly reliable and most fault corrections can be performed automatically as described in the section on protective relaying.

If the trolley coach power network is part of a large DC system, which already incorporates supervisory control, or if the supply system is contracted out to a power utility, it may be practical to add the supervisory control of the trolley coach supply to the existing control with considerable economy of scale. However, if supervisory control must be established from scratch, the cost of manning the control board is high. For feederless or small substation systems, which are without redundant equipment, supervisory control can do little that cannot be performed automatically.

If a fault does not clear (see protective relaying section) then attendance at the scene is necessary to determine and correct the fault. A line crew can be dispatched by transit control on hearing of the outage from a coach driver almost as rapidly as from a power system supervisor. The response will be as quick if the coaches are equipped with radios.

Substations can be equipped with exterior warning lights which indicate overheating or other problems. These can be seen and reported by drivers or connected via remote-dial trouble phone to transit control.

Where supervisory control is necessary, recent advances in digital telemetry, and video displays can reduce costs below those associated with older systems and their obsolete technology.

Regeneration

One of the problems with trolley coaches equipped to regenerate is that the overhead line is unreceptive much of the time. Coaches must thus be equipped with controls and resistor banks to accept braking power when regeneration is not possible. There are two ways to avoid this and so remove the resistors from coaches, except for a small capacity unit to absorb energy while the coach is on section gaps, or insulators. One is to arrange for higher voltages on the overhead. This requires special protective relaying and the ability of all coaches to accept this voltage (say up to 1000 volts) without damage. This is quite possible if all coaches were equipped with solid state controls and inverters for auxiliary supplies. The only other line voltage load would be the 600 volt heaters, which are insensitive to over voltages. Such an arrangement merits consideration for entirely new trolley coach systems but has not been applied on existing systems due to compatibility needs of older equipment and substations.

The other method to increase receptivity is to provide reversible substations which will accept DC power from the overhead and either invert it back to the AC supply or dump it in substation resistors. This latter process has been used on some older subways where it is advantageous to remove heat waste from cars to the substation and thus reduce heat build-up below ground. However it wastes energy and has little or no merit for surface transit operations.

A reversible inverter equipped substation was fitted on a new light rail line in Hannover, West Germany, in 1976 as a demonstration sponsored by the German Ministry of Research and Technology. All vehicles on the line are equipped with chopper controls with full regeneration capabilities. Results were compared between sections of the route with and without this reversible feature.

On four minute headways 27 percent of the vehicle's accelerating power was regenerated and returned to the line for use by other vehicles, 4 percent of accelerating power (excluding transmission losses and auxiliary loads) was either burned in on-board resistors or, in the section equipped, inverted to AC and returned to the utility company distribution system. On eight minute headways 25 percent of the vehicle's accelerating power was regenerated and used by other vehicles, and 6 percent of power was inverted into AC.

Inverters therefore cannot be economically justified except with long headways and where a considerable premium is placed on the saving of electrical energy. Power utilities are generally unwilling to accept this return power which is in irregular surges and has an unclean wave form.

REFERENCES

CHAPTER 1.2

1. "600 volt Propulsion System for Electric Trolley Coaches," General Electric, Erie, Pennsylvania, June 1976.
2. "Solid State Propulsion System for Trackless Trolley Coaches," Randtronics, Menlo Park, California, 1978.
3. "MRC Control - Chopper Control Economic Comparison," General Electric, Erie, Pennsylvania, August 1976.
4. "AC Induction Motor Drive in a Trolley Bus," Oy Stromberg, Helsinki, Finland, 1977.
5. "Trolley Bus ER100" - Technical Notice, Berliet - Traction CEM Oerlikon, Paris, France, January 1977.
6. "Standard Trolley Buses with Chopper Power Control," Secheron, Geneva, Switzerland, 1974.
7. Personal Communications with Siemens AG, West Germany, September 1979.
8. Description, Operation and Maintenance Handbook, Telma, Cergy Cerex, France.
9. A Macro Analysis of Variables Influencing Transit Usage, G.L. Thompson, Bureau of Transit Services, British Columbia, April 1973.
10. Study of Flywheel Energy Storage, Volumes 1-5, UMTA-CA-06-0106-77-1, September 1977.
11. "Trolley Gelenkbus," Graf & Stift AG, Wien, Austria, 1978.
12. "Ikarus Glenk Trolley Bus," Mogurt, Budapest, Hungary, 1978.
13. "9Tr Trolley Bus," Skoda, Plzen, Czechoslovakia, 1973.
14. "Trolley Bus," Energomach Export, Moscow, USSR.
15. Various pamphlets and articles describing the DUO-Bus, Daimler-Benz, Stuttgart, West Germany.
16. Ohio Brass Transit Catalog, #76, Ohio Brass Company, Mansfield, Ohio, 1978.
17. Kummler & Matter Handbook and Manual, Kummler & Matter AG, Zurich, Switzerland.
18. "Considerations sur les Liches de Contact Modern pour Trolley Bus," M. Adolphe and M. Hug, Revue Generale de L'Electricite, January 1955.
19. "High Speed Electric Overhead Contact Line for Trolley Buses," Kummler & Matter, Zurich, Switzerland.
20. "Overhead Hardware Evaluation, Municipality of Metropolitan Seattle," R.W. Beek and Associates, Seattle, Washington, July 1976.
21. "OBus Fahrleitungsmaterial," Furrer & Frey, Bern, Switzerland.
22. Electrical Construction Code, State of Washington.
23. Transit's Stepchild - The Trolley Coach, Sebree and Ward, Cerritos, California, 1974.
24. "Trolley Coach News," North American Trackless Trolley Association, (various volumes), Louisville, Kentucky, 1974-1978.

CHAPTER 1.3

OPERATIONAL AND ENVIRONMENTAL EVALUATION

This chapter describes the operational and environmental characteristics of trolley coach systems. The initial sections deal with the area of operations. Subjects include performance reliability and capacity. The subsequent sections address the environmental issues of noise, air pollution and energy consumption. Throughout this chapter, the focus is on a comparison of trolley coaches and motor coaches in surface street operation. This comparison attempts to place the two vehicle types in a similar setting. Comparison of existing trolley coach and light rail operation is not generally meaningful, as almost all light rail systems have substantial portions of exclusive rights of way.

Operating Performance and Speed

Introduction

Common thought has held that the TC is a superior vehicle in terms of acceleration and overall operating performance. During the period of the TC's maximum utilization, the late 1930's through the late 1950's, this was a very true statement. The TC would out-perform motor coaches propelled by either diesel or gasoline engines. Several reasons can be cited for this situation:

- o The trolley coach was propelled by a DC motor which has the characteristic of high torque throughout its operating range and a high acceleration rate.
- o The DC motor has a significant overload capability and can deliver high operating performance on most grades that are encountered in normal transit operations.
- o Propulsion systems available for motor coaches were either not mature products or were not designed to comparable performance standards.

The performance of the motor coach improved in the early 1970's when the 8V-71 Detroit Diesel was made available to the transit industry. This propulsion system provided greater acceleration and power and overcame many of the performance deficiencies of the 6V-71 and the older 6-71 engines built by Detroit Diesel. The maximum acceleration rate provided by this new engine and the General Electric 1213 motor are both above the tolerance limit for standing passengers.

The superior performance of TC's was also partially attributable to the fact that most were equipped with double stream doors. The ability of patrons to use four, rather than two, access points reduced dwell time. This in turn lowered running times and increased speed of operation. The

current manufacturers producing transit coaches in the U.S. and Canada have standardized on single width front doors. Double stream center doors have been available on a special order basis for both TC's and motor coaches. Comparisons that are made between these vehicle types today cannot credit the TC with superior dwell time performance, since the same door options are available to each vehicle.

The top speed obtainable with a trolley coach has generally been less than that obtainable with a diesel. This fact does not constrain the TC since its maximum speed of 40 mph/64 kmph is greater than that which is required or permissible in most urban local route operations. Top TC speeds have been restrained by rigid overhead, the rear end gear ratio and, in the past, the lack of both desire and need for faster operation.

Performance Characteristics

The performance characteristics of the TC have remained essentially unchanged for many years. This has been due to the fact that most TC's built since 1940 have utilized the General Electric 1213 motor or a close equivalent. The performance curve for coaches of varying weights employing this motor are shown in Figure 1.3-1. Also shown in this figure is the acceleration curve for a General Motors T8H5307A with functioning air conditioning.

The performance of TC's on grade is shown in Figure 1.3-2 as is that of the GM T8H5307A. This figure also demonstrates the overload capabilities of the 1213 motor. For short periods the vehicle will operate on excessive grades at acceptable operating speeds. Table 1.3-1 compares the performance characteristics of TC and motor coaches.

Table 1.3-1

TC and Motor Coach Performance *

	AMG <u>10240E</u>	GMC <u>T8H5307A</u>
Maximum Acceleration (mphs/mpsps)	3.5/1.5	2.7/1.2 (A)
Maximum Speed (mph/kmph)	40/64	55/88.7
Time (sec) Required to obtain 25 mph/40 kmph	10	14

A - will vary according to rear drive ratio and type of injectors employed.

* Reference 12

According to a study undertaken by SEPTA, (Reference 12), a TC will require 7.3 seconds per mile less running time than a motor coach. This amount is exclusive of any savings attributable to double stream doors. Assuming that the average transit route is ten miles long, TC's will reduce running time by 73 seconds. This amount is well within the range of normal running time variations and is far less than layover times usually provided.

Figure I.3-1

Trolley Coach Operating Characteristics
Single Motor - 48-50 Passenger Coaches

Weight of Coaches	18,000	20,000	22,000	23,500
Average Pass. Load	7,350	7,350	7,350	7,500
Totals	<u>25,350</u>	<u>27,350</u>	<u>29,350</u>	<u>31,000</u>

Motor Type - GE-1213
Gear Ratio - 11.59 to 1
Wheel Dia. - 42 inches

Average Voltage - 550
Grade - Level
Average Stop - 7 secs.

Leeway - 10% of time in motion
Accelerating & Brake Rate - 3.5 MPHPS

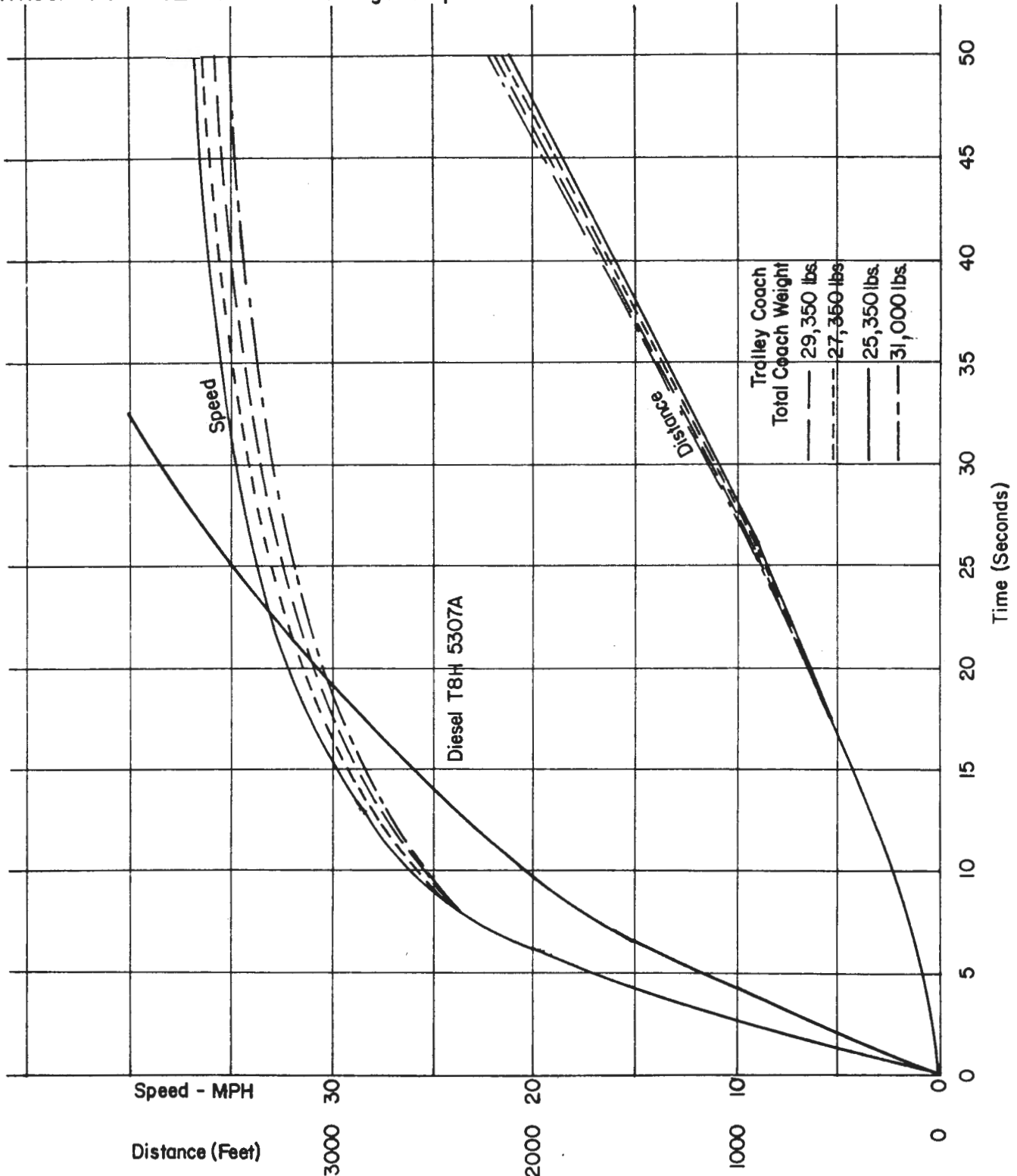
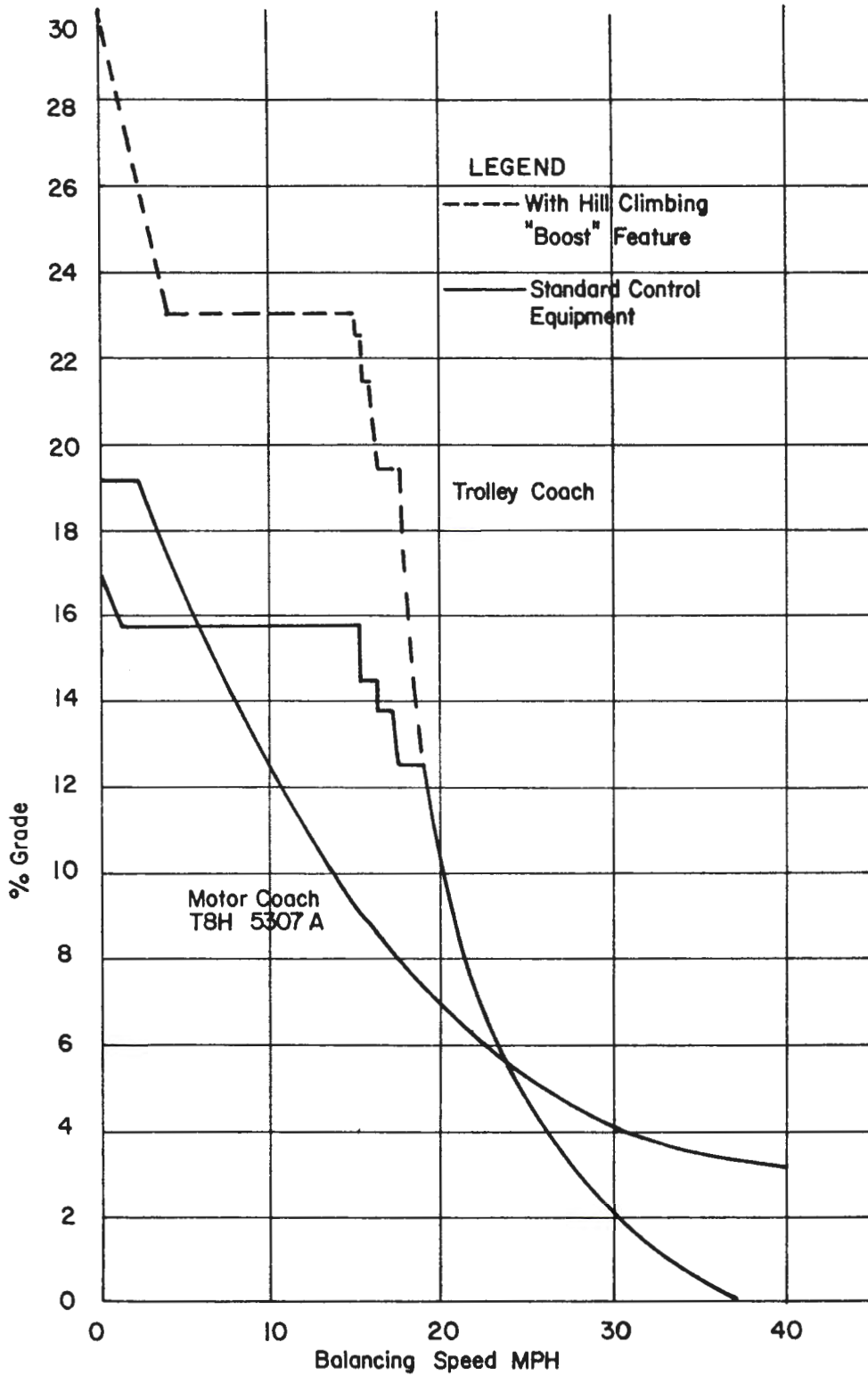

Figure I.3-2

Gradeability Curve
Trolley Coach
GE-1213 Motor
Total Weight - 15.5 Tons
Wheel Dia. 42" Line Voltage - 550
Gear Ratio 11.59:1 General Electric Company



Street Performance

The performance data provide some degree of insight as to how different vehicles will function when placed in revenue service. An alternative course is to seek out comparisons in actual operating environments. Four systems were reviewed to determine how the trolley coach's actual street performance compared to that of the diesel bus.

Edmonton - ETS stated that no differences are acknowledged between the two vehicles. From an operational point of view, they are considered to be interchangeable. This fact is demonstrated on a daily basis. Presently, ETS lacks sufficient trolley coaches to fulfill the vehicle requirements of its existing trolley lines. Motor coaches are pressed into service daily on these routes. During August, 1978, a strike by electrical workers required that complete substitution of motor coaches be made for all trolley coaches. No revisions were made in the operating schedule, (running times and headways) to accommodate this temporary conversion.

Vancouver - The findings in this city parallel those in Edmonton. Diesel coaches are frequently pressed into service on trolley routes when there are insufficient numbers of serviceable trolley coaches. Additionally, BC Hydro operates one route, 41st Street Crosstown, with both TC and motor coaches. The running time is the same for both vehicle types.

A comparison was made of route segments served by both TC's and coaches. One such segment is Granville Street between Robson and Broadway, a distance of 1.5 miles. This street is a main arterial that includes a shopping mall restricted to transit vehicles and a bridge where high speeds are obtainable. The running time for both vehicles is identical.

Seattle - METRO temporarily converted all TC service to diesel in order to facilitate the rebuilding and expansion of the overhead contact wire system. Several route segments were selected to determine if there were significant differences in running time between the two vehicle types. The results are shown in Figure 1.3-3. The type of equipment employed is shown on the figure.

It should be emphasized the comparison is between 35 year old trolley coaches and nine year old diesels. Further, the service pattern on Route 2 was changed effective with substitution of motor coaches. The effective headway was reduced between First and Denny and Queen Anne and Galer and increased on the remainder of the segment, when new route 13 was introduced on February 23, 1978.

The conclusions do not appear to favor either vehicle type. Consider, for example, the outbound segment of Route 2 during the peak periods. Trolley coaches have the better performance in the evening peak (due largely to their performance on Queen Anne Hill), but the reverse is true in the morning peak.

Figure 1.3-3

Comparison of Running Times in Seattle

Route 2

Between First and Denny and 7th and West Raye

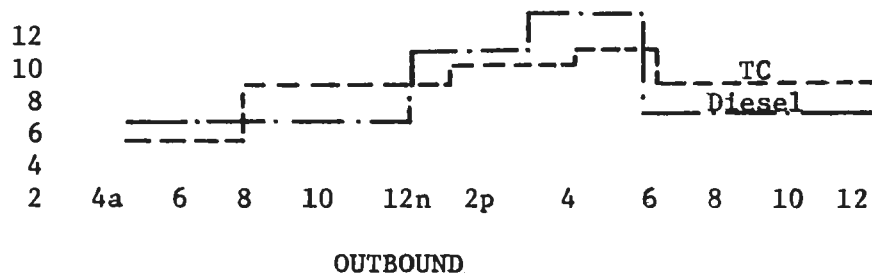

Schedule Dates:
 TC - 6/1/76
 Diesel - 2/23/78

Equipment:
 TC - Twin Coach/Pullman
 1943/1944
 Diesel - GMC T8N5305
 1969

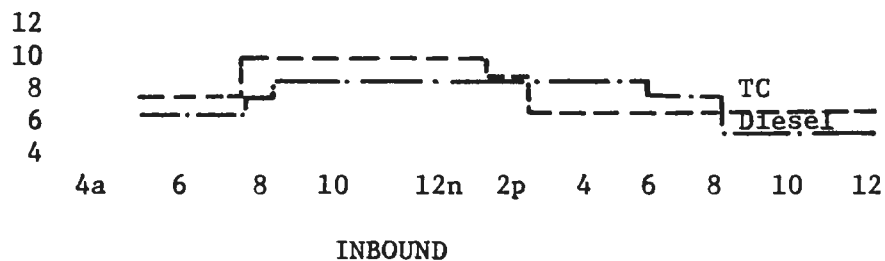

Terrain: Severe grades in the outbound direction on Queen Anne Hill. Remainder of route has average grades and level operation.

Route 1

Between 10th and Fulton and First and Denny

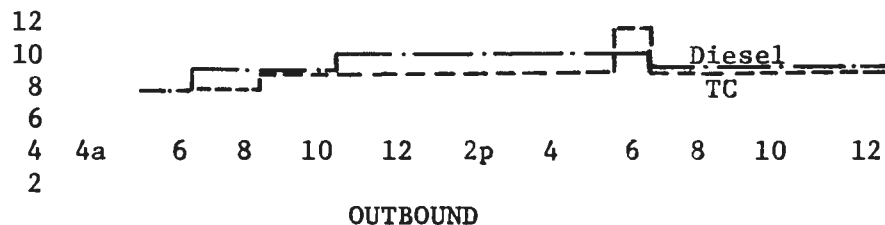

Schedule Dates: Same
 Equipment: Same
 Terrain: Average grades and level operation.

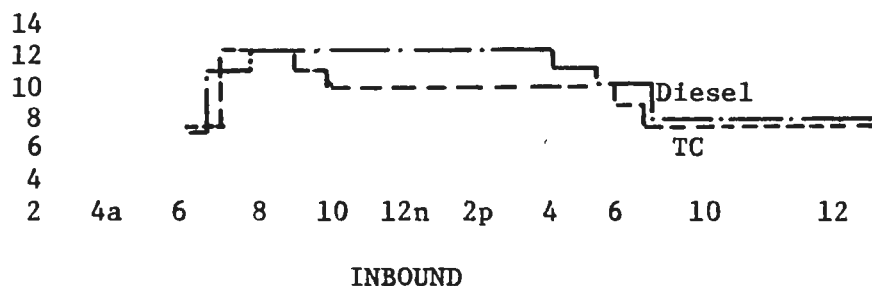

The variances in running time, generally one or two minutes, fall well within scheduled layover times, which range between 5 and 13 minutes. In this particular situation, had the variances favored either trolley coaches or motor coaches, there would have been no need to alter headways or change total vehicle requirements. It is also likely that these small variances would not be perceptible to the traveling public.

San Francisco - The MUNI schedule department does not differentiate between TC's and motor coaches on a performance basis. To verify this statement, several route segments were compared. Examples of these comparisons are shown in Figure 1.3-4. The comparisons between routes 31 (motor coach) and 5 (TC) would favor the motor coach. These routes operate on separate streets in the same corridor, and both encounter similar street conditions. Operationally, route 31 accommodates about 10,250 daily riders and route 5 about 12,000. Some of this difference relates to the shorter length of route 31. The number of weekday bus trips are 142 and 168, respectively. Another comparison utilizing a Sutter Street segment shows a clear preference for the trolley coach. Additional segments could be shown but no overall preference is indicated.

Conclusions

A review of TC and motor coach performance data leads one to conclude that the former is a superior vehicle provided top speeds do not exceed 40 mph/64 kph. The determinants of overall speed on a typical urban transit route include factors other than propulsion system performance. Speed also depends on:

- o Traffic volumes
- o Incidence of traffic signals
- o Cycle time for traffic signals
- o Turning movements
- o Incidence of double parking
- o Street geometry
- o Dwell time

These factors often predominate and overwhelm the TC's slight performance advantage. The SEPTA study previously cited concluded that one additional vehicle would be required if motor coaches replaced its TC's. Edmonton and San Francisco, on the other hand, have concluded that the two vehicles are interchangeable.

Another factor that affects only TC performance is the overhead system. Special work at intersections limits both speed and acceleration. The effect on performance will be significant if switches and crossovers are frequently encountered.

When TC's and motor coaches are compared for typical urban route applications, they can be considered to have identical performance and treated as interchangeable. The error of such an assumption, if one exists at all, will be small. In Philadelphia the error would have been one vehicle in a fleet of 110 or 0.9 percent.

Figure 1.3-4

Comparison of Running Times in San Francisco

Routes 5 (TC) and 31 (Diesel) between 25th and Divisadero on separate streets - two or three blocks apart.

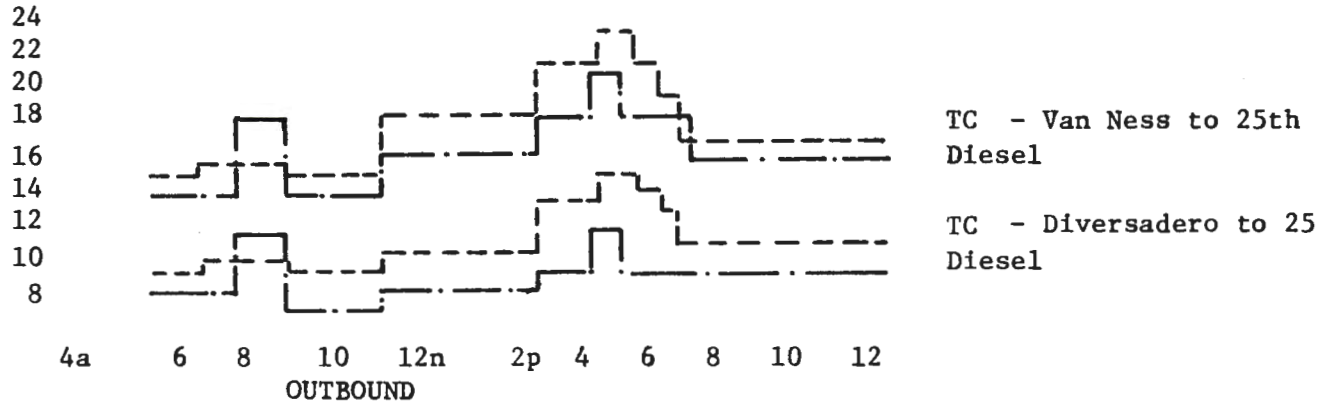
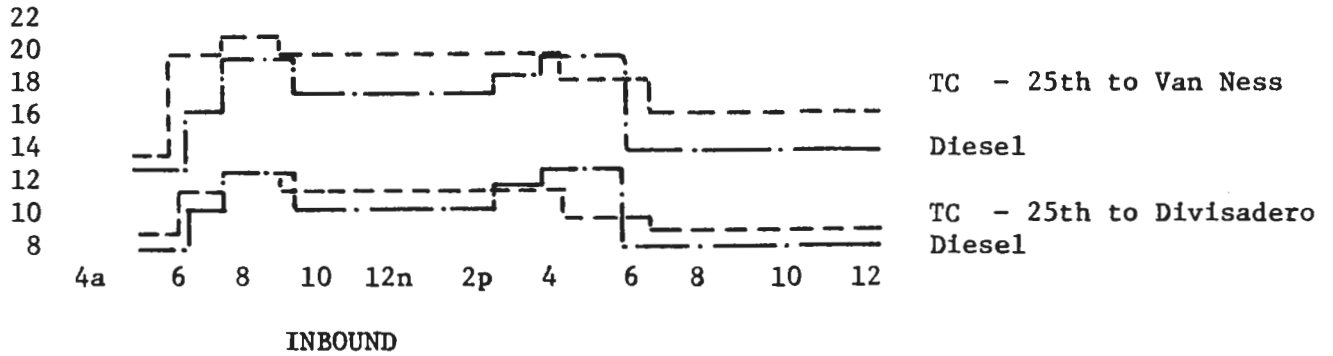

Schedule Dates: TC and Diesel - Those in effect on August 1978.

Equipment:

TC : E800, Flyer

Diesel: GMC T8N5305

Terrain: Average grades of long duration.

Routes 1 and 3 (TC) and 45 (Diesel) between Sanson and Park on Sutter Street

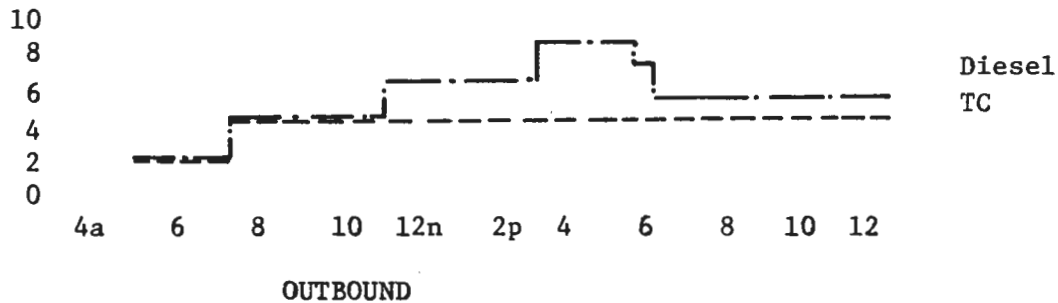

Schedule Dates: Same

Equipment: Same

Terrain: Level and slight grades.

Reliability

Reliability is a measure of vehicle performance and can be gauged in several ways. First, what is a fleet's availability for revenue service? Reliability increases with improved fleet availability. Second, what is the failure rate while in service? Reliability increases as the rate of service failure decreases. TC systems add another dimension to service failure. Interruptions and delays can occur due to power outages, shorted feeder circuits, broken wire and so forth.

Availability

BC Hydro's monthly mileage report for its fleet of 29 year old TC's indicated that during the month of November, 1978, all vehicles had seen revenue service. The average monthly mileage was 2610. Assuming that all vehicles which operated in excess of 2500 miles were fully available when needed, Table 1.3-2 indicates the fleet's availability. (The complete mileage distribution is shown in Table 1.4-2.) Unfortunately, the characteristics of BC Hydro's motor coach fleet, e.g., fleet age, service assignment and fleet size, do not allow for comparison.

Table 1.3-2

TC Availability *

<u>MILES OPERATED</u>	<u>NUMBER OF VEHICLES</u>	<u>PERCENT AVAILABLE</u>
2500 and over	167	100%
2000 to 2499	58	90%
1500 to 1999	18	70%
1000 to 1499	5	50%
500 to 999	2	30%
0 to 499	1	10%
<hr/>		
TOTAL	251	89%
<hr/>		

* Reference 6

Service Failure

Vehicle service failure records were reviewed for both BC Hydro and MUNI. Tables 1.3-3 and 1.3-4 indicate the failure rates associated with both trolley coaches and motor coaches on these two systems. Comparisons should be limited to TC's and motor coaches of the same system. Comparisons between operators are not valid because of differences in recordkeeping and maintenance standards.

Table 1.3-3

Trolley Coach Service Failures *

<u>Vehicle Problems</u>	<u>Miles Between Occurrences</u>		<u>Minutes of Service Delay per Service Failure</u>
	<u>San Francisco</u>	<u>Vancouver</u>	<u>San Francisco</u>
Doors	16640	44500	4
Current Collection System	3450	13700	23
Dead Coach	12200	14800	30
Brake System	15250	6400	8
Propulsion System	12200	59300	14
Steering	61000	0	3
Air System	45700	25400	34
Hot Body	47750	0	28
Misc.	30500	14800	9
TOTAL	1450	2250	19

* References 7 and 8

Table 1.3-4

Motor Coach Service Failures *

<u>Vehicle Problems</u>	<u>Miles Between Occurrences</u>		<u>Minutes of Service Delay per Service Failure</u>
	<u>San Francisco</u>	<u>Vancouver</u>	<u>San Francisco</u>
Transmission	11200	12500	17
Battery	8300	0	29
Doors	13500	20000	9
Stalled Coach	65200		26
Hot Engine	9300	33000	34
Brake System	4800	7700	10
Low Oil	35500	-	33
Air System	27900	33300	13
Fuel	78200	-	55
Turn Signal	65200	-	4
Low/No Power	23000	-	16
Misc.	13000	8300	17
TOTAL	1200	2080	19

* References 7 and 8

The comparisons are favorable to the TC even in the case of BC Hydro's 29 year old vehicles. Although the average delay was the same for MUNI's TC's and motor coaches, both total delay time and delay time per revenue mile are less for the TC. The principal problem areas for the TC are:

- o Current Collector System - Faults generally occur as a result of dewirements which can bend poles, break ropes, cause retrievers to jam and allow the collector to get caught in the overhead.
- o Dead Coach - The propulsion is unresponsive and the coach is inoperable.
- o Propulsion System - The coach is operable but there are problems with low power, rough acceleration or sticking power pedal.
- o Brakes - The dynamic and/or air brakes need adjustment.

Trolley coach systems also have service failures which relate to the overhead lines and feeder systems. MUNI's failure rate for the same sample period is shown in Table 1.3-5. When this failure rate is added to that for vehicles the total failure rate is 1340 miles per occurrence, but this figure can be misleading. Vehicle failures generally affect only one vehicle while a non-vehicle failure has the potential of impacting an entire line. A blocked vehicle will cause following coaches to accumulate until the blockage is removed. The inability to react quickly will tie up the entire line. Open feeder circuits, which do not automatically close, will tie up service until the fault is removed or motor coach service is substituted.

Table 1.3-5

Non-Vehicular TC Service Failures *

<u>Failure</u>	<u>Miles/Km. Between Occurrences</u>
Blocked due to a lack of maneuverability	91,500/147,200
Out from wire	49,750/80,050
Wire down	45,750/73,600
Open feeder circuit requiring motor coach substitution	(A)

* Reference 7

(A) The sample period was too small to determine the actual failure rate for open circuits.

Failures of this type point out one of the weaknesses of a TC system. Unfortunately, the ability to minimize these failures is only partially controllable. Traffic accidents and other occurrences are always potential sources of blockage. The overhead wire system is continually subjected to damage by vehicular traffic which collides with support poles or directly damages the overhead.

Vehicle Requirements and Capacity

Vehicle Requirements

The number of vehicles required to provide service for the same number of passengers on one or more routes may differ for different vehicle types for several reasons. Among these are:

- o Vehicle size may be different,
- o Vehicles may have different performance characteristics thus requiring more or fewer vehicles to maintain the same frequency of service.
- o Spare ratios may differ.

At the present time, there is no difference in vehicle size between trolley coaches and motor coaches. Currently available vehicles utilize the same 40 feet/12.2 meter body, the largest single unit vehicle that is permitted in most states. During the 1930-1950 period, the average trolley coach was larger than the average motor coach, although the largest available vehicles of each type were of similar size.

It is possible, in the future, that the trolley coach may have a slight size advantage. If sufficient demand exists for a low floor trolley coach to be produced that does not utilize the same body as a low floor motor coach, then the trolley coach could be designed with more usable passenger area and less interior space being devoted to propulsion equipment. This potential design difference results from the greater flexibility in locating propulsion equipment than is possible in a motor coach. This advantage would probably be less than 5% of total vehicle capacity, and could most likely be ignored in most situations. It should be noted that similar considerations apply to the current and future designs of articulated trolley coaches as well as to single unit vehicles.

The discussion of vehicle performance has indicated that there is little difference between the performance of trolley and motor coaches. The differences that exist are within the level of variation that is normally to be expected in a street transit operation, and thus may safely be ignored.

One difference between trolley and motor coaches that has existed in the past is that trolley coaches were claimed to have shorter dwell times at stops due to having wider doors. Current design trolley and motor coaches have identical door configurations; single width front and center doors, with double width center doors being optionally available.

SEPTA studied the loading efficiency of various door configurations and concluded that the single width front door, double width center door configuration was 60% more efficient than the single width front and center doors usually employed on motor coaches. The double width front, single width center door used on most trolley coaches built before 1951 was only 20% more efficient. However, the time savings measured in this study amounted to only 0.3 seconds per mile or 3 seconds on a ten mile route, which is again well within normal schedule variability. However, systems that use central area fare free zones or off vehicle fare collection may experience greater time savings from the use of wide doors. The two transit systems that use the wide center door option on both trolley and motor coaches, Boston and Toronto, both have numerous rail rapid transit interchange points at which fares are not collected. It must be emphasized again that door configurations are not currently an advantage for either vehicle type, as identical arrangements are available for both.

The analysis of maintenance requirements and procedures indicates that trolley coaches may have a slightly lower maintenance reserve requirement than do motor coaches. Information on actual operating practices is difficult to obtain, as most transit systems have an active fleet that is larger than is required for scheduled service and a maintenance reserve. The excess is typically at least 15% over the scheduled fleet. This includes the maintenance reserve, vehicles used for charter service and reserve equipment held to cover short term increases in usage or to maintain service in the event of a major disruption such as a garage fire. However, examples of systems operating with the minimum fleet size necessary for maintenance include Vancouver in 1973, with a 6.9% reserve for trolley coaches, and Chicago in 1975, with a 9.2% reserve for motor coaches. The SEPTA study indicated that an 8% maintenance reserve was required for both vehicle types. The Vancouver experience implies that a 7% reserve is practical for trolley coaches. It should be noted that systems that operate trolley coaches will often maintain a larger than average motor coach reserve, as motor coaches can replace trolley coaches in emergencies, while the reverse cannot be done.

Capacity

Capacity of a trolley or motor coach route or facility is affected by two factors, vehicle capacity and vehicle throughput. Vehicle capacity as discussed above may be considered to be identical for the two vehicle types. Maximum vehicle throughput, however, does differ for trolley and motor coaches. This is a result of the obvious inability of trolley coaches to pass each other when operating on a single wire. A similar condition occurs when either trolley or motor coaches are operated through single lane streets or other facilities where there is insufficient lane width for passing. Two such situations are the Granville Street Mall in Vancouver and the Harvard Square underground station in Boston. Eighty-three vehicles per hour on seven routes are scheduled to use the Granville Street Mall in the peak direction. The Harvard Square station has 74 vehicles per hour on five routes scheduled in the peak direction. This includes some empty vehicles. Both locations have a mix of trolley

and motor coaches. The capacity of this type of facility is a function of both the number of vehicles and the number of routes, so that it is difficult to specify a maximum level. However, it is likely that a location on a grade separated facility unaffected by adjacent intersections could accommodate a greater number of vehicles. Up to 120 trolley or motor coaches per hour could be accommodated under these conditions without excessive delays caused by queuing, given a relatively even flow of vehicles.

Motor coach volumes on the order of 120 per hour have been observed on surface streets. In these situations, bus stops for different routes are staggered and vehicles are free to pass each other. Similar volumes may be achieved with trolley coaches by the use of two sets of wires and loading islands to serve the center set. By staggering the curb stops and loading islands, and cutting back the sidewalk at the islands, overall street width required could be kept the same as for motor coaches with two sets of curb stops. In fact, since there would be no interference between vehicles operating in the two lanes, capacity should be equal to twice the single lane configuration described above, or at least 160 vehicles per hour.

Articulated vehicles will tend to have a slightly lower throughput. This is a result of the greater time needed for a vehicle to clear the stop location due to its greater length. It is unlikely that a difference of more than 10% would occur, although this figure would have to be verified by field observation. However, the effect of a 10% loss in vehicle throughput is to lower the increase in passenger capacity from 50% to 35% greater than obtainable with single unit vehicles.

Air Pollution Characteristics

The air pollution characteristics of the trolley coaches and diesel powered motor coaches are highly dissimilar. Motor coach emissions are essentially line sources following transit routes. Emissions reflect pollutants from diesel fuel combustion--primarily carbon monoxide, nitrogen oxides, and hydrocarbons.

Trolley coach emissions are point sources concentrated at the electric generating station. The emission characteristics depend on the type of fuel used at the generating station and on the degree of source control. If the process is fossil-fueled, primary pollutants are particulates, sulfur oxides, and nitrogen oxides. If the generating process is nuclear or hydroelectric, emissions are negligible; however, other environmental impacts such as thermal pollution are present and perceived dangers of nuclear accidents may exist.

The U.S. Environmental Protection Agency (EPA) has published "city bus emission" factors for motor coaches. The factors, which apply to an average speed of 18 mph/29 kmph, are presented below. EPA has also developed "speed correction factors" for carbon monoxide, hydrocarbons, and nitrogen oxides. Included in the table are emission rates at 10 mph/1.6 kmph, which may be more typical of city bus operating speeds.

Table 1.3-6

Urban Motor Coach Emissions *

<u>Pollutant</u>	<u>Grams/mile (Grams/kilometer)</u>	
	<u>18 mph (29 kmph)</u>	<u>10 mph (16 kmph)</u>
Exhaust particulates	1.3 (0.8)	--
Sulfur oxides	2.8 (1.7)	--
Carbon monoxide	21.3 (13.2)	22.6 (14.0)
Hydrocarbons	4.0 (2.5)	4.7 (2.9)
Nitrogen oxides	21.5 (13.4)	24.3 (15.1)

* Reference 9

Following is a summary of electric trolley coach emissions, which was derived from various sources.

Table 1.3-7

Trolley Coach Emissions

<u>Pollutant</u>	<u>grams/mile (grams/kilometer) (A)</u>			
	<u>Steam Turbines</u>			<u>Nuclear, Hydro Pump Storage (1)</u>
	<u>Oil-Fired (1)</u>	<u>Coal-Fired (1)</u>	<u>Gas (2)</u>	
Particulates	1.0 (0.6)	1.0 (0.6)	0.13 (0.1)	0
Sulfur oxides	9.5 (6) (B)	24.4 (15.2) (C)	.008 (0)	0
Carbon monoxide	0.3 (0.2)	0.5 (0.3)	0.22 (0.14)	0
Hydrocarbons	0.2 (0.1)	0.2 (0.1)	0.013 (0.01)	0
Nitrogen oxides	10.3 (6.4)	9.4 (5.8)	9.1 (5.7)	0

(1) Reference 2.

(2) Reference 9 and discussions with M. Trykoski, Edison Electric Institute.

(A) Assuming 3 KWH/mile (1.0 KWH/kilometer) with chopper installation. Observed power consumption typically varies between 3 KWH/mile and 4.5KWH/mile, (1.9 and 2.8 KWH/kilometer). At higher power consumption rates, these factors should be modified appropriately.

(B) 0.5% sulfur content assumed

(C) 2% sulfur content assumed.

The emission factors for the electric trolley coach can be made to reflect conditions in a particular region by developing a composite emission factor based on the source(s) of power generation in that region. In the absence of site specific information, the map in Figure 1.3-5 and Table 1.3-8 can be utilized to construct composite emission factors for the electric trolley coach in a particular region.

Another study, which takes into account the relative toxicity of various pollutants, computes total relative toxicities as follows:

Table 1.3-8

Relative Toxicity of Air Pollutants *

Diesel bus	1.55
Electric trolley coach	
oil-fired	0.48
coal-fired	0.82

* Reference 10

It is thus apparent that the air pollution characteristics of the trolley coach are generally superior to those of the motor coach. The trolley coach is significantly cleaner for all pollutants except sulfur oxides. On a national basis, violations of ambient air quality standards for sulfur oxides are relatively uncommon, while other standards are violated very often. Further, electric generating facilities are often located in remote areas where population exposure is low. The pollution-generation of motor coaches is normally greatest in areas of high population concentration.

It should be noted that motor coaches typically contribute a very small percentage (on the order of one percent) of the total regional emissions of carbon monoxide, hydrocarbons, and nitrogen oxides. Thus, although the trolley coach is considerably cleaner, the impact of even wholesale replacement of a motor coach fleet with TC's would be negligible on a regional basis. At isolated pollution hot spots, there may be a small but perceptible impact.







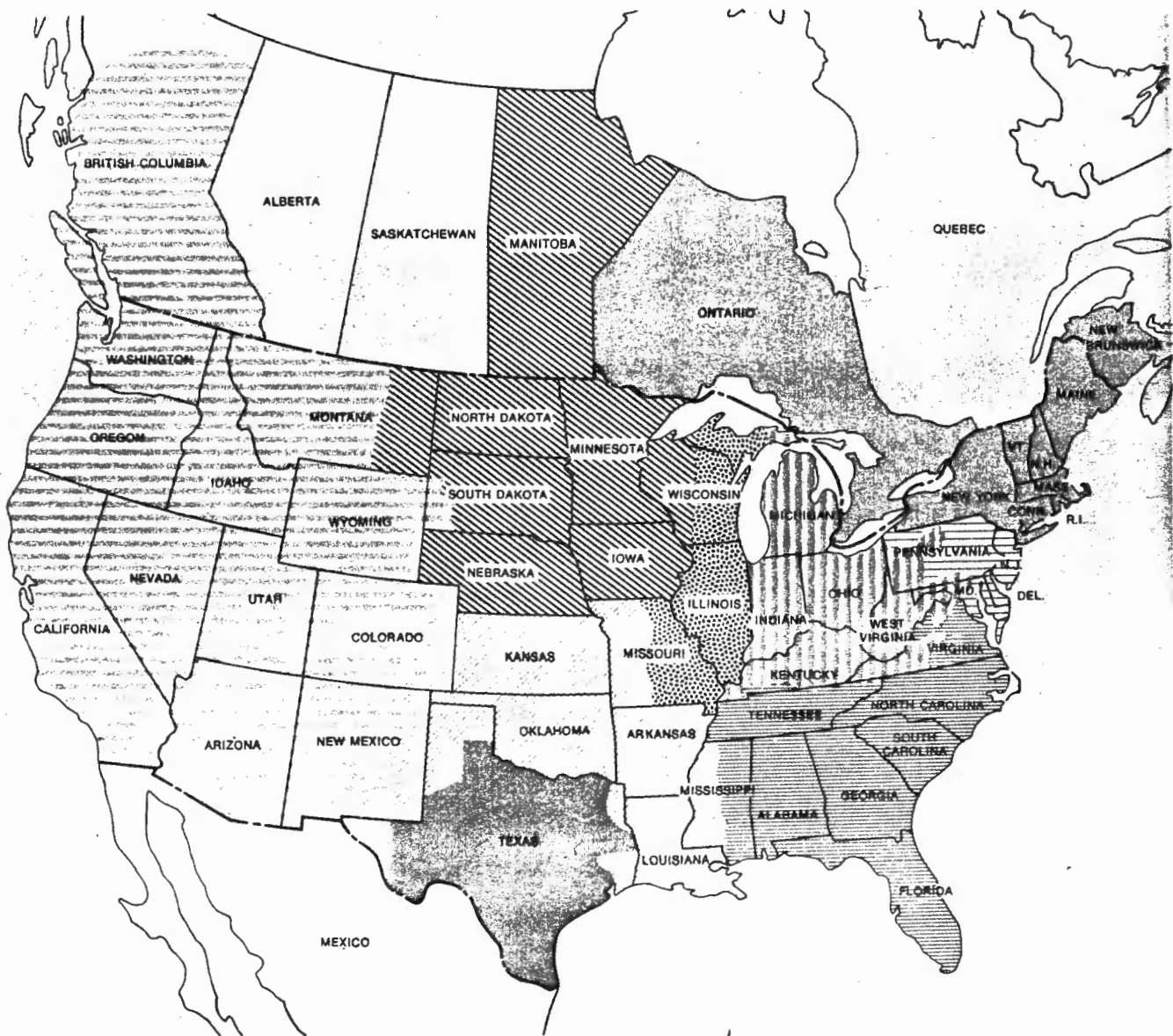

Noise Characteristics

Several studies have been performed of the comparative noise pollution levels of the diesel powered motor coach and the TC. A study performed by the Southeastern Pennsylvania Transportation Authority reported sound measurements as follows:

Figure 1.3-5

North American Reliability Council Districts *



- | | | | | | |
|---|--|---|--|--|---|
|  | ECAR East Central Area Reliability Coordination Agreement |  | MAIN Mid-America Interpool Network |  | SERC Southeastern Electric Reliability Council |
|  | ERCOT Electric Reliability Council of Texas |  | MARCA Mid-Continent Area Reliability Coordination Agreement |  | SPP Southwest Power Pool |
|  | MAAC Mid-Atlantic Area Council |  | NPCC Northeast Power Coordinating Council |  | WSCC Western Systems Coordinating Council |

* Reference 11

Table 1.3-9

Power Generation Fuel Source in the Various Reliability Districts *

	Steam Turbines			Combustion Turbine	Combined Cycle	Nuclear	Hydro	Pump Storage	Other (a)	Total
	Coal	Oil	Gas							
<u>1976 TOTAL - MW (ACTUAL)</u>										
ECAR	62,620	4,402	92	3,495	568	2,187	550	2,697	0	76,661
ERCOT	2,360	0	30,013	1,011	715	0	318	0	0	34,417
MAAC	14,057	12,985	0	7,941	120	4,298	941	1,286	50	41,678
MAIN	26,014	1,893	95	3,290	0	6,564	573	924	0	39,353
MARCA	9,964	628	235	2,492	72	3,719	3,086	0	0	20,196
NPCC	3,737	24,843	54	5,220	0	7,686	5,237	2,631	0	49,408
SERC	51,936	16,133	640	10,402	348	10,647	8,945	660	7	98,718
SPP	5,084	8,067	23,504	2,068	873	836	2,283	260	59	48,034
WSCC	15,564	23,886	2,121	4,497	846	3,383(b)	37,523	1,411	765	89,996
NERC	191,336	92,837	56,754	40,416	3,542	39,320	59,456	9,869	881	494,461
<u>1986 TOTAL - MW</u>										
ECAR	88,101	5,696	92	3,560	560	15,925	590	3,797	1,000	119,325
ERCOT	18,999	5,700	22,927	1,011	715	6,000	350	0	0	55,702
MAAC	16,989	14,845	0	8,717	246	19,235	957	1,286	400	62,675
MAIN	37,297	3,878	78	6,027	0	17,294	573	612	420	66,179
MARCA	21,422	572	161	3,087	176	7,106	2,732	0	0	35,256
NPCC	5,337	26,395	54	5,435	419	16,633	5,329	3,631	32	63,265
SERC	74,574	18,770	135	11,202	1,178	49,677	10,655	4,823	770	171,784
SPP	30,384	12,081	17,601	5,254	1,223	9,888	2,580	260	377	79,648
WSCC	32,978	23,539	2,011	5,864	6,351	22,021	43,870	4,012	2,935	143,581
NERC	326,081	111,476	43,059	50,157	10,876	163,779	67,636	18,421	5,934	797,415

(a) Includes diesel, geothermal, and undesignated fuel type.

(b) Includes Hanford (850 MW). Hanford is not considered firm for peaking and is not included in the projected capability data for 1981 and 1986.

* Reference 11

Table 1.3-10

Sound Intensity Above Ambient *

<u>Condition</u>	<u>Distance</u>	<u>Motor Coach</u>	<u>Trolley Coach</u>
Driveby, full speed	50 ft. (15 m.)	12-16 dBA	0
Standing start	15 ft. (4.6 m.)	18-25 dBA	0
Idle	15 ft. (4.6 m.)	4-8 dBA	0

* Reference 12

These results are significant in that they indicate that the sound made by the trolley coaches tested was not discernable over the prevailing ambient noise levels.

Measurements made by the San Francisco Department of Public Health indicated peak noise levels from 74 to 92 dB for motor coaches and from 69 to 84 dB for TC's. Elsewhere, it was reported that tests made in Seattle found average sound levels of 65 dB and 94-95dB for trolley coaches and diesel coaches, respectively. Tri-Met's trolley coach study (Reference 2) includes Figure 1.3-6, which describes noise ranges of the trolley coach and the motor coach.

It is thus apparent that the noise generated by the trolley coach is significantly less than that of the motor coach. The decibel scale, which is used to measure sound levels, is logarithmic. A three dB increase represents an approximate doubling in the level of sound pressure. Ten dB represents a tenfold difference in sound pressure level, but is perceived by the human auditory system as being twice as loud. The substitution of the trolley coach for the motor coach could result in noticeably quieter streets, particularly where bus noise is a major component of the noise. On streets with significant truck traffic or characterized by high speed traffic, the positive benefit of the trolley coach will be much less perceptible.

It should be noted that the U.S. EPA has proposed new noise emission standards for coaches. These standards would limit exterior coach noise to 83 dBA in 1979, 80 dBA in 1983 and 77 dBA in 1985. The standards were proposed in September 1977 and have not yet been adopted. If these standards are adopted and complied with, the noise pollution advantage of the TC will be substantially reduced. However, the cost of meeting noise standards for motor coaches could change the initial and operating cost differentials between the two vehicle types.

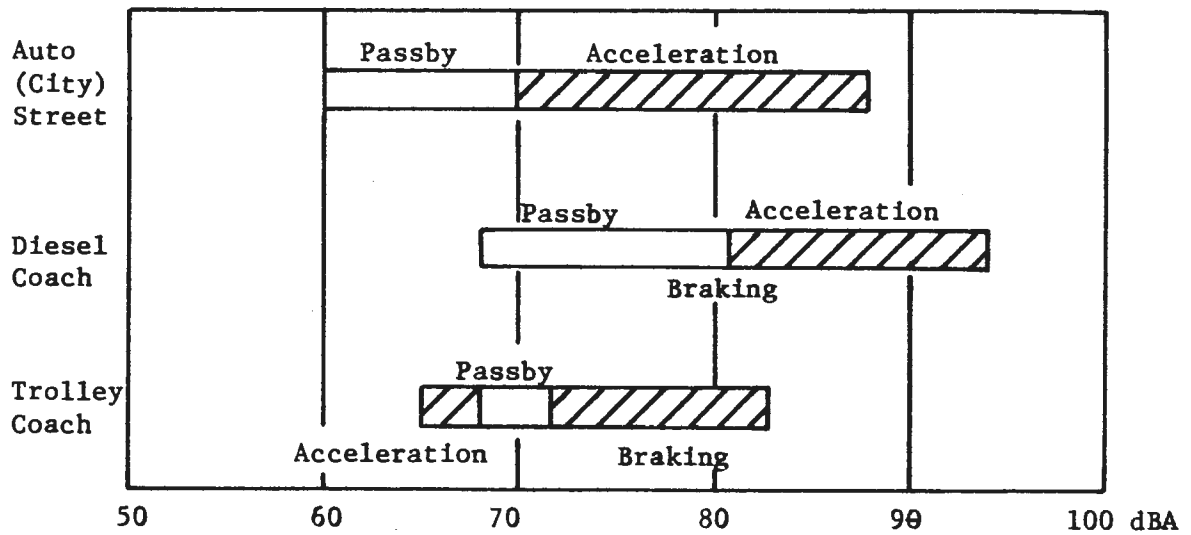

Vehicular noise (in dBA) at 50 feet/15 meters from source.

* Reference 2

Figure 1.3-6

Vehicular Noise Ranges *

Energy Characteristics

Energy requirements are a function of several factors particular to a given system. Notably, terrain, relative magnitude of express vs. local service, and traffic conditions can be expected to impact on energy intensiveness. Following is a sample of reported energy consumption rates for motor coaches and trolley coaches.

Table 1.3-11

Reported Fuel and Power Consumption

<u>Location</u>	Motor Coach	Trolley Coach	
	<u>mpg</u>	<u>KWH/mile</u>	<u>equiv. mpg (c)</u>
Albany, NY (1)	4.6	--	--
Chicago, IL (1)	3.3	--	--
Dayton, OH (1)	4.3	3.6 (a)	3.86
Denver, CO (1)	4.6	--	--
Edmonton, AL (5)	4.9	4.5 (a)	3.08
Little Rock, AR (1)	4.8	--	--
Milwaukee, WI (1)	4.7	--	--
Philadelphia, PA (2)	2.8	1.9 (b)	7.3
Providence, RI (1)	5.2	--	--
San Francisco, CA (3)	2.8	3.69 Old Coaches	3.76
		4.46 New Coaches	3.13
		3.12 with chopper	4.47
		4.25 w/o chopper	3.27
Vancouver, BC (4)	5.3	3.3 with chopper	4.21

Sources:

- (1) Reference 13
- (2) Reference 12
- (3) Reference 10
- (4) British Columbia Hydro and Power Authority, Personal communication.
- (5) Reference 14

- (a) Based on consumption at substation - includes line loss.
- (b) Metered onboard - does not include line loss.
- (c) Assuming 1 KWH requires .072 gallons of low sulfur fuel.

The reference cited for San Francisco reports an interesting comparison. It is reported that one KWH of electric power requires .072 gallons of low sulfur fuel, which is virtually the same as diesel fuel. This report indicates that the fuel used to generate electricity (at 4.45 KWH/mile) is equivalent to a fuel consumption rate of 3.13 miles per gallon, which is 11 percent better than the 2.8 miles per gallon reported for San Francisco's diesel bus fleet. Further, with the new generation of electric trolley coaches with chopper control, power consumption is approximately 3.12 KWH per mile, equivalent to 4.47 miles per gallon (58 percent better than the diesel fleet). It is worth noting the the steep terrain of San Francisco results in diesel fuel consumption rates greater than most areas.

The 4.47 miles per gallon expected for new generation trolley coaches with chopper control is better than diesel buses in San Francisco. For other cities the reverse appears to be true. It would thus appear that for oil-fired electric generating equipment the energy balance is slightly in favor of the diesel bus in flat or moderate terrain. In hilly terrain, the fuel balance may shift to the trolley coach.

In regions where the preponderance of electric energy generation comes from fuels other than oil, it is expected that the TC would be the preferred mode from an energy conservation viewpoint.

A distinct advantage of the electric trolley coach is that its power can be derived from a variety of sources. While the diesel bus must run on diesel fuel, electricity can be generated from oil, coal, natural gas, hydro, nuclear and more exotic sources.

REFERENCES

CHAPTER 1.3

1. "600 Volt Propulsion System for Electric Trolley Coaches," General Electric, Erie, Pennsylvania, June 1976.
2. Trolley Bus Evaluation Study - Tri-County Metropolitan Transportation District, DeLeuw, Cather & Company, San Francisco, California, March 1976.
3. A New Way to Go Electrically with Trolley Buses from AM General, AM General Corporation, Wayne, Michigan.
4. "Operating Schedules," Municipal Railway of San Francisco, various dates.
5. "Operating Schedules," Municipality of Metropolitan Seattle, various dates.
6. "Monthly Mileage Reports," British Columbia Hydro and Power Authority, November 1978.
7. "Central Control Daily Log," San Francisco Municipal Railway, June 1978.
8. "Summary of Pull-Ins," BC Hydro and Power Authority, July 1978.
9. Compilation of Air Pollutant Emission Factors, U.S. Environmental Protection Agency, Washington, D.C. , April 1977.
10. Environmental and Economic Feasibility of Trolley Coach Expansion, Carl Natvig, San Francisco Municipal Railway, July 1978.
11. 7th Annual Review of Overall Reliability and Adequacy of the North American Bulk Power Systems, National Electric Reliability Council, Washington, D.C., July 1977.
12. "Alternative Analysis - Trolley Bus vs. Diesel Bus," Southeastern Pennsylvania Transportation Authority, Philadelphia, Pennsylvania, March 1977.
13. Transit Operating Report - 1975, American Public Transit Association, Washington, D.C., 1975.
14. Study of Trolley Replacement Policy, Edmonton Transit System, 1977.

THIS PAGE LEFT BLANK INTENTIONALLY.

CHAPTER 1.4

INTEGRATION AND POTENTIAL FOR UPGRADING

Introduction

The problems of integrating trolley coaches into existing transit operations directly affect the system's transportation and maintenance departments. The effect on transportation departments is universal for those systems not currently operating TC's. The supervisory and driving staff must be fully acquainted with and trained to operate the new vehicle. The effect on maintenance departments will vary. The impact on systems with existing rail operations will be minimal since much of the required infrastructure is in place. Some amount of retraining will be required as jobs are transferred from motor coach to TC maintenance. Systems without any electrical operation are faced with both acquiring new capabilities and retraining existing staff.

Trolley coach service design follows most of the commonly employed tenets of network design and layout. Some of these guidelines have greater importance where TC's are concerned. For example, it is always desirable to have a garage location that minimizes off route operation. The penalty imposed in a motor coach operation is to increase operating costs. The TC imposes the additional penalty of increased capital cost for the additional overhead wire. TC service design also imposes new requirements. Sufficient flexibility must be incorporated into the network to allow for emergencies or occasional closure of certain key streets.

The trolley coach in North America is confined to operating on typical urban transit route networks. Although its potential for operation on mixed traffic expressways appears to be very limited, the TC can be considered for use on transitways over a wide range of usage. The TC appears to be most suitable for underground operation when such segments are too short for one route operation or usage is below the threshold for rail service.

Service Design

The discussion of service design presented here will deal with the conventional trolley coach as opposed to a vehicle with off wire capability, although most of the discussion is also applicable to systems using vehicles having limited off wire capability. Systems using vehicles with full off wire capability may be treated as being almost identical to motor coach systems based on the experience of the only extensive system of this type that ever existed - Public Service Coordinated Transport of New Jersey.

The basic factor that differentiates trolley coach service design from motor coach service design is the need for capital investment in the form of the overhead wire for all route mileage to be served. This includes, in addition to regular service routes, all emergency routes and garage connections. Express services may also require additional wire under certain circumstances. This subject is dealt with in a subsequent section. This requirement will affect systems in terms of route selection for trolley coach operation, route configuration, the treatment of branches and extensions, and garage location.

Given a group of transit routes having sufficient service density to justify trolley coach operation, the selection of routes to be operated with trolley coaches will depend upon the relationship of routes to each other and to existing or proposed garage locations. The goal of this selection is to minimize the amount of otherwise unused wire that is needed for garage movements and the amount of dead mileage and time needed for coaches to operate to or from their assigned routes.

Several route configurations can be used to accomplish these goals. Smaller systems, which consist of primarily radial routes and require only one garage, will generally have all routes connected in the central area, with the garage located near the center of the system as shown in Figure 1.4-1. Seattle is an example of this type of system.

Where a system is large enough to require multiple garages, or where the routes to be served fall predominantly in one direction from the central area, it is desirable to locate garages so that they are close to the outer ends of lines. Such a location permits dead time to occur between peak periods, rather than before and after the morning and evening peaks. As a result, total driver pay hours are reduced.

Most systems of this size consist of radial and circumferential or crosstown routes. These systems have generally included one or more crosstown routes in the trolley coach network, so that radial routes are connected both in the central area and at outlying locations. Garages are placed so that convenient access is available to the crosstown routes as shown in Figure 1.4-2. San Francisco and Vancouver are examples of this type of system.

The largest transit systems cannot be categorized as readily. However, in general, these systems have several garages, each serving routes in a portion of the overall service area. Such transit systems may have two or more disconnected trolley coach operations each having its own garage. Philadelphia and Toronto fall into this category. However, both of these cities have extensive electric railway operations, and an areawide system of electric power distribution. Trolley coach systems in Boston and Chicago formerly had similar characteristics. It should be noted that each subsystem in a large system must have the same degree of connectivity and the same relationship of routes to garages as in a single smaller system.

Figure 1.4-1

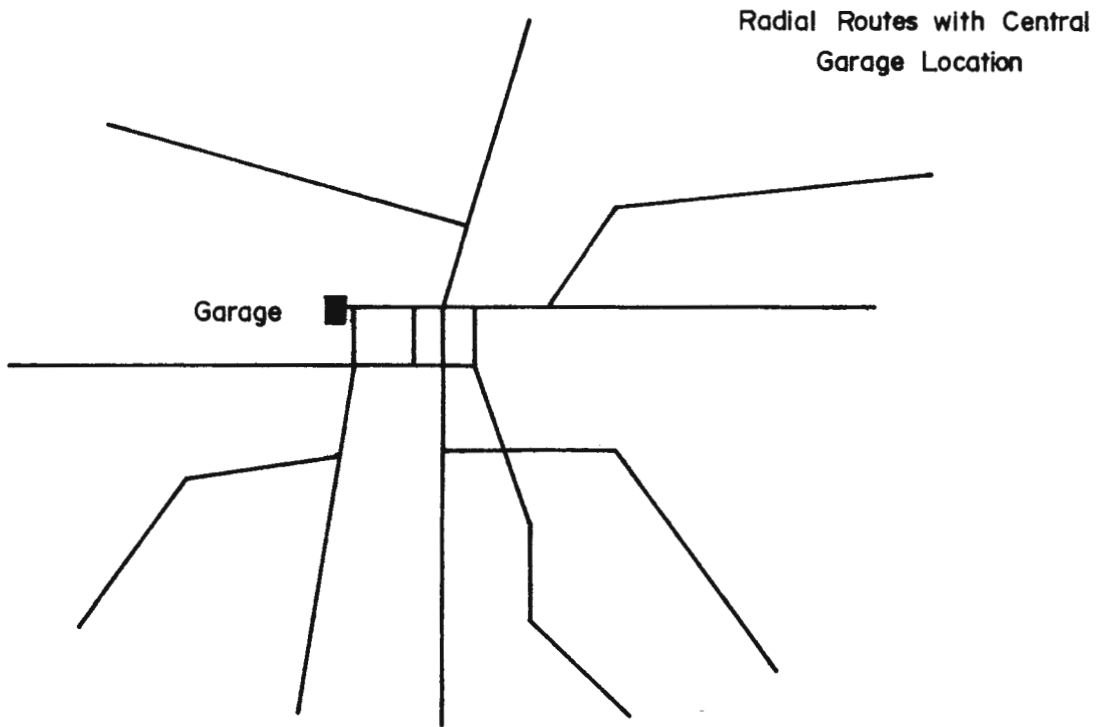
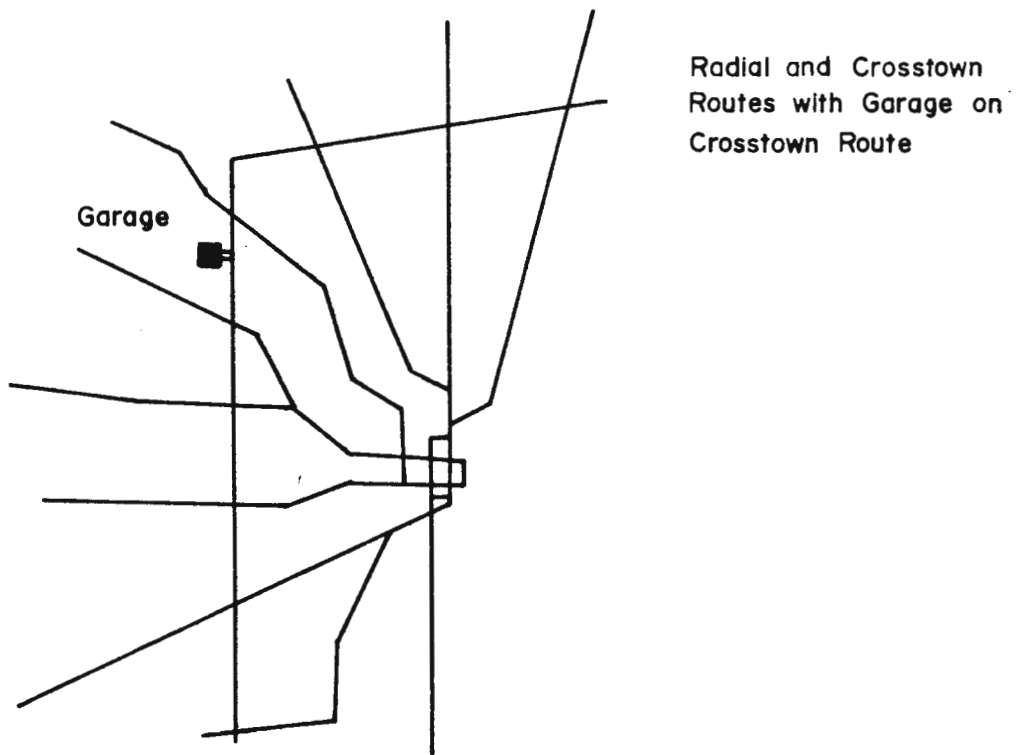

Figure 1.4-2



To some extent, the problem of excessive dead mileage to reach garages in a trolley coach system can be overcome by the use of remote storage lots. Since servicing requirements of TC's are fewer than those of motor buses, the provision of remote storage lots with minimal facilities is practical. Until very recently, an example was the North Cambridge location in Boston. This location had only a small office structure for driver reporting and for the use of the personnel assigned to vehicle cleaning. Recently the total garage function has been moved to this location due to the sale of the garage property located adjacent to Harvard Square.

The need for connectivity does not include the need to provide for wired access to the major overhaul facility. Several systems do not have such access for all or some of their trolley coach routes. Use of a tow truck has proved to be quite satisfactory for these operations. Most mechanical repair work on a trolley coach is performed on components that have been removed from the vehicle, so that the need to cycle vehicles through a major overhaul facility is limited to accident damage repair, repainting or other bodywork.

Route Configuration

The same constraint, the need to provide wire on all streets that may be used by a trolley coach, influences route configuration. It requires a different design approach toward branches and route extensions than is required for motor coach systems.

Where a branch is short relative to the total route, or has sufficient service density to warrant trolley coaches in its own right, it is practical to install wire. However, the most common situations are the suburban extension of a route, often with one or more branches, where the additional distance is high relative to the total route and the service density is low. Figure 1.4-3 shows a typical route configuration for a motor coach operation. The two most practical route configurations for trolley coach operation in this corridor are shown in Figures 1.4-4 and 1.4-5. Figure 1.4-4 shows a feeder bus operation, for the outlying area, with both local and express operations being provided by trolley coaches in the common or trunk portion. Figure 1.4-5 shows local service in the trunk portion being provided by trolley coaches, while the service to the outlying areas is provided by express motor coach routes.

These two configurations may be employed in any desired combination. For example, through express service may be provided only during peak hours, with feeder routes being operated during the off peak. Also, trolley coaches and motor coaches may be mixed on a route in local service, as is presently being done in Edmonton, due to a shortage of trolley coaches. However, this is likely to result in poor utilization of the investment in trolley coach overhead wire and equipment. Such an approach is most suited to the situation where the branch or route extension operates only a small number of trips during peak periods, and motor coach operation can be confined to one or two peak-only vehicles.

Figure 1.4-3

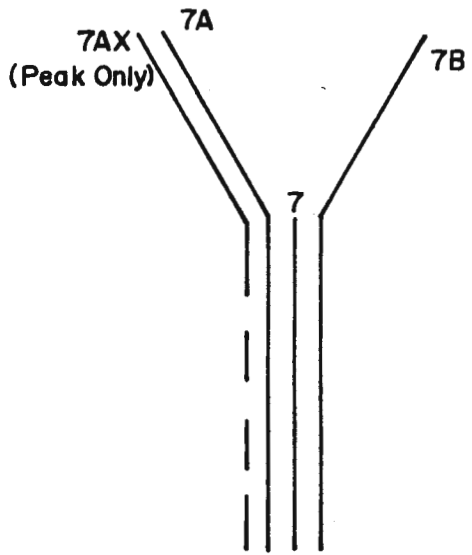

7, 7A, 7AX, 7B
Bus Route with Suburban
Extensions

Figure 1.4-4

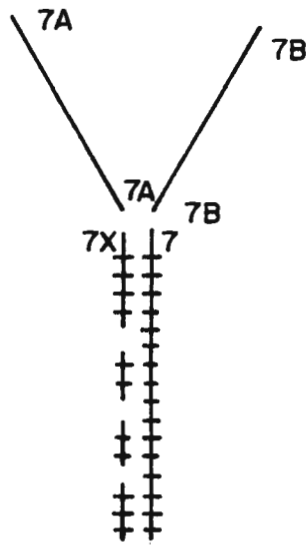

7, 7X
Local and Express Trolley
Coach with Feeder Bus Routes

Figure 1.4-5

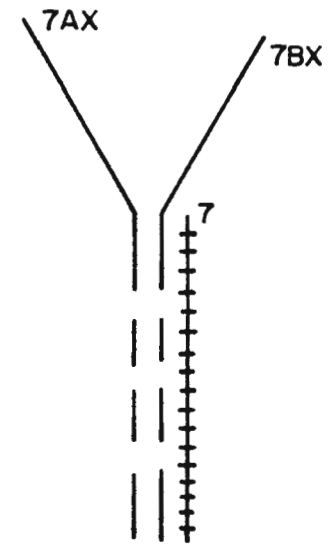

7, 7AX, 7BX
Local Trolley Coach and
Express Bus Routes

The route configurations described above each have advantages and disadvantages. The decision as to which configuration to employ is dependent on a number of factors. Among these are the extent of through travel between the outlying portions and the trunk portion of the routes and the intent of the system designer to maximize trolley coach usage. It should be noted that the use of motor coaches for peak-only express service may be desirable in that the cost of additional wire for express operation could be avoided. Also, trolley coaches can then be concentrated on high mileage full day assignments, thus making better use of vehicles having a higher initial cost but lower maintenance cost and a longer life.

Of the existing systems, Vancouver and Philadelphia operate express and local services on the same route with trolley coaches. Vancouver, Boston, San Francisco and Edmonton operate express services with motor coaches and local service with trolley coaches on the same route.

The location of the transfer point for a feeder operation may have a substantial impact on the success of such an operation. Edmonton has had considerable success in locating transfer points at suburban shopping centers, thus having the feeder routes serve the shopping center as well as feeding the trunk route.

Express Operation

Express service with trolley coaches on arterial streets is presently operated in Philadelphia and Vancouver, and was formerly operated in Atlanta, Akron, Kansas City and Indianapolis. Several schemes may be used to provide express service. The simplest, requiring no additional wire, is to schedule local and express trips in pairs, with an express vehicle starting immediately ahead of a local and not catching up to the previous local trip before the end of the express zone. This scheme will work where the difference between the express and local running times is less than the headway of each service. For example, if a five minute headway is operated with alternative local and express trips, then an express leaving one minute ahead of a local can have up to 8 minutes shorter running time before it catches up to the previous local. This scheme is not presently used in any North American trolley coach operation, although several rail systems schedule this type of operation.

By installing a short section of express wire at a passing zone, this scheme can be expanded so that an express vehicle can overtake one or more local trips without the expense of installing three or four sets of wires over an entire route. Figure 1.4-6 diagrams this type of operation. In the example of Figure 1.4-6, express operation is confined to the peak direction and a single, reversible wire segment is used for the passing zone. This approach is not currently used but was used in both Atlanta and Akron.

Both of these approaches require precise schedule adherence to function successfully and both are limited to express and local services having identical headways so that the sequence is maintained.

Figure I.4-6

Operation of Passing Section on a Trolley Coach Route

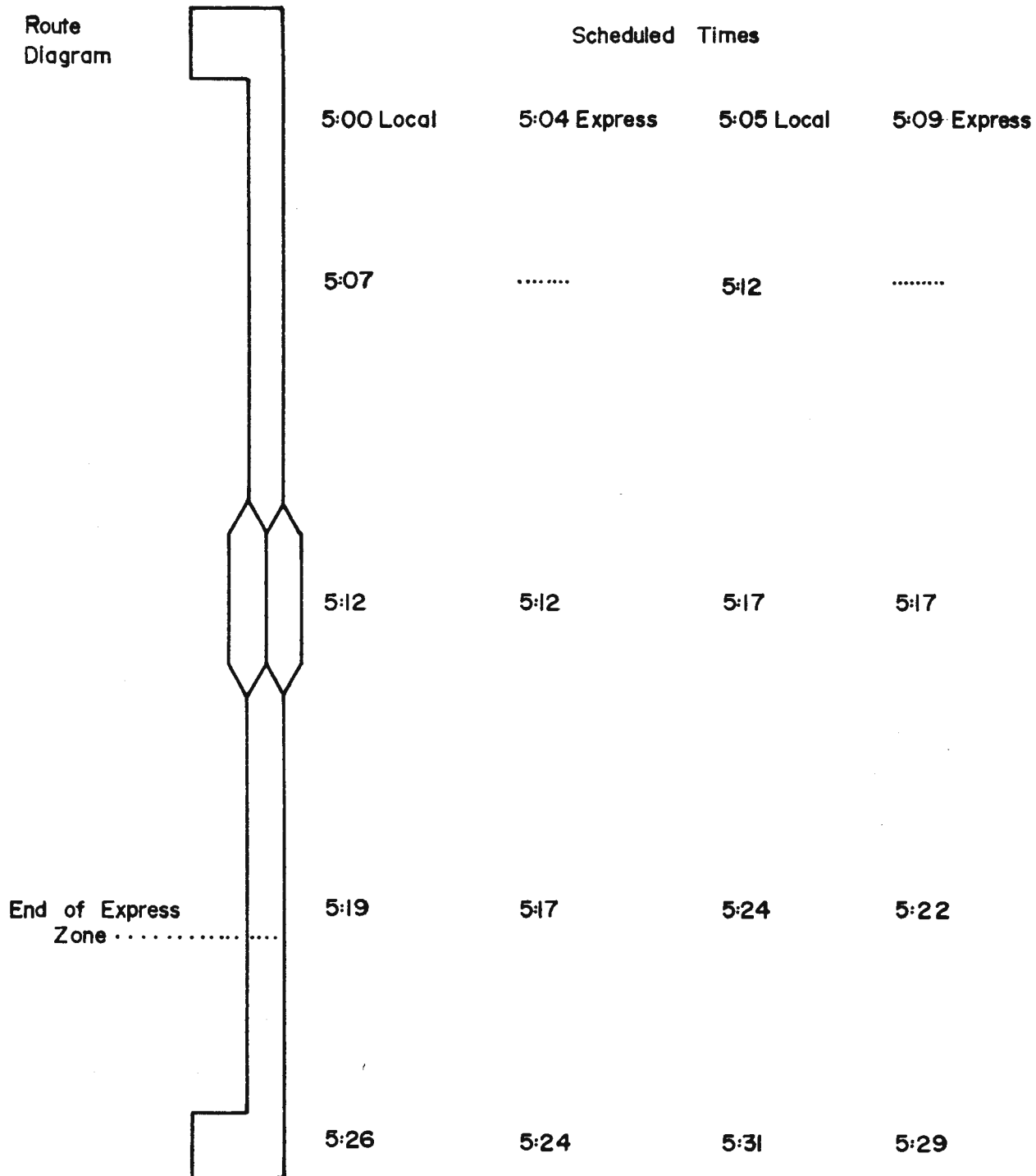

To obtain greater scheduling flexibility as well as to provide higher service frequency, separate express wire is required. This may be either a reversible center wire, as in Philadelphia, or separate wires for each direction, as in Vancouver. Although a single wire pair is less expensive to construct, street width or the desire for two-way express operation may require the installation of two pairs of wires.

Express operation on limited access highways in mixed traffic has never been attempted with trolley coaches. This is partially due to the fact that most trolley coach installations predated the construction of limited access highways. In addition, there appear to be severe feasibility problems that would restrict the use of trolley coaches on limited access highways. One limitation is the maximum speed of 40 mph/64 kmph that is the design standard for current trolley coaches. The maximum speed could be increased by changing to a lower gear ratio than the present 11.59 to 1. Milwaukee used a 9.23 to 1 gear ratio on its trolley coaches, which also used standard tires and the GE 1213 motor. This ratio should produce a top speed of 50 mph/80 kmph, although acceleration and the maximum grade capability may be reduced and power consumption increased.

Another even more severe problem is the inability of a trolley coach to weave through traffic at high speed, as would be necessary in many freeway applications. High speed movements away from the wire line are likely to result in dewirement. Establishing fixed lane change points where the wire changes position would be impractical for freeway operation.

An additional problem would occur if multiple routes were to use a freeway. Typically, the speed through a switch in the overhead wire is limited to 25 mph/58 kmph. Using the European wire systems, speeds of up to 36 mph/58 kmph through switches are possible. These speed restrictions, along with the somewhat greater tendency for dewirements to occur at switches, make switches impractical in freeway operation.

Finally, there is the problem of how to handle dewirements. Rewiring a trolley coach that is not directly under the wire requires that the driver or another person stand in a position behind the coach and almost directly under the wire. This procedure would be extremely hazardous on a heavily traveled freeway.

Because of these reasons, it appears that freeway operation of trolley coaches is limited to situations where a short section of freeway such as a bridge would be used as part of a route that is largely on surface streets. Entrance and exit from this section would both have to be on the same side of the highway. These would preferably be on the right hand or slow moving side. Operation would be restricted to the curb lane with the capability available for moving out one lane to pass a stalled vehicle at slow speed. No switches could be installed in this section. It is likely that such an operation would be most practical only where there are no intermediate entrances or exits between the entrance and exit used by trolley coaches.

System Flexibility

In developing a trolley coach system, the layout of the overhead wire network will generally include segments that are not used by regular routes or for garage movements, in order to maximize system flexibility under abnormal conditions. It is particularly desirable to have operating flexibility in central areas, where a street blockage may disable several routes. Operating flexibility is required not only to deal with emergencies, but also to handle such street traffic disruptions as parades and street repair work. It is also desirable to provide for locations where vehicles may turn around other than at ends of lines. These are used both to provide service over part of a line in the event of a disruption, and to provide for short turn operation. Short turn operation may either be regularly scheduled or may be used to put vehicles back on time in the event of a delay to service.

Figure 1.4-7 shows an example of additional wire that could be installed in a downtown area. The route structure shown in this figure includes a north-south main street with through routes on it and an east-west main street with two routes ending in the core, using two loops. Some redundancy is provided by the availability of both loops for the east-west routes. However, a blockage on either main street will stop a portion of the system.

In a first stage of providing additional flexibility, turns are provided between the north-south route and the outer legs of each loop indicated by A, while through movement across the main east-west street is provided as indicated by B. These segments permit all service to continue to operate if either or both main streets are blocked.

The second stage would be to provide short turn loops on the edge of the core area by means of installing wire at locations C, D and E. Finally, installing the two connections indicated by F would permit operation of the north-south routes even if the entire east portion of the core area is blocked.

Turnback locations can be installed by using around-the-block loops, as shown in the above example. Where usage is infrequent, a wye can be utilized. Wyes have the disadvantage of requiring the trolley coach to back up in traffic, but will be substantially less expensive to install. The Chicago system was the largest user of wyes for emergency turnarounds, and even had some at ends of lines.

In a complex system with many intersecting lines, the provision of emergency turn wire at intersections will add to flexibility. Such wire may be used to reroute vehicles on alternative streets. In some cases, the turns available at intersections will serve as a means for turning vehicles around without providing special facilities.

Figure I.4-7

Sample Downtown Area with Emergency and Turnback Wire

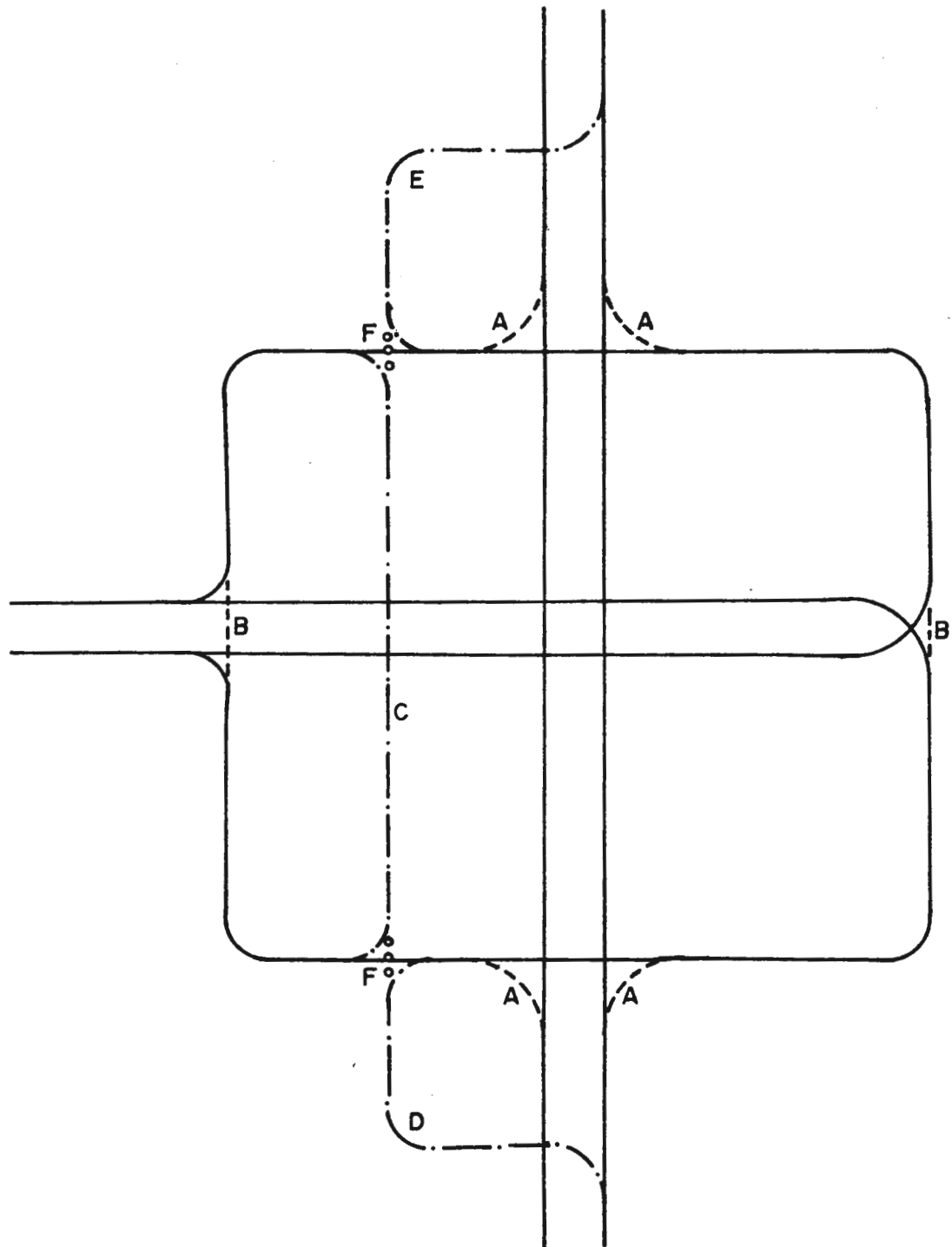

Operations and Maintenance

The TC will require a variety of changes in such key maintenance department functions as servicing, inspection, unit repair and major overhaul. The operator of existing electrified rail services can respond to these requirements fairly easily. Operators who now provide only motor coach services will have to acquire new capabilities but may not be bound by historical precedents with regard to staffing and work procedures. The transportation department is primarily faced with training a sufficient pool of drivers and supervisory staff to support operations.

Vehicle Maintenance

Maintenance activity associated with large vehicle fleets is normally accomplished at two locations, the vehicles' assigned garage and a main maintenance facility. All activity associated with small fleets is normally centralized at one location. The activities performed at garages include:

- o Servicing, which includes fueling, checking lubricants and cleaning.
- o Major and minor inspection of various vehicle subsystems on a mileage basis.
- o Minor repairs that can be performed in a short period of time.
- o Unit exchange which includes such items as engines, transmission and compressors.
- o Tire maintenance including changing and regrooving.
- o Battery maintenance including charging and replacement.
- o Brake maintenance including changing and adjustment.
- o Emergency repairs that are required when the vehicle is in revenue service.

Main maintenance facility functions include:

- o Major body work necessitated by accidents or a rebuilding program.
- o Chassis and suspension system repairs
- o Painting
- o Unit remanufacturing.

The trolley coach is very adaptable to this structure. Procedural modifications, training programs and the purchase of appropriate shop tools are required to support the TC, but the structure of the maintenance department will not be drastically altered.

The maintenance effort associated with TC's has invariably been less than that required for motor coaches of a similar age. This fact has been demonstrated in the past and was recently reaffirmed by a study conducted by SEPTA in Philadelphia (Reference 6). The cost of maintaining motor coaches was shown to exceed TC's by as much as 37 percent. This is principally due to the TC's propulsion system that has fewer moving

parts and the longer life associated with its major components. BC Hydro, for example, operates a fleet in which approximately 25 percent of the propulsion motors have accumulated in excess of 250,000 vehicle miles (400,000 km.). The discussion that follows deals with the major maintenance differences between the two vehicle types.

Servicing - TC servicing requirements are less since the need for fuel and lubricants does not exist. A complete discussion of this activity can be found in the next section.

Inspections - Inspection intervals vary among TC operations. Vancouver employs 2,000 mile (3,200 km.) minor and 6,000 mile (10,000 km.) major inspection intervals. Major and minor inspections in Philadelphia are performed at 3,000 mile (4,800 km.) and 6,000 mile (10,000 km.) intervals. Chicago chose longer periods and inspected its coaches every 12,000 miles (19,000 km.), although some items were checked at shorter intervals. Diesel inspections also vary, but the predominant interval is every 6,000 miles (10,000 km.). The inspection procedures employed for MRC (resistance control) equipped trolley coaches in Vancouver are shown in Figure 1.4-8.

Chopper propulsion control systems will require changes in inspection procedures, particularly those shown in Figure 1.4-8 under the heading of "Control Compartment." This equipment will replace the MRC unit (master controller, accelerating and braking contactors and related equipment). Present experience with chopper control in this country is quite limited, and a significant amount of revenue mileage will have to be accumulated before inspection procedures can be finalized. One factor that may have a significant impact on inspection intervals is the need to replace air intake filters for the chopper's ventilator system. The inspection process will be aided by the availability of diagnostic test equipment. The chopper system purchased by Philadelphia and Seattle will be provided with test equipment having data readouts for nineteen system parameters. Equipment can also be purchased to locate and repair logic card faults. Defective cards can be repaired in-house, although it is quite common to return them to the manufacturer on an exchange basis.

Unit Exchange - Numerous items on both TC's and motor coaches will have to be exchanged or undergo major overhaul during each vehicle's life. These items are shown in Table 1.4-1. This is not an all inclusive list, but serves to illustrate the major differences between the two vehicle types.

Figure 1.4-8

BC Hydro Inspection Procedures * (1)

<u>ITEM CHECKED</u>	<u>INSPECTION</u>		
	<u>Minor</u>	<u>Major</u>	<u>30,000 miles (48,000 km.)</u>
<u>EXTERIOR</u>			
Trolley base	X	X	X
Trolley poles	X	X	X
Trolley shoes and saddles	X	X	X
Trolley rope and retrievers	X	X	X
<u>CONTROL COMPARTMENT</u>			
Compressor governor	X	X	X
Main contactors and line switch	X	X	X
Voltage regulator	X	X	X
Perform current leakage test	X	X	X
Fuse panels		X	X
All visible connections		X	X
Master controller		X	X
All contactors and interlocks		X	X
<u>UNDER SIDE</u>			
Auxiliary motor brushes, bands and brush holder (2)	X		
Generator brushes (2)	X		
Traction motor and brushes	X	X	X
Compressor brushes	X		
Control rods and bell cranks		X	X
Compressor motor, remove and check brushes		X	X
Auxiliary motor (2)		X	X
Compressor motor		X	X
Drive shaft and differential back lash		X	X
Differential leaks and clean vents		X	X
Clean traction motor screens		X	
Test insulation of traction motor armature			X
<u>LUBRICATION</u>			
Differential oil level	X	X	X
Compressor oil level	X	X	X
Lubricate drive line and universals	X	X	X
Lubricate control rods	X	X	X
Clean and oil motor air intake		X	X
Auxiliary (2) and propulsion motor		X	

* Reference 4

- (1) Excluding items similar to both TC and motor coaches.
- (2) Auxiliary motors and generators have been replaced by static converters on recent purchases of TC's.

Table 1.4-1

Major Unit Components

<u>Drive Train</u>	<u>TC</u>	<u>Motor Coach</u>
Diesel engine and subsystems (A)		X
Traction motor and subsystems (B)	X	
Torque converter		X
Differential	X	X
<u>Auxiliary Systems</u>		
Air Compressor	X	X
Generator		X
Convertor	X	

A - Including starting motors, governor, cooling system, fuel system.

B - Including master controller and contactors.

A fairly common practice with motor coaches is to take the vehicle out of service while drive train units are overhauled. This is not the case with TC's and exchange is the normal mode of operation. This fact greatly improves the TC's availability. BC Hydro currently operates a fleet of 251 TC's that are approximately 29 years old. Each vehicle was in service during a recent sample month. The average vehicle mileage was 2,610 miles (4,200 km.). The distribution of individual vehicle miles shown in Table 1.4-2 attests to their availability.

Table 1.4-2

Distribution of TC Vehicle Mileage in Vancouver *

Month of November, 1978

<u>Range</u>		<u>Incidence</u>
<u>Miles</u>	<u>Kilometers</u>	
0 - 499	0 - 800	1
500 - 999	800 - 1600	2
1000 - 1499	1600 - 2400	5
1500 - 1999	2400 - 3200	18
2000 - 2499	3200 - 4000	58
2500 - 2999	4000 - 4800	121
3000 - 3499	4800 - 5600	42
3500 - 4000	5600 - 6400	4
Total		251

* Reference 5

Brake maintenance - TC's require less brake maintenance since dynamic braking is used throughout most of the braking cycle. BC Hydro has the following experience with brakes in service at the end of November, 1978.

	<u>Trolley Coaches</u>		<u>Motor Coaches</u>	
	<u>Front Brakes</u>	<u>Rear Brakes</u>	<u>Front Brakes</u>	<u>Rear Brakes</u>
<u>Existing life over</u>				
20,000 miles (32,000 km.)	80%	69%	59%	43%
40,000 miles (64,000 km.)	63%	40%	31%	14%
60,000 miles (10,000 km.)	46%	18%	13%	4%

The life distribution of brakes currently in service is shown in Table 1.4-3.

Table 1.4-3

Current Life of Brakes in Service *

<u>Range (000)</u>		<u>Number of TC</u>		<u>Number of Motor Coaches</u>	
<u>Miles</u>	<u>Kilometers</u>	<u>Front Brakes</u>	<u>Rear Brakes</u>	<u>Front Brakes</u>	<u>Rear Brakes</u>
0 - 19.9	0 - 32	52	78	69	97
20 - 39.9	32 - 64	41	71	49	50
40 - 59.9	64 - 100	44	58	30	17
60 - 79.9	100 - 129	30	25	14	3
80 - 99.9	129 - 161	28	14	4	2
100 - 119.9	161 - 193	22	3	4	1
120 - 139.9	193 - 225	17	2	--	--
140 - 159.9	225 - 257	9	--	1	--
160 - 179.9	257 - 290	5	--	--	--
180 - 200.0	290 - 322	4	--	3	--
Total		251	251	170	170

* Reference 5

Unit Repair - The principal units that are subject to periodic repair are the diesel engine and the electric motor. The effort associated with each is dissimilar. The diesel engine must be removed from the vehicle for a complete overhaul, although a top overhaul (valves, sleeves, pistons, etc.) can be accomplished in place. The electric motor offers additional latitude in that it is rarely necessary to remove the motor housing from the vehicle. Commutator surfaces can be smoothed and ground in place and armatures are replaced on an exchange basis as mentioned above. Only faulty field coils will require the removal of the motor case.

A summary outline of the overhaul procedure for both diesel engines and electric motors is presented below.

- o Disassemble the engine,
- o Clean and degrease,
- o Check tolerances of all wearing surfaces,
- o Replace items as appropriate, including sleeves, pistons, rods, valves, bearings, etc.,
- o Remanufacture main components such as crank shafts as appropriate.
- o Check and repair support systems as appropriate including intake air blower, fuel pump, oil, pump, etc.
- o Assemble engine,
- o Place engine in service.

DC motor overhaul steps are:

- o Check field coils mounted on the motor case. If no faults are found, remove only the armature, leaving the motor case attached to the vehicle,
- o Rewind armature, balance and replace commutator as appropriate,
- o Replace motor bearings,
- o Replace armature and reassemble the motor.

The cost of rebuilding a traction motor normally exceeds that of a diesel due to the labor involved in rebuilding an armature. The SEPTA comparison study found the costs to be greater by 30 percent per vehicle. The mileage interval between diesel engine overhauls, however, is normally much less. SEPTA's experience indicates that diesels will accumulate 130,000 miles (200,000 km.) between overhauls (mileage can vary in different operating environments), while the comparative figure for traction motors is 375,000 miles (600,000 km.). Traction motor rebuild costs, taken over the life of the vehicle, are much less. Based on a 24 year life, SEPTA found their costs to be 60 percent less per vehicle. The average life of various components is shown in Table 1.4-4.

The following tabulation shows the existing life of BC Hydro's diesel engines and electric motors in November of 1978. The motor coaches selected for comparison are GMC 5304 and 5306 models with an average accumulated mileage in excess of 450,000 miles (725,000 km.). These data confirm that DC motors do have longer lives and further support the contention that TC's have lower maintenance costs.

	<u>TC</u>	<u>Motor Coach</u>
Existing life over 50,000 miles (80,000 km.)	75%	77%
Existing life over 100,000 miles (160,000 km.)	62%	58%
Existing life over 150,000 miles (240,000 km.)	46%	39%
Existing life over 200,000 miles (320,000 km.)	35%	17%
Existing life over 250,000 miles (400,000 km.)	23%	1%

The other units that are subject to rebuilding requirements were shown in Table 1.4-1. As this table indicates, a greater number of components are associated with the motor coach. Table 1.4-4 indicates the lower lives associated with motor coach components. Together these facts further indicate the greater amount of effort associated with motor coach maintenance.

Table 1.4-4

Average Life of Major Unit Components *

<u>Drive Train</u>	<u>Vehicle Type</u>	<u>Average Lifetime</u>	
		<u>Miles</u>	<u>Kilometers</u>
Diesel engine	MC	130,000	210,000
Traction motor	TC	375,000	600,000
Torque convertor	MC	75,000	120,000
Differential	TC/MC	No difference cited	
<u>Auxiliary Systems</u>			
Air compressor	TC/MC	375,000/25,000	600,000/40,000
Generator	MC	85,000	140,000
Converter	TC	375,000	600,000

* Reference 6

Staffing Requirements - Transit systems that have established electrical operations possess most of the capabilities required to maintain TC's. The lack of chopper experience may be the single most important exception. In this situation, appropriate staff members will be required to take specialized training.

Transit systems presently not operating TC's will have to acquire the necessary capabilities. Diesel mechanics can be trained to perform routine inspections and make necessary repairs on contactor propulsion systems. Personnel assigned to maintain chopper systems must possess experience in electronics that probably will not be available within an existing organization. Should the operator elect to perform all unit rebuilding in house, additional skill will be required to rewind and rebuild armatures and perform necessary work on other units unique to the TC.

New TC operations may also have the ability to consider in-house versus contractor unit rebuilding. The principal items to consider include traction motor armature and field coils and the static converter. Such a course would lower staff requirements and may have a significant impact on cost savings.

The total work force required to maintain a fleet of TC's is less than that required for a similar number of motor coaches. The Oak Street operating garage of BC Hydro employs a maintenance staff of 128, excluding supervisory personnel. Approximately 75 are assigned to maintain 301 TC's and the balance work on 160 diesels. The ratio of vehicles to personnel is about 4:1 for TC's and 3:1 for diesels. Only limited unit work is performed at this location.

The reduction in maintenance staff made possible by the TC can give rise to 13c (job protection requirement) considerations. Some of the displaced workers could be retrained to perform overhead line maintenance and other new functions associated with the TC. The problem is compounded by the requirement for new capabilities and a possible desire to contract certain unit work.

Facilities Required - The facility requirements for TC's and motor coaches do not vary greatly. Existing garages can usually be adapted to the TC's needs if sufficient height is available for overhead wires. Garage space is traditionally allocated between two maintenance functions, inspection and repair. In order to minimize the need for overhead wiring the configuration of the inspection area should employ lanes or angled bays that can be accessed without the need for overhead special work. The relative high turnover of vehicles in the inspection area requires continual wire access.

Repair areas can be configured in the same manner for both vehicles. Since vehicle turnover in this area is usually longer, it is not necessary to wire each possible movement. One access wire, running the length of the repair area, should be provided. Final coach positioning can be accomplished using an umbilical cord attached to the trolley poles and a power source.

TC visits to main maintenance facilities will be infrequent and made principally for collision repair work. Existing configurations are directly usable by TC's, provided a tow truck can maneuver the vehicle into work areas. If the transit operator chooses to perform all unit repair work additional floor space may be required. Wiring need not be provided to access these facilities, if they are remote from the TC system, and internal wiring can be limited to a short section used for coach testing.

Servicing

Transit vehicles are serviced in preparation for their next revenue assignment. The various activities which relate to TC's and motor coach servicing are indicated in Table 1.4-5.

Table 1.4-5

TC and Motor Coach Servicing Activities

<u>Activity</u>	<u>TC</u>	<u>Motor Coach</u>
Secure a defect card from driver	X	X
Remove fare receipts	X	X
Add fuel		X
Check and add lube oil		X
Check and add coolant		X
Check and add torque converter fluid		X
Check tire pressure	X	X
Check and replace carbon inserts	X	
Check exterior (lights, mirrors, etc.)	X	X
Clean interior	X	X
Clean exterior	X	X
Running brake check	X	X

The differences between the two are readily apparent. The TC needs none of the engine servicing steps, but adds one additional requirement, namely, check and replace carbons. According to the SEPTA study, which compares TC's and motor coaches, TC's required less time for servicing. The engine servicing steps consumed 78 hours/vehicle/year while carbon checking required only 10.2 hours/vehicle/year resulting in a net saving of 67.8 hours. All other activities were assumed not to vary in time between the two vehicle types.

Major differences - Carbon inserts can be checked in one of two ways. First, the inserts can be checked on a daily basis and changed as required. Second, they can be changed at intervals whose length is based on average shoe life, as measured in miles, and average daily vehicle miles. The interval should be sensitive to the normal range of variations for these two items. The actual servicing activity can take place at the service island or in the storage area after the coaches have been parked. The latter course is often performed since slack times can be better utilized and work effort at the time of initial pull-in can be reduced.

The amount of personnel training required to accomplish this additional activity is minimal. The principal aim of such training is to impress upon personnel that they will be working with 600 volt equipment.

Although the SEPTA study equates the amount of effort required to wash TC's and motor coaches, differences can exist. Many transit operators currently employ mechanical washers that clean all external surfaces. This equipment cannot be employed to clean TC's since it would interfere with current collection equipment mounted on the top and rear of the vehicle. Although bus washers have been modified to clean a portion of the roof, hand washing is necessary for the rear portion of the vehicle, and additional staff time is required.

Facilities required - Existing servicing lanes can be used for TC's provided sufficient clearances exist for the overhead wires. If coach washing equipment is available in each lane, separate service islands should be provided for TC's and motor coaches and each provided with the appropriate washer. TC lanes need not be equipped with fueling and other motor coach facilities. Segregation is not necessary if washers are in a remote location or if the washer can be equipped with a retractable roof brush, as was used in Chicago.

Service area wiring - The immediate service area and its access should be wired. Wiring between the service and storage areas can be eliminated if auxiliary power is provided. Depending on the layout of the service area it may be desirable to wash coaches when they are operating on auxiliary power.

Storage

The facility options available for trolley coach storage exceed those of the motor coach. The TC can for all practical purposes be treated as an electric rail vehicle. It does not have an internal combustion engine which is sensitive to the low temperatures experienced in the northern regions of this country. In most instances, existing motor coach storage could be converted to accommodate TC's.

Facility requirements - A majority of the TC's in operation in this country are stored out-of-doors. This includes areas such as Boston, that experience significant annual snowfall. Facility requirements are minimal and consist of a paved lot configured in a manner that will accept lane storage. Protection from the elements and vandalism can be provided, but heated facilities are not necessary. During the cold weather months it is desirable to heat the coaches prior to the morning pull-out. This is easily accomplished since the vehicles are electrically heated and do not rely upon the prime mover as a heat source.

There has been a trend in recent years to store transit buses in other than lane configurations. Some operators want the ability to access any coach at any time, and have employed herringbone and other parking configurations to achieve this end. TC's without auxiliary power are required to use lane configurations. Existing storage facilities would have to be converted to lane storage unless the auxiliary power feature is purchased.

Storage area wiring - Wiring of storage facilities was discussed in a previous section. Typically, outside lots do not require a wire over every lane. Two or three lanes can share a common wire. Switches can be controlled by a yard master to speed the storage operation. Shared wire is usually not used on protected storage since it would inhibit emergency vehicle removal. Existing facilities can be wired provided sufficient clearances are available. It may be necessary to rebuild doorways in some instances to provide sufficient clearances.

Wiring can be clearly simplified if auxiliary power is provided. Access and entry into the facility need not be wired. Wire should be installed in storage areas to minimize pull-out time, but only trailing point switches are required. Trolley poles could be lowered in the servicing area and the vehicle parked on auxiliary power. During the night, the carbons can be checked and the poles placed on the wire for the morning pull-out.

Satellite parking - The minimal servicing needs of the TC permit consideration of another storage alternative, satellite parking. Facilities can be provided at outer terminals to reduce pull-out and pull-in times. The facilities should be secured and need to be manned only by cleaning personnel and a transportation department representative. Boston, until recently, employed a satellite lot on its North Cambridge route.

Power Distribution, Operation and Maintenance

Power distribution maintenance can be subdivided into two subcomponent areas:

- o Feeder distribution and overhead contact systems
- o Substations.

The requirements placed on a transit operator who has decided to install a TC operation can vary considerably. Operators of light or heavy rail systems have an infrastructure that will support TC operations and need only adapt it to this vehicle type. Lacking the presence of such an infrastructure, steps must be taken to put it in place.

Feeder distribution and contact wire systems - Current operators of rail services that use an overhead wire system will have the capabilities needed to maintain TC feeder and contact wire systems. Some degree of training will be required to familiarize staff with the principal differences in the two wire systems. Operators of third rail systems will have to acquire new capabilities to maintain the contact wire system although the existing staff should be able to handle the feeder system.

The new operator must acquire all the capabilities needed to maintain an overhead wire system. The necessary steps to secure these capabilities include:

- o Establish a power distribution department and appoint a department head. This department will also be responsible for substations and normally will report to the system's chief of maintenance.
- o Establish maintenance procedures and construction standards for the various overhead configurations employed.
- o Inspection procedures must be established to periodically field check the wire system. Contact wire inspection must be checked according to its usage pattern. The following inspection plan is employed by some current operators.

<u>Number of annual collector passes</u>	<u>Inspection intervals</u>
100,000	6 Months
50,000	12 Months
25,000 and less	15 Months

- o Determine manpower requirements to:
 - conduct normal maintenance and inspection activities,
 - provide emergency protection during peak periods,
 - provide on-call protection nights and weekends.

- o Purchase line trucks and appropriate line tools.
- o Recruit and hire line crews to maintain all feeders and overhead lines. Table 1.4-6 indicates the number of crews needed to accommodate wire mileages on existing systems. Line men are required by a variety of utility companies and a pool of trained personnel is readily available.
- o Purchase a replacement hardware inventory and establish a stores system to dispense same.
- o Establish communication links and appropriate procedures with fire, police and other agencies to deal with emergency situations that involve or may affect the contact wire system.

Table 1.4-6

Personnel Employed for Overhead Wire Maintenance

<u>System</u>	<u>Field Forces</u>	<u>Wire Miles (km.)</u>	
		<u>Maintained</u>	<u>Normal Deployment</u>
San Francisco	27	115 (185) TC 43 (70) LRV	
Seattle	17	64 (100) (a)	Five man maintenance and construction Two man emergency and inspection
Vancouver	17		Four man crews
Dayton	10	140 (225)	Three man crews

(a) As of January, 1978, the number of personnel is expected to remain the same for the expanded system, which will more than double the wire miles.

Source: Personal and Telephone Interviews

Substations - A number of cities in the U.S. and Canada have electrified rail systems and employ staff to operate and maintain substation equipment. The operators of these systems, in most instances, have been upgrading substations by installing state-of-the-art conversion equipment. As such their staff is fully acquainted with conversion technology that would be employed for a new TC installation. New installation would probably require additional staff, but the availability of surplus substation capacity in some cities may hold this requirement to a minimum.

Transit systems that do not currently operate electric services will have numerous problems to overcome. The solutions to these problems will be aided by the lack of restrictive work rules and other precedents which often encumber operators of existing power distribution facilities. The problems are:

- o Substation Ownership and Operation - The new operator may have the option of purchasing 600 volts DC directly from the utility company. This action would preclude the necessity of owning, operating and maintaining substation equipment.
- o Operation of substations - Modern substations are unmanned and can be remotely monitored. Operational responsibility of existing systems generally rests with a load dispatcher who monitors performance and summons maintenance forces when outages occur. New systems have other alternatives which can be considered.
 - Transportation department personnel at a systems operation center or a major garage can monitor the system for faults.
 - Remote monitoring equipment can be omitted and replaced by driver reports of outages to the system operation center. The reliability of present day conversion equipment and improved radio communication reduces and, in some instances, eliminates the need for formal substation monitoring.
- o Maintenance of substations - Transit operators will normally have to look outside their organization for maintenance supervision and staff. Assigned personnel should have several years experience with solid state electronic systems. The general use of this equipment in various industrial applications provides a ready pool of qualified personnel. The necessary steps to establish a maintenance capability are:
 - Establish inspection and maintenance procedures.
 - Determine manpower requirements to provide 24 hour capabilities. Nights and weekends can usually be covered by on-call personnel.
 - Recruit and hire experienced staff.
 - Purchase a replacement hardware inventory to minimize outages caused by equipment failures.

Seattle presently plans to assign one person to maintain and inspect 24 500 KW substations. Maintenance of the larger CBD units will be contracted to City Light.

Training of Operating Personnel

The introduction of trolley coach service must be preceded by a driver training program. This program must illustrate vehicle differences, the power distribution system, emergency procedures and provide supervised training on the vehicle. The following is a training program outline for experienced motor coach drivers.

1. Classroom Activity

- o Description of the Propulsion System
 - Control Switch - closes the master contactor and energizes the compressor and static converter
 - Directional lever - controls direction of travel
 - Power pedal - controls flow of current to the motor and speed of operation
 - Line braker - energizes the propulsion system
 - Resistance grids - limits current flow during acceleration and dissipates current generated during dynamic braking
 - Overload relay - protects against excessive currents
- o Description of Auxiliary Systems
 - Air compressor - supplies air for braking, suspension, etc.
 - Static converter - supplies all low voltage current
 - Heater system
- o Description of Coach Control Console
- o Description of Overhead Wire System
 - Switches and means of activating
 - Crossovers
 - Section insulators
 - Speed through special work
 - Sectionalization
 - Substation functioning
 - Starting procedure after power outage
- o Description of the Current Collector System
 - Current collector
 - Trolley poles and base
 - Retriever
 - Dewirement procedures
- o Description of the Brake System
 - Air brakes
 - Dynamic or electric brakes
 - Regenerative brake
 - Parking brake

- o Hot Coach Procedures - steps to be taken when the coach develops a potential to ground
- o Hot Wire Procedure - steps to be taken when an overhead wire falls on the coach
- o High Water Procedure - steps to be taken when standing water is encountered on the roadway

2. Training in the Depot Yard

- o Current Collection System - illustrate the functioning of various components and have trainees practice rewiring procedures
- o Overhead Wire System - illustrate the various components and methods of switch activation
- o Vehicle Description and Functioning
 - Locate the various components that were described in class. Trainees should view underbody and principal control cabinets.
 - Illustrate procedure for placing coach in service
 - Illustrate the use of all items on the driver's console and the directional lever
 - Illustrate parking clearances required to avoid damage to trolley poles and front of coaches
 - Demonstrate "backing" procedures on wire and through special work
 - Illustrate emergency procedures, e.g., pushing and towing of dead coach, use of wheel chocks, broken trolley rope, etc.

3. Onboard Training

- o Illustrate use and response of power pedal and brakes in normal situations and on grades
- o Illustrate touring limits of the coach and proper bus stop procedures
- o Illustrate the procedures for activating switches and operating through special work
- o Illustrate the functioning of current collector when the coach position is both inside and outside the curve on curve wire segments and at switches
- o Illustrate limits placed on coach maneuverability and ability to accelerate without dewiring when operating near vehicle's touring limits
- o Allow trainees to operate the coach.

4. Driving Experience with a Driver Instructor

The trainee is in full control of the coach, but a driver instructor is present to observe and instruct as required. This step can be omitted for experienced motor coach drivers.

Although this program is primarily intended for training drivers, all persons in a position to operate the coach should be required to participate. Those required to complete the program should include maintenance department forces, especially hostellers, servicemen and emergency road service personnel, and roadmen, road supervisors and inspectors employed in the transportation department.

Scheduling

Vehicle scheduling is aided by the employment of trolley coaches. The motor coach tour of duty is limited by the amount of fuel it consumes and the size of the fuel oil tank. This constraint does not apply to TC's and they can remain in service between early morning pull-outs and late night pull-ins. The only constraint that may apply is the need to clean coach interiors when excess refuse collects during the daily duty cycle. Systems that have a low peak to base ratio will be able to significantly reduce pull-in and pull-out mileage and the amount of vehicle turnover at storage and servicing facilities. These reductions will in turn allow for a small cost savings.

Organizational Changes

The existing operator of electrical transit services will probably not have to make any major organizational changes to accommodate the TC. The exception may be the need to create an overhead line section within its power distribution department. The new operator will have to make certain changes to accommodate the TC. Vehicle related maintenance responsibilities can usually be assigned to existing departments. For example, TC unit repair work can be assigned to the existing unit repair shops, provided its capabilities are increased. Power distribution will require the addition of a new functional area. One possible assignment of this function is shown in Figure 1.4-9.

Figure 1.4-9

Organization of the Maintenance Department
for TC Operations

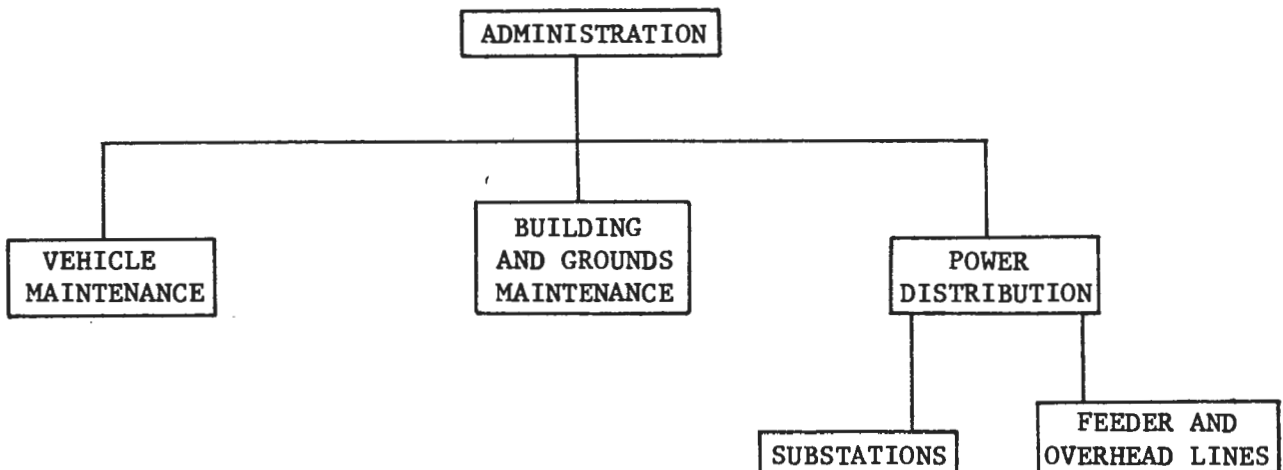

Feasibility of Trolley Coaches for Exclusive Right of Way Operations

Background

Trolley coaches have not been extensively employed in fixed guideway systems. The only significant example of such a system that we have knowledge of is in Guadalajara, Mexico. This recently constructed system consists of a 3.2 mile/5.1 km. subway in the central area with portals at both ends. Two surface routes operate through the subway section, giving the route structure a general H shape. The subway portion has five underground stations and one at each portal. Apparently, one of the significant factors in the choice of trolley coaches for this system was the availability of used vehicles from Chicago at low cost. In general, the system appears to be an attempt to provide an exclusive right of way for transit through a congested area at the lowest possible capital cost, minimizing the value of imported equipment required.

Differences in Right of Way Requirements

In general, trolley coaches have very similar performance characteristics to current generation diesel motor coaches. Thus, the design of exclusive rights of way and operation on such facilities will be very similar. However, certain design differences do exist. The most significant difference is the need to provide ventilation in an underground facility designed for diesel coaches which would not be needed for trolley coach operation.

A second design difference is the greater vertical clearance required for trolley coach operation. A busway could be built for motor coaches with as little as 11 feet/3.4 m. vertical clearance. Trolley coaches would require at least 13 feet/4.0 m. of vertical clearance due to the roof mounted equipment on the vehicle and the space required for overhead wire construction. In addition, roadway design must provide for gradual transitions between varying wire heights. For example, it would be impractical to have a 13 foot/4.0 m. clear height underpass adjacent to a road crossing requiring 18 foot/5.5 m. of wire clearance.

Operational differences exist primarily in the form of speed restrictions due to the use of overhead wiring. These have already been described in the section on mixed traffic operation on freeways. The most significant restriction is the speed limit of 36 mph (58 kmph) at wire switches. This would result in a slight reduction of overall speed on a busway with frequent entrances and exits, or with off line stations. The diverging movement speed restriction is less important, as there is usually a speed restriction anyway for diverging movements as a result of roadway geometry.

The top speed difference between trolley coaches and motor coaches would produce only a small change in actual system performance. For example, the difference in running time over a seven mile distance due to 55 mph/88 kmph as opposed to a 50 mph/80 kmph top speed is only 48 seconds. In actual operation, it is likely that the higher acceleration and better performance of the trolley coach on grades would counter the top speed advantage of the diesel motor coach so that running times would be almost identical, as was found for normal street operation.

Differences in guideway requirements between trolley coach or diesel motor coach and light rail systems are more significant. Basic differences exist in both width requirements and structural requirements imposed by vehicle weight. The minimum width requirement for both vehicle types is a 24 feet/7.3 m. right of way for two direction operation. This minimum width would be applicable to tunnels or structures and could result in restricted speed operation for motor coaches.

For an at-grade right of way, 27 feet/8.2 m. would be the minimum desirable width for a rail system. Busways will require wider rights of way, but design standards vary. Pittsburgh uses two, 14 feet/4.3 m. lanes without shoulders in a right of way of approximately 40 feet/12.2 m. Most busways have been designed with shoulders which would increase the right of way requirement to approximately 50 feet/15.2 m.

Vehicle weight differences are also substantial. The vehicle weight (fully loaded) for a trolley coach is 33,400 pounds/15.2 MT. or 835 pounds per foot of length/1242 kg/m. For the standard Light Rail Vehicle, the fully loaded weight is 103,000 pounds/46.7 MT. or 1450 pounds per foot of length/2163 kg/m. It should be noted that the support structure is more narrow for a rail system than for a busway. The weight bearing portion of a rail system structure is approximately 3 feet/0.9 m. on either side of the track centerline, while on a busway, the full width of the roadway is load bearing.

Vertical clearance requirements are almost identical for trolley coaches and light rail cars with pole or pantograph current collection. If third rail current collection is used, clearances may be reduced by approximately 1 foot/0.3 m.

In addition to the dimensional differences there is one structural design element that varies between rail and motor coach roadway rights of way. Rail systems may be designed with physical separation between the two channels of movement. Motor coach roadways should be designed without such separation unless the roadway for each direction is of sufficient width to allow vehicles to pass. This constraint is of particular importance in underground construction. Many rail facilities are designed with separate tunnels for each track, or where cut and cover construction is used, center supports are placed between the tracks.

The reason behind this constraint is that rail vehicles are designed so that a stalled vehicle may be pushed by the following one to clear the line. Motor coaches not being physically guided, can bypass a stalled vehicle if sufficient room is available.

The differences in guideway surface and associated facilities are substantial. The most obvious is the need for a paved surface as opposed to rails. The power distribution system is somewhat different. Substations and feeder lines are almost identical. A single centered overhead wire is needed for rail systems, as opposed to two contact wires at 24 feet/7300mm spacing for trolley coaches. Signal systems are generally used for rail systems, but not for trolley coaches.

Stations for trolley coaches or step entry light rail vehicles are similar, except that off line stations (stations with loading lanes separate from the main roadway) would not be used on a rail system. In addition, the platform edge may need to be moved closer to the centerline of the guideway, if the full roadway width is maintained through the station. Stations intended for ultimate conversion to level entry for rail use will require greater alteration. In this situation, the station is generally designed for level entry with either the track or roadway being raised on trestlework (Boston), or a portion of the platform being depressed to track level and connected by short stairways or ramps to the remainder of the station (Brussels).

A final difference is that a right of way for trolley coach operation must include space for turning facilities at any point where a vehicle is to change direction, either as part of a regular operation or in an emergency. Rail systems, however, may be designed either for single or double end vehicles. Double end vehicles require only an appropriately located crossover to change direction. For this reason, even some rail systems such as Boston that are equipped with turning facilities for most of their routes are specifying double end equipment.

Suitability of Trolley Coaches for Different Right of Way Configurations

Each of four right of way configurations are examined in this section in terms of cost and operational feasibility. These are:

1. Subway in central area; street operation in outlying areas.
2. Motor coach roadway in trunk portion, street operation in central area and outer portions.
3. At-grade right of way except for central area which is on streets.
4. At-grade right of way except for central area, which is in subway.

Costs for configurations 1 and 2 are based on a multiple route system having a total of 30 two way line miles (48 km.). In case 1, 3 miles (4.8 km.) of subway are included. Costs for configurations 3 and 4 are based on a single route of 10 miles (16 km.). All configurations are costed for usage levels of 25,000 daily trips, including 4,000 in the peak hour.

For each configuration, trolley coach operation is regarded as the base situation. Costs for light rail or diesel motor coach operation are treated as positive or negative increments. Costs given are highly generalized. Only items where major cost differentials exist are indicated. Costs are based on a 30 year life cycle. All fixed facilities are assumed to last 30 years. Variations in vehicle life are treated explicitly in the cost tables. Two fleets of motor coaches are included in the life cycle vehicle costs, and one and one-half fleets of trolley coaches. Costs are based on single unit six-axle articulated light rail cars and 40 feet/12.2 m. motor and trolley coaches. Train operation for light rail and the use of articulated motor coaches and trolley coaches will reduce the operating costs for all of the vehicle types but should not significantly affect the relationships among the vehicle types shown in the following tables.

Configuration 1 - Subway in central area; street operation in outlying areas. This right of way configuration is compared with both diesel motor coaches and light rail. It is perhaps the best suited of any to trolley coach operation. The principal advantages of the trolley coach are the substantial reduction in the need for ventilation in the underground portion of the route, as compared with diesel coaches, and the elimination of the need for street track construction, as compared with light rail.

Ventilation requirements for underground operations of diesel coaches are very uncertain. The three block long Harvard Square station is limited to 30 motor coaches per hour in addition to trolley coaches.

No example of an underground busway with stations has been built, to our knowledge. Ventilated enclosed facilities for motor coaches such as the Port Authority Bus Terminal in New York, the South Hills Tunnel in Pittsburgh, and underground stations in Toronto and Boston are not comparable. If ventilation provisions for vehicular tunnels are used as a design standard, then intake and exhaust ducts along with ventilating shafts and fans would be needed. Thus, for this situation, the ventilation requirements, although a crucial cost determinant, are impossible to specify.

Cost comparisons for motor coach, light rail and trolley coach operation for Configuration 1 are shown in Table 1.4-7.

Operating feasibility problems with this configuration exist only with motor coaches. The ventilation problem introduces a large amount of uncertainty. None of the enclosed motor coach facilities presently operating provide a satisfactory environment for waiting passengers.

Configuration 2 - Motor coach roadway in trunk portion, street operation in central area and outer portions. This right of way configuration tends to favor diesel coaches, as the cost of wire is eliminated. Comparison is made only with motor coaches, as the comparisons shown for configuration 1 show that light rail is a high cost mode for systems that operate mostly on the street. Configuration 2 costs are shown in Table 1.4-8. There appear to be no problems of operating feasibility for either mode in this configuration.

Configuration 3 - At-grade right of way except for central area which is on streets. This comparison is made for motor coach, light rail and trolley coach operation and is shown in Table 1.4-9.

Table 1.4-7

Configuration 1 - Cost Comparisons

<u>Cost Item</u>	<u>Trolley Coach/ Motor Coach</u>	<u>Trolley Coach/ Light Rail</u>
INITIAL COSTS (in dollars)		
Tunnel ventilation	+\$10/+60 million	0
Overhead wire	- 9 million	0
Vehicles	- 2 million	+\$15 million
Underground turning loop	0	- 7 million
Street trackage	0	+ 34 million
Signals in subway	0	+ 1 million
NET INITIAL COST	-1/+49 million	+ 43 million
LIFE CYCLE COSTS (in dollars)		
Operating cost	0	-20 million
Vehicle life	+2 million	- 5 million
NET LIFE CYCLE COST	+1/+51 million	+18 million

Table 1.4-8

Configuration 2 - Cost Comparison

<u>Cost Item</u>	<u>Trolley Coach/Motor Coach</u>
INITIAL COSTS (in dollars)	
Overhead wire	-\$9 million
Vehicles	- 2 million
NET INITIAL COST	-11 million
LIFE CYCLE COSTS	
Vehicle life	+ 2 million
NET LIFE CYCLE COST	- 9 million

Table 1.4-9

Configuration 3 - Cost Comparison

<u>Cost Item</u>	<u>Trolley Coach/Motor Coach</u>	<u>Trolley Coach/Light Rail</u>
INITIAL COSTS (In dollars)		
Overhead wiring	-\$5 million	0
Vehicles	- 2 million	+\$15 million
Signal System	0	+ 2 million
NET INITIAL COST	- 1 million	+17 million
LIFE CYCLE COSTS (in dollars)		
Operating cost	0	-30 million
Vehicle life	+ 2 million	- 5 million
NET LIFE CYCLE COST	+ 5 million	- 18 million

Configuration 4 - At-grade right of way except for central area, which is in subway. The cost differentials between trolley coach and light rail in this configuration are the same as in configuration 3, except that there is an additional \$7 million advantage for light rail due to the elimination of an underground turning loop. The comparison with diesel coach operation is dependent on the ventilation requirements as described in Configuration 1.

Variations Due to Usage Level

The comparisons presented above are, of course, not uniformly valid throughout all usage levels. At substantially lower usage levels than were used in the comparison, the TC and motor coach would show less of an operating cost differential when compared with light rail operation. Light rail vehicles have higher per vehicle operating costs, but lower operating costs per unit of capacity. As usage levels decrease, the additional capacity of the vehicle becomes unnecessary over a larger part of the daily operation, and thus, the higher cost per vehicle will raise the overall operating cost. This effect is minimal above a usage level of approximately 2000 passengers per hour in the peak. For example, in Configuration 3, the life cycle cost differential between trolley coach and light rail drops from \$18 million to \$8 million when the peak load is reduced by half, to 2000 passengers per hour, but increases to \$38 million when the peak load is doubled to 8000 passengers per hour. In no case does doubling or halving the peak load produce a change in the service type that is least costly.

The range of 2000 to 8000 passengers per hour covers most situations where a service type choice would be an issue for exclusive right of way systems. Above this level, rail systems are likely to be necessary to achieve reliable operation. Below this level, it is not likely that an exclusive right of way will be a reasonable alternative.

At usage levels substantially greater than cited in the example, the trolley coach and diesel motor coach systems may not be capable of providing sufficient capacity. In particular, systems that do not have off line stations, as would be found in most subway applications, may be capacity limited. There is limited experience with facilities of this type. The Harvard Square station is scheduled to operate 71 vehicles per hour during the morning peak. It seems reasonable to expect that the frequency of motor coach movements observed on surface streets could at least be equalled, if not exceeded, since there would be no street traffic conflict. Thus a reasonable upper limit may be a 30 second headway, or 120 vehicles per hour, giving a capacity of approximately 8,000 passengers per hour for single unit vehicles. This would increase to approximately 11,000 passengers per hour for articulated vehicles. At this service volume, a major terminal stop is likely to require multiple loading bays.

Conversion of Trolley Coach Rights of Way to Rail Operation

The conversion of a trolley coach right of way to rail operation, light rail operation in particular, would be relatively simple if the facility has been designed for later conversion. Such a design would allow for the clearances and weights required by rail vehicles. The primary cost element will be the replacement of the paved roadway surface with track. This could cost in the order of one-half to one million dollars per route mile depending upon the type of installation. Other items would be the installation of a signal system, and the removal of the negative overhead wire, relocation of the positive wire, and replacement of special work to accommodate either pantographs or fixed harp trolley poles. If the amount of service provided is to increase substantially, additional substations would be needed. Station changes would be limited to revising the platform edge as previously mentioned.

Such conversion would require that the operation over the right of way be wholly or partially suspended during the conversion period. It is unlikely that a trolley coach right of way would have usage levels that would make surface street operation infeasible, as it would be with many heavy rail routes. In some situations, conversion could be scheduled so that one lane or track of the right of way was available for use during peak hours in the prevailing direction of movement. This approach was used in the conversion of the South Hills tunnel in Pittsburgh from light rail to combined motor coach and light rail use.

REFERENCES

CHAPTER 1.4

1. The Trolley Coach in North America, Sebree and Ward, Cerritos, California, 1974.
2. "600 Volt Propulsion System for Electric Trolley Coaches," General Electric, Erie, Pennsylvania, 1976.
3. "Trolley Coaches in the United States, Total and GE Equipped," General Electric, Erie, Pennsylvania, 1950.
4. "Trolley Coach Inspection Procedure," BC Hydro and Power Authority.
5. "Monthly Mileage Report," BC Hydro and Power Authority, November 1978.
6. "Alternative Analysis - Trolley Bus vs. Diesel Bus," SEPTA, Philadelphia, Pennsylvania, March 1977.
7. "Training Procedure," BC Hydro and Power Authority.
8. "Pittsburgh East Busway Design," Passenger Transport, May 1978.
9. Comparison of Busway and Light Rail Modes, Proceedings of the 1975 TRB Light Rail Conference.
10. A Policy on Design of Urban Highways and Arterial Streets, AASNO, 1973.
11. Light Rail Transit Construction Costs, Proceedings of 1975 TRB Light Rail Conference.
12. "Tabulation of Trolley Coach Rehabilitation and Extension Cost," Municipality of Metropolitan Seattle, 1978.
13. Light Rail Transit, A State of the Art Review, UMTA, DOT-UT 500009, Washington, D.C., 1976.
14. Bayonne-Jersey City Rail Corridor Alternatives, NJDOT, CRW, Trenton, New Jersey.
15. Transportation and Traffic Handbook, Institute of Traffic Engineers, 1976.

CHAPTER 1.5

IDENTIFICATION OF RESEARCH NEEDS

Introduction

In general, the trolley coach is a proven form of public transportation. It would be possible today to construct a trolley coach system using readily available components whose design has not substantially changed since the 1940's. However, the environment in which a trolley coach system operates has changed. For example, the use of exclusive rights of way makes it desirable to have higher speed capability than is usable on surface streets. Thus, there are several areas where research is needed for certain components of a trolley coach system. Areas that we have identified for possible research are listed below and cover many aspects of trolley coach development, from transit passenger preferences to specific subsystems. Potential research areas are:

- o Off wire capability
- o Current collection for high speed operation
- o Power control systems
- o Routing control
- o Passenger preference.

Off Wire Capability

Problem

The current trolley coach is a vehicle that can only be operated under wire. This factor limits the scope of the trolley coach to installations where wire is justified for all regular route locations as well as for frequently used detour or turnback locations and all movements to, from and within garages and storage areas.

Solutions

Develop various forms of dual power system vehicles. Off wire systems may be classified by their performance characteristics. These include: emergency systems, with very limited range and speed capability of from 5 to 10 mph (8 to 16 kmph); auxiliary systems, with sufficient range for lengthy detours and garage movements and speed capability of from 20 to 25 mph (32 to 40 kmph); and full capability systems, in which full performance is available from either power source. Types of power sources proposed or used include batteries, internal combustion engines and flywheel energy storage systems.

Background

Initial development of full capability dual powered vehicles was undertaken by Public Service Coordinated Transport of New Jersey in the 1930's. The idea has remained dormant until recently when several European systems as well as Seattle developed dual powered vehicles of various performance characteristics. Some of these are production systems while others are experimental.

Summary of Research Efforts Required

- o Establish value of off wire capability in various situations.
- o Examine potential hardware to see if it meets cost effectiveness criteria.
- o Develop promising hardware, if any, into a workable system.

Detailed Research Description

To establish value of off wire capability for various performance levels, it would be necessary to estimate the cost of not having such capability. Costs include additional wire and switches and the additional operating cost for such factors as circuitous routes to and from garages. In addition, the costs of maintaining service during emergencies or detours would need to be estimated. The costs include additional supervision and emergency wire repair crews, additional driver time due to delays, and the cost of substitute motor coach service.

For full capability systems, the value of having dual powered vehicles for regular route service would need to be estimated, including an evaluation of the situations where such capability could be effectively utilized. For example, a cost comparison of full capability dual powered vehicles with conventional trolley coaches and motor coaches for a subway surface operation would examine the cost tradeoffs among dual powered vehicles, tunnel ventilation and overhead wire extensions.

Given this type of cost tradeoff study, the value of various levels of off wire capability could be established. These values would then be converted into life cycle cost figures that would reflect additional operating costs due to the weight and size of the propulsion system as well as purchase and maintenance costs. In addition, the potential use of each type of off wire system should be estimated so that development may be concentrated on systems that are appropriate for the widest application.

The next step would be to examine the potential hardware to determine if it can meet the requirements developed in the previous task. This would include a review of existing research on off wire systems as well as an examination of technology in related areas to determine transferability. For example, the field of internal combustion engines usable for auxiliary or emergency power could be expanded to include piston engines designed for light aircraft. The examination would determine not only the initial and operating costs of the potential power source, but also physical limitations such as size and weight which might make a particular power source infeasible.

Automatic rewiring capability would also be a part of the off wire systems research program. This capability would also be examined from a cost tradeoff standpoint. Tradeoffs among cost, flexibility of rewiring location, speed of rewiring, and precision of vehicle positioning required to use the system should be included. The available hardware would then be evaluated in terms of meeting the cost effectiveness requirement.

Finally, the development of promising hardware into a workable system should be undertaken if it is found to be worthwhile. This process would include detailed system design, fabrication of prototype, equipment and component testing, installation of equipment into vehicles and in-service testing.

It should be noted that UMTA is currently funding a research effort in flywheel technology. As was discussed in Chapter 1.1, this technology may provide an off-wire capacity for TC's. Although this capability is not the main thrust of the research effort, the potential side benefits may enhance the flexibility of TC's.

Current Collection For High Speed Operation

Problem

Existing trolley coach current collection equipment is a limiting factor in high speed operation. Speed limits are a particular problem for operation through switches and on curves. Also, high speed operation requires that vehicles stay fairly close to the wire centerline. Even within the limiting speeds, high speed operation increases the frequency of dewirements, the damage caused by dewirements, and wear on the overhead wire system.

Solutions

The Kummner and Matter (K&M) flexible overhead suspension system is claimed by its manufacturer to permit higher speeds and to reduce dewirements and wear for high speed operation. In addition, a more general review of current collection technology, including both hardware and system configurations, may produce an improved design.

Background

Trolley coach current collection is generally based on the street car technology developed in the early part of this century. The hardware in general use today is almost identical to that developed in the 1930's. Although current technology is adequate for surface street operation, the potential for use of trolley coaches on exclusive rights of way may be limited by the speed restrictions inherent in presently available current collection hardware.

Summary of Research Efforts Required

- o Determine value of various performance levels.
- o Define characteristics for overhead wire system.
- o Test K&M wire system to determine performance limits.
- o If needed, develop wire system concepts.
- o Test prototype wire system.

Detailed Research Description

The first task would be to determine the value of various performance levels. This may be accomplished by estimating the number and types of routes that are presently infeasible for trolley coach operation that would become feasible at various levels of performance. Performance would be measured in terms of speed on straight movements, speed at which excursions from the wire centerline may be performed and speed through switches. The effects of factors such as pavement condition and variations in wire height should be considered. This analysis should determine the extent to which speed restrictions are a limiting factor in trolley coach utilization and thus be indicative of the need for further research.

If there is found to be a need for higher speed capability, then the next step would be to test the K&M wire system. It is recommended that this test be performed on a regular service route. However, the location should be selected so that the route is suited for speed trials during off peak times, such as late evenings. It would be desirable to select a route where coaches can be specifically assigned, so that the vehicular components of the system may be tested as well as the wire fittings. This test should determine if there is sufficient speed advantage to the K&M wire system to warrant its use.

If the results of the first two steps indicate that there is a need for greater speed capability than can be provided by existing wire support systems, then a program of developing overhead wire concepts should be undertaken. This would include a review of current collection technology for other applications, primarily rail systems, to determine if there are any applicable techniques. In addition, a conceptual analysis of potential means of supplying current to trolley coaches would be part of this step. Wire system concepts thus developed may appear promising enough to warrant the construction and test of prototypes. If this is the case, then prototypes should be fabricated and a suitable test location be obtained that is not part of a regular service route. After such tests, it may be desirable to go through an in service test on a route that is suited to high speed operation.

Propulsion Control Systems

Problem

Two propulsion control systems have recently been developed for trolley coaches. These are the chopper and pulse width modulation (PWM) control. Both systems apparently offer reductions in energy consumption. In addition, PWM control offers a potential savings in traction motor cost and size. However, it is not known whether these savings are sufficient to justify development costs, as well as possible increased purchase and maintenance costs.

Solutions

Further in-service testing and development of these concepts is required before either becomes a new standard for trolley coaches.

Background

Chopper control has been extensively tested, and is being used on the production vehicles for Seattle and Philadelphia. Experience with these fleets will be sufficient to determine its advantages and disadvantages. PWM control requires further development and testing, existing today in prototype form only.

Summary of Research Efforts Required

- o Evaluate Seattle and Philadelphia in-service experience with chopper control.
- o Review current PWM control experience, in order to determine advantages and disadvantages of this type of control.
- o Develop and test, if warranted, PWM control package for trolley coaches.

Detailed Research Description

The first step would be to document in-service experience with the chopper control being installed on the Seattle and Philadelphia vehicles. This experience should also determine the need for design modifications, if any, to reduce maintenance. As a result, the relative value of contactor and chopper control could be estimated, based on the tradeoffs between power consumption, maintenance and initial cost and weight differentials.

The next step would be to review current experience with PWM control. This should include an assessment in power consumption, weight, initial cost and maintenance relative to both chopper and contactor control. As part of this review, an estimate of the effort required to develop a motor and control package for trolley coaches should be made. This estimate would include several variables, including the use of dynamic, regenerative or eddy current braking and the use of a currently available traction motor as opposed to designing a new motor.

If one or more PWM control configurations appear promising, prototypes should be constructed and used in test facilities and also tested in service. The tests should be designed to verify the advantages and disadvantages of various PWM control configurations as well as to identify design problems. Comparisons would be made with chopper and contactor control.

Routing Control

Problem

Present means of switch control require driver activation and may not be capable of handling complex intersections reliably.

Solution

Utilize automatic routing and control of switches. Automatic route selection has been tested but is not a proven system.

Background

Seattle and Philadelphia, as well as several European systems, have had to replace switch control systems as a result of conversion to chopper controlled vehicles. Present radio frequency switch control systems are driver actuated through the turn signal control. Automatic route selection is possible with a radio frequency system, but experiments to date have not been fully satisfactory.

Summary of Research Efforts Required

- o Review need for automatic route selection.
- o If needed, develop route selection system.

Detailed Research Description

The first step would be to review experience of systems using manually actuated radio frequency route selection control. The particular problem to be examined is the occurrence of misroutings at complex intersections, and thus the adequacy of manually controlled systems to route vehicles in complex situations. Initially, operating experience should be documented based on the observations of supervisory personnel. This information may need to be supplemented by field observation at complex intersections, noting both misroutings, and delays at these locations due to routing control problems.

If routing control problems are found to exist, then the second step in the process, development and testing of an automatic route selection system should be undertaken. Initially, European experience with the system designed by Kummeler and Matter should be examined in order to determine its advantages and disadvantages. This examination should indicate if this system performs satisfactorily, or if modifications or a different approach may be needed. If either a different system or major modifications in the K&M system are found to be desirable, then a design effort should be undertaken. A service test program should be included for any new or modified design.

Passenger Preference

Problem

Is there any measurable preference among transit users for trolley coaches, as has been claimed by some proponents of this type of transit equipment?

Solution

Measure passenger behavior and attitudes in situations where trolley coaches and motor coaches are directly comparable.

Background

This problem is different from the others described in this section in that it is not intended to solve a technical problem. Rather, it is intended to obtain information as to whether or not there is a non-technical advantage to trolley coaches, in that users find this type of transit service to be more attractive than other types. Proponents of trolley coaches have claimed that this is the case, however, most evidence dates from the 1930's and 1940's. This evidence also is based on comparisons between new (at the time) trolley coaches and 30 to 40 year old street cars. It should also be noted that similar results were obtained when PCC cars replaced older street railway equipment. Thus, any current study should be designed to compare recent design trolley coaches with motor coaches that are similar in age and condition.

Summary of Research Efforts Required

- o Locate a situation where trolley coaches will replace motor coaches on the same route.
- o Perform detailed usage measurements and attitude surveys to determine effect of change in vehicle type.

Detailed Research Description

Locate a situation where trolley coaches will replace motor coaches on one or more routes. This situation may be either a restoration of trolley coach service that has been discontinued for a substantial time period, as in Seattle, or it may be new trolley coach routes, as are proposed in San Francisco. The test location should preferably be one where the vehicle type change is the only variable, i.e., there should be no rerouting or substantial change in headways accompanying the vehicle type change.

Design and perform usage measurements and user surveys to determine the extent of usage changes resulting from the vehicle type change, and the reasons for such changes, if any.

The study should be designed to collect and analyze the following data:

- o Detailed usage statistics on the affected routes and on adjacent routes.
- o "Before" and "after" information on specific users, in order to determine the amount of change in transit use as opposed to other modes; the effect of the change on selection of transit route; the extent to which any changes are due to the change in vehicle type or are the result of exogenous factors; and the attributes of each vehicle type that affect user behavior, if any.

