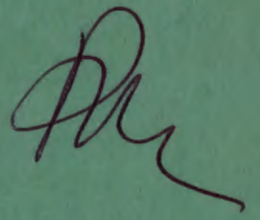


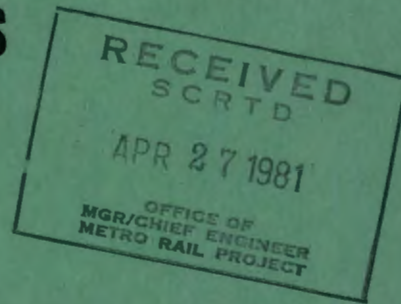
S.C.R.T.D. LIBRARY



REPORT NO. FHWA-TS-80-221

# SLURRY WALLS FOR UNDERGROUND TRANSPORTATION FACILITIES

PROCEEDINGS OF A SYMPOSIUM  
HELD AUGUST 30-31, 1979  
AT CAMBRIDGE, MASSACHUSETTS



MARCH 1980  
FINAL REPORT

SPONSORED BY:



U.S. DEPARTMENT OF TRANSPORTATION  
FEDERAL HIGHWAY ADMINISTRATION  
WASHINGTON, D.C. 20590



#### NOTICE

This document is disseminated under the sponsorship of the Department of Transportation in the interest of information exchange. The United States Government assumes no liability for its contents or use thereof.

The contents of this report reflect the views of the Office of Development of the Federal Highway Administration, which is responsible for the facts and the accuracy of the data presented herein. The contents do not necessarily reflect the official views or policy of the Department of Transportation.

This report does not constitute a standard, specification, or regulation.

The United States Government does not endorse products or manufacturers. Trade or manufacturers' names appear herein only because they are considered essential to the object of this document.

PROCEEDINGS FROM THE  
SYMPOSIUM ON  
DESIGN & CONSTRUCTION  
OF  
SLURRY WALLS  
AS  
AS PART OF PERMANENT STRUCTURES

March, 1980

Submitted to:

John M. Hooks  
Federal Highway Administration  
Washington, D.C. 20590

Compiled and Produced by:

CHI ASSOCIATES, INC.  
956 N. Monroe Street  
Arlington, VA 22201  
B. Dennis, Editor



05971

TF  
232  
.S95

|   |  |  |           |
|---|--|--|-----------|
| 1. Report No.<br>FHWA-TS-80-221   | 2. Government Accession No.                          | 3. Recipient's Catalog No.   |           |
| 4. Title and Subtitle<br>Slurry Walls for Underground Transportation Facilities   |  | 5. Report Date<br>March 1980   |           |
|   |  | 6. Performing Organization Code  |           |
| 7. Author(s) Compiled and produced by CHI ASSOCIATES, INC.,<br>B. Dennis, editor  |  | 8. Performing Organization Report No.  |           |
| 9. Performing Organization Name and Address<br>Chi Associates, Inc.<br>956 N. Monroe Street<br>Arlington, Virginia 22201  |  | 10. Work Unit No. (TRAIS)  |           |
|   |  | 11. Contract or Grant No.<br>DOT-FH-11-9505  |           |
| 12. Sponsoring Agency Name and Address<br>Federal Highway Administration<br>U.S. Department of Transportation<br>Washington, D.C.   |  | 13. Type of Report and Period Covered  |           |
|   |  | 14. Sponsoring Agency Code   |           |
| 15. Supplementary Notes   |  |  |           |
| 16. Abstract<br><p>This volume contains the papers of the 20 speakers who addressed the topic of Slurry Walls at the Symposium sponsored by the Federal Highway Administration. The symposium was held at the Hyatt Regency Hotel in Cambridge, Massachusetts on August 30 &amp; 31, 1979. The papers provide a thorough coverage of the design, construction, economics, geotechnical, instrumentation, economic, and legal aspects of the technique as well as pertinent examples of its application at sites around the world.</p> |  |  |           |
| 17. Key Words<br>Slurry walls, cut and cover tunneling  |  | 18. Distribution Statement<br>No restrictions - Document is available to the U.S. Public through the National Technical Information Service, Springfield, Virginia 22161 |           |
| 19. Security Classif. (of this report)<br>Unclassified  | 20. Security Classif. (of this page)<br>Unclassified | 21. No. of Pages<br>414  | 22. Price |

## METRIC CONVERSION FACTORS

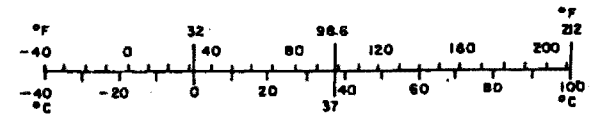
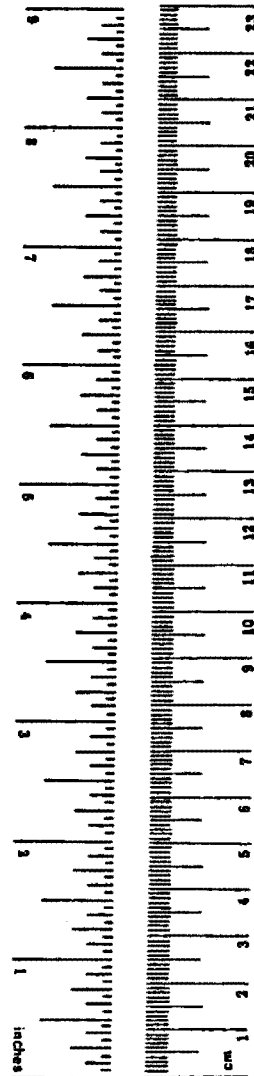
### Approximate Conversions to Metric Measures

| Symbol                     | When You Know           | Multiply by                | To Find             | Symbol          |
|----------------------------|-------------------------|----------------------------|---------------------|-----------------|
| <b>LENGTH</b>              |                         |                            |                     |                 |
| in                         | inches                  | *2.5                       | centimeters         | cm              |
| ft                         | feet                    | 30                         | centimeters         | cm              |
| yd                         | yards                   | 0.9                        | meters              | m               |
| mi                         | miles                   | 1.6                        | kilometers          | km              |
| <b>AREA</b>                |                         |                            |                     |                 |
| in <sup>2</sup>            | square inches           | 6.5                        | square centimeters  | cm <sup>2</sup> |
| ft <sup>2</sup>            | square feet             | 0.09                       | square meters       | m <sup>2</sup>  |
| yd <sup>2</sup>            | square yards            | 0.8                        | square meters       | m <sup>2</sup>  |
| mi <sup>2</sup>            | square miles            | 2.6                        | square kilometers   | km <sup>2</sup> |
|                            | acres                   | 0.4                        | hectares            | ha              |
| <b>MASS (weight)</b>       |                         |                            |                     |                 |
| oz                         | ounces                  | 28                         | grams               | g               |
| lb                         | pounds                  | 0.45                       | kilograms           | kg              |
|                            | short tons<br>(2000 lb) | 0.9                        | tonnes              | t               |
| <b>VOLUME</b>              |                         |                            |                     |                 |
| tsp                        | teaspoons               | 5                          | milliliters         | ml              |
| Tbsp                       | tablespoons             | 15                         | milliliters         | ml              |
| fl oz                      | fluid ounces            | 30                         | milliliters         | ml              |
| c                          | cups                    | 0.24                       | liters              | l               |
| pt                         | pints                   | 0.47                       | liters              | l               |
| qt                         | quarts                  | 0.95                       | liters              | l               |
| gal                        | gallons                 | 3.8                        | liters              | l               |
| ft <sup>3</sup>            | cubic feet              | 0.03                       | cubic meters        | m <sup>3</sup>  |
| yd <sup>3</sup>            | cubic yards             | 0.76                       | cubic meters        | m <sup>3</sup>  |
| <b>TEMPERATURE (exact)</b> |                         |                            |                     |                 |
| °F                         | Fahrenheit temperature  | 5/9 (after subtracting 32) | Celsius temperature | °C              |

\* 1 in = 2.54 (exactly). For other exact conversions and more detailed tables, see NBS Misc. Publ. 296, Units of Weights and Measures, Price \$2.25, SO Catalog No. C13.10:286.

### Approximate Conversions from Metric Measures

| Symbol                     | When You Know                     | Multiply by       | To Find                | Symbol          |
|----------------------------|-----------------------------------|-------------------|------------------------|-----------------|
| <b>LENGTH</b>              |                                   |                   |                        |                 |
| mm                         | millimeters                       | 0.04              | inches                 | in              |
| cm                         | centimeters                       | 0.4               | inches                 | in              |
| m                          | meters                            | 3.3               | feet                   | ft              |
| m                          | meters                            | 1.1               | yards                  | yd              |
| km                         | kilometers                        | 0.6               | miles                  | mi              |
| <b>AREA</b>                |                                   |                   |                        |                 |
| cm <sup>2</sup>            | square centimeters                | 0.16              | square inches          | in <sup>2</sup> |
| m <sup>2</sup>             | square meters                     | 1.2               | square yards           | yd <sup>2</sup> |
| km <sup>2</sup>            | square kilometers                 | 0.4               | square miles           | mi <sup>2</sup> |
| ha                         | hectares (10,000 m <sup>2</sup> ) | 2.5               | acres                  |                 |
| <b>MASS (weight)</b>       |                                   |                   |                        |                 |
| g                          | grams                             | 0.035             | ounces                 | oz              |
| kg                         | kilograms                         | 2.2               | pounds                 | lb              |
| t                          | tonnes (1000 kg)                  | 1.1               | short tons             |                 |
| <b>VOLUME</b>              |                                   |                   |                        |                 |
| ml                         | milliliters                       | 0.03              | fluid ounces           | fl oz           |
| l                          | liters                            | 2.1               | pints                  | pt              |
| l                          | liters                            | 1.06              | quarts                 | qt              |
| l                          | liters                            | 0.26              | gallons                | gal             |
| m <sup>3</sup>             | cubic meters                      | 35                | cubic feet             | ft <sup>3</sup> |
| m <sup>3</sup>             | cubic meters                      | 1.3               | cubic yards            | yd <sup>3</sup> |
| <b>TEMPERATURE (exact)</b> |                                   |                   |                        |                 |
| °C                         | Celsius temperature               | 9/5 (then add 32) | Fahrenheit temperature | °F              |



## METRIC CONVERSION FACTORS

## INTRODUCTION

In October 1979 the Federal Highway Administration awarded a contract\* to the engineering consulting firm CHI Associates, Inc. for the purpose of determining the advantages of using Slurry Walls as a permanent part of underground transportation structures. In order to help acquaint engineers, architects and contractors in the United States with the advantages and experience gained to date of the use Slurry Walls, one task of the contract called for the planning and presentation of a two day symposium to address:

THE USE OF SLURRY WALLS AS AN INTEGRAL PART OF THE FINAL STRUCTURE FOR UNDERGROUND TRANSPORTATION FACILITIES.

The two day symposium was held in the beautiful Hyatt Regency Hotel in Cambridge, Massachusetts on August 30 & 31, 1979. The unequalled list of 20 expert speakers and topics was the main factor that drew over 300 people interested in Slurry Wall design and application from around the world. Many more requests were received for the published proceedings.

In this document the papers of the distinguished speakers have been assembled. Following several of the papers, important questions and answers that arose during the Symposium have been presented as transcribed from the audio tapes made of the Symposium.

---

\* Contract No. DOT-FH-11-9505



## ACKNOWLEDGEMENTS

CHI Associates, Inc. would like to thank the following people for their tremendous assistance in the planning and backing of the Symposium.

Our Contract Board of Consultants

Jerome Iffland - Iffland Kavanagh Waterbury, P.C.

Dominique Namy - Soletanche & Rodio, Inc.

George Tamaro - ICOS Corporation of America

Petros Xanthakos - Consulting Engineer

Our Contract Managers

John Hooks - Federal Highway Administration

Roger Sinha - Federal Highway Administration

Certainly a report of this magnitude could not easily be compiled by one person. The editor greatly appreciates the efforts of the many members of CHI ASSOCIATES, INC. who contributed their time and efforts to the compilation of this report. In addition, special appreciation is extended to John M. Hooks for this patience throughout the project and to the authors of the enclosed papers who made the symposium and this volume such a huge success.

TABLE OF CONTENTS

Thursday, August 30, 1979

|  |     |
|--|-----|
| OPENING REMARKS.....   | 5   |
| <i>John M. Hooks - Federal Highway Administration</i>  |     |
| REVIEW OF FINDINGS OF A RECENT ON SITE STUDY OF SLURRY WALL PRACTICE<br>IN EUROPE.....                                 | 8   |
| <i>John M. Hooks - Federal Highway Administration</i>  |     |
| CRITICAL ASSESSMENT OF SLURRY WALL CONSTRUCTION IN THE UNITED STATES.....  | 20  |
| <i>Thomas J. Regan, Jr. - Sverdrup &amp; Parcel and Associates, Inc.</i>   |     |
| DESIGN OF SLURRY WALLS AS PART OF PERMANENT STRUCTURES.....  | 31  |
| <i>Jerome S. B. Iffland - Iffland Kavanagh Waterbury, P.C.</i>   |     |
| SITE CONDITIONS SPECIFIC TO SLURRY WALL CONSTRUCTION.....  | 56  |
| <i>Dominique Namy - Soletanche &amp; Rodio, Inc.</i>   |     |
| SLURRY WALL CONSTRUCTION, CONSTRUCTION PROCEDURES AND PROBLEMS.....  | 80  |
| <i>George Tamaro - ICOS Corporation of America</i>   |     |
| GEOTECHNICAL ASPECTS OF SLURRY WALL DESIGN AND CONSTRUCTION.....   | 96  |
| <i>Donald T. Goldberg - Goldberg, Zoino, Dunnycliff &amp; Associates, Inc.</i>   |     |
| DEFORMATIONS AND EARTH PRESSURES - EXCAVATION WALL SYSTEMS.....  | 114 |
| <i>G. Wayne Clough - Stanford University</i>   |     |
| SLURRY WALL CONSTRUCTION FOR TRANSPORTATION SYSTEMS IN BRITAIN.....  | 138 |
| <i>David G. Jobling - London Transport</i>   |     |
| CHARLES CENTER STATION, BALTIMORE RAPID TRANSIT SYSTEM SLURRY WALL DESIGN<br>AND INSTALLATION.....                     | 160 |
| <i>Ugo Piccagli - Bencor Corporation of America</i><br><i>Drupad B. Desai - Daniel, Mann, Johnson &amp; Mendenhall</i> |     |
| RESEARCH DESIGN STUDY ON THE USE OF SLURRY WALLS AS PERMANENT STRUCTURES<br>IN TRANSPORTATION FACILITIES.....          | 180 |
| <i>Mehmet Basci &amp; Bernard G. Dennis - Chi Associates, Inc.</i>   |     |

Friday, August 31, 1979

|  |     |
|--|-----|
| PERFORMANCE MONITORING OF SLURRY WALL CONSTRUCTION.....  | 197 |
| <i>John Dunicliff - Geotechnical Instrumentation Consultant</i>  |     |
| UNIQUE ASPECTS AND REQUIREMENTS IN THE MASSACHUSETTS BAY TRANSIT AUTHORITY'S<br>RED LINE EXTENSION - NORTHWEST IN CAMBRIDGE AND SOMERVILLE, MASSACHUSETTS .. | 221 |
| <i>Eugene J. Perko - Sverdrup &amp; Parcel and Associates, Inc.</i>  |     |
| STRUCTURAL CONNECTIONS IN SLURRY WALLS.....  | 249 |
| <i>Petros P. Xanthakos - Petros P. Xanthakos, LTD.- Consulting Engineers</i>   |     |
| ECONOMIC CONSIDERATIONS IN SLURRY WALL APPLICATIONS.....   | 271 |
| <i>Arturo L. Ressi di Cervia - ICOS Corporation of America</i>   |     |
| LEGAL ASPECTS OF SLURRY WALL CONSTRUCTION.....   | 282 |
| <i>Louis Cantor - Greenberg, Trayman, Cantor, Reiss &amp; Blasky, Attorneys<br/>At Law</i>   |     |
| INNOVATIONS IN SLURRY WALL TECHNIQUES, DESIGN AND CONSTRUCTION - THE POST-<br>TENSIONED DIAPHRAGM WALL .....   | 294 |
| <i>Martin Fuchsberger - ICOS, Great Britain, LTD.</i>  |     |
| USE OF SLURRY WALLS IN LIEU OF UNDERPINNING.....   | 315 |
| <i>Kenneth R. Ware, Robert N. Evans, James G. Beck - Bechtel, Inc.</i>   |     |
| DIAPHRAGM WALL EXPERIENCES IN JAPAN.....   | 348 |
| <i>Seiken Fukui - Tokyo Metropolitan Government</i>  |     |
| EXPERIENCE WITH SLURRY WALLS IN SOFT CLAY.....   | 383 |
| <i>Kjell Karlsrud, Elmo Dibiagio, Gunnar Aas - Norwegian Geotechnical<br/>Institute</i>  |     |
| FUTURE RESEARCH.....   | 409 |
| <i>Donald A. Linger - Federal Highway Administration</i>   |     |

## SYMPOSIUM

ON

### THE USE OF SLURRY WALLS AS AN INTEGRAL PART OF THE FINAL STRUCTURE FOR UNDERGROUND TRANSPORTATION FACILITIES

JOHN M. HOOKS  
FEDERAL HIGHWAY ADMINISTRATION  
WASHINGTON, D.C.

#### OPENING REMARKS

I'd like to begin with some welcoming remarks that are germane to the purpose of this symposium. We are talking about design and construction of transportation facilities; we are very concerned with the application of slurry walls in this type of construction and specifically we'd like to see more slurry walls incorporated in the permanent structure in those underground transportation facilities. And if you'll pardon the very inexcusable pun, it's a deep subject and it has many interesting facets. When I look over the agenda which we have assembled over the last few months, I'm convinced that we have incorporated all of the important aspects of slurry wall construction and I think we have gathered a pretty good list of speakers to address those topics, and I must admit I'm very pleased with the response and the attendance at this symposium. I think it speaks well of the interest in the topic; I think it speaks well of the quality of the program; and I think it speaks very well of the capabilities and reputation of the speakers. I understand that as of last night there were 115 people registered. This morning, from the opening of registration at 8:00 o'clock right up until 9:15, when we had to cut off and get under way, there was a line waiting to register. There are supposedly 300 seats in the room and there are not very many empty. I have noticed over the past several months favorable response not only from the local Boston area and not only from the United States nationwide, but from Canada, South America, France, United Kingdom, and even as far away as Thailand and Nigeria. I don't know that anyone has shown up from Thailand, but we certainly did have requests for copies of the proceedings. I know that contractors, consulting engineering firms, public government agencies, and the academic world are represented here today and I am convinced of the merit of our topics when I reflect on the fair response that we've had to our symposium. And before I continue, I think this is a good opportunity to acknowledge the very fine work in planning, organizing, and conducting this symposium that has been accomplished by Dr. Chi and CHI ASSOCIATES. I know that quite a bit of the burden rested on the shoulders of Bernie Dennis and he's done a whale of a job putting this symposium together and getting us off on the right foot. He's also been very ably assisted in the development of the program by a Board of Consultants consisting of Jerry Iffland, George Tamaro, Dominique Namy, and Petros Xanthakos, all of whom you'll hear from later on in the program.



The Department of Transportation and the Federal Highway Administration have an active and comprehensive R&D program in the field of transportation tunneling under way at the very moment. Cut and Cover Tunneling is one of the aspects of the R&D program, and within that task there is a fair amount of work devoted to the topic of slurry trench construction for underground walls. One of the active R&D projects that is under way right now is the project being done by CHI ASSOCIATES. The payoff from this project is expected to be recommendations and procedures for incorporating a slurry wall into permanent underground structures. This symposium was included in the research and development effort of CHI ASSOCIATES to provide a forum for discussion of the latest thinking on the construction of slurry walls and the incorporation of slurry walls in the final structure. In order to insure a wide dissemination of the findings of this meeting, we intend to publish proceedings of the conference and make them available to anyone who desires a copy. When the symposium brochure was mailed out, there was a card attached to it, and all that is required to receive a copy of the proceedings is to fill it out and mail it to the Federal Highway Administration in Washington. It is already addressed to FHWA, and copies of the proceedings will be mailed out later this year or early in calendar year 1980.

When I was first asked to give this talk, my topic was noted as welcoming remarks and keynote speech. Well, welcoming remarks are self-explanatory, but I had to check with my friend Webster to find out what a keynote speech was and what type of an approach I should take. Well, my friend Webster tells me that a keynote is a basic idea or ruling principle, and that a keynote speech is a talk which sets forth the basic idea or line of policy. Now I think mostly of keynote speeches in terms of political conventions, when some firebrand speaker whips the convention delegates into a frenzy and sends them home convinced beyond a shadow of a doubt that tomorrow they could elect a donkey to the premiership of the Soviet Union, or maybe an elephant to the presidency of West Germany. Well I don't very often breathe fire and brimstone and I'm sure that I won't send you away from here feverishly looking for your nearest bentonite store or your nearest clam shell outlet. I'm sure I won't even send you away from here firmly convinced that you should go home and build your next house with a slurry trench wall foundation even though it probably would be one of the safest and driest cellars in town. But, on the other hand, I would like to state in very basic terms what the principle behind our efforts of these next couple of days is.

We in the Federal Highway Administration contend that slurry walls technology is very underutilized in the United States today. Certainly figures are very hard to quote because job conditions change from site to site, but we are convinced that a savings in cost and a savings in time are possible if slurry wall technology is adopted carefully. We believe that there is a significant payoff to be realized by promoting the use of slurry walls on selected projects. Now that is an important point. We don't fool ourselves that slurry wall technology is applicable to every job site, be it an underground transportation facility or an

underground building, or whatever. But we do believe that slurry wall technology should be a prime alternate for consideration whenever deep excavation is planned, whenever a cutoff wall is desired, or whenever temporary or permanent ground support or reinforcement is necessary. And more specifically, we contend that slurry wall technology is underutilized as a permanent part of underground structures such as tunnel sections, foundations for buildings or parking garages. This is where we think the greatest economies lie. I believe that this program that we've put together today and this group of speakers will generally, I say generally, support this theme. Certainly they will raise questions and they will raise questions in your mind, and some of them will give negative thoughts on the subject; but they will at least send you away from here with food for thought and with perhaps a little bit more appreciation of how applicable this slurry wall technology is to some of the construction projects that we see here in the States.

REVIEW OF FINDINGS OF A RECENT ON SITE STUDY OF  
SLURRY WALL PRACTICE IN EUROPE

by

JOHN M. HOOKS  
FEDERAL HIGHWAY ADMINISTRATION  
WASHINGTON, D. C.

ABSTRACT

Use of slurry trench walls (or diaphragm walls) is a common practice in Great Britain and Western Europe. Cut-and-cover tunnels, building basements, highway retaining walls, and cut-off walls are routinely designed and built using the slurry trench procedure. The walls are often incorporated in the final structure, sometimes in the form of precast panels. Slurry wall activity in the United Kingdom and Europe has been intense for years while in the United States, the adoption of the slurry wall technique has been slow.

In late 1978, the Federal Highway Administration requested the International Road Federation (IRF) to explore the reasons behind the lag in adoption of slurry wall practice. A study team of 2 FHWA engineers, 2 State highway engineers, 2 consulting engineers and 1 slurry wall contractor was formed. The IRF, in consultation with the study team, planned and organized a 2½-week on-site review of slurry wall practice in the United Kingdom and Europe. Great Britain, France, Italy, Germany and Belgium were visited. Government officials, design engineers, and contractors were interviewed concerning the various aspects of slurry wall design and construction. Active construction sites and completed projects were inspected. A report on the findings of the review trip will be published by IRF.

## REVIEW OF FINDINGS OF A RECENT ON-SITE STUDY OF SLURRY WALL PRACTICE IN EUROPE

It was readily apparent, and it is readily apparent to us that the Europeans make much greater use of slurry wall technology than we do here in the United States. It also seems to be the case with a number of innovative techniques such as reinforced earth, permanent ground anchors, and segmental bridge construction. The question is "Why?". Do others recognize such a good thing while we are relatively blind or perhaps dogmatic in our thinking?

In order to explore that question from one angle, the Federal Highway Administration asked the International Road Federation to conduct a study of current practice in Europe with regard to slurry wall construction and to prepare a report summarizing the findings.

This effort was not to be a long and comprehensive paper study of what is being done over in Europe now, a study of theoretical considerations. We didn't have the wherewithal to fund a large study, but rather we focused on a short, concentrated effort relying on face-to-face meetings with the people who design slurry walls, the people who build them, and the people who own them. And we also relied on a series of site inspections to dig up as much detailed information as possible in a very short period of time.

With that idea in mind, a study team was organized by the International Road Federation. It included representation from state transportation agencies, the Federal Highway Administration, consulting engineering firms, and contracting firms from the slurry wall portion of the contracting world. The study team ultimately numbered seven, with two state transportation officials, two Federal Highway officials, two design engineers from consulting engineering firms, and one slurry wall contractor. The overall objective of the review was to develop as comprehensive a picture as possible in a very short amount of time of the current state of the practice of slurry wall technology in Western Europe. We don't contend that there are no other places in the world where slurry wall technology has been used extensively and has been developed to a fine state of the practice, but the itinerary was limited to Western Europe due to time and funding. The itinerary was initially established and finally refined, based on the amount of either active or completed slurry wall construction projects which would be available for discussion or on-site review. The International Road Federation organized the details of the itinerary with the help of the local government agencies and with the very willing cooperation of the major slurry wall contractors who operate on the European continent and in the United Kingdom.

The final itinerary covered:

|         |         |
|---------|---------|
| England | Germany |
| France  | Belgium |
| Italy   |         |



and it represented a difficult balance between trying to learn as much as we possibly could and trying to face up to the limitations we had on time, money, and human energy. As it turned out, the trip lasted almost three weeks, it covered an awful lot of ground, and we saw probably more slurry wall sites than we might ever want to see in our life. We met and had some detailed discussions with a wide variety of engineers from government agencies and from contracting firms, and we accumulated as much information as we possibly could in two and a half weeks. It would be almost impossible for me to cover everything we saw over there and I don't intend to do that. We are in the process of putting together a comprehensive report on our findings. It will be detailed in nature as to what type of sites we saw, and it will be fairly detailed in nature as to our conclusions on the status of slurry walls in Europe. It will include some recommendations on our part as to what we feel might be necessary to promote slurry wall technology here in the States.

So over that last half of this talk, I'd like to share with you a few of the highlights of what we saw during our study trip and then invite you to review our final report when it is available early in calendar year 1980.

The intent of our study was to review slurry wall technology in five major elements and to investigate the European practice in each one of those elements. We broke our responsibilities down into:

- Site investigation
- Design procedures and design considerations
- Contracting practices
- Construction procedures and problems
- Construction monitoring and instrumentation

Again, our objective was to investigate as thoroughly as possible the European practice with regard to those elements, to compare them as to what we find here in this country, to learn from their experiences, and perhaps come back and make some recommendations and ultimately to effect some changes in our practice to further the use of slurry wall technology in this country.

We really did not expect to find any great surprises, nor did we find any, with the exception of a bit of disappointment in the scope of site investigation efforts on the average project and in the efforts of monitoring the construction of the wall and monitoring the performance of the wall after its completion.

This may have been and in fact probably was, a result of our own expectations more than any shortcomings in the European approach to building slurry walls. We did expect to find quite a few variations from country to country, and we did, mostly in the contracting practices

that were used in offering a potential slurry wall site for bid, accepting bids, and contracting with the ultimate general contractor and the specialty contractor, if such were the case. Most of that will be covered in the report, and I won't really get into that now. But one general impression that I had while I was there, and it has not been dispelled since, is that slurry wall technology is almost always given prime consideration in the engineering design of underground facilities in Europe. That is not nearly as often, and practically is never the case, here in the United States where slurry walls are often relegated to the position of a last resort when a problem crops up or when nothing else will seem to solve the problem. There are probably a lot of reasons for that, and one of them is the predominance of the qualified slurry wall contractors in Europe; not that we do not have qualified specialty contractors here in this country, but the practice has been built up over a much longer span of time and it has become routine to consider slurry walls as a possibility for deep excavations or cutoff walls.

Following are some photographs from our study trip and I'll caution you on one thing. I found out right away that it is very difficult to take good pictures of a slurry wall site. That's kind of an excuse, I'm sure, but the only good opportunity you get to see a slurry wall site is after the wall is built and the excavation is complete, prior to completion of the underground structure. So during the construction procedure, you don't see anything. It's underground and after it's all done, there really isn't much to see unless you can get inside it, and the slurry wall itself is exposed in the final structure.

So I have selected a few photographs from the hundreds that were taken, and I'm going to use them to try and illustrate either a point or a particular application that we saw during our study trip.

Figure 1 shows the interior of the YMCA building in London on one of the lower parking floors below the original ground surface. The slurry wall technique was used in the construction of the underground parking garage, and this figure obviously illustrates the group's fearless leader examining the surface texture of the wall where you can easily see some variations in the surface texture. It's obviously no comparison to a formed concrete wall, but in the basement of an underground parking garage where the light is dim, is it really necessary to have an aesthetically pleasing concrete wall? Many people would contend it's not, and I am firmly in favor of that idea, that where it is not necessary, it doesn't make any sense to go to an aesthetically pleasing surface condition on the wall.

Figure 2 shows the EMI Building in London, and the foundation here was built with the slurry wall technique. The point to be made here is that by beginning with the construction of the foundation wall by the slurry wall technique, the subsequent construction could proceed both up and down at the same time. The underground parking levels were being constructed at the same time as the building rose from the surface, saving probably a considerable amount of time in the overall time for completion of the building.

Figure 3 shows a depressed section for the A-6 motorway near Manchester, England. It was one of the few sites where we encountered a slurry wall which was incorporated into a highway project and, being from the Federal Highway Administration, I was quite interested in this and one other that came later on. The highway was built on new alignment, so the advantage of the slurry wall is not immediately evident. However, once the slurry wall was constructed, it was immediately possible to construct the roadway slabs or the pedestrian walkway slabs for those cross-structures and reroute traffic and carry traffic across the new alignment of the crossroads while the excavation for the main line then proceeded under-the-roof, so to speak. And of course the slurry wall was, in this case, a cast-in-place wall, so a brick surface was put on the wall for aesthetic purposes.

Figure 4 is a picture of work at a Paris Metro site. The point I wanted to illustrate here, and it may not be very apparent, is that this new subway line is approaching an existing surface rail line at a very acute angle, and therefore much of the line construction of the new subway is very, very close to the existing rail line. The narrow confines of the working zone and the need to maintain the surface rail traffic, are severely aggravated by the existence of electrical lines for the surface railroad (upper portion of Figure 4 is not very visible). So you're working with a crane boom and a clam shell with a lot of metal right close to live electrical lines.

Figure 5 is another Paris Metro site, and the point I wanted to make here is that this is one of the cases where we saw precast panels being used as part of the slurry wall, and that rubber diaphragm at the end of the precast panel is the water stop for prevention of leakage through the wall.

Figure 6 is another view of the same Metro construction site, and the point to be illustrated here is that in many of the cases we saw, the confines of the working area between building line to building line are probably much narrower than we would run into in this country. In this particular case, there was no maintenance of traffic through the site, so that was not a problem.

Figure 7 is another view of the same Metro site. This construction site was almost a gold mine because at the time we were there, several of the stages of the slurry wall in the tunnel construction were visible, from the construction of the wall itself to this point where the roof slab of the tunnel section is being poured. You can see the bars coming out from the precast panels for tie-in with the roof slab of the tunnel section, and then a little farther down the line, backfill had been completed and traffic was back on the new tunnel alignment. With the procedure they had here, the waterproofing, the backfill, and the street restoration were not dependent upon the excavation of the tunnel alignment itself. The excavation here was carried out under the roof.

Figure 8 is a construction site in Milan, and again the lateral clearances were not quite so restrictive. The traffic was utilizing this street, in a manner of speaking. There was no traffic control in terms of flagmen, but traffic was allowed through this section while the construction was going on.

Same site, Figure 9 shows a car turning onto the street, and the driver was totally under his own control as to how he was going to avoid all the construction equipment.

There was an oil refinery (see Figure 10) that was polluting underground water, and the water was flowing into a fish hatchery at the bottom of the hill. The solution was to build a slurry wall that cut off the flow of water and allowed a weir type of action where the contaminated water flowed over the wall into a trench and was carried to a basin, and from there was pumped back into the fish hatchery clean, while the pollutants--gasoline and oils--were extracted and probably thrown back into the refinery process.

A pretty comprehensive series of diaphragm walls for perimeters and load-bearing elements were built by the slurry method in several shapes. Some are round, some rectangular, and some of them were cross-shaped. Figure 11 shows the perimeter wall for a portion of that power plant.

Figure 12 shows one of the load-bearing elements with grout pipes for grouting the limestone at the base of the load-bearing element.

Figure 13 shows an ancient church that was severely damaged by an earthquake in 1976. The decision was made to try to restore that church to its original condition. Well, one of the first steps was to build a slurry wall at the base of the church between an old hospital and the church to prevent any further lateral movement of the foundation of the church (Figure 14).

Following are two pictures of what we found in Berlin. The Germans were very high on the technique they call the invert wall method. They built the slurry wall, braced it with either cross-bracing (Figure 15) or tie-backs (Figure 16) as the excavation proceeded to the invert depths, and then they poured a tremie-seal invert slab which sealed the excavation off from any further infiltration of water. Then the water was pumped out and a tunnel section was built inside that slurry wall. In that particular case, that slurry wall was not incorporated in the final structure. The tunnel section itself was a complete box section on its own.

Figure 17 shows some drawings of one of the very few highway tunnel sections we saw during our trip. It is in Antwerp, and this is the opening of the highway tunnel section.

The trip lasted about three weeks. It was a fast itinerary and it was jammed with many site visits, many interviews, and many technical discussions, and our report is going to provide full details on our findings.



Just to show that the trip was not all hard work, Figure 18 shows the group relaxing after a hard day at Rolandsbogen high above the Rhine River in Germany.

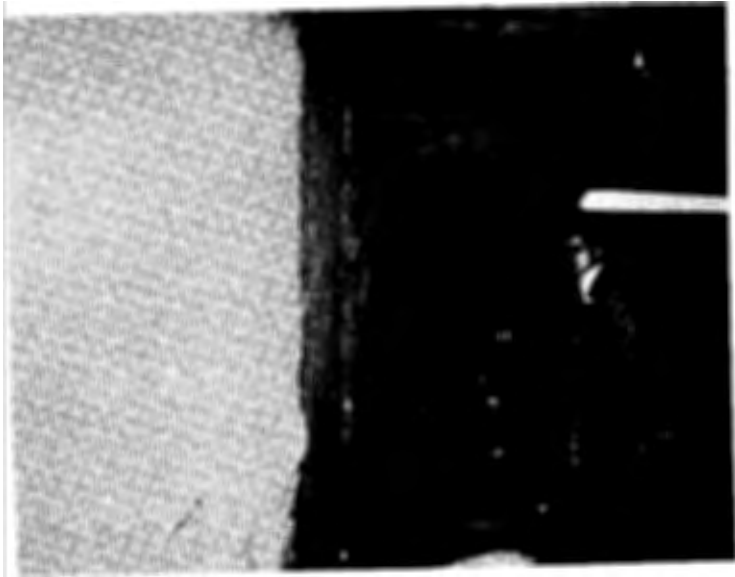


FIGURE 1



FIGURE 2



FIGURE 3



FIGURE 4



FIGURE 5



FIGURE 6

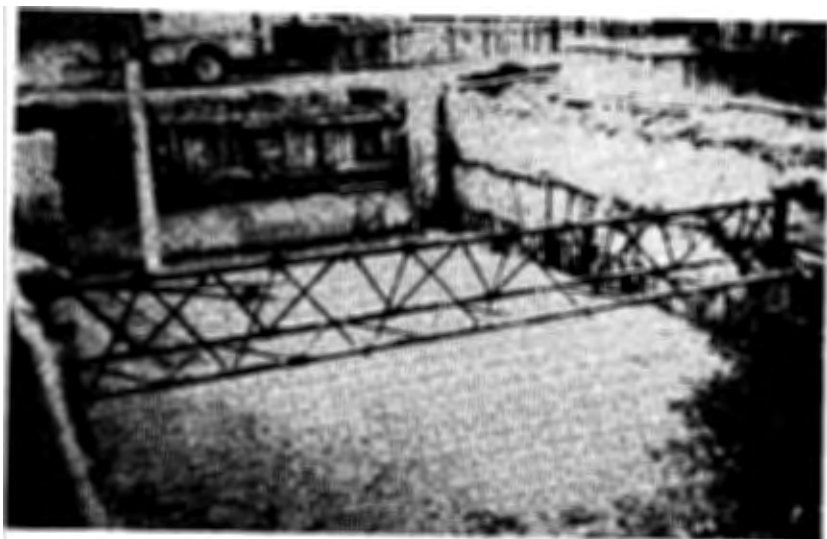


FIGURE 7



FIGURE 8



FIGURE 9



FIGURE 10



FIGURE 11



FIGURE 12

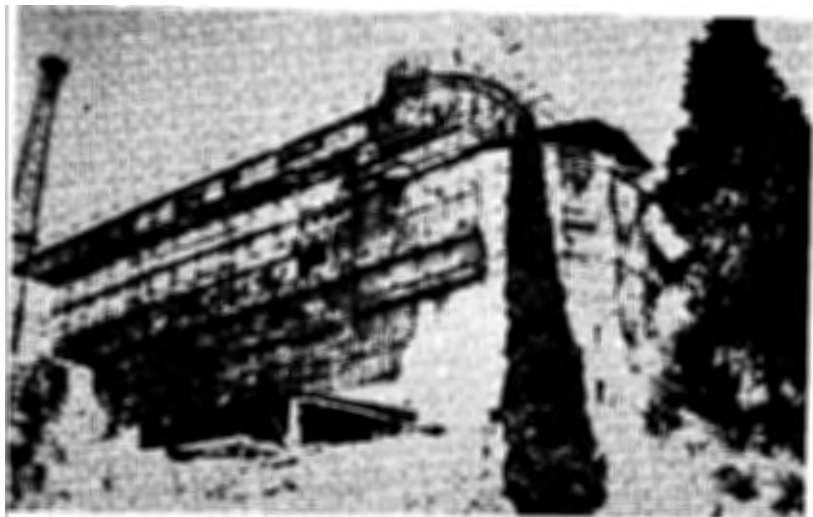


FIGURE 13



FIGURE 14



FIGURE 15

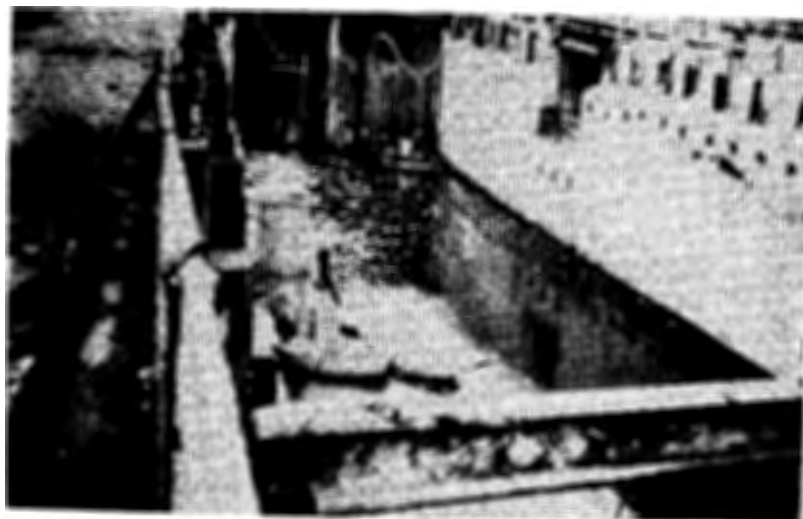


FIGURE 16



FIGURE 17



FIGURE 18

CRITICAL ASSESSMENT OF SLURRY WALL CONSTRUCTION  
IN THE UNITED STATES

by

T. J. REGAN, JR.  
VICE PRESIDENT  
SVERDRUP & PARCEL AND ASSOCIATES, INC.  
BOSTON, MASSACHUSETTS

ABSTRACT

This paper discusses the use of Slurry Wall techniques in urban areas in the United States from its introduction to the present time. A comparison is made of production rates, typical uses, costs, equipment and industry acceptance. An analysis of areas where techniques have fallen short of expectations is also included.



# CRITICAL ASSESSMENT OF SLURRY WALL CONSTRUCTION IN THE UNITED STATES

## INTRODUCTION

While slurry walls can and have been used in connection with building foundations the emphasis of this paper is on the use of slurry walls in connection with cut-and-cover construction, and in particular on the use of slurry walls as part of the permanent structure.

Cut-and-cover tunneling is a process of installing a structure below ground by excavating an area of sufficient width, constructing the permanent structure at the bottom of the excavation, and then covering the structure with soil. The excavation may be left open during construction or temporary decking may be installed to permit movement of traffic if the construction is in a street area.

Traditionally, the structure has been built inside a groundwall support system of soldier piles and timber lagging. Utilities are generally relocated outside the excavation or are supported within the excavation. When the structure is complete, backfilling is done, utilities are repositioned, and surface restoration completes the work. Each of these steps results in disruption to the normal activity and flow of traffic at street level. Until fairly recently there had been little change in this method since it was introduced over 80 years ago and came to be known as the Berlin method.

Many authorities believe that cut-and-cover construction will largely be supplemented in the next ten years by improvements in shield-driven tunnel technology. However, even if true, there will still be many areas that must be done by some form of cut-and-cover.

The slurry wall technique was developed and first used in Europe in the early 1950's. It took about ten years before the first use of a slurry wall was seen in the United States. This was in 1962. In the almost eighteen years since its introduction into the United States, the slurry wall technique has made halting advances.

There are at least three areas where the technique has been used in this country.

- Buildings - both foundation walls and retaining walls have been used, with the building industry perhaps somewhat more willing to use the wall as part of the permanent structure. Some early attempts were disappointing although now there are many successful examples. The 60 State Street Building here in Boston is an excellent example of a well executed project.
- Cut-off walls - there are many successful examples of using the slurry trench technique for cut-off walls on dams. This type of application, however, is radically different from the urban problems of cut-and-cover tunneling.

- Tunnels - Slurry walls have been used in urban tunnel projects beginning with BART. However, the use has generally been as a temporary ground wall support. On occasion the technique has been used in lieu of underpinning. There are almost no examples of the slurry wall being incorporated into the permanent structure. It is particularly appropriate that here in Boston we are incorporating the slurry walls into the structure in the first major application in the country.

## HISTORICAL DATA

The first uses of slurry walls in this country was as a substitute for soldier piles and lagging. It was used only as a temporary wall--the permanent structure was built inside and the wall abandoned. The soldier pile-tremie concrete (SPTC) method developed in San Francisco was exactly this kind of a substitution. Piles were driven or pre-bored at 6 to 8 feet on-centers, the space between was excavated in a slurry trench, and the concrete was placed to serve as a lagging. Variations on this method are presently being used in several locations.

The impervious nature of a slurry wall has been utilized where it is important to cut off ground water. This kind of use has developed to a fair degree.

Recently there has been some acceptance of the idea of using a slurry wall in place of underpinning. I happen to believe that underpinning should generally be avoided--use a technique to hold the soil in its original position by permitting only tolerable ground movements. This approach however is not universally accepted.

We have tried to examine the production rates of various slurry wall projects. Accurate data is very hard to come by and varies tremendously depending on conditions. However a generalized trend is shown in Figure 1 and we believe the trend is fairly reliable. It is encouraging in that the trend in production rates seems to be up and current rates are well above those of a few years ago.

The costs per square foot of slurry walls have apparently risen about in proportion to inflation trends. It seems that much more frequently slurry walls are competitive with traditional methods even though they are not incorporated into the permanent structure. Unfortunately on many projects, slurry wall costs are buried in with excavation, bracing, or other items. I would suggest that any time alternate bids are allowed the terms be set up so that the owner knows exactly what the difference in bid price is and what the conditions are.

## DEVELOPMENT OF EQUIPMENT

One of the major factors in the improving acceptance of slurry walls is the improved equipment being used. Most of the equipment has been developed by the slurry wall contractors themselves--it is not an off-the-shelf item.

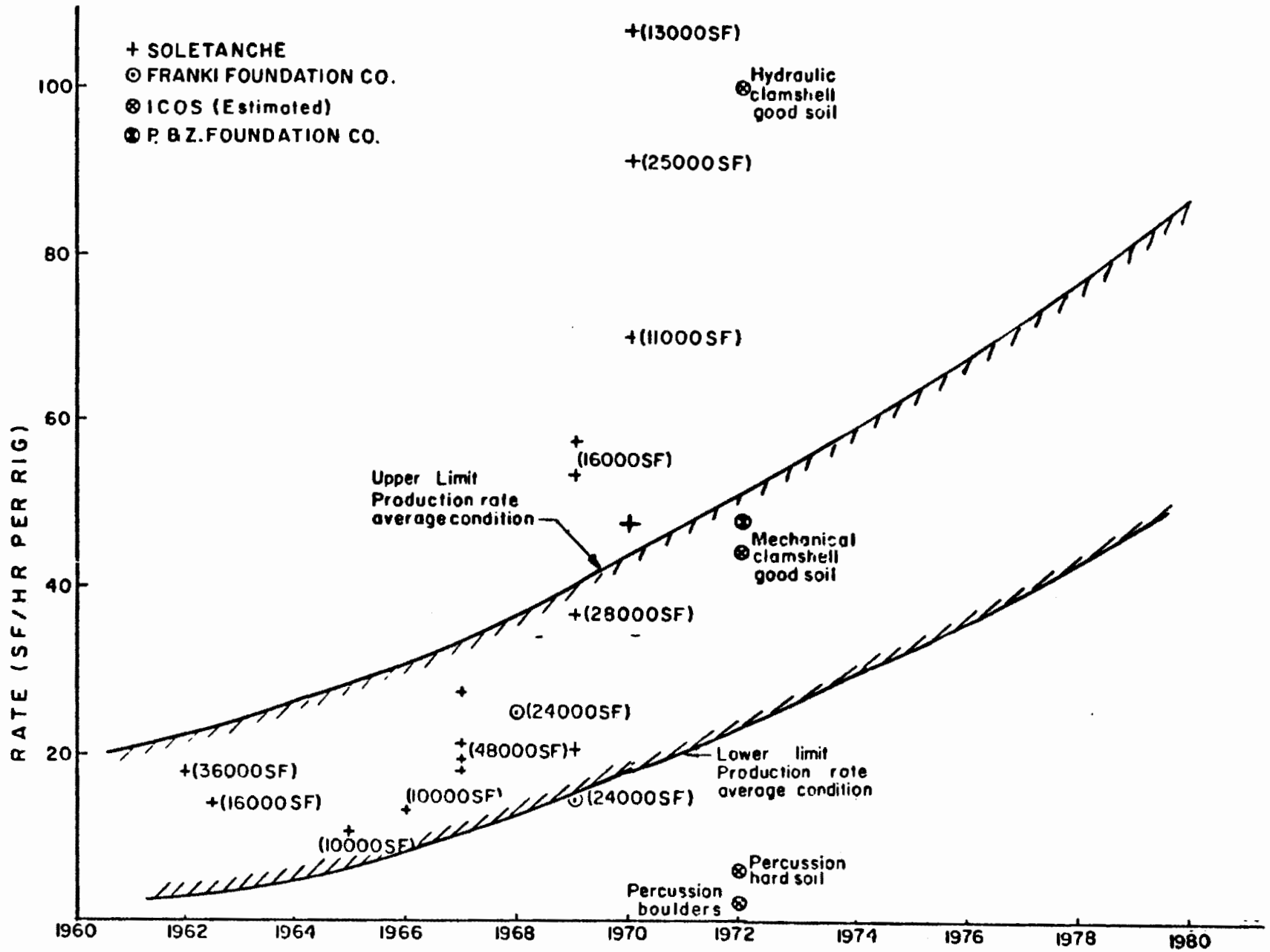


FIGURE 1. AVERAGE PRODUCTION RATE, Slurry-Trench Walls

There are several different types in use today in the United States. Most slurry wall construction in the United States is by clamshell--the major competitors all use this method. However the reverse circulation technique used by the Japanese--Tone Boring--and the earlier techniques used by Soletanche have never really caught on in the United States. Tone Boring has operated to a degree in the Chicago area but has yet to do a major job in the tunneling field. This is not to say the method is without merit--it just hasn't been developed in the United States.

Among the contractors using clamshells, a major difference exists; that is a cable suspended bucket vs., a bucket on a Kelly bar. To the owner the difference is probably insignificant. Each contractor claims his system is superior; and each contractor has performed numerous examples to prove his point. Both are probably right and both methods can generally result in a wall built to acceptable tolerances. Buckets are also designed to function either as a hydraulic or mechanical unit.

Since the introduction of the slurry wall process into the United States, an often voiced objection is that the process can tend to be messy. When adequate care is not taken this can be true. Slurry that is allowed to splash and run onto the surface, and to run into sewers and drains can cause severe problems, and raise objections from the public.

However this need not be so. I would like to examine in detail the techniques that are being used on the current job in Harvard Square. The slurry itself is stored in a closed system; two twenty thousand gallon storage tanks are located right in the Square, the slurry is pumped to the trench and returned to the storage tanks through a desanding operation. The clamshell has weepholes to drain the slurry back into the trench before turning the rig to dump into a hopper. The hopper raises and dumps into waiting trucks sealed to prevent leakage.

The significant point from an owner's or an engineer's point of view is that the equipment is being improved gradually. Digging through till and boulders and forming rock sockets is a more predictable operation than it was a few years ago. Most of the equipment changes and developments are coming from Europe--primarily Franki and ICOS. The bottom line is that most of the slurry wall contractors in the United States today are reasonably capable and most are continually improving both the equipment and the techniques. The shakeout in the industry that eliminated many marginal contractors seems to be pretty much over.

#### PRODUCTION RATES

Meaningful data on production rates is extremely hard to come by. Slurry wall contractors may know, but they certainly are not making this kind of detailed information available. In an urban area there are many factors that affect the production rate and each case must be considered on its own merit.

Some factors affecting production rates are:

- Noise restrictions - the operation may be limited to one shift or part of a shift.
- Traffic restrictions - depending on the area, actual work may be limited to substantially less than one shift.
- Labor and union rules - overtime work may be partially or totally precluded due to other labor rules and unions.
- Size of the job - a small job that is over in a month gives no opportunity to develop a learning curve nor to overcome delays due to unexpected conditions.
- Depth of the wall - generally speaking the greater the depth, the greater the risk of something going wrong, and the greater the difficulty of maintaining the verticality of the wall.
- Length of the panel - the longer the panel, the greater the production rate; however, this must be balanced against the risk of each individual case.

## COSTS

Generalizations of cost figures may be a dangerous thing to do. However, I think that under ordinary conditions a cost of \$30-\$40 per square foot is probably reasonable. Excavation in till and boulders may cost from \$100-\$150 per square foot.

As mentioned before, prices for slurry walls are often buried in with other items. On the Red Line Extension, unit prices bid by the successful contractor are as follows:

### Harvard Square

|            |              |               |
|------------|--------------|---------------|
| Overburden | - \$50/S.F.  | (54,000 S.F.) |
| Rock       | - \$150/S.F. | ( 2,500 S.F.) |

### Davis Square

|            |              |               |
|------------|--------------|---------------|
| Overburden | - \$25/S.F.  | (82,000 S.F.) |
| Rock       | - \$150/S.F. | ( 4,000 S.F.) |

We have no way of determining what portion of these prices represents a general contractor's add-on or the proportion assigned to labor, materials and equipment. An educated guess is that 20 percent of the cost represents labor, 35 percent of the cost represents material, and 45 percent of the cost represents equipment.

## DEVELOPMENT OF DETAILS

Over the years various methods of forming the joint between panels and at the end closure have been developed. Each is somewhat different and designed to be compatible with the excavating equipment being used. Pipe joints have been frequently used; at Harvard Square Franki is using a flat plate with a key. Joints obviously are a potential source of

leaks for ground water. It is my contention that transit structures in general do not have to be 100 percent watertight and that it is probably more cost effective to take steps to handle a small amount of leakage than to make the structure absolutely watertight.

The techniques for fabricating and placing rebar cages and inserts have probably developed to a higher degree than many other parts of the process. Guide rollers, inserts, stiffening beams, etc., are all used very effectively and probably offer little potential for dramatic improvements.

One area that is in the developmental stage is providing moment connections from a slurry wall to other structural elements. We have used Cadweld connectors frequently to develop reinforcing bars. While questions have been raised regarding the use of this type of connector, we feel that its extensive use in the nuclear power plant industry is a reasonably good criterion.

One aspect of the construction of slurry walls is to maintain adequate tolerances, especially if the wall is to be incorporated into the permanent structure. A guide that should be readily attainable is to maintain plumbness of  $\pm 1$  percent. Since most transit structures built by cut-and-cover methods will be relatively shallow, this variation can be incorporated into the clearance diagram.

#### TYPICAL USES IN THE UNITED STATES

BART - Slurry walls were used at the Civic Center, Embarcadero, and Powell Stations and for a vent shaft. None of the walls were incorporated into the permanent structure, although I believe in one station it was used as a support for a relieving platform.

WMATA - Slurry walls have been used several times as ground wall support and in lieu of underpinning; however, none were incorporated in the permanent structure.

MARTA - Several walls up to 55'-60' deep were used as temporary ground wall support.

NYCTA - Slurry walls have been used as ground wall support on the Archer Avenue section but never in the permanent structure.

BALTIMORE - A modified soldier-pile-tremie-concrete method is being used at the Charles Center Station in lieu of underpinning.

I do not know of any examples in this country where the slurry wall was used as part of the permanent structure. I would like to touch briefly on some of the objections I have heard.

- . You don't really know if the wall has large voids or not - this could happen with soldier-pile-tremie-concrete, but with a reinforcing cage, I think it is highly improbable.

- . Slurry walls leak - this was discussed earlier.
- . The bucket wandered off plumb by as much as two feet - I think this would be highly unlikely with the proper equipment.
- . Slurry wall construction is tough going - true, but so is soldier pile and lagging; piles and wales twist, get out of line, loss of ground through lagging, etc.

#### POTENTIAL AREAS FOR DEVELOPMENT

I think there are several areas where development should be taking place but has not.

Secant piles - they have been used to some extent in Atlanta but practically nowhere else in the country. Benoto used to operate in Chicago but is no longer active in this country. The technique seems to have advantages under certain conditions. Precast elements in a slurry trench - this method, popular in Europe, has never caught on in the United States. DOT attempted a demonstration project several years ago without any positive results.

Post-tensioned slurry walls - ICOS has apparently had success with this technique but it has yet to make an appearance in the U.S.

Reverse circulation rigs - Tone Boring was tried in the Chicago area but apparently without much success.

As a final closing idea I would like to suggest that UMTA fund for each project or contract, the preparation of a construction report. This was done at BART and the document is a very useful tool. It analyzed man-hours and time for various tasks, gave quantities of materials, types of equipment used and for how long, temporary conditions, utility support methods, detours and traffic maintenance, and a wealth of other information including pictures. Admittedly the cost of preparation for such a report is significant but I maintain it would be money well spent.

SPEAKER: Mr. T. J. Regan, Jr.  
Sverdrup & Parcel and Associates, Inc.

William Baron  
Clemson University

Question:

One of the advantages of the slurry wall in buildings apparently is that in soft ground it prevents lateral movement or reduces lateral movement as compared to normal excavation. Is the use of a precast element in a slurry wall as effective, or can it be as effective in reducing lateral movement?

Mr. Regan

Answer:

Every indication that I have is that the use of a precast element does exactly the same thing as a cast-in-place slurry wall. It is really a precast concrete piece put in a slurry and concrete; the concrete hardens around it and it is peeled off from the building side or the surface side and you are left with an element that functions every bit as well as an element cast in place.

A. J. Trivedi  
Port Authority of New York  
and New Jersey

Question:

The cost figures that you quoted, did they include excavation and temporary bracing as you go along or just the wall in place?

Mr. Regan

Answer:

I think that's the wall in place. It includes excavation but not temporary bracing or tie-backs, or whatever they may be. That is excavation of the wall--not excavation of whatever structure may be inside the wall.

Sol Katz  
New York City Transit Authority

Question:

On the slurry panels, you said that water tightness was not that important. Now, there are excavations where they are important, particularly on a permanent item. How do you go into that, particularly when you cannot waterproof the wall on the outside?



Mr. Regan

Answer:

I didn't mean to say that the waterproofing wasn't important. My point was that you can accept some degree of leakage and still take care of it. Certainly the techniques are improving in the joint systems and you can, if necessary, grout behind the joint of the wall if you do get a leak.

Mr. Katz

Question:

Well, I am talking about a 50 or 60-foot head of water and an excavation 90 to 100 feet deep, where you will have leaks due to windows in the wall caused by boulders or insufficient seating on the rock below. Now how would you get into that situation?

Mr. Regan

Answer:

There may well be extreme cases where you would use the slurry wall as a ground support system only, and build a fully waterproof structure inside of it. The kind of extreme condition you are citing sounds like it well may be that.

# DESIGN OF SLURRY WALLS AS PART OF PERMANENT STRUCTURES

by

JEROME S. B. IFFLAND  
IFFLAND KAVANAGH WATERBURY, P. C.  
NEW YORK, NEW YORK

## ABSTRACT

When slurry walls are used as part of permanent structures, the design must consider the complete loading and unloading history of the walls. This includes the temporary construction sequences of excavation and bracing, integration of the walls into the permanent structure, back-filling and removal of bracing, and long term loading conditions. Various assumptions are possible for determining the magnitude of the loads acting on the walls during the loading history. Similarly, several different types of analysis are possible. First, a conventional elastic analysis may be made in which the stresses are determined throughout the loading history utilizing applied loads developed for each load stage. An analysis can also be made based on the assumption that plastic hinges can form allowing for redistribution of moments. The loading for the plastic analysis method would also be those applied loads developed for each load stage. Rather than utilizing applied loads, both methods may be combined into a single operation. Various assumptions are possible for the constitutive equations of the soil-structure interaction model for each of the general soil types. This paper discusses the possible assumptions for loads and methods of analysis for the design of slurry walls as part of permanent structures and suggests alternative acceptable design procedures.

## DESIGN OF SLURRY WALLS AS PART OF PERMANENT STRUCTURES

### INTRODUCTION

The methods by which slurry walls are designed, when they are to be used as parts of permanent underground structures, should meet several specific requirements. First, the method of design should be consistent with that used for the non-slurry wall portion of the underground structure. The assumptions regarding the magnitude and distribution of applied loads should be consistent. The methods of computing stresses should also be consistent. If stresses are computed assuming elastic action of the non-slurry wall portion of the structure, the same procedures should apply to the slurry wall portion of the structure.

Secondly, the design method should be rational. The designer should be able to visualize the action of the structure. When loads are changed, deflections and stresses should respond logically. Common sense is important throughout the entire design process.

Thirdly, the selected method of design should be adaptable. It should be adaptable to different assumptions for computing earth pressures, to stratification of the soil mass, to changing levels of ground water, and to different types and magnitudes of surcharge loading. The method should also allow for investigation of the effects of prestressing the bracing struts and the effects of struts being located at elevations different from those assumed during design or to possible loss of struts during construction.

These three considerations, consistency, rationality and adaptability, form the basis for the "incremental load application" design procedure suggested in this paper. The procedure is presented in detail for an assumed elastic method of analysis without any soil-structure interaction except at the base of the underground structure where springs are assumed to satisfy equilibrium requirements. The same incremental procedure is then suggested for a plastic method of analysis and for a soil-structure interaction method of design.

### PRELIMINARY DESIGN FOR CONSTRUCTION

Before the slurry wall is designed as part of the permanent underground structure, a preliminary design must be made to establish the width and depth of the wall and the location and design of the braces. The depth of the wall must be sufficient to provide a factor of safety against failure of the bottom of the excavation. The width and depth of the wall will also be controlled by the necessity of supporting vertical loads due to the dead and live load reactions of the decking across the top of the excavation as well as the dead load of the wall itself. Struts should be located to facilitate the proposed method of excavation within the cofferdam and a decision on whether these struts are to be prestressed should be made and, if so, the magnitude of the prestress decided.

This paper does not treat these preliminary computations. It is assumed that the number of struts, the levels of excavation, the depth and width of the slurry wall, and the need for and amount of prestressing the struts have been already established. The proposed design procedure will establish the validity of the magnitude of the assumed prestressing forces in the struts as well as the design of the struts and the wall thickness. If the preliminary design is not satisfactory, it must be changed and a re-analysis made. In some cases the proposed design procedure will indicate that the preliminary depth of the wall will also have to be increased.

### ASSUMPTIONS

In order to illustrate the incremental loading approach without introducing complex loading diagrams, a Rankine earth pressure distribution for one type of soil throughout, without ground water pressure or surcharge loads, has been used. The same principles of design apply for a stratified soil mass and with earth pressure distribution determined by other theories and even for time dependent conditions. Ground water pressure and surcharge loads can also be added. These more complicated loadings only change the applied incremental loading in each step of the procedure. The vertical loads of the reaction of the decking across the excavation and the weight of the wall are not included in the described procedure. The magnitude of the resultant compression stress in the wall from these loads is small; however, these stresses can be included if desired.

A designer can also utilize the concept of "equivalent height" without changing the proposed procedures. In the following, it has been assumed that lateral pressures start at the top of the ground which is also the top of the slurry wall. The struts are assumed to be pin-connected to the slurry walls and it is assumed that the structure acts elastically.

Additional assumptions regarding possible reactive forces are noted for several of the loading stages. In many cases, the distribution and magnitude of the reactive forces on the structure are arbitrary. In general, net passive earth pressure forces have been used to provide reactive forces to the applied loads. In some instances pressures lower than these would be more applicable. Many valid assumptions are possible depending on varying soil conditions. These would be acceptable alternates as long as equilibrium conditions are satisfied. The proposed design procedure would not be changed.

### GENERAL DESCRIPTION OF DESIGN PROCEDURE

It is proposed that structures, constructed of slurry walls joined to cast-in-place concrete structures constructed within the cofferdam formed by two parallel slurry walls, be designed by incremental application of applied loads. Each stage or increment of stresses is determined by any changes in the method of support of the structure or by changes in the applied load. The stress distribution and magnitude in the structure for each stage of loading is recorded and is added to that of the previous stage. The final stress distribution is the algebraic sum of all loading stages. This approach for the design of slurry walls is not new.

In one of the few available papers on design of slurry walls, James and Jack (1) used a similar stage by stage analysis simulating the method of construction in the field for an "Empirical Single Tie Approach" design method.

Incremental summation of stresses, as both loading on a structure and its support conditions change, is a common structural procedure. All prestressed concrete structures are examples of this. The concept is adaptable to all possible variations on how the underground structure is constructed and how the slurry walls are joined to the remainder of the underground structure. As will subsequently be described, the incremental load application procedure is adaptable to methods of plastic analysis as well as to soil-structure interaction models.

### STAGE 1

After the slurry wall has been constructed, the first stage of the excavation is shown in Figure 1. The wall acts as a cantilever to resist the applied active earth pressure  $p_A$  over the depth of excavation  $h_1$ . Figure 1 illustrates one possible reactive pattern. The wall is assumed to be rigid and it rotates about point B developing passive earth pressure  $p$  where it pushes into the earth. The net passive pressures at the peaks of the pressure diagram are indicated in the figure. Since the wall is of a predetermined depth (from the preliminary design) constructed to point D, these peak passive earth pressures are usually not equal to their maximum value. Their magnitude is established by summation of horizontal forces on the structure and equating them to zero and by summation of the moments of these forces about any point on the structure and equating these to zero.

The loading shown in Figure 1 is not recommended for deep walls. It is not reasonable to believe that a relative high level of stress exists in the lower portions of a deep wall due to a relatively small application of active earth pressure. The example is shown to illustrate that a designer has flexibility in determining a possible reactive pattern and that one must be selected that best fits rational principles.

A second alternate reactive pattern is illustrated in Figure 2. In this example, the wall is still assumed to act rigidly and rotate about point B and develop reactive net passive earth pressures on each side of the wall. However, in this case it is assumed that the wall is a free end at point D. This is equivalent to assuming a factor of safety against overturning equal to one and is a common assumption made in design of sheet piling walls. The two equations of statics determine the location of the point D at depth  $d_1$  and the location of intermediate peak in the net passive earth pressure diagram at distance  $X_1$  from point D. In this alternate, both net passive earth pressures indicated in Figure 2 are their maximum value.

A third alternative reactive pattern is shown in Figure 3. The same assumptions used for the alternative shown in Figure 2 are made with the

additional assumption that the reactive forces are simplified as illustrated. This loading assumption is also commonly used in design of sheet piling walls. In the notation the distance to point D is denoted as  $d_1'$  to indicate that it is different from that of Figure 2.

The three alternate loading patterns have been described to demonstrate possible assumptions. None of these are ideal but Alternate 2 is recommended. Once the loading pattern has been established, the stress distribution and magnitudes in the wall are computed and recorded for the Stage 1 loading. From the assumptions made, there are no stresses in the wall below point D.

#### STAGE 1'

The next stage of construction is the installation of a brace at the top of the wall usually prestressing this brace to some force  $F_1$ . The assumed reactive pattern to this force is shown in Figure 4. The two equations of statics locate the point D at distance  $d_1''$  and the peak of the net passive earth pressure at distance  $X_1'$  above point D. As shown in Figure 4, the magnitude of these reactive pressures at the peaks of the pressure diagrams are maximum values.

The stresses in the wall from the applied prestressing force are computed and added to those in Stage 1 to determine the net stage of stress at this stage of the construction. Again, there are no Stage 1' stresses in the wall below point D.

#### STAGE 2

After the first brace has been installed and prestressed, excavation continues from depth  $h_1$  to depth  $h_2$  as shown in Figure 5. At this stage of construction two loading changes have taken place. An increment of active earth pressure has been added to the structure and the support conditions have changed. In addition to the net passive earth pressure reactive forces, the first brace also acts as a point of support. These forces are shown in Figure 5 and the values of  $d_2$  and  $X_2$  are determined from the two equations of statics. The net passive earth pressure reaches the maximum value at point D and there are no stresses in the wall below this point.

#### STAGE 2'

Before excavation proceeds, the second brace is installed and usually prestressed to some force  $F_2$ . The assumed loading pattern is shown in Figure 6. It is emphasized that throughout the design procedure a designer has the prerogative of assuming alternate reactive patterns. The assumption should be rational and could be different for alternate active loading patterns. In Figure 6, the two unknowns determined from statics are the location of point D at distance  $d_2'$  and the magnitude of the reaction at the first brace. The next passive earth pressure reaches its maximum value at point D and there are no

stresses in the wall below this point.

### STAGE 3

Excavation now proceeds to depth  $h_3$  as shown in Figure 7. The increment of active earth pressure due to this excavation is indicated. Because the structure is supported by two braces, it is now indeterminate and it must be analyzed as a continuous beam. There are three unknowns, the reactions to the two braces and the location of point D at the distance below the excavation  $d_3$ . It should be noted that the total forces in each brace is the sum of the original prestressing force plus the incremental reactions of the subsequent loading stages. The incremental reaction sometimes puts the brace into tension as is the case with the top brace for this stage of loading. Should the brace at any time of loading lose its net compressive force, it would mean that the initial prestressing force was inadequate and, if no prestressing force was used, the brace should then have been prestressed. The total stresses in the slurry wall at the end of the Stage 3 loading are the algebraic summations of all stresses for each loading stage through Stage 3.

### STAGE 3'

The third brace with the prestressing force  $F_3$  is now installed. This load and the resultant reactive pattern is shown in Figure 8. The force  $F_3$  is supported by the net passive earth pressure developed and by the first two braces. This structure is also indeterminate and must be analyzed as a continuous beam. There are three unknowns, the reactions to the first two braces and the distance  $d_3'$  to the location of the peak net passive earth pressure. As before, the point D is equivalent to a free end and there is no external moment on the structure.

### STAGE 4

After the third brace is installed, the excavation is carried down to distance  $h_4$  from the ground surface as shown in Figure 9. The increment of active earth pressure and the reactive forces are also shown. This loading diagram differs from previous ones (except for Figure 1) by the assumption that the reactive net passive earth pressure extends to the full depth of the wall. This assumption can be made and the peak value calculated. If it exceeds the maximum allowable value, indicated in brackets in Figure 9, then the assumption is wrong and the depth  $d_4$  must be calculated as it has been shown for the loading in previous stages. The reactive forces for the applied incremental loads are the net passive earth pressure and the forces developed in the three braces. The structure is again indeterminate and must be solved as a continuous beam.

### STAGE 4'

The fourth brace is installed and prestressed. The structure and

loading is similar to Stage 3' except that there are now three braces acting as reaction points as well as the net passive earth pressure as shown in Figure 10. As the bottom of the wall is approached, the calculations may indicate that the distance  $d_4'$  exceeds the distance to the base of the slurry wall. In this case, an adjustment in the reactive earth pressure pattern must be made similar to that shown in Figure 9. The peak value cannot exceed the maximum value at the bottom of the wall. The unknowns in the indeterminate continuous beam structure in Figure 10 are the reactions to the three braces and the distance  $d_4'$ .

#### STAGE 5

For this discussion, Stage 5 will represent the last increment of excavation as shown in Figure 11. The incremental active earth pressure is supported by five reactions, the four braces and the net passive earth pressure at the bottom of the wall. The last several loading stages have been affected by the finite depth of the slurry wall. In Figure 11, the distance  $d_5$  is a known value and the net passive pressure at its peak value at the bottom of the wall again cannot exceed its maximum allowable value as shown in brackets in the figure. It should be noted that the top brace (as well as some of the others) has had incremental tension forces added to its original prestressing load for several loading stages. It was previously stated that if the net force in any brace became tension, additional prestressing force would be required. However, as the bottom of the wall is being approached and the peak net passive earth pressure is less than the maximum at this point (as assumed in Figure 9 and Figure 11), it is possible to change these total bracing forces by increasing the total depth of the wall. This of course would only change the stress patterns affected by finite location of the bottom of the wall. At the end of Stage 5, the preliminary design of the slurry wall is effectively checked. The brace design and the prestressing forces can be compared to those initially assumed and any required changes made. The associated stress patterns would have to be corrected if prestressing forces are changed. These represent four of the nine loading stages up to this point in the design procedure.

#### STAGE 6

The excavation within the braced cofferdam has been completed. The next step in the construction is to construct the bottom slab of the permanent structure as shown in Figure 12. A discussion of the type of joint between this bottom slab and the slurry walls will not be made in this paper. It can be a full moment connection or a partial moment connection. Whatever the degree of fixity, its value only has to be included in the analysis. That is, the moment  $M_6$  could be a pre-established value. Similarly, if interior walls were poured and made to act compositely with the slurry walls, they would only be another loading stage and once constructed they would change the properties of the structure.



Figure 12 shows the incremental applied load caused by the construction of the bottom slab. It consists of the dead load for the slab plus some live load. The reactive forces are also shown. These are the elastic springs representing the earth pressure beneath the bottom slab and the assumed net passive earth pressures at the base of the slurry walls. The entire braced U-Shaped structure must be analyzed as a unit. The distance  $X_6$  is an unknown since the top of the pressure diagram is assumed to be located at the point of contraflexure in the slurry wall where it no longer pushes against the external earth. This must be computed by trial and error although the first trial should be satisfactory. It is quite possible that the net passive earth pressure reactive forces will be of such magnitude that they can be neglected. The reason for the spring supports will be discussed under the next loading stage. Once the U-Shaped structure of Figure 12 is analyzed, the stresses in the slurry walls are adjusted to include those for this new load increment.

#### STAGE 7

The top slab of the permanent structure is now constructed. In Figure 13, it has been conveniently located in the plane (or close to it) of the third brace. If the slab were a substantial distance below this brace, then an additional brace removal loading stage would subsequently have to be included in the analysis. After the top slab has cured, the temporary shoring and the lower two braces are removed. The incremental applied loading consists of the slab load (and possibly some construction live load) and the release of the bracing forces  $F_3'$  and  $F_4'$ . The reactive forces are the springs below the bottom slab, net passive earth pressures in the slurry walls at zones where they push into the earth due to the bending action of the wall and the reactions provided by the first and second braces. The location of the zones of net passive earth pressure forces must be located by trial and error. The zones shown in Figure 13 are not necessarily correct and certain ones may turn out to be small enough to be neglected. It is also possible to assume that there is insufficient movement of the walls to develop any passive resistance. This is an assumption that can be left up to the designer's judgement.

The degree of rigidity of the connection between the slurry walls and the top slab can also be adjusted. The moment  $M_7$  could be a pre-established value based on a pre-determined partially fixed joint. The springs at the bottom are required because an elastic reactive force is necessary in order that external and internal equilibrium conditions balance simultaneously. The spring constants are functions of the modulus-of-subgrade-reaction which can be varied arbitrarily to give a rational pressure diagram. This pressure diagram will not peak at the ends of the bottom slab which will usually result if a uniform spring constant is assumed.

The discussion of the need for elastic springs at the base could equally apply to the passive resistance to the slurry walls. However, it is believed that the assumed linear distribution of these pressures should not result in as great an unbalance in internal and external equilibriums as that caused by vertical forces. If in the analysis, it is found that this is not the case, then arbitrary springs with possible varying spring constants can be used on the sides of the slurry walls once the passive pressure zones have been determined. This comment applies to all subsequent loading stages.

After the analysis is complete, incremental stresses are recorded as before and added to those of the other stages to determine the resultant stresses throughout.

### STAGE 8

The backfilling process now begins. This is shown in Figure 14. The increment of load is the weight of this backfill. The assumptions and discussion on reactive forces and springs for the Stage 7 loading all apply for this stage and to the subsequent stages 9, 10 and 11.

### STAGES 9, 10 and 11

These loading stages represent subsequent brace removals and backfilling operations. Each stage is separately analyzed and the resultant stresses in the structure added to the previous accumulative totals. It is probable that passive earth pressure cannot be developed on the inside of the slurry walls because of the lack of compactness of the newly placed backfill.

It is possible that the tops of the slurry walls are to be demolished down to some depth. In such a case, the backfill in Stage 10 might only be placed to that height and the top brace subsequently removed before the demolition of the tops of the walls. Some temporary sheeting might also be required. These conditions would change the incremental loading and reactive patterns accordingly. As backfilling and brace removal operations take place, stresses continue to change throughout the structure and these must be calculated and added to the cumulative totals to evaluate the total stress picture.

### STAGE 12

Once backfilling and brace removal operations are complete, there are additional loads applied to the permanent structure. These are shown in Figure 18. They include surface loads, loads acting from the interior of the structure, and the incremental earth pressure load on the slurry walls resulting from the time dependent build-up of at-rest earth pressures. These new incremental loads will create substantial changes and increases in the stresses in structure. Also, it is at this

stage of the loading that any possible unbalanced earth pressure might be considered. Such an assumption could result in sideways of the structure and also induce substantial increases in stresses.

Once the Stage 12 loads are analyzed and stresses determined, the final stresses in the slurry walls can be established and these walls can be designed for their permanent condition and the adequacy of the wall thickness checked and reinforcing steel selected. Of course, all intermediate stress conditions must also be checked and revisions made, if necessary. At the end of this process the design of the structure is complete.

### PLASTIC ANALYSIS

The elastic incremental load application design procedure previously discussed is considerably complicated by the need to evaluate the load stages when braces are installed and prestressed and when they are removed. For this reason, Iffland (2) has suggested that structures of this type be analyzed using a plastic analysis or limited state theory as the method is sometimes called. Using this method of analysis, the in and out movement of one or more of the supports prior to, during, and subsequent to loading does not affect the collapse load. The collapse load is also independent of the previous history of loading.

When one considers that, for a reinforced concrete wall of constant thickness (as a slurry wall is), the plastic moment capacity at various sections can be varied almost at will by adjustment of the amount of the reinforcing steel, and that this limit state theory eliminates consideration of the brace loading stages, the incremental load application method by plastic analysis is decidedly a much simpler procedure. The procedure is exactly the same as previously described except that hinges (of predetermined moment capacity if desired) would be allowed to develop at the points of support at the brace locations and also at other highly stressed points in the composite slurry wall permanent structure. Plastic analysis eliminates the problems introduced by support movements and also transforms the indeterminate structures that exist during various stages of the construction into easily identified structural mechanisms eliminating the requirement of solving the indeterminate structural problem. Actually, if there was no need to examine stress conditions at different load stages for design of bracing and other construction stage requirements, the total loads on the finished structure could be applied and analyzed in one procedure.

### SOIL-STRUCTURE INTERACTION

Solution of complete soil-structure interaction problems utilizing Finite Element Method (FEM) techniques is currently in vogue. The more sophisticated soil constitutive models consider certain soils as time-dependent viscous, multi-linear elastic soils. Whatever model is

selected to represent the properties of the soil mass, and many have been suggested, the incremental load application procedure described herein is applicable to the soil-structure interaction problem. Its use might enhance the soil-structure interaction approach since the stresses for each load stage can be examined to determine if they are rational. If not, then the applicability of the selected model of the properties of the soil mass could be adjusted until reasonable values result. The same model would, of course, have to be used for all load stages.

## CONCLUSION

An incremental load application procedure has been suggested for analysis of structures constructed of slurry walls joined to cast-in-place concrete structures built within the cofferdam formed by two slurry walls. This method provides for consistency throughout the analysis and design process, it provides the designer with a rational approach, and it is adaptable to all manner of design conditions. The method provides the designer considerable leeway to exercise his individual judgement on how the structure acts by selection of appropriate reactive support patterns without grossly changing the results of the analysis. The procedure is also applicable to the Plastic Analysis Method and to Soil-Structure Interaction Methods.

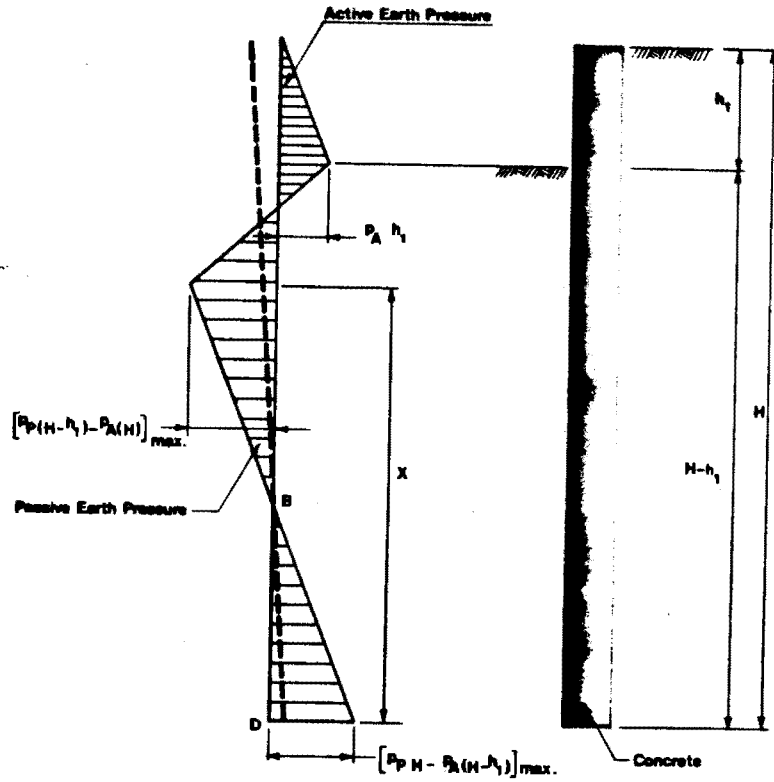
## APPENDIX I - REFERENCES

1. James, E.L., and Jack, B.J., "A Design Study of Diaphragm Walls", Diaphragm Walls & Anchorages, Proceedings of a Conference organized by The Institution of Civil Engineers and held in London, 18-20 September 1974, Institution of Civil Engineers, London, 1975, pp. 41-49.
2. Iffland, Jerome S.B., "Practical Design of Concrete Diaphragm Walls," Transportation Research Record 684, Transportation Research Board, National Academy of Sciences, Washington, D.C., 1979, pp.37 - 43.

## APPENDIX II - NOTATION

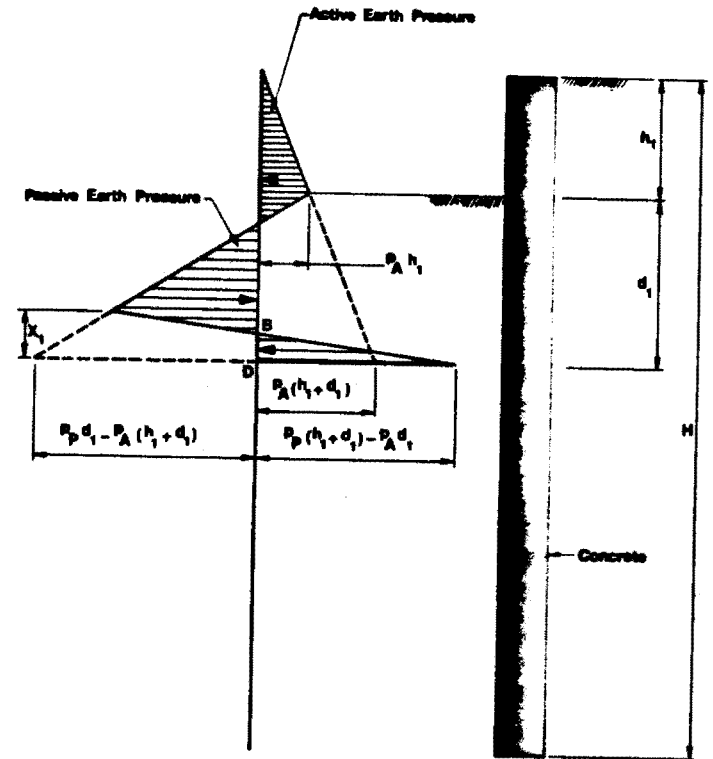
|  |  |
|--|--|
| $d_1, d_1^I, d_1^{II}, d_1^{III}, d_2, d_2^I, d_3, d_3^I, d_4, d_4^I, d_5$ | - distance from bottom of excavation to lowest point on net passive earth pressure diagram |
| $f_1$  | - distance from top of backfill to centerline of top slab                                  |
| $h$  | - distance from ground surface to top of top slab  |
| $h_1, h_2, h_3, h_4, h_5$  | - depth from ground surface to level of excavation   |

|   |  |
|---|--|
| $P_A$   | - intensity of active earth pressure   |
| $P_{AR}$  | - intensity of at-rest earth pressure  |
| $P_P$   | - intensity of passive earth pressure  |
| B   | - point of rotation in wall where net pressure is zero                       |
| C   | - equivalent force of net passive pressure                                   |
| D   | - point on slurry wall at lowest point on net passive earth pressure diagram |
| $D'$  | - thickness of bottom slab of structure                                      |
| $D''$   | - thickness of top slab of structure   |
| $F_1, F_2, F_3, F_4,$<br>$F_2', F_4'$   | - prestressing or incremental or total forces in braces.                     |
| $M_6, M_7, M_7', M_8, M_8',$<br>$M_9, M_9', M_{10}, M_{10}',$<br>$M_{11}, M_{11}', M_{12}, M_{12}'$ | - moments in top and bottom slabs at juncture with slurry walls              |



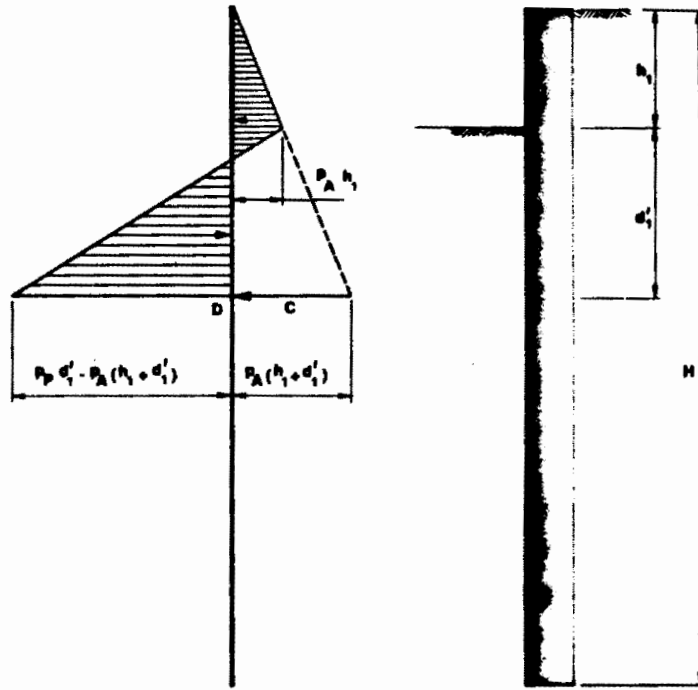
STAGE 1

FIGURE 1 CANTILEVER EARTH PRESSURE ALTERNATE 1

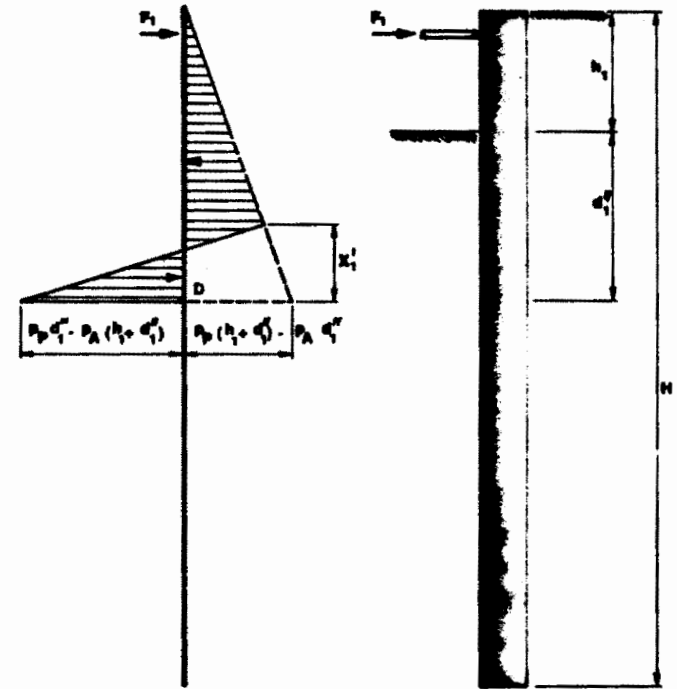


STAGE 1

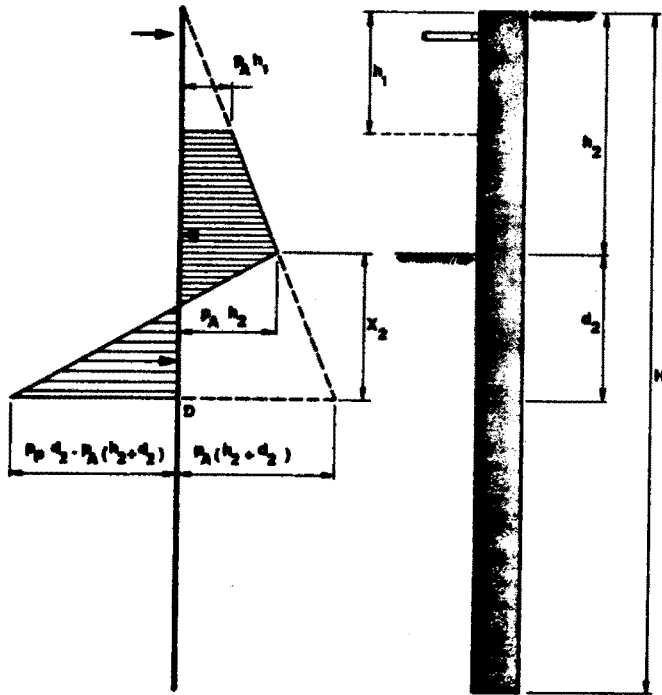
FIGURE 2 CANTILEVER EARTH PRESSURE ALTERNATE-2



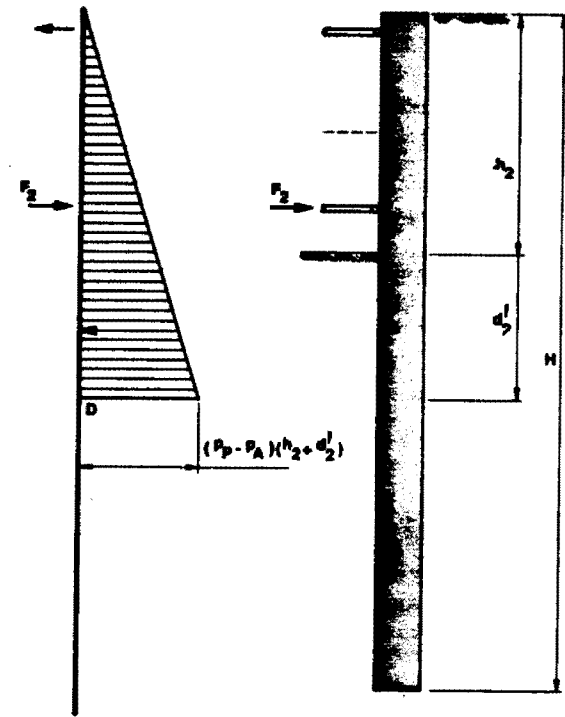
STAGE 1  
FIGURE 3 CANTILEVER EARTH PRESSURE ALTERNATE 3



STAGE 1'  
FIGURE 4 INSTALL AND PRESTRESS 1ST. BRACE

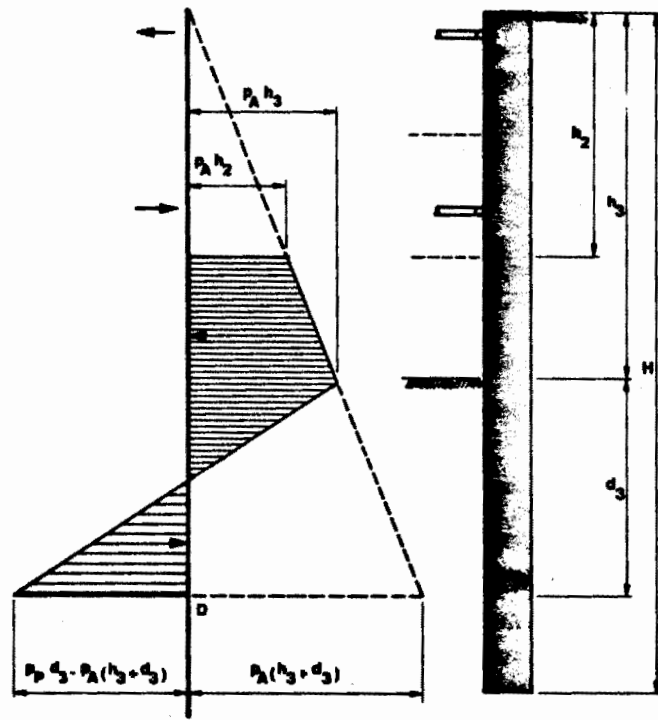


STAGE 2  
FIGURE 5 INCREMENTAL EARTH PRESSURE 1



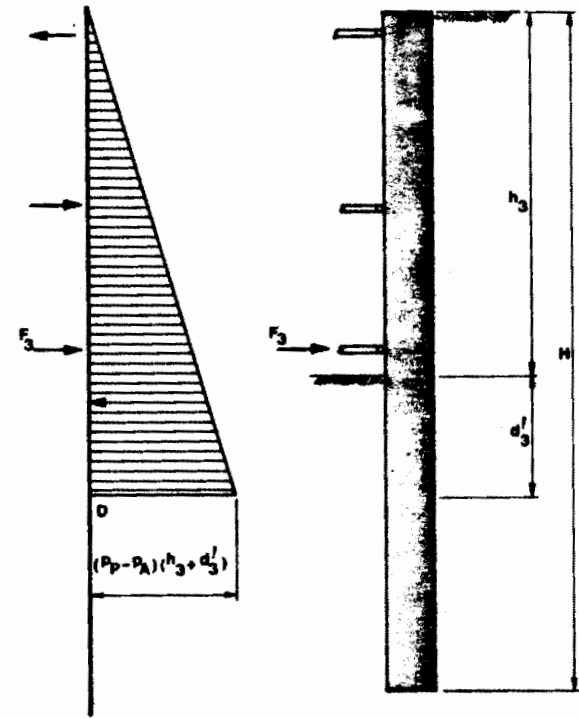
STAGE 2'  
FIGURE 6 INSTALL AND PRESTRESS 2ND. BRACE





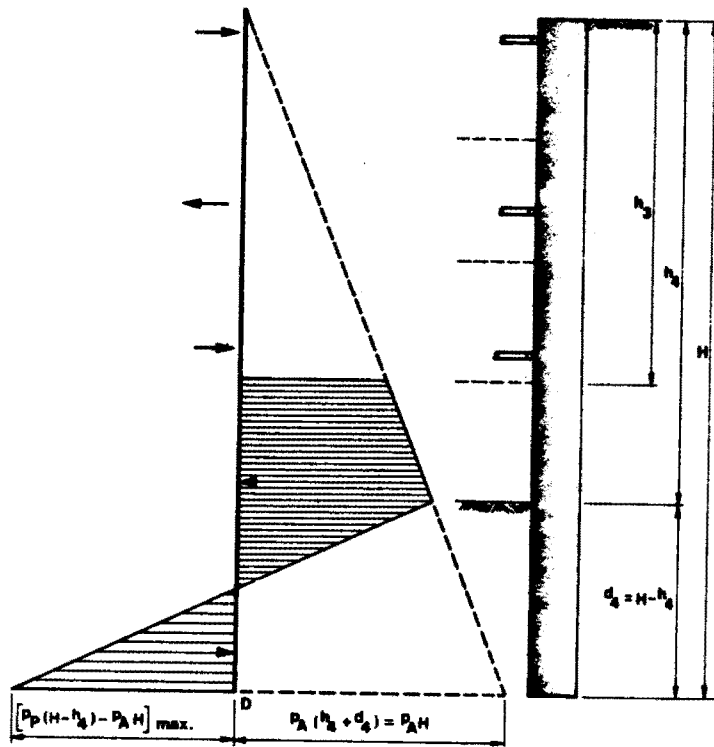
STAGE 3

FIGURE 7 INCREMENTAL EARTH PRESSURE 2



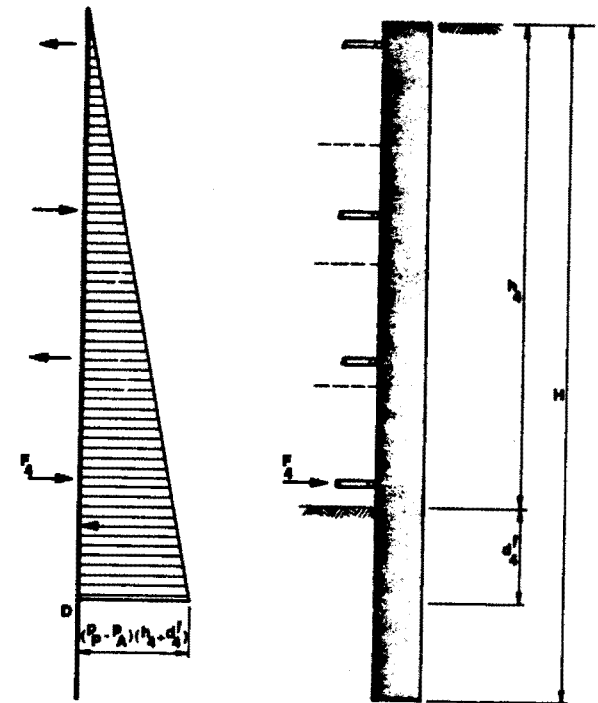
STAGE 3'

FIGURE 8 INSTALL AND PRESTRESS 3RD. BRACE



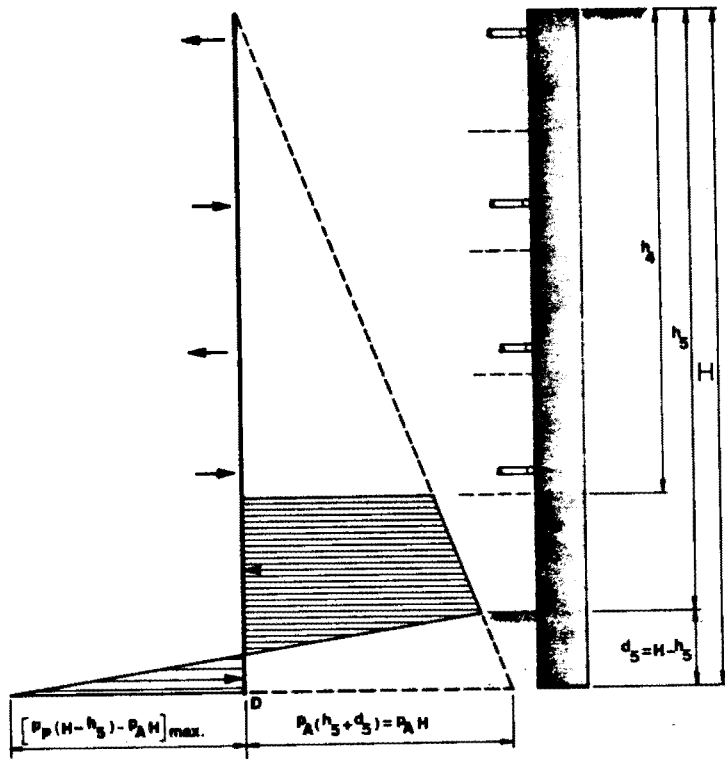
STAGE 4

FIGURE 9 INCREMENTAL EARTH PRESSURE 3



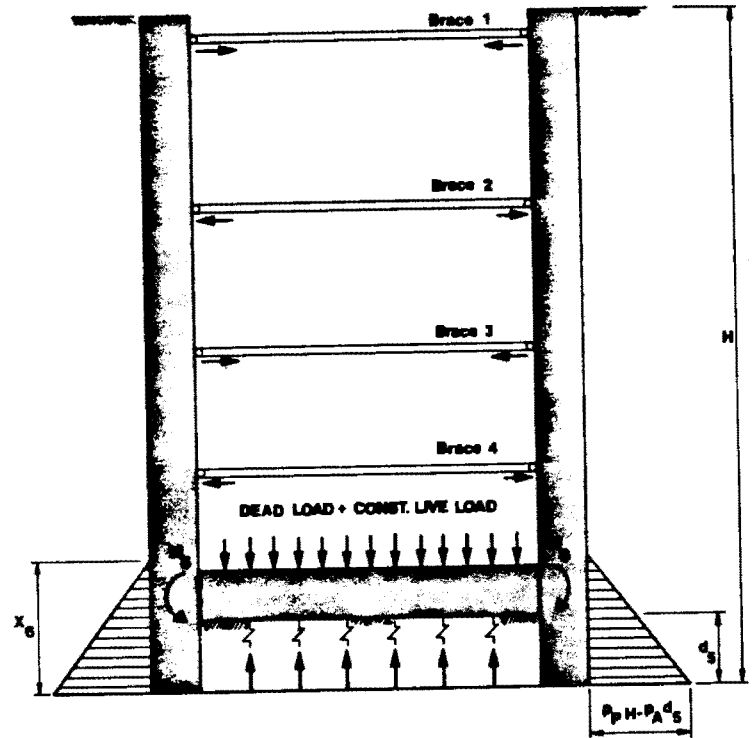
STAGE 4'

FIGURE 10 INSTALL AND PRESTRESS 4TH. BRACE



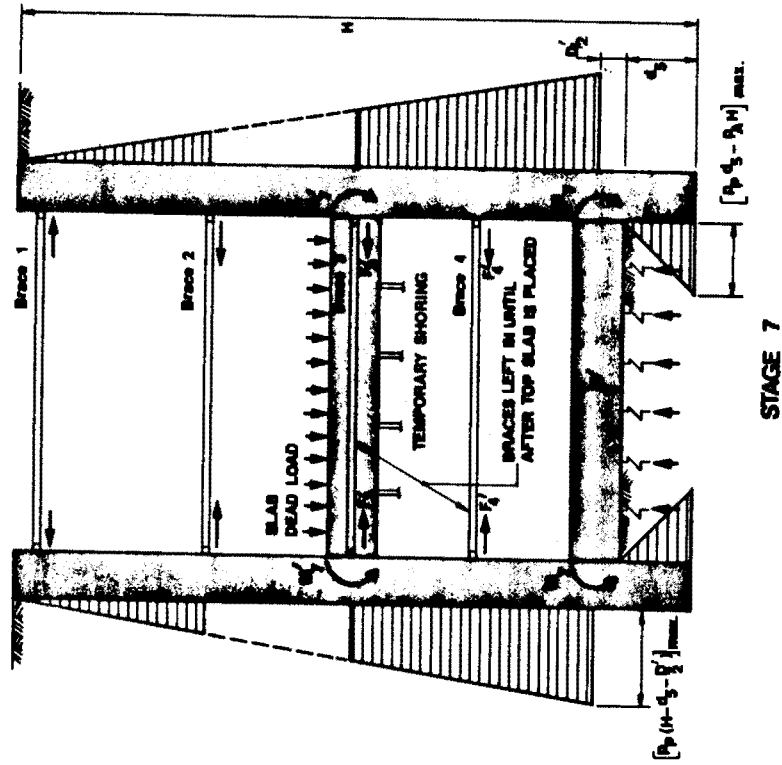
STAGE 5

FIGURE 11 INCREMENTAL EARTH PRESSURE 4

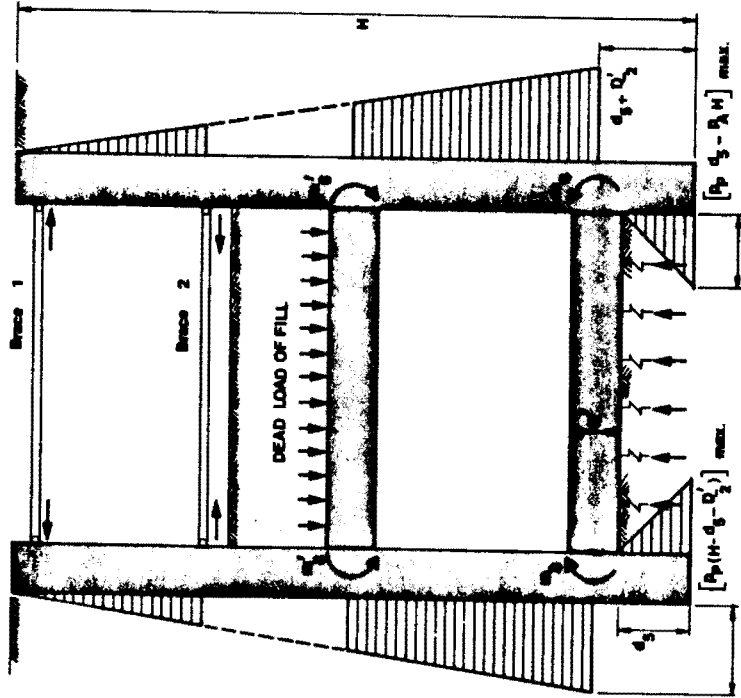


STAGE 6

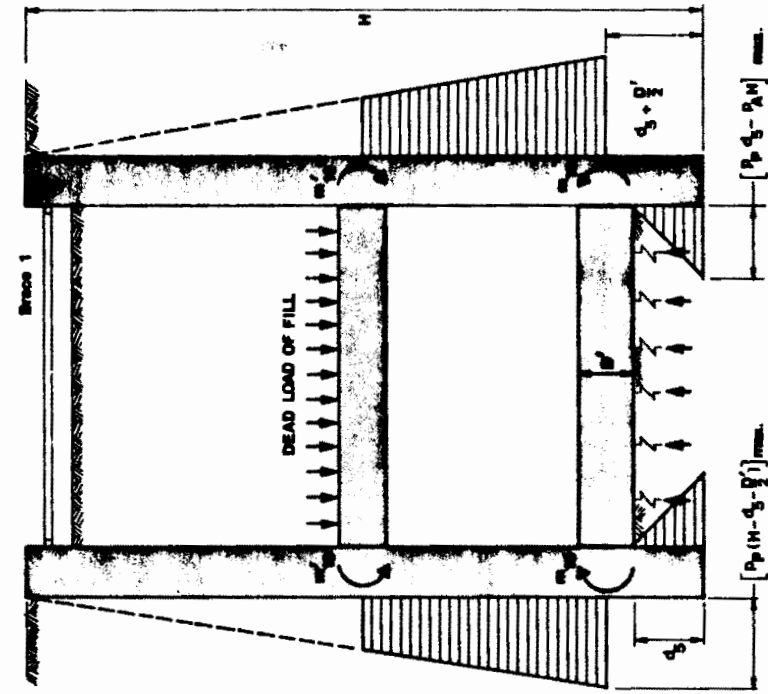
FIGURE 12 CONSTRUCTION OF BOTTOM SLAB



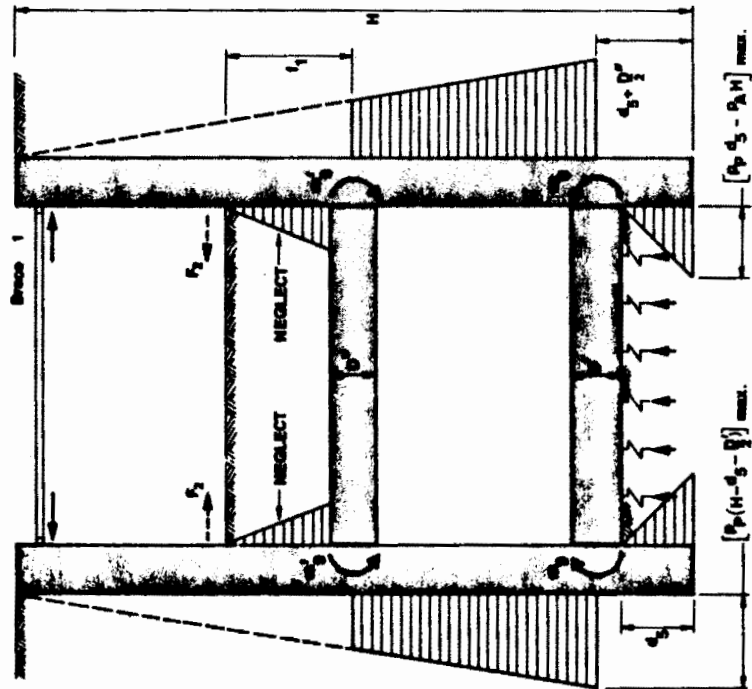
STAGE 7  
 FIGURE 13 CONSTRUCTION OF TOP SLAB



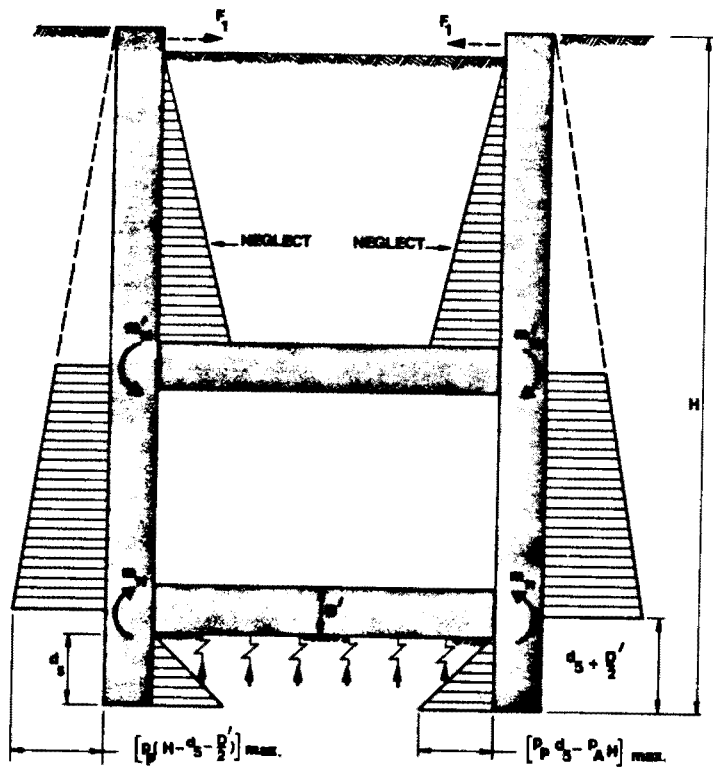
STAGE 8  
 FIGURE 14 BACKFILL UP TO BRACE 2



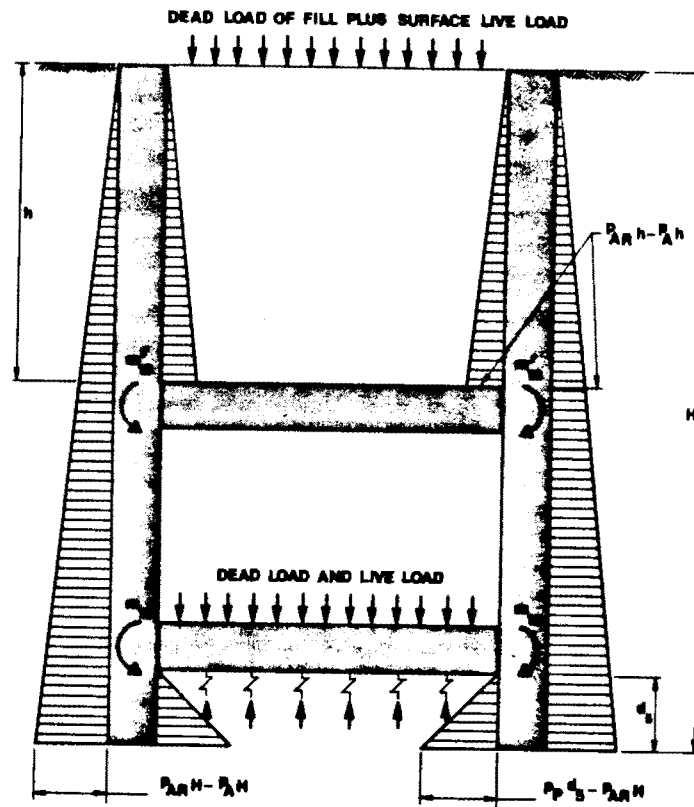
STAGE 10  
 FIGURE 16 BACKFILL TO BRACE 1



STAGE 9  
 FIGURE 15 REMOVE BRACE 2



STAGE 11  
FIGURE 17 REMOVE BRACE 1



STAGE 12  
FIGURE 18 FINAL LOADS

SPEAKER: Mr. J.S.B. Iffland  
Iffland Kavanagh Waterbury, P.C.

Gary Cantrell  
CH<sub>2</sub>M Hill

Question:

If I understand you correctly, when you install your braces, you are working with passive earth pressures. I have difficulty in understanding why you are going to passive in such an installation that would require movement of the wall and loading of the brace far above your at-rest condition. Can you explain if this is truly what you are doing, and if so, why?

Mr. Iffland

Answer:

Of course my applied pressure due to excavation is active. When I install a brace and I prestress it, what takes that reaction; some sort of passive pressure. Whether this passive pressure is fully developed is a question open to whoever is designing the wall. I have shown a fully developed passive pressure, this is the assumption made whenever you design any kind of sheet pile wall. I followed the traditional assumptions--however, you could assume, for instance my first assumption when I showed three different assumptions for the first stage of cantilever loading I showed that there was an example where you wouldn't develop full passive pressure. I tried to emphasize that you have that prerogative of changing your type of reactive pattern. You could, for instance, assume horizontal springs. You can't have tension springs, of course, but you can put some sort of spring pattern in where you think it will develop some sort of reaction to that prestressing force. You could vary your subgrade modulus to give you a pressure diagram which you think is the logical pressure diagram. This, of course, is something I do on my bottom springs--

Mr. Iffland (cont'd)

I forgot to mention that I put the bottom springs in there because I need them to satisfy equilibrium, both internal and external equilibrium when I have a closed box. Otherwise, my solution will not balance. That's the only reason I use the springs. When I put the springs in there, I vary the subgrade modulus because I know that if I assume a constant spring constant, I get a peak at the ends of the wall--and at the ends of the walls--don't deflect at that point so you can get a peak pressure there, so I adjust the spring constants to give me a pressure diagram that I think is logical. I show this pressure diagram in my TRB paper, for instance. I would do the same thing along the sides too. But yes, you are right. You do have to develop quite a bit of movement to develop passive pressures, but something is taking the prestressing force and you have to make some assumptions as to what is taking it.

Gary Cantrell

Question:

Could the prestressing forces be reduced to the point where you can design it for an at-rest or slightly above, rather than passive? There has to be a considerable difference. If it can be designed so, it might save some cost. How do you feel?

Mr. Iffland

Answer:

I think you will find that nobody builds these walls without any prestressed forces in the struts. They just feel this is the safe way to go. They have to prestress them; they don't want the struts to drop out on the worker who is underneath them, and the usual practice is to prestress them 100% of the force you develop in those struts in the final condition (maybe 150% in some cases) and that is a fairly large force; and if you look at struts, they are 16"-18" diameter pipe, or something like that, in order to take that kind of



Mr. Iffland  
(cont'd)

Amol R. Mehta  
Sverdrup & Parcel  
and Associates

Mr. Iffland

Mr. Mehta

Mr. Iffland

force. That force pushes up against something, and what you want to assume is your choice.

Question:

The statement you made at the beginning that there is no design method available--I just did not follow why you cannot choose any design method for any sheet pile which is very available and well studied and published. What is the difference between a slurry wall and any sheet pile as to the interactions between soil and structure the minute you get the forces and deformation.

Answer:

The pressure diagrams that I have assumed are consistent with sheet pile and walls...now practically, of course, sheet pile walls are very flexible, and slurry walls are very rigid, but the assumptions of the use of sheet piles and walls are really based on the walls being rigid, so they are more nearly true for slurry walls than for sheet pile walls. Does that answer your question?

Question:

The answer--what you said is if the wall is rigid, go to at-rest; if the wall is flexible, go to active?

Answer:

But I cannot advocate the assumptions to what the reactive patterns are. I am not really trying to sell anybody on my assumptions. What I am trying to sell is the incremental approach to keeping track of your stresses all the way through your construction procedure until your back-filling operation is complete. And to me, this is a consistent and rational design approach.

Mr. Mehta

Question:

The other point I would like to explore, when you speak of plastic, how much are we speaking about when you look at plastic design?

Mr. Iffland

Answer:

I'm speaking about plastic methods of analysis like you use in steel structures. The problem is, in this country we are not allowed to design concrete structures by plastic methods of analysis; yet, the code just does not permit it. The steel code does permit it. Basically, in plastic analysis, you develop plastic hinges at any highly stressed points; and in reinforcement concrete, is very advantageous because you can control those hinges by changing your reinforcing steel, and you can always force the hinge location whenever you want. For instance, we can force the hinge location by controlling the amount of the reinforcing steel at all the braces and also, maybe, at the top slab and the bottom slab to provide a partial moment connection by controlling the amount of reinforcement. Of course, you might have to go through several analyses to come up with the right solution. Don't confuse plastic analysis with ultimate strength analysis. Ultimate strength analysis is just the way of analyzing a given cross-section. Plastic analysis is the redistribution of moments through plastic hinges.

Mr. Mehta

Question:

No, my question was, what is the possibility of cost savings through plastic strength, what is the difference in percentage if you did one design straight and one design in plastic?

Mr. Iffland

Answer:

I would like to compare it to structural steel because I haven't really designed enough structures in concrete and plastic analysis to make a comparison. But in steel, plastic analysis vs. elastic analysis,

Mr. Iffland  
(cont'd)

you save 10% to 15%. In concrete, of course, the way you save is in reinforcement steel by redistributing your moments so you do not get the real high stress areas which you can control by the location of your plastic hinges. And just what that percentage is, I really don't know but would say it would be the same order of magnitude, 10%-15%. The real advantage of plastic analysis is that it permits a much easier design. You don't have to worry about your brace movements due to prestress. You don't have to have all these complicated indeterminate structures to analyze though I don't think they are very big complications. But you transform your structures into a mechanism, and you have a much easier solution.

## SITE CONDITIONS SPECIFIC TO SLURRY WALL CONSTRUCTION

by

DOMINIQUE L. NAMY, Ph.D.  
PRESIDENT  
SOLETANCHE AND RODIO, INC.  
MCLEAN, VA.

### ABSTRACT

The paper will describe, in a broad sense, special site conditions related to slurry wall construction.

First, the general parameters which lead to the choice of a slurry wall instead of traditional techniques will be discussed, including:

- Environment;
- Geotechnical conditions;
- Type of structure to be built;
- Labor "situation".

Next, conditions more specific to slurry wall construction, related to slurry wall design and construction sequence, will be reviewed. These include:

- Detailed analysis of the geotechnical conditions;
- Type of foundations of adjacent structures;
- Dimensions of the working platform;
- Design characteristics of the slurry wall.

An understanding of the above conditions will help to determine:

- Type of equipment required;
- Construction sequence;
- The need for preliminary soil treatment such as grouting;
- Type of bentonite, concrete, etc.

Finally, several complementary techniques, which are used in cases where the slurry wall does not provide a complete solution to the problem, will be outlined.

## SITE CONDITIONS SPECIFIC TO SLURRY WALL CONSTRUCTION

### I. Introduction

Slurry wall technology, developed nearly three decades ago in Europe, is now successfully applied in many parts of the world. It is used currently for the construction of both temporary and permanent earth retaining structures in Europe and in some Far Eastern and Latin American countries. But the use of structural slurry walls has been relatively limited in the United States, although the first applications date from the early sixties.

One may very well wonder why there is such a limited use of this technique in the U.S., especially as trenching under slurry has been and is currently performed for the construction of impervious cutoffs. In fact, the first trenches stabilized with bentonite slurry were excavated on the west coast in the early 40's.

There are many factors which explain why structural slurry walls have been used to a varying extent in different countries; these factors will first be reviewed briefly, then site conditions specific to the design and construction of slurry walls will be discussed.

### II. The Development of the Slurry Wall Technique as a Function of the Economical, Political and Social Environment

One common factor existed in almost every location where this technique was first considered for use: all were densely populated areas. This entails:

- o High cost of land
- o Zoning and development laws (i.e. limitation of the elevation of new construction, etc.)
- o Development and construction of mass transit system
- o In many cases, presence of historical landmarks to be preserved.

With all these restrictions, public and private developers had to make the best use of the space available, under the ground as well as above it. Thus, there was a market for improved existing technologies or the creation of new ones for performing deep urban underground excavation.

The evolution of the state of the art in Europe since 1930 has followed a logical path:

Piles

Secant or tangent pile retaining walls

Cast-in-place diaphragm walls

Precast diaphragm walls

The evolution from the tangent pile wall to the cast-in-place wall corresponded to the economical and physical necessity of decreasing the number of joints.

The evolution of machinery precisely adapted to these new procedures closely followed their development. Fig. 1 illustrates the excavation of panels using reverse circulation machines developed in France and Italy. Other specialized tools were also developed, such as the mechanical clamshell, and later the hydraulic clamshell.

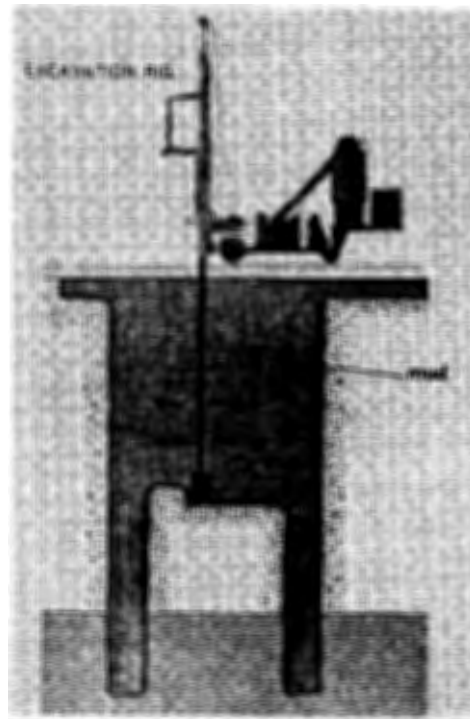


Figure 1

In the USA, however, the development of a very sophisticated highway system and the availability of land resulted in a primarily above-ground expansion, rarely requiring very rigid support for deep excavations.

Other factors were also important for the development of this technique. The encouragement of creativity and technical improvement leads to innovation. For instance, in France, contractors perform both design and construction work and can quote alternate solutions for most projects. Also, as the contractor is legally liable for the quality of his work for the 10 years following its final acceptance, owners and engineers are not too reluctant to accept innovation.

Labor is another important factor. Most European and Japanese firms have their own labor force; laborers usually remain with the same company for several years. Thus, it is worthwhile for the contractor to train his labor, which facilitates the use of relatively sophisticated processes. However, in many U.S. cities laborers familiar with the slurry wall technique are not available. This affects production and cost to such an extent that a procedure which should be competitive is not.

Nevertheless, it is believed that this technique will see great development in this country in the next five to ten years. The current size of many cities and their suburbs, combined with the increased cost of energy, should result in greater development within present urban boundaries; in fact, a number of urban mass transit projects are now under construction or in the design stage. In many cases, existing site conditions should encourage the selection of slurry walls as temporary and permanent structures. Some of these conditions are discussed in the next section.

### III. Site Conditions and the Design

The site and economic conditions as well as the type of structure to be built will dictate the optimization of the project, (see Fig. 2) For a transit system, the choice may be between an elevated and a subway system. For a structure, the developer must decide on the number of basement levels to be included in his design.

PREDESIGN STAGE

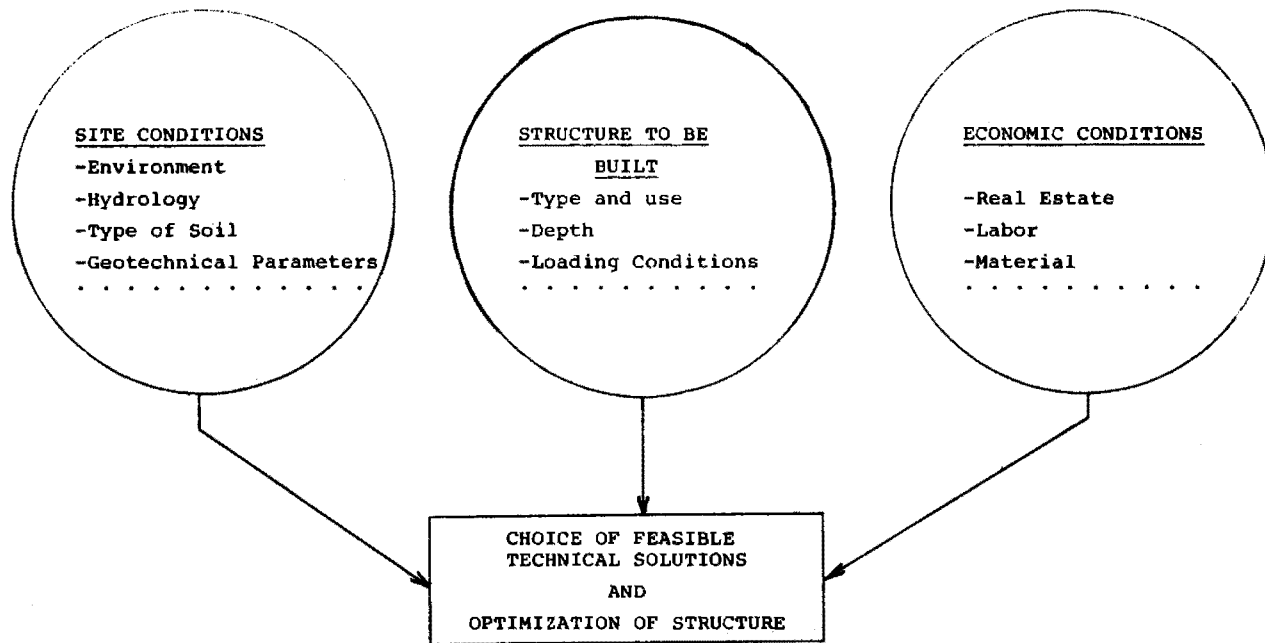


FIGURE 2

The most common techniques available to support excavation are shown in fig. 3. Obviously, the solution finally chosen should be the least expensive one appropriate to the project.



DESIGN STAGE  
DIFFERENT SOLUTIONS FOR EXCAVATION SUPPORTS

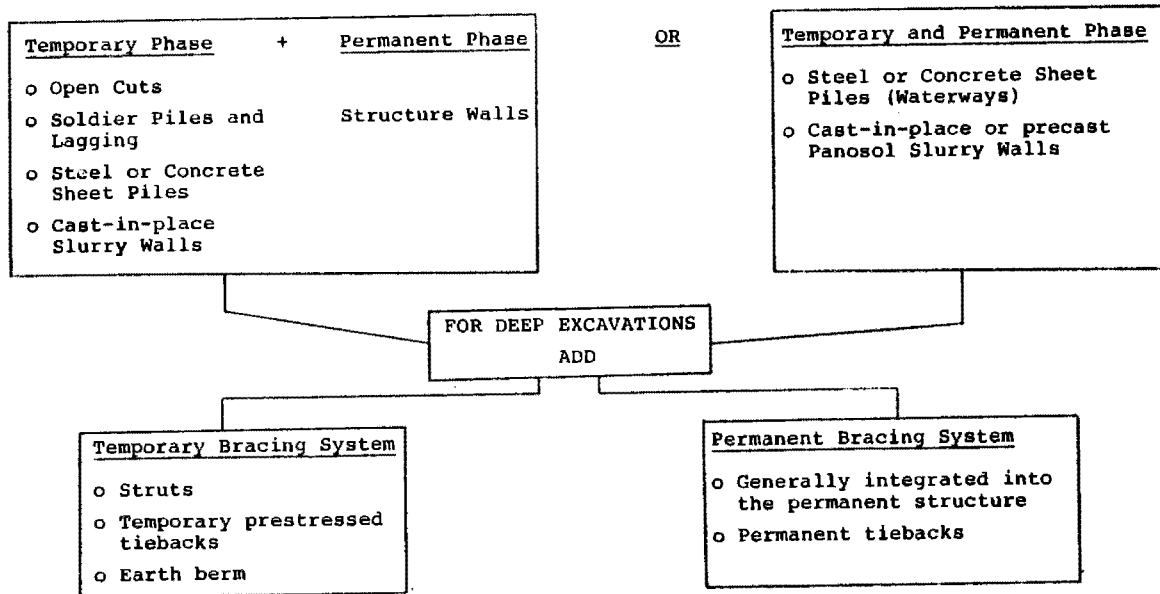


FIGURE 3

One of the reasons that the use of slurry wall has been relatively limited in this country is due to the fact that the procedure has very often been considered only as a temporary support system. Experience has shown that if at least part of the following conditions are met:

- o deep excavation in soils
- o urban environment
- o high water table

the slurry wall is in many cases the most economical as well as the safest solution, as long as it is designed as a support system for both the temporary and permanent phases.

The most important advantages of the technique are now well known and are summarized in figs. 4 and 5. Figure 6 illustrates some of these advantages:

DESIGN STAGE: SITE CONDITIONS LEADING TO THE CHOICE OF SLURRY WALL  
CORRESPONDING ADVANTAGES

| <u>Environment</u>   | <u>Advantage</u>  |
|--|---|
| -Mainly urban area<br>o High cost of land<br>o Densely populated | -Deeper substructure<br>-Increase in useable surface  |
| -Presence of multi-storey buildings, historical places           | -In most cases, no risk of disturbance to buildings   |
| -Nuisances   | -Not as noisy as sheet pile driving<br>-Minimum surface restoration<br>-Often minimum delay of construction |

FIGURE 4

DESIGN STAGE: SITE CONDITIONS LEADING TO THE CHOICE OF SLURRY WALL  
CORRESPONDING ADVANTAGES

|  |   |
|--|---|
| <u>Soil Conditions</u><br>-High water table +<br>• layers of compressible soils<br>• cohesionless material | -Decrease or eliminate dewatering<br>-No risk of material running<br>-Decrease or eliminate settlement<br>-No movement of adjacent structure, or within acceptable limits |
| <u>Economics</u>   | -Usually cheaper if wall is both temporary and permanent  |

FIGURE 5

- o An excavation (22 m deep) directly adjacent to an old building founded on footings or strip footings, without underpinning.
- o The technique allows the best use of available space.

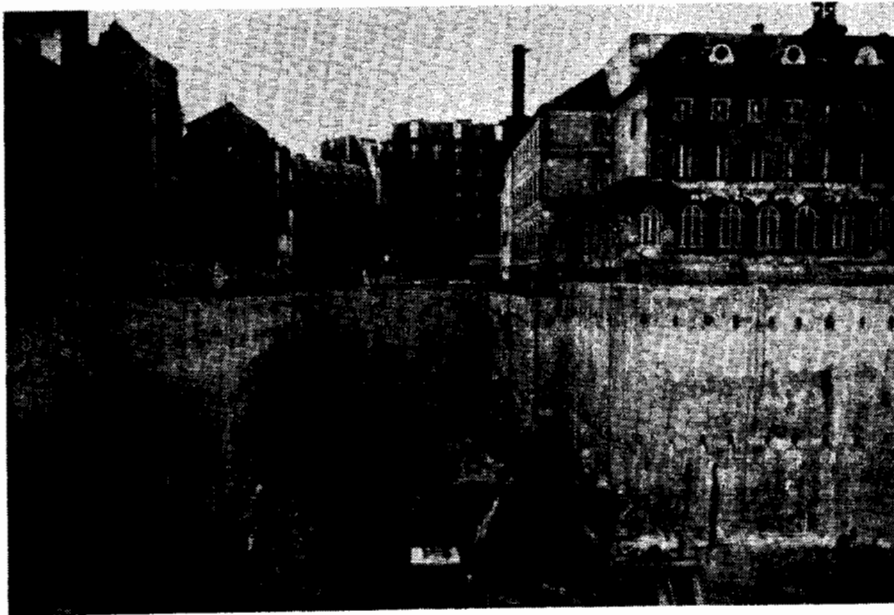


Figure 6

The cut-and-cover method, fig. 7, is a good example of how the technique can be used to minimize surface nuisances. As soon as the top slab has been cast and the roadway restored, practically all the remaining work proceeds underground.

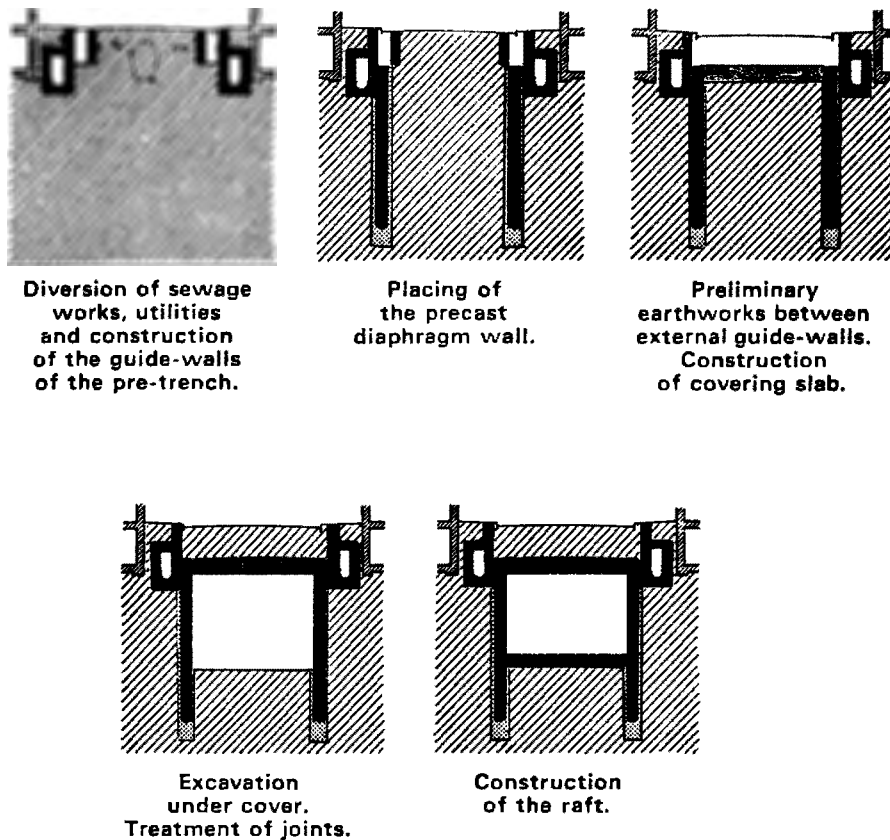


Figure 7 Cut-and-Cover Method of Construction

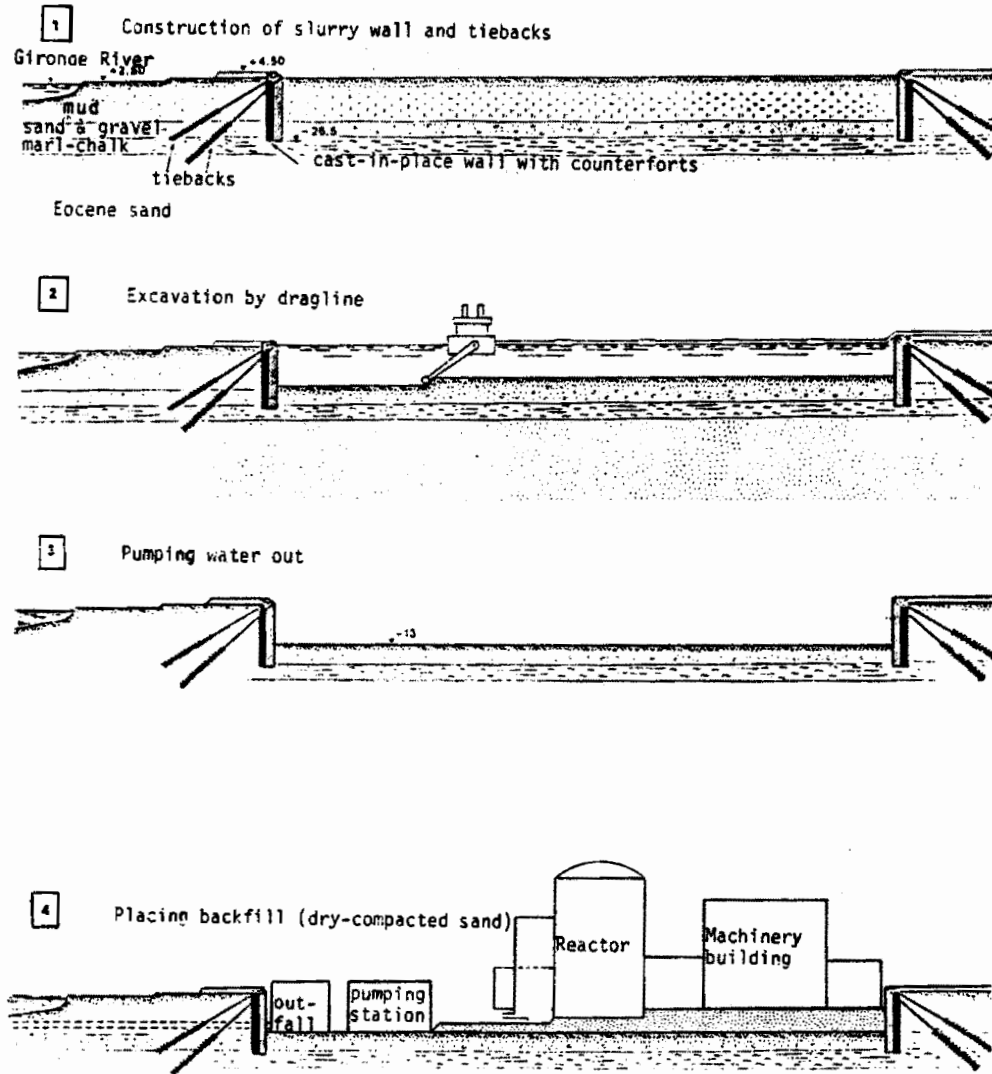
The technique can also be attractive in a non-urban environment, as illustrated in Fig. 8 and Figure 9. A huge excavation was necessary for the construction of a nuclear power station founded on a raft in extremely difficult soil conditions. The bearing soil was below a mud layer with a minimum thickness of 15 m. The water table was at the natural ground elevation.

The first solution proposed was to build a cutoff around the site and excavate the mud with stable slopes, necessitating the removal of about 2,600,000 cu. yd. of mud.

The solution finally selected, proposed as an alternate, was to construct a cast-in-situ wall forming both a retaining wall and a cutoff. The volume of mud to be removed was reduced to about 1,300,000

cu. yd. As shown in fig. 8 and Figure 9, the use of panels with a T-shaped cross-section, combined with only one bracing system of high capacity tiebacks on the top of the wall, allowed an economical excavation with a dredge.

PLAN OF EXECUTION



LE BLAYAIS NUCLEAR POWER PLANT

FIGURE 8

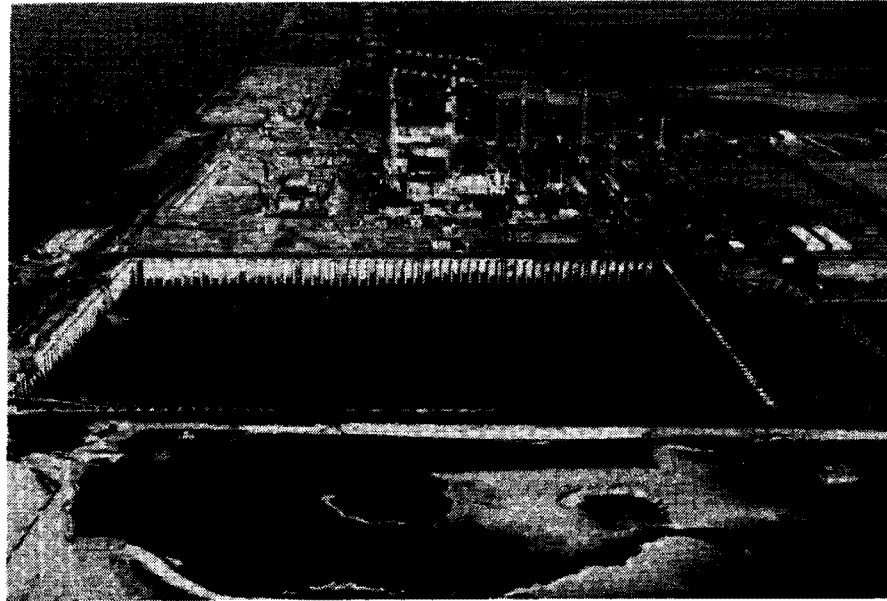


Figure 9

Slurry walls become even more attractive if they can also perform functions other than temporary and permanent support. For instance,

- o The transfer of vertical loads to the bearing soil layer during the temporary and/or permanent phases.
- o The transfer of the uplift pressure on the bottom slab through the mobilization of the friction between the wall and the surrounding soils.
- o If a continuous impervious soil layer exists below the future excavation, the wall can be embedded in it, thus also providing an effective water cutoff during construction. A simple draining layer below the bottom slab and the installation of a small pumping unit will solve the problems of uplift pressure and watertightness of the bottom slab. This solution is even more economical when a PANOSOL precast slurry wall is used as shown in figs.10a and 10b. The embedment of the panels

is designed only for the lateral stability condition and the excavation under cement-bentonite (C-B) slurry is extended to the impervious layer. Once it sets, the C-B slurry will provide a cheap, effective, vertical cutoff below the precast wall.

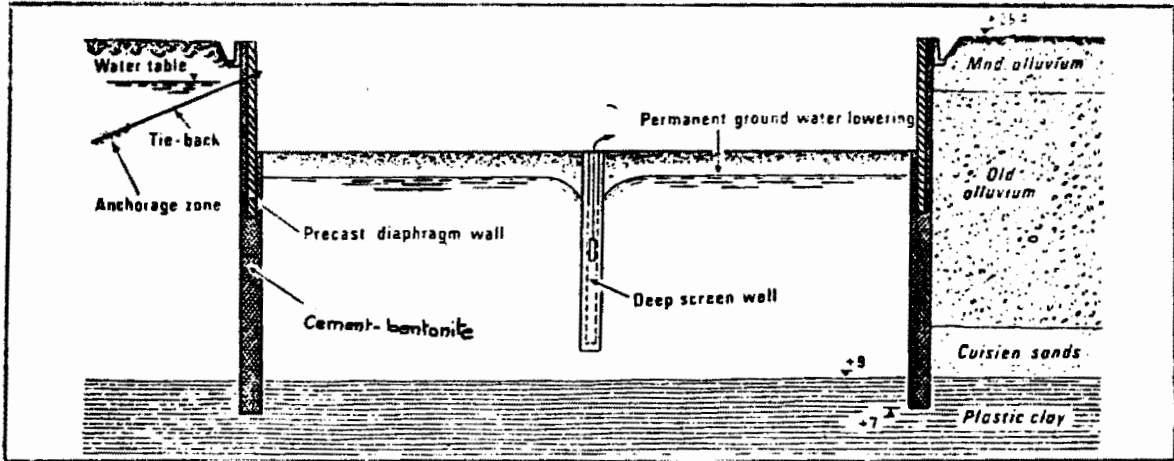


Figure 10a

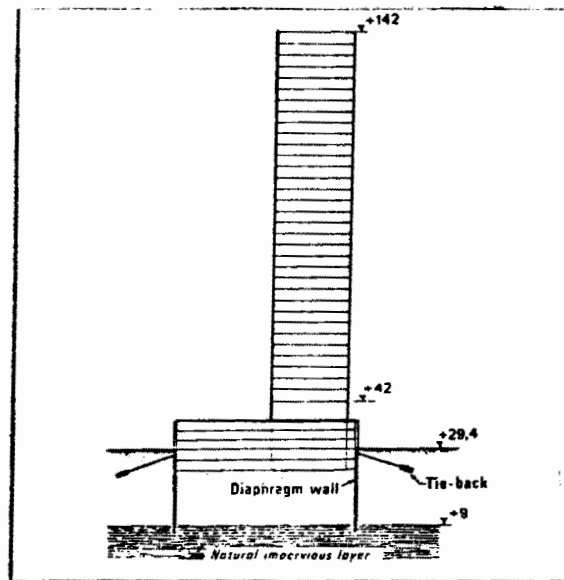


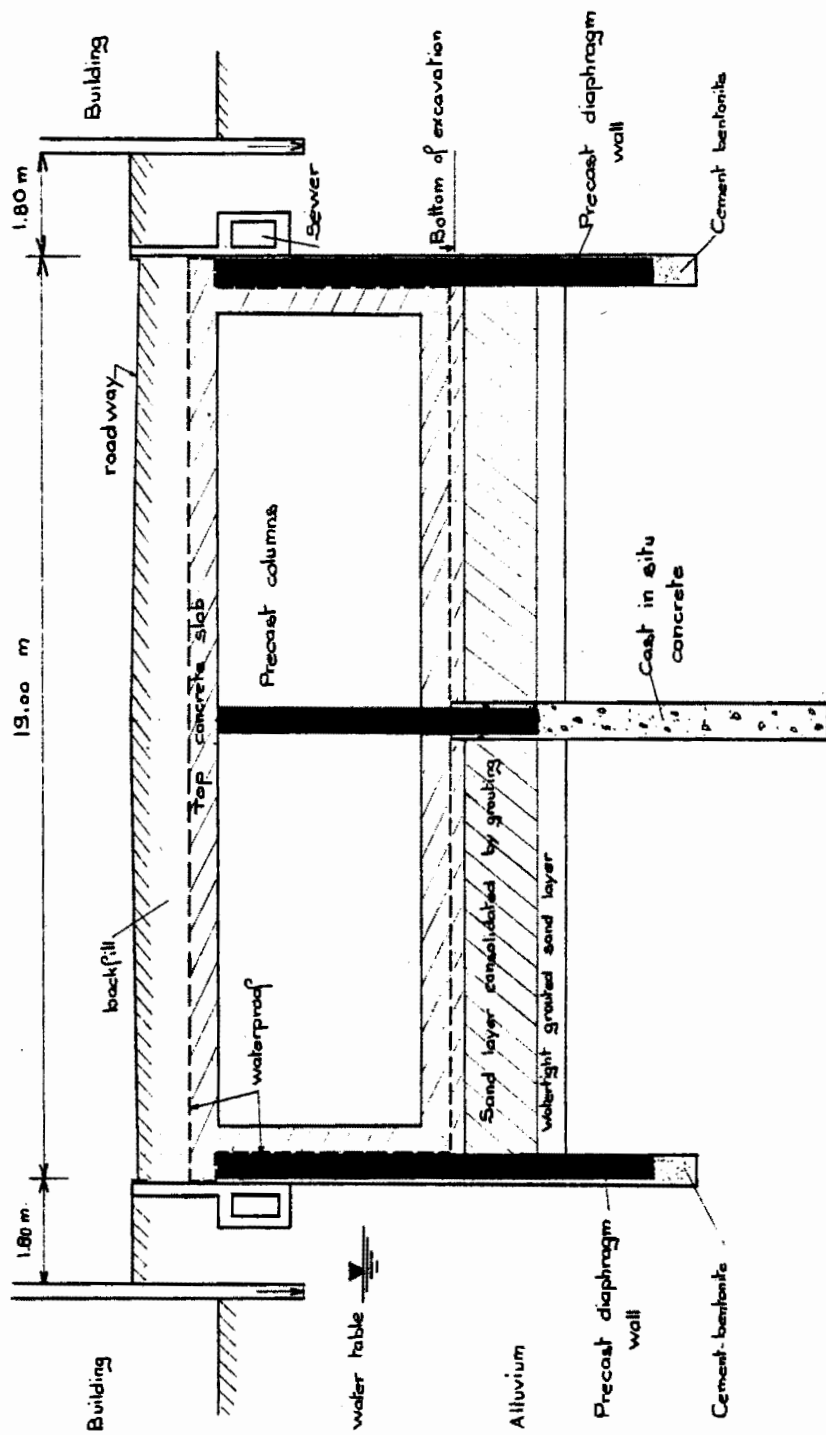
Figure 10b

Specific site conditions may be such that the use of slurry wall must be combined with other specialty techniques. Several uses of these combined procedures are discussed in the following paragraphs.

The problem most frequently encountered is the absence of an impervious layer in which the slurry wall can be embedded economically; and no lowering of the water table is permitted outside the future excavation. Several solutions are briefly discussed in the following sections.

- i. Dewatering plus underpinning of the structures which would be affected by the dewatering. This is economically feasible only when the latter are limited in number.
- ii. Dewatering within the excavation boundaries, plus realimentation of the water table outside, when soil conditions allow an effective realimentation.
- iii. Creation of an impervious horizontal layer between the toes of the slurry wall by grouting. Fig. 11 shows a case where a sand layer was grouted to render it watertight as no lowering of the water table was permitted. Since grout pipes were already in place, it was decided to take advantage of their presence to consolidate the loose sand layer in which the wall was to be embedded. By improving the characteristics of this layer, it was possible to reduce the necessary embedment of the precast slurry wall panels. This work was done for a subway station, shown under excavation in Figure 12.





SUBWAY  
Massena station in Lyon

FIGURE 11



Figure 12

Another case of grouted plug is shown in fig. 13 to eliminate dewatering during construction. The uplift pressure for the permanent phase is balanced by means of permanent vertical tiebacks.

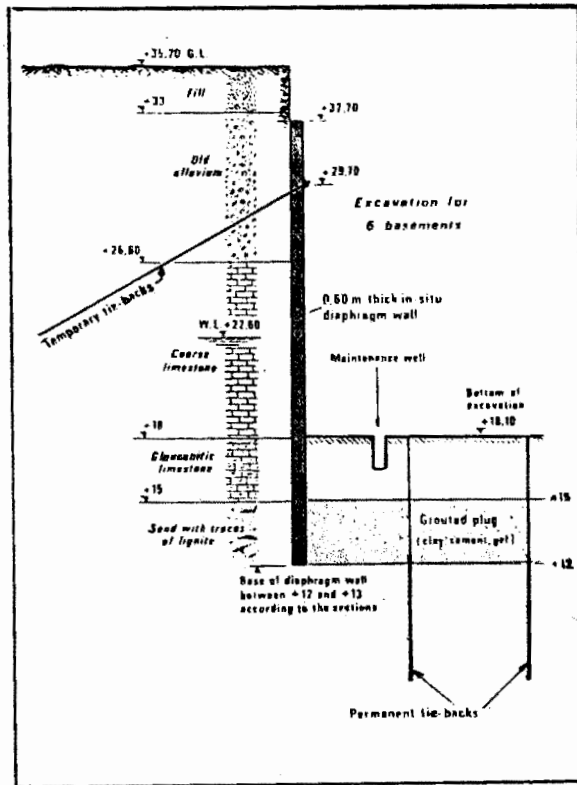


FIGURE 13

- iv. Where the excavation is through both overburden and rock material, it may be less costly to use a minimum embedment of the wall in rock. If necessary, the wall can be extended down by an effective vertical grout cutoff to prevent lateral flow through fissured bedrock. Fig. 14, Figure 15 illustrate a project where such conditions existed. Relief wells were added to insure the stability of the bottom limestone slab.

Another adverse condition existed at this project, the Lyon Station in Paris. The clock tower was founded on piles. Trenching under slurry along the piles and below their toes would not have prevented decompression of the sand and gravel layer. The solution was to grout the soil mass in front of and below the first row of piles down to an elevation where the surcharges would be insignificant. Then the construction of the wall could proceed with an appropriate sequence of trenching.

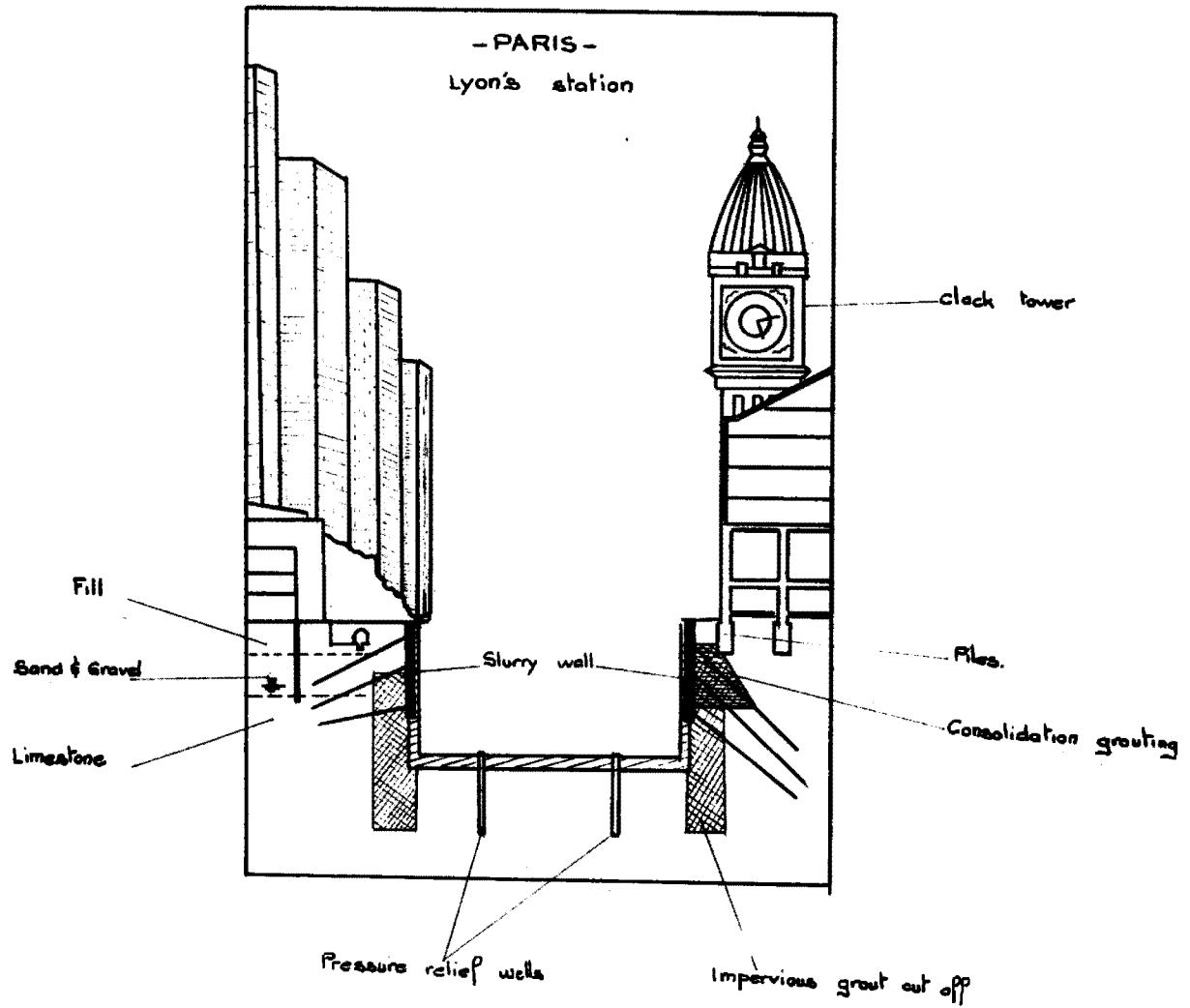


Figure 14

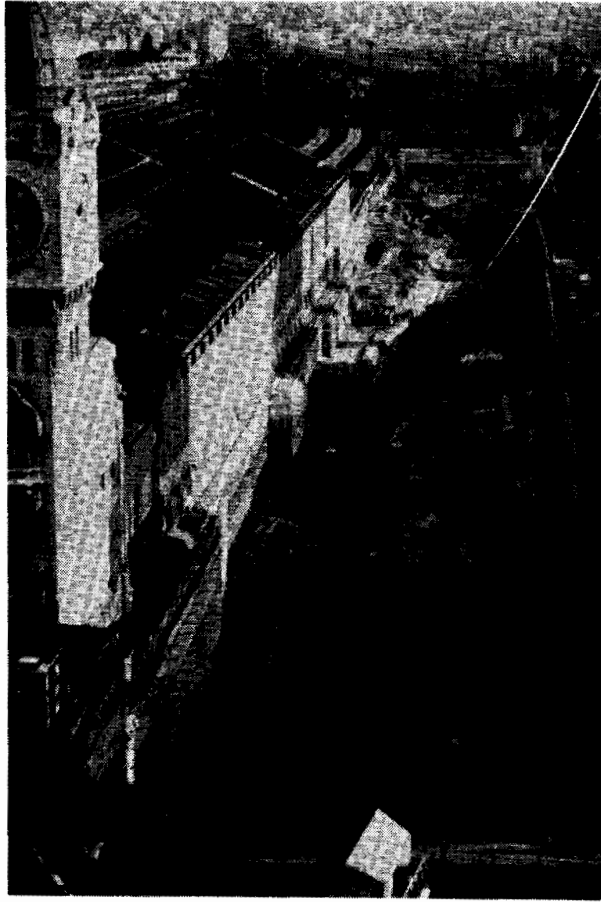


FIGURE 15

Some words of caution in regard to ground water are appropriate. The level of slurry in the trench should always be a minimum of 2 feet above the piezometric head of the soil through which the trench passes. If the water table is at or near the ground elevation, the working platform may be raised to the elevation needed. However, if artesian conditions exist on the site, it should be carefully investigated to check the feasibility of a slurry trench application, and during construction the stability of the trench should be carefully monitored.

Another technique associated with slurry wall is the pre-founded column. This is a "fast track" system where the columns of the building and the piles are installed from ground surface at the same time (fig. 16). This allows for the simultaneous construction of the substructure and the superstructure, and results in a considerable saving of time. Furthermore, the need for a temporary bracing system is eliminated. Thus, the combined use of diaphragm wall and pre-founded columns is often an economical solution for deep excavation in poor soils with a high water table, and when the cost of a temporary bracing system becomes burdensome.

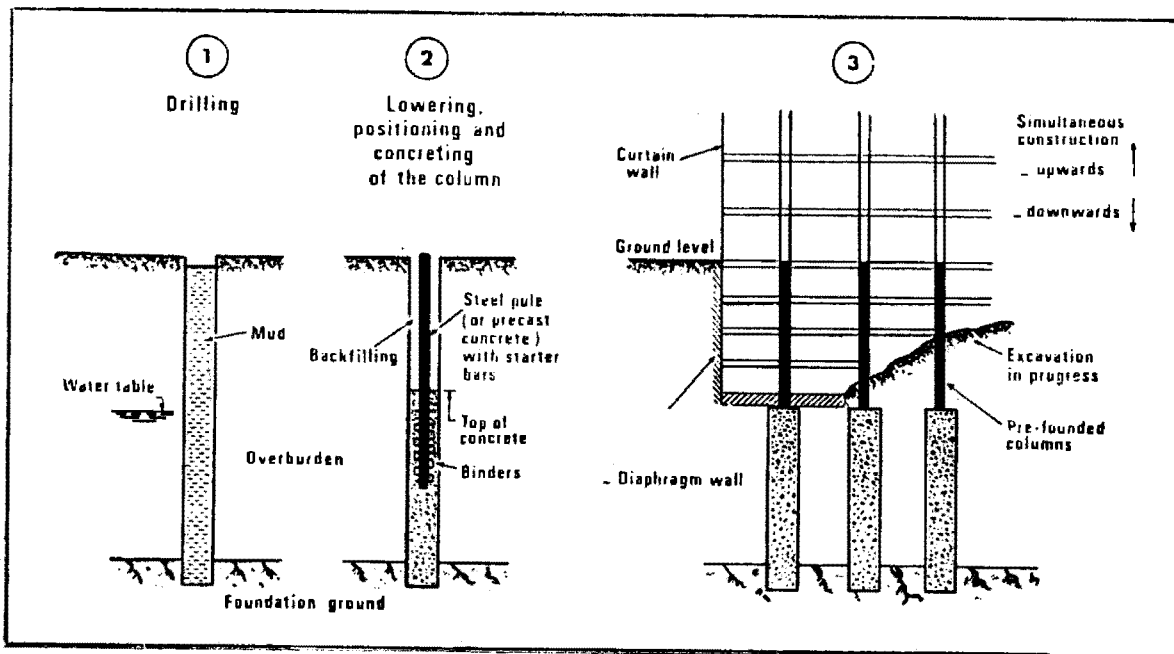


Figure 16

It is important to stress that slurry walls by themselves are in most cases only a part of the substructure system. However rigid a slurry wall is, the horizontal support system is a key element to minimizing horizontal displacements during excavation. The slurry wall and the bracing system must be designed and optimized as a whole.

#### IV. Site Conditions and the Specifications

The specifications should be closely related to the site conditions. The main factors to consider are mentioned in fig. 17.

SITE CONDITIONS AND THE SPECIFICATIONS

|   |  |
|---|--|
| Soil Conditions<br>+<br>Adjacent Building Foundations | -Necessary pretreatment<br>-Choice of maximum panel length<br>-Sequence of construction<br>-Required desanding |
| Depth of the Slurry Wall<br>+<br>Nature of Soils      | -Allowable deviation from verticality  |
| Chemical Nature of<br>o Soils<br>o Water              | -Type of<br>o Cement<br>o Bentonite<br>o Aggregates<br>o Additives<br>-Steel coverage                          |
| Utilities<br>Road Relocation                          | -Construction phases   |

FIGURE 17

- o The phases of construction depend on the time required for relocation of utilities and roads and on the estimated production of the work.
- o The maximum length of panels will vary with the nature and condition of the adjacent foundation, the soil conditions and also the estimated time to complete a panel.
- o As for verticality, the usual tolerance is one percent of the height. It should in fact also be related to the soil conditions and the depth of the trench. Obviously the deeper the trench, the more difficult and costly it is to control the verticality to 1%. The same can be said if excavation must be performed through very nonhomogeneous material.

## V. Site Conditions and the Contractor

This topic covers extensive territory. The physical characteristics of the wall to construct (thickness and depth), the type of soils through which the trench will be excavated, the development history of the area, the space available (horizontal and vertical), the condition of adjacent structures, the availability of materials and experienced labor and many other factors must be considered by the contractor when he plans his work, chooses his equipment and his team, estimates his production and his costs.

Some of the conditions frequently encountered are illustrated in the following figures.

- Work in a narrow street
- Rigs must be carefully selected
- Site congestion and its effect on production



FIGURE 18      SAINT DENIS, PARIS



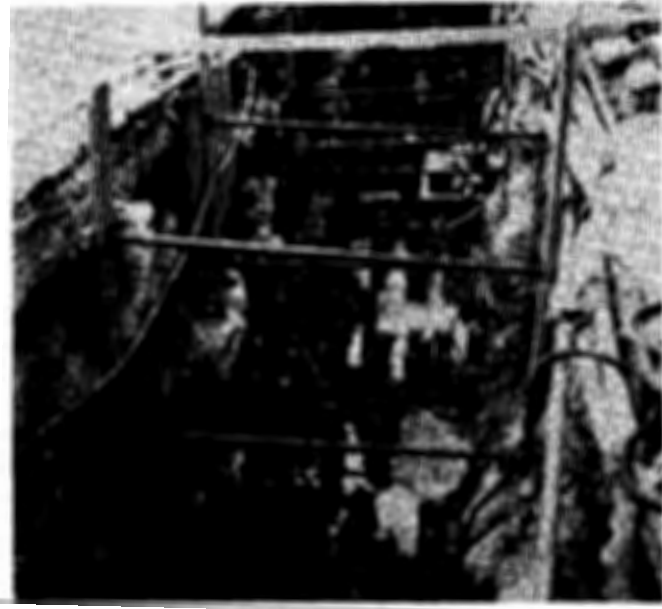


FIGURE 19



FIGURE 20

NATURAL AND MAN-MADE OBSTRUCTIONS.  
WHEN POSSIBLE, THESE SHOULD BE REMOVED  
PRIOR TO TRENCHING (HONG KONG)



FIGURE 21  
TYPICAL PROBLEMS OF UTILITY CROSSINGS (HONG KONG)

There are many unknowns related to underground conditions which can only be estimated by the specialty contractor. This is the most difficult part of the work, but also the most challenging.

To conclude, site conditions affect the construction of slurry wall in many ways. Numerous details require appropriate action prior to the work, action which may appear insignificant but is most important in order to eliminate the potential development of problems which may require difficult and costly solutions.

SPEAKER: Dr. Dominique Namy  
SOLINC

Oliver H. Gilbert, Jr.,  
Woodward-Clyde  
Consultants

Question:

Dr. Namy, you mentioned permanent tie-back anchors. How do you protect them against long-term corrosion?

Dr. Namy

Answer:

Well, we have quite a few techniques for that, according to the type of tie-back. One of the techniques most used right now is to cover the free end with a plastic tube to inject between the plastic tube and the bar itself some epoxy or cement grout.

SLURRY WALL CONSTRUCTION,  
CONSTRUCTION PROCEDURES AND PROBLEMS

by

GEORGE TAMARO  
VICE PRESIDENT & CHIEF ENGINEER  
ICOS CORPORATION OF AMERICA, NEW YORK, NEW YORK

ABSTRACT

The technique of constructing below grade structural walls by the bentonite slurry trench method, now an internationally accepted construction procedure, continues to find widespread use in the United States in both temporary and permanent walls for transportation facilities.

Since the technique originally developed as a construction innovation and the procedures and tools used to construct the wall are critical to their proper performance, it is essential that the designers of such wall systems understand in detail how the walls are built.

This paper will focus on the procedures, tools and details which the designer must consider in the preparation of contract specifications and drawings, as well as those which can cause extra cost or difficulty when required to be used in the field.

Additionally, the paper will outline the degree of finish and accuracy of placement normally obtained, as well as procedures and methods which must be used to obtain accuracy in excess of those limits.

## SLURRY WALL CONSTRUCTION CONSTRUCTION PROCEDURES AND PROBLEMS

### INTRODUCTION

The techniques of constructing below grade structural walls by the bentonite slurry trench method, an internationally accepted construction procedure, continues to find widespread use in the United States in both temporary and permanent walls for transportation facilities.

Since the technique originally developed as a construction innovation and the procedures and tools used to construct the walls are critical to their proper performance, it is essential for anyone considering the use of such a wall system to understand in detail how the walls are built. Inappropriate details or procedures can cause significant increases in the cost of the work as well as a defective end product.

### GUIDEWALLS

Guidewalls are essential for the accurate control of the alignment and elevations of a slurry wall. They serve as a guide for the excavation and then as the support for the reinforcing cage prior to and during the concrete pour. The excavation for guidewalls should be carried down to the elevation of the lowest utility or to the level of the footing of any adjacent structures. All terminated utilities should be removed and plugged, and openings in walls of adjacent structures should be sealed. In the cases where guidewalls are not provided against existing structures, those structures should be protected by a cement plaster coat or a lining of plywood or steel plate. The trench should be backfilled to the underside of the guidewalls with a lean concrete or a clean, well compacted backfill.

Guidewalls are usually six to twelve inches thick, three to six feet deep, and are normally reinforced with only four #6 bars running longitudinally. (Figures 1 & 2). As a practical matter, only the inside face of the guidewalls should be cast against the soil sides of the trench. In many locations, guidewalls need not be removed after final construction is completed. In these cases, the guidewall on the unexcavated side of the wall should remain in place, while the guidewall on the inside (or excavated) side of the wall is removed during the general excavation.

### BUILDING AND UTILITY PROTECTION

Plastic sheets, plywood or steel plates may be necessary to protect adjacent, above grade structures from damage or bentonite splash. In some cases where structures are of a low quality and sufficiently far from the edge of the excavation no protection is necessary while in other cases where a high quality building is adjacent to the edge of the trench it may be necessary to provide steel plates and/or plywood to protect from impact of the excavating tool and plastic sheets to protect against splash at higher elevations.

Utility lines which cannot be removed must be located, exposed and protected (Figure 3). Protection is usually done by wrapping the utility with a layer of soft compressible material (wood or plastic foams) and then an outer layer of steel plate or concrete. The outer steel or concrete layer should extend into and be supported by the guidewalls.

### EXCAVATING TOOLS

All surveys of slurry wall excavating tools list dozens of different machines, all believed by their designers to be the "ultimate tool". The truth of the matter is that after several uses, almost all of these tools prove to be technically impractical and commercially non-viable. As a result, slurry wall construction has been executed by a limited number of special pieces of equipment.

These excavating tools are listed below, with least popular tools listed last. (See Figures 4, 5, 6)

#### Soil Excavation - Soft to medium hard ground

- 1) Mechanical clamshell bucket, cable hung
- 2) Hydraulic clamshell bucket, cable hung
- 3) Hydraulic clamshell bucket on kelly bar
- 4) Mechanical clamshell bucket on kelly bar
- 5) Rotary drills with bentonite circulation

#### Soil Excavation - Hard and Bouldery Ground

- 1) Clamshell buckets listed above with or without percussion drills
- 2) Percussion drills with or without bentonite circulation
- 3) Rotary drills with bentonite circulation

#### Rock Excavation

- 1) Percussion drills with bentonite circulation.
- 2) Rotary drills with bentonite circulation
- 3) Explosives with percussion and circulation

(See Figures 7, 8, 9 for excavation sequences)

### PANEL DIMENSION AND ARRANGEMENT

Panel dimensions are usually controlled by both the technical requirements of the work and the type and size of equipment available. Panel lengths can be no shorter than the length of the bucket and no thinner than the width of the bucket. Short panel lengths are usually in the range of seven feet, and should be used in loose unstable materials or in areas where there are very high surcharge pressures from adjacent structures. Longer panels, ranging up to thirty feet in length, can be used in cohesive soils or other stable materials. Specific panel sizes are dependent upon location of the

panel joints since the panel joints must be coordinated with the permanent framing system, the temporary bracing scheme or the location of adjacent footings.

Wall thickness is usually twenty-four, thirty, or thirty-six inches. However, if it is necessary for the diaphragm wall to carry a high lateral load, to span large distances between supports or to carry substantial vertical loadings, the thicknesses can be increased up to sixty inches.

The "Bottom of Wall" elevations are governed by the location of the top of rock, by the need to embed the wall in an impervious strata, by the need to prolongate flow lines through a pervious strata, to secure a stable bottom during the construction period, or by the need to provide lateral support for the wall during the excavation and bracing process.

If the bottom of the wall is to be seated on rock, care must be taken to verify the location and nature of the top of the rock. The top of the rock must be satisfactorily cleaned prior to the placement of concrete in the panel.

If the bottom of the wall is to be seated in a rock socket, the rock socket should be sufficiently deep to provide the function required, i.e., lateral support, load bearing capacity or watertightness.

Furthermore, if the general excavation is to be carried down into the rock to a level below the bottom of the wall, the wall must be structurally stable when and if the rock in front of the wall or below the wall is fractured or removed by blasting.

The "Top of Wall" elevation is governed by the details of future sub-grade and superstructure construction, by the location and elevation of adjacent footings, by the location of existing and future utilities, and by the need to trim or remove sections of the wall at a later time.

#### WALL REINFORCEMENT

In general, slurry walls are reinforced by either steel reinforcing bar cages, high strength post tensioning steel or steel wide flange or built up sections.

#### REINFORCING STEEL CAGES

Reinforcing steel cages should be detailed as simply as possible and the same details should be repeated as often as possible. The designer should strive for only one layer of horizontal and vertical reinforcing steel on each face of the wall. Splices should be minimized and, if possible, totally eliminated. Provision should be made for field alterations of all cages. (See Figure 10)

Unforeseen site conditions usually require a greater or lesser depth of wall; the cage may also have to be altered in order to accommodate a revised panel length. Accessories may be added, removed or relocated during construction.

Welding of cages is to be discouraged. Erection stresses often cause even the best prepared weld to fail. Cages and accessories should be securely tied with tie-wire.

A minimum three-inch cover should be required over each face of reinforcement. Wheel spacers, skids or other spacing devices should be used in order to guarantee the specified cover. Cages should be securely suspended from the guidewalls and kept six inches clear of the bottom of the excavation.

Shop drawings should plan for and accurately show the details and locations for all bracing plates, tieback anchor trumpets, beam seats, keys and pipe sleeves. These accessories should be detailed and located in such a manner that they will not interfere with the placement of the concrete. The location and details of group pipes, tiedown anchor sleeves, slope indicator tubes and even the tremie pipe must be studied in detail and shown on the shop drawings. Complicated, poorly conceived details will guarantee problems in the field.

#### CONSTRUCTION JOINTS BETWEEN PANELS

Construction joints between panels are achieved in a variety of ways (Figure 11, 12). The most basic and simplest methods are the half-round joint formed by a stop end pipe or joints formed with steel wide-flanged sections (Figure 13). Less often used are joints formed by square-end buckets and joints incorporating sheetpile sections or break-away keys set into the pour. Complicated joint details are expensive, difficult to install and perform unsatisfactorily in less than ideal conditions.

#### DESIGN OF CONCRETE MIXES

Because of variations in materials, mixing equipment and skilled labor, it is difficult to recommend a specific concrete mix design; however, there are several rules which should be followed in the design of the mix. With hard gravel being preferred over crushed gap-graded stone, the aggregates used in the mix should be well graded. A sandier mix similar to a "pump-crete" mix will flow better in a tremie pipe and throughout the panel and is therefore preferred. Plasticizers and air entrainment mixtures are recommended. Design mixes should range between 3,000 psi and 5,000 psi ultimate strengths and should be designed and tested with enough water to guarantee that an eight-inch slump will be achieved. It is important that all personnel involved in the execution of this work understand that an eight-inch slump is essential for the proper casting of these panels and that the people in the field are not to be permitted to tamper with the mix.



A four-inch slump concrete gives fine results in a laboratory but guarantees improperly cast walls. The surface will be honeycombed, the joints will be irregular and improperly concreted and an occasional cold joint will occur due to the difficulty of placing this material through a tremie pipe into a long, narrow excavation.

### CONCRETE PLACEMENT

If excavations are performed in fine sand, or with percussion tools used to drill boulders or bedrock, it is imperative that the panel be cleaned prior to the placement of the concrete. Otherwise the fine sand particles will settle to the bottom of the panel, or if held to suspension by the bentonite, will mix with the concrete and form pockets of "mud" in the panel. These mud pockets usually flow to the edges of the panels or get "hung up" in the cage.

Panel cleaning can be done well by an airlift and desander (Figures 14 and 15) at the trench or by complete replacement of contaminated bentonite with fresh bentonite and less effectively by flushing the bottom of the panel with fresh bentonite or by cleaning the bottom with a "toothless" clamshell bucket.

A single eight-inch or ten-inch diameter tremie pipe centrally located within the panel is recommended. The tremie hopper should be large enough to receive the occasional surge of concrete and prevent the spillage of concrete from the hopper into the trench (Figure 16 and 17). It is wise to require the placement of a four to six-inch mesh screen at the hopper in order to prevent the entry of large balls of concrete which occasionally occur with high cement content concretes.

The concrete pour should proceed as rapidly as possible. However, it should always be timed in such a manner that a continuous concrete pour is maintained. Disruptions in the delivery of concrete guarantees a cold joint in the panel and a future source of leakage.

At the conclusion of the concrete placement, the stop end pipe must be extracted from the excavation; it must be removed at a rate slow enough that it is never raised above the level at which the concrete has already set and at a rate fast enough that the pipe will not become stuck within the panel (Figure 18).

### QUALITY OF THE IN-PLACE CONCRETE

If a correctly designed mix has been properly placed, it is almost impossible for the concrete to not achieve its design strengths. Experience has shown that cylinders taken during the pour usually show concrete strengths ten to fifty percent greater than the strength specified, and that cores taken from a wall even under the most disadvantageous placement conditions are apt to have strengths equal to or more than fifty percent greater than the strength specified.

The question of permissible bond stresses continues to remain unanswered; some researchers and designers recommend the use of allowable stresses as much as seventy-five percent of the ACI code allowables while other researchers and designers recommend no reductions at all. In most cases, the argument about allowable bond stresses is a mute argument since actual computed bond stresses are far less than the allowable stresses.

#### ACCURACY, TOLERANCES AND FINISH

Construction accuracy and finishes usually are dependent upon the geology of the site and the contractor's skill and tools. However, properly executed diaphragm wall construction should fall within the following tolerances:

The vertical joint at the end of a panel formed with an end pipe should fall within six inches of the specified location, while the location of a panel formed by a steel beam should be within three inches of its theoretical location. Inserts within a cage should be within three inches horizontal and three inches vertical of the specified location. Keys and dowels should be permitted a three inch variation in vertical location and should not be required to develop the moment capacity of the member framing into the wall.

Greater accuracy can be achieved in the construction of diaphragm walls; however, the amount of the additional cost necessary to achieve a small improvement in the accuracy of construction must be weighed against the cost of corrections performed on the wall upon exposure.

Tolerances should be increased by fifty to one-hundred percent in the cases where walls are excavated through loose boulder-laden soils or fills consisting of piles, timbers and other loose debris.

The finish of the wall is a direct reproduction of the soil surfaces against which the wall is cast and the tools used to excavate the panel. (Figures 19 and 20). A loose boulder removed from the excavation leaves an indentation in the side of the excavation. Concrete placed within the excavation will fill that indentation and will appear as a protrusion on the finished wall. The occasional bump should be trimmed from the face of the wall and any voids should be filled. Occasionally a wall is parged, and most often the as-cast wall serves as the final wall finish (Figure 21).

Some designers specify the construction of an independent masonry wall anywhere from three inches to three feet from the face of the diaphragm wall. In the case where larger distances separate the masonry wall and the diaphragm wall, the space between the two walls is used as a pipe chase, as an electrical conduit run, as a plenum and as a drainage channel for any water which might seep through the wall.

Properly executed slurry walls are water-tight throughout the panel. Occasionally seepage will occur at the vertical joint between panels, at cold joints, or at tieback trumpet locations (Figure 22). The first two

problems are the full responsibility of the slurry wall contractor and will be sealed by him after the wall is exposed. The joint or crack is chipped out and cleaned and then packed with rapid-setting grout mixes. Occasionally it is also necessary to chemically or cement grout the soil directly behind the wall at the location of the leak.

### CONCLUSION

This paper has outlined the basic features of the design and the construction of the diaphragm walls. It has warned of some of the problems that can be expected in the use of the diaphragm walls and has offered guidance in the planning and construction of sound, practical, economical walls.

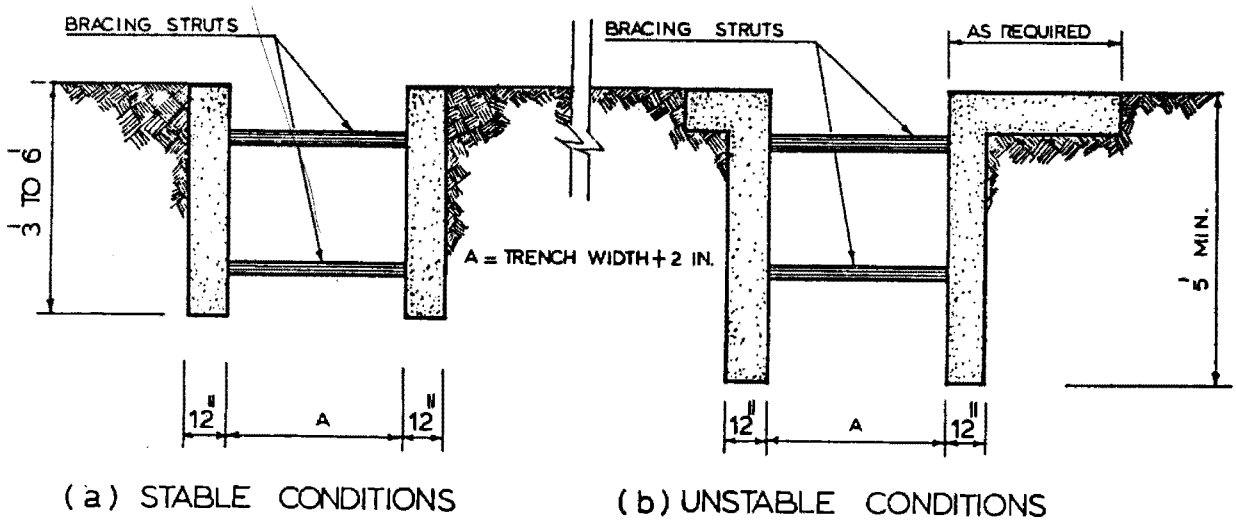


FIGURE 1 TYPICAL GUIDEWALLS



FIGURE 2 T SHAPED GUIDEWALLS



FIGURE 3 LOCATING & EXPOSING UTILITIES AND PIPES FOR REMOVAL OR PROTECTION



FIGURE 4 A MECHANICAL CLAMSHELL

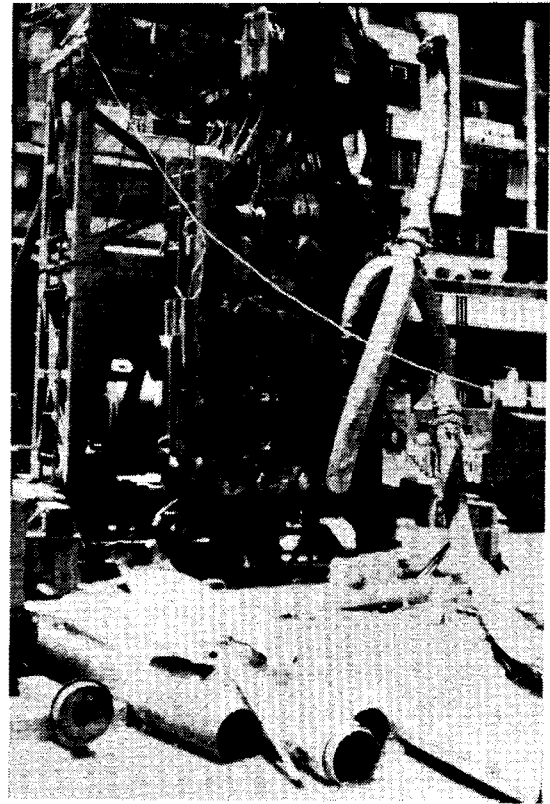


FIGURE 5 ONE TYPE OF ROTARY DRILLING RIG



FIGURE 6 A CHISEL FOR PERCUSSION WORK

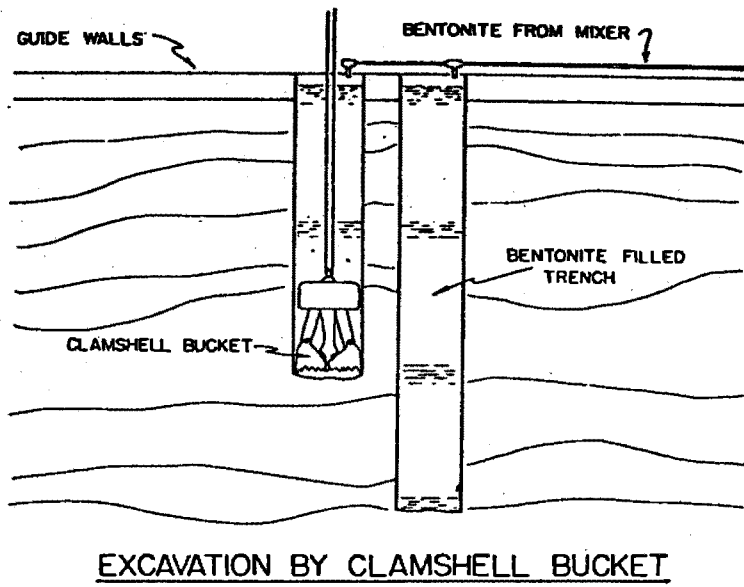


FIGURE 7

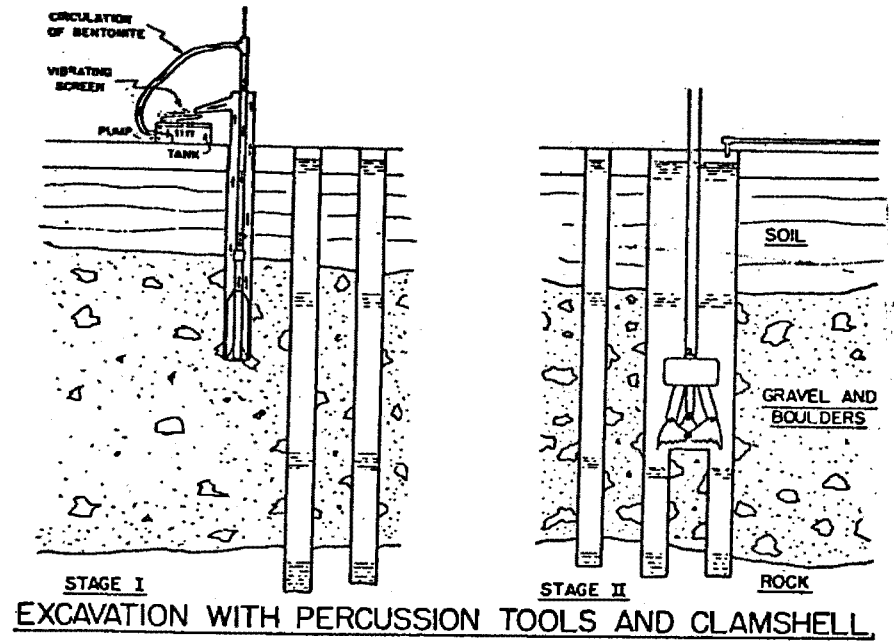


FIGURE 8

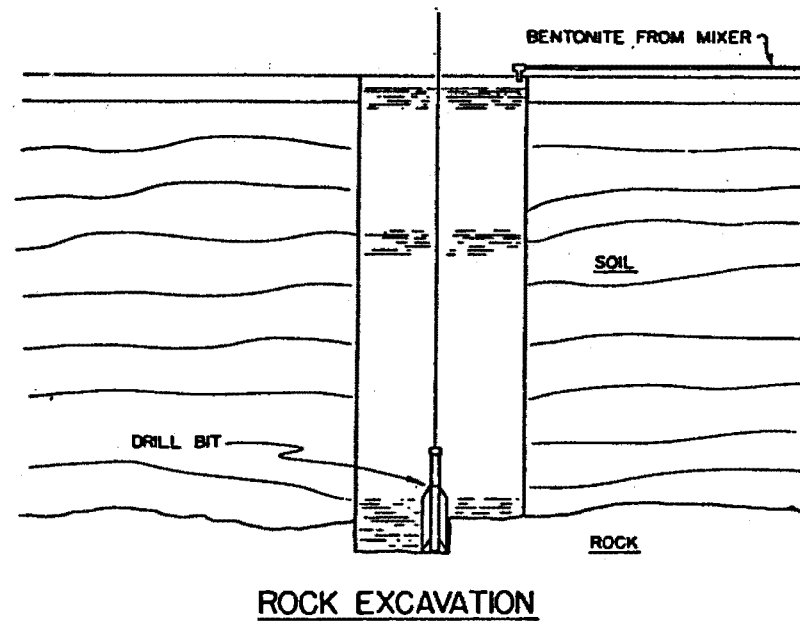


FIGURE 9

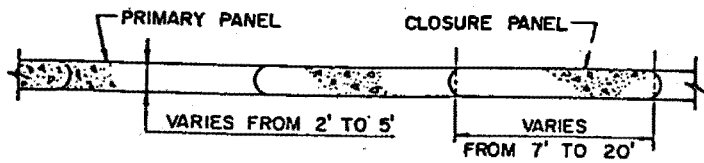


a

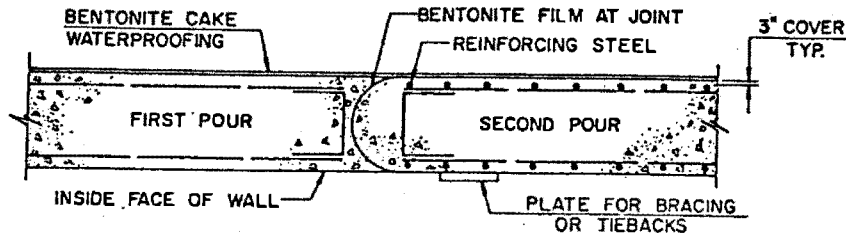


b

FIGURE 10 REINFORCING CAGES SHOULD BE SIMPLE IN DETAIL

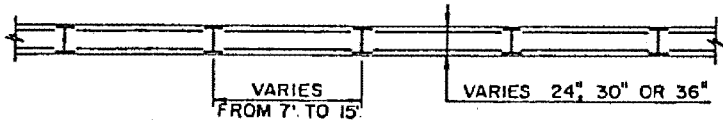


PLAN OF REINFORCED CONCRETE WALL

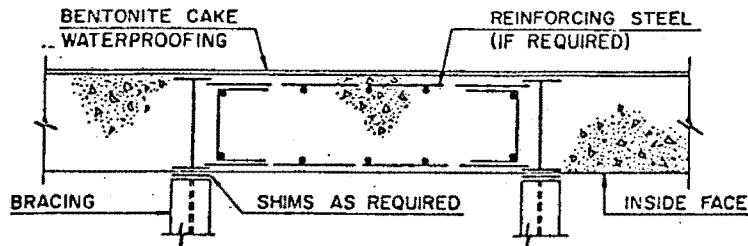


TYPICAL JOINT DETAIL

FIGURE 11



PLAN OF "SOLDIER BEAM & CONCRETE LAGGING" WALL



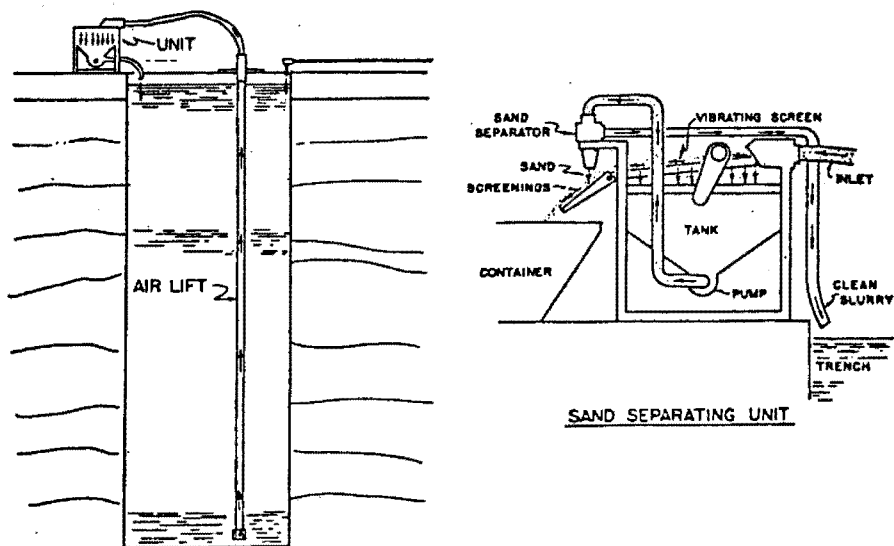
TYPICAL JOINT DETAIL

FIGURE 12



FIGURE 13 FIELD PHOTO OF A HALF-ROUND JOINT FORMED BY USING A STOP END PIPE



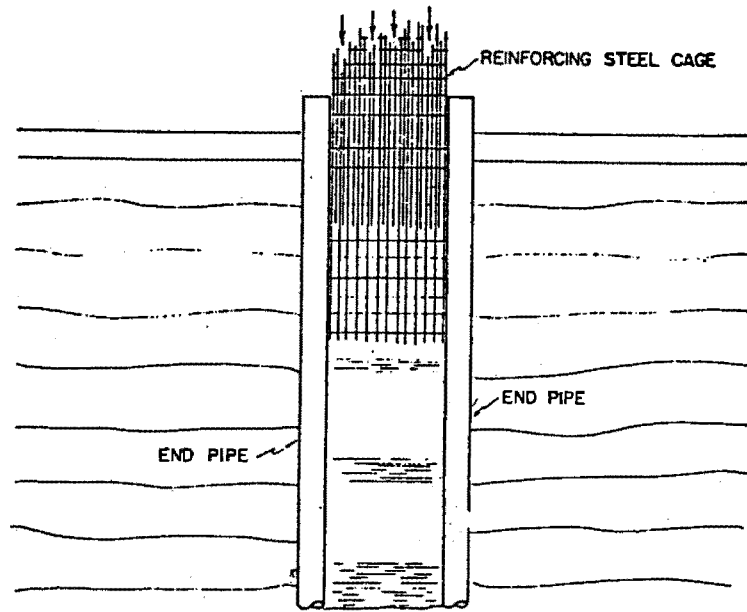


CLEAN-UP WITH SAND SEPARATOR UNIT

FIGURE 14

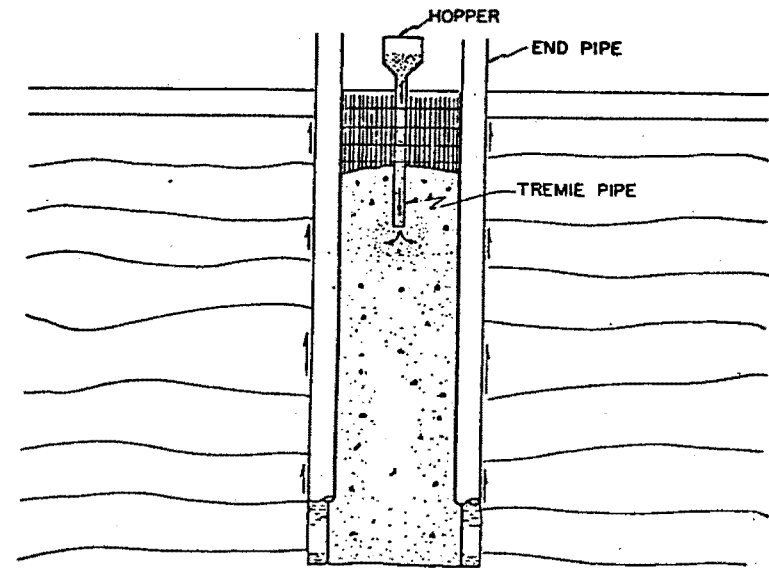


FIGURE 15 FIELD PHOTO OF RESIDUE FROM DESANDING UNIT



PREPARATIONS FOR CONCRETE PLACEMENT

FIGURE 16



PLACEMENT OF CONCRETE

FIGURE 17



NOTE: ON LEFT PORTION OF PHOTO THE END PIPE IS SHOWN. MOISTURE ON THIS PIPE SHOWS THAT IT HAS ALREADY BEEN PULLED ABOUT 10 FEET OUT OF THE PANEL

FIGURE 18 FIELD PHOTO OF CONCRETE PLACEMENT



FIGURE 19



FIGURE 20

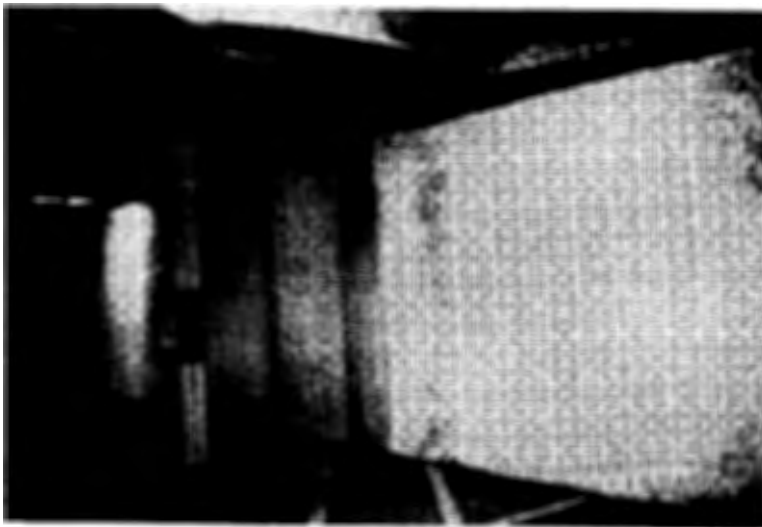


FIGURE 21



FIGURE 22

# GEOTECHNICAL ASPECTS OF SLURRY WALL DESIGN AND CONSTRUCTION

by

DONALD T. GOLDBERG  
GOLDBERG, ZOINO, DUNNICLIFF & ASSOCIATES, INC.  
NEWTON UPPER FALLS, MASSACHUSETTS

## ABSTRACT

This paper is addressed to those geotechnical issues germane to construction of slurry trenches and the subsequent stages of excavation and ultimate functioning of the slurry wall as part of the permanent structure. Principal issues addressed for the period of slurry wall construction are fluid loss potential, bentonite slurry stability, raveling of ground, excavation, and panel length criteria. Factors influencing vertical load capacity and lateral pressure both during construction and for the permanent wall are covered.

The role of conventional soil tests and subsurface investigations are discussed in connection with the above-described geotechnical issues. The broad categories of data acquisition are subsurface investigations, simple index property tests, engineering properties of cohesive soils, and groundwater chemistry.

Throughout, the objective has been to create a realistic framework wherein the field and laboratory data are applied in the most effective manner.

## GEOTECHNICAL ISSUES DURING EXCAVATION OF SLURRY TRENCH

### INTRODUCTION

For purposes of this discussion on the geotechnical aspects of slurry wall design and construction, it is convenient to examine three stages. The first is the excavation of the slurry trench but prior to filling with concrete. The second is during excavation on one side of the completed diaphragm wall such that the wall acts as an earth retaining structure. The third and last stage is after completion of the project when the diaphragm wall acts as part of the permanent structure.

The engineering issues for each of these successive stages differ measurably. During the period when trench excavation is filled with bentonite slurry, the contractor's concerns are such practical matters as stability of the open trench, nature of the soil being excavated, and the threat of fluid loss through highly pervious zones. See Figure 1 for schematic showing sloughing near top of slurry trench.

During the subsequent excavation period, the wall will be subjected to lateral earth, water, and surcharge forces. Superimposed loads from temporary structures and/or by the vertical component of anchorages will impart vertical forces. Thus, both vertical and lateral force considerations require geotechnical study and analyses.

If the diaphragm wall ultimately acts as the permanent wall of the structure, conditions of horizontal loading as well as vertical loading may differ considerably from that existing during the construction period. Additionally, the behavior of soil (i.e., "soil mechanics") for the so-called long-term drained case may differ from the relatively short-term construction period, particularly for cohesive soils. Finally, there must be consideration of groundwater chemistry for potential adverse effects on concrete and reinforcement.

## Chemistry of Groundwater and of Soil

An unstable bentonite slurry may lead to excessive viscosity, flocculation, attendant loss of fluid, and spalling of the excavated face. Some factors which affect the slurry are pH, contamination by salt iron, calcium, or organics. Calcium contamination may arise from cement or concrete rubble in the ground.

The geotechnical investigation should include routine chemical tests of groundwater. It is extremely simple and inexpensive to perform a great number of pH and conductivity tests on groundwater samples. Indeed, these can be performed in the field as a matter of routine. Anomalous variations in these simple index-type tests will be indicative of other ions. Using pH and conductivity as an index of ion concentrations, water quality analyses should then be performed on selected representative samples. Analyses should include soluble iron, soluble calcium, soluble magnesium, and chlorides. In addition, total coliform counts should be taken if any indications of raw sewage are observed during field investigations.

## Raveling of Ground and Obstructions to Excavation

This threat exists with the presence of rubble fill, nests of cobbles, building demolition debris, and other materials which may contain relatively large voids.

## Obstructions to Excavation

Buried foundations of structures or existing utilities will impact upon the facility of making the excavation. Accordingly, the geotechnical site investigation must include location of utilities and a routine research of the site history with the identification of former structure locations, walls, and pile foundations. Filled-in former depressions may all be relevant to site evaluation.

## Rock

Contractor must be provided with reasonable data so that he may judge equipment needs where requirement is to penetrate into rock. The rock hardness, degree of fracturing, and weathering are all important criteria.

## Groundwater Table

The stability of the excavated trench relies upon a positive head of bentonite slurry above the piezometric level in the adjacent ground. Ideally, this should be about five feet. The geotechnical investigation must therefore include appropriate information concerning loss of drilling water while making borings, the identification of highly pervious strata, and reliable information concerning piezometric levels. Of particular importance would be the identification of artesian conditions such as that which may exist under circumstances shown in the accompanying Figure 2.

Here the piezometric level in the underlying Stratum "C" is at a higher elevation than in the near surface Stratum "A". As a result, there will be a reduction of the slurry head in relation to the piezometric level in Stratum "C" with the possible consequences of ground loss and cave-in. This may or may not be detected during excavation of the slurry panel.

### Permissible Length of Panel

Factors that prevent the ground from caving into the excavated panel are the net positive outward force developed by maintaining the slurry level above groundwater level, the natural cohesion of the soil, and arching action in the ground as shown schematically in Figure 3. In this plan view, the tendency for the soil to creep inward near the centerline of the panel is relieved by transfer of load toward the ends of the panel—in simple terms, "arching".

Trench stability is affected by slurry density, length of panel, and height of slurry above water table. Trench stability is normally not of concern so long as the panel lengths are less than 20 feet and a slurry level is at least 5 feet above water table. There would, however, be special concerns if the soil were extraordinarily weak, as for example clays with undrained shear strength less than about 500 psf, loose silt, or loose uniform sands. Under such circumstances, slurry level should be raised and/or panel lengths shortened.

An unusual situation was encountered in connection with the proposed Alewife Station as part of the MBTA Red Line Northwest Extension Project here in Cambridge. Concern over a soft quick clay with sensitivity\* well over 20 centered upon several issues: (a) Stability of the excavated panel prior to concreting, (b) Inward wall creep prior to concreting, (c) Outward wall bulge after concreting, (d) Sloughing of the excavated face, and (e) Load bearing capacity of the completed wall. The extent of these concerns ultimately led to construction of two test panels with extensive *in situ* monitoring.

---

\*Sensitivity is the undisturbed strength *in situ* divided by remolded strength. Common clays have sensitivity of about 5. A clay with sensitivity of 20 becomes practically fluid upon remolding.

## GEOTECHNICAL ISSUES WHILE EXCAVATING BETWEEN DIAPHRAGM WALLS

Fundamentally, the wall must resist horizontal loads. Also, the wall may be required to support vertical loads or to minimize displacements outside the excavation.

### Vertical Loads

In addition to the weight of the wall itself, there may be vertical component of tieback force or superimposed loads from temporary or permanent structures.

Figure 4 illustrates the case of ground anchorages. It is self-evident that downward movement of the wall would lead to outward displacement and ground settlement behind the wall.

The component of force along the side of the diaphragm wall ("adhesion") would be analyzed in the manner commonly used in soil mechanics practice. In the case of clays, one would examine two conditions—the first based on undrained shear strength and the second based on an effective stress analysis for the so-called drained condition at the concrete-clay interface. These concepts are expressed as follows:

Undrained (Clay):

$$S_a = \alpha S_u$$

where:

$$S_a = \text{Adhesion, tsf}$$

$$S_u = \text{Undisturbed strength, tsf}$$

$$\alpha = \text{Reduction factor (less than 1)}$$

Effective Stress (Clay):

$$S_a = K (\tan \delta) \bar{\sigma}_v$$

where:

$$S_a = \text{Adhesion, tsf}$$

$$K = \text{Lateral earth pressure coefficient}$$

$$\tan \delta = \text{Clay to concrete friction angle}$$

$$\bar{\sigma}_v = \text{Effective stress, tsf}$$



The excavation process, and associated disturbance, will of course cause some strength loss in the clay. Figure 5 presents a plot of empirical reduction factor ( $\alpha$ ). Note, where the undrained strength of the soil is high,  $\alpha$  is relatively low—perhaps in the order of .50 to .60. But in the case of softer clays, the effect of disturbance is less; thus  $\alpha$  and therefore adhesion is higher.

In the effective stress method, data regarding  $K \tan \delta$  again comes largely from instrumentation measurements on piles. Its value is typically about 0.20 to 0.25 for clay and about 0.30 to 0.35 for sand.

Side friction of diaphragm walls in sand is computed by the effective stress method, utilizing overburden stress and lateral earth pressure coefficient. Disturbance by excavation has little or no effect. Opinion varies, however, as to the so-called mud cake effect and to what degree this may adversely affect side friction. Some believe the bentonite has no effect; others believe side friction is reduced by 10 to 30 percent. (Reference 4) Since mud cake development is more pronounced with highly pervious soil, it would seem reasonable to expect a corresponding effect on side friction.

Thus, in summary, for sands, assuming zero reduction due to mud cake, the adhesion is computed as follows:

$$S_a = K \cdot \tan \delta \cdot \bar{\sigma}_v$$

where:

$$S_a = \text{Adhesion}$$

$$K = \text{Lateral earth pressure coefficient. Use } K = K_o = 0.5$$

$$\bar{\sigma}_v = \text{Effective stress}$$

$$\delta = \text{Friction angle between concrete and soil}$$

The equation for solving end bearing of a deep foundation, in terms of effective stress, is as follows:

$$q_u = N_q \bar{\sigma}_v$$

where:

$$q_u = \text{Ultimate bearing capacity, tsf}$$

$$\bar{\sigma}_v = \text{Effective stress, tsf}$$

$$N_q = \text{Bearing capacity factor}$$

The above formula is for cohesionless soils or for the so-called drained case in clays wherein the cohesion component of strength is neglected.

Bearing capacity factors ( $N_q$ ) for deep circular foundations are given in Figure 6. For continuous foundations,  $N_q$  is about two-thirds of that for circular foundations.

As a practical matter, it would be an extraordinary case indeed where bearing capacity governs sizing of a deep foundation on cohesionless soil, because bearing pressure is usually limited by allowable settlement. This is best approached by direct experience or by *in situ* testing. The equation for solving for the ultimate bearing capacity of deep foundations on cohesive soils is given below:

$$q_u = N_c S_u$$

Where:

$q_u$  = Ultimate bearing capacity

$S_u$  = Undrained strength

$N_c$  = Bearing capacity factor —  $N_c = 9$  for circle;  $N_c = 7.5$  for continuous foundations

A safety factor of at least 2 should be applied to the computed vertical load-bearing capacity of a slurry wall utilizing the above-described procedures. Based upon one experience of the writer with soft highly sensitive clay, there is justification for neglecting the end bearing capacity entirely because side friction and base bearing apparently do not develop together in such soils. In this case, maximum shear strength developed along the side of the wall before end bearing was mobilized. When this adhesion was broken, it is speculated that there was a rapid decay in strength along the sides and simultaneous transmission of load to the bottom of the wall. This load could not be sustained by end bearing and failure occurred.

### Horizontal Loads

Conventional practice for cross-braced steel sheeting or soldier piles utilizes an empirical design earth pressure diagram for strut load computations. These empirical rules, developed originally by Peck (Reference 4), produce an earth pressure diagram above the bottom of excavation, but provide no basis for determining earth pressure below bottom of excavation. They are applicable to relatively homogeneous profiles of either sand or clays.

The Peck diagrams are based upon an "envelope" of apparent pressure diagrams derived from strut load measurements at braced sheeted excavations. Since the envelope encompassed significant variations between measurement stations, it tends to be conservative at any single location.

Differences exist between the conditions upon which the Peck empirical diagrams are based and diaphragm walls. First, diaphragm walls are much more rigid than sheeting and so there is less local variations of lateral pressure. Second, conventional practice is to prestress braces, again reducing variation. And third, where tiebacks are used they inherently lead to less load variation; they also eliminate temperature effects.

In consideration of the above, the applicability of the Peck diagrams to diaphragm walls is not universally agreed upon. Another complication is that the Peck diagrams apply only to the depth of cut and provide no basis for pressure estimates below. This has obvious implications if one is examining an intermediate excavation stage. The problem is particularly acute with a diaphragm wall extending below excavation because its rigidity attracts load, and thus induces bending moment.

The writer's own personal views are as follows for relatively homogeneous soil profiles in sand or in clay with ample safety with respect to base upheaval:

1. Check loads by Peck diagram at final depth of excavation. This is admittedly conservative.
2. Check intermediate stages of excavation by active earth pressure and by passive pressure on interior side of wall.

Figures 7 and 8 illustrate cases where it is believed that the Peck empirical rules could not be applied. In both, significant forces develop on the portion of wall below bottom of excavation.

Figure 7 illustrates excavation in soft clay with the wall terminating in an underlying, unyielding layer. The earth pressure diagram suggested on the figure is based upon the following rationale:

1. Earth pressure on each side of the walls increases linearly with depth.
2. Deflection of the wall within the soft clay is insufficient to mobilize either the active pressure condition on the earth side or the passive pressure condition in clay on the excavated side.
3. The lateral pressure is equal to the earth pressure at rest coefficient,  $K_0$ , times the effective overburden stress. To this, one must add the hydrostatic pressure.

An alternate way of computing pressure line "2" in the soft clay would be by means of lateral subgrade modulus wherein the soil reaction is proportional to computed wall deflection.

Figure 8 illustrates the case of a rigid diaphragm wall terminating in soft clay. The hypothesis there is that the depth of excavation produces a tenuous situation with respect to base stability and that the diaphragm wall is purposely extended below the bottom of the excavation to restrain movement and thus maintain base stability. The analysis of earth pressure in this case is based upon the following rationale:

1. Projection of the diaphragm wall below the base of excavation attracts load because of its rigidity.

2. One selects the desired factor of safety with respect to base stability. Then it follows that a force develops against the wall to achieve the safety factor as shown by curve "2".
3. Finally, one must assume a distribution of load on the diaphragm wall to maintain safety as shown by curve "3".

The above-described cases illustrate but two instances where one cannot go blindly ahead and apply either theoretical solutions or empirical design rules. In both cases it is believed that finite element analyses would provide a sound basis for engineering "judgment" and its use should certainly be encouraged in these and other cases.

### Displacements

Mitigation of ground displacements adjacent to the excavation is a criterion which frequently leads to selection of a diaphragm wall over other methods. Indeed, such usage eliminates underpinning.

With diaphragm walls, typical maximum horizontal and vertical displacements are less than 0.20 percent of excavation depth (*e.g.*, one inch for 40-foot cut). Moreover, displacements are relatively insensitive to soil type. (Reference 1)

With sheeting or soldier piles, displacements are very sensitive to soil type. In very stiff clays or sands, displacement is only slightly more than with diaphragm walls. With soft to medium clay, on the other hand, displacements in the order of 1 to 2 percent of the cut depth are common (*e.g.*, 5 inches to 10 inches for 40-foot cut).

## GEOTECHNICAL ISSUES FOR PERMANENT WALL

### Long-Term Vertical Load Capacity

Analytical tools are essentially the same as those used for analysis of the wall during the construction period. The principal difference is that it is absolutely essential that an effective strength analysis be carried out for cohesive soils.

### Distribution and Magnitude of Horizontal Pressure

Herein, a distinction must be made between the construction period and long-term conditions.

In the former, a slot is cut in the soil to relieve at rest pressure. Then sequential excavation occurs between support levels with accompanying lateral movement. During this stage, the soil is in the active state, thus active pressure or an empirical trapezoid would apply. (See previous discussion.)

Under long-term conditions of the permanent wall, earth pressure at rest, linearly increasing with depth, is appropriate.

Conventionally, horizontal pressure is the sum of hydrostatic pressure and horizontal earth pressure at rest. The latter is computed by the expression:

$$\bar{\sigma}_h = K_o \bar{\sigma}_v$$

Where:

$\bar{\sigma}_h$  and  $\bar{\sigma}_v$  are respectively horizontal and overburden stress

$K_o$  = At rest earth pressure coefficient

$K_o$  is in the order of 0.4 to 0.5 for cohesionless soils, and in the order of 0.6 to 0.7 for very soft and/or sensitive soils. In the case of overconsolidated clays,  $K_o$  may commonly be about 1.0. Still, one would generally use a value in the order of 0.5 in most cases.

Reason is that the excavation of a slurry trench, the subsequent tremie concrete pour, and the excavation between two walls relieves the *in situ* horizontal stress. So long as lateral deformation is complete during the excavation, there should be no load buildup with time. The exception will be soils that have a tendency for continued horizontal expansion after excavation such as heavily overconsolidated expansive clay or soft shale. Lateral earth pressure will obviously be much greater than  $K_o = 0.5$ . The writer offers no simple recommendations for earth pressure coefficients in this case. Each situation must be evaluated independently utilizing laboratory tests to model the construction conditions.

As a practical matter, it is unlikely that clays with overconsolidation ratios below 4 and liquid limit below 60 would display significant lateral expansion. On the other hand, overconsolidated highly plastic clays (say liquid limit in excess of 100) should be investigated.

## SUMMARY OF GEOTECHNICAL INVESTIGATION

### Research Site History

This effort will disclose incidence of old foundations (such as piles, foundation walls, etc.), areas of fill, location of utilities, and other information of similar nature which are fundamental to a thorough evaluation of the site.

### Exploration

Conventional borings should be supplemented by machine-excavated test pits to explore for underground obstructions, rubble fill, or other material which will impact upon the diaphragm wall or construction process. Simple laboratory tests should be performed as a matter of routine to assist in the proper identification of soil types. Such tests include Atterberg limits, natural water content, and grain size analyses.

### Grain Size Analyses

Grain size analyses on granular soils provide an indication of soil permeability. In addition, the grain size tests provide data on the amount of fines that may become suspended in the bentonite slurry.

### Atterberg Limits

To the experienced geotechnical engineer, Atterberg limits represent important indices for preliminary assessment of engineering properties of cohesive soil. Limits are indicators of sensitivity (strength lost upon remolding), of over-consolidation ratio, and of expansion potential. The tests are inexpensive and quick.

### Rock Data

Three major issues are excavation of panel, bearing value of rock, and water inflow when excavating to subgrade. A fundamental geologic assessment is vital—first to provide a general framework, second to disclose anomolous characteristics.

If diaphragm wall panels are to bear upon rock, such data are particularly acute. For example, in Boston the argillite has been locally altered to a clay-like material which is subject to softening upon exposure. Some schists, as in New York, may also be subject to softening upon removal of overburden.

Site investigation should include rock coring, with records of drilling rate and water loss. Packer tests, for rock permeability, or perhaps pumping tests, are an appropriate index of rock fracturing. Rock hardness, RQD, and slaking are all additional relevant information.

## Permeability

The colloidal action of bentonite will develop an effective mud cake and prevent loss of slurry where the soil permeability is less than about  $10^{-2}$  centimeters per second. Higher values of soil permeability may require the addition of fine sand or other materials to plug voids in the pervious ground.

The first assessment of soil permeability is made during site investigation. Occasions of fluid loss during drilling are indicative of potentially pervious conditions, and therefore the information should be recorded in detail. Instances of fluid loss are indicative of pervious strata, thus *in situ* permeability tests would be appropriate. The most simple technique is a constant head or falling head test out of the casing. This test, though crude, nevertheless has value. A more accurate technique is by water inflow tests—either by bailing the casing or by applying a vacuum pump to a short section of wall screen.

Whether or not laboratory and *in situ* permeability tests are warranted depends upon the suspected permeability (visual, drilling fluid loss, grain size, etc.). A few tests are useful for correlation with other indicators. More are required with increasing permeability and stratigraphic complexity.

## Monitoring of Groundwater Table

Observation wells should be monitored regularly to provide seasonal fluctuation data. Moreover, where perched or artesian conditions exist, observation wells should be installed in the particular stratum of interest and isolated from the rest of the geologic profile.

## Undrained Strength

Ordinary unconfined compression or vane tests provide a basis for estimating the undrained shear strength of cohesive soil. Where soils are soft or highly sensitive to disturbance, the data should be obtained by *in situ* vane shear tests.

The data so ascertained are applied to analytical studies made in connection with trench stability, side adhesion along the diaphragm wall, and bearing capacity at the bottom of the wall.

## Consolidation Tests

These would be utilized in estimating the magnitude and rate of rebound-recompression process resulting from stress release by excavation and reapplication of permanent structure load. In addition, the consolidation tests will identify swell characteristics of highly overconsolidated soils and thus form a basis for assessing whether or not the soil has potential for excessive lateral expansion or heave.

## Triaxial Compression Tests

Unconfined compression or triaxial undrained "quick" tests at natural water content are usually all that are required unless major questions concerning base stability arise. Another possible justification for triaxial tests is to determine soil

modulus data for a finite element analysis. It has been found empirically that the soil modulus from laboratory tests is somewhat less than the actual soil modulus *in situ*. Thus, a laboratory program to establish modulus should have intermediate rebound-reload cycles and measurement of secant and tangent modulus. Comparison of lab data with field measurements on similar soils is highly desirable.

### Chemical Tests

These should be performed routinely on groundwater and should always encompass conductivity and pH tests, both of which are simple and inexpensive. Anomalous values would be indicators of potential contamination. Other tests should include iron, calcium, magnesium, chlorides, and coliform.



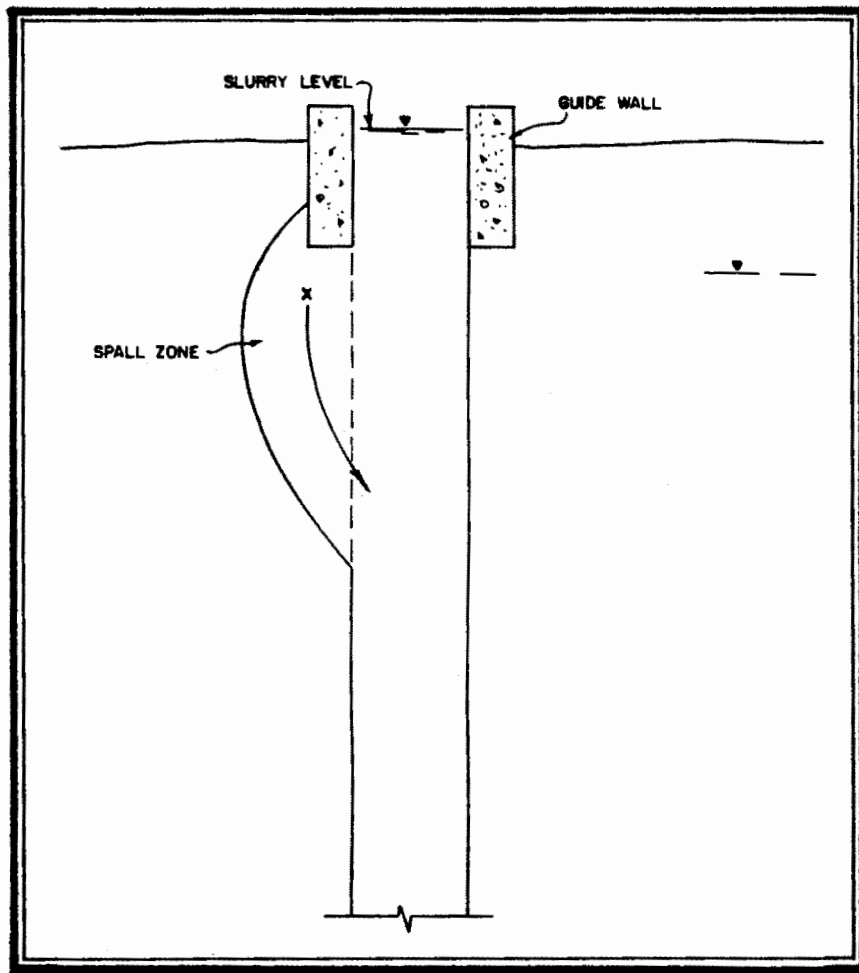


FIGURE 1 - TRENCH SLOUGHING

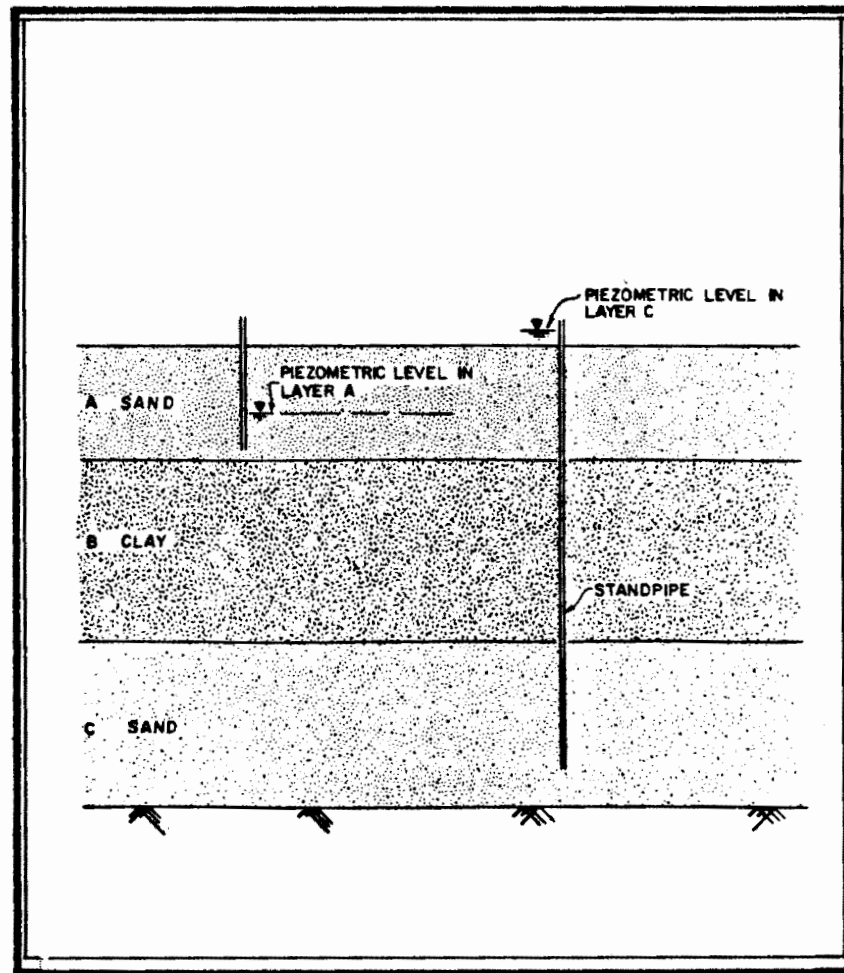


FIGURE 2 - ARTESIAN CASE

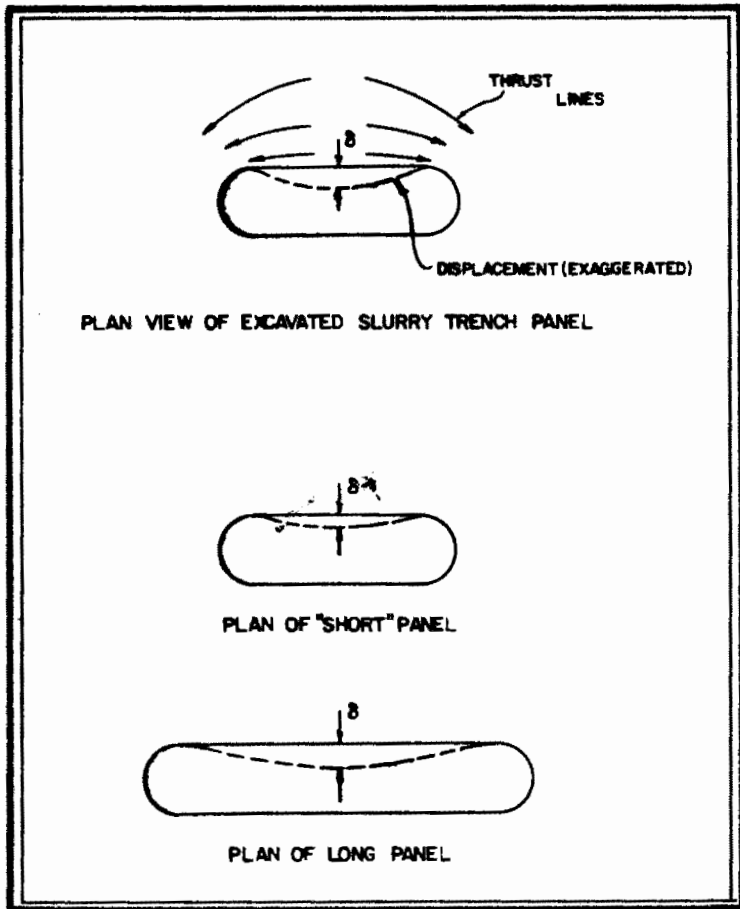


FIGURE 3 - ARCHING

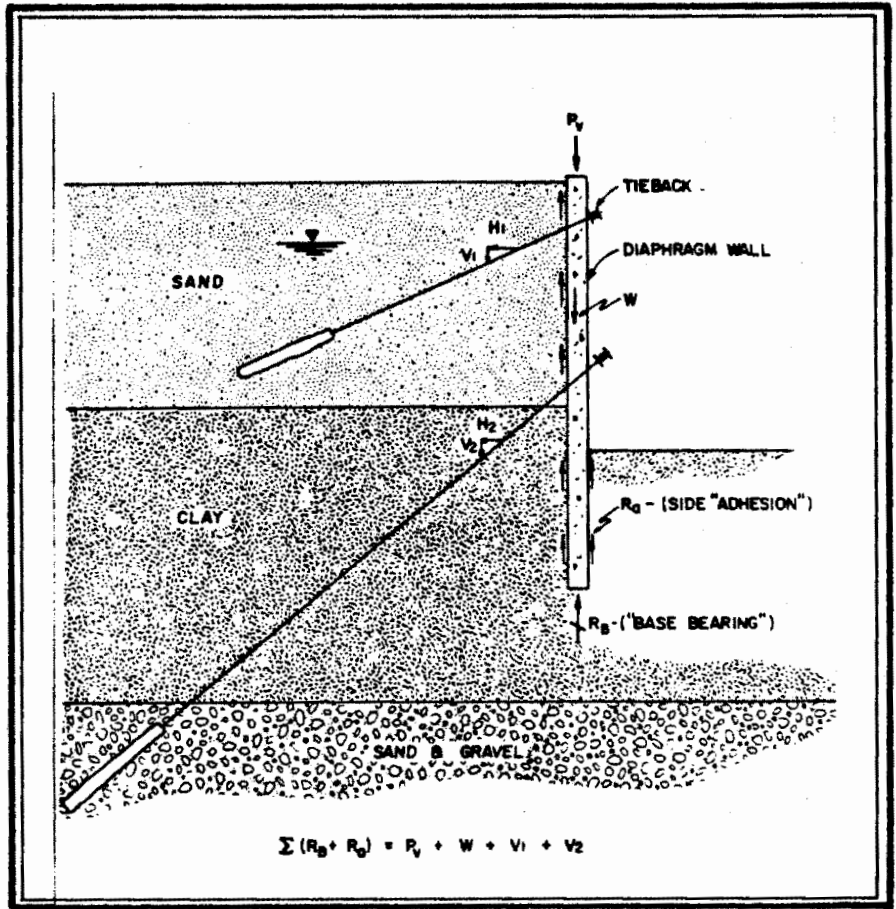


FIGURE 4 - VERTICAL LOAD CAPACITY

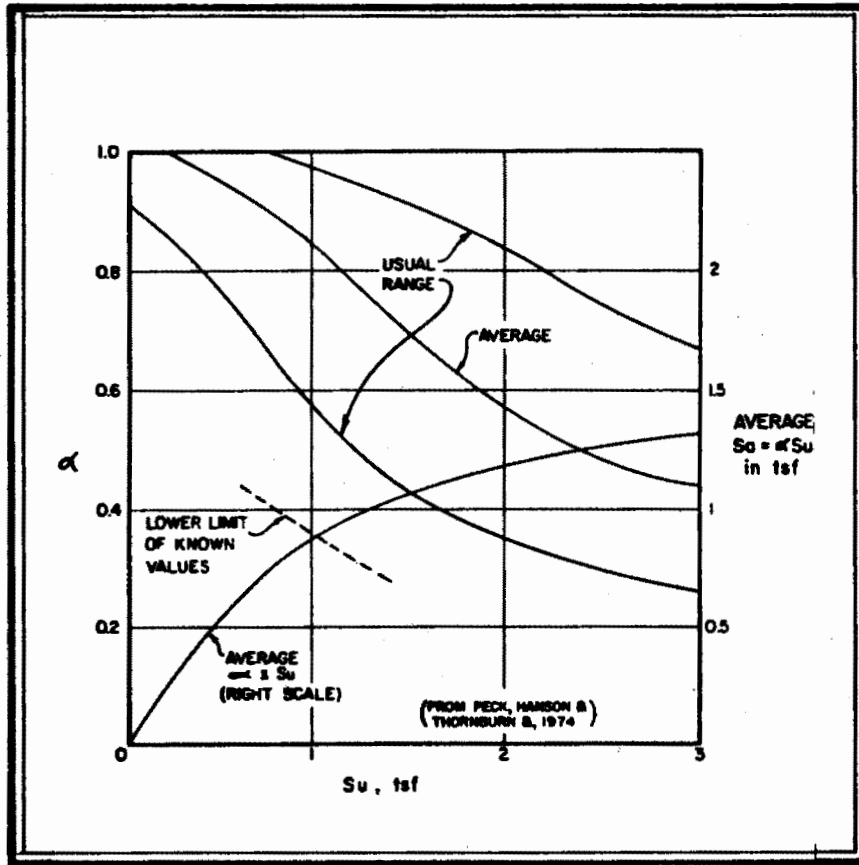


FIGURE 5 - REDUCTION FACTOR IN UNDRAINED STRENGTH,  $S_u$

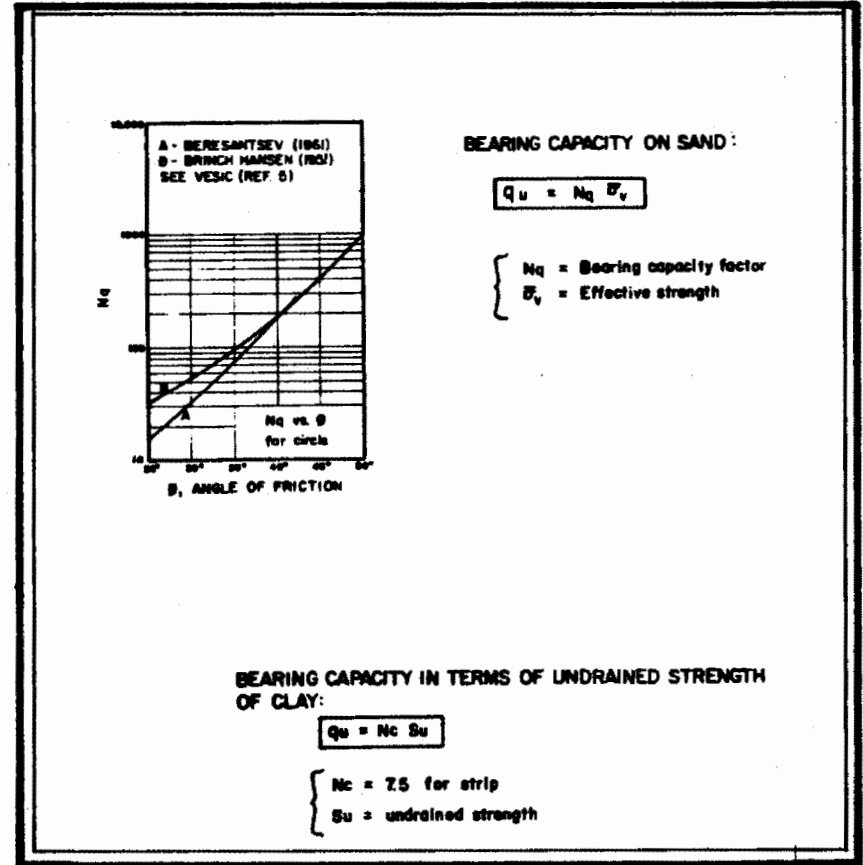
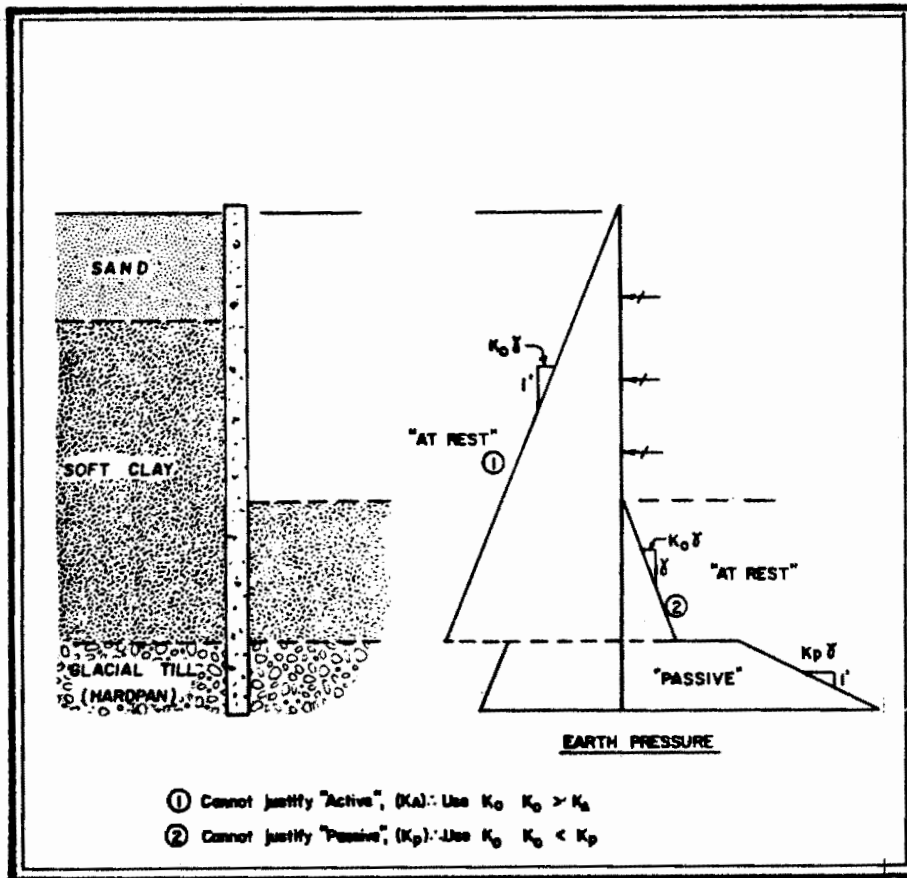
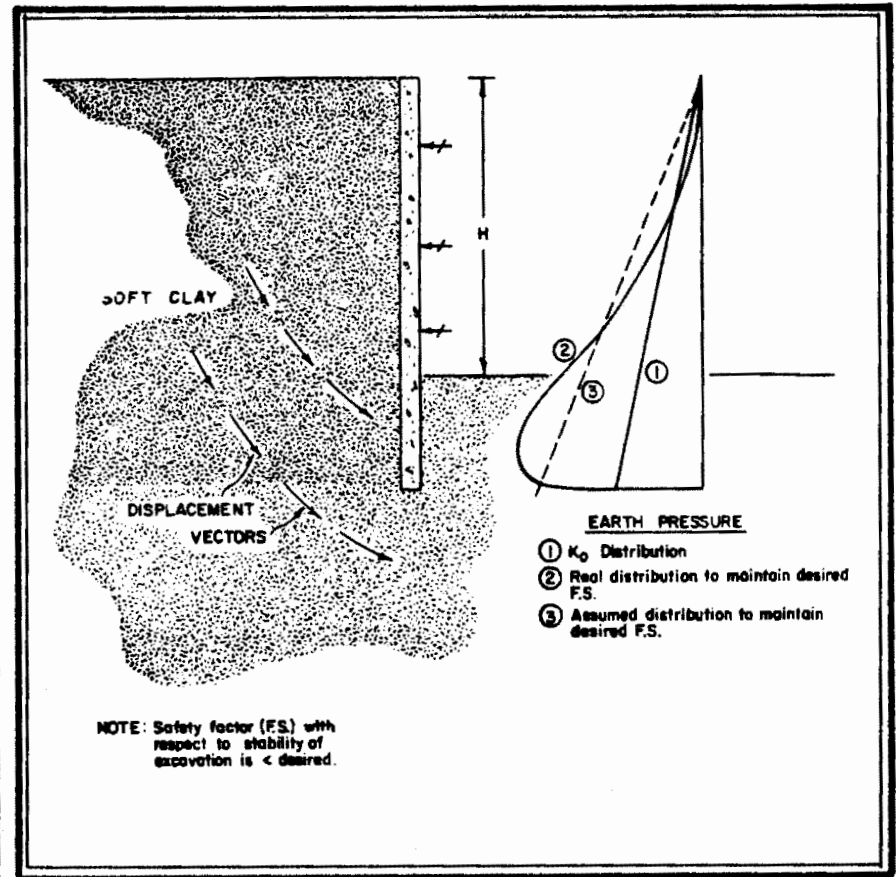


FIGURE 6 - BEARING CAPACITY



**FIGURE 7 - WALL INTO UNYIELDING STRATUM**



**FIGURE 8 - WALL TERMINATES IN SOFT CLAY**

## REFERENCES

1. Goldberg, D.T., Gordon, M.D., and Jaworski, W.E., "Lateral Support Systems and Underpinning", Report Nos. FHWA-RD-75-129 and 130, U.S. Department of Transportation, Federal Highway Administration, (1976).
2. Peck, R.B., Hanson, W.E., and Thornburn, T.H., "Foundation Engineering", Second Edition, Wiley (1974).
3. Sliwinski, Z. and Fleming, W.G.K., "Practical Considerations Affecting the Construction of Diaphragm Walls", Conference on Diaphragm Walls and Anchorages, Institution of Civil Engineers, London (1974).
4. Terzaghi, K., and Peck, R.B., "Soil Mechanics in Engineering Practice", Wiley (1968).
5. Vesic, A.S., "Ultimate Loads and Settlements of Deep Foundations in Sand, Bearing Capacity and Settlement of Foundations", Proc. of Symposium at Duke University, (1965).
6. Xanthakos, Peter, "Underground Construction in Fluid Trenches", University of Illinois at Chicago Circle (1974).

# DEFORMATIONS AND EARTH PRESSURES-EXCAVATION WALL SYSTEMS

by

G. WAYNE CLOUGH

PROFESSOR OF CIVIL ENGINEERING, STANFORD UNIVERSITY

STANFORD, CALIFORNIA

## ABSTRACT

The basic objective of this paper is to set into perspective the behavior of the slurry wall-ground system. Misconceptions about the effects of a slurry wall on excavation performance are common. It is important to know the reasons for slurry wall performance characteristics so that they can be used in the proper situations and to the best advantage. A slurry wall support system positively affects excavation performance by providing a relatively high degree of structural support, good contact between the wall and the soil, control over seepage and/or drainage of excess pore pressures and low levels of construction vibrations. These positive effects can be negated by poor construction techniques (especially if the basic factor of safety against basal heave is low), ill-considered ground water control measures, or poorly thought-out wall support systems.

In order to illustrate slurry wall performance characteristics, a review is provided of some important case histories and of results of finite element studies. The case history data is drawn primarily from the San Francisco and Oslo, Norway areas, for both soft clay and sandy soil conditions. Relationships between soil movements, soil conditions and system stiffness are established. Side effects are shown to be significant in loose sandy soils with a high ground water table.

The results from the finite element studies are used to reinforce and refine some of the behavior trends observed in the field data. Optimum conditions for the positive effects of the slurry wall are defined for soft clays. Earth pressure, wall movement and excess pore pressure distributions are reviewed.

Finally, the role of the finite element technique for analysis of slurry wall systems is discussed. A case history is used to illustrate how and where the procedure can provide useful design information.

DEFORMATIONS AND EARTH PRESSURES - EXCAVATION  
WALL SYSTEMS

INTRODUCTION

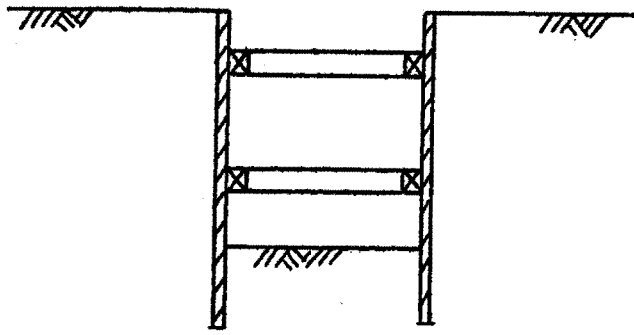
The behavior of support systems for excavations is an especially interesting category of soil-structure interaction. They may consist of braced, tied-back, or bermed walls, and the stiffness of the walls and supports can vary widely (see Figure 1). In contrast to conventional retaining walls, which usually are backfilled with ideal free-draining sand, excavation support walls are often built in poor soil conditions with a high ground water table. Furthermore, because they are often built to be serviceable only for a limited period of time, the factors of safety used in their design in many cases are lower than those for other problems. In addition, movements of excavations are often critical since they may affect major urban structures.

Interestingly, the design methodology for excavation wall systems is often written about as if it is set into stone. Many engineers nod condescendingly when new concepts are discussed as if to say, "Well, we've used the available technology for a long time and it has worked just fine." This attitude flies in the face of the real fact that a comprehensive technique for design does not exist. There appears to be a complacency which has set in with procedures largely developed in the 1940-1950 period, which, although they represented significant steps forward, do not necessarily produce the best, or most economical solutions. This is generally readily acknowledged by those individuals who generated the forward movement of the 1940's and 1950's, but not by those who are content to see an unchanging horizon. I say, if the technology is really so well defined, why do we continue to have such a high rate of dismally poor behavior for supported excavations? Recent papers have documented a long list of failures and litigation-ridden projects (3,7,21).\*

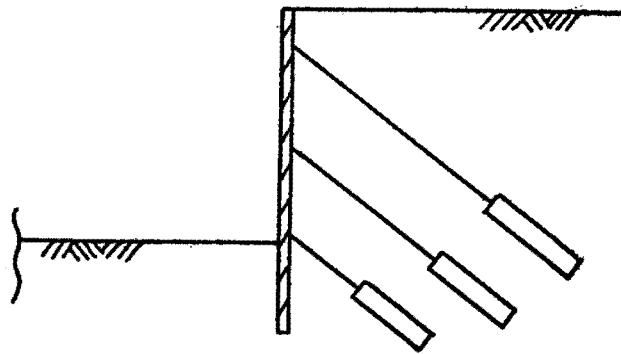
It is the opinion of this writer that significant improvements remain to be made in the design technology for excavation wall systems. Research and development in this area is slowly producing results, although the progress is being challenged by the rapid breakthroughs in construction

---

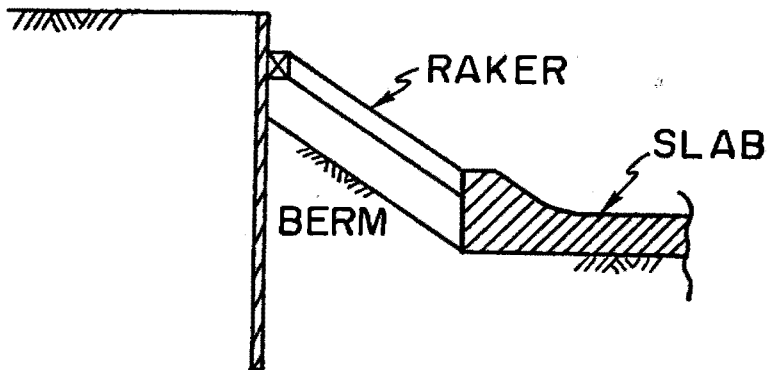
\*Numbers in parentheses refer to corresponding numbers in References Cited at end of paper.



CROSSLLOT BRACE SYSTEM



TIED-BACK SYSTEM



RAKER AND EARTH BERM SYSTEM

FIGURE 1. EXAMPLES OF EXCAVATION SUPPORT SYSTEMS.



techniques, as typified by the slurry wall. At this time, it is fair to say that useful conceptual advances have been recently made concerning the behavior of excavation support systems. This has been accomplished through advances in our analytical techniques, as typified by the finite element method and the gradual accumulation of a number of well-documented case histories. In this paper, I will provide a brief review of some of the information which is contributing to advancing the state-of-the-art, especially as this applies to the slurry wall.

#### EFFECTS OF WALL INSTALLATION ON INITIAL STRESS STATE AND SOIL MOVEMENTS

The installation of a wall for an excavation support system induces movements and involves changes in the stress state in the ground. In soil types such as loose sands, potentially running silts or weakly cemented sands below the water table, the type of wall construction technique exerts a significant influence on the final ground movements and stresses.

Because of the nature of the slurry wall construction process, it generally subjects the soil to a minimum of disruptive influences. There are no heavy vibrations induced by the trenching operation, and only small volumes of soil are removed. During trenching, the soil is continuously supported by the slurry which exerts a lateral pressure on the trench walls roughly equal to that which exists in the ground prior to trenching. Measurements of lateral and vertical ground movements during the trenching operation have shown them to be small, typically less than one centimeter (10,16). DiBiagio and Myrvoll (10) reported a case where a trench was held open in a soft clay for 24 days and the maximum inward trench movement reached only 1.6 cm using a bentonite slurry with a density of  $10 \text{ kN/m}^3$  (65 pcf). The small level of movements associated with slurry wall trenching makes it possible to construct very close to adjacent foundation walls.

During the process of concreting the trench, the lateral pressures exerted by the concrete are considerably above those of the slurry or those initially in the ground. Assuming an entirely fluid condition, concrete pressures are approximately three times those initially in the ground.

Measurements of the pressures exerted by the tremiè concrete in the field suggest that the full effect of the fluid concrete is not felt because of (1) a partial set-up during the pour, and (2) vertical shear stresses between the soil and the concrete. However, measured lateral pressures are reported to be between 1.5 to 2 times those initially in the ground (10,17). The effects of the introduction of the concrete pressures into the trench are twofold:

- 1.) The trench walls move outward from each other to positions about equal to or slightly beyond their initial positions.
- 2.) A firm and positive contact is established between the soil and the wall.

Thus, the result of the slurry wall construction has a generally favorable influence on the ground conditions.

With time and further hardening of the concrete, measured pressures between the concrete and the soil have been shown to decrease (10). During excavation, the earth pressures acting on the slurry wall appear to be consistent with those expected for normal excavation retaining structures.

Recent experiences with wall construction in San Francisco have provided some interesting object lessons in effects of wall installation. A series of excavations have been made for a large storm sewer system along the periphery of San Francisco Bay. The upper 30 to 40 feet of the soil in this area consists of a sand-rubble fill placed by random dumping during the expansion of the shoreline into the Bay. Most of the excavation support walls have been of the sheetpile type, and they have been driven into place by a vibratory hammer operating at a frequency of 1100 rpm. One small section was built using a slurry wall. Where the sheetpiles have been used, noise levels during driving elicited numerous complaints, street settlements reached one foot, and the pavements were badly cracked (9). Of course, the cause for this was the densification of the sand pockets in the fill during driving, which was accentuated by the "rattling" of the sheets where they encountered obstructions. Measurements have shown ground accelerations reached 0.4 g near the sheetpiles during hard driving (9). The slurry wall section was a distinct contrast in that surface settlements during wall construction were not noticeable and essentially no noise complaints were made.

This discussion points out that the effect of wall installation can be an important factor in engineering performance. Oftentimes, this aspect is overlooked in preliminary deliberations where attention is commonly focused on effects of wall stiffness on levels of preloading.

#### EFFECTS OF THE WALL SYSTEM ON GROUNDWATER FLOW

In soils where groundwater flow can be a problem, the wall is often relied upon to serve as a barrier to seepage. This is particularly important where the soils are silty enough that dewatering is difficult, yet at the same time water can pass through them, or in situations where dewatering is undesirable from the standpoint that consolidation settlements may be produced in intervening clay layers. Conventional sheetpile systems are often used in these circumstances, but all too often openings in the interlocks created by driving in sand or rubble layers lead to passage of substantial flows of water through the wall (19). These problems can be combatted by techniques such as chemical grouting of the pervious soil lenses or slightly open interlocks, sump pumping, recharge wells, and driving of secondary sheetpile sections. Alternatively, the slurry wall or secant pile wall can be used, both of which provide a more reliable seepage barrier. In the case of a slurry wall, seepage can still be a problem beneath the wall, through poorly formed wall joints, or through improperly designed tie-back holes. Each of these problems should be addressed to insure that the purpose of the slurry wall as a flow control device is fulfilled.

#### GENERAL CONSIDERATIONS - WALL MOVEMENTS, EARTH LOADS AND BASAL STABILITY - CLAY SOILS

Clayey soils generally pose the largest problems concerning movements which can occur during excavation. It is pertinent to the theme of this conference to consider the influences of the special characteristics of a slurry wall in improving this situation. However, before addressing this specific issue, it is useful to consider basic trends of behavior.

#### Relationship Between Excavation Induced Movement and Factor of Safety Against Basal Heave -

It is a documented fact that as a braced excavation in clay is deepened, the ground movements around the excavation increase. The primary

cause for this is the increased level of shear stresses being applied to the soil as the factor of safety against basal heave diminishes.

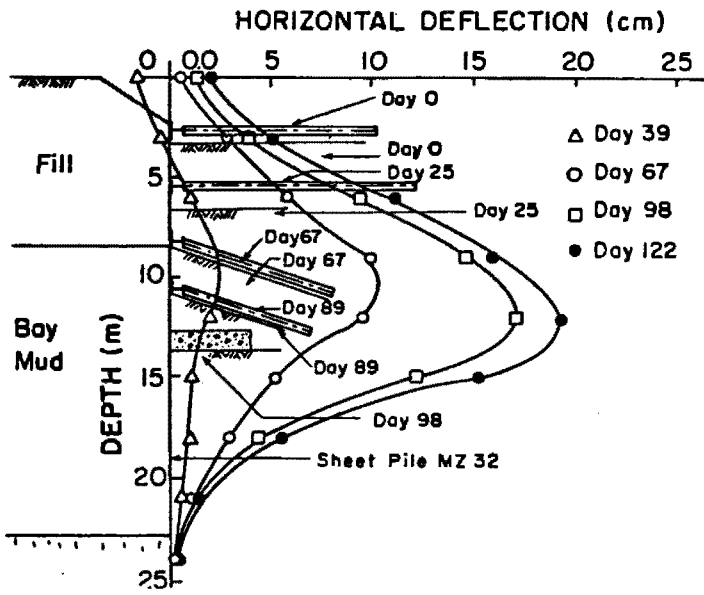
The relationship between ground movement and tendency for basal heave is nicely shown by the data in Figure 2 where the maximum lateral movement measured in the soil behind an excavation in San Francisco Bay Mud is plotted versus factor of safety against basal heave. Note that the lateral movement is nondimensionalized by dividing by the depth of the excavation. The data show that the nondimensionalized movements increase strongly as the factor of safety drops below 1.5. This is important since it demonstrates the nonlinear behavior of the soil. If the soil were a linear elastic medium, the nondimensional movement would remain a constant regardless of factor of safety.

The relationship observed in Figure 2 for a field case history can also be duplicated analytically through finite element analyses. Procedures for this type of analysis are described elsewhere and will not be discussed here (20,24). In Figure 3, the progressive movements and strut loads for a deepening excavation as predicted by a finite element analysis are shown.

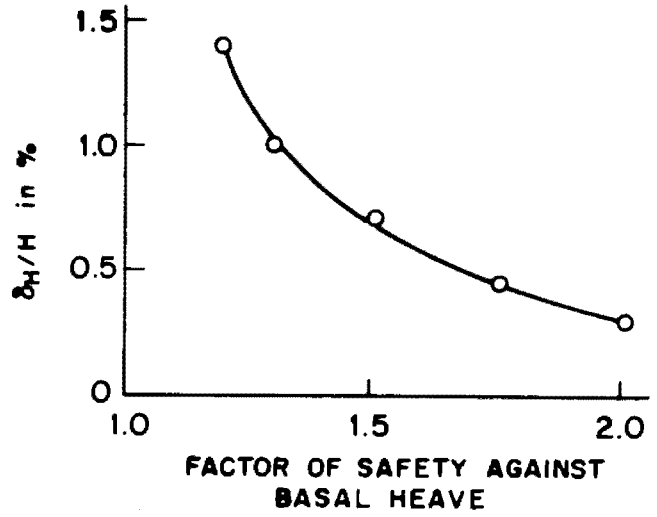
In this particular case, the wall penetrates through a homogeneous clay deposit to an underlying rigid base; its stiffness is that of a heavy sheetpile section ( $8088 \text{ t} \cdot \text{m}^2/\text{m}$ ). The clay is assumed to behave in an undrained fashion with an ideal elasto-plastic response; its shear strength increases linearly with depth. The excavation reaches a maximum depth of 15 m, and at that point, the factor of safety against basal heave is just above 1.0. At this level, large zones of yielding develop in the soil mass. The lateral movements of the wall, and soil settlements behind the wall can be seen in Figure 3 to begin to increase substantially as the deeper portions of the excavation are removed.

Also, as the depth of the cut increases the location of maximum lateral wall movement moves lower. The strut loads typically show a large increase as the soil immediately below the strut is removed, and thereafter either increases slightly, or in the case of the upper strut, decreases.

The analytically predicted maximum lateral wall movements from the example described in Figure 3 are plotted against the basal heave factor of safety in Figure 4 along with those from other analyses where the shear strength and the shear strength distributions of the clay soil were varied.



(a) Wall Movements



(b) Maximum Lateral Movements Vs. Factor of Safety

FIGURE 2. OBSERVED LATERAL MOVEMENT BEHAVIOR OF SHEETPILE WALL IN SAN FRANCISCO BAY MUD.

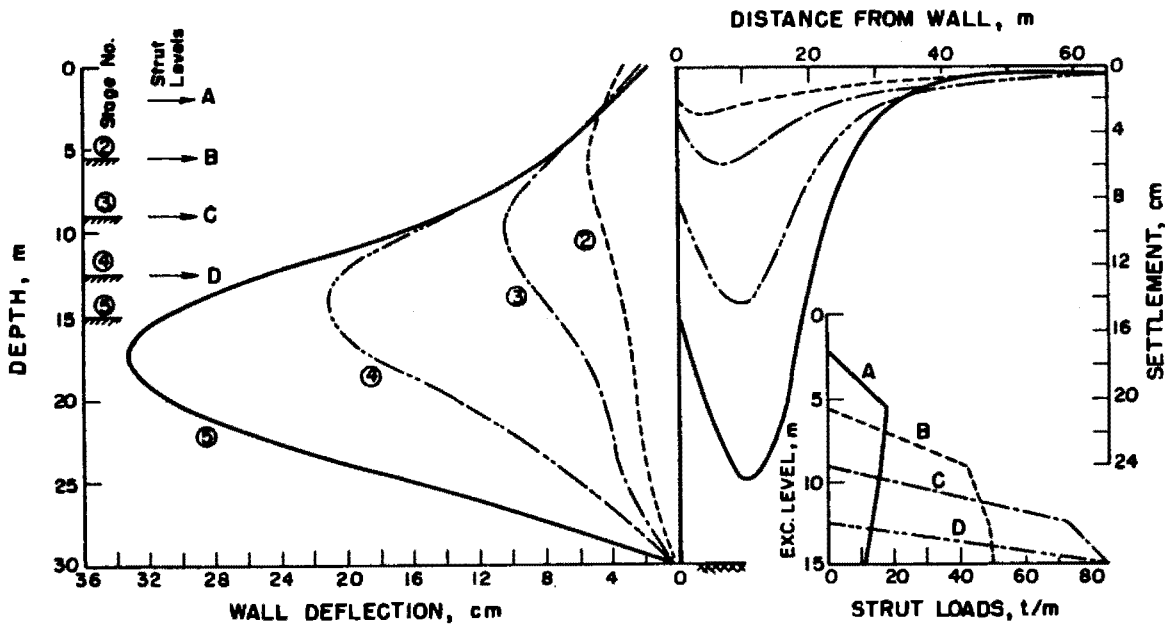


FIGURE 3. FINITE ELEMENT PREDICTED MOVEMENT AND STRUT LOADS FOR SHEETPILE WALL IN CLAY.

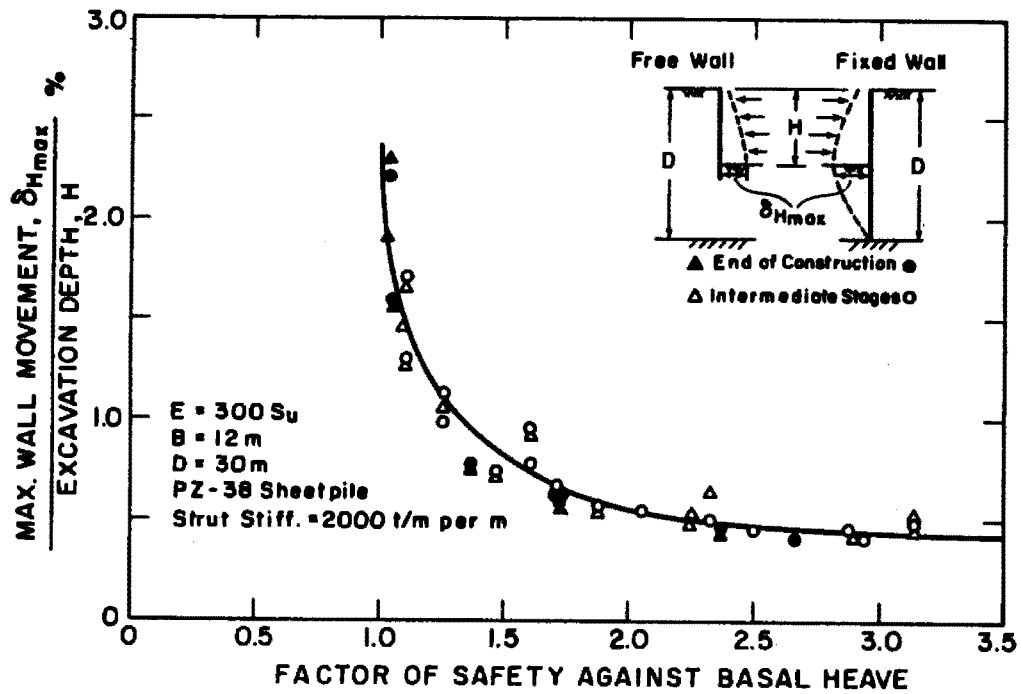


FIGURE 4. ANALYTICAL RELATIONSHIP BETWEEN MAXIMUM LATERAL MOVEMENTS OF SHEETPILE WALLS AND FACTOR OF SAFETY AGAINST BASAL HEAVE.

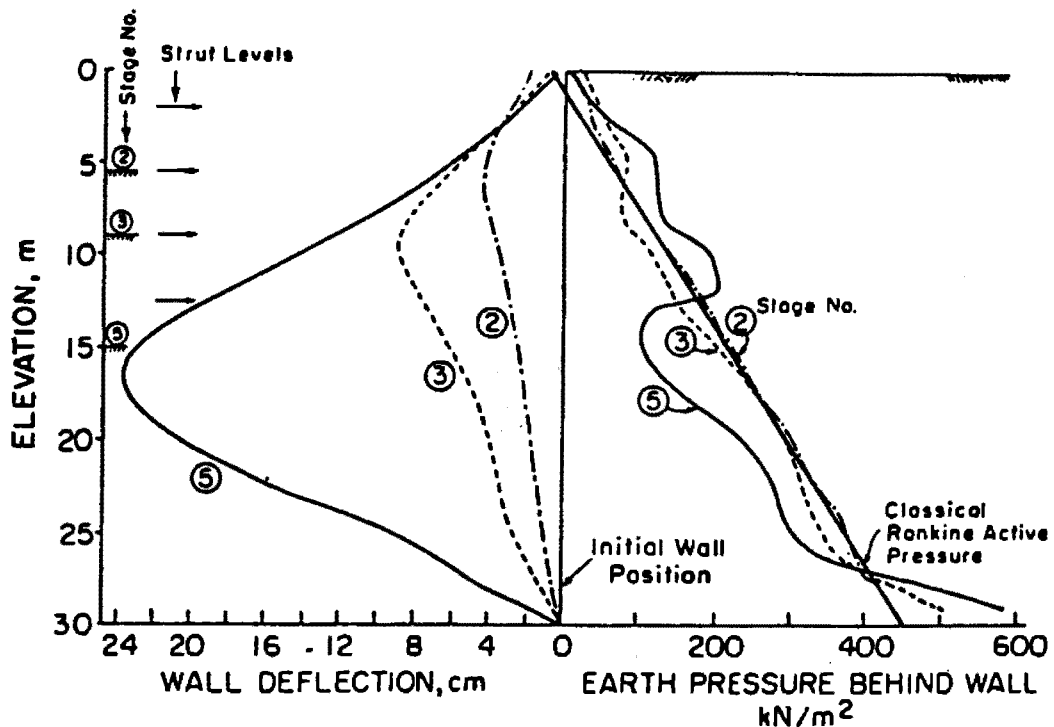


FIGURE 5. FINITE ELEMENT PREDICTED EARTH PRESSURE DISTRIBUTION ON SHEETPILE WALL IN CLAY.

In all cases, the results give essentially the same trend, one which is consistent with that shown for the field case history in Figure 2. As in the field case, the wall movements correlate strongly with factor of safety against basal heave, and they increase rapidly as the factor of safety falls below 1.5. Note also that the same response is obtained regardless of whether the wall is keyed into rock or remains well above the rock base and entirely within the moving clay soil. These data show clearly that the factor of safety against basal heave is a very important parameter in determining how much lateral movement occurs during excavation. The same concept also applies to vertical soil movements behind the excavation. In fact, in most cases, where no unusual construction activities or soil consolidation take place to distort the typical performance, the vertical soil movement behind the wall can be taken as equal to the expected lateral movement. Thus, Figure 4 applies as well for soil settlements during excavation as for lateral wall movement.

#### Total Earth Load and Earth Pressure Distribution During Excavation

In Figure 5, the predicted earth pressures acting on the active side of the excavation wall of the example described in Figure 3 are shown for several excavation stages. The initial earth pressures assumed to be acting on the wall prior to excavation were those of the at-rest condition.

The earth pressures for Stage 2, following excavation to a depth of 5.5 m (18 ft) below the first strut level, are essentially linear and about equal to the classical Rankine values. This is not surprising, since the wall deflection profile in Figure 3 shows lateral movements all the way to the bottom of the wall, movements which are on the order of those needed to produce Rankine conditions (0.5% H). At Stage 3, the earth pressures around the strut levels are higher than Rankine, but lower than Rankine below the struts to a depth of 26 m (85 ft) whereupon the pressures again exceed the Rankine values. At this stage, deflection of the sheeting below the last strut level produces an arching effect which was first fully explained by Bjerrum, Clausen and Duncan (2). Following final excavation to Stage 5, the trends at Stage 3 are even more prominent, showing increased pressures on the exposed wall portion and decreased pressures on the embedded wall portion. Interestingly, in spite of the differences in pressure profiles at Stages 2, 3 and 5, the total resultants of the pressure diagrams along the full length of the wall are about the same. This is

illustrated in Figure 6 where the resultant is plotted versus excavation stage; note that the resultants are all about equal to the classical Rankine resultant for the entire depth of the wall.

These results show that during excavation the system load is essentially a fixed quantity when the wall movements are large enough to induce the Rankine state over the entire wall length. The results also show that the distribution of the load is strongly influenced by the flexure of the wall below the last strut level and the degree of stability of the excavation. The larger the movements in the basement soils, the stronger is the arching effect whereby the lateral stresses below the excavation are reduced and the stresses on the strutted wall portion are increased.

Conventional simplified design load diagrams for support elements of walls in clays accommodate the arching effects illustrated in Figure 5 by providing an envelope approach. A load diagram is recommended which will generate a resultant large enough to account for the effects of arching of the earth pressures onto the strutted part of the wall. For the commonly used load diagram of Peck, Hanson and Thornburn (2), the resultant for clayey soils is 1.7 times that of the Rankine approach, a value which is conservative for most cases.

Perhaps one of the least understood aspects of support system loading is what to do for the portion of the wall embedded in the soil. Load diagrams do not explicitly address this problem since they only apply to the exposed wall section. However, in most cases, structural design of the wall based only on the loading of the exposed portion is also adequate for the embedded portion. The reason for this can be seen in the earth pressure loadings in Figure 5. As arching occurs, the soil pressure increases on the exposed wall section are compensated by decreases in pressures below Rankine active values on the embedded section. Basically, the system moves to come into an equilibrium position, and in doing so, the pressures on the active side of the embedded wall section decrease until they are balanced by the passive side wall pressures. This is possible so long as the factor of safety against basal heave is greater than one and the wall is capable of yielding plastically or moving relatively freely with the soil.

Many wall systems are overdesigned because of a lack of appreciation of the effects of arching and soil-structure interaction. Often designers arbitrarily assume full active or at-rest pressures to act on embedded wall



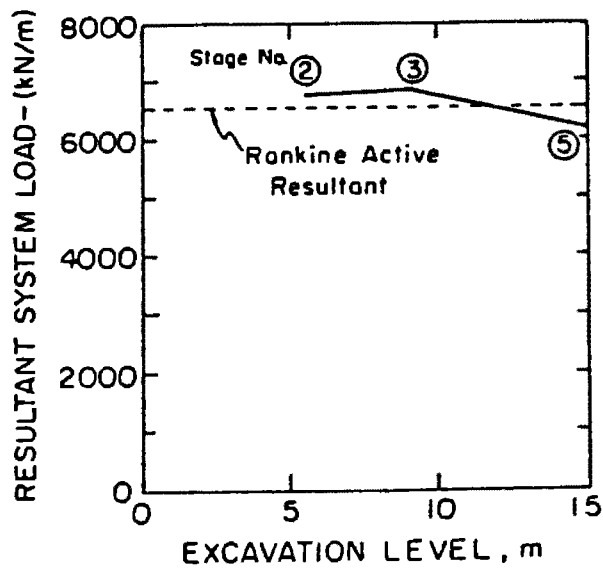


FIGURE 6. RESULTANT OF EARTH PRESSURE DIAGRAMS SHOWN IN FIGURE 5.

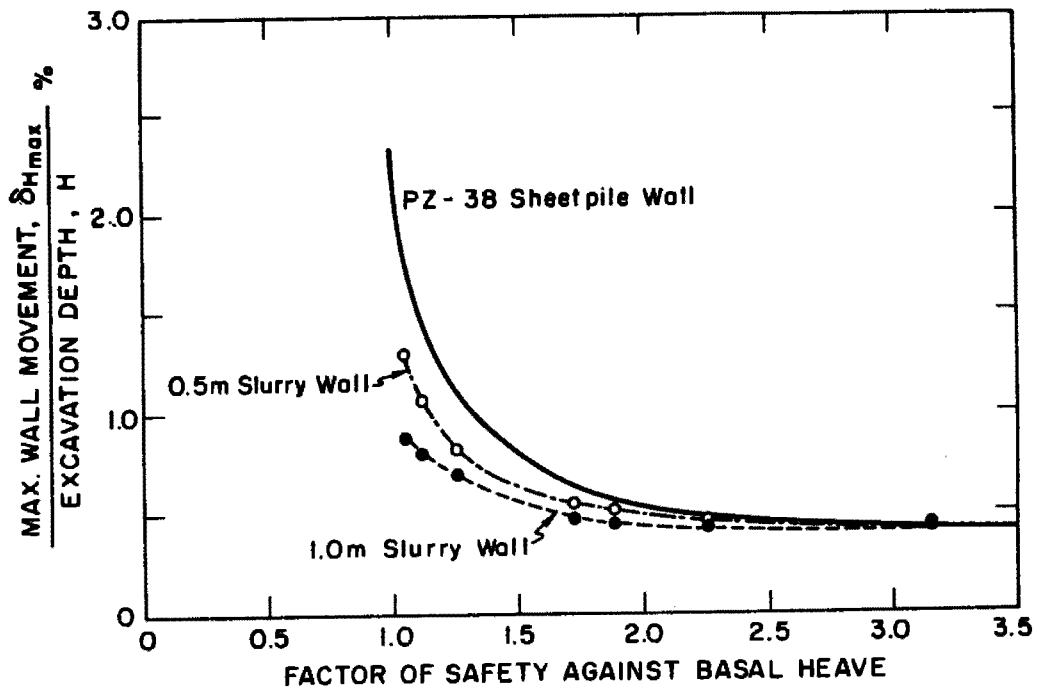


FIGURE 7. EFFECT OF WALL STIFFNESS ON RELATIONSHIP BETWEEN MAXIMUM LATERAL WALL MOVEMENTS AND FACTOR OF SAFETY AGAINST BASAL HEAVE.

sections. This can only be justified if it is desired specifically to have a wall with a high degree of stiffness which will have the capability to substantially restrain subgrade movements. In this case, the wall itself will end up receiving loads which could be carried by the soil if enough deformation were allowed (assuming the factor of safety against basal heave is greater than one).

#### EFFECT OF SYSTEM STIFFNESS ON MOVEMENTS IN CLAY

The preceding section of this paper has described the nature of the problem of movements of excavations in clays. Confronted with a situation where the anticipated movements which could occur are unacceptable, the designer has the option to change the system design; at this stage, it is likely that a slurry wall system will be considered over a sheetpile wall because of its greater stiffness. This approach is often taken based on the simple fact that a slurry wall has a section modulus which is often an order of magnitude larger than the heaviest sheetpile section. Such reasoning is, in fact, too simplistic, since the wall stiffness is only one variable in the braced wall-soil system, and it may or may not be significant, depending upon the circumstances.

The isolated effect of wall stiffness on movement trends over a range of stability conditions is illustrated in Figure 7, where nondimensionalized lateral wall movements predicted by finite element analysis are plotted versus factor of safety against basal heave for three wall stiffness values. The heaviest section represents a 1.0 m thick concrete wall (stiffness ~ 20 times that of the sheetpile section used in Figure 3), the intermediate case represents a 0.5 m thick concrete wall (stiffness ~ 10 times that of the sheetpile section used in Figure 3) and the third case is the standard sheetpile section. In all of the cases, the wall is braced by four levels of struts as shown in Figure 3.

The results in Figure 7 demonstrate an important finding; namely, increasing wall stiffness has the greatest effect in reducing wall or soil movements when the factor of safety against basal heave is approaching a value of one. It is in this region that the soil has used up its resistance to the developing shear in the soil, and the support system is required to play a larger role. At high factors of safety, the different wall stiffness cases show essentially the same movement levels, because in this instance

the soil mass has adequate capacity in and of itself to resist the shear stresses developed by the excavation.

In addition to the wall stiffness, the stiffness of the supports of the wall, i.e. the braces or tie-backs, also can play a significant role in the movement of the system. The effective stiffness of the supports is influenced by the horizontal and vertical spacing, the structural section properties, and the types and security of the connections. Goldberg, Jaworski and Gordon (13) have suggested that the support spacing and wall properties can be combined into a general stiffness parameter defined as  $EI/h^4$ , where  $EI$  is the flexural stiffness of the wall, and "h" is the vertical spacing of the supports. This is a useful concept which incorporates two of the more important factors affecting behavior.

Case history data on maximum lateral slurry wall movements in clays from eight projects are presented in Table 1 along with the respective values of  $EI/h^4$  and the factor of safety against basal heave. These results show several interesting trends:

- 1.) Even though the factor of safety against basal heave is low in a number of cases, the movements are only 0.2% or less of the wall height. This confirms the general trends indicated by the analytical results in Figure 7, i.e., a stiff wall system can serve to limit movements even though the basal heave factor of safety is low.
- 2.) However, in three of the cases, the movements are relatively large; one percent or greater of the wall height. For two of these, opening of holes for caissons inside the excavation led the large movements. In the other case, very wide spacings were used between the supports which reduced the system stiffness in spite of the use of a stiff wall. Several authors have shown that strut spacing should be lower than  $2 c/\gamma$  in soft clays in order to effectively control movements ( $c$  is the undrained cohesion of the soil and  $\gamma$  is the total unit weight (22)).

These data illustrate that use of a large wall stiffness can serve as an important factor in limiting movements, but that this factor alone does not guarantee that movements will be small. Comments as to other important parameters are given in the following section of the paper.

TABLE 1. MOVEMENTS OF SLURRY WALLS IN CLAY  
(Adapted from Clough and Schmidt, 1977)

| Reference                | Location      | $EI/h^{4*}$<br>kN/m <sup>2</sup> /m | Factor of<br>Safety<br>Basal Heave | <u>Max. Movement</u><br><u>Exc. Depth %</u> | Comment                                     |
|--------------------------|---------------|-------------------------------------|------------------------------------|---|---|
| Lambe (1970)             | Boston        | 1470                                | 2.0                                | 0.2   |   |
| DiBiagio and Roti (1972) | Oslo          | 4300                                | 1.3                                | 0.1   |   |
| Armento (1973)           | San Francisco | 26600                               | 1.4                                | 0.15  |   |
| O'Rourke et al (1976)    | Chicago       | 1420                                | 1.4                                | 0.5   |   |
| O'Rourke et al (1976)    | Chicago       | 3020                                | 1.3                                | 1.8   | Problems Caused by Nearby Fdn. Construction |
| O'Rourke et al (1976)    | Chicago       | 6490                                | 1.4                                | 2.0   | Problems Caused by Nearby Fdn. Construction |
| Clough and Denby (1977)  | San Francisco | 109                                 | 1.7                                | 1.0   | Vertical Strut Spacing = 9 m                |
| Johnson, et al (1977)    | Boston        | 2200                                | 4.0                                | 0.2   |   |

\*Based on moment of inertia of concrete section only

COMMENTS ON THE INFLUENCE  
OF OTHER PARAMETERS ON WALL MOVEMENTS

Many factors influence wall and soil movements in an excavation project. Aside from those already discussed, preloading, earth berms, below subgrade supports, and construction sequence are four with a significant effect on behavior.

Preloading

Preloading is essentially a universal practice for tie-backs and common for struts. As a designer the question about preloads is, "How much preload and what distribution of preload should be applied?" Widely varying philosophies are expressed in the literature on this subject. Some of these are as follows:

- 1) Use a preload distribution like the Rankine Active case (triangular).
- 2) Preload each support until one inch of onward movement is observed during preloading or a total load is applied which equals that calculated from the Peck (23) wall loadings for braced walls. (trapezoidal or rectangular).
- 3) Use a preload distribution like the At-Rest stress condition (triangular).

The "right" amount and distribution of preload depends upon the type of system and the desired purpose of the preloading. First, a tied-back wall is more adapted to application of and maintenance of a high preload than a braced wall. It is rare to hear of a braced wall loaded to values above Peck type magnitudes, but not so for tied-back walls. Second, if movements are important, then higher values might be used than if movements are not important.

Relationships between movements and magnitudes of preloads are given in Figures 8 and 9 for sands and stiff clays respectively; primarily results of field data and model tests are used to make up this plot. As the design preload diagram ordinate from which preloads are calculated gets larger, the movements get smaller. Thus, preload apparently has a strong effect in the amount of system movement that occurs and can be used to diminish system movements. Note, however, there is a diminishing returns effect in that increasing preload values up to or slightly beyond the values of the Peck loadings produces a sharp movement reduction, but further increases yield increasingly small reductions in movements. Thus, use of very large prestress loads is not desirable.

Optimal distributions of design preload diagrams appear to be trapezoidal or rectangular in shape rather than triangular (4,14). Triangular distributions lead to higher preload forces on the lowest supports where these forces are opposing the movement of a large mass of soil, a mass usually large enough to be unaffected by prestress loads. Trapezoidal or rectangular distributions lead to high preloads near the top and these loads can be effective in reducing early movements of the system.

It is important to note that applying preloads so as to recreate the at-rest pressures to the wall does not eliminate system movements. In applying at-rest type preloads, only the lateral component of stress relief

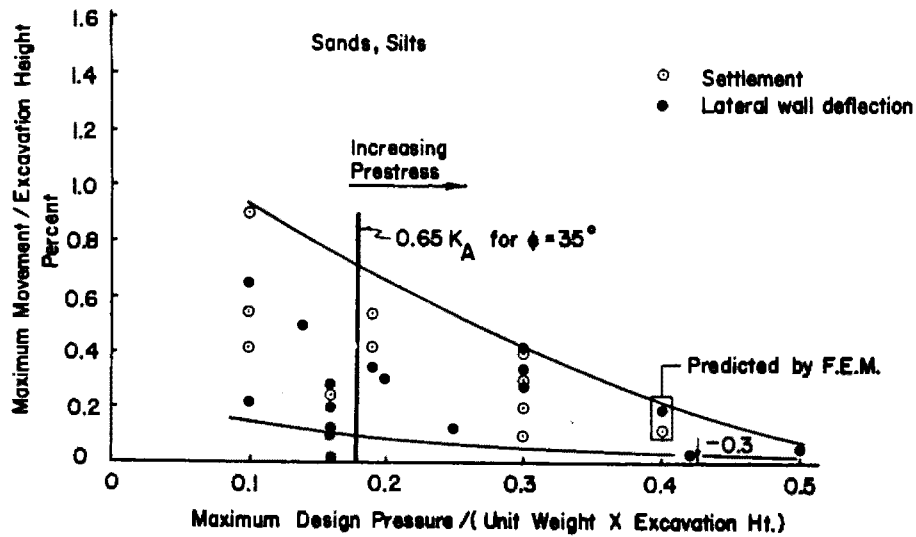


FIGURE 8. EFFECT OF PRESTRESS LOAD ON MOVEMENTS OF WALL SYSTEMS IN SANDS.

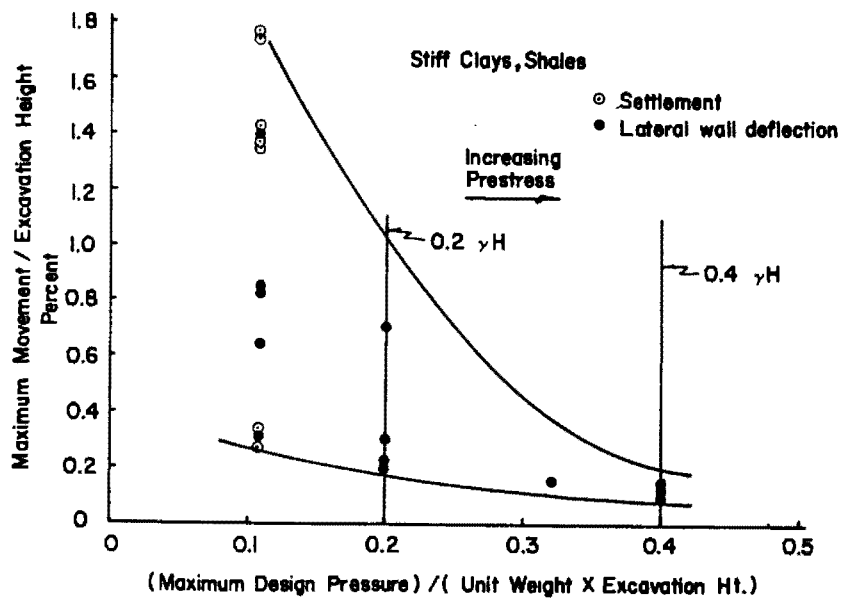


FIGURE 9. EFFECT OF PRESTRESS LOAD ON MOVEMENTS OF WALL SYSTEMS IN STIFF CLAYS.

is being re-applied, not the vertical stress relief across the excavation bottom. Also, system movements occur during each excavation step before preloading. These movements will not be fully regained during preloading.

#### Movements of Earth Berm Supported Walls

Most of the preceding discussion has concerned crosslot braced or tied-back walls. In wide excavations in deep clays where tie-back anchorage cannot be obtained, excavations are constructed using the conventional earth berm-raker support system. An example of the earth berm system was depicted earlier for the Levi Strauss Building in San Francisco (see Figure 2). The earth berm-raker system in soft clays may be expected to move more than the crosslot braced type wall in general, because a substantial amount of excavation is made before the structural supports (rakers) are supplied.

Based upon field data reviews and finite element studies (6,7,21,22) the following trends are observed:

- 1) Problems are often produced by premature removal of the berm by an overzealous subcontractor, and by local slope failures produced in berms due to seepage, softening of the soil during rainy weather, or softening under repeated movement of equipment.
- 2) The stabilizing effects of large or flat berm in the past have been overestimated when the stability against basal heave in clayey soils is low. In these cases the clayey soil simply moves beneath the subgrade and "carries" the berm with it.
- 3) There is a clear linkage between the effectiveness of a given berm size in controlling excavation movements and the basic stability of the excavation.
- 4) To enhance the successful use of an earth berm, the period during which it is relied upon to support the wall alone should be minimized.

#### Below Subgrade Supports

The data in Figure 3 show clearly that movements in clays develop primarily below the present subgrade level after the initial excavation stage. In order to minimize movements, it would therefore be desirable to have a support for the wall below subgrade. Under most circumstances this is difficult to achieve, since although a strut might be dropped into a pre-opened slot a connection with the wall cannot be effected. This problem has been resolved in several critical projects in Oslo, Norway where crosslot slurry trench walls have been opened to structurally tie the

longitudinal walls together (12,17). Concrete is tremied only into the portion of the crosslot slurry trench below subgrade, and the remainder is filled with gravel. A detailed case history report by Karlsrud (17) presents data showing this technique to be very effective. It is, of course, relatively expensive, and is difficult to construct for wide excavations.

#### Effects of Construction Sequence

In the previous discussion, references have been made concerning the influence of construction factors on excavation movements. The degree of this influence can be substantial both during and after the excavation is complete. It is beyond the scope of this paper to discuss all the possible influences of construction procedures. A recent review has been made by Clough and Davidson (7) and excellent specific case history accounts are provided by White (25), Broms and Stille (3), O'Rourke, Cording and Boscardin (21), Hansbo, Hofmann and Mosesson (15), and Lambe, Wolfskill and Wong (19).

Additional movements of excavations and even local failures have been produced by late installation of supports, pile driving, caisson construction, loss of water through tie-back holes and interlocks and joints of slurry and sheetpile walls, remolding and undercutting of clay berms, and surcharge loading by soil and equipment. Because these factors cannot always be anticipated, it is difficult to make accurate movement predictions for excavations in clay. However, many of the effects of construction have been defined and thus, they can be anticipated and controlled by good specifications and construction procedures. The designer should consider how the excavation and subsequent construction will be carried out, establish critical phases where construction effects can be magnified, and incorporate these aspects into his performance estimates and specifications.

#### FINAL COMMENTS

Much of the information reviewed in this paper has been generated within the last decade. As particularly concerns slurry walls, the following conclusions are appropriate:

- 1.) A properly designed and constructed slurry wall system can be effective in reducing levels of wall and soil movement in situations which otherwise could lead to problems.



- 2.) The installation procedures for a slurry wall have less undesirable side effects on sensitive soils (such as loose sands) than many conventional techniques.
- 3.) The effective stiffness of a slurry wall system is governed by the stiffness of the supports and their spacing as well as the stiffness of the wall, per se.
- 4.) Earth load distributions on the slurry wall as well as other types of walls in clays are strongly influenced by below subgrade movements. Because of arching effects, it is possible to generate earth pressures below Rankine active values on embedded wall sections.
- 5.) Secondary construction within an excavation can produce movements of a slurry wall which negate the cost of its additional stiffness.
- 6.) In designing a wall system to control movements, the effect of proper preloading should not be underestimated. It can be as important to behavior as the structural elements and their properties.
- 7.) Earth berm supports for slurry walls are especially sensitive elements. Their behavior is affected by seepage, weather, time and basic excavation stability; they also are subject to premature removal by an over-zealous subcontractor.

## ACKNOWLEDGMENTS

A series of dedicated Stanford students have assisted the author in the past four years accumulate much information on wall systems. The help of Drs. Yuet Tsui, Gordon Denby, Ayed Osaimi, Abdulaziz Mana, and Messrs. Richard Davidson, Philippe Mayu, and Lawrence Hansen is appreciated. Considerable data are also drawn from other authors; conclusions presented herein are solely those of the author. Financial support for some of the work described in the paper was provided by National Science Foundation Grant No. ENG-77-24308.

## REFERENCES CITED

1. Armento, W. J., "Cofferdam for BARTD Embarcadero Subway Station," Presented at the ASCE National Structural Engineering Meeting, April 9-13, 1973, San Francisco (Preprint No. 1926).
2. Bjerrum, L., Clausen, C. J. F. and Duncan, J. M., "Earth Pressures on Flexible Structures - A State of the Art Report," Proceedings, Fifth European Conference on Soil Mechanics and Foundation Engineering, Vol. 1, Madrid, 1972, pp. 169-196.
3. Broms, B. and Stille, H., "Failure of Anchored Sheet Pile Walls," Journal of the Geotechnical Engineering Division, ASCE, Vol. 102, No. GT3, March, 1976, pp. 225-254.
4. Clough, G. W., "Deep Excavations and Retaining Structures," Proceedings, Conference on Analysis and Design of Building Foundations, 1976, pp. 417-466.
5. Clough, G. W. and Tsui, Y., "Performance of Tied-Back Walls in Clay," Journal of the Geotechnical Division, ASCE, Vol. 100, No. GT12, December, 1974, pp. 1259-1274.
6. Clough, G. W. and Denby, G. M., "Stabilizing Berm Design for Temporary Walls in Clay," Journal of the Geotechnical Engineering Division, ASCE, Vol. 103, No. GT2, February, 1977, pp. 75-90.
7. Clough G. W. and Davidson, R. R., "Effects of Construction on Geotechnical Performance," Proceedings, Specialty Session III, Ninth International Conference on Soil Mechanics and Foundation Engineering, Tokyo, 1977, pp. 15-53.
8. Clough, G. W. and Schmidt, B., "Design and Performance of Excavations and Tunnels in Soft Clay, A State-of-the-Art," Proceedings, International Symposium on Soft Clays, Bangkok, 1977.
9. Clough, G. W. and Chameau, J. L., "A Study of the Behavior of the San Francisco Waterfront Fills Under Seismic Loading," Rept. No. 35, J. A. Blume Earthquake Engineering Center, Stanford University, Stanford, California, February, 1979.

10. DiBiagio, E. and Myrvoll, F., "Full Scale Field Tests of a Slurry Trench Excavation in Soft Clay," Proceedings, Fifth European Conference on Soil Mechanics and Foundations, Madrid, 1972, pp. 461-472.
11. DiBiagio, E. and Roti, J. A., "Earth Pressure Measurements on a Braced Slurry-Trench Wall in Soft Clay," Proceedings, 5th European Conference on Soil Mechanics and Foundation Engineering, Vol. 1, pp. 473-484.
12. Eide, O., Aas, G. and Josang, T., "Special Application of Cast-in-Place Walls for Tunnels in Soft Clay in Oslo," Proceedings, 5th European Conference on Soil Mechanics and Foundation Engineering, Vol. 1, pp. 485-498.
13. Goldberg, D. T., Jaworski, W. E. and Gordon, M. D., "Lateral Support Systems and Underpinning," Vols. 1, 2, 3, 4, Reports FHWA-RD-75-130, Federal Highway Administration, April, 1976.
14. Hanna, T. H. and Kurdi, I. I., "Experimental Studies on Multi-Anchored Flexible Retaining Walls in Sand," Report, Department of Civil and Structural Engineering, University of Sheffield, Sheffield, England, 1974.
15. Hansbo, S., Hofmann, E. and Mosseson, J., "Östra Nordstaden, Gothenberg, Experiences Concerning a Difficult Foundation Problem and Its Unorthodox Solution," Proceedings, Eighth International Soil Mechanics and Foundation Engineering Conference, Vol. 22, Moscow, 1973, pp. 105-110.
16. Johnson, E. G., Gifford, D. G. and Haley, M. X., "Behavior of Shallow Footings Near a Diaphragm Wall," Paper Presented at ASCE National Meeting, San Francisco, October, 1977.
17. Karlsrud, K., "Instrumentation of the Two Storey Tunnel Through Studenterlurden Constructed Using the Diaphragm Wall Technique," Fjellsprengningsteknikk Bergmekanikk/Geoteknikk, 1976, pp. 17.1-17.12.
18. Lambe, T. W., "Braced Excavations," Proceedings, 1970 Specialty Conference on Lateral Stresses in the Ground and Design of Earth-Retaining Structures, ASCE, Cornell University, June, 1970, pp. 149-218.
19. Lambe, T. W., Wolfskill, L. A. and Wong, I. H., "Measured Performance of Braced Excavation," Journal of the Soil Mechanics and Foundations Division, ASCE, Vol. 96, No. SM3, Proc. Paper 7307, May, 1970, pp. 817-836.
20. Mana, A. I., "Behavior of Deep Excavations in Soft Clay," Thesis Presented in Partial Fulfillment of the Ph.D. Degree, Stanford University, 1977.
21. O'Rourke, T. D., Cording, E. J. and Boscardin, M., "The Ground Movements Related to Braced Excavations and Their Influence on Adjacent Buildings," Report No. DOT-TST 76T-23, U.S. Department of Transportation, August, 1976.

22. Peck, R. B., "Deep Excavations and Tunneling in Soft Ground," State-of-the-Art Report, Seventh International Conference on Soil Mechanics and Foundation Engineering, Mexico City, State-of-the-Art Volume, 1969, pp. 225-281.
23. Peck, R. B., Hanson, W. E. and Thornburn, T. H., Foundation Engineering, 2nd Edition, John Wiley and Sons, 1974.
24. Tsui, Y., "A Fundamental Study of Tied-Back Wall Behavior," A Thesis Presented to Duke University in Partial Fulfillment of the Requirements for the Ph.D. Degree, 1974.
25. White, R. E., "Anchored Walls Adjacent to Vertical Rock Cuts," Proceedings, Conference on Diaphragm Walls, Session VI, Institution of Civil Engineers, London, September, 1974, pp. 35-42.

SPEAKER: Professor G. W. Clough  
Stanford University

Question posed by  
someone from  
C. E. Maguire, Inc.

Question:

How far do the movements behind the slurry wall go, and how does one account for these?

Professor Clough

Yes we have made, and many people have made observations of this, and you can be concerned about one excavation depth behind the wall, as a rule of thumb. Now, as you get to a lower factor of safety, the curvatures on the deflection profile back behind the wall get sharper and that becomes your problem in terms of dealing with your distribution of movement, but about one excavation depth back. About two excavation depths back, your movements are diminishing quite a bit. What you really want to look at is the distribution of the curvature that is occurring. As the factor of safety gets low against basal heave, the curvature gets very sharp and that can cause distortion.

SLURRY WALL CONSTRUCTION FOR TRANSPORTATION  
SYSTEMS IN BRITAIN

by

DAVID G. JOBLING  
LONDON TRANSPORT  
LONDON, ENGLAND

ABSTRACT

The paper describes a number of projects where diaphragm walling has been used as part of the permanent structure and also describes two schemes now under design where diaphragm walling will be used.

The work undertaken at Westminster Station is described where diaphragm walling was used as part of a station extension and carries very considerable loads from an underpinning building.

At Northumberland Park, a new depot was built to service trains for the Victoria Line. The approaches between the tunnel and the depot were built using diaphragm walling in wet ground conditions, and this work is described and observations made on the long-term performance of the walls.

Heathrow Central Station was constructed in deep cut and cover, using diaphragm walls as a permanent structure. The paper describes the construction of these walls, their performance and the problems of waterproofing where they form the outer wall of the permanent structure.

Diaphragm wall work at Glasgow in connection with BR work is described, as is also some diaphragm wall work at Newcastle in connection with the new Tyne and Wear Metro.

Stations at Silvertown and Woolwich Arsenal in the Dockland area of London are now under design; both will be in extremely bad ground and diaphragm walling or secant piling will be used. The reasons for the choice of this sort of construction are described.

Some observations are made on the relative merits of achieving a prebuilt wall by slurry trench walls or secant piling, reference being made to particular cases outlining the reasons for the choice.

## SLURRY WALL CONSTRUCTION FOR TRANSPORTATION SYSTEMS IN BRITAIN

### INTRODUCTION

This paper is not intended to go into the methods and technicalities of slurry wall construction, but to describe a number of jobs where slurry walls have been successfully used and to look at some of the problems and reasons why they have been chosen for particular works.

As part of a programme to allow for longer trains, it was necessary in 1963 to extend the platforms at Westminster Station. To avoid disruption to road traffic, it was decided to carry out the platform extension at the east end where the running tunnels were straddled by the New Scotland Yard Building, which was the headquarters of the Metropolitan Police. The building itself was designed by Norman Shaw, a very well-known architect, and as such is a listed building. Therefore, there was no option but to underpin the building to maintain its existing appearance. Although it was a very interesting structural job, this paper will not go into the underpinning aspects, it being sufficient to say that the extended platform tunnel had to carry this seven-story brick building, maintaining it in occupation during the whole period of the works.

Reference to Figure 1 shows the relationship of the building to the tunnel. To avoid the problem of building a new wall close to a building and a brick arch tunnel, it was decided that the new station walls outside the building would be built by the slurry wall method. The wall inside the building, of necessity, had to be on a piled foundation as work had to be carried out from within the basement of the building and it was not possible to get a slurry rig in this confined space. The construction of the slurry wall was carried out by Messrs. Soletanche, Ltd., using a reverse circulation drilling process. The method was entirely satisfactory through the 25-ft. depth of filled ground and gravels, but became a rather slow process when the hard London Clay was encountered. It is worth noting that as the walls were fairly close to the back of the existing brick arch tunnel, considerable trouble was experienced with the Bentonite slurry leaking through the brickwork of the tunnel and on one occasion closed the railway down. Indeed, it was necessary to abandon the slurry wall work for a period while a pre-treatment of the area was carried out using a cement Bentonite grout. When the slurry wall was completed, the top was castellated to form seatings for the steel beams which spanned between the slurry wall and the reinforced concrete wall inside the building. These carried the main wall of the building, the considerable loads of the wall being jacked into the beams by means of Fressi flat jacks. This was probably the first slurry wall used in Britain as part of a permanent structure and certainly the first to carry overlying building loads as well as acting as a permanent retaining wall. In the design of the wall a certain caution was exercised as there was very little previous experience on which to base the design. In spite of the assurances given by the

various publications, the normal bond lengths for reinforcement recommended by the Code of Practice for RC were doubled. The cages themselves were lap welded for rigidity so they did not distort and deform while a considerable weight was being lowered into the slurry filled excavation. At the time, there was little or no information available on the behavior of slurry walls also acting as load bearing piles. Considerable thought was given to their load bearing characteristics. The design of load bearing in-situ bored piles within London Clay was by 1963 a well-defined procedure, the loading being taken partly in friction and partly in end bearing. For the purposes of this design, the friction characteristics of the London Clay were considerably reduced to take account of the presence of a film of Bentonite mud between the clay and the concrete. Also, the design was considered so that in the ultimate failure condition if friction was neglected the whole of the load could be catered for in end bearing only, but with very little safety factor. This wall has now been in service for 16 years as a load bearing structure; for the first 6 years of its life, settlement records were kept but as during this period, apart from the initial settlement, there was no consistent pattern, further measurements were abandoned.

In retrospect, although certain problems were met in constructing the slurry wall, even worse problems were met with constructing those lengths of traditional reinforced concrete walls in the very bad ground conditions. There is little doubt that in spite of the difficulties, the decision to use this form of construction was entirely justified and economic.

Regarding the finished performance of the wall, it was reasonably watertight except for one area where a delay with concrete delivery occurred and Bentonite mud got rolled into the concrete. This had to be cut out and replaced. Nevertheless, it is not really reasonable to expect 100% watertightness for the life of the wall, and therefore a false brick wall was built some 6 inches in front of the diaphragm wall with a drainage channel formed between the brick and the diaphragm wall. This 4-1/2 inch skin wall was tied to the diaphragm wall by means of normal twisted brick ties. It is worthy of note that, as at that time the station was due for modernization, rather than carry out a decorative finish on the extended part of the platforms in isolation of the whole station, the brick wall was studded out with timber and covered with hardboard which was painted. Owing to various delays with station modernization program, the hardboard finish is still in existence and after 16 years is still perfectly satisfactory in its general appearance.

Shortly after the Westminster works, it was necessary to build a new depot at Northumberland Park to service the trains for the Victoria Line which was then under construction. Since the whole line was underground and the depot was a surface depot, it was necessary to construct an approach tunnel between the depot and the driven tunnels. The ground in the area was very indifferent, being adjacent to the River Lea and within its flood plain. It was decided to build the cut and cover approach tunnels using slurry walls rather than by the traditional cut and cover techniques.



Figure 2 shows the extent of this work. Part of the tunnel near the surface was covered with a lightweight snow roof, but in the deeper sections of the cut and cover tunnel, the diaphragm walls carried a roof formed with prestressed precast concrete beams. The contractor for the diaphragm wall work chose to use a grab excavating method but, as it was in the early days of diaphragm wall work, the sophisticated guide systems for grabs now in existence were not used so that basically the grab was a free falling grab. The joint between the panels was formed by tubes in the usual manner. On the whole, this work went fairly well but in the upper parts of the trench some problems arose due to the caving in of the trench which gave rise to some substantial blips on the diaphragm wall. This was probably partly due to the unguided grab tending to twist and cause some problems with the upper parts of the excavation. However, the finished results were perfectly satisfactory although the finished appearance perhaps left something to be desired. The ground in the area was exceedingly wet and consequently there were a number of fairly severe leaks between the joints in the diaphragm walls in one or two places through defective areas of diaphragm wall. These were treated by drilling holes through the wall and injecting grout to seal the leaks. Although this treatment was given at locations where water was actually running, no attempt was made to treat those areas of the wall which were just damp. Since this was a railway tunnel being an approach to a depot, no attempt was made to line the walls in any way, but drainage channels were placed at the bottom of the wall to channel the infiltrating water into sumps and hence into the main drainage sump where the water was pumped to the surface. In this respect it should be noted that the cost of treatment to get a diaphragm wall almost completely waterproof may be very high compared to the comparatively low cost of installing pumps and pumping small quantities of inflowing water. In the 14 years these walls have been in service, no difficulties have been experienced.

A far more recent London Transport project using diaphragm walls is the new underground station at Heathrow Central. Although this part of the line was built in driven tunnel, it was decided to build the station in cut and cover methods and therefore a short length of platform had to be constructed within driven tunnel. Because of the constraints on a site in the middle of a very busy airport, it was decided that for the most satisfactory and economic method of construction would be to use diaphragm walls to form the permanent outer structure of the box forming the station. Reference to Figure 3 shows the extent of the slurry walling, and Figure 4 the structure of the station in cross section. The sub-contract for the slurry walls was let to Messrs. Soletanche, Ltd., and the metre thick walls were built in traditional fashion using a guided grab. Progress was generally good and the walls themselves were completed slightly ahead of programme. A difficulty in construction occurred while some sheet piles were being driven in the vicinity to form a box around one of the three subway entrances. The vibration due to the sheet piling caused parts of the slurry trench fairly near the surface within the water bearing gravels to cave in, so that when the wall was exposed, there were some severe blisters on the exposed face of the diaphragm wall. As soon as it was realized that the piling was causing a problem, the operation

was suspended until after the completion of the diaphragm wall. The box was excavated to full depth using two steel support frames placed as the work proceeded. The upper frame was preloaded by means of flat jacks. The two intermediate floors were keyed into the diaphragm walling by exposing the reinforcement and tying in the slab reinforcement.

The main problem experienced was the cutting of the tunnel eyes in the diaphragm wall after completion of the box. This proved a very slow time-consuming job. Manual breakers, machine breakers, and thermic lances were tried and finally a combination of all three; but the job took some six times longer than its programmed period. As a result of this experience, there is no doubt that where tunnel eyes have to be cut within a diaphragm wall on future work, special provisions will be made. Again it must be stressed that the top 30-ft. of ground at Heathrow was water-bearing gravel with a water table only some five to six feet below ground level. Therefore, as before, the whole design concept was that the wall would not be 100% watertight and drainage channels around the perimeter of the box were incorporated at each floor level. A false brick lining wall was constructed leaving a 6-inch gap between the diaphragm wall and the brick skin wall; thus any water penetrating the wall was led away by the drainage channel leaving the brick skin wall dry to take the tiles and other finishings. The result was entirely successful except for one or two problem places at platform level where it had been necessary to dispense with a false wall in order to form some concrete duct blocks against the diaphragm wall. To alleviate the problem some drill holes were taken from track level through the concrete of the duct block and into the joints in the diaphragm wall, thus allowing the water to escape directly into the track drain. It should be emphasized that where diaphragm walling is to form part of the permanent structure, it must always be assumed that there will be some leakage, even though it be small amounts, that would be quite sufficient to spoil finishings applied directly to a concrete facing to the wall.

A most interesting job is nearing completion at Argyle Station on the British Railways Clyderail Scheme. The work is under the direction of the Chief Civil Engineer, Mr. G. B. Craig, Scottish Region, the consulting engineer being W.A. Fairhurst & Partners, and the contractor Lilley Construction, the slurry wall sub-contractor being ICOS. The project is the refurbishment of an old line through the center of Glasgow built in cut and cover at the end of the last century. The old brick tunnels ran directly down the center of Argyle Street, which is one of the main shopping streets in Glasgow. The problem was to construct a new station in this busy street. Because of the proximity of substantial buildings and the necessity of interfering as little as possible with the functioning of the shops, a diaphragm wall method of construction was chosen. The general layout is shown in Figure 5. The ground is basically sand silts overlying a sandstone bed rock some 28 metres below street level. A pre-contract was let to drive sheet piles adjacent to the properties over the length of the works and to divert all the statutory services into a position adjacent to the sheet piling. It also included building one wall of the pre-trench for the diaphragm wall. The purpose of the sheet piling was to form a protected area between the

sheet piles and the back of the diaphragm wall so that should it be necessary in the future to carry out any work on the services, it could be done without endangering either the station works or the adjacent premises. The thickness of the external diaphragm walls was one metre in some parts and 800 mm in others. The internal walls were 600 mm thick. The sequence of construction is shown in Figure 6.

Two points are worth noting. The central diaphragm walls that were necessary for the staircases and escalators leading from platform to concourse level were driven from within the existing tunnel. The other is that to minimize disruption at surface level only short lengths of the street were occupied at any one time. A shallow excavation was taken down to just below the soffit of the new roof. Then capping beams were constructed on the diaphragm walls and a new roof of prestressed concrete beams placed and waterproofed, the reinstatement of the street then taking place immediately. The extent of the disruption can be seen in the photograph of Figure 7. In this way it was possible to keep the whole street open to pedestrians, service vehicles to the shops and more especially to enable emergency service vehicles such as fire engines to reach all premises at any time. This job is very typical of situations where the diaphragm wall is at its most useful. By more traditional construction methods the surface disruption would have been very much greater and there is a strong possibility that some of the adjacent properties would have had to have been underpinned or at best may have suffered some settlement. The work would almost certainly have been considerably more expensive. Again mention must be made of the fact that the joints in the wall were not expected to be completely watertight for the life of the wall. Therefore, a decorative facing system was utilized that stood off the wall leaving a gap so that any infiltrating water would run into a drainage channel. (see Figure 8)

In a paper on the use of diaphragm walls for permanent sub-surface construction, mention must be made of the use of the secant pile wall which serves exactly the same purpose as a diaphragm wall but the method of construction is entirely different. The secant pile wall is a series of in-situ concrete bored piles constructed with a special rig and in such a way that the piles are interlocked with each other forming a continuous wall. London Transport uses this method widely and in recent years has used the method for the construction of a number of sub-surface stations and for a cut and cover tunnel. A job which is currently in progress at Kings Cross using secant piles is shown in Figure 9. On this work, slurry walls could equally as well have been used, but because of the confined space and certain other factors, London Transport considered that in this particular situation, the secant pile method had some advantages. To illustrate the point, Figures 10 & 11 show two jobs which are presently being designed in the London Transport office for an extension of the underground railway eastwards along the line of the River Thames. The two stations are Silvertown and Woolwich Arsenal, being adjacent stations on this line. In both stations, the ground conditions are expected to be very bad. At Silvertown, the entire construction will be within a fine grain sand with a water table level not far below ground level. A bed of chalk is at a level not far below the track level. At Woolwich Arsenal, the chalk is at a level so that about half the construction

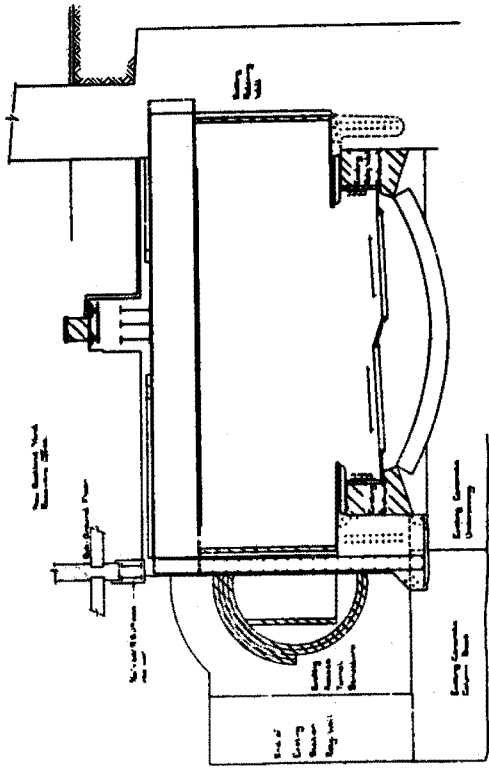
will be within chalk, but the chalk is overlaid with a water-bearing silty sand that is very difficult to chemically treat even if resins are used, which are extremely expensive. Given an open site at these stations, the choice would be to carry out the construction for the whole station by cut and cover methods using either slurry walls or secant piles. Because, however, properties overlie a good deal of the station area, this is not possible. For different reasons on the two stations, use is being made of slurry wall/secant pile construction. To consider first Silvertown Station shown in Figure 10 at the first state, only one tunnel of the station will be built. The second station tunnel will be built at a later date after the first one is commissioned. If a tunneled escalator shaft in bad ground was used, it is very probable that tunneling the second station tunnel would cause some movement of the escalator shaft which could well cripple an installed and commissioned heavy duty escalator. Therefore it was decided to use a diaphragm wall box to contain the escalator, thus making the tunneling of the second station tunnel very much easier. From here it was a short step to contain as much of the platform within this box as possible. Thus within the confines of the surface configuration, the shape of diaphragm wall shown is being used. As it is desired to seal the diaphragm walls into the chalk to prevent possible problems with the water bearing sands boiling up from under the base of the walls as excavation proceeds, the walls will be rather deep. For this reason, coupled with the fact that it is a fairly open site, it was considered that slurry walling would be rather better than secant piling.

At Woolwich Arsenal, the situation is rather different. The site is extremely confined and surrounded with property much of which would be very expensive to buy and demolish for the works, but there are clearly severe problems in carrying out the tunnel works in the very bad ground conditions expected. To minimize the problems, it is planned to build a diaphragm wall around the upper machine chamber of the lower level escalator and as much of the actual shaft itself as can be contained within the box, the limits of which are dictated by the surface features. From this box probes will be driven to freeze the ground using refrigerated brine or liquid nitrogen which will enable the rest of the escalator shaft and the lower concourse to be driven in comparative safety and hopefully without causing substantial settlement to the overlying telephone exchange which carries much expensive equipment rather sensitive to excessive vibration or movement. At this site it has been decided to use secant piling rather than slurry walling. This is because of the comparatively shallow level to the chalk, the probability that older and unknown building foundations and services will be encountered, and finally because of the very confined and congested nature of the site. It must be emphasized, however, that on both these jobs either method could be used. It is just that in the experience of London Transport engineers, some situations appear to be better suited to one particular method. It should be noted that the tenderers for either job will be allowed to submit alternative quotations for either method of construction should they so wish. In both these jobs there is a very strong case for using a diaphragm wall method of construction. There is no

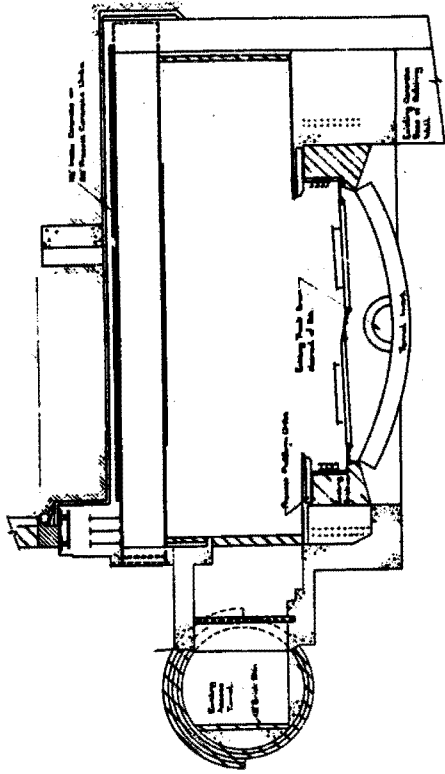
doubt that other methods could be evolved that would be perfectly practicable, but almost certainly would be considerably more difficult, give rise to many more technical problems, and be very much more expensive.

The use of diaphragm walls as part of the permanent structure has been used very successfully by London Transport in the past and will continue to be used in the future as an economic and trouble-free method of construction.

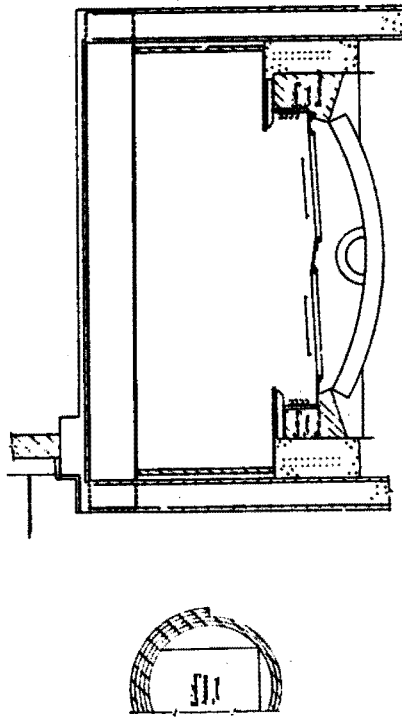




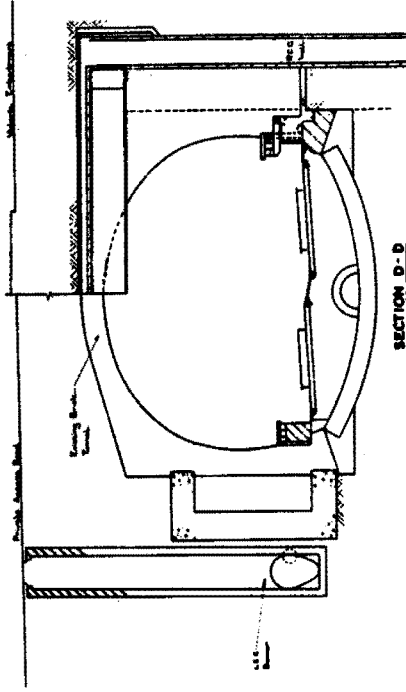
SECTION A-A



SECTION B-B



SECTION C-C



SECTION D-D

DISTRICT LINE - WESTMINSTER STATION - PLATFORM EXTENSION.  
CROSS SECTIONS.

| CONTRACT NO. AND SHEET          | DATE                            | BY   | IN CHARGE | DESIGNED BY | CHECKED BY | DATE | APPROVED BY |
|---------------------------------|---------------------------------|------|-----------|-------------|------------|------|-------------|
| AS SHOWN OTHERWISE INDICATED BY |                                 |      |           |             |            |      |             |
| REVISIONS                       |                                 |      |           |             |            |      |             |
| NO.                             | DESCRIPTION                     | DATE | BY        | IN CHARGE   | DATE       | BY   | IN CHARGE   |
| 1                               | AS SHOWN OTHERWISE INDICATED BY |      |           |             |            |      |             |
| 2                               |                                 |      |           |             |            |      |             |
| 3                               |                                 |      |           |             |            |      |             |
| 4                               |                                 |      |           |             |            |      |             |
| 5                               |                                 |      |           |             |            |      |             |
| 6                               |                                 |      |           |             |            |      |             |
| 7                               |                                 |      |           |             |            |      |             |
| 8                               |                                 |      |           |             |            |      |             |
| 9                               |                                 |      |           |             |            |      |             |
| 10                              |                                 |      |           |             |            |      |             |
| 11                              |                                 |      |           |             |            |      |             |
| 12                              |                                 |      |           |             |            |      |             |
| 13                              |                                 |      |           |             |            |      |             |
| 14                              |                                 |      |           |             |            |      |             |
| 15                              |                                 |      |           |             |            |      |             |
| 16                              |                                 |      |           |             |            |      |             |
| 17                              |                                 |      |           |             |            |      |             |
| 18                              |                                 |      |           |             |            |      |             |
| 19                              |                                 |      |           |             |            |      |             |
| 20                              |                                 |      |           |             |            |      |             |
| 21                              |                                 |      |           |             |            |      |             |
| 22                              |                                 |      |           |             |            |      |             |
| 23                              |                                 |      |           |             |            |      |             |
| 24                              |                                 |      |           |             |            |      |             |
| 25                              |                                 |      |           |             |            |      |             |
| 26                              |                                 |      |           |             |            |      |             |
| 27                              |                                 |      |           |             |            |      |             |
| 28                              |                                 |      |           |             |            |      |             |
| 29                              |                                 |      |           |             |            |      |             |
| 30                              |                                 |      |           |             |            |      |             |
| 31                              |                                 |      |           |             |            |      |             |
| 32                              |                                 |      |           |             |            |      |             |
| 33                              |                                 |      |           |             |            |      |             |
| 34                              |                                 |      |           |             |            |      |             |
| 35                              |                                 |      |           |             |            |      |             |
| 36                              |                                 |      |           |             |            |      |             |
| 37                              |                                 |      |           |             |            |      |             |
| 38                              |                                 |      |           |             |            |      |             |
| 39                              |                                 |      |           |             |            |      |             |
| 40                              |                                 |      |           |             |            |      |             |
| 41                              |                                 |      |           |             |            |      |             |
| 42                              |                                 |      |           |             |            |      |             |
| 43                              |                                 |      |           |             |            |      |             |
| 44                              |                                 |      |           |             |            |      |             |
| 45                              |                                 |      |           |             |            |      |             |
| 46                              |                                 |      |           |             |            |      |             |
| 47                              |                                 |      |           |             |            |      |             |
| 48                              |                                 |      |           |             |            |      |             |
| 49                              |                                 |      |           |             |            |      |             |
| 50                              |                                 |      |           |             |            |      |             |
| 51                              |                                 |      |           |             |            |      |             |
| 52                              |                                 |      |           |             |            |      |             |
| 53                              |                                 |      |           |             |            |      |             |
| 54                              |                                 |      |           |             |            |      |             |
| 55                              |                                 |      |           |             |            |      |             |
| 56                              |                                 |      |           |             |            |      |             |
| 57                              |                                 |      |           |             |            |      |             |
| 58                              |                                 |      |           |             |            |      |             |
| 59                              |                                 |      |           |             |            |      |             |
| 60                              |                                 |      |           |             |            |      |             |
| 61                              |                                 |      |           |             |            |      |             |
| 62                              |                                 |      |           |             |            |      |             |
| 63                              |                                 |      |           |             |            |      |             |
| 64                              |                                 |      |           |             |            |      |             |
| 65                              |                                 |      |           |             |            |      |             |
| 66                              |                                 |      |           |             |            |      |             |
| 67                              |                                 |      |           |             |            |      |             |
| 68                              |                                 |      |           |             |            |      |             |
| 69                              |                                 |      |           |             |            |      |             |
| 70                              |                                 |      |           |             |            |      |             |
| 71                              |                                 |      |           |             |            |      |             |
| 72                              |                                 |      |           |             |            |      |             |
| 73                              |                                 |      |           |             |            |      |             |
| 74                              |                                 |      |           |             |            |      |             |
| 75                              |                                 |      |           |             |            |      |             |
| 76                              |                                 |      |           |             |            |      |             |
| 77                              |                                 |      |           |             |            |      |             |
| 78                              |                                 |      |           |             |            |      |             |
| 79                              |                                 |      |           |             |            |      |             |
| 80                              |                                 |      |           |             |            |      |             |
| 81                              |                                 |      |           |             |            |      |             |
| 82                              |                                 |      |           |             |            |      |             |
| 83                              |                                 |      |           |             |            |      |             |
| 84                              |                                 |      |           |             |            |      |             |
| 85                              |                                 |      |           |             |            |      |             |
| 86                              |                                 |      |           |             |            |      |             |
| 87                              |                                 |      |           |             |            |      |             |
| 88                              |                                 |      |           |             |            |      |             |
| 89                              |                                 |      |           |             |            |      |             |
| 90                              |                                 |      |           |             |            |      |             |
| 91                              |                                 |      |           |             |            |      |             |
| 92                              |                                 |      |           |             |            |      |             |
| 93                              |                                 |      |           |             |            |      |             |
| 94                              |                                 |      |           |             |            |      |             |
| 95                              |                                 |      |           |             |            |      |             |
| 96                              |                                 |      |           |             |            |      |             |
| 97                              |                                 |      |           |             |            |      |             |
| 98                              |                                 |      |           |             |            |      |             |
| 99                              |                                 |      |           |             |            |      |             |
| 100                             |                                 |      |           |             |            |      |             |

FIGURE 1-a WESTMINSTER STATION, CROSS SECTIONS

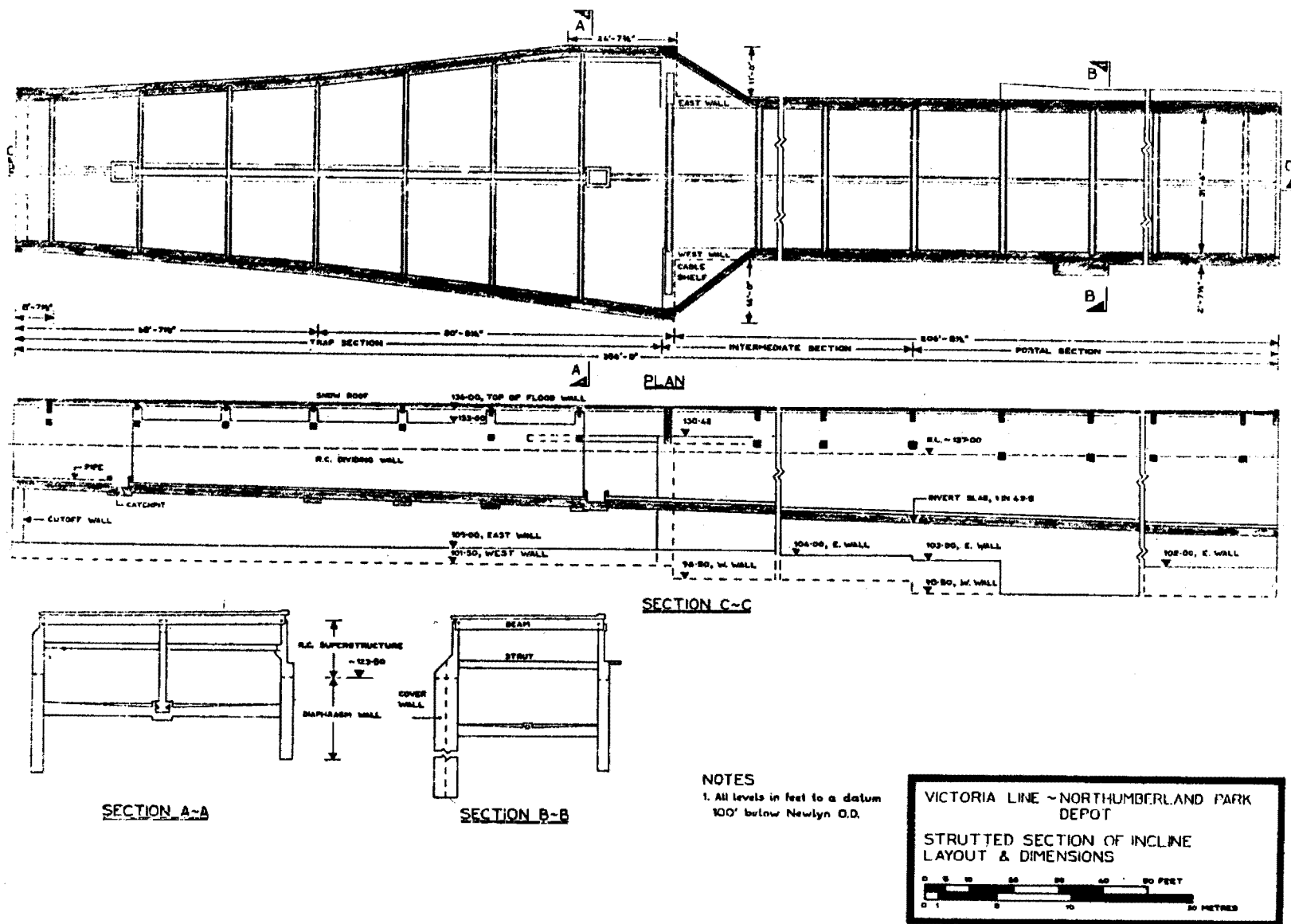


FIGURE 2 NORTHUMBERLAND PARK DEPOT, STRUTTED SECTION OF INCLINE LAYOUT AND DIMENSIONS



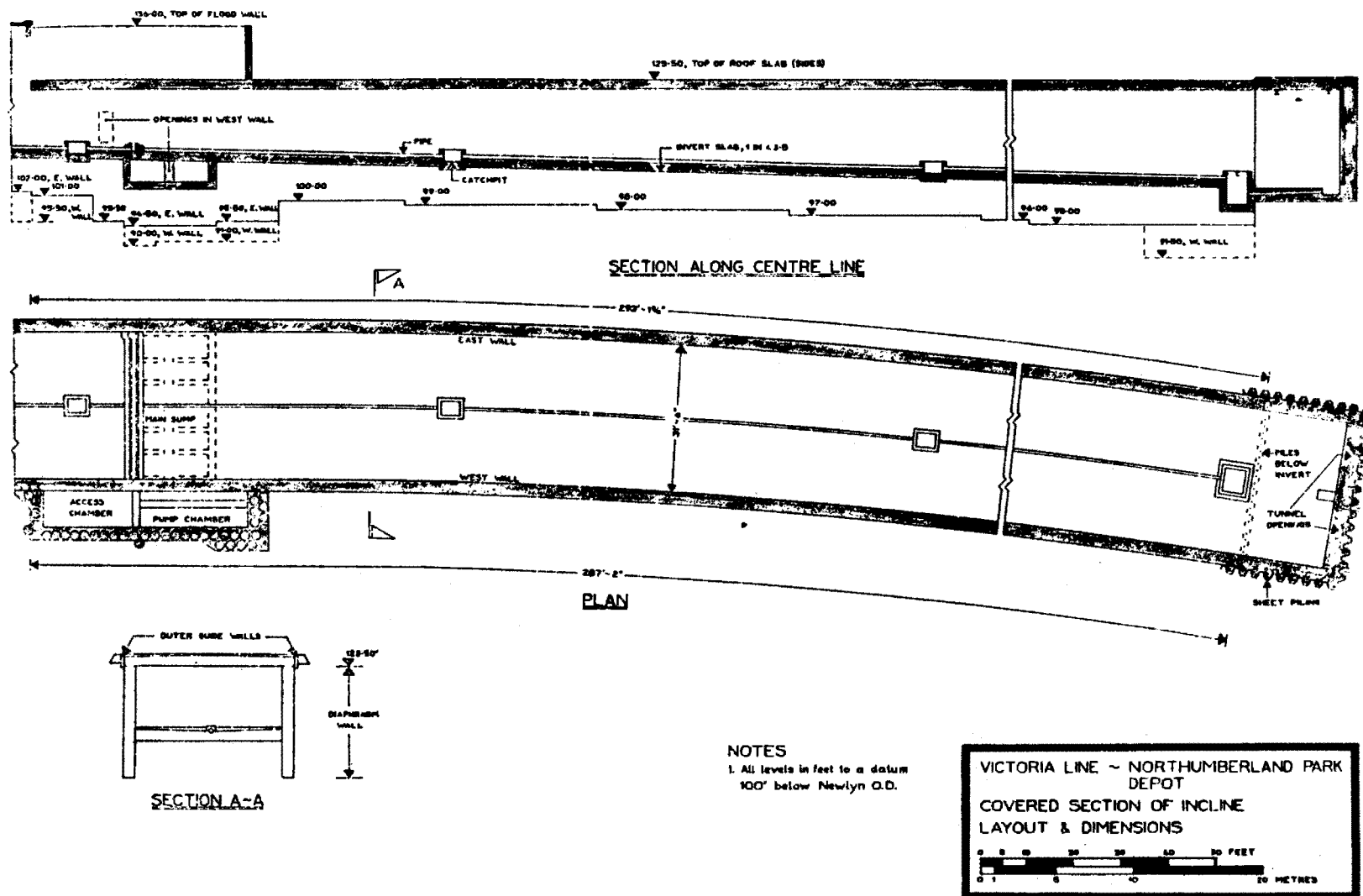


FIGURE 2-a NORTHUMBERLAND PARK DEPOT, COVERED SECTION OF INCLINE LAYOUT AND DIMENSIONS

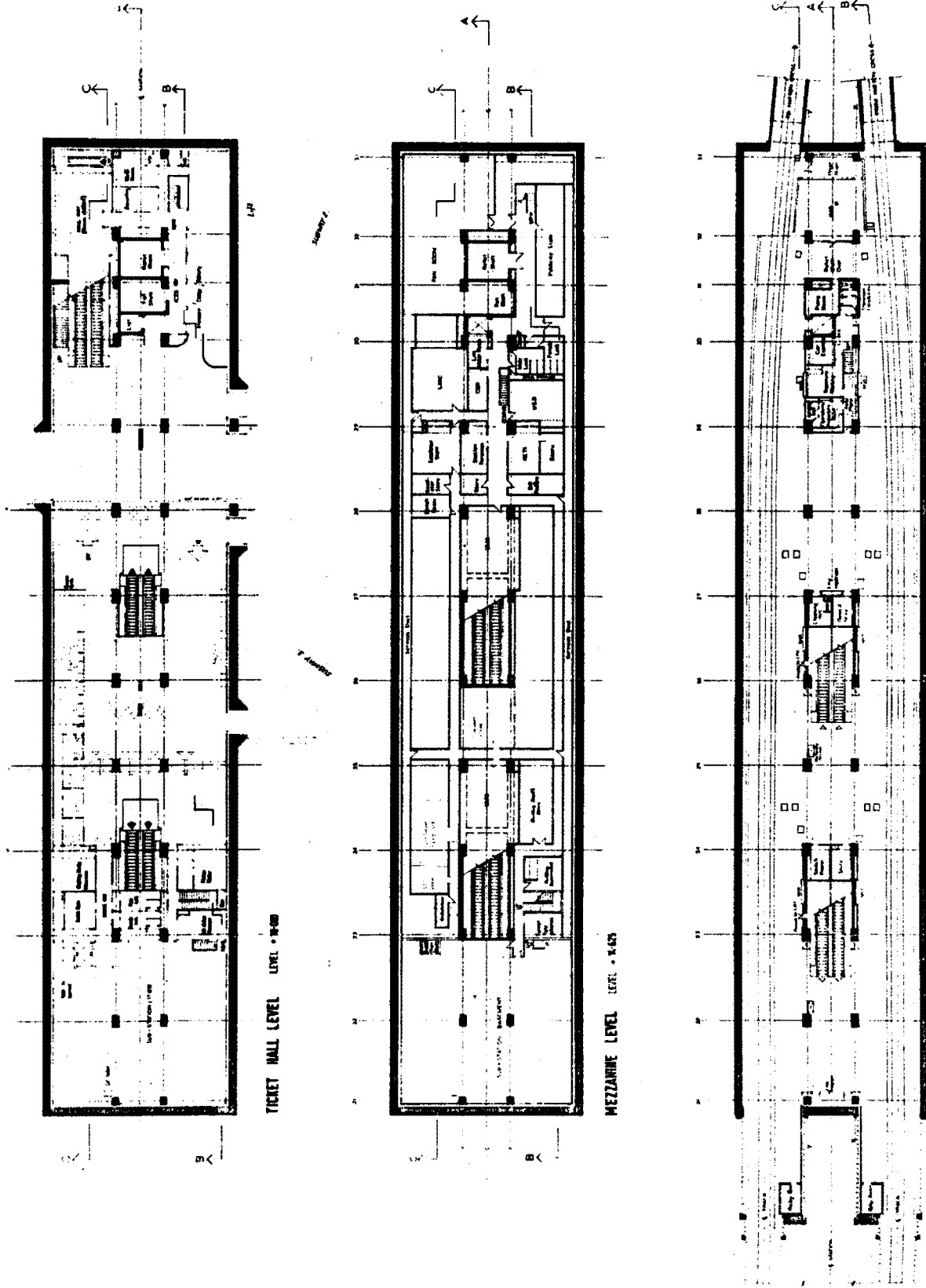
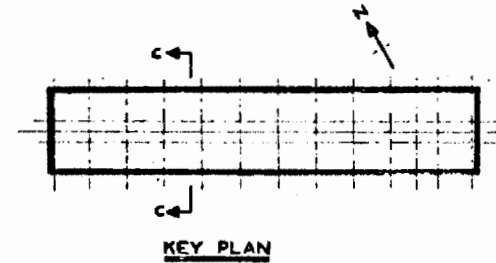
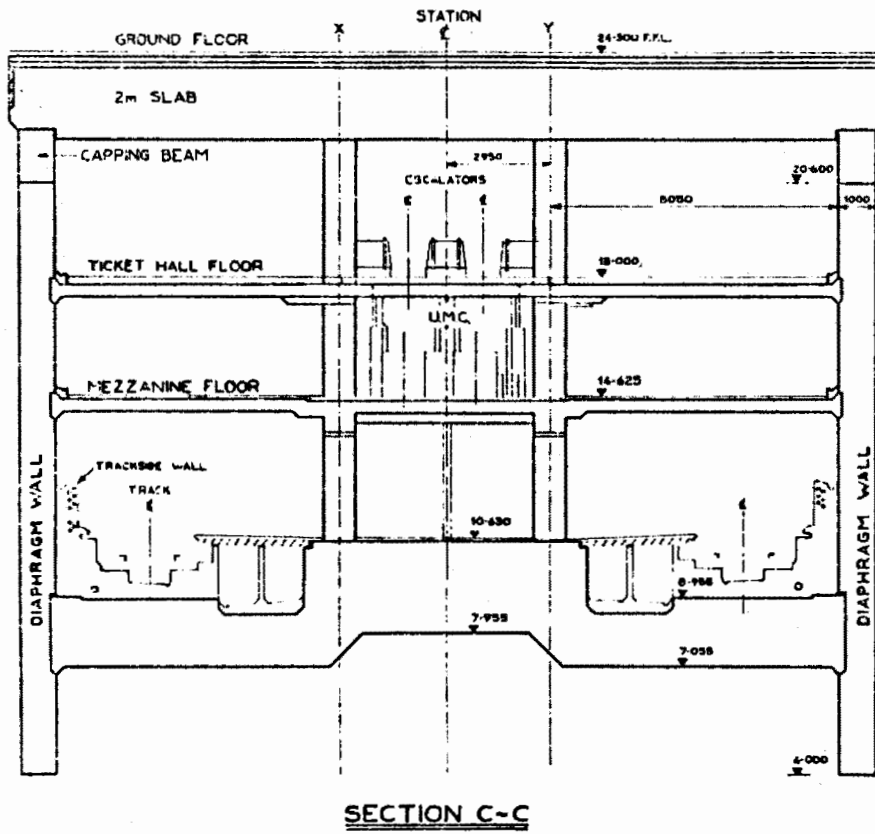


FIGURE 3 HEATHROW CENTRAL STATION, FLOOR PLANS



NOTES

1. All levels in metres above Newlyn O.D.
2. All dimensions in millimetres.

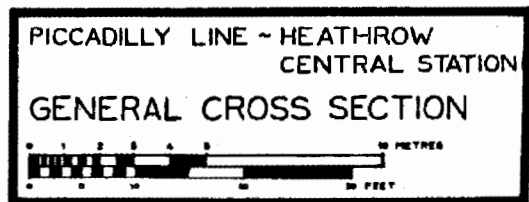


FIGURE 4 HEATHROW CENTRAL STATION, GENERAL CROSS SECTION

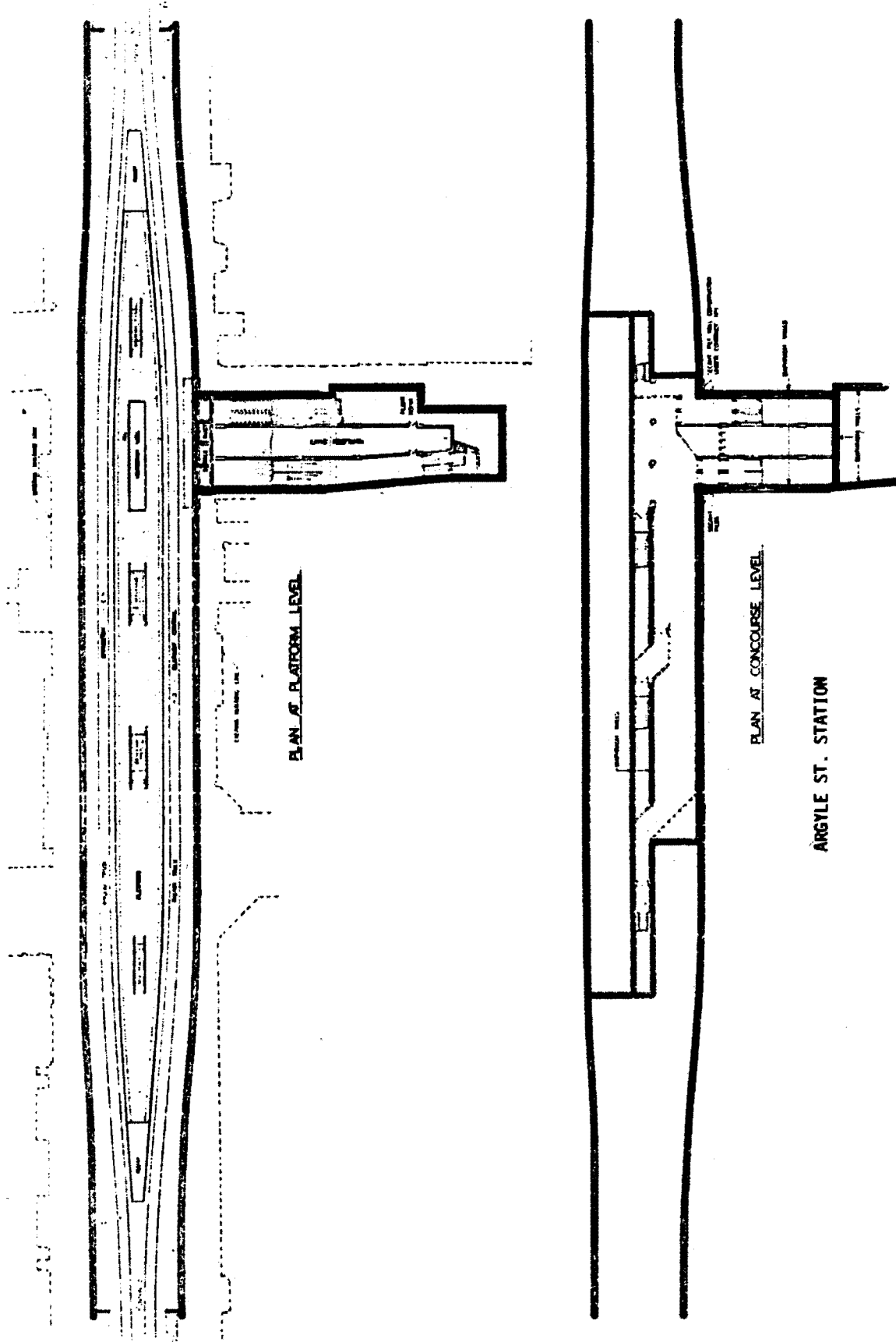


FIGURE 5 ARGYLE ST. STATION, FLOOR PLANS

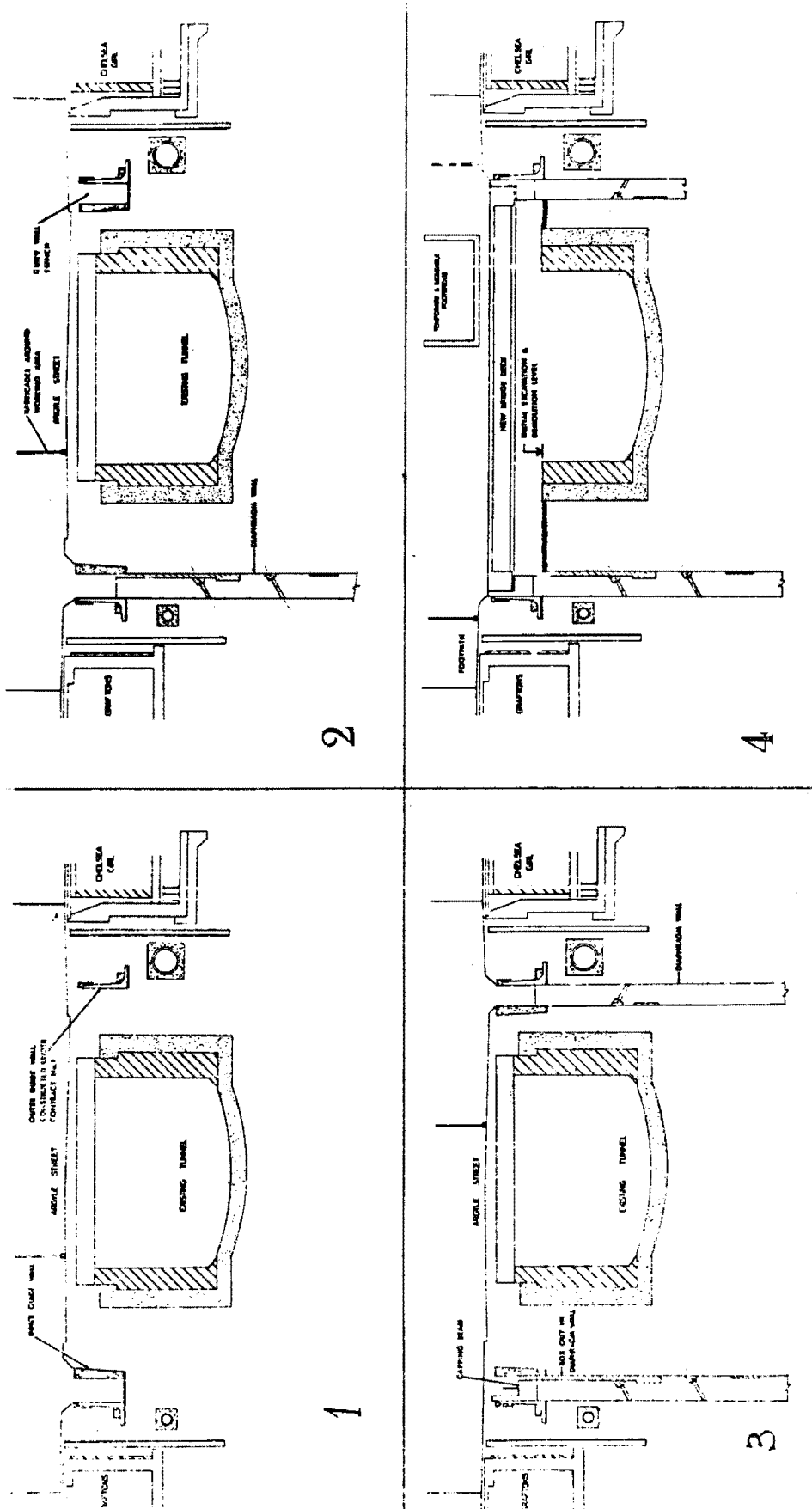


FIGURE 6 ARGYLE ST. STATION, CROSS SECTIONS

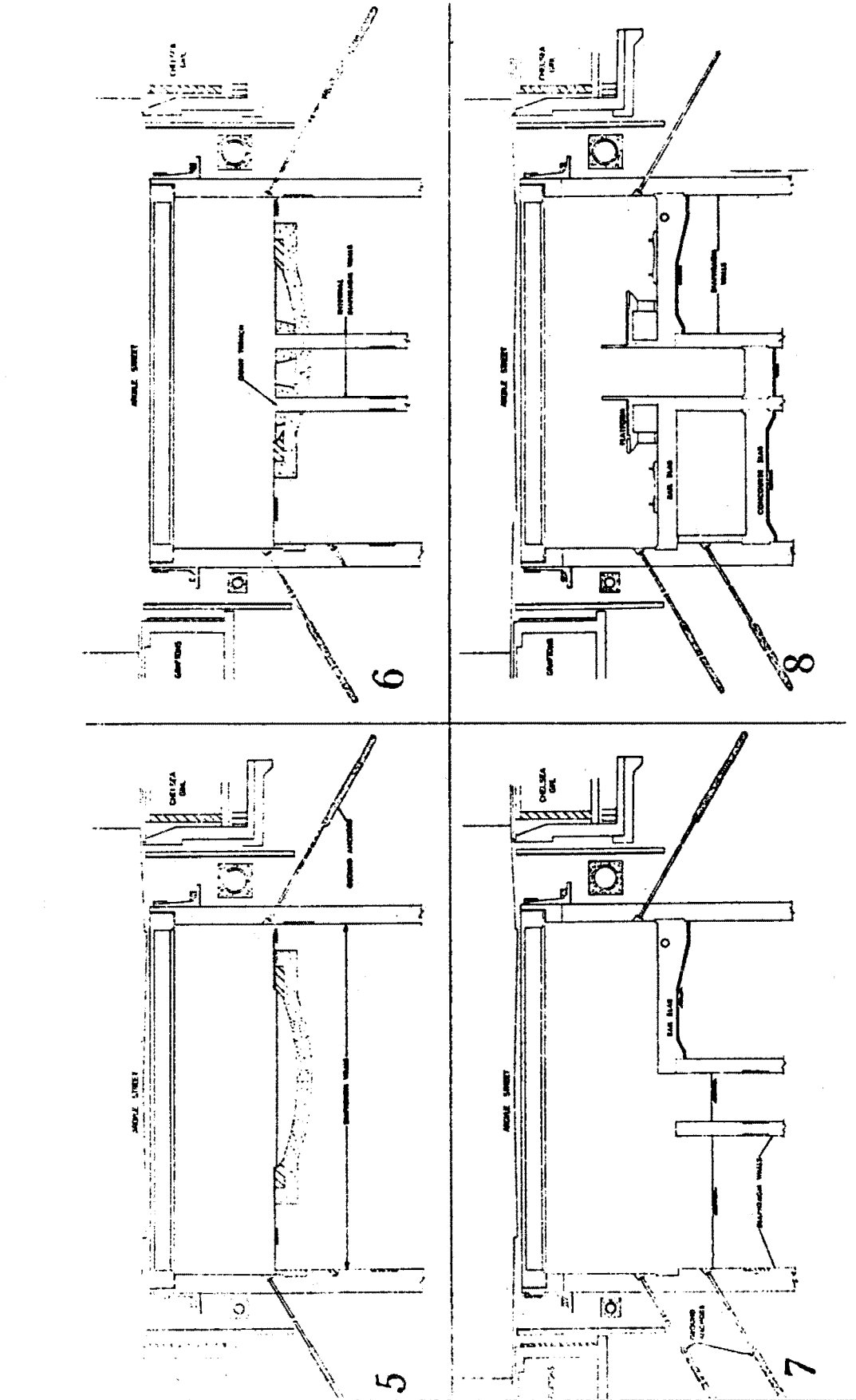


FIGURE 6-a ARGYLE ST. STATIONS, CROSS SECTIONS

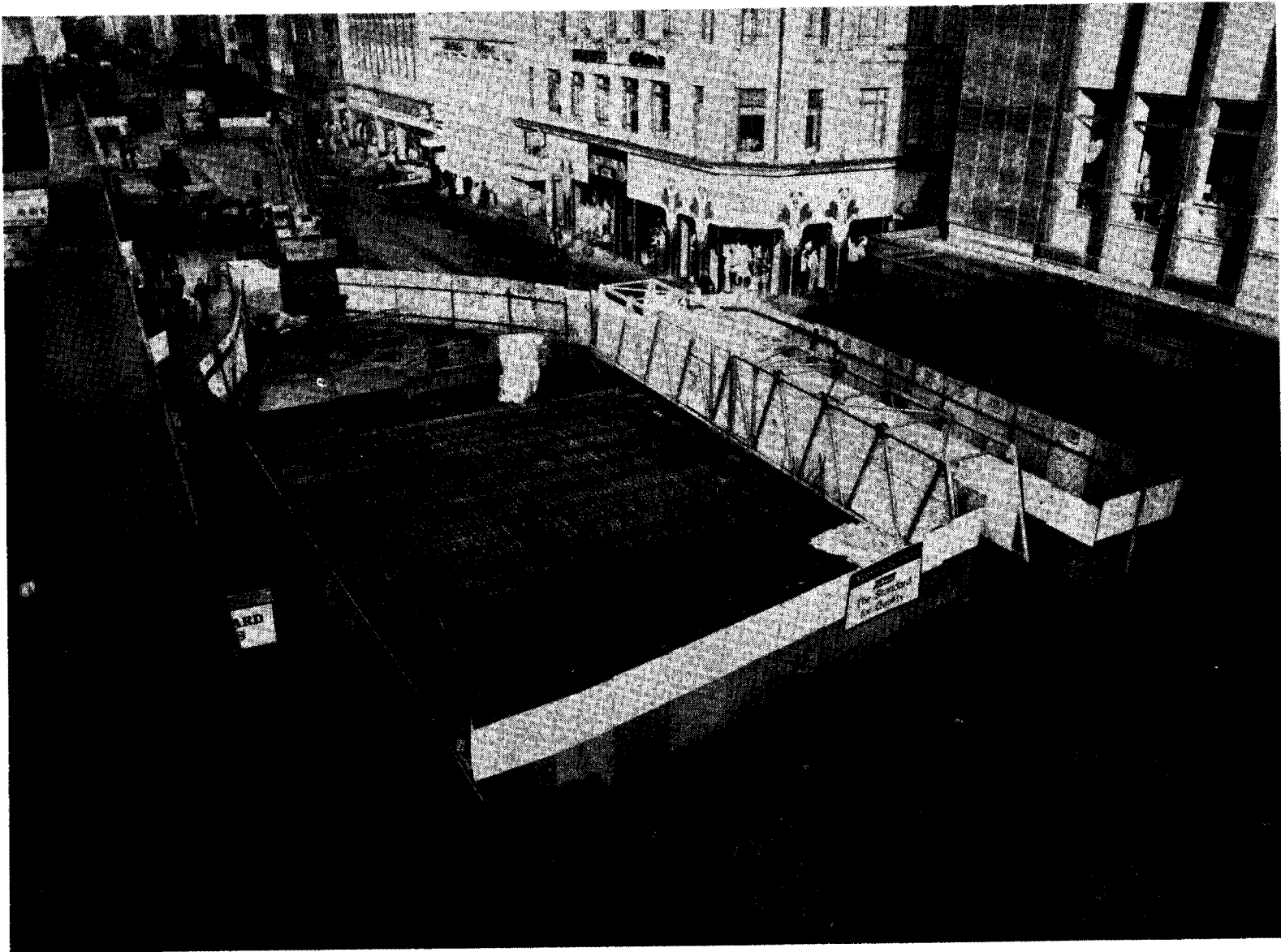


FIGURE 7 VIEW OF ARGYLE STREET SHOWING ONE SECTION OF ROOF BEING CONSTRUCTED.



FIGURE 8 VIEW OF STATION NEARING COMPLETION SHOWING THE DECORATIVE LINING PANELS.



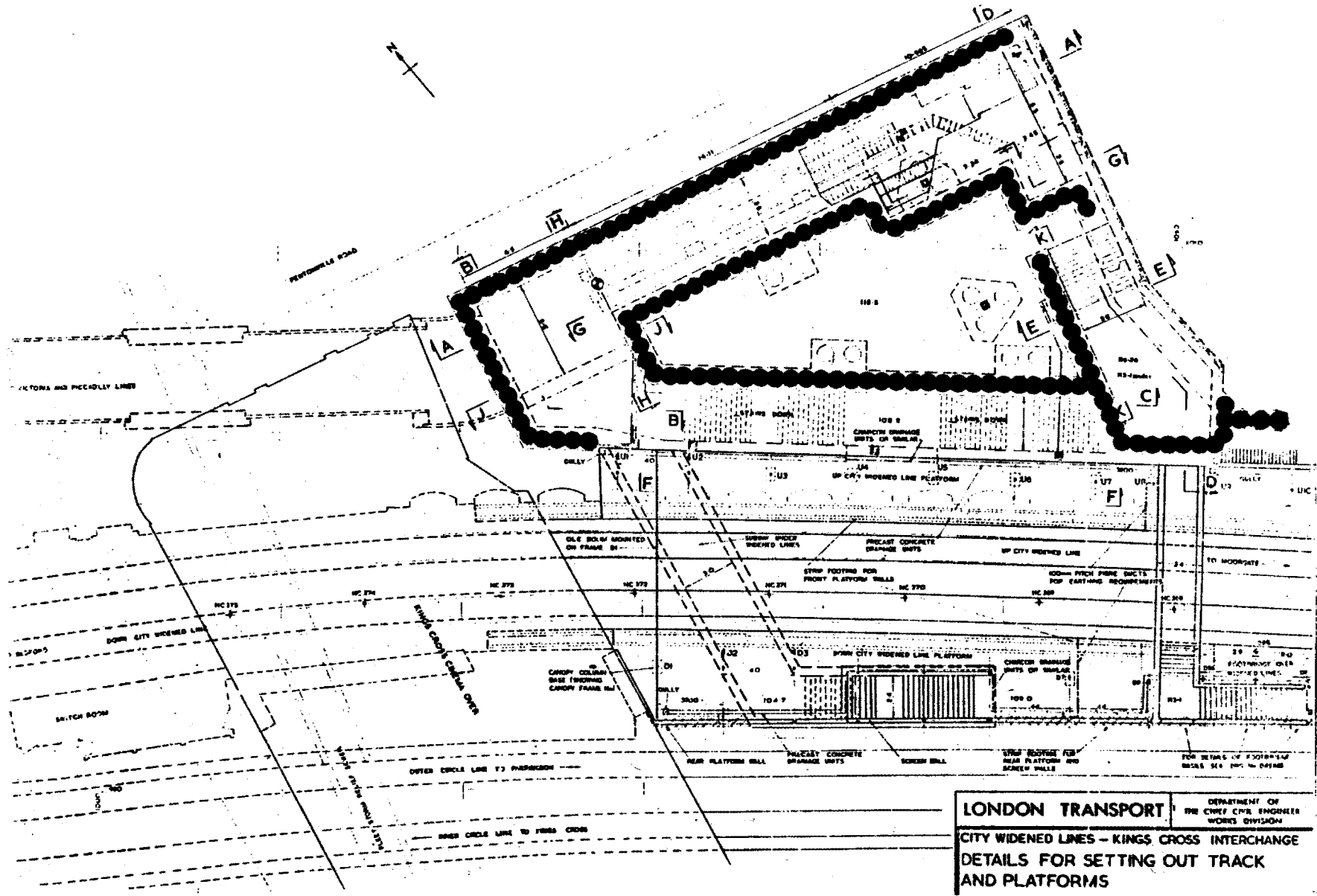


FIGURE 9 KINGS CROSS INTERCHANGE, DETAILS FOR SETTING OUT TRACK AND PLATFORMS

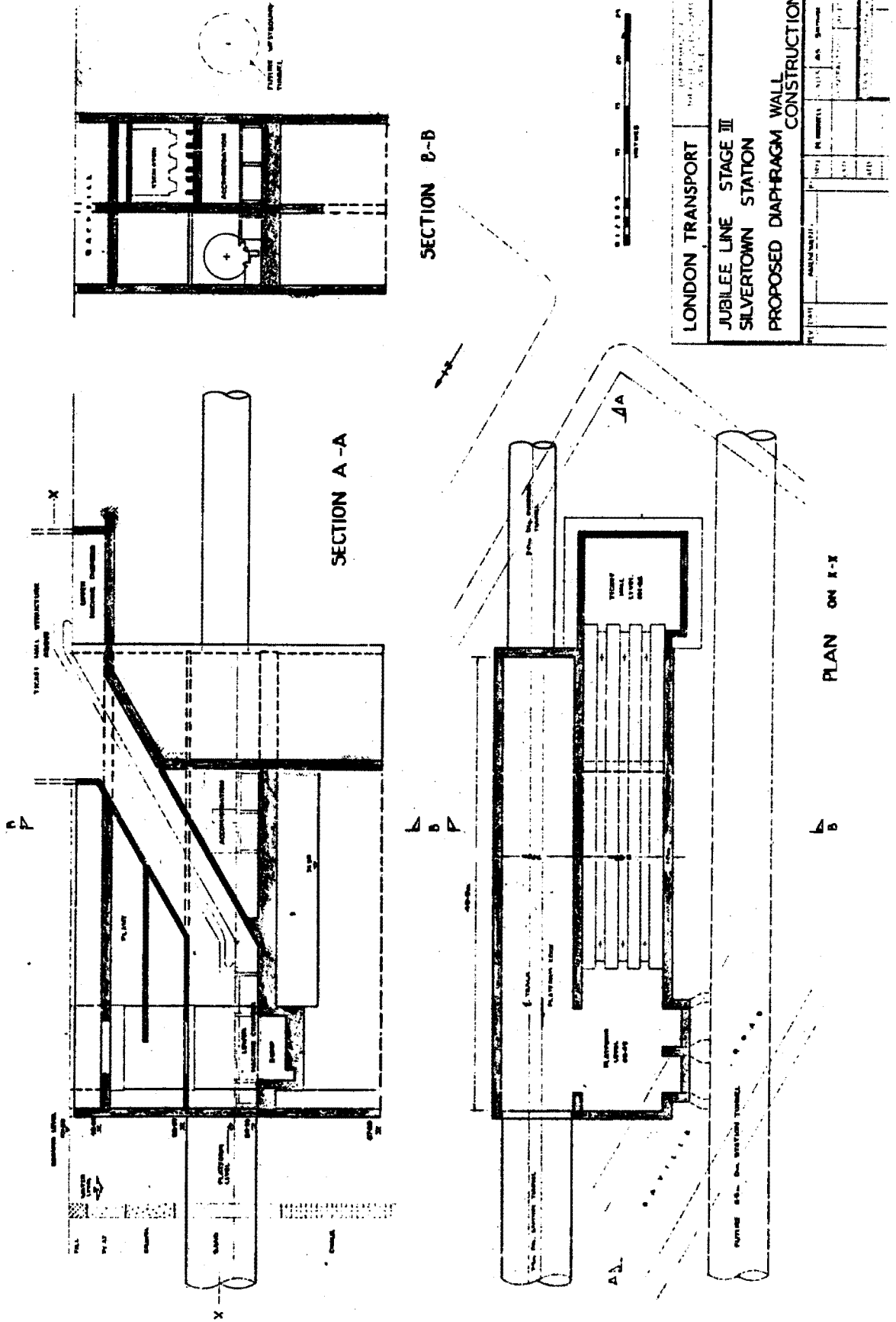


FIGURE 10 SILVERTOWN STATION, PROPOSED DIAPHRAGM WALL CONSTRUCTION



CHARLES CENTER STATION, BALTIMORE RAPID TRANSIT SYSTEM  
SLURRY WALL DESIGN AND INSTALLATION

by

UGO PICCAGLI

PRESIDENT, BENCOR CORPORATION OF AMERICA

DALLAS, TEXAS

and

DRUPAD B. DESAI

CHIEF ENGINEER, DANIEL, MANN, JOHNSON & MENDENHALL

BALTIMORE, MARYLAND

**ABSTRACT**

The above presentation will cover the following items:

1. General presentation of the Baltimore system.
2. Slurry wall design for the North Station, the Laurens Street Station and the Charles Center Station.
3. Charles Center Station slurry wall. Soil conditions, wall and underpinning as per contract documents, wall as actually being installed, construction procedures.
4. Design considerations for the Charles Center Station underground construction.
5. Consideration on temporary and permanent slurry wall for the Charles Center Station.

CHARLES CENTER STATION, BALTIMORE RAPID TRANSIT SYSTEM  
SLURRY WALL DESIGN AND INSTALLATION

INTRODUCTION

This paper was prepared to offer the experience we have had relative to the slurry walls as used for the Charles Center Station of the Baltimore Rapid Transit System. The concept, design, and approval of this installation has been particularly lengthy and difficult due to several factors which we believe will be of interest for the future projects where the slurry walls might be considered either as temporary retention walls or as permanent walls, achieving the triple purpose of retaining the earth during excavation, protecting existing adjacent foundations, and thus eliminating underpinning and becoming a permanent part of the structure.

We believe that the retention system for the Charles Center Station, now under construction, will serve as an important example of the bentonite trenching technique and be helpful in sponsoring the use of this technique with the goal of seriously considering in the design stages of future projects these retaining walls as permanent walls rather than temporary.

Briefly, the Charles Center Station is the central terminal of Section A of Phase I of the Baltimore Rapid Transit System, where the north, south and east corridors will meet. Figure #1.

The Baltimore Rapid Transit System was planned in 1967-68 as a six corridor 71-mile system. Phase I was established in 1970 as a 28-mile, two corridor system. Section A of Phase I is a 7.5 mile stretch that will be completed in 1982, and at that time will carry an estimated 83,000 passengers daily.

The overall program cost for Section A is estimated to be \$721 million. The cost for construction and owner-furnished equipment is estimated to be \$600 million, including contingency and escalation to time of construction.

The division of line structures for Section A of Phase I is as follows:

|               |            |
|---------------|------------|
| Aerial        | 2.35 Miles |
| Surface       | 0.95 Miles |
| Cut-And-Cover | 1.25 Miles |
| Tunnel        | 2.95 Miles |

CHARLES CENTER STATION SLURRY WALL INSTALLATION

Section A includes nine stations: six are underground and three are aerial stations.

Three of the underground stations: the North Avenue Station, the Laurens Street Station and the Charles Center Station, have used the bentonite slurry technique for their retention systems. While for the first two stations, the slurry walls were only a relatively small part of the entire retention system, (the slurry walls were used to protect critical building locations) at the Charles Center Station the full length of the station is protected by slurry walls. Figure #2.

The Charles Center Station structure is very close to major office buildings, including one 26-story structure. Extensive underpinning was designed as well as the use of slurry wall construction methods.

The soil conditions at the Charles Center Station are typical of the downtown Baltimore area. Granular deposits of dense to very dense sand of the Patuxent formation which frequently includes levels of silt and clay. This formation is primarily composed of light colored sands which frequently merge into gravels with pebbles of considerable size. The bottom of the excavation for the station is in decomposed rock.

The retention system for the Charles Center Station is one of the most difficult among the stations actually under construction for the Baltimore System. In addition to being located in the central business district, with several important structures to be protected, serious problems were caused by the existing soil conditions.

Originally, the contract called for underpinning the major structures, followed by the installation of the slurry walls in two of the three blocks that cover the Charles Center Station. The slurry walls were designed as 2'-thick walls with beams placed in the open panels on 6' centers after the excavation of the panel was completed under bentonite. The soil conditions were found to be considerably more difficult than expected for jacking piles under the structures because of very hard soils with pebbles and boulders which slowed down the installation of the underpinning.

To improve the progress of construction, the slurry walls were therefore re-designed to function by themselves as the retention system for the station's excavation and for protection of the adjacent building foundations. Figure #3.

Since the slurry walls became the only protection installed, soldier piles were placed before the slurry walls were dug, augered under bentonite, to prevent any relaxation of the soil under the adjacent buildings.

Once the primary soldier piles were installed on 8' centers and 6' centers, depending on locations and extent of the footing width exposed to the panel, the slurry wall panels were dug in between and another soldier beam placed between the previously pre-augered beams.

The primary soldier piles are carried out 5' deeper than the secondary piles and the slurry walls, 10' below the bottom of the structure.

Sizes of soldier beams vary from 104 pounds to 131 pounds per lineal foot. The final wall to be installed consists of an unreinforced wall 2'-thick with an average depth of 72', to a maximum depth of 105', with wide flange beams at 3' or 4' on center depending upon the loads of the adjacent structures and panel configuration. Figure #4.

In total, 150 holes had to be pre-augered through the alluvial material, drilling under bentonite in front of the most important structures. 187 panels of 2'-thick wall will cover the three blocks along Baltimore Street and protect the full extent of the station's excavation for approximately 1400 LF of walls, for a total surface of approximately 110,000 square feet.

From a practical and economical standpoint, three factors experienced in this project are important to mention for the role they might have in the initial design and construction analysis of any future similar project and in the decision of the type of retention system to chose.

Firstly, this is the first time in North America that structures of such importance have not been underpinned while deep excavation adjacent to them is performed for the construction of the subway station.

This construction technique, if found successful after the project will be completed, will certainly help the concept of using the rigid slurry walls not only as temporary protection of excavation but also in lieu of underpinning and hopefully, as permanent structural walls.

Secondly, the presence of or lack of room to work effectively and economically. Figure 5 shows Block 2 of the Charles Center Station with two excavating machines and necessary supporting equipment for the installation of the slurry walls. There is very little room to effectively work, a lot of planning is needed before a shift starts in order to program every step of each piece of equipment. For instance, there is no room for the machines to cross each other and if this becomes necessary, it would mean completely stopping all production activities. Figure #6.

Thirdly, the installation of the slurry walls for this station is being done at night. At 7:00 p.m., the street is closed to the traffic, temporary sidewalks and barricades are removed, guide walls exposed, equipment brought into the street and finally, excavation can begin.

By 6:00 a.m. the following morning, the site must be completely restored, equipment removed, street cleaned and swept, and pedestrian and automobile traffic reinstated. Figure #7.

To have eight hours of operations, the shift must last at least eleven hours and very frequently the effective time of work is less than eight hours.

We believe that the decision of not allowing the street to be closed during the day and therefore working only at night, might be carefully considered by the authorities in charge.

While it is understandable that local merchants do not wish to see entire sections of city streets blocked off during business hours, it is however important to consider the economic penalty that this situation puts on the construction project. European and South American experiences, where city streets are almost always closed during the day to allow construction work, provides positive know-how that could be used to find more economical solutions to similar problems.

#### CHARLES CENTER STATION SLURRY WALL DESIGN CONSIDERATIONS

The construction of underground subway systems in the urban area demands a close look at the various alternatives of the support of excavation systems while the excavation is taking place and during the period when the permanent structure is erected.

The factors which influence the selection of a method of support of excavation systems vary with each method. The discussion here will be limited to the "Slurry Wall" type construction method as it applies to the Charles Center Station.

In the early planning stage, the factors considered for slurry wall included:

- . The type of subsoil
- . The groundwater
- . The availability of the type of trenching equipment
- . Environmental controls, e.g., method of disposing the slurry
- . Site limitations, e.g. available working space
- . Settlement consideration with respect to adjoining structures
- . Utilities in the area
- . Cost

Having analyzed all other factors, we must recognize that cost plays an important role in the final determination of the system. The main advantages of slurry wall construction as considered by us included the following:



- . It could be used as temporary support and permanent support
- . The ground movements within immediate vicinity would be small during the slurry wall excavation and during the excavation inside the slurry walls
- . The groundwater seepage into the excavation can be controlled or cut off
- . It will minimize underpinning, or eliminate the need to underpin the adjoining structures where walls are designed to carry lateral loads.
- . It will be relatively quiet and vibration-free method of construction.

While it was recognized that a properly designed slurry wall and strutting procedure will provide technically a means of protecting adjacent footings, those slurry walls which virtually touch the footings or which require that the footings be cut during the process of constructing slurry walls need careful evaluation.

#### CHARLES CENTER STATION DESIGN

All of the above factors lead to the following conclusions:

- . Design the slurry wall as a temporary wall.
- . Design the slurry wall to be capable of resisting lateral loads from the adjacent structures.
- . The soil underneath the footings, which are required to be cut, be stabilized by use of chemical grout.
- . Develop detailed specifications pertaining to:
  - Length of the panel
  - Width of the panel
  - Internal bracing system spacing
  - Requirement of minimum depth below excavation subgrade for both the soldier piles and slurry wall panel.
- . The slurry wall contractor be required to submit detailed calculations for trench stability analysis.
- . The slurry wall contractor submit a detailed quality control program prior to beginning any panel excavation.

- . At no time will the contractor be allowed to leave more than one half width of footing exposed during excavating for slurry wall panel.
- . Specify the limitation on sequence of panel excavation and concreting operation.
- . Closely monitor the structure movements.

All of the above conclusions were implemented including successful grouting of the footings underneath the major buildings.

Figure 8 shows the detailed slurry wall layout for the Charles Center station. Figures 9 and 10 show the amount of the area of footing which is required to be cut to install the slurry wall in the case of one major building. Figure 11 shows the estimated footing settlement which could result from such a cut.

#### TEMPORARY vs. PERMANENT SLURRY WALL CONSTRUCTION

One obvious question that requires an answer is why these walls were not considered as a part of the permanent wall system. Since there is no single answer, I will give you the evaluation of the facts. The construction of slurry walls in the Charles Center Station area, being in the heart of downtown central business district, required us to consider two types of problems: technical nature and socio-political nature.

#### TECHNICAL NATURE:

- Proximity of significant major structures 3 to 26 stories high
- Need for cutting footings to the tune of 25% of the existing footings for major, high rise buildings.
- Concern for stability of trenches against possibility of local caving of cohesive materials at the shallow depths beneath the footing level
- Potential damage resulting from excessive settlement of footings due to improper slurry wall construction
- Paucity of information related to design of strengthened slurry walls subjected to large bending moments, without use of tiebacks or anchors
- Complex nature of network of internal floor system (based on station design requirement) which sometimes did not span the full width of excavation.

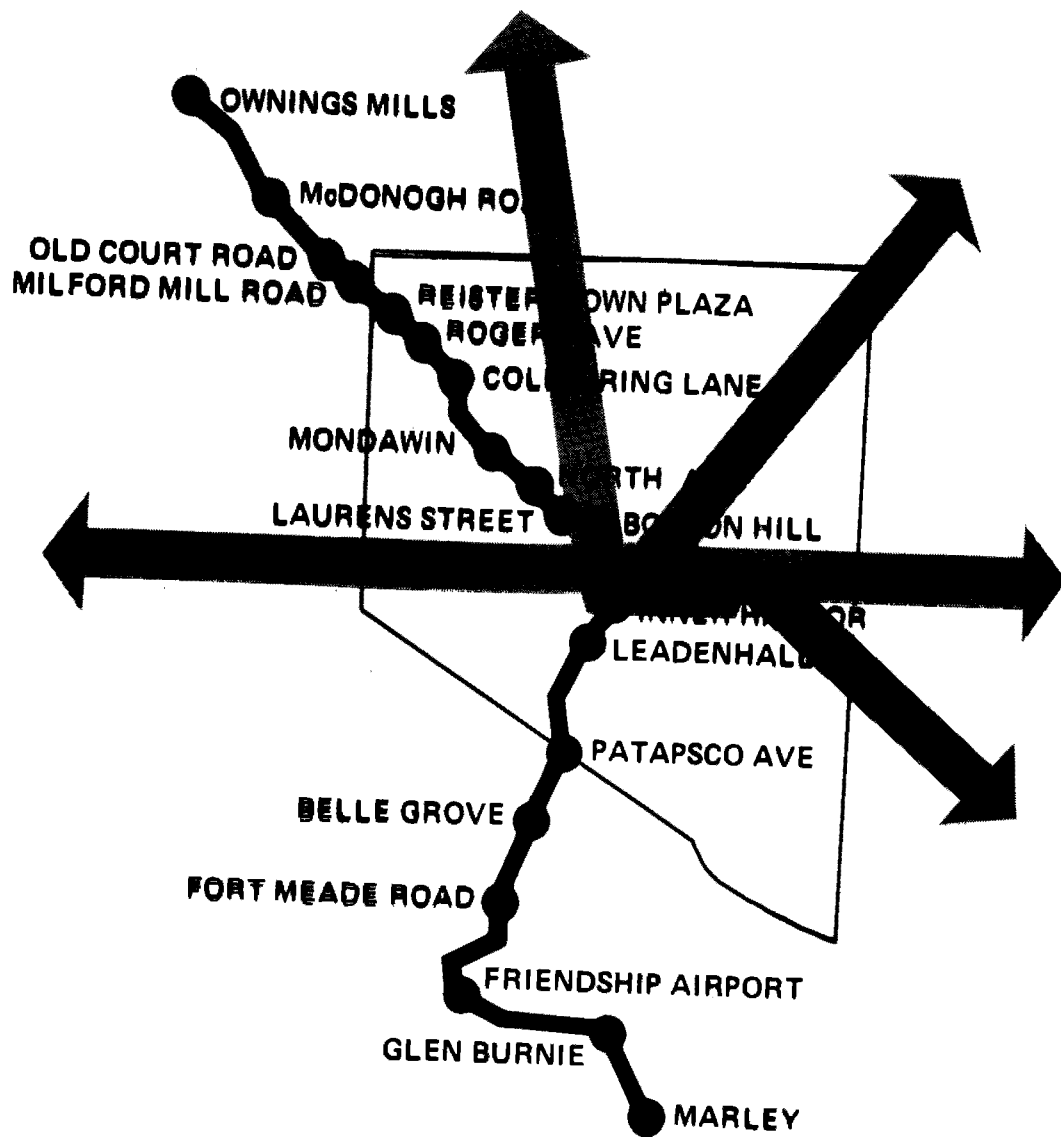
SOCIO-POLITICAL NATURE:

- Inability of the designer to be directly involved in the supervision of the construction
- Inability of the owner to pre-qualify the contractor
- Inability of the owner to pre-judge the experience of the contractor because of lack of history in similar types of construction
- In the event of failure, impact on the economic climate and major businesses in the heart of downtown Baltimore.

After reviewing the state of the art of the slurry wall construction industry and all the problems, it was considered prudent to design the slurry walls as temporary support system.

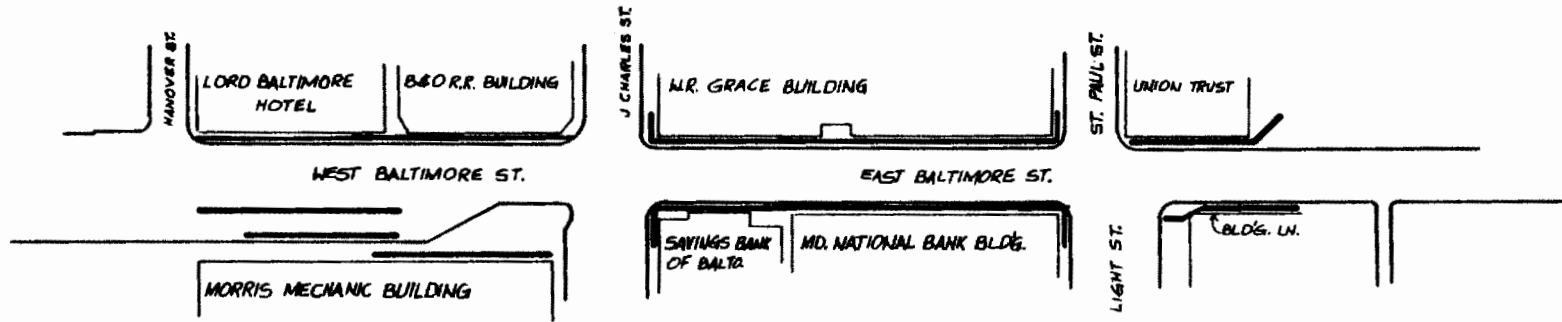
By adopting this design concept, we believe that we did advance the state of the art of slurry wall construction a notch and provided our client:

- . The benefit of reduced cost
- . A safe and economical excavation support system
- . A solution which minimized the impact of transit construction on adjoining structures.



**Baltimore Region Rapid Transit System  
Phase 1, Section A: Charles Center To Owingings Mills**

FIGURE 1



**KEY PLAN**

**CHARLES CENTER STATION**

**— SLURRY WALLS (typ.)**

|   |  |   |
|---|--|---|
| <p>STATE OF MARYLAND DEPARTMENT OF TRANSPORTATION<br/>MASS TRANSIT ADMINISTRATION</p> | <p>DANIEL, MANN, JOHNSON &amp; MENDENHALL / KAISER ENGINEERS<br/>GENERAL CONSULTANTS</p> | <p><b>BENCOR Corporation</b><br/>of America</p> |
| <p>BALTIMORE REGION RAPID TRANSIT SYSTEM<br/>PHASE 1</p>                              | <p>SVERDRUP AND PARCEL<br/>CONSULTING ENGINEERS</p>                                      | <p>Foundation Specialist</p>                    |

**FIGURE 2 KEY PLAN**

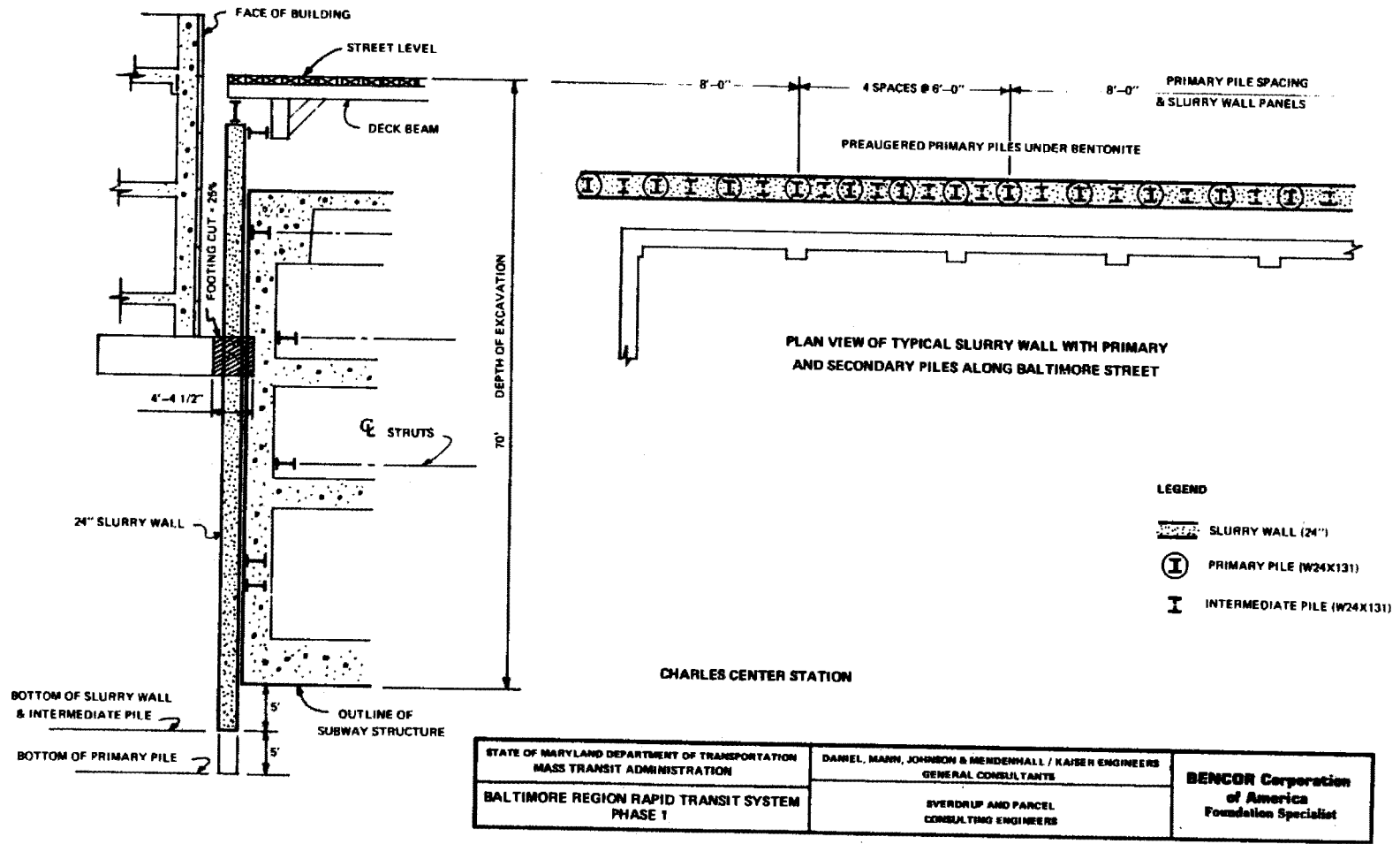


FIGURE 3 PLAN VIEW OF TYPICAL SLURRY WALL WITH PRIMARY AND SECONDARY PILES ALONG BALTIMORE STREET

SECTION THRU BLOCK 2

Baltimore Region Rapid Transit System  
Charles Center Station

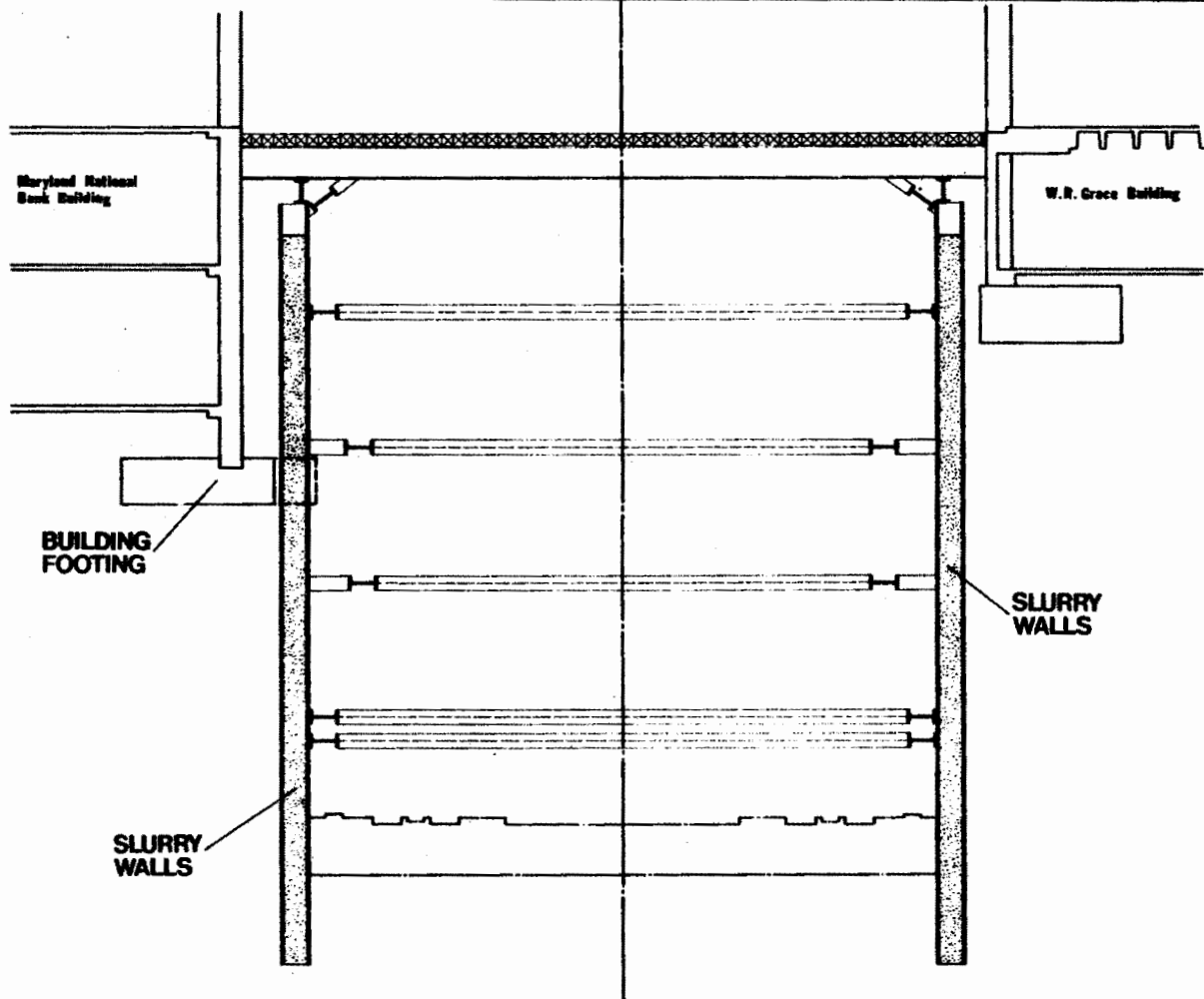
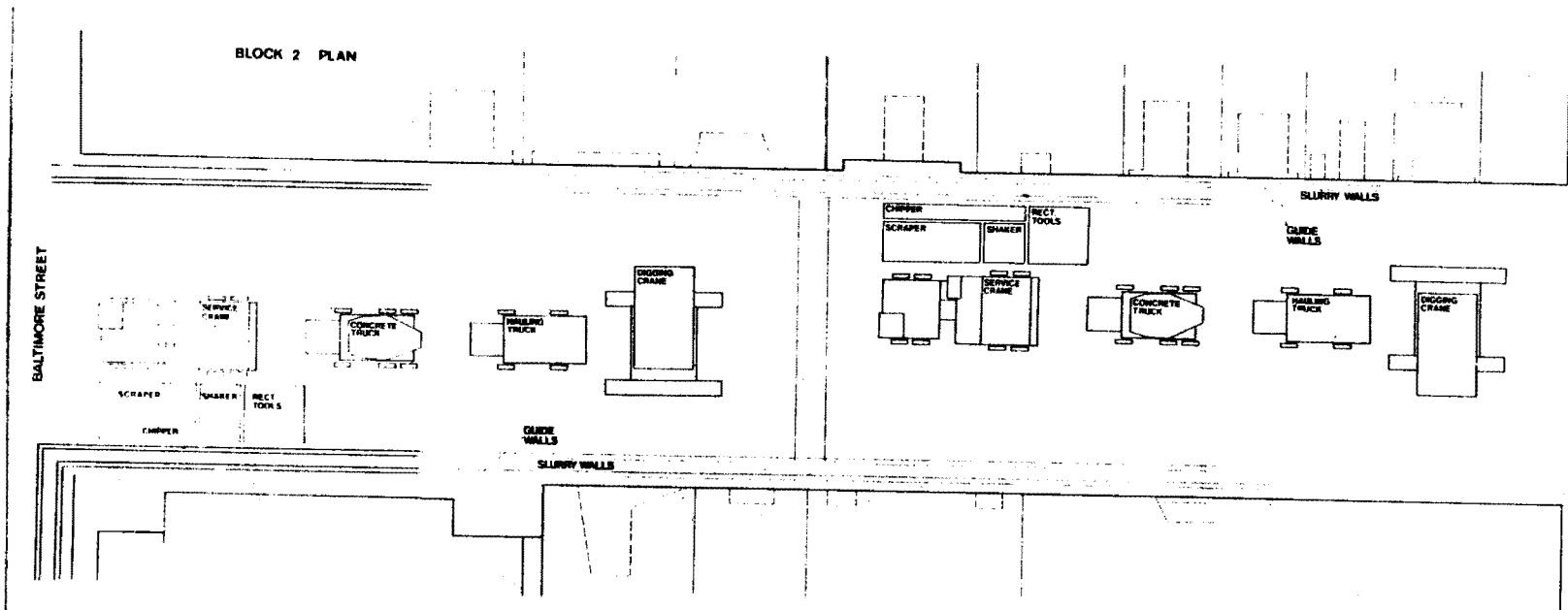


FIGURE 4 SECTION THRU BLOCK 2



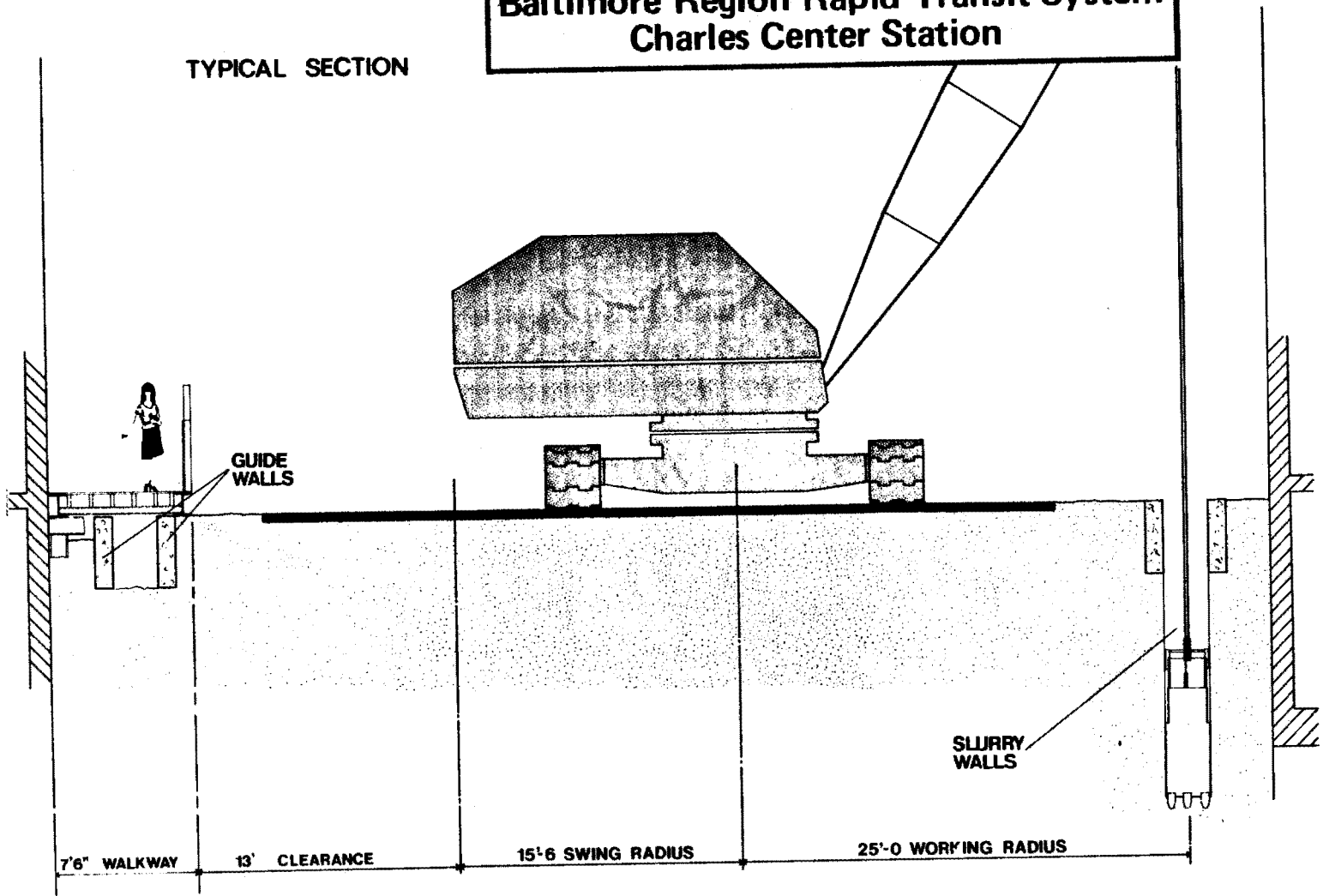
**Baltimore Region Rapid Transit System  
Charles Center Station**

FIGURE 5 BLOCK 2 PLAN



**Baltimore Region Rapid Transit System  
Charles Center Station**

TYPICAL SECTION



173

FIGURE 6 TYPICAL SECTION

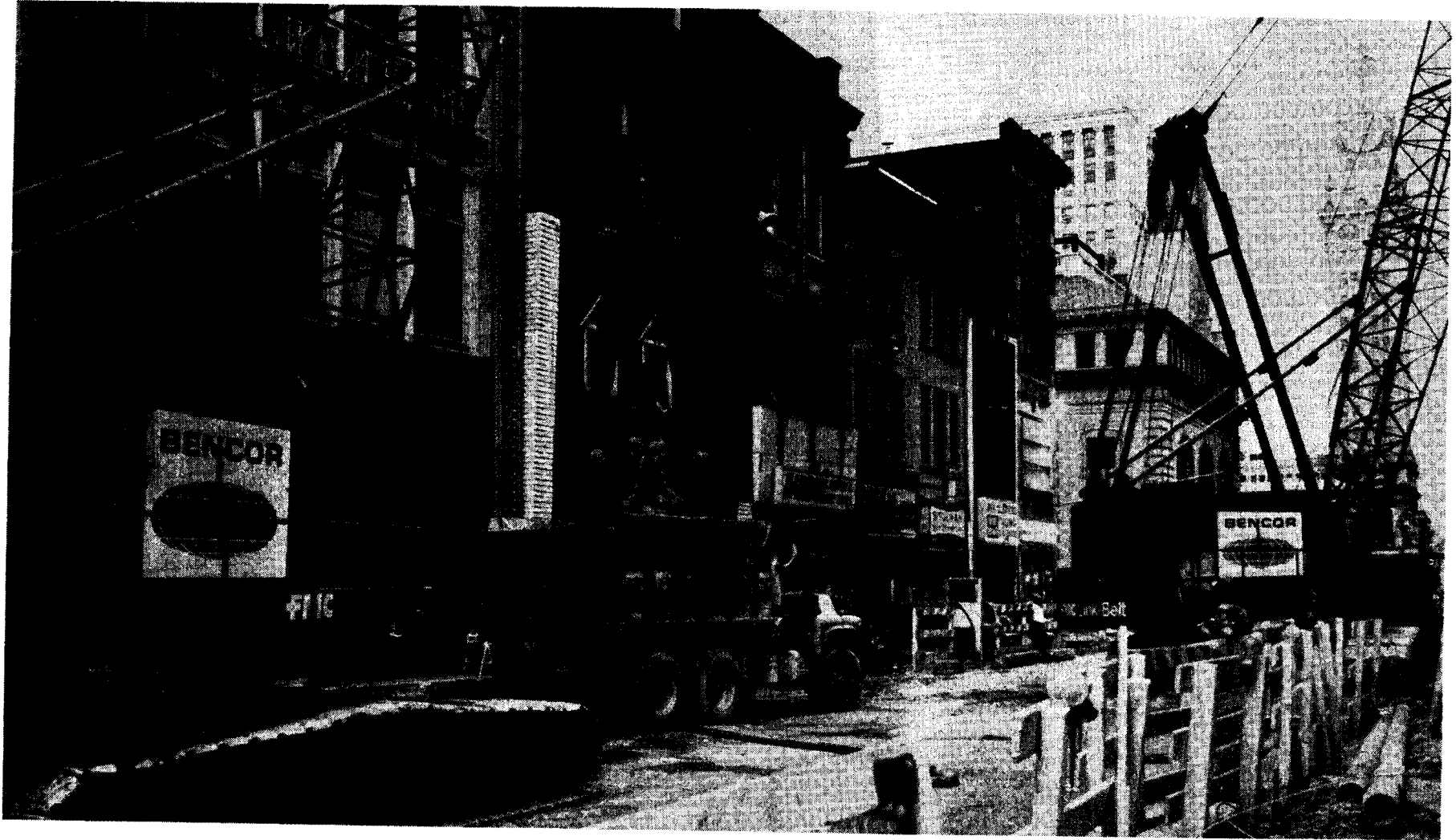


FIGURE 7

**Baltimore Region Rapid Transit System**  
Charles Center Station / Slurry walls and piles

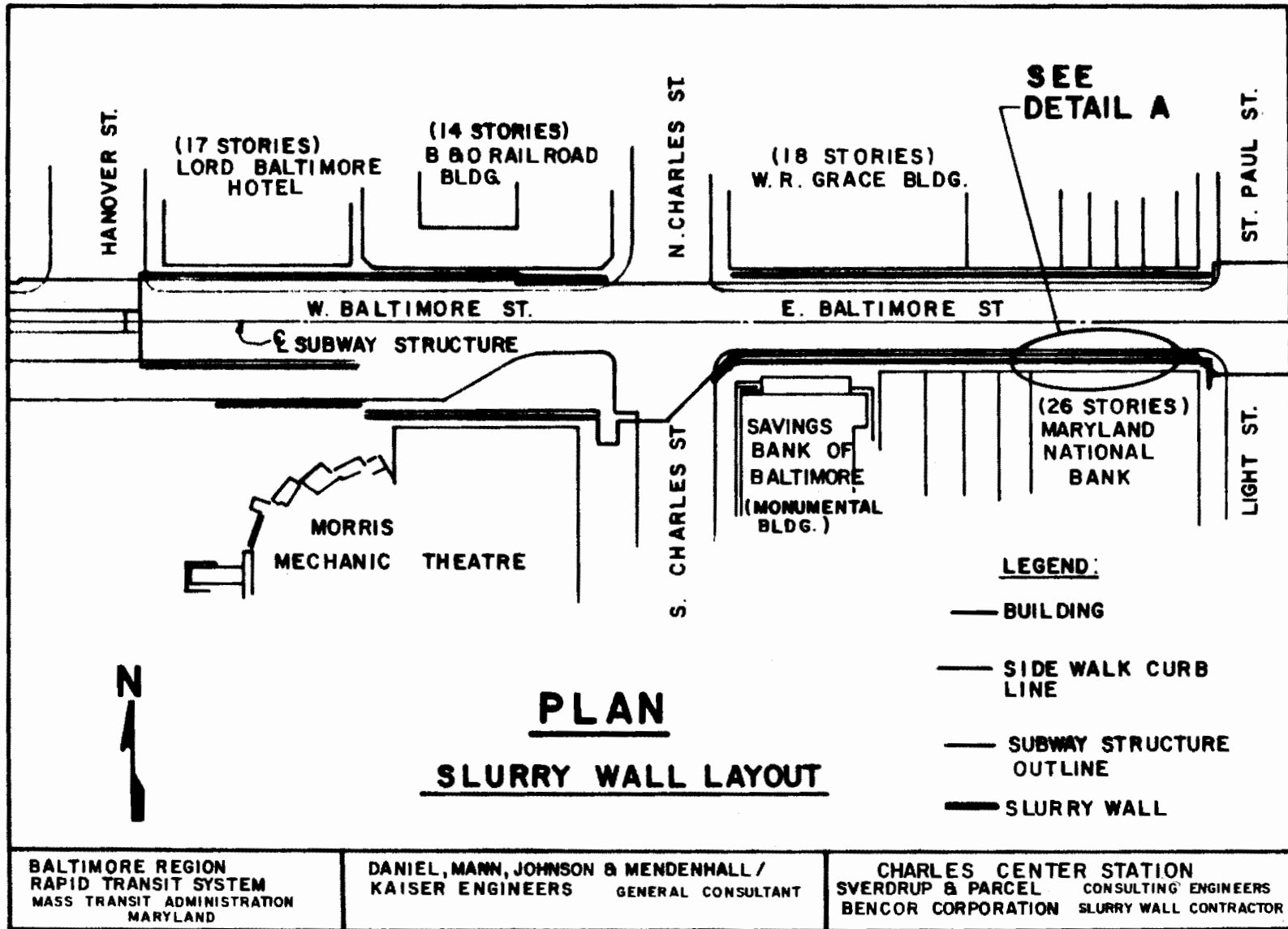


FIGURE 8 PLAN, SLURRY WALL LAYOUT



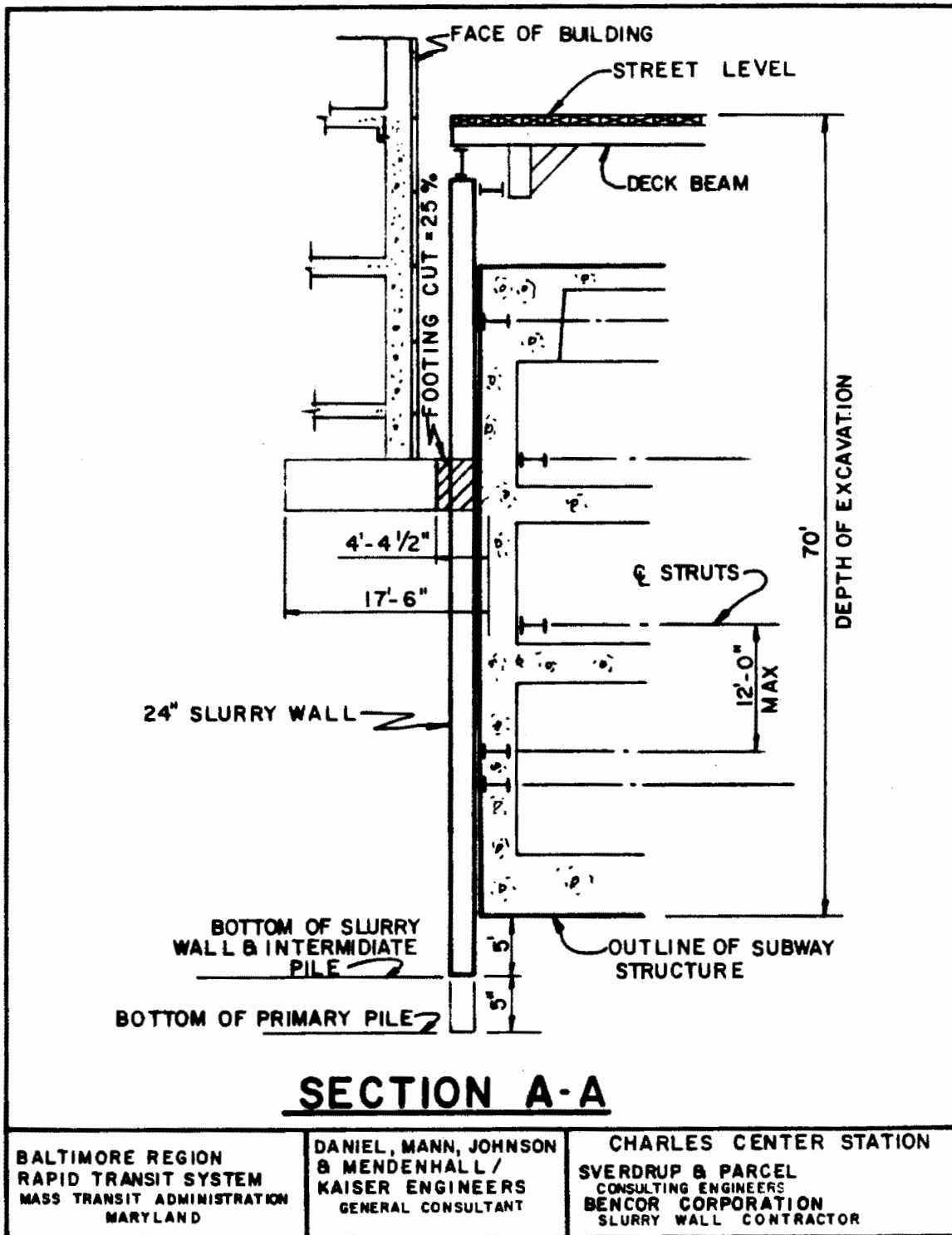


FIGURE 10 SECTION A-A

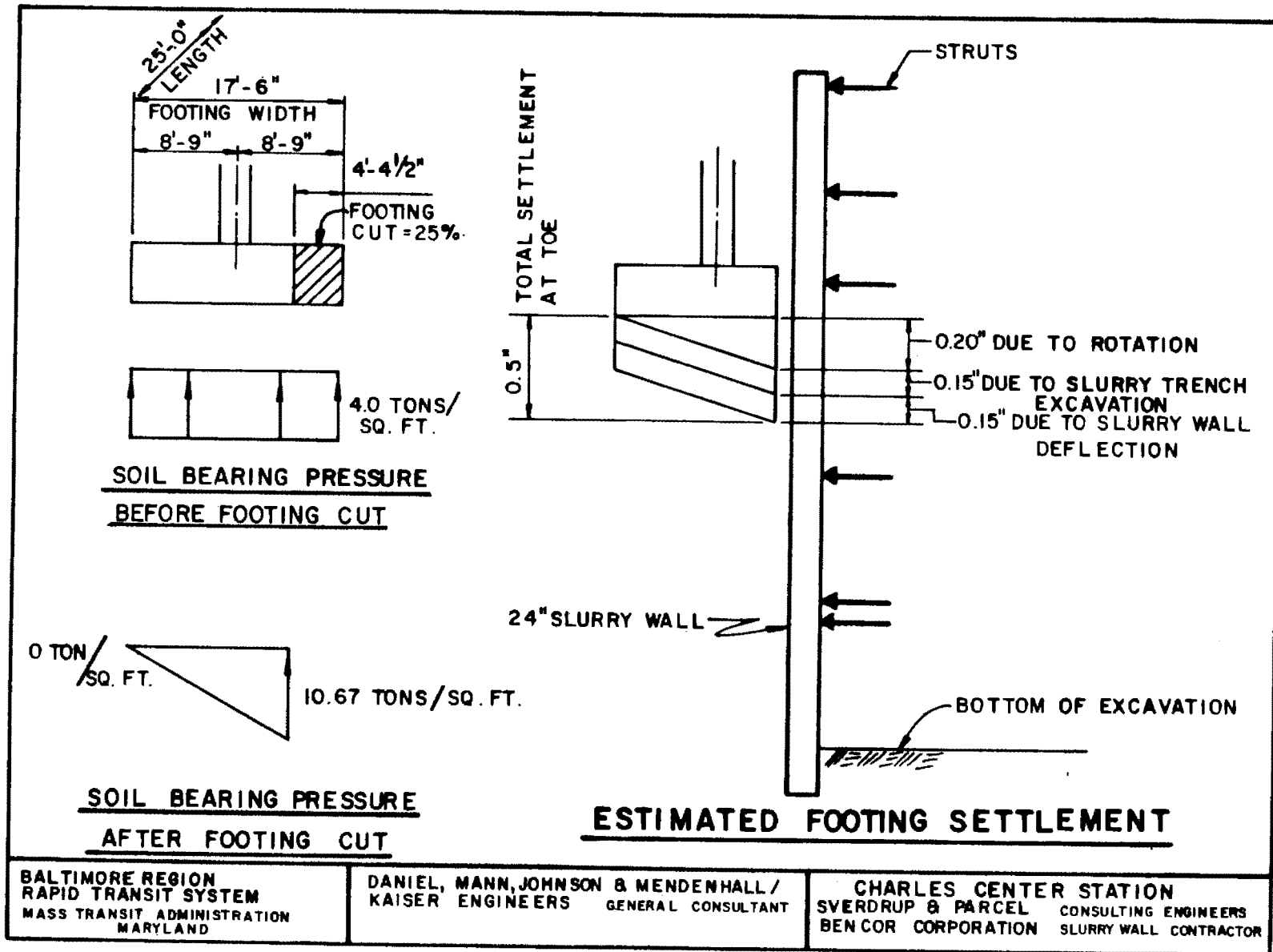


FIGURE 11 ESTIMATED FOOTING SETTLEMENT

SPEAKERS: Ugo Piccagli  
Bencor Corporation of America  
and  
Drupad B. Desai  
Daniel, Mann, Johnson & Mendenhall

Unidentified Questioner

Question:

Sir, I just wondered if you gave consideration to compaction grouting under those footings. I am sure you did. Did you, and what was the outcome of that?

Mr. Desai

Answer:

Yes, we did consider using compaction grouting under these foundations. As a matter of fact, we did consider compaction grouting vs. displacement grouting and concluded that displacement grouting would be better than compaction grouting for reasons of the excess limitations for consideration in terms of the type of material we were encountering, and we felt that we might be able to do better with chemical grouting.

RESEARCH DESIGN STUDY ON THE USE OF SLURRY WALLS AS PERMANENT  
STRUCTURES IN TRANSPORTATION FACILITIES

by

M. BASCI & B. DENNIS

CHI ASSOCIATES, INC.  
WASHINGTON, D. C.

ABSTRACT

Under its present contract with the Federal Highway Administration, Chi Associates, Inc., is responsible for investigating innovative ideas for the use of Slurry Walls as permanent structures. For such a design study the site conditions existing in Washington, D.C. on the Washington Metropolitan Area Transit Authority's (WMATA) Federal Center S.W. Subway Station were considered. The station which was completed in 1974 employed slurry walls for temporary earth support thus eliminating extensive underpinning of adjacent structures at a cost savings of \$2,000,000. This site therefore provided an excellent study example for the development of alternative designs that would make more extensive use of Slurry Wall attributes.

This paper will provide a brief summary of the efforts made by Chi Associates during this design study. CAI designers had to address the problem commonly associated with slurry wall construction; that of providing appropriate joint to handle the large moments that develop at the intersection of the roof and floor slabs with the Slurry Walls. To accommodate this problem, various station geometries such as plain box sections, arched roof sections, three folded plate roof sections, along with T-shaped slurry wall panels and counterfort section supports were investigated.

For each design alternative, calculations were done using both the "Working Stress Method" and the "Ultimate Strength Method".



## RESEARCH DESIGN STUDY ON THE USE OF SLURRY WALLS AS PERMANENT STRUCTURES IN TRANSPORTATION FACILITIES

### INTRODUCTION

The organization and presentation of this symposium is but one of the eight tasks in the contract between the Federal Highway Administration and Chi Associates, Inc. (CAI). The primary objective of the contract is to determine the advantages of using slurry walls as a permanent part of underground transportation structures.

CAI is responsible for investigating the state-of-the-art of slurry wall design and construction in the United States. From such an effort details as to physical, environmental and economical profiles for the efficient use of the technique will provide the basis for a design study. This design study will address the principal factors influencing joint details, bracing and tiebacks, and the behavior of slurry walls as part of underground structures.

Now ten months into the contract, CAI is heavily into the design portion of the contract. New design concepts and solutions to commonly encountered design difficulties are being investigated under the review of a Board of Consultants consisting of

Jerome S.B. Iffland  
Principal  
Iffland Kavanagh Waterbury, P.C.

Dominique Namy  
President  
Soletanche and Rodio, Inc.

George Tamaro  
Vice President & Chief Engineer  
ICOS Corporation of America

Petros P. Xanthakos  
President  
Petros P. Xanthakos, Ltd.

For this symposium, CAI would like, therefore, to present a brief view of the results of our efforts to date and indicate what work faces us in the coming months.

### CAI INVESTIGATIONS AND SITE VISITS

At the outset of the project, a literature survey and discussions with the Board of Consultants identified major sites in the U.S. where slurry walls had been used for transportation facilities. Unfortunately,

it was discovered that at only one site, the BART Subway System in San Francisco, California, had slurry walls been incorporated into the final structure. In Boston, extensive use of permanent slurry walls was in the design phase. Other major sites, New York, Washington, D.C., Baltimore, and Atlanta, however, had relegated slurry walls to temporary earth support structures.

In order to gain an understanding of the design problems associated with incorporating slurry walls into the final structure, CAI personnel visited design offices and construction sites in Washington, D.C., Boston, Baltimore, and New York. Even a site in Caracas, Venezuela where a new subway system employing slurry walls as permanent structures was visited.

At each of these sites CAI personnel gathered design documents and discussed problems encountered in the slurry wall analysis. This information was studied in detail by CAI engineers to provide the background and basis for formulating new design concepts and solutions to the problems.

#### DESIGN PROBLEMS ADDRESSED BY CAI

From the information gathered from the site visits it became apparent that two of the common difficulties encountered when designing slurry walls as permanent structures were:

- tolerance
- moments at wall/slab intersections

Today we would like to briefly present our approach and findings in these areas.

#### PROBLEM SOLUTIONS

##### A. TOLERANCE

One obvious problem is construction tolerance. It is difficult enough to build the slurry wall itself. The operation entails the construction of a deep, below-grade structure through a slurry mud mixture from the ground surface level without the benefit of visual inspections and control. Under these conditions, it would be considered reasonably good workmanship to control the dimensions to within a few inches of the intended ones. However, if a slurry wall is to become part of a permanent station structure, provisions must be made to connect the roof and floor slabs to it by means of joints. It is clearly difficult to assure the precise locations of joints in the slurry wall during the wall's construction.

The tolerance specification for a slurry wall is an important consideration which plays a key role in the economics of the final product.

Unreasonably close tolerance requirements for keys and blockouts would inevitably be reflected in higher bid prices.

Designers therefore must be familiar with this problem and the slurry wall construction procedure. In general it should not be considered unreasonable for reinforcing steel at wall/slab blockouts to be within  $\pm 3$  inches (7.6 cm) vertically and  $\pm 3$  inches (7.6 cm) horizontally and designs should take this into consideration. Tolerances stricter than these can be achieved but not in a cost effective manner.

#### B. MOMENTS AT THE WALL/SLAB INTERSECTION

All of the design packages reviewed by CAI engineers showed simple box frame analysis of slurry walls. Slurry walls were rejected after analysis usually because of two factors:

1. The large moments that resulted at the wall/slab joints
2. The possibility of sidesway of the frame under asymmetric loading conditions

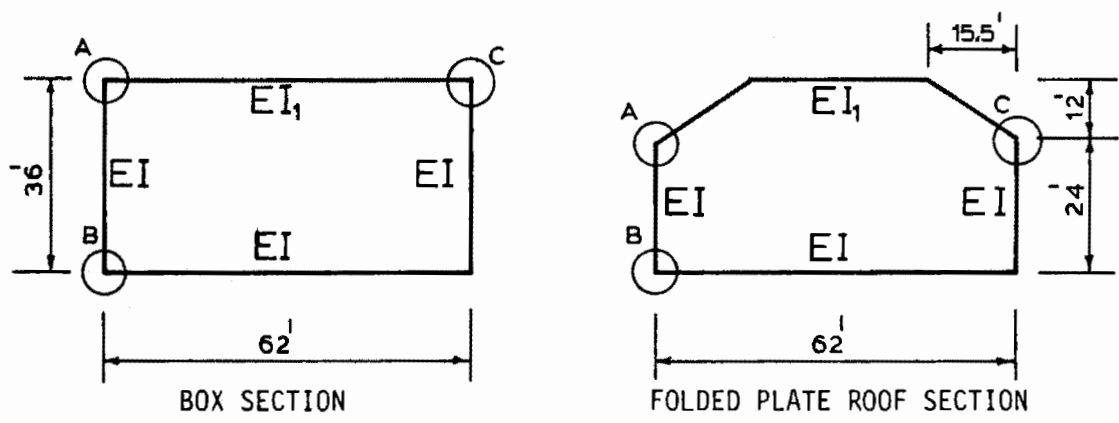
Both of these facts required slurry wall thickness of unreasonable dimensions or impossible joint fabrication requirements.

CAI engineers proposed changing the cross section geometry of the structure in order to reduce the large moments at these joints. An arched roof and a folded plate roof were compared to the box section and each other in order to determine geometric effect on moment reduction. Wall and slab thicknesses were varied. In addition counterforts were suggested and investigated as a means of restricting sidesway.

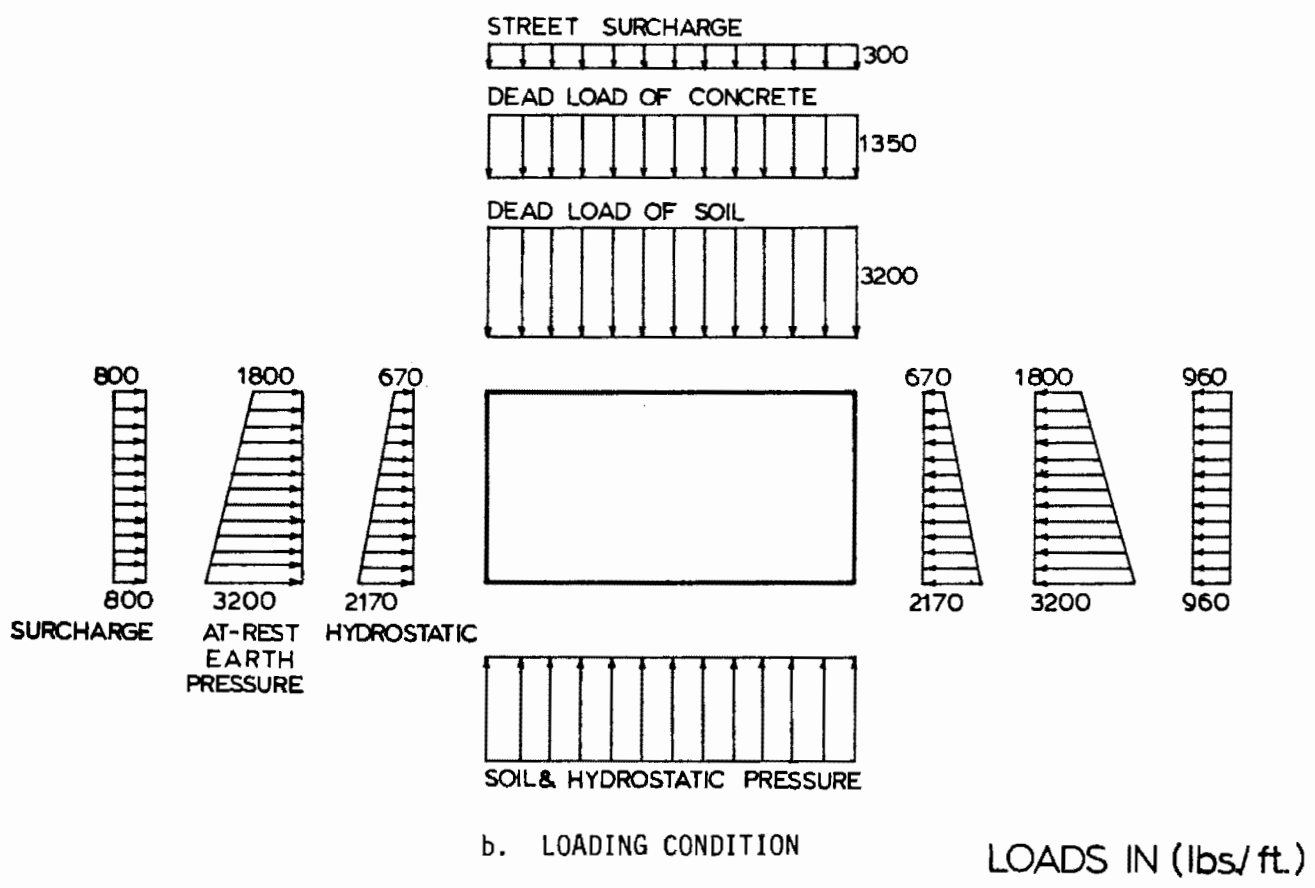
A series of parametric studies has just been completed by CAI engineers. In the short time available at this symposium it would not be possible to present a detailed discussion of our design efforts, however, we felt it would be appropriate to show the results of four of our parametric studies.

A. PARAMETRIC STUDY NO. 1: VARYING ROOF GEOMETRY AND THICKNESS

- PURPOSE: To study the effect of geometry and thickness on moments at the wall-roof intersection (wall and base slab thickness kept constant at 4 feet (1.22 m)).
- CASES STUDIED: Figure 5-1 shows the cross sections studied and the arbitrary loading conditions.
- RESULTS: Summarized in Table 5-1.
- CONCLUSIONS: For the loading conditions shown, the folded plate roof geometry offered considerable moment reduction at the critical wall-roof slab interface. Additional increase of the roof slab thickness helped to reduce moments still further.



a. CROSS SECTIONS STUDIED



b. LOADING CONDITION

LOADS IN (lbs/ ft.)

FIGURE 5-1 CROSS SECTIONS AND LOADING CONDITIONS FOR PARAMETRIC STUDY NO. 1

Results:

|  |  | Simple Box Section    |                       | Folded $\pi$ Roof Section |                       |
|--|--|-----------------------|-----------------------|---------------------------|-----------------------|
|  |  | Moment at A<br>ft-kip | Moment at B<br>ft-kip | Moment at A<br>ft-kip     | Moment at B<br>ft-kip |
| Symmetric Loading<br>Full (at rest) earth<br>pressure on both<br>sides of structure  | 6' Thick Roof<br>$I=5.333\text{ft}^4$<br>$I_1=18\text{ft}^4$     | -847                  | -654                  | -499                      | -612                  |
|  | 7' Thick Roof<br>$I=5.333\text{ft}^4$<br>$I_1=28.583\text{ft}^4$ | -721                  | -671                  | -424                      | -629                  |
|  | 8' Thick Roof<br>$I=5.333\text{ft}^4$<br>$I_1=42.667\text{ft}^4$ | -626                  | -685                  | -351                      | -643                  |
| Asymmetric Loading*<br>Full (at rest) earth<br>pressure one side - $\frac{1}{2}$<br>(at rest) earth<br>pressure other side |  | Moment at B           | Moment at C<br>ft-kip | Moment at B               | Moment at C<br>ft-kip |
|  | 6' Thick Roof<br>$I=5.333\text{ft}^4$<br>$I_1=18\text{ft}^4$     | -835                  | -921                  | -750                      | -667                  |

Note: Only maximum moments at wall-slab intersections shown

\*For this analysis  $\frac{1}{2}$ (at rest) earth pressure was applied to the right side of the structure replacing the full(at rest) earth pressure shown above on both structures for the asymmetrical loading condition.

TABLE 5-1 RESULTS OF PARAMETRIC STUDY NO. 1 : VARYING ROOF GEOMETRY AND THICKNESS

B. PARAMETRIC STUDY NO. 2: ARCHED ROOF VS. FOLDED PLATE ROOF

PURPOSE: To study the effects of asymmetrical loading on two basic cross section geometries.

CASES STUDIED: For this study another arbitrary loading condition was imposed which included the soil-structure interaction (see the soil pressure beneath the structure). Figure 5-2 shows the cross sections studied and the loading condition imposed.

RESULTS:

|                   |      | Arched Roof Section |          | Folded Plate Roof Section |          |
|-------------------|------|---------------------|----------|---------------------------|----------|
|                   |      | A                   | B        | A                         | B        |
| Moment (ft kip)   |      | -1471.34            | -1652.22 | -1468.7                   | -1386.89 |
| Shear (kip)       | Wall | 114.59              | 108.67   | 126.8                     | 91.95    |
|                   | Slab | -277.06             | -172.52  | -256.08                   | -187.92  |
| Axial Force (kip) | Wall | -255.22             | -285.30  | -262.07                   | -279.07  |
|                   | Slab | —                   | -240.89  | —                         | -242.52  |

CONCLUSION: For the loading condition shown, the folded plate roof showed a slight reduction in shear as compared to the arched roof section. The results were favorable because consultants indicated possible difficulty or more effort required to construct the arched roof.

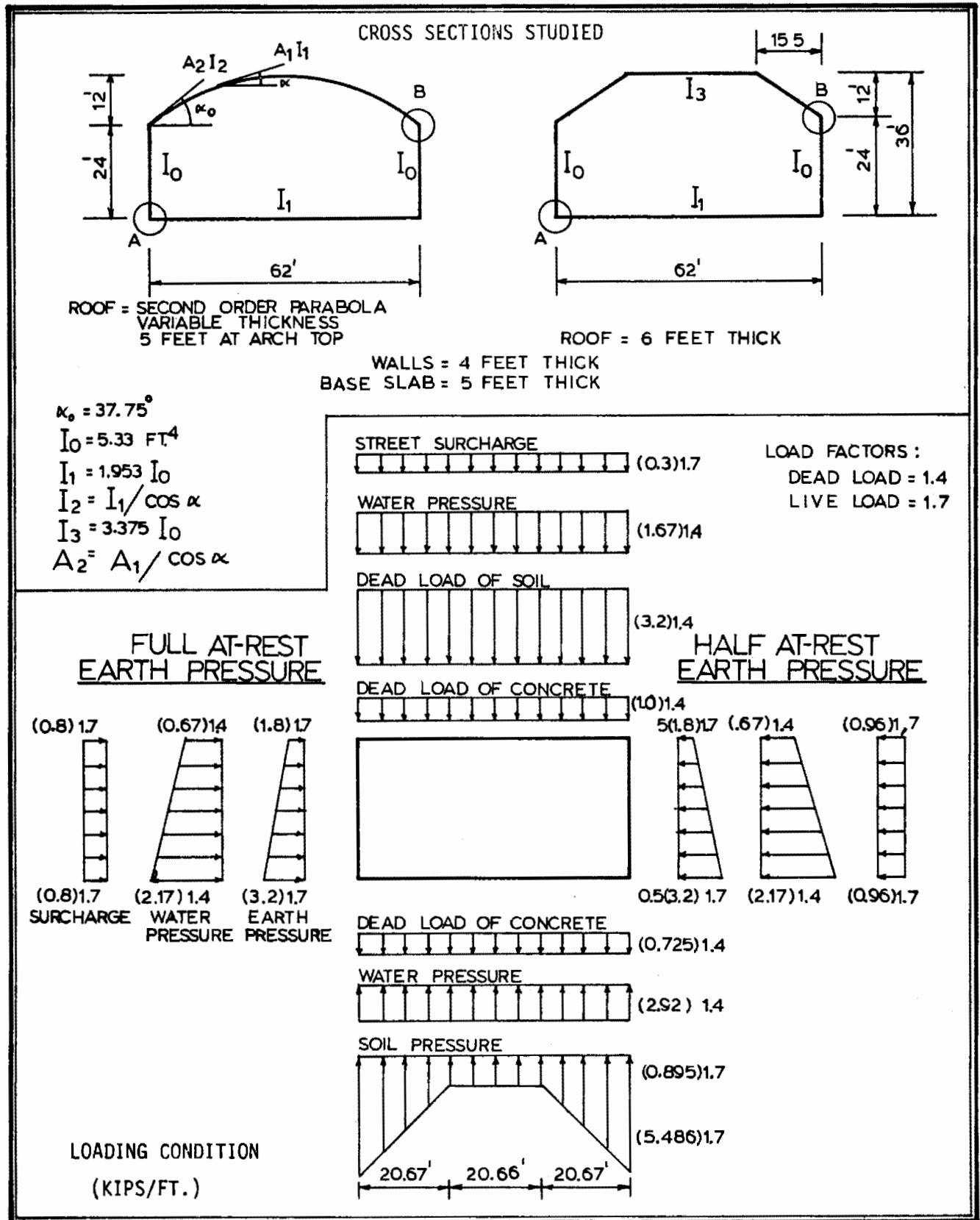


FIGURE 5-2 CASES STUDIED AND LOADING CONDITION FOR PARAMETRIC STUDY NO. 2



C. PARAMETRIC STUDY NO. 3: EFFECT OF AXIAL THRUST ON REBAR QUANTITY

PURPOSE: To study various design alternatives to reduce the area of steel required at the wall-base slab intersection.

DESIGN APPROACH: An axial thrust introduced into the base slab creates a combined compression and bending behavior. More favorable reinforcement distribution is developed as the axial compression neutralizes some of the tensile stress on the concrete section due to flexure.

CASES STUDIED: Figure 5-3 presents the loading conditions and the cases studied.

NOTE: The loading condition imposed for this study simulated a drop of water table to below excavation level with at-rest, saturated soil.

RESULTS: Summarized in Table 5-2.

CONCLUSIONS:

- Changing the geometry of the base slab did reduce moment at the wall-slab junction and increased axial force in the slab.
- Increasing wall thickness increased the moment at the wall-slab junction.
- Varying base slab thickness (section C) provided great reduction in area of steel reinforcing required at wall-slab junction.



Results:

a. Statistics on base slab under asymmetrical loading conditions.

|                     | CASE I   | CASE II  | CASE III | CASE IV  | CASE V   |
|---------------------|----------|----------|----------|----------|----------|
| Moment A (ft-kip)   | -1584.96 | -1207.41 | -1250.92 | -1120.22 | -1302.51 |
| Shear A (kip)       | -174.21  | -166.96  | -171.29  | -164.51  | -166.80  |
| Axial Force A (kip) | 32.25    | 141.67   | 132.05   | 143.03   | 133.21   |

b. Area of reinforcing steel required for continuation from slab to wall to properly handle moments.

|                                      | CASE I |      | CASE III |      | CASE IV |      |
|--------------------------------------|--------|------|----------|------|---------|------|
|                                      | A      | B    | A        | B    | A       | B    |
| Tension steel (in <sup>2</sup> )     | 10.04  | 2.53 | 4.68     | 2.53 | 3.18    | 2.53 |
| Compression steel (in <sup>2</sup> ) | 1.56   | 2.53 | 2.56     | 2.53 | 1.00    | 2.53 |

TABLE 5-2 RESULTS OF PARAMETRIC STUDY NO. 3 :  
EFFECT OF AXIAL THRUST ON REBAR QUANTITY

D. PARAMETRIC STUDY NO. 4: EFFECT OF COUNTERFORTS ON REDUCING SIDESWAY OF STRUCTURE

**PURPOSE:** To investigate the effectiveness of counterforts in reducing sidesway deflection on structure cross sections having hinged joints at wall-base slab intersection.

**CASES STUDIED:** Figure 5-4 shows the station cross sections studied. Figure 5-5 shows the loading conditions imposed. Figure 5-6 provides information on the counterforts used on the roof slab and the slurry walls.

**RESULTS:**

|        | Box Section      |                                 | Folded Plate Roof Section |                                 |
|--------|------------------|---------------------------------|---------------------------|---------------------------------|
|        | Moment* (ft kip) | Maximum Lateral Deflection (ft) | Moment* (ft kip)          | Maximum Lateral Deflection (ft) |
| CASE 1 | -26,656          | 0.066                           | -25,046                   | 0.06                            |
| CASE 2 | -28,116          | 0.047                           | -26,996                   | 0.04                            |
| CASE 3 | 0                | 0.066                           | 0                         | 0.049                           |

\*Maximum moment in base slab at wall-slab intersection point A, taken over 14 foot depth of section. This point is critical because continuation of steel reinforcing from wall to slab should be minimized as much as possible.

**CONCLUSION:** Under asymmetrical loading conditions, counterforts reduced the maximum deflection of the structural cross sections considered.

More important is the fact that, by employing counterforts in conjunction with hinge connections between the wall and base slab, the sidesway deflection due to asymmetric loading can be reduced to or below the amount of deflection in a structure having rigid joints and no counterforts.

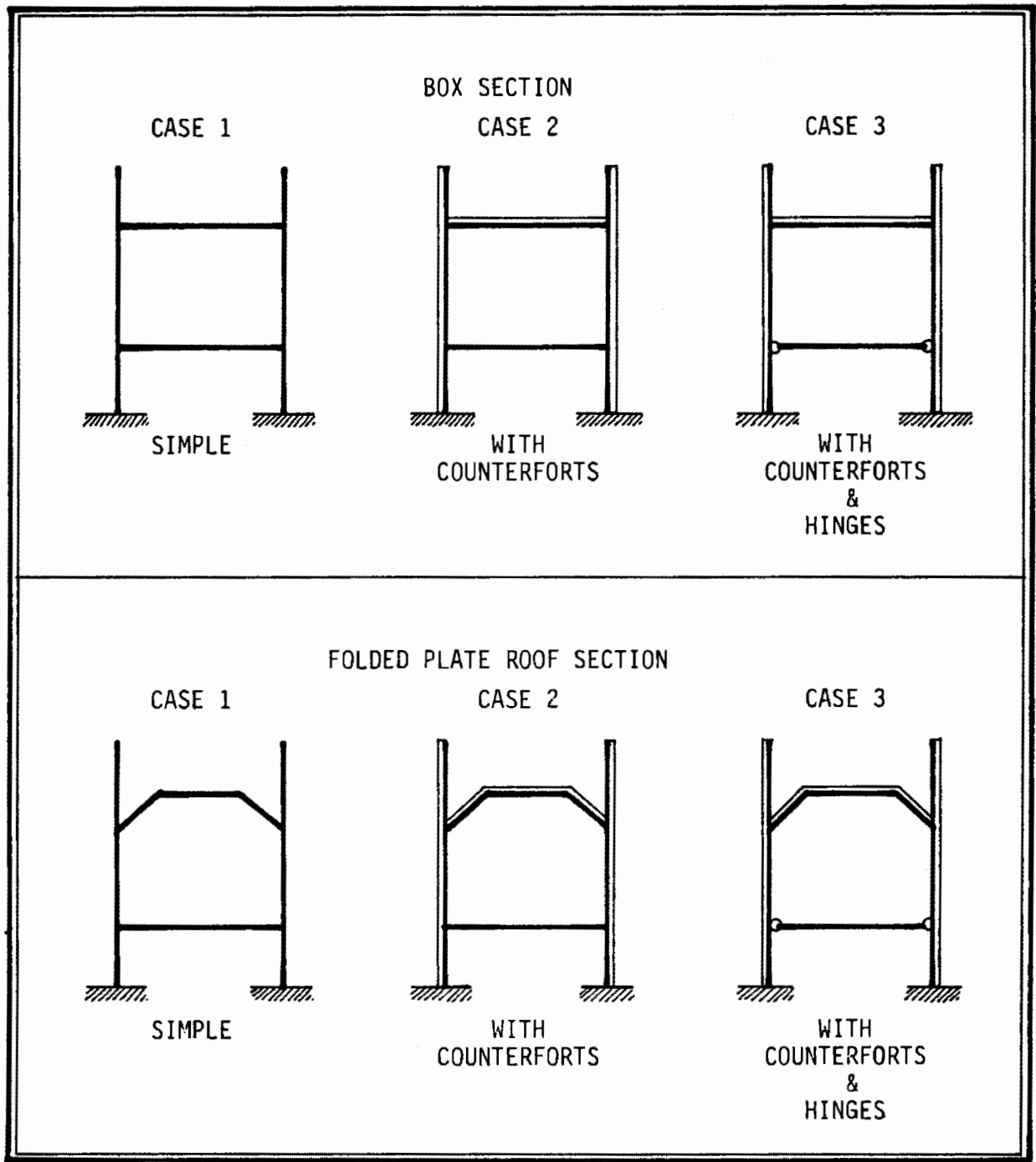


FIGURE 5-4 STATION CROSS SECTIONS STUDIED FOR PARAMETRIC STUDY NO. 4

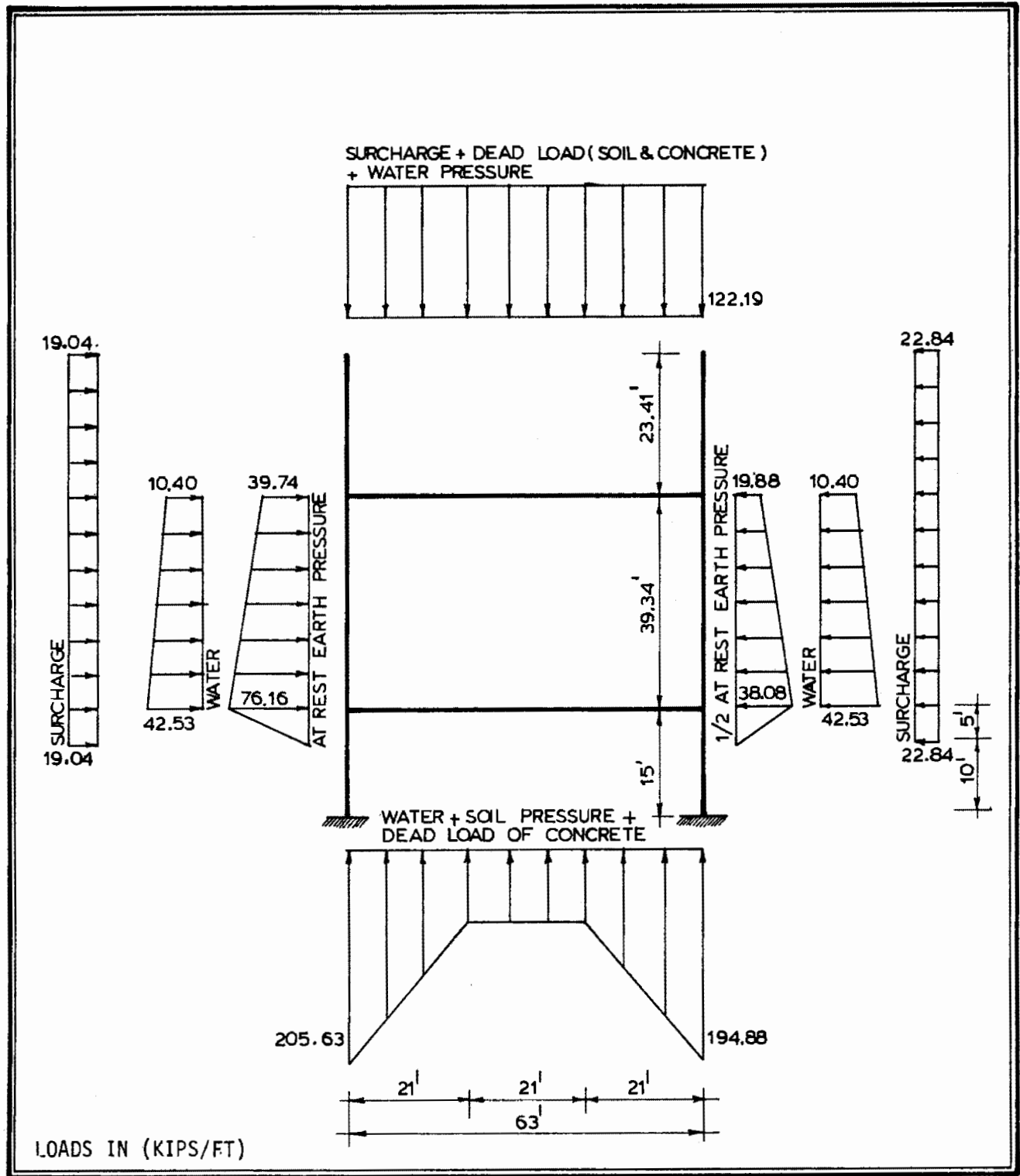


FIGURE 5-5 LOADING CONDITION FOR PARAMETRIC STUDY NO. 4

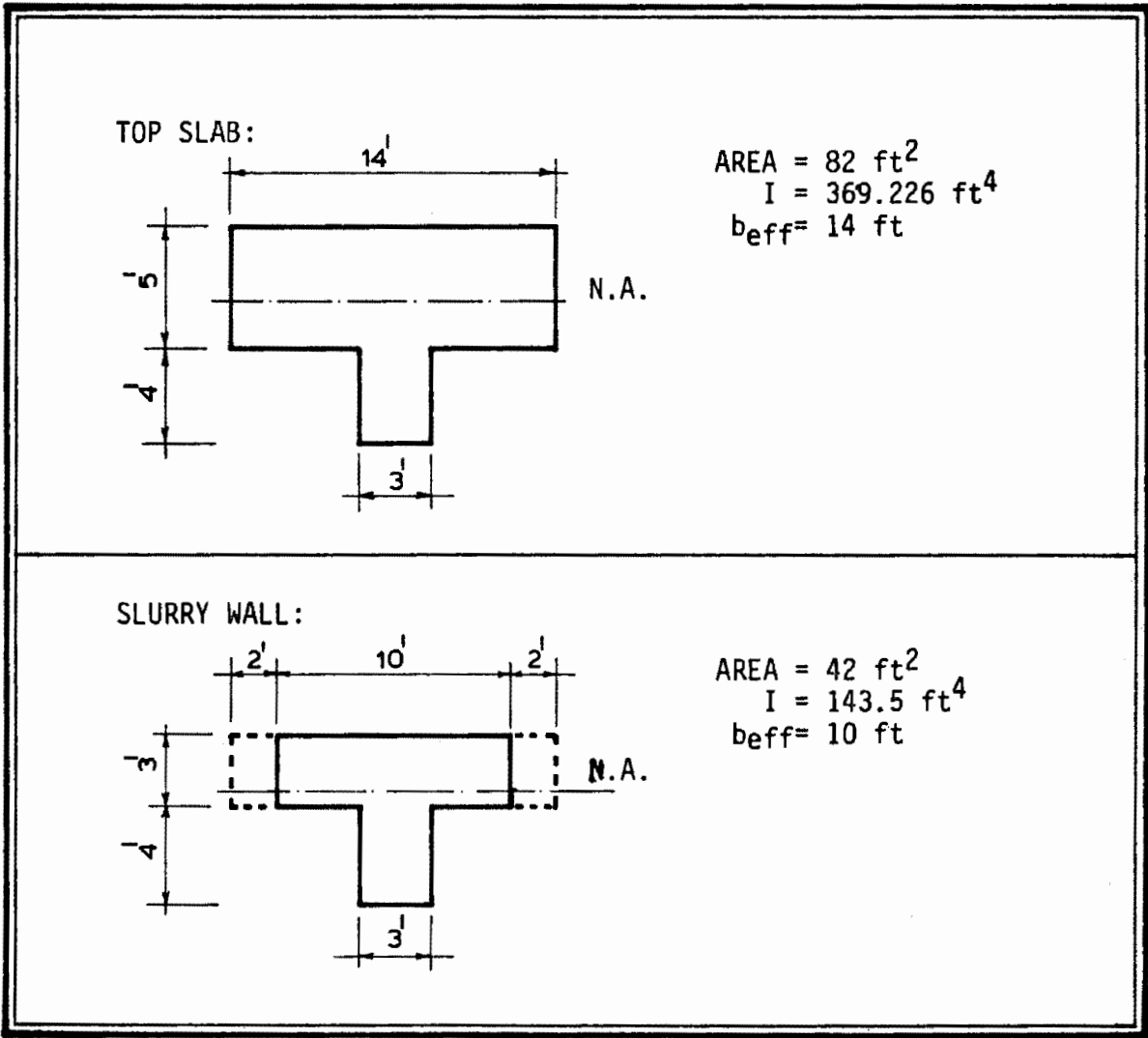


FIGURE 5-6 COUNTERFORT INFORMATION

## SUMMARY OF PARAMETRIC STUDIES

CAI investigations revealed that a designer has several effective options available to address perplexing difficulties that arise when trying to incorporate slurry walls into the frame of the permanent structure. Varying geometry (i.e., roof and base slab shape and thickness) allows reduction of moments at critical locations in the structure where the slurry wall construction process and field fabrication limitations precluded customary box frame arrangements. In particular, a folded plate roof can reduce moments at the wall/slab intersection by 20% to 40%, for asymmetrical and symmetrical loading cases respectively (see results of parametric study No. 1). In addition, the area of tension steel reinforcement can be reduced by as much as 68% (see results of parametric study No. 3).

Different design options such as intermediate supports or hinged joints and counterforts can also alleviate customary design problems. As stated before, hinged joints can eliminate troublesome moments at the slab-wall intersection, while counterforts insure structural stability against side-sway to a level equal to or better than that in a plain rigid box frame section (see results of parametric study No. 4).

### Future Work

Work under the present contract is still under way. In the coming months CAI engineers will be adapting concepts developed and tested in the parametric study to an actual comparative design analysis. The contract calls for a preliminary design to be developed for a site, preferably where slurry walls were used as temporary structures, so that a comparison can be made between conventional and the alternate design using slurry walls as a part of the permanent structure.

In consultation with the Board of Consultants a suitable site, WMATA's Federal Center S.W. Subway Station in Washington, D.C. (D4b) has been chosen. At this site in 1972, slurry walls were used as temporary earth support structures at a cost savings of over \$2,000,000. through the elimination of the underpinning required with conventional designs. The design is well documented and cost figures are readily available for a comparison between the present structure and an alternate design. Therefore, over the next several months, CAI engineers will be developing this preliminary design. A cost analysis and comparison will follow. The results will be presented in CAI's final report addressing the use of slurry walls as an integral part of underground transportation structures.



# PERFORMANCE MONITORING OF SLURRY WALL CONSTRUCTION

by

JOHN DUNNICLIFF  
GEOTECHNICAL INSTRUMENTATION CONSULTANT  
LEXINGTON, MASSACHUSETTS

## ABSTRACT

This paper describes various reasons for using instrumentation to monitor the performance of slurry walls and adjacent structures during and after construction. A review is given of the parameters that may be measured, and of the various available measurement methods. Among the instruments described are devices for measurement of subsurface vertical and horizontal movement, slurry trench width, movement of adjacent structures, tie back and bracing load, and pore water pressure. The paper gives some general guidelines for selection of monitoring arrangements for a particular project and includes references for case histories describing performance monitoring for slurry walls.

## PERFORMANCE MONITORING OF SLURRY WALL CONSTRUCTION

### INTRODUCTION

This paper describes various reasons for using instrumentation to monitor the performance of slurry walls and adjacent structures during and after construction. A review is given of the parameters that may be measured, and of the various available measurement methods. Among the instruments described are devices for measurement of subsurface vertical and horizontal movement, slurry trench width, movement of adjacent structures, tie back and bracing load, and pore water pressure. The paper gives some general guidelines for selection of monitoring arrangements for a particular project and includes references for case histories describing performance monitoring of slurry walls.

### REASONS FOR USING INSTRUMENTATION

During construction of a slurry wall itself the following need to be ensured:

- Trench Stability
- Verticality of Trench
- Guide Wall Stability

During and after excavation of material alongside a concreted slurry wall the following need to be ensured:

- Adequate Prevention of Ground Movement Behind the Wall
- Adequacy of Lateral Support Provided by Cross-Lot Bracing or Tie-Backs
- Prevention of Bottom Heave Failure (basal stability)
- Retention of Adequate Ground Water Level to Avoid Distress to Nearby Structures

Instrumentation frequently plays a role as a tool in ensuring adequacy of these factors.

PARAMETERS OF INTEREST

The following summarizes the parameters of interest in using instrumentation, together with possible measurement methods.

| Geotechnical Problem        | Parameters Of Interest                              | Possible Measurement Methods   |
|-----------------------------|---|--|
| Trench Stability            | Width of Trench                                     | <ul style="list-style-type: none"> <li>●Trench Width Gage</li> <li>●Inclinometer</li> </ul>  |
|                             | Horizontal and Vertical Movement of Adjacent Ground | <ul style="list-style-type: none"> <li>●Optical Survey*</li> <li>●Inclinometer</li> <li>●Subsurface Settlement Gage*</li> </ul>  |
| Verticality Of Trench       | Alignment of Sides Of Trench                        | <ul style="list-style-type: none"> <li>●Inclinometer In Temporary Casing</li> </ul>  |
| Guide wall Stability        | Horizontal and vertical Movement of Guide wall      | Optical survey*  |
| Ground Movement Behind Wall | Horizontal Movement Of Ground                       | <ul style="list-style-type: none"> <li>●Optical Survey*</li> <li>●Inclinometer In Or Behind Wall</li> <li>●Horizontally Installed Multi-Point Extensometer</li> <li>●Tape Extensometer Across Excavation</li> <li>●Piezometer</li> </ul> |
|                             | Vertical Movement of Ground                         | <ul style="list-style-type: none"> <li>●Optical Survey*</li> <li>●Subsurface Settlement Gage*</li> </ul>   |
|                             | Movement of Adjacent Buildings                      | <ul style="list-style-type: none"> <li>●Photography</li> <li>●Optical Survey*</li> <li>●Tiltmeter</li> <li>●Crack Gage</li> </ul>  |

TABLE I

TABLE I  
(continued)

| Geotechnical Problem                         | Parameters Of Interest                                  | Possible Measurement Methods                   |
|--|---|--|
| Lateral Support With Cross-Lot Bracing       | Load in Bracing   | ● Strain Gage                                  |
| Lateral Support With Tie-Backs               | Movement of Anchor                                      | ● Telltale                                     |
|  | Load in Anchor  | ● Load Cell                                    |
| Basal Stability                              | Bottom Heave or Horizontal Movement Of Ground           | ● Heave Gage *<br>● Piezometer<br>● Inclinator |
| Retention Of Ground Water Level              | Ground Water Level                                      | ● Observation Well                             |
|  | Pore Pressure   | ● Piezometer                                   |
| Full Scale Test Panels for Research Purposes | All Above Parameters                                    | See Above                                      |
|  | Earth Pressure Between Wall and Soil Outside Excavation | ● Earth Pressure Cell                          |
|  | Stress in Wall  | ● Strain Gage                                  |

\* Requires installation and use of deep benchmark to a depth below seat of settlement or heave.

## MEASUREMENT METHODS

In the following subsections the various measurement methods are described in turn. In general each subsection includes a statement of the use of the measurement method, the principle of operation, and some guidance on various practical details which, if followed, will maximize the chance of measurement success. Measurement methods are described in the following sequence:

### Deformation Measurements

- Optical Survey
- Inclinometers
- Subsurface Settlement Gages
- Combined Inclinator and Multi-Point Subsurface Settlement Gages
- Multi-Point Extensometers
- Heave Gages
- Tape Extensometers
- Telltales
- Benchmarks
- Trench Width Gages
- Crack Gages
- Tiltmeters

### Load and Stress Measurements

- Strain Gages
- Load Cells

### Water and Earth Pressure Measurements

- Observation Wells and Piezometers
- Earth Pressure Cells

### Optical Survey

Horizontal movements of the ground surface, the guide walls, or the top of the slurry wall itself are normally measured by holding a steel tape or scale at right angles across a line of sight between a fixed transit position and a permanent foresight. It is particularly important to ensure that the end points of the

line of sight are immovable and, if there is a possibility of movement, distances should be chained from these points to permanent points more remote from the excavation. Accuracy is generally about  $\pm 0.01$  feet.

Vertical movements of the ground surface, the guide walls, or the top of the slurry wall itself are usually measured by second or third order optical levelling to an accuracy of  $\pm 0.01$  feet. Simple studs are used as measuring points on concrete surfaces, while on the ground surface steel or wooden stakes are often driven to create a measuring point. In areas where seasonal soil moisture change or frost action would cause vertical movement of such a measuring point, a Borros anchor (described later) should be set about five feet below ground surface to serve as a surface measuring point. Measurements of vertical movement require use of a good benchmark, described later.

### Inclinometers

Inclinometers provide a method of measuring subsurface horizontal movement, either of the slurry wall itself or of the ground behind the wall. They can also be used to determine verticality of the excavated slurry trench.

An inclinometer system consists of a pipe installed in a nominally vertical borehole, with internal longitudinal guide grooves. A torpedo containing an electrical tilt sensor is lowered down the pipe on the end of a graduated electrical cable, orientation being controlled by wheels riding in the guide grooves. The electrical cable is connected to a remote readout device indicating tilt of the torpedo with respect to vertical. Tilt readings and depth measurements enable the alignment of the grooved pipe to be determined, and changes in alignment provide horizontal movement data.

For slurry wall measurements a precise tilt sensor is required, the preferred sensor being a closed loop force balance servo accelerometer, such that measurement accuracy is approximately  $\pm 0.2$  inches in 100 feet of depth. Hand calculation of data is a laborious procedure, and data reduction should be performed by computer. Magnetic tape readout units are available and, although expensive, can often provide economy by reducing field reading and data calculation time.

Several details of good practice are worth noting. After a set of readings have been taken within the grooved pipe, a repeat set should be taken with the torpedo rotated  $180^\circ$  in the grooves, and computation based on the difference between the two sets, thereby negating any zero drift in the sensor and averaging for groove irregularities. After installation of grooved pipe in holes deeper than about 60 feet a survey should be made of in-place groove twist, using a rental device from the instrument manufacturer. Twist can be present in the pipe prior to installation and can be

aggravated during installation, and clearly any unrecognized twist will give false data on the direction of horizontal ground movement. The torpedo should be checked frequently, using either a test stand obtainable from the manufacturer, a home made stand on a suitably sturdy wall, or by installing a grooved pipe in an area remote from ground movement and using this as a stable calibration pipe. The inclinometer system does not provide a measurement of absolute horizontal position, but merely position with respect to one end of the grooved pipe. Great care should be taken to install the bottom of the pipe deep enough so that base fixity can be relied upon, in which case data are calculated from the bottom upwards. If this is not possible periodic optical survey measurements should be made on the top of the pipe to determine the top location, and data calculated from the top downwards. Ideally both should be done, thereby providing a check on the base fixity assumption.

An "in-place" version of the inclinometer system is commercially available, whereby tilt sensors are locked in place at various depths down a grooved pipe. Data can be obtained rapidly, can be telemetered to a remote location, and arrangements can be made for an alarm to sound in the event a pre-set horizontal displacement is exceeded.

Inclinometer pipes installed in soil are usually backfilled, in the annular space between pipe and soil, with a weak grout or with pea gravel. Inclinometer pipes installed within the slurry walls themselves are usually installed within a four inch PVC pipe attached to the reinforcing cage, the annular space between the pipes being filled with a weak grout. For measuring verticality of an excavated slurry trench a length of grooved pipe is lowered within the slurry filled trench and a series of double-acting hydraulic jacks, attached to the pipe, are used to force the pipe against one wall of the trench. Readings are made in the usual way, the jacks retracted and the pipe withdrawn.

### Subsurface Settlement Gages

Subsurface settlement gages provide data on vertical ground movements adjacent to a slurry wall, hence, on trench stability during trench excavation and on overall stability during excavation between slurry trenches. Shallow subsurface settlement gages are also used to create "surface" measuring points below the zone of seasonal moisture changes and frost action.

Subsurface settlement gages fall into two general categories, single point gages and multi-point gages. The most commonly used single point gage is the "Borros anchor", consisting of a steel anchor mechanically set at the bottom of a borehole. A small diameter riser pipe extends from the anchor to the ground surface, and optical survey elevations are taken on top of the pipe to keep track of anchor settlement. A larger diameter sleeve pipe

protects the riser pipe from vertical movement of soil above the anchor. Although a frequently used and simple device, problems can arise due to binding between the bottom of the sleeve pipe and the riser rod, such that downdrag on the sleeve pipe causes downward movement of the anchor. This can be overcome by installing an O-ring bushing or a length of greased garden hose in the annular space at the bottom of the sleeve pipe. Accuracy of measurement will normally be  $\pm 0.01$  feet.

A full pattern of subsurface settlement with depth can be determined using a multi-point inductive coil settlement gage. The gage consists of a corrugated plastic pipe installed in a nominally vertical borehole with stainless steel wire rings around the pipe every five or ten feet. The annular space between pipe and borehole wall is grouted with a grout having similar modulus to the soil. A probe containing an inductive coil is lowered within the pipe on the end of an electrical cable and survey tape, proximity between probe and each steel wire in turn being recognized by maximum deflection of a readout meter. Tape readings at the ground surface provide data for computation of settlement. If the lowest steel wire is within the zone of settlement, readings are referenced to the top of the pipe and an optical survey elevation must be taken on this point to determine absolute settlement, to an accuracy of  $\pm 0.01$  feet. If greater accuracy is required the lowest steel wire must be below the zone of settlement, and readings are referenced to this point. If a worm gear winding mechanism and dial height gage are used at the reading head, an accuracy of  $\pm 0.02$  inches can be achieved.

#### Combined Inclinometer and Multi-Point Subsurface Settlement Gages

It is possible to package the multi-point inductive coil settlement gage and inclinometer pipe such that they can be installed in a single borehole, thereby obtaining both horizontal and vertical subsurface movement data from one installation. The system requires careful sizing of inclinometer pipe and corrugated plastic pipe, packing the intervening space with grease, and careful selection of grout mix (with engineering properties as similar as possible to those of the surrounding soil) to fill the annular space between corrugated pipe and soil.

#### Multi-Point Extensometers

Multi-point extensometers, installed vertically, have been used to monitor subsurface settlement of soil on the outside of slurry walls. They have also been installed horizontally or inclined slightly downward, through the slurry wall from the inside of the excavation to monitor horizontal movement of the wall and soil. There appears to be little reason to make vertical installations in the future, as the inductive coil settlement gage previously described provides a greater coverage of movement data of adequate accuracy for similar cost.



A horizontally installed multi-point extensometer consists of up to six separate anchors placed at various depths down a drillhole, with a sleeved rod connected to each. Wires are available as an alternative to rods, but in this application rods are to be preferred. The rods pass through a head set in the slurry wall, and relative movement between the end of each rod and the head gives data on horizontal movement. The deepest one or two anchors should be set beyond the zone of any expected ground movement, to serve as a datum point for deformation measurements. Zero relative movement between the two deepest anchors usually indicates that both are beyond the active movement zone. Various types of anchors are available, the grouted type being suitable, and providing the easiest installation procedure, requiring that the drillhole is angled slightly downward. If access is available to the reading head, readings are taken manually with a mechanical gage. If a remote readout is required, the most efficient method is use of a recently developed "magneto-strictive" device. A permanent magnet is attached to each rod within the few feet near the head, and one to the head itself. A guide tube is installed through the head and alongside all the magnets. Magnet separation is measured by inserting a probe containing a magneto-strictive wire. The operating principle consists of sending an electrical pulse along the wire, which is influenced by the presence of each magnet as it travels down the wire and returns to the source end. The pulse travels at a known speed, and hence by accurate timing of pulse return characteristics the magnet separation and hence distance between anchors can be determined. Accuracy is on the order of  $\pm 0.005$ ". The primary advantage of this device in comparison with alternative electrical sensors is that only one sensor is required for monitoring all anchors in a drillhole, hence, achieving substantial economy. The magneto-strictive device can either be installed permanently at each head or can be used as a portable "wand." Arrangements can be made for supplementary manual readings using a mechanical gage.

The annular spaces between rods and sleeves should be filled with a light oil. A disconnect should be provided between the inner end of each rod and its anchor, using a simple bayonet arrangement. In this way, if questionable readings are made, the appropriate rod can be disconnected from its anchor by gripping and turning at the head and free sliding within its sleeve verified. If the rod does not slide freely, the sleeve will have been squeezed and data from that anchor will not be reliable.

### Heave Gages

Heave gages are used to monitor heave of the base of the excavation between slurry walls as an index of basal stability. They fall into two general categories. First, gages which require

lowering rods or a probe down a hole to locate a buried component. Second, electrical gages which provide a measurement of heave with respect to a deep anchor, and do not require lowering of a rod or probe.

The simplest method in the first category is to install a conical steel point, facing upward, at the bottom of the excavation. At any time during the progress of the excavation a probing rod of known length is lowered down the borehole to mate with the conical point. The elevation of the top of the rod is determined by optical levelling, hence, the elevation of the conical point. Accuracy is approximately  $\pm 0.01$  feet.

The second category requires drilling a hole to below the anticipated seat of heave, setting an anchor to which is attached a sleeved rod. The rod terminates at an electrical linear displacement sensor set below the eventual bottom of the excavation, such that any change in distance between sensor and deep anchor causes an identical movement within the sensor itself. A cable runs up the borehole to the current bottom of the excavation, and arrangements can be made to set the cable terminals below the excavation bottom using a packer device such that excavation can proceed without damaging the cables. Several sensors can be set in the same borehole to provide a pattern of heave measurement with depth. Accuracy can be as great as  $\pm 0.005$  inches.

Clearly, the second category is the more expensive, requires far greater skill and care during installation, and is necessary only when  $\pm 0.01$  feet accuracy is insufficient.

### Tape Extensometers

Tape extensometers are used to measure the width across an excavation between slurry walls, and hence to provide a cross-check on horizontal movement measurements by optical survey or inclinometers.

Studs are attached to the walls, and the portable extensometer mated with the studs and stretched across the excavation at the time of reading. A minimum two man crew is required.

### Telltales

Telltales are used to monitor the movement of tie-back anchors with respect to the face of the slurry wall, hence, providing an indication of loss of anchor load and a forewarning of possible ground and wall movement. They normally consist of a small diameter rod within an oil-filled sleeve, the "stick-out" through the anchor locking plate being read with a mechanical gage. A disconnect arrangement between the rod and its anchor, as described previously for multi-point extensometers, provides a means of checking that the rod is free to move correctly within its sleeve.

## Benchmarks

Benchmarks established on substantial permanent structures ordinarily do not contribute error to vertical movement measurements. However, benchmarks placed at shallow depths in soil often move to some extent and the movement may be sufficient to interfere with desired accuracy of a survey. Apart from effects of frost heave and seasonal moisture changes, construction activities may settle a surface bench as a result of extension strains toward the excavation.

If no suitable permanent structure is available, remote from all possible vertical movement due to construction activities, a deep benchmark should be installed to a depth below the seat of vertical movement. Such a deep benchmark consists of a pipe, anchored at depth, surrounded by and disconnected from a sleeve pipe to protect the inner pipe from vertical movement caused by soil movement. The space between the two pipes should be filled with a bond breaking material.

It is good practice to install three such benchmarks and to survey between them on a routine basis, thereby identifying any vertical movement of a particular benchmark.

## Trench Width Gages

Trench width measurements are normally associated with full scale test panels rather than with routine construction monitoring. Two distinct type of gages have been used in such tests, one in Norway and one in Boston.

The Norwegian case is reported by DiBiagio and Myrvoll (1972) and used a hydraulic gage. The gage consists of a piston within an oil filled piston chamber, set horizontally across the trench. End bearing plates contact opposite walls of the trench, one attached to the end of the piston rod, the other to the other end of the assembly. A standpipe rises vertically from the piston chamber. A reduction in trench width causes piston movement and an upward flow of oil into the standpipe, and hence, standpipe oil level can be related to trench width. The gage was attached to the reinforcing cage prior to installation in the trench.

The Boston case (Goldberg, Zoino, Dunncliff, 1978) required monitoring of trench width in which there was no reinforcing cage, both prior to and after concreting. The Norwegian device would almost certainly have been dislodged during concreting, and the absence of steel allowed use of the "soil strain gage" inductive principle. The system consists of opposing twelve inch diameter coils installed directly on the surface of the trench walls after excavation. The coil separation distance and hence change of trench width at the coil location is determined by sending an electric current through one of a pair of coils installed on

opposite sides of the slurry trench. This primary current induces a corresponding secondary current in the second coil. The induced secondary current is measured and compared with the primary current with respect to amperage and phase shift and the coil separation distance determined. Coils were installed using a double acting hydraulic jack supported on orientation rods. Four plastic tent pegs were attached to the back of each coil, the jack retracted, the coils supported on opposite ends of the jack, the jack and coils lowered into the trench with controlled depth and orientation, the jack actuated to drive the tent pegs into the soil until coils were at the trench wall surface, and the jack retracted and withdrawn. Measurements were taken while the trench was filled with slurry, after concrete pouring, and after concrete set with an accuracy of approximately  $\pm 0.1$  inches.

Unlike an inclinometer system, these trench width gages do not indicate displacements relative to initial conditions (before excavation) nor do they separate unequal movement of the two sides of the trench. They do however, provide data relative to localized surface sloughing of the trench walls and indicate actual changes in trench width. (Inclinometers measure soil displacement at some distance from the trench.) They also yield backup displacement data should inclinometers be destroyed during trench excavation.

#### Crack Gages

A pre-construction survey of buildings adjacent to a slurry wall excavation will normally be made as a legal record for defining building conditions prior to construction. The survey will include a written description of conditions, accompanied by a photographic record. The width of any existing cracks will be monitored using an optical crack width gage. Selected cracks may also be gaged with a portable mechanical gage of the Whittemore type by attaching permanent studs on each side of the crack. Subsequent readings with the gage provide a record of change in crack width and hence, can provide a forwarning of distress.

#### Tiltmeters

Tiltmeters are used to monitor verticality of buildings adjacent to slurry wall excavations and hence, can provide a forewarning of distress.

Normally ceramic plates are glued to the walls at representative locations, and readings of plate verticality made using a portable tiltmeter containing the same type of tilt sensor as used in an inclinometer. Alternatively tiltmeters can be permanently mounted at selected locations.

## Strain Gages

Strain gages provide a means of monitoring load in cross-lot bracing, hence, a check on adequacy of lateral support. They are also used, primarily in full scale test panels for research purposes, to monitor stress within the slurry wall itself.

For monitoring cross-lot bracing, the most effective method over the past decade has been use of vibrating wire strain gages mounted on studs welded to the strut. Attention needs to be paid to the following details. The thermal co-efficient of the gage itself should be as near as possible to the thermal co-efficient of the strut, hence, creating a true stress sensor independent of temperature. Such a gage will give a correct indication of stress change, including any stress change caused by change in temperature of the strut. Gages should be at least five feet from the ends of a strut to avoid end effects. For a full measurement of maximum stress due both to bending and axial thrust, a minimum of three gages are needed on a pipe strut and four on a wide flange strut. Cables should be encased in flexible conduit as physical protection and suitable cover plates should be installed over the gages themselves. If stress in the strut is of interest, readings should be related to the initial gage readings prior to strut installation. If the readings are to be used for determination of earth pressure on the wall, readings should be related to the gage readings after the strut is in place but prior to prestressing.

Recently weldable gages have been used successfully in cross-lot bracing. They are available both in vibrating wire and resistance strain gage versions, and are attached to the strut using a small high capacitance spot welder. If the resistance strain gage version is used, careful consideration must be given to proper gage circuitry (in no case should a quarter bridge be used), using high quality environmental connectors.

For monitoring stress within the slurry wall itself, three methods are available. First, attachment of strain gages, usually the resistance type, to the steel. Second, use of embedment strain gages in the concrete, either of the vibrating wire or resistance type. Third, use of "sister bars", short lengths of reinforcing steel gaged with a full bridge of resistance strain gages and cast in the concrete. The first method requires very careful installation techniques, difficult to accomplish in any environment where the steel gage can be housed, and tends not to be successful. In the second method the gages tend to be damaged during concrete placement, but with great care can be effective. The third method is to be preferred, with great care being taken over gage waterproofing and connectors. In this method it is important that the short length of reinforcing bar is not necked-down significantly at the gage location, otherwise strain measurements will be incorrect. Suitable "sister-bars" are available commercially.

## Load Cells

Load cells on selected tie-backs provide anchor load data, and hence, a forewarning of reduction in load and resultant instability. Strain gages on the ties themselves have been used for the same purpose, but usually with poor success. Load cells are "donut" shaped, such that the tie passes through a central hole in the cell, and are available in sizes to accommodate both Dywidag bars and bundles of stranded tendons. Cells are normally gaged with resistance strain gages, and should have sufficient gages to create insensitivity to non-uniform loading. Cells should be waterproof, and cables should be protected by encasement in flexible conduit of the "Sealtite" type.

As an alternative, a telltale arrangement can be used as a load indicator and, although requiring manual access to the face of the slurry wall, will often be less expensive than an electrical load cell. The telltale is a small diameter rod, attached to the tie within its sleeved length (i.e., within the "active zone" of the soil) and passing through a hole in the anchor locking plate. The rod is encased within its own sleeve. The change in "stick-out" of the rod with respect to the locking plate is measured with a mechanical gage and is equal to the change in length of the portion of tie alongside the rod. The tie is an elastic member, hence, load change can be determined from length change. The arrangement can be calibrated in place at the time of stressing the tie by monitoring rod movement as stress is applied. Accuracy can be  $\pm 5$  kips.

Although not related to performance monitoring per se, a comment on load measurement while locking-off tie-backs is worth making. Tie-back specifications usually call for proof-testing each tie to a certain load, and locking it off at a specified lower load. Use of a "calibrated" hydraulic jack is not suitable for this purpose, as the laboratory calibration does not correctly model the field conditions, where ram travel causes frictional build up and an actual applied load up to 25% less than the load indicated by the hydraulic pressure gage and "calibration". A load cell should always be used in series with the jack when stressing all ties, and a high quality mechanical load cell is often more convenient than an electrical strain gaged cell, due to the absence of cables and a separate readout box.

## Observation Wells and Piezometers

Observation wells provide a means of measuring the ground water table, and hence, observing whether the excavation has drawn down the water table and may result in settlement of adjacent structures. They usually consist of a slotted wellscreen attached to a steel pipe, installed in a borehole in a sand surround.

Piezometer in the soil provide information on:

- drainage of pore water from the soil towards the excavation, hence, a forewarning that consolidation settlement may cause damage to adjacent structures.
- shear deformation of the soil towards the excavation (shear deformation in a normally consolidated clay causes a rise in pore pressure, in an overconsolidated clay a reduction in pore pressure), hence, a forewarning that shear deformation may cause damage to adjacent structures.
- progress of heave beneath the base of the excavation, (pore pressure changes as heave occurs, a steady state hydrostatic pore pressure indicating end of heave due to unbalanced pore pressures), hence, a forewarning of failure due to basal instability.

If rapid measurement response to changing pore pressure is not required an open standpipe piezometer (Casagrande piezometer) is normally used. If rapid response is required, as in the cases of piezometers to monitor shear deformation or progress of basal heave, a diaphragm type of piezometer is necessary. The pneumatic type is preferable or, if pore pressures below atmosphere are to be measured, the vibrating wire type. In selecting a pneumatic piezometer, attention should be paid to the following details. A dry gas should be used rather than air. The volumetric displacement of the sensor at the time of reading should not be more than 0.002cc. Use of the types with a "pre-load" in the check valve runs a risk of zero shift due to change in the pre-load value. The types having a readout pressure gage on the return line and which are read under a no-flow condition are sensitive to flow rate and tubing length. If the piezometers are read under a flow condition, a constant flow rate is essential, preferably created by an automatic constant volume flow controller.

If piezometers are installed in soils containing sand size or larger particles, the drill casing should not be left in place, as this runs the risk of pore pressure leakage between the soil and the outside of the casing. A particularly useful piezometer for installation in soft clays is the "Geonor-M-206" model, installed by connecting to E-size drill rod and pushing into the soil. The device is sold as an open standpipe piezometer but can be converted to a pneumatic instrument by sealing a pneumatic sensor within the piezometer body, and is recoverable.

### Earth Pressure Cells

In a few cases earth pressure between a slurry wall and the soil outside the excavation has been measured for research purposes. Either pneumatic or vibrating wire earth pressure cells are satisfactory. DiBiagio and Robi (1972) describe a procedure in which



an inexpensive hydraulic jack is used to position each cell against the wall of the trench, and to hold it in position while the panel is concreted. The cells and the hydraulic rams used to position them in the trench are attached to the preassembled reinforcing steel cage before it is lowered into the slurry filled trench. Each cell is first mounted in the center of a flat steel plate such that the membrane is flush with the surface of the plate. The assembly is then attached by means of a flexible coupling to the body of the hydraulic jack and a reaction plate of similar size is fastened to the piston end. To avoid exerting forces on the reinforcing steel cage during installation of the cells, the body of the jack is placed inside a short length of pipe welded to the reinforcing. The inside diameter of this pipe is such that the jack can slide back and forth freely inside it. When hydraulic pressure is applied to the jack, the piston is first forced out until the reaction plate comes in contact with the soil whereupon the piston ceases to move and the body of the jack is displaced in the other direction until the pressure cell engages the soil on the opposite side of the trench. In this manner the force developed by the jack is transmitted directly to the sides of the trench and not to the reinforcing. Once the cell and the reaction plate are in contact with the sides of the trench the ram pressure is increased until the desired seating force is obtained. This pressure is maintained throughout the concreting of the panel and is released when the concrete has set.

If effective stress rather than total stress is required, then clearly a piezometer must accompany each earth pressure cell, either installed in a manner similar to the earth pressure cells or in nearby boreholes in the soil.

#### SELECTION OF MONITORING ARRANGEMENTS FOR A PARTICULAR PROJECT

It is not possible to provide hard guidelines on selection between the previously described monitoring arrangements for a particular project, because such a selection is entirely dependent on the questions remaining in the designer's mind after completing his design. Any geotechnical design has, inherent within it, unanswered questions, and instrumentation is nothing more than a tool to assist in answering those questions. The designer should not ask "what did the other engineer measure on his project?", but rather should identify which features of his design have questionable assumptions or low factors of safety, and consider performance monitoring instrumentation as a tool for providing data upon which additional judgements can be made. Inherent within this approach is, of course, the requirement that geotechnical personnel familiar with the design assumptions are involved in the construction phase.

Despite the above "there is no cook-book" statement, a few general guidelines can be given.



The most frequent performance monitoring procedures are optical survey to monitor building, ground surface and guide wall deformation, and inclinometers to monitor horizontal ground and/or wall movement.

If both horizontal and vertical subsurface movement measurements are required, locations can be arranged to provide a cross-check between measurements, for example inclinometers, horizontal multi-point extensometers and support load measurements at the same station.

Rather than spreading instruments uniformly over a length of slurry wall, it is usually more efficient to select a few representative stations and instrument those fully, and then to use minimal instrumentation at other stations to examine whether in fact the few selected stations are representative of the critical conditions.

## BIBLIOGRAPHY

The following publications describe performance monitoring of slurry wall construction.

- DiBiagio, E. and B. Kjaernsli (1961) "Strut Loads and Related Measurements on Contract 63a of the Oslo Subway." Proc. ICSMFE pp 395-401. Paris.
- DiBiagio, E. and F. Myrvoll (1972) "Full Scale Field Tests of a Slurry Trench Excavation in Soft Clay." Proc. 5th ECSMFE, vol. I, pp 461-471. Madrid.
- DiBiagio, E. and J. A. Roti (1972) "Earth Pressure Measurements on a Braced Slurry-Trench Wall in Soft Clay." Proc. 5th ECSMFE, vol. I, pp 473-483. Madrid.
- Eide, O., G. Aas, T. Josang (1972) "Special Application of Cast-in-Place Walls for Tunnels in Soft Clay in Oslo." 5th ECSMFE, vol. I, 485-498. Madrid.
- Flaate, K. and R. B. Peck. (1973) "Braced Cuts in Sand and Clay." N.G.I. Pub. No. 96. Oslo.
- Goldberg, Zoino, Dunicliff & Associates, Inc. (1978) "Slurry Wall Test Panel Report. MBTA Red Line Extension, Davis Square to Alewife." Unpublished.
- Huder, J. (1972) "Stability of Bentonite Slurry Trenches with Some Experiences in Swiss Practice." Proc. 5th ECSMFE, vol. I, pp 517-522. Madrid.
- Karlsruud K. (1976) "Instrumentation of the Two-Story Tunnel Through Studenterlunden Constructed Using the Diaphragm Wall Technique." (in Norwegian, English Summary) N.G.I.
- Karlsruud, K. (1976) "Practical Experiences from the Excavation of Slurry Trenches in Oslo Clay." N.G.I. Pub. No. 110. Oslo.
- Karlsruud, K. and F. Myrvoll (1976) "Performance of a Strutted Excavation in Quick Clay." Proc. 6th ECSMFE, (Also N.G.I. Pub. 111). Vienna.
- Massachusetts Bay Transportation Authority (1978). Plans and Specifications for Construction of Harvard Square Station.
- Massachusetts Bay Transportation Authority (1979). Plans and Specifications for Construction of Davis Square Station.
- Rosenberg, P., G. St. Arnaud, N. L. Journeaux and H. Vallee, (1977), "Design, Construction, and Performance of a Slurry Trench Wall Next to Foundations." Can. Geotech. J. 14, pp 324-339.

**Abbreviations:**

**N.G.I.** = Norwegian Geotechnical Institute.

**ICSMFE** = International Conference for Soil Mechanics and Foundation Engineering.

**ECSMFE** = European Conference for Soil Mechanics and Foundation Engineering.

## ACKNOWLEDGEMENTS

The writer acknowledges with thanks the assistance of the following engineers in providing a bibliography of publications describing instrumented slurry walls: Matthew Barvenik, William Beloff, Donald Goldberg, and Richard Simon of Goldberg, Zoino, Dunicliff & Associates; Eldon Abbott of Parsons, Brinckerhoff, Quade and Douglas.

SPEAKER: John Dunicliff  
Geotechnical Instrumentation  
Consultant

D. J. Jobling  
London Transport

Question:

I have not used instrumentation in slurry wall work but I have used considerable subsurface instrumentation for monitoring ground movements during tunnel drives and always found it very unsafe to use just one borehole or one instrument for movement. I found that it was wise to use a number of them to relate movements together to see what is happening and when you get something unusual or something that does not look right, you suspect the instrumentation before you assume that the results are right. Can I have your comments?

Answer:

Mr. Dunicliff

Yes, I agree with your philosophy 100%. One thing that I think we should try to do is when we plan one of these instrumentation programs is to look ahead and think about the time when the instrumentation man says, "Something terrible is happening, according to my instruments," and the job superintendent comes up and says, "How do you know your instruments are working?" Now I have to be able to answer that question. If I can't answer that question, I have no right to be out on that job. So in the early planning phases I think we have to ask ourselves how are we going to answer that question. And maybe the way is to measure something two ways or to have several instruments so that you can compare and evaluate and toss out the one that is evidently bad. If you address the problem in the cool light of a Monday morning instead of the hell of a Saturday afternoon when it happens on the job, you are half way through it. But it certainly is a temptation when one instrument shows something dramatic happening. Sometimes you can readily say it is not working. But if you plan ahead of time, I think that you can cover that problem.

John Huang  
Ackenheil & Associates

Question:

Your Boston trench gauge, was that for the purpose of measuring the trench movement before the concrete had set or after? If it was before the concrete was set, would a Norwegian trench gauge have done just as well?

Mr. Dunnicliff

Answer:

The purpose of it was to monitor the closure (opening and closing of the trench). During the time the trench remained open... bentonite filled... during the time the concrete was placed and after the concrete had set. My concern with a Norwegian gauge was that during concrete placement, it would be knocked out of position because it had a physical presence across the trench and I feared that as the concrete came up, it would just be knocked out. In the Norwegian application, they had steel in their trench; in the Boston one, we didn't. So we had nothing to tie it to and that simple coil stuck in the wall with a tent peg--we felt would stay there, and it did. I think that one of them came out, but the rest of them stayed there, and that was my reason for not using the Norwegian gauge.

Asaf Ali Qazilbash  
C. E. Maguire, Inc.

Question:

In the width gauge that you are using, does that get affected by the dielectric medium that you have between the two coils--the fact that you have slurry at one time, air at another time, and concrete at another? Does that affect the electric property?

Mr. Dunnicliff

Answer:

No, provided that you have nothing magnetic there. It is the magnetic capability that would screw you up. In other words, you could not use it if you had a steel reinforcement there. We made some tests in the lab before doing this, and it made no difference whether you had water or concrete or

Dunnicliff  
(Cont'd)

slurry--or whatever--just so you have continuity of data independent of the material, provided it was not metallic. Obviously, if you had a magnetic ambience, the thing would not work for you.

Kjell Karlsrud  
Norwegian Geotechnical Institute

Question:

I would like to make a comment regarding the hydraulic width gauge. We have used it also during concreting, but as you indicated at that time, it was within the reinforcement cage. So we could observe what was happening during concreting, as well, with that gauge. I think the gauge you have developed is very nice also, but one of the advantages of this hydraulic gauge is that you get a direct reading of the changes in width because the stand pipes go up; you can mount them on the board, and you can read directly the changes in width with enough accuracy (such as millimeters). Reading it directly is the advantage of this, so you can see on the spot what is happening.

Dunnicliff

Answer:

I agree with this line of thinking that says this can be done simply--do it simply--it's obvious that the Norwegian one is much more simple than the Boston one.

Joseph Minster  
Dames & Moore

Question:

These gauges that you lower into an open trench full of slurry, what is wrong with a bucket that you use in excavating that trench going down and coming up? Isn't that a good enough indication that you have the width you are looking for?

Dunnicliff

Yes, in the two cases that I described--the Norwegian test and the Boston test, it was not during a construction/production test. It was a specific research project as part of the design phase because there was a real concern that the trench would stay open. The Boston clay was very soft and extremely

Dunnicliff  
(Cont'd)

sensitive, so it was felt an extremely small movement would be sufficient to cause failure. So in the production phase, yes, I am sure your approach would be appropriate. But in a researching test that goes into overriding a design judgment, I think you have to be a little more precise than that.

Minster

Question:

Yes, I think this is the idea that we must accept because my field experience actually shows that you had better stay out of that trench as much as possible. Any time you try to go in, in this case, for example, you either do not achieve anything because the minimum width is determined by the type of bucket you are using or, if any sloughing occurs, there is not much you can do about it anyway. You just have to spend more with concrete, and that's it.

Dunnicliff

Answer:

In the Boston case the rationale was: Can we hold a slurry trench up? Is the slurry trench method an appropriate design procedure? If not, what are all the alternatives? Or can we build the guide wall up and have an excessive head of slurry or look for other possibilities. Therefore, it was a research effort.



UNIQUE ASPECTS AND REQUIREMENTS IN THE  
MASSACHUSETTS BAY TRANSPORTATION AUTHORITY'S  
RED LINE EXTENSION-NORTHWEST IN CAMBRIDGE  
AND SOMERVILLE, MASSACHUSETTS

by

EUGENE J. PERKO  
SVERDRUP & PARCEL AND ASSOCIATES, INC.  
BOSTON, MASSACHUSETTS

ABSTRACT

This paper addresses the unique aspects and requirements in the MBTA's Red Line Extension, a rapid transit subway transportation facility in Cambridge and Somerville, Massachusetts, demonstrating how slurry walls aid in the construction of the permanent tunnel and station structures.

The principal issues addressed include the site-sensitive historic buildings, and traffic and pedestrian maintenance while continuing transit service in the active, congested Harvard Square area; the maintenance of an active, functioning railroad and contractor haul road adjacent to the tunnel construction in a restricted width railroad right-of-way; the community concerns of construction through wetlands and recreation lands; and the problems of construction in the varying soil condition, including a soft, sensitive "quick clay" concern at the Alewife Station location.

UNIQUE ASPECTS AND REQUIREMENTS IN THE  
MASSACHUSETTS BAY TRANSPORTATION AUTHORITY'S  
RED LINE EXTENSION-NORTHWEST IN CAMBRIDGE  
AND SOMERVILLE, MASSACHUSETTS

INTRODUCTION

A. A BRIEF HISTORY

The present Red Line rapid transit subway, opened in 1907, links downtown Boston with a terminal station at Harvard Square in Cambridge. A Red Line Extension has long been considered to shape and serve growth in what has been defined in numerous studies as the Northwest Sub-region (a corridor of 20 communities).

Extension of the Red Line beyond its present Harvard Square Terminus has been studied for over 35 years. Several alternate routes were proposed in a 1945 report. Other studies in the 1950's and 1960's and the early 1970's have reviewed and investigated various routes and combinations of railway and transit service to provide extended service to Route 128, some 11 miles from downtown Boston.

The development and completion of the Preliminary Environmental Analysis led to the Final Environmental Impact Statement which was submitted for funding in August 1977. The final EIS provided the MBTA's (Massachusetts Bay Transportation Authority) Red Line Extension Northwest request for funding for a transit alignment from Harvard Square to Arlington Heights.

The Town of Arlington adopted a resolution in April 1977 not to support construction of the Red Line in Arlington until certain proposals are satisfied.

Funding has been approved by UMTA for the extension from Harvard Square to Alewife with a request to evaluate additional lower cost alternatives through Arlington. Funding by Federal and State agencies totals over \$540,000,000 for the extension to Alewife.

B. EXTENSION DESCRIPTION

The funded project is approximately 3.1 miles of MBTA Red Line Rapid Transit from the present terminus at Harvard Square to Alewife, and to a point about 500 feet north of Route 2.

Construction begins with a cut-and-cover segment through Harvard Square, the route proceeds north in a deep bore tunnel generally following Massachusetts Avenue to Porter Square and on to Davis Square in Somerville. The route then turns west in a cut-and-cover tunnel on the Fitchburg Freight Cutoff railroad right-of-way to Alewife just south of Dewey and Almy Circle where Route 2 from the west terminates at the Alewife Brook Parkway. Through Freight Service will be discontinued on the Freight Cutoff from east of Grove Street (Davis Square area) in a direction towards Alewife to a point just east of Alewife Brook Parkway in Cambridge.

The transit route proceeds from Alewife along the Lexington Branch of the MBTA Commuter Rail System toward Arlington. Commuter operations were discontinued in March 1977.

The Harvard Square Station will be rebuilt in a new location contiguous to the present location and new stations will be constructed at three other locations. These are: Porter Square in Cambridge, Davis Square in Somerville, and Alewife in Cambridge. Parking spaces for 2,000 vehicles will be provided at Alewife. No new parking will be provided at Harvard Square, Porter Square, or Davis Square.

The extension will commence at the existing platform area at Harvard Square. From Holyoke Street, tracks in separate tunnels will turn north into Massachusetts Avenue, then enter a new station platform area extending from about Church Street to Flagstaff Park. From the station, tracks would continue north in a deep bore tunnel under Massachusetts Avenue. In profile, the existing bi-level track configuration would be retained through the new Harvard Square platform area, with tracks converging to a side-by-side configuration north of the station. Outbound tracks would descend on a relatively steep downward grade (4.0 percent) after leaving the new platform area. This descent would limit cut-and-cover work in Massachusetts Avenue by permitting deep bore tunneling to begin at the north end of Flagstaff Park.

In the deep bore tunnel, tracks would proceed northerly under Massachusetts Avenue to a station at Porter Square, just beyond and below the existing MBTA commuter rail station.

North of Porter Square Station, tracks in the deep bore tunnel would underpass the Porter Square Shopping Center and residential areas, curving left under College Avenue and Holland Street to the proposed Davis Square Station in the Fitchburg Freight Cutoff right-of-way. The Davis Square Station would be constructed by cut-and-cover methods. The Porter Square Station would be constructed by rock mining methods except for the mezzanine and the pedestrian tunnel under Massachusetts Avenue.

From Davis Square Station, the extension would proceed west in a cut-and-cover tunnel within the Fitchburg Freight Cutoff right-of-way. The horizontal alignment would generally parallel the present railroad alignment to minimize impacts to surrounding residential and commercial properties. Cut-and-cover construction would permit the profile to be raised, while allowing sufficient space for major utility crossings or relocations.

At about Harvey Street, the tracks in the cut-and-cover tunnel would leave the Fitchburg Freight Cutoff right-of-way, pass under Russell Field and W. R. Grace industrial property and continue to the proposed Alewife Station, which straddles the Alewife Brook Parkway. From Alewife Station, the extension would turn sharply north to enter the Lexington

Branch right-of-way. Tracks in the cut-and-cover tunnel would continue in the railroad right-of-way into Arlington to a point about 500 feet north of Route 2.

The four proposed stations are located as follows:

1. Harvard Square - New station platforms would be constructed under Harvard Square extending underground to Flagstaff Park. Other portions of the existing station would be redeveloped and the north leg of the bus tunnels would be relocated.
2. Porter Square - The new station would be located under the MBTA Commuter Rail Line just east of Massachusetts Avenue, crossing Somerville Avenue and extending into the Porter Square Shopping Center parking area. It is the deepest station on the proposed extension--constructed in rock.
3. Davis Square - The station would be constructed in the Fitchburg Freight Cutoff right-of-way, crossing under College Avenue and Holland Street.
4. Alewife - A station would be built beneath the Alewife Brook Parkway on an east-west axis immediately south of the Fitchburg Freight Cutoff. A 2,000 car parking garage would be constructed west of the Alewife Brook Parkway. Access to garage would be from Route 2 and Alewife Brook Parkway.

Despite the magnitude of the project, land acquisition requirements and displacement have been kept to an absolute minimum by routing transitways within existing transportation rights-of-way and by utilizing deep bore construction.

For the deep bore tunnel, twin section tubes, about 20 feet in diameter, each with a single track, would be built rather than a more costly single 34 foot diameter tube accommodating double tracks. A double-box concrete structure, about 35 feet wide, is provided for cut-and-cover tunnel sections, with variable-width transition sections at connections with the stations.

#### C. COSTS AND SCHEDULE

The main elements of cost are the four stations, the deep bore tunnels and the cut-and-cover tunnels.

The construction contracts have been awarded for the Harvard Square Station Complex, \$71,300,000; and the Davis Square Station, \$29,200,000. Two deep bore tunnel contracts have been awarded with a combined total cost of \$71,900,000. The Porter Square Station is presently being advertised and bids are expected to be opened by the

end of September. The project value is estimated at \$38,000,000 excluding the three metal ceiling liner options. The cut-and-cover tunnels west of Davis Square Station including the present Alewife Station and Garage design are estimated at \$100,000,000.

The first construction was begun on the deep bore tunnels in October 1978. The completion of construction for the alignment through the Alewife section is anticipated for 1983.

#### D. USE OF PERMANENT SLURRY WALLS

Permanent slurry walls are being used for structural support of station and roadway above for the Harvard Square Station and are planned for the Alewife Station, and the Davis to Alewife Tunnel. The slurry walls function to provide the soil retaining support needed during construction as well as for the completed station and tunnel. The slurry walls also provide the required underpinning support during excavation for buildings adjacent to the construction and in addition will provide all or most of the ground water cut-off as permitted by subsurface conditions.

## II PERMANENT SLURRY WALLS IN THE HARVARD SQUARE STATION

### A. DESCRIPTION OF EXISTING AND NEW STATION

The Harvard Square area of Cambridge has no well defined boundary. The geographic area extends eastward to Putnam Square, northward to about Waterhouse Street, southward to the MBTA yards, and westward to Radcliffe College. This general locale is referred to as the "Harvard Square Area". The intersection of Massachusetts Avenue, Boylston Street and Brattle Street--where the entrance kiosk to the existing Harvard Square Station is located--is specifically "Harvard Square".

Problems associated with extending the Red Line beyond the Harvard Square Area have been the subject of many studies over the years.

The physical facilities and operations of the existing subway and bus service in Harvard Square were intrinsic elements in all the design options studied. The need to maintain transit service during construction of the extension imposed significant constraints on design solutions.

The subway from Central Square in Cambridge approaches the Harvard Square Area in a single tunnel under Massachusetts Avenue. West of Putnam Square the tracks begin to separate vertically, and arrive at the station platforms (between Dunster and Holyoke Streets) on two levels in separate tunnels. Outbound trains enter the upper level and when reversed beyond the station, re-enter via the lower, inbound tunnel. Passenger platforms are one above the other, both on the Harvard Yard side of the tracks. From the station the tracks again converge to a common level in a three track, 45 foot wide tunnel extending under Brattle Street and Brattle Square to Eliot Street where the open train yard begins. Cross-over and lay-over capabilities are provided in the tunnel and yards.

The existing station complex featured a system of trolley-bus tunnels also operating at two levels. A two-way ramp descends from Mount Auburn Street to a tunnel portal near Brattle Square, then separates on two levels in tunnels paralleling the transit tunnel. At Harvard Square bus tunnels turn northward, converge to a common level, and ascend to the surface on an incline in Flagstaff Park. Passenger loading/unloading areas are under Harvard Square. Southbound trackless trolleys use the lower level, and northbound trackless trolleys, the upper level. Portions of several buildings on Brattle Street are supported by the roof of the bus-trolley tunnels.

Intermodal transfer was in the existing station accomplished by a maze of ramped passageways connecting each rapid transit platform with each of the two bus levels. The passageways, fare collection lobby, and access stairs to the surface are tightly concentrated in the area directly under Harvard Square. At the surface, the transit facility is distinguished primarily by the entrance kiosk in the center of the Square.

In traffic volume, among Red Line stations, existing Harvard Square Station is second only to Washington Street Station because it handles heavy bus transfer to and from North Cambridge, Arlington, Belmont, and Watertown. The station is a complex network of levels, ingeniously connected to each other by ramps, and the underground transfer circulation in particular works well. Exiting traffic to the Square above (including transfer to buses at grade) is not so well handled, and suffers from inadequate escalators. Entrance to the busway levels from the street was confusing due to unnecessarily awkward routing at the mezzanine level. The underground complex and the kiosk suffer from clutter, poor lighting, and poor signing. There is inadequate shelter for bus passengers at grade and confusion with surface traffic.

The new extension alignment commences at the present two level Harvard Square Station. In order to retain the existing bus, rapid transit tunnel arrangement and maintain the extension on public right-of-way, it was proposed that the two level concept be retained throughout the new transit station and its connection to the existing tracks.

From Holyoke Street, tracks in separate tunnels turn north on a 250 foot radius curve into Massachusetts Avenue, then enter a new station platform area extending 440 feet from about Church Street to Flagstaff Park. From the station, tracks would proceed northerly on a slight "S" curve to about Cambridge Street, continuing northerly in deep bore tunnel under Massachusetts Avenue.

The upper level track through the present Harvard Square Station platform area is approximately 25 feet below the ground surface; the lower level track is 40 feet below ground. Throughout the connecting tunnels and new station platform area, the 15 foot vertical distance between tracks would be maintained. Tracks would descend at a 3.6 percent maximum grade to depths of 32 feet and 47 feet, respectively, below ground at the beginning of the new station platforms. Through the platform area, tracks descend on a grade of 0.5 percent. The horizontal alignment of tracks and platforms curve slightly northwest on a 4,000 foot radius.

To accommodate new transit platforms and the transit extension on the new alignment, the north legs of the trackless trolley-bus tunnels are being relocated westerly from about Church Street to the portal at Flagstaff Park. The westerly bus ramp remains in its present location.

The Harvard Square Station complex is a composite of new station construction, which is now underway, and elements of the existing station, subways and busways. In concept, it is a rotation of the two existing track and platform levels from the present east-west position under Massachusetts Avenue to a north-south position--with the area under Harvard Square remaining the focal point for primary access, underground inter-modal connections and fare collection functions. The space under the Square will be entirely restructured to conform with the new design requirements. The abandoned train tunnel in the Harvard Square to Brattle Square sector would be kept structurally intact and those portions utilized in the new station concept will be internally renovated. Bus tunnels not rebuilt would also be renovated.

Primary access points from the surface to the station would be in Harvard Square. Additional access will be from the south and the north. Selection of entrance locations was coordinated with studies of pedestrian and vehicular circulation. The objective of these studies was to create a better pedestrian environment by lessening conflicts and congestion and by an allocation of open space more favorable to pedestrians.

The new station site plan incorporates a surface concept in which the present kiosk island is expanded southward to the sidewalk between Boylston and Dunster Streets, eliminating the present east-west trafficway south of the kiosk. Brattle Street from Harvard Square to Brattle Square is narrowed to two travel lanes, and Boylston Street will operate in both directions. The principal entrance is built in the area south of the present kiosk. In Brattle Square, an entrance to the existing train tunnel has been developed as a passageway to the lobby area under Harvard Square.

The City of Cambridge and Harvard University had expressed interest in having access capability near Church Street. A secondary mezzanine is provided which connects an entrance at the corner of Church Street and Massachusetts Avenue with an entrance near Harvard University's Straus Hall and this also functions as an entrance to the rapid transit platforms.

Egress to the north end of the station platforms is necessary for emergency use. Therefore, an inconspicuous emergency exitway is located at the south end of the Flagstaff Park near the busway incline.

An agreement has been made between the MBTA and the Massachusetts and Cambridge Historical Commissions to retain the existing kiosk structure as a prominent element in the Harvard Square area. It will be used as the future newsstand locations.

Escalators and stairs link the principal entrance in the kiosk area with the fare collection lobby. Stairs also link the Brattle Square entrance with the bus tunnel. Within the station, all levels are linked with ramps. Escalators and internal ramps facilitate access to bus loading areas and rapid transit platforms for the handicapped.

For the non-ambulant handicapped, an elevator is furnished.

The fare collection lobby is at an elevation approximately midway between the upper and lower transit platform levels and will serve both levels from a single fare collection line. After passing through the turnstiles, passengers travelling north ascend a ramp to the upper platform; inbound passengers descend by ramp to the lower platform.

Ramps also connect the "free" area of the fare collection lobby with the two trolley, bus-loading platforms. Distance from train to bus will approximately equal the present distance but circulation will be much simpler and more clearly delineated.



The functional characteristics of the underground busways will not change but passenger boarding areas would be modified. Bus passenger areas are upgraded in appearance, consistent with adjacent new construction.

## B. CONSTRUCTION METHODS AND IMPACTS

Cut-and-cover methods will be used to construct the project from the point of track tie-in to a point in Massachusetts Avenue near Cambridge Street (opposite the Hemenway Gym) where sufficient depth would be reached for deep bore construction. Project elements in the cut-and-cover section include transit tunnels, the new platform area, a temporary station, and the relocated section of bus tunnels.

Construction would be phased to minimize traffic disruption and pedestrian access. Carefully phased decking procedures will permit near-normal traffic operation while construction proceeds below the decking.

Where excavation passes near Lehman Hall, Straus Hall, Wadsworth and other Harvard Yard buildings, a slurry wall will be constructed. The need to underpin these and other nearby buildings in the project area will not be required. The wall will serve as the permanent structure wall.

Relocation of the north legs of the bus tunnels necessitate on-street operation of buses and trackless trolleys. On-street operations have been modified for the duration of the construction period. This frees tunnels and ramps for use in moving equipment and materials into and out of the construction site and measurably lessens the impact of construction in the Harvard Square Area.

Slurry walls will be used on all three sides of the triangular shaped station. The three curved walls have a total length of about 1700 feet and about 57,000 square feet of slurry wall construction. The walls are generally 3 feet thick except for a 3'-6" thick section of the south wall. Walls will be braced during construction with tie-back anchors to keep the excavated areas clear of wall bracing.

Construction of this section of the project requires approximately 5 years and will involve three phases:

### Phase I

- a. A temporary transit station will be constructed on the opposite side of the tracks from the existing platforms. An auxiliary passenger station has been built in the MBTA yards.
- b. Passenger operations would be transferred to the temporary stations, and the present platforms, mezzanines, passageways and kiosk entry would be abandoned. Train tunnels remain in use.
- c. Busway operations in tunnels will be discontinued and interim surface operations instituted.

## Phase II

The new station, new tunnels, and the relocated section of busways would be constructed.

## Phase III

- a. The tie-in with existing tracks would be made, and transit operations would commence at the new station.
- b. Portions of the abandoned train tunnels would be redeveloped as future concessions.
- c. All final interior and surface construction would be completed.

### C. TEMPORARY STATIONS

The temporary station in Harvard Square will be constructed between Dunster and Holyoke Streets under the south side of Massachusetts Avenue. This station will provide continued access to the station during and after demolition of existing platforms. It will mirror the present station and consist of an upper, outbound platform and a lower, inbound platform. Existing tunnel walls at both levels will be broken open to the extent required for access to and from the transit cars. The width between the existing tunnels and the south curblineline of Massachusetts Avenue would be adequate for station construction. Fare collection facilities would be located in a temporary head house on the surface. Paid passengers descend by stair directly from the head house to the lower, inbound platform. Outbound, (terminating) passengers ascend to the surface via separate stairways. The existing subway entrance near Holyoke Street, presently unused, will be used as an auxiliary exit.

The east-west trafficway between Boylston and Dunster Streets will be shifted northward, and the vacated space will be used for the temporary head house and pedestrian circulation. The street area over the temporary station will be decked and restored to normal traffic use.

A second temporary transit passenger area has been provided in the MBTA train yard immediately beyond the Eliot Street tunnel portal. This station is in close proximity to the trackless trolley turn-around at the Harvard Motor Inn area of Mount Auburn Street and thus serves the relatively large numbers of transit passengers who transfer to the Watertown and Waverly trackless trolleys. The passenger load at the Harvard Square temporary station is substantially less, and the transferring passengers avoid the walk from Mount Auburn Street to Harvard Square.

## D. NEIGHBORHOOD AND COMMUNITY FACTORS

### Pedestrian Circulation

The location of the new subway entrance in the kiosk area combined with the new pedestrian area improvements will reduce the conflict between the automobile and the pedestrian. This will improve pedestrian walking in Harvard Square and maintain a compact commercial core and commercial spine.

Open spaces directly affected by this project are Flagstaff Park and the southwest corner of Harvard Yard.

### Existing Historic Resources and Impacts

**Old Harvard Yard Historic District:** The Old Harvard Yard Historic District was created to preserve the site where the first college in the United States was founded. The Old Yard is a large rectangular area which includes 19 buildings and is bordered on the south and west by Massachusetts Avenue, on the north by Cambridge Street, and on the east by additional property owned by Harvard University. This district is listed in the National Register of Historic Places.

**Cambridge Common Historic District:** The Cambridge Common District was created to preserve an area which has served as a focal point for political, social, and religious activity in Cambridge for over 300 years. It is significant in a national sense because the Common served as a center for rebellious activity prior to the Revolutionary War and as a camp for George Washington's Continental Army. This district is listed in the National Register of Historic Places and includes the Cambridge Common, the bordering streets, and the surrounding land and buildings to a depth of 100 to 200 feet. Flagstaff Park is within this district.

The new Harvard Square Station will be built alongside the Old Harvard Yard District. A number of buildings within the district are close to the location of the proposed construction. Of eight buildings, only Straus, Lehman and Wadsworth Halls are sufficiently close to construction that they may be directly affected by it.

The alignment of the proposed tunnel would necessitate excavation from the surface along a line passing close to the aforementioned three buildings and would encroach upon a strip of yard space fronting Lehman Hall. To protect these buildings a slurry wall is proposed which would retain and stabilize the earth behind the line of excavation. The quality of workmanship will be controlled to ensure that no damage occurs. Approximately 250 lineal feet of masonry and iron fencing bordering the Lehman Hall site is to be temporarily removed. Salvageable components such as dressed stone and ornamental iron will be catalogued and stored for re-use. The fence will be rebuilt to match the present design after primary sub-surface construction is completed. All

disturbed landscaping and paving will also be renewed. All restoration work is to be done in consultation with the Massachusetts and Cambridge Historical Commissions.

The existing kiosk in Harvard Square is considered contiguous to this district by the Massachusetts Historical Commission. Station construction in Massachusetts Avenue occurs about 30 feet from the First Church, Unitarian, and although no adverse effects are anticipated a construction settlement monitoring program will be implemented as a precautionary measure. This monitoring program will be extended to other buildings and structures at Harvard Square.

The proposed alignment passes through Flagstaff Park (formerly called the "Little Common") which is within the Historic District. Construction will require the removal of about 27 trees, mainly oaks, maples, and elms of small to medium size. In cooperation with the Cambridge Historical and Conservation Commission, the affected area is to be re-landscaped with plantings of trees, shrubs and grasses upon completion of construction. Temporary removals include a flagpole monument, a statue monument, a formal paved terrace, ornamental masonry garden walls and balustrades. These would be restored. It will also be necessary to locate a permanent ventilation opening in the park which will be about 400 square feet in area, covered by permanent grating.

#### E. ALTERNATE CONSIDERATIONS

The use of secant piles to provide the ground wall support and permanent wall system was investigated and appeared to have some construction advantages; however other constraints and limitations provided disadvantages which outweighed the positive aspects.

The secant pile construction would require specialist contractors with the expertise and equipment required. Clearance requirement from existing buildings would be more than with slurry wall construction. Tie-back systems required whalers and infringed on horizontal space needs. Thicker walls would be necessary and there would be more joints requiring waterproofing.

The benefits of the slurry walls therefore led to the decision to utilize slurry walls.

#### F. COSTS

The total \$71,300,000 cost of the Harvard Square Station includes the station structure as well as the station finish efforts. The bids were received and opened in December, 1978, and contract awarded in February 1979. The first four bids ranged from the low of \$71,300,000 to \$77,400,000 with a fifth bid of \$85,000,000. The low bidder for the slurry wall item was \$50 per square foot for the 54,200 square feet of slurry wall. Other bidders were at \$120, \$120, \$40, and \$50 per square foot. An estimated 2,500 square feet of slurry wall in rock was bid at

\$150 per square foot by the low bidder and at \$120, \$120, \$125 and \$170 per square foot by others.

The engineers' estimates for slurry wall items were \$40 per square foot for normal slurry wall construction and \$150 per square foot for slurry wall in rock.

These costs reflect the congested, sensitive concerns of the Harvard Square area with its traffic maintenance problems, pedestrian access requirements, historic buildings, utilities, etc., while maintaining the existing subway and bus service.

### III PERMANENT SLURRY WALLS IN THE DAVIS SQUARE TO ALEWIFE TUNNEL AND ALEWIFE STATION

#### A. PROJECT DESCRIPTION

The alignment from Davis Square to Alewife extends in cut-and-cover tunnel from Davis Square along the Freight Cutoff Right-Of-Way, across the northwest corner of Russell Field, across the W. R. Grace property just north of Jerry's Pond and Lehigh Metal Products, beneath Alewife Brook Parkway, and on towards East Arlington and Arlington Center along the MBTA Lexington Branch Railroad Right-Of-Way.

The transit station at Alewife is located beneath the Alewife Brook Parkway just north of Lehigh Metal Products. Entrances and fare collection facilities are located on both sides of the Parkway at the ends of the station platform which lies on an east-west axis. A parking garage for transit users, containing kiss-and-ride and bus loading/unloading facilities, will be constructed on a site west of the Parkway and north of the Rindge Avenue Extension; this site was occupied by several businesses. A mezzanine or lobby is to be constructed on level below grade and beneath the parking garage to provide access from the garage to the station platform. The platform will be located east of the garage two levels below grade. An underpass located beneath Alewife Brook Parkway will provide free pedestrian circulation between the east and west sides of the Parkway. The Alewife complex also includes a section of tunnel extending from the station across the Alewife Brook Reservation to Route 2. Turnback crossovers and a lay-up track would be provided in this tunnel section.

Construction of the Davis Square to Alewife Section, which includes the line segment between the two stations, the Alewife Station, the parking garage, and approximately 1,200 feet of tunnel north from the Alewife Station would cost approximately \$100,000,000 and require about four years for completion.

#### Tunnel Line Segment

From the Davis Square Station in Somerville, the alignment continues west toward Cambridge following the Freight Cutoff right-of-way where it would turn southwest and cross Harvey Street and Russell Field to reach the Alewife Station.

From the end of Alewife Station, the alignment would turn northward on a 400 foot radius through the Alewife area, entering the existing Boston and Maine Lexington Branch right-of-way as quickly as possible to minimize impacts to environmentally sensitive lands within the Alewife Brook Reservation. After the alignment enters the railroad right-of-way, it would run on a northerly tangent under Route 2. Turnback and storage facilities for the Alewife Station would be located in this section extending to a point about 500 feet north of Route 2.

This alignment was selected because it minimizes land takings, business displacements and infringement on the environmentally sensitive lands of the Alewife Brook Reservation while allowing the station platform to be located such that it is equally accessible from the "industrial triangle", to the west, and from the surrounding residential neighborhoods of North Cambridge and East Arlington.

At the Davis Square Station, the trackbed would be about 50 feet below grade. The tunnel floor would then rise and would remain at 25 to 30 feet below ground to the Alewife Station. Tunnel construction costs would be minimized at these depths.

From Alewife to Route 2 the alignment would be at a maximum depth of approximately 32 feet, allowing adequate cover between the tunnel section and Alewife Brook.

### Station

Entrances to the below grade Alewife Station will be located at both ends of the station platform, which is 440 feet in length and 35 feet in width.

A head house will be constructed at the east entrance, just west of Russell Field and north of Lehigh Metal Products on what is now vacant land owned by W. R. Grace, Inc. There will be a pedestrian underpass under Alewife Brook Parkway to the bus platform and garage. Although planned as a free standing entrance, the east entrance could become an integral part of any new development or redevelopment of the W. R. Grace property. The east entrance would be used primarily by persons walking in from North Cambridge, especially residents of Jefferson Park and Rindge Towers, and by employees of W. R. Grace or persons connected with any new development that may occur on the vacant property. The east entrance would also provide excellent access to the Russell Field complex.

The west entrance will be the main entrance to the station and serve most of the park-and-ride, kiss-and-ride and bus patrons. The west entrance will be located in the parking garage, with the lobby being one level below grade. The station platform is east of the lobby and two levels below grade. Stairways, escalators, and elevators connect the platform to the lobby and then to the bus loading/unloading and parking facilities above. This west entrance would also be connected by walkways and pathways to working and shopping destinations at Alewife, facilitating easy access for rapid transit users.

Handicapped and elderly patrons have access to the station platform via elevators at the west entrance which would be accessible via the pedestrian underpass from the east.

### Bus Handling Facilities

All bus loading/unloading will occur at ground level beneath the upper parking garage levels. Escalators and stairways will provide quick access from the bus platforms to the station lobby and platform. The station will have 12 bus berths and a peak hour capacity for 55 to 64 buses.

### Parking Garage

The proposed parking garage at Alewife Station will accommodate approximately 2,000 park-and-ride vehicles and staff parking spaces for 50 to 100 vehicles. The structure itself would be approximately 630' x 324', with five levels. The garage would have an expansion capability of 1,000 parking spaces and two levels.

Kiss-and-ride facilities will be located at ground level and would consist of free and possibly short-term metered spaces. Park-and-ride spaces would be provided on the upper levels.

### Proposed Transit Turnback and Lay-up Facilities

Outbound of the Alewife Station an additional parallel track and crossovers will provide turnback capability and an initial lay-up capacity for 36 Red Line cars. The three track tunnel will extend to a point about 500 feet beyond Route 2.

The three track tunnel would be approximately 48 feet wide outside-to-outside of walls and the roof would typically be about 12 feet below grade level. A yardman's lobby would be located in the tunnel near the Alewife Station.

## B. CONSTRUCTION CONSIDERATIONS, METHODS AND IMPACTS

Cut-and-cover construction will be utilized for this section of the project. Intersections at Cameron Avenue, Cedar Street and Massachusetts Avenue will require decking during construction to permit the uninterrupted flow of vehicular and pedestrian traffic.

Where construction underpasses Alewife Brook Parkway, a short by-pass roadway would be constructed on an earth embankment and bridge adjacent to the Parkway. The temporary detour will permit uninterrupted traffic flow while a section of the station and a pedestrian underpass is constructed and the original roadway is restored.

Tunnel construction under Route 2 will be accomplished without disturbing the roadway. An existing highway bridge spans the tunnel alignment and it is anticipated that underpinning techniques will support the bridge piers during tunnel construction.



Cut-and-cover construction between Alewife Station and Route 2 will require temporary relocation of Alewife Brook, Little River and Yates Pond outlet prior to excavation. Once the box section for the tunnel has been completed and covered over, these waterways can be relocated to their original channels.

It is possible that the railroads (Freight Cutoff Branch) may not be abandoned prior to the start of construction. In that eventuality, the railroads would be relocated within the existing right-of-way in most locations. Due to the existing Route 2 Bridge and the narrow right-of-way, the railroad relocation will infringe on the Alewife Brook Reservation.

There are several utilities along the alignment that will be affected by the cut-and-cover tunnel. It is proposed that most utilities can be supported over the tunnel or relocated within the same area. Some of the major utilities include: 48" x 52" combined sewer located parallel to railroad right-of-way at Davis Square; 345 Kv PTC power lines belonging to Boston Edison at Thorndike Street, Somerville; at Massachusetts Avenue-Cameron Avenue-Cedar Street area, 20 inch gas, 24 inch storm drain, electrical ducts, 15 inch sanitary sewer, 32" x 36" combined sewer, 24" x 32" combined sewer; a 30" x 41" combined sewer at Montgomery Street; at Alewife Brook Parkway, 345 Kv PTC Boston Edison power lines; at Rindge Avenue Extension 48 inch combined sewer; 36 inch storm drain at Freight Cutoff; 23" x 33" combined sewer at Freight Cutoff and Lexington Branch; 66 inch MDC Alewife Brook conduit and 54 inch inverted siphon across the Alewife Brook Reservation; and 26 inch high pressure gas line at Route 2.

The alignment's close proximity to Route 2 and Massachusetts Avenue would permit easier materials handling for this phase of tunnel construction. The Fitchburg Freight Cutoff right-of-way could be utilized for a construction access road to facilitate the movement of construction equipment and the removal of waste materials to and from Route 2 and Massachusetts Avenue.

Slurry wall construction has been selected using the slurry walls as the permanent tunnel and station walls for the majority of the construction. The wall will provide soil retaining support during construction, support adjacent railroad and haul road operations, and also function as a ground water cutoff wall in most locations in this area of high ground water. The varying soil conditions along the 6,800 foot long cut-and-cover length will provide five unique conditions which must be addressed.

Adjacent to the Davis Square Station the tunnel depth of 50 feet will extend the slurry wall through a glacial clay deposit to the glacial till over rock. A deep sand trough exists in the soil profile as the tunnel progresses westward. Next the tunnel will bottom out in a material which consists of stratified sands and clays. Pump tests have indicated these stratified materials have small vertical permeability and relatively higher horizontal permeability of ground water. The area where the station and garage complex is located is underlaid with a very soft sensitive "quick

clay". The material is more sensitive than the typical Boston blue clay commonly found in the area. The sensitivity is very high (in excess of 20) with natural water content between 35 and 45 percent with an undrained shear strength (from field vane shear tests) averaging 900 psf.

Beyond the station to the north the tunnel rests on a clay which is relatively soft but not to the degree of the "quick clay".

The unique physical characteristics of the "quick clay" led to additional geotechnical investigations which included actual field installation of slurry wall test panels and included numerous tests (including load testing a full size panel to failure) in order to provide the designers and prospective contractor with data results which will allow a more definitive design and also a better understanding of its performance both during construction and for long-term station support.

Cut-and-cover construction from Davis Square to Alewife/Route 2 and construction of the Alewife Station complex would occur simultaneously over a period of approximately 3 years.

Temporary decking and construction staging would be required where the project alignment passes under Cameron Avenue, Massachusetts Avenue and Cedar Street. In the Alewife Station Area, maintenance of traffic on Alewife Brook Parkway will be of major importance. Timing of this project with the proposed Alewife roadwork will determine construction staging.

### C. NEIGHBORHOOD AND COMMUNITY FACTORS

Determination and assessment of the project's impact on the neighborhoods through which it passes is of primary concern. Evaluation must consider the project's effect on the character, appearance, and quality of life of the neighborhoods.

As proposed, the Red Line Extension from Davis Square through Alewife passes through the North Cambridge Neighborhood in Cambridge.

The North Cambridge Neighborhood is bounded by the Somerville line on the north; Porter Square on the east; the Arlington-Belmont line on the west; and by the MBTA Fitchburg Main Line on the south. North Cambridge contains approximately 480 acres of land in a mixture of residential, commercial and industrial uses. Most of the industrial uses are concentrated in the westernmost part of the neighborhood and are physically separated from the residential sector by the Alewife Brook Parkway. All residential areas are concentrated east of the Parkway and are further divided into subneighborhoods by man-made barriers such as Massachusetts Avenue and the Fitchburg Freight Cutoff; these barriers have not lessened the strong social and community unity which has developed over the years in North Cambridge.

The use of local, neighborhood streets by contractors will be either eliminated or minimized under strictly controlled specification.

#### D. OPEN SPACE AND HISTORIC RESOURCES

Two open space areas are located along the alignment from Davis Square to Alewife, one of which is public parkland. No significant historical structures are found in the vicinity of this section.

##### Russell Field

Russell Field is a 9.8 acre recreational park in northwest Cambridge, bounded by Clifton Street, Rindge Avenue, and the W. R. Grace, Inc. complex.

Russell Field offers football, baseball, basketball, and unorganized recreational activities for high school activities and all age groups. The facilities include a football field with bleachers, scoreboard, and goal posts; a quarter-mile cinder track; a baseball diamond; tot-lot; a small parking area; and a locker room building.

An agreement between the City and MBTA will permit use of Russell Field as a construction staging area.

##### Alewife Brook Reservation

The Alewife Brook Reservation can be described in terms of two contiguous areas. These areas are:

Alewife Brook Reservation East - This area includes the Alewife Brook Parkway corridor. It includes the Yates Pond area, bound by the Parkway, Route 2, and the Boston and Maine Lexington Branch and Freight Cutoff.

Alewife Brook Reservation West - This area includes the Little Pond, Little River and the associated open-space areas west of the Alewife Brook Reservation East. This area is bound by the Arthur D. Little property on the north, the Freight Cutoff on the south and Belmont residential areas on the southwest and west.

The total area of the Alewife Brook Reservation (East and West combined) amounts to approximately 124 acres.

#### E. ALTERNATE CONSIDERATIONS TO SLURRY WALL CONSTRUCTION

Soldier piles with timber lagging and steel sheet piling alternatives were compared with the slurry walls for the various soil conditions and situations. The benefits of the more rigid slurry wall providing the temporary soil retaining support and the permanent structure wall along with the underpinning and ground water cutoff benefits led to the selection of the slurry wall for the tunnel sections. One location where

soldier piles with lagging is recommended is at the Massachusetts Avenue intersection where the three intersecting streets have numerous utilities which cross the tunnel construction. Augered piles are to be used to avoid the need to drive piles for the full depth.

The deposit of "quick clay" requires response to the stability of an open excavation and a heave problem. These problems are adequately addressed by an appropriately designed slurry wall and construction procedure.

#### F. COSTS

The total amount of slurry wall construction in the 6800 feet of tunnel and station comes to approximately 560,000 square feet of wall. This presently is to be built in five contracts--four tunnel contracts and the station contract. The estimated construction cost is anticipated to be about \$34 or \$35 per square foot for the tunnels and about \$39 per square foot for the station.

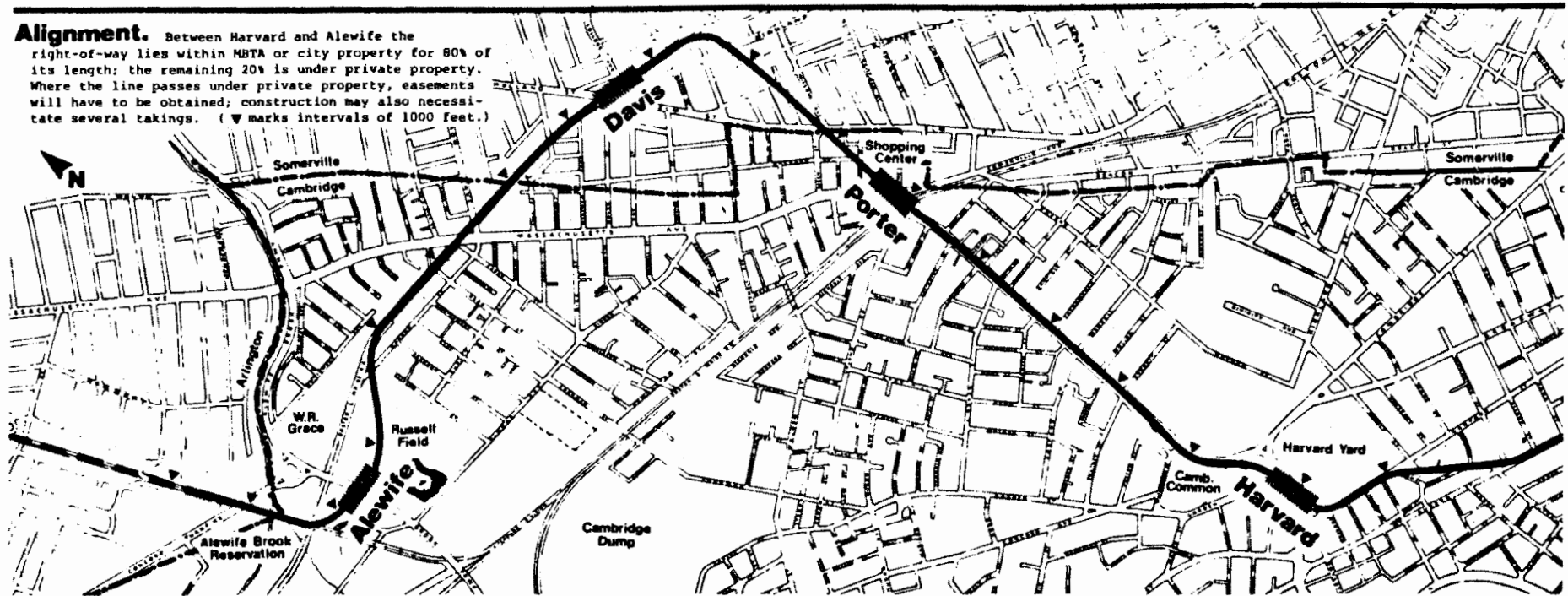
#### IV CONCLUSION

In conclusion we can see that many interesting and unique engineering problems are encountered in the MBTA Red Line Extension project. Slurry wall construction does provide an answer to many of the concerns relating to the temporary and permanent needs of tunnel and station construction. Slurry walls provide an excellent means of protecting adjacent buildings, railroads and haul roads to avoid other means of underpinning. They provide the soil retaining support during construction and also serve as the permanent structure wall. In addition they provide ground water cutoff thereby greatly reducing or eliminating dewatering requirements.

I wish to acknowledge the assistance and direction provided by the Massachusetts Bay Transportation Authority and the Urban Massachusetts Transportation Administration. I thank you for the opportunity to present this report to you.

# Red Line - Harvard to Alewife

**Alignment.** Between Harvard and Alewife the right-of-way lies within MBTA or city property for 80% of its length; the remaining 20% is under private property. Where the line passes under private property, easements will have to be obtained; construction may also necessitate several takings. (▼ marks intervals of 1000 feet.)



**Profile.** The tunnel enters bedrock about midway to Porter Square and leaves it just east of Davis, near Grove St. The cut-and-cover segment begins at Davis Square Station. At Harvard and Porter the track is on two levels. (The vertical scale is exaggerated X 10; actual inclines never exceed 4% or 1' rise in 25' length.)

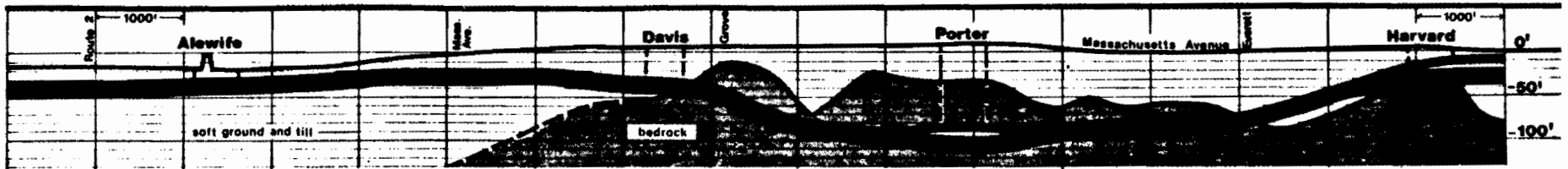


FIGURE 1 RED LINE - HARVARD TO ALEWIFE

**Scope of ground support:  
Slurry walls; soldier piles, and lagging**

In order to protect nearby buildings and minimize construction noise and disruption, slurry walls will separate new construction from existing foundations. Where proximity of buildings is not a problem, soldier piles and lagging will retain the earth.

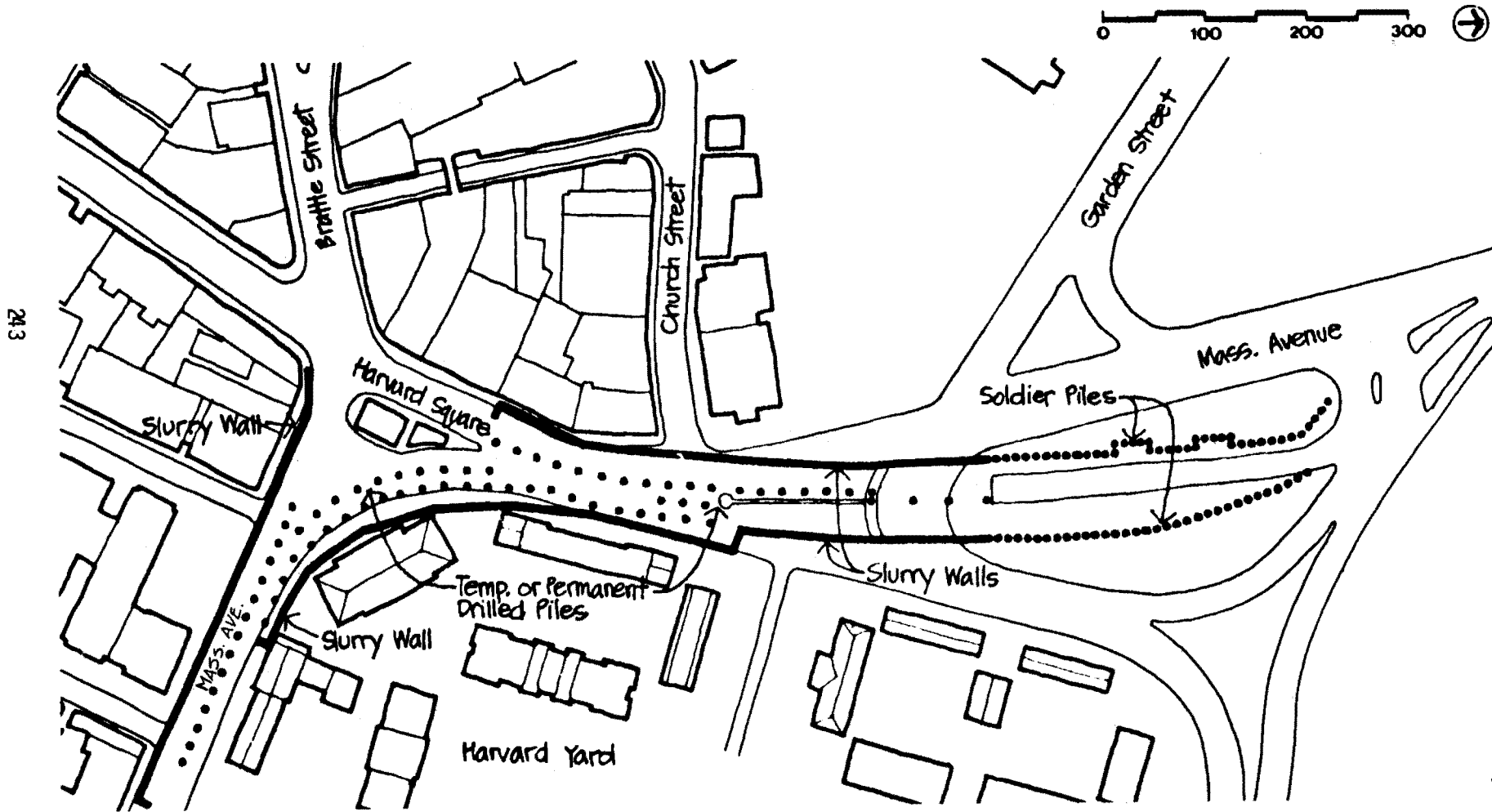


FIGURE 2 HARVARD SQUARE STATION

Mass. Avenue

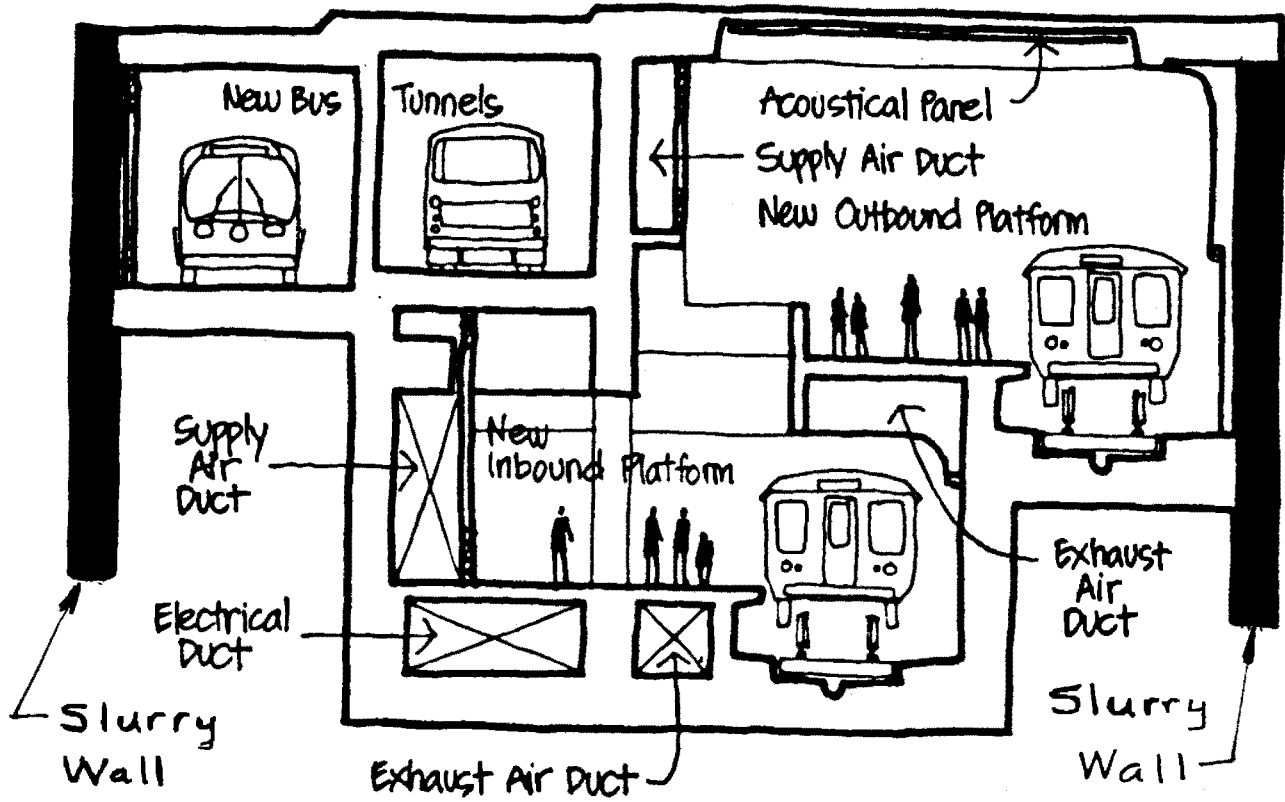


FIGURE 3 HARVARD SQUARE STATION, SECTION THRU TRAIN PLATFORMS



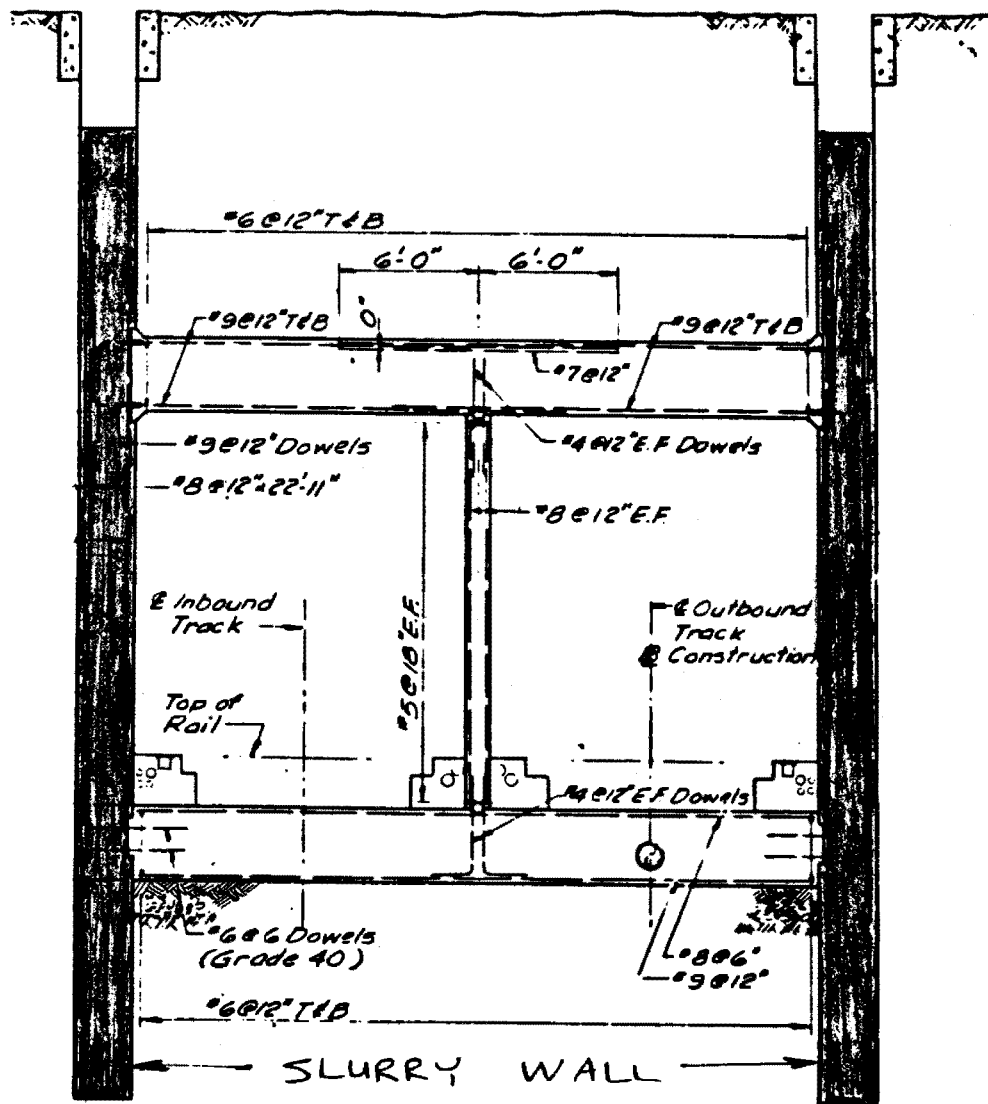


FIGURE 4 DAVIS TO ALEWIFE TUNNEL, TYPICAL SECTION THROUGH TUNNEL

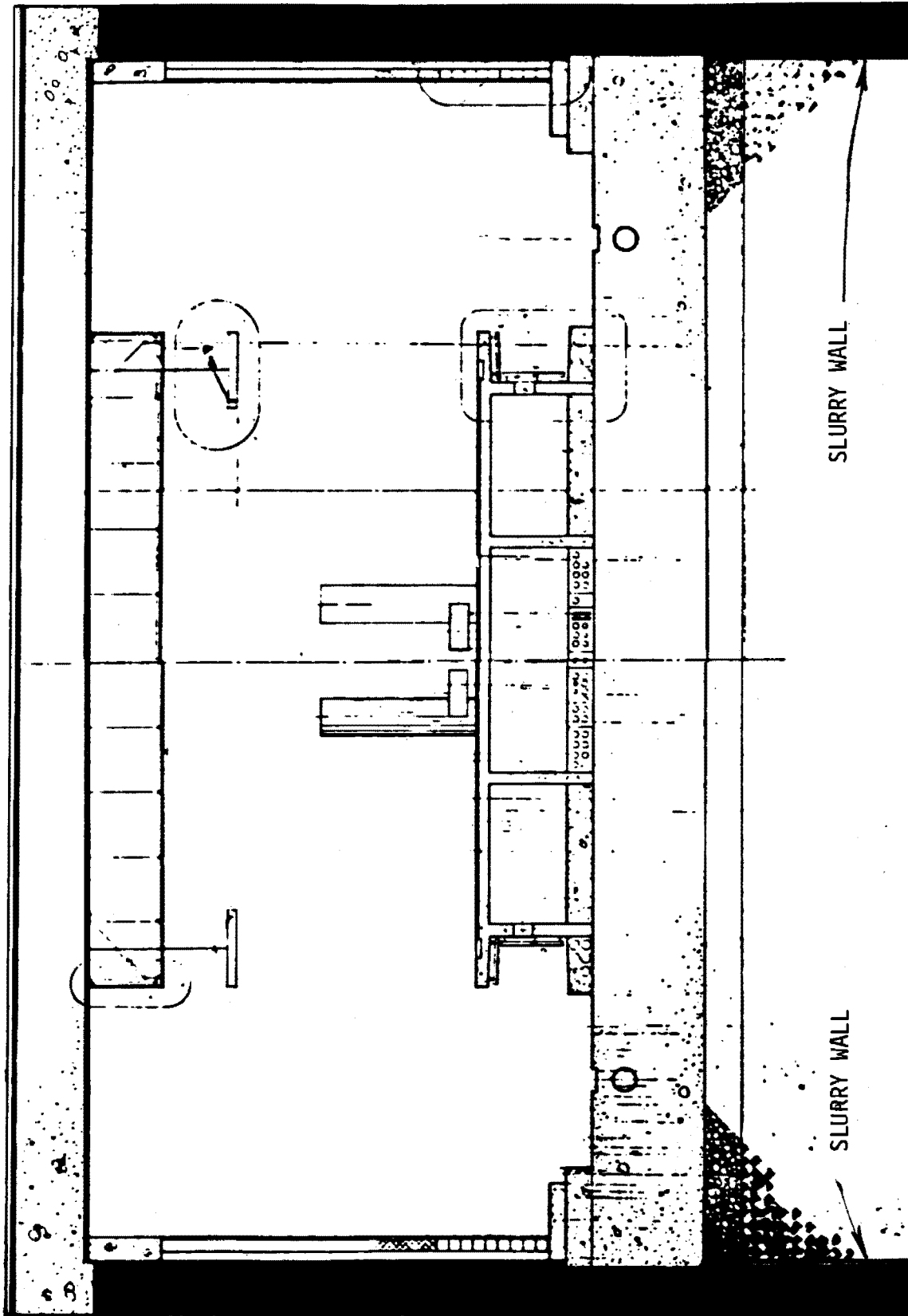


FIGURE 5 ALEWIFE STATION, TYPICAL SECTION THROUGH PLATFORM

SPEAKER: E. J. Perko  
Sverdrup & Parcel and Associates, Inc.

Joseph Minster  
Dames & Moore

Question:

Is the work now at Harvard Square Station going according to schedule?

Perko

Answer:

I am not sure exactly where that schedule stands. I think that from the anticipated schedule, it may be lagging a little behind that. I would have to refer to the representative of the MBTA to address that.

Minster

Question:

Approximately how many months were allowed for the completion of that slurry wall?

Perko

Answer:

For the slurry wall only? There again I believe the total construction of the station with all of the interconnections is going to take something over a period of five years. The slurry wall work itself would be the earlier part of that. So I think the slurry wall work should probably be completed within the next year.

Thomas Hill  
N.Y. City Transit Authority

Question:

At the Harvard Station, you have the slurry wall on three sides, using the slurry wall as a permanent structure and also as a means of underpinning the adjacent buildings. You have mentioned that there will be instrumentation. What will the instrumentation be to indicate the possible movements of adjacent structures? And what are the limits of movement before a standby procedure is applied. Also, what would the standby procedure be?

Perko

Answer

Here again we do not anticipate that we are going to have any severe concerns or problems.

Perko  
(Cont'd)

Again, I think that the concerns for the refinements of the exact specifications ... (I do not have those numbers available, but if you see me during break, we will see if we can get that information and have it made available to you).

# STRUCTURAL CONNECTIONS IN SLURRY WALLS

by

PETROS P. XANTHAKOS  
PETROS P. XANTHAKOS, LTD. - CONSULTING ENGINEERS  
CHICAGO, ILLINOIS

## ABSTRACT

In the past several years construction joints and structural connections have undergone major changes and continuous modifications, and it appears that this evolution will continue. No attempt should be made to "freeze" a technique which is likely to remain in the stage of development for many years to come, and it is evident that modifications in the design, detailing and construction of joints and structural connections are forthcoming. Thus, this paper will attempt to present a summary of common types of joints and connections, on a provincial basis.

Joints between adjoining wall panels must satisfy certain requirements. Thus the joint must not physically disturb any poured panels, it should not leak, it should not distort or deform, it should not disrupt the structural integrity of the structure as a whole, and it should, where necessary, transfer shear, moment and axial tension.

Structural connections to adjoining members such as slabs, beams and the like, commonly must transfer shear, direct tension and bending moment. Important in this respect are also shear connectors in composite walls. Such connections can be made by bending bars into the member to be connected, by locking devices, by a combination of plates and structural shapes, or by using bonding media to affect the adherence of one member to another.

This paper will review methods and current practices for the design, detailing and construction of joints and connections which satisfy these requirements.

## STRUCTURAL CONNECTIONS IN SLURRY WALLS

### INTRODUCTION

The use of efficient joints and connections for the transfer of shear, axial load, and bending moment from panel to panel and from panel to another member has become a common requirement in slurry wall construction. Joints and connections affect directly the structural integrity and performance of the finished structure, and therefore their design and construction must be adequate and compatible with the difficulties inherent in this type of work. Construction joints and structural connections have been reviewed in "Slurry Walls" (Xanthakos, 1979). The purpose of this paper is to summarize the current state of the art and further suggest methods particularly for moment connections, and also for shear connections in composite walls.

### CONSTRUCTION JOINTS IN WALL PANELS

The design and detailing of panel joints must recognize the field difficulties involved in their execution. For example, physically a joint should not disturb a previously poured panel, and it should accommodate the excavation of an adjacent panel but without restricting the type of equipment. On the other hand, the joint should not collect slime or bentonite since this will affect its watertightness. Finally, the construction of a joint should be feasible by simple methods, and should be executed at a cost compatible with the economics of the project.

#### Types of Joints

A very common and relatively simple type of joint is shown in Figure 1. This is the so-called round-tube or interlocking-pipe joint. The semicircular end is formed by means of a steel tube inserted as a stop for the fresh concrete. Some time after the start of the pour (usually 2 h) the pipe is gently rotated to break any bond with the concrete. When the pour is completed but before the concrete begins to set, the tube is extracted leaving a half-round concrete key at the end of the unformed panel. This is used to guide the excavating tool as construction continues, but it also serves to lock adjoining panels against lateral movement. Evidently, any deviation from the true vertical alignment of the completed panel is introduced to the next panel and must be corrected with the next equipment pass. In general, the outside diameter of the tube should be the width of trench, and thus some difficulties may be experienced when inserting the pipe if the trench is not sufficiently straight.

The round-tube joint accommodates panels excavated with rotary drilling equipment or with round-end clamshells. It can transfer lateral shear, but cannot sustain longitudinal bending moment since there is no continuous reinforcement through it. If cavitation or overwidth excavation occurs at the end, or if the tube is used in conjunction with a square-end clamshell, the fresh concrete may bypass and flow around as shown in Figure 2.

If this happens, the hardened concrete must be broken with chisels and removed as the adjacent section is excavated, and this can be a time-consuming and expensive operation. If such concrete rings remain in place, they can force the excavating tool out of alignment and result in a defective panel.

A modified round-tube joint is shown in Figure 3. A round steel plate and a corrugated plate are attached to the cage, as shown, and serve to separate the fresh concrete from the round tube. The extraction of the tube does not depend, therefore, on the hardening process and setting time of the concrete, and thus the device is useful for avoiding stuck-pipe problems. The teeth of the corrugated plate provide suitable interlocks and improve resistance to seepage flow provided bentonite and other impurities are not trapped there.

For composite steel and concrete panels, the joint shown in Figure 4 is often used. The steel I beam can be used independently, particularly in panels excavated with square-end clamshells, or in conjunction with the round tube. In either case, care should be taken that concrete does not leak to the other side of the beam web.

#### Joints to Transfer Axial Shear

Such a joint is shown in Figure 5. This detail allows the horizontal reinforcement to be extended from one panel to the next. Usually, therefore, the joint is located near the center of the panel or away from the ends. Essentially, a steel plate is welded to the cage, and provides a barrier for the fresh concrete. Chemical textile sheets (usually vinylon) surround the ends of the cage and the bottom, and increase protection against leaking concrete. The horizontal reinforcement passes through holes in the plate and it is spliced with the steel cage inserted in the adjacent chamber.

Although in principle the detail is relatively simple, its execution requires some previous experience and adequate field control. If the combination of the plate and the vinylon sheet does not isolate the concrete section from the slurry chamber completely and leakage of fresh concrete occurs, the result may be a totally defective panel. This joint is, therefore, recommended under competent technical advice and provided the contractor works under an effective quality control program.

A different type of joint is shown in Figure 6, commonly called RPT joint. This was initially developed for a special project in England by Randel, Palmer, and Tritton, but can be used on a general basis for the transfer of shear. The conventional steel tube is combined with sections of straight web piles attached to the cage and built into the concrete. After the mix is set, the split pile provides a recess at the end of the section into which one of the clutches of the straight web pile protrudes. After the end pipe is extracted and the next panel is excavated, two sections of straight web pile are sunk and interlocked with the web of the first panel. This connection transfers shear and axial tension.

### Keyed and Water-Stop Joints

The double function of such joints is better contact between adjoining panels and improved watertightness. This is done by means of a vertical cavity as shown in Figure 7. One or two keys are created using two smaller tubes with the main round tube. When the concrete in both panels is set, the cavity formed by the key is thoroughly cleaned and grouted. A water stop can be inserted as shown.

### Special Construction Joints

With the exception of the steel-plate joint, the details mentioned so far are normally used in wall construction where the principal reinforcement consists of the vertical steel. If a wall spans horizontally, however, these joints are not effective since they do not provide continuous reinforcement through. For such situations special joints must be used. Even though major specialist contractors have developed and successfully tried such joints, their effectiveness depends on how well they are executed.

In principle, a plain keyed joint can transfer, or resist, a lateral load equal to the shear strength of plain concrete at some critical section. If a joint has a mechanical connector, it will transfer axial load along the wall and considerable vertical load. If steel bars are extended across the joint, they will also resist bending stresses horizontally. In reality, however, in spite of the theoretical adequacy of a joint, its in situ performance and effectiveness depend mainly on workmanship; hence, engineers and contractors are cautioned that the joint is as good as built.

A special detail is the steel-plate-and-casing joint shown in Figure 8. This sequence is intended to eliminate the problems caused when fresh concrete leaks to the slurry chamber with the steel-plate alone. Thus in addition to the steel plate and vinylon sheet, two specially made steel blocks or casings are inserted and fill the slurry chamber as shown. Block A is a barrier that stops concrete from flowing, and it also provides a cavity for the extension of the steel bars. Block B is a second barrier, and as it fits tight into the panel it prevents displacement of the cage toward the slurry chamber. When the concrete is poured, it looks as shown in Figure 8(b). The panel is completed as shown in Figure 8(c).

Joints like the one just described are relatively more expensive than the simple steel-plate joint because of the extra appurtenances and the longer installation necessary. The extra blocks are usually installed using vibrohammers to overcome skin friction. If the latter is unusually large, it may be difficult to extract the boxes.

Major specialist contractors have used the joint of Figure 8 with some modifications. Other special joints to be mentioned in this paper are the casing joint developed by Franki, and the locking box used by Takenaka (XANTHAKOS, 1979).



## STRUCTURAL CONNECTIONS

The use of diaphragm walls in permanent underground structures requires connections to transfer moments and load to beams, columns, floors slabs. These connections directly affect the overall integrity and structural performance, and therefore their design and method of construction must be adequate to ensure the life of the structure. Evidently, economy and practicality require that the strength of the structure should not be governed by the strength of the connections but should be rather measured by the strength of individual members.

In the past, such connections have been made in a variety of ways: by welding steel bars or steel inserts to the main cage; by transferring tensile or compressive stresses by bond or anchorage; by using steel plates and angles to prevent separation of the wall from adjoining members; by using key-type devices; or by using bonding media affecting the adherence of one member to another.

Even though a connection theoretically may appear adequate, its performance and load-carrying capacity should be judged from field experience or by properly devised and performed tests. This part of the paper will review some of the most recent details developed to provide structural continuity.

### Transfer of Moment

Very commonly the transfer of moment between a diaphragm wall and a connecting slab or beam is accomplished by reinforcing bars extended as dowels. The transfer of the corresponding tension by the protruding bent-out bars is achieved by sufficient lap, by welding, or by other mechanical devices. Once the bars are bent to the right position and cleaned, the structural continuity is obtained as in conventional construction. The most critical point is the accurate positioning of the connection bars in the cage to satisfy the construction tolerance and also to minimize the eccentricity of force during its transfer through the connection.

Couplers and other Mechanical Devices. For commercial mechanical devices developed by specialist contractors, performance data are available from manufacturers or they have been developed by private testing. Engineers must, therefore, use judgment to determine the compliance of such data with the governing building codes and specifications, and to set the acceptability level in technical terms. In general, couplers must develop 125% of the specified yield strength of the bar, and sufficient data must be available on resistance to fatigue, stress reversal, dynamic load, long term creep and other special conditions such as effect of bar misalignment. A coupler, used to splice moment transferring bars, is shown in Figure 9.

Tests have been performed to study the performance of high-strength bars spliced with CADWELD couplers subjected to stress reversal of the yield load (Sozen and Gamble, 1967). In these tests two reinforced concrete beams were subjected to 400 reversals of the yield moment of No. 18 bars connected with CADWELD II. After these reversals the beams were loaded to failure. At the yield moment the bars had a calculated steel tensile stress of 55,800 psi, which compared favorably with the theoretical yield stress of 55,000 psi for A432 bars. The yield stress in this case is defined as the point of which the stress-strain curve shows a well defined break. Two main conclusions from these tests were (a) the coupler device was able to sustain the 400 reversals of the yield stress in the bars, and (b) after the 400 reversals, a maximum tensile stress of 87,600 psi was sustained in the spliced bar, at which time the bar was fractured at the edge of the splice. This stress was compared to the theoretical tensile strength of 93,800 psi.

Tests have also been carried out to study creep effects. For No. 18 bars, tested about 240 hours (Siess, 1966), the conclusion was that no creep occurred at an average bar stress of 20,000 psi and a minimum properties splice. These bars had some eccentricity that might have increased the maximum bar stress by 10 to 20%. Even though the investigators had no way of knowing how much the shearing stress in the filler metal was increased due to this eccentricity, it was assumed that it was higher than in a concentrically loaded splice. For bars subjected to a higher stress, some creep probably occurred, due partly to the eccentricity and partly to local high stresses. Thus at an average stress of 30,000 psi, the average strain increased by 2%, whereas at an average stress of 35,000 psi, the average strain increased by almost 5%. This creep was considered insignificant, and it appeared to have occurred in the first few hours of the test from which it can be concluded that it would be the maximum creep for an infinite duration of loading. For exposed bars such as those used in the tests, strains of this order and magnitude should not be larger than those expected due to variations in the modulus of elasticity of the steel or due to variations in the cross-sectional area of the bar. However, for bars encased in concrete, the transfer of stress from the concrete to the bar would involve also creep in the concrete and this would further increase the elastic strain in the bar. Since these tests involved large-size bars, the conclusions obtained therefrom should be considered limited. For smaller size bars (smaller than No. 9), there is some suspicion that creep might occur even though it still may be structurally insignificant.

Other tests on creep in CADWELD bar splices reported by Ebert (1967) involved specimens at ambient temperatures. These tests concluded that at ambient temperatures the couplers are as resistant to creep as the unspliced bar for all practical purposes, provided of course the installation procedures are adequate and the devices are free of structural defects. The bars used were No. 9 intermediate grade, tested up to 260 hours with stresses of 25,000, 30,000 and 35,000 psi but without the benefit of supporting concrete. Even though it was recognized that a limited time program of several hundred hours does not represent the time frame normally encountered in creep behavior, this time was sufficient for the occurrence

of first stage creep, the transient creep behavior which always precedes the regular state creep. Thus, at ambient temperatures, the absence of first stage creep will normally ensure the absence of second and third stage creep.

Coupling devices similar to those tested above normally would not be expected to undergo strains associated with long-term creep, at least at normal temperature and under the usual stress conditions. However, further tests are indicated in the author's opinion to study creep in splices encased in concrete and with a bent bar radius as close to the splice as the case actually is in the field.

Bar Misalignment with Voids in Coupling Splices. Under the normally accepted tolerance in diaphragm wall construction, misalignment or angular distortion can occur in any of the patterns shown in Figure 10. For the CADWELD splices, the maximum cocking (angular distortion) of the bar in a splice and the maximum eccentricity are shown in Figure 11 and 12, respectively.

Tests conducted on No. 14 and 18 bars Grade 60 using T-series Cadweld splices gave strengths exceeding the 90,000 psi ultimate load. Again, the tests were carried out in air environment and without the effect of concrete encasement. If, however, the same bars were encased in concrete, the performance of the splice would have been improved as bending forces would be absorbed by the set concrete rather than by straightening of the bars, and this would tend to offset the effect of eccentricity.

The results of these tests are summarized in Tables 1 and 2 (Pittsburgh Testing Laboratory, 1968), and evidently the effect of misalignment is practically absent.

Welded Splices. In general, codes permit welded splices subject to appropriate provisions and requirements. The ACI code requires that a full welded splice shall have bars butted and welded to develop in tension at least 125% of the specified yield strength of the bars.

The decision to specify welded splices should be made with regard to steel weldability and proper welding procedures. Reinforcement which is to be welded should be so indicated, and welding procedures should be specified. In general, ASTM specifications will govern, and material properties will conform to welding procedures specified in AWS D 12. 1-75. It should be noted that ASTM A 706 steel has been developed specifically for welding, having a restricted chemistry plus maximum carbon equivalent so that supplementary requirements are in this case not necessary.

Welded splices have been used in diaphragm wall construction but at a cost which often is too high. For isolated cases, such as wall-to-beam or wall-to-strut connections, welded splices may still be deeper.

Heat Bents. Very commonly, bars intended as dowels are initially inserted and anchored in the wall as shown in Figure 13. The front area is blocked by styrofoam or other suitable material. When the wall

is exposed, this material is removed and the bars are bent usually at ambient temperatures. A lap splice is thus provided with the bars of the horizontal member. Considering, however, the lap splice length required for bars under current codes and especially for Class C splices, this connection is often impractical and uneconomical. Alternatively, short cantilever slabs, wall brackets, and the like, can receive bentout bars in a practical and efficient manner as shown in Figure 14.

The bending process is facilitated if it is done after the bars are heated to an optimum temperature. The effect of heating on the amount of work necessary to accomplish bending is shown in Figure 15, where this work, expressed as bending moment, is related to the bar temperature as well as to bar diameter. Evidently, the larger the bar size the greater the work necessary to bend the bar. For practical purposes, there is a convenient temperature for each bar size, at which the bar can be bent manually using a pipe. Heating can be applied at the initial bent of the bar as it is assembled with the cage, and then to restore the bar into the connecting member and provide the lap splice. Alternatively, only one of these two stages uses heating, while the other is done at ambient temperature.

The effect of heating on the bar strength and performance is not fully known; neither is the effect of changing the point of bent along the bar. Certain interesting results have, however, been obtained from individual tests in connection with actual field projects. In one of such tests, both these effects were studied using Japanese deformed bars Type 3 SD 35, 22 mm - diameter, and at a temperature of 400<sup>0</sup>C. The results are summarized in Table 3.

In these results, type 1 is the basic deformed bar tested without bents at ambient temperature, and then used for comparison. With the exception of types 6 and 7, the average yield and tensile strength for all other types is about the same with very minor deviations. In particular, comparing type 1 and 3 to type 2 and 4, the strength characteristics of the bar remain unchanged and the effect of heating is absent. Evidently, a restoration point other than the point of the original bent should be avoided, irrespective of heating or ambient temperature. Restoring the bars without heating may encounter certain difficulties since it is not easy to do this exactly at the point of initial bent, and this can make the bar brittle. On the other hand, heating may make the bar lose some of its ductility, while it makes restoring easier. Thus, for this project, type 4 process was eventually selected.

### Transfer of Shear

Wall-to-Slab Connection. For nominal shears, the transfer may be accomplished as shown in Figure 16. The vertical connection plate is made continuous, and is attached to the cage. The connection angle is welded to the plate after the wall is exposed. On the slab side, the strength of this connection is measured by the shear strength of concrete at a critical section or by bearing on the horizontal leg of the angle. On the wall side, bearing along the underside of the vertical plate should be ignored because of possible accumulation of bentonite there, and the shear is transferred by means of the anchor bars.

The allowable shear, based on extended bars and dowels is given by

$$V = A_s f_s \cos \theta \quad (1)$$

where

- V = total vertical shear in connection
- $A_s$  = cross-sectional area of bar
- $f_s$  = allowable steel stress
- $\theta$  = angle between direction of shear force and extended bar

As an example, No. 9 bars spaced at 12-in, centers and 45° angle have a shear capacity  $V = 1.00 \times 24 \times 0.707 = 17$  kips per linear foot of wall, which is adequate for normal conditions.

Wall-to-Beam Connection. Effective connections of this type have been made by means of steel bearing plates or angles combined with anchor bars. Details for such connections are shown in "Slurry Walls" (Xanthakos, 1979), and they will not be repeated here.

### Composite Walls

When the wall thickness in the final structure differs materially from the wall thickness required during excavation, or where other conditions dictate, the composite wall shown in Fig. 17 is used. Part (b) of this figure is more advantageous over the detail shown in (a), but it requires suitable shear connectors to join the two walls together. The loads, hence the corresponding shears, acting on the composite section are loads applied after the exterior wall is constructed and also any loads representing long-term changes and adjustment in the earth stresses.

Connection with Shear Studs. A composite wall can be made as shown in Figure 18. The anchor bars are attached to a steel plate and the entire assembly is incorporated into the cage of the diaphragm wall. When the wall is exposed, the surface of the plate is cleaned, and shear studs are welded to it as in conventional construction, usually one stud opposite each anchor bar. The shear studs project into the formed portion of the composite wall.

The spacing, size, and configuration of the studs depend on the shear transfer requirements, or the allowable shear may be determined from the shear capacity  $V$  of each stud. This is given by the expression

$$V = 110 d^2 f'c \quad (2)$$

if  $h/d$  is equal to or greater than 4.2, or by the expression

$$V = 27 hd f'c \quad (3)$$

if  $h/d$  is less than 4.2, where

- V = shear transfer capacity per stud, lb
- h = length of stud, in
- d = stud diameter, in

Connection with Deck Plate. Several specialist contractors in Japan have developed and successfully executed their own connection details for composite-wall construction. Such a detail is the so-called deck plate shear connector, initially embedded in the cast-in-place exterior diaphragm wall and eventually having anchor bars protruding into the interior formed wall.

The usual thickness of the forming plate is quoted as 1.6 mm or 1/16 in. Once the walls are tied together, the plate performs no other structural function; hence, the above thickness has been selected to withstand deformation and distortion during handling and also during concrete placement. The shape and dimensions of the forming plate are shown in Figure 19a. The angle  $\theta$  is made  $40^\circ - 45^\circ$  when the plate is placed horizontally as shown, and  $60^\circ - 70^\circ$  if the plate is vertical. The arrangement of the steel bars on the recess of the plate usually is as shown in Figure 19b. The bar spacing should normally be greater than 17.5 cm (7 in) and the end distance greater than 15cm (6 in) for butt welding.

The forming plate is fixed to the reinforcing cage and held secured with a bracket or by welding. When the detail is set horizontally both top and bottom ends of the plate are attached to the cage as shown in Figure 19c. The anchor steel bars pass through holes made in the plate, and they are bent and spliced with the bars of the main cage. On the outer side, the anchor bars protrude some 7 to 7.5 cm (2 3/4 to 3 in), which is the normal clearance from the face of the cage to the face of the trench. The recess is then filled with material such as styrofoam.

After the excavation is carried out and the wall is exposed, the plate surface and the protruding bars are cleaned carefully to remove dirt or any other residual material. The bars of the main structure (interior wall or slab) are then butt welded to the protruding bars.

## References

- Xanthakos, P.P., 1979: Slurry Walls, McGraw-Hill, New York  
Sozen, M.A., and W.L. Gamble, 1967: "A Report," University of Illinois, Urbana, Illinois  
Siess, C.P., 1966: "Creep Testing of CADWELD Splices," Talbot Laboratory, Urbana, Illinois  
Ebert, L.J., 1967: "Creep in Bar Splices," CASE Institute of Technology, Cleveland.  
Pittsburgh Testing Laboratory, 1968: "Effect of Bar Misalignment on Bar Splices," Cleveland.

Table 1 - Results of Tensile Tests, Misaligned #18 Bars, Grade 60

| Specimen No. | Sectional Area, Sq. in. | Max. Load, Lb | Tensile strength psi | Type & description (Reference to Fig. 10)                                      | Fracture pattern          |
|--------------|-------------------------|---------------|----------------------|--|---------------------------|
| 1            | 4.00                    | 395,000       | 98,750               | (b)-Bars in line and parallel. Off center with center of sleeve. Touching I.D. | Bar pulled out of sleeve  |
| 2            | 4.00                    | 385,500       | 96,400               | (d) Bars parallel, but both off center. Within 1/16" of sleeve I.D.            | Bar fracture              |
| 3            | 4.00                    | 389,500       | 97,100               | (a) Bars cocked to maximum Both touching sleeve I.D. Bars in same plane        | Bars pulled out of sleeve |
| 4            | 4.00                    | 402,500       | 100,600              | (a) Bars cocked to maximum Both touching sleeve I.D. Bars in same plane        | Bar fracture              |

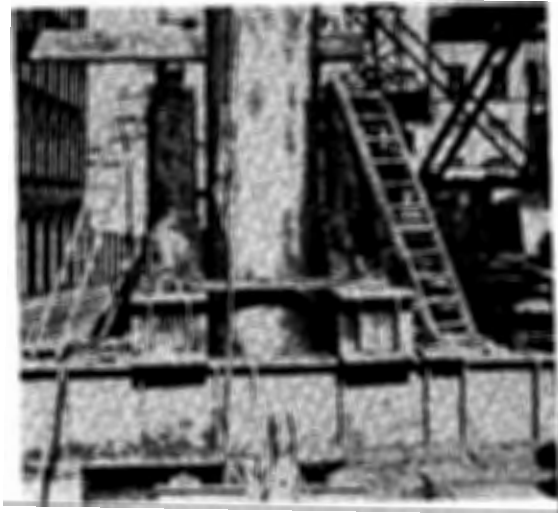
Table 2 - Results of Tests, Misaligned #14 Bars, Grade 60

| Specimen No. | Ultimate Load, Lb | Observed Yield | Type & description (Reference to Fig. 10)  | Fracture pattern |
|--------------|-------------------|----------------|--|------------------|
| 5            | 210,000           | 142,000        | (b) Bars in line and parallel Off center with center of sleeve Within 1/16" of sleeve I.D.     | Bar fracture     |
| 6            | 218,500           | 147,500        | (c) Bars parallel. One bar off center of sleeve to within 1/16" of sleeve I.D.                 | Bar fracture     |
| 7            | 210,000           | 141,000        | (d) Bars parallel, but both off center. One bar 1/8" of sleeve, the other 1/16" of sleeve I.D. | Bar fracture     |
| 8            | 218,000           | 147,000        | (a) Both bars cocked. Both bars within 1/8" of sleeve I.D. Bars in same plane.                 | Bar fracture     |

Table 3 - Effect of heating on bar characteristics

| Process type | Sample No. | Yield Strength<br>t/cm <sup>2</sup>    | Tensile Strength<br>t/cm <sup>2</sup> | Elongation<br>% | Remarks   |
|--------------|------------|--|---------------------------------------|-----------------|---|
| 1            | 1          | 3.84                                   | 5.93                                  | 34 (14)         | Untreated, ambient temp<br>Basic Type, No bents                           |
|              | 2          | 3.87                                   | 5.95                                  | 25 (13)         |   |
|              | 3          | 3.79                                   | 5.85                                  | 28 (15)         |   |
|              | Average    | 3.83                                   | 5.91                                  | 28 (14)         |   |
| 2            | 1          | 3.84                                   | 5.93                                  | 34 (11)         | Heated but no bents   |
|              | 2          | 3.87                                   | 5.95                                  | 37 (11)         |   |
|              | 3          | 3.87                                   | 5.85                                  | 14 (11)         |   |
|              | Average    | 3.86                                   | 5.91                                  | 28 (11)         |   |
| 3            | 1          | 3.84                                   | 5.85                                  | 14 (5.2)        | Bent without heating<br>Restored without heating                          |
|              | 2          | 3.69                                   | 5.85                                  | 11 (8.6)        |   |
|              | 3          | 3.69                                   | 5.82                                  | 13 (11)         |   |
|              | Average    | 3.74                                   | 5.83                                  | 13 (8.3)        |   |
| 4            | 1          | 3.89                                   | 5.52                                  | 17 (12)         | Bent without heating<br>Restored with heating                             |
|              | 2          | 3.84                                   | 5.75                                  | 32 (12)         |   |
|              | 3          | 3.89                                   | 5.93                                  | 34 (11)         |   |
|              | Average    | 3.87                                   | 5.73                                  | 28 (12)         |   |
| 5            | 1          | 3.81                                   | 5.85                                  | - (14)          | Bent without heating<br>Restored without heating<br>Point of bent changed |
|              | 2          | 3.89                                   | 6.01                                  | - (15)          |   |
|              | 3          | 3.89                                   | 6.03                                  | - (15)          |   |
|              | Average    | 3.86                                   | 5.96                                  | - (15)          |   |
| 6            | 1          | -                                      | 3.40                                  | - (5.2)         | Bent without heating<br>Restored with heating<br>Point of bent changed    |
|              | 2          | -                                      | 3.74                                  | - (5.6)         |   |
|              | 3          | Excessive deformation. Unable to test. |                                       |                 |   |
|              | Average    | -                                      | 3.57                                  | - (5.4)         |   |
| 7            | 1          |  | 2.19                                  | 2 (1.6)         | Bent with heating<br>Restored without heating                             |
|              | 2          |  | 2.47                                  | 3 (2.2)         |   |
|              | 3          |  | 2.99                                  | 4 (1.7)         |   |
|              | Average    |  | 2.55                                  | 3 (1.8)         |   |
| 8            | 1          | 3.89                                   | 6.0                                   | 24 (12)         | Bent with heating<br>Restored with heating                                |
|              | 2          | 3.84                                   | 5.90                                  | 23 (13)         |   |
|              | 3          | 3.87                                   | 5.98                                  | 26 (13)         |   |
|              | Average    | 3.87                                   | 5.96                                  | 24 (13)         |   |



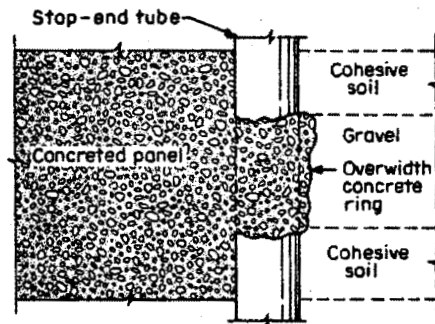


(a)

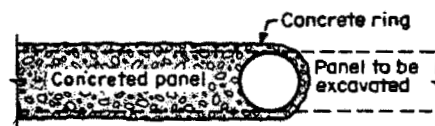


(b)

**Fig. 1** Extraction of interlocking pipe by means of (a) jacks and (b) crane. (Franki.)

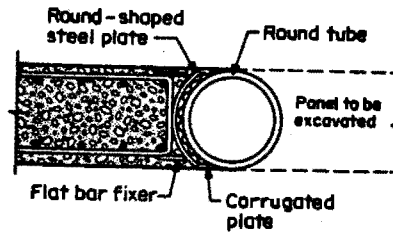


(a)

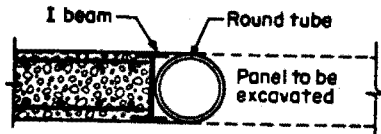
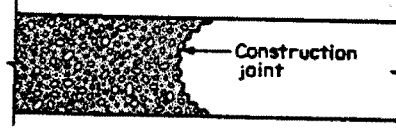


(b)

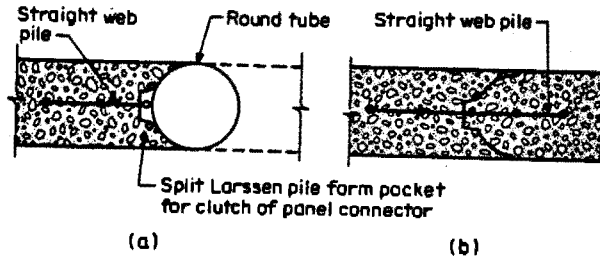
**Fig. 2** Penetration of fresh concrete beyond the stop-end tube due to overwidth excavation: (a) partial elevation; (b) partial section through gravel layer.



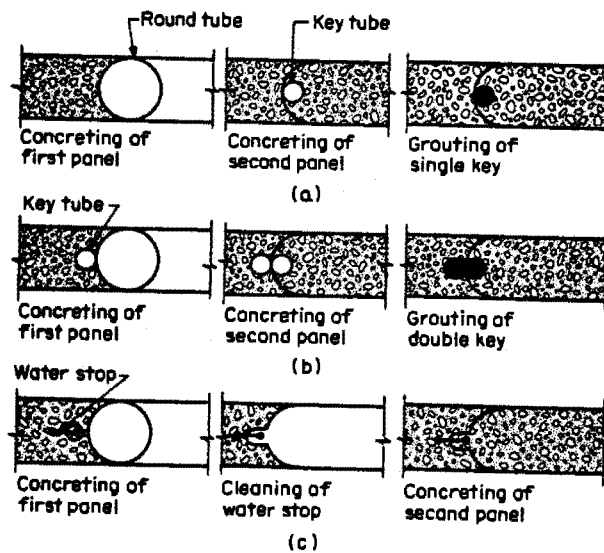
**Fig. 3** Modified round-tube joint.



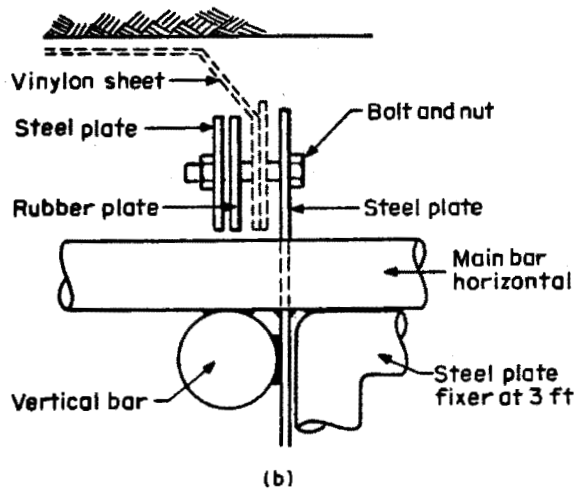
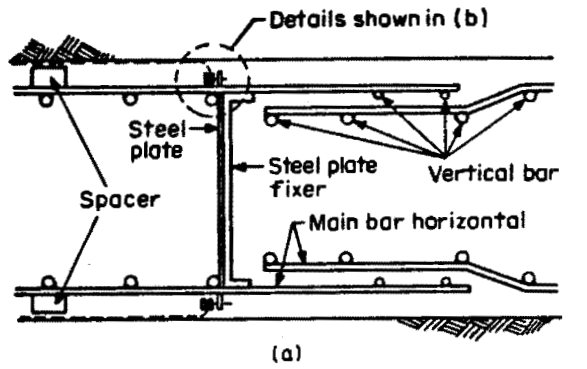
**Fig. 4** I-beam joint details.



**Fig. 6** RPT joint details.



**Fig. 7** (a) Single key joint; (b) double key joint; (c) water-stop joint.



**Fig. 5** Vinylon-sheet and steel-plate joint. (a) General joint detail and splicing of horizontal reinforcement. Note that the interlocking pipe is not shown. Concrete is poured against the vertical steel plate. (b) Detail showing the attachment of vinylon sheet to the steel plate. (c) The reinforcement cage is lowered into the trench; vinylon sheets are extended 3 to 4 ft to prevent concrete from leaking into the next panel.

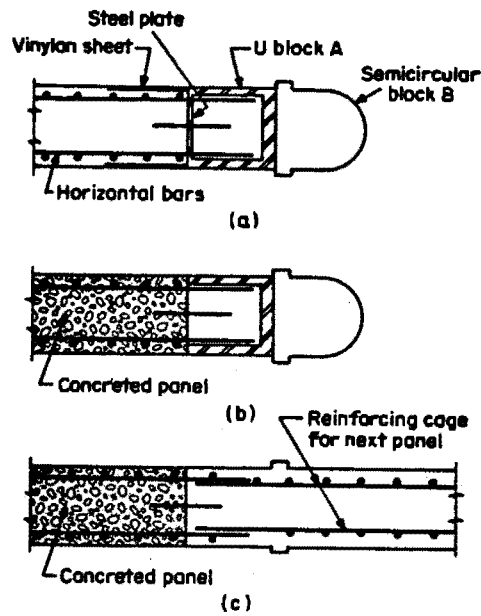


Fig. 8 Construction sequence of vertical joint using steel-plate-and-casing assembly.

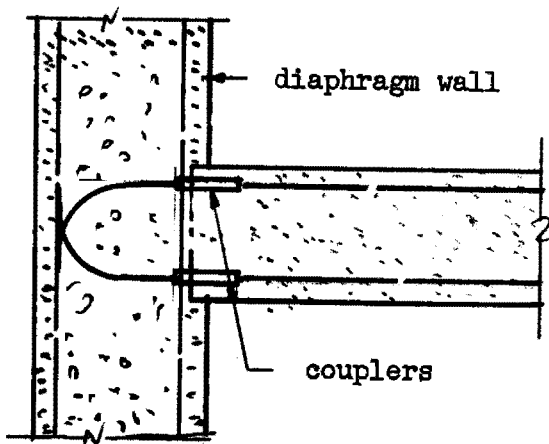


Fig. 9 Coupling devices used to splice bars for moment connection

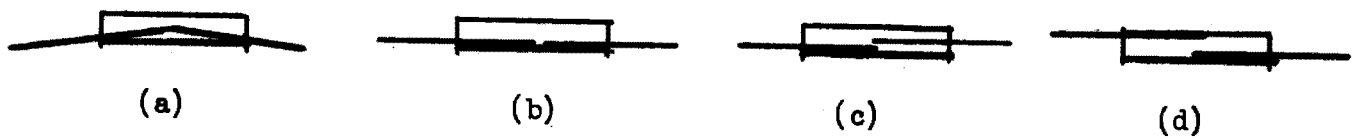
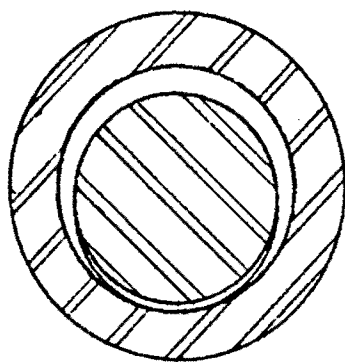
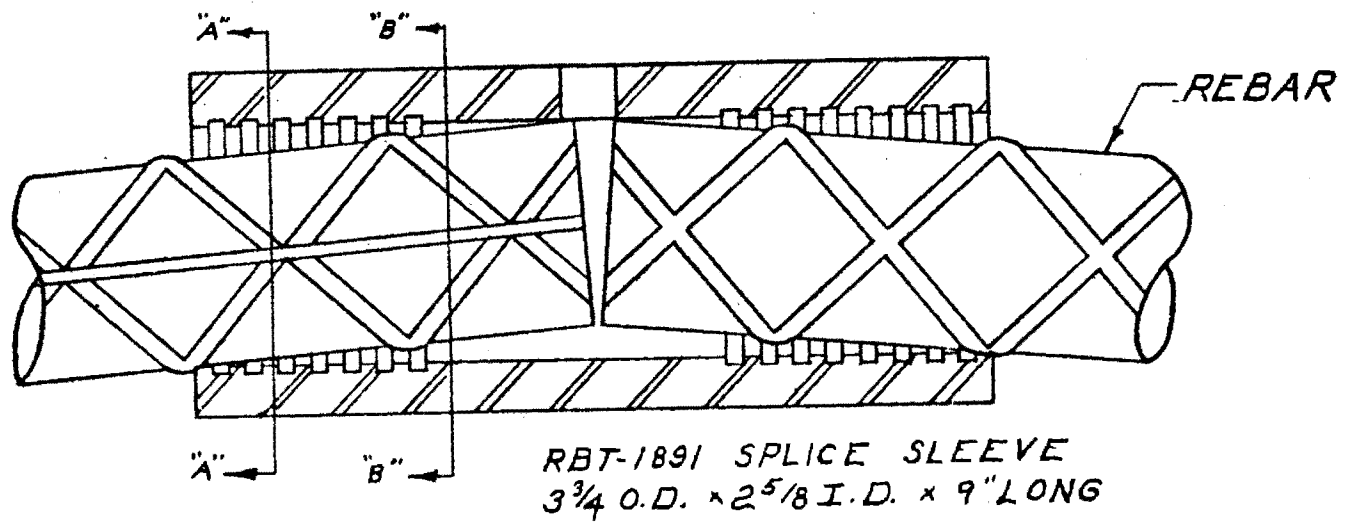
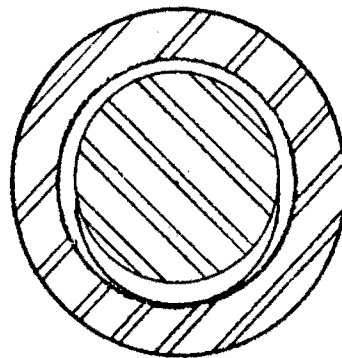


Fig. 10 Misalignment and angular distortion of bars spliced with coupling devices. (a) Bars cocked; (b) bars parallel, but off center and on the same side of sleeve; (c) bars parallel, but one bar off center; (d) bars parallel, but both off center on either side of sleeve.



SECT. A-A



SECT. B-B

Fig. 11 Cadweld splice showing maximum cocking of bar in sleeve.

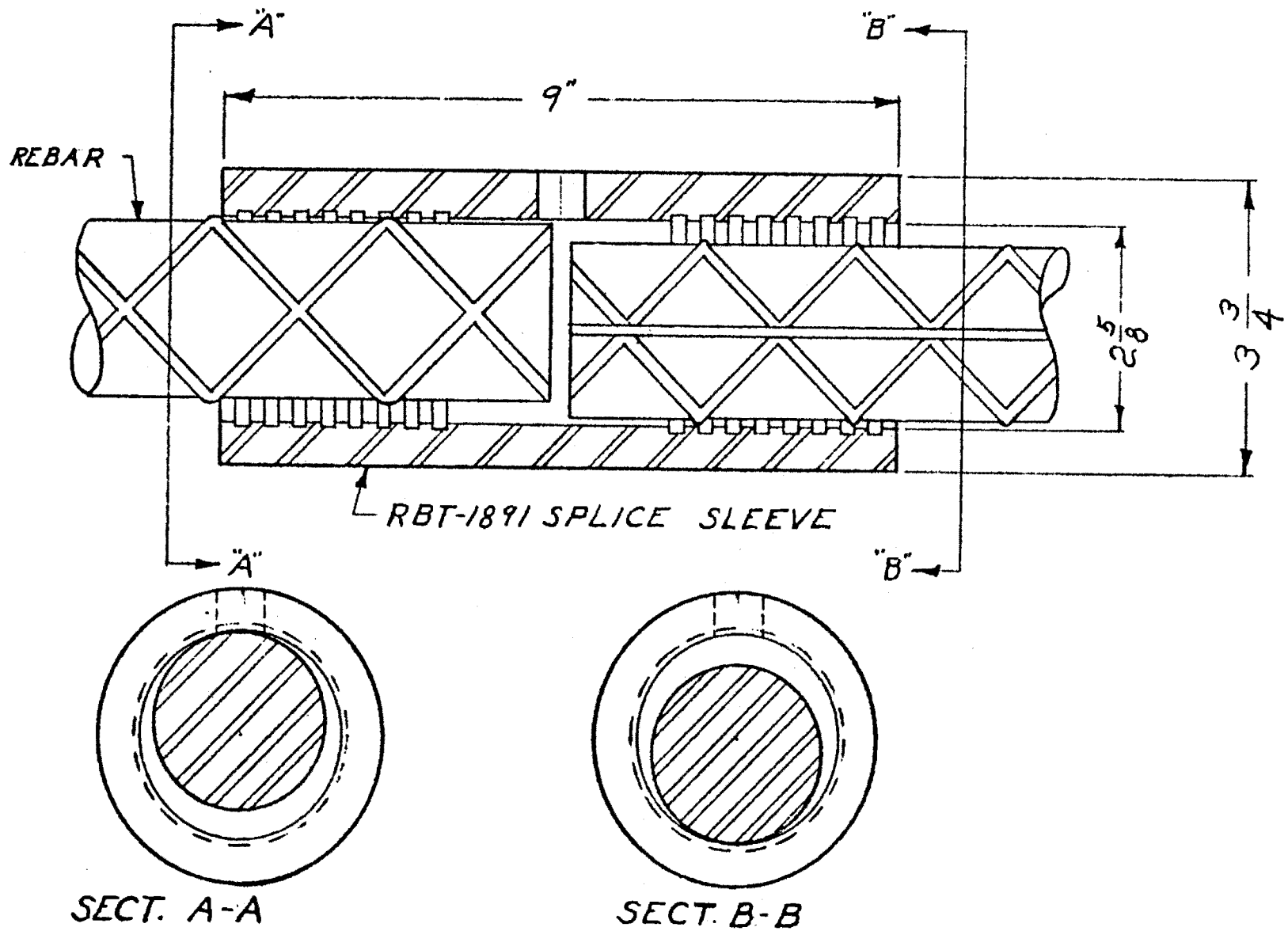


Fig. 12 Cadweld splice showing one bar touching top of sleeve, the other touching the bottom.

Fig. 13 Wall-to-slab moment connection using bentout bars. Area in front of bars is blocked with styrofoam.

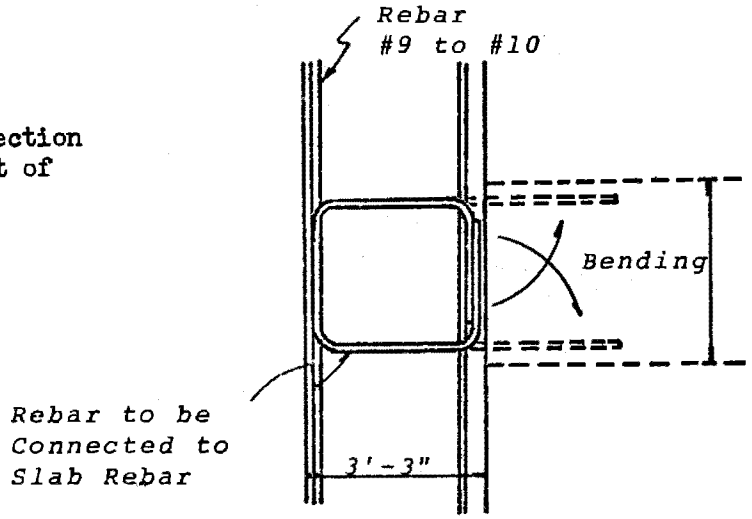


Fig. 14 Bentout bars used in a wall-to-bracket connection.

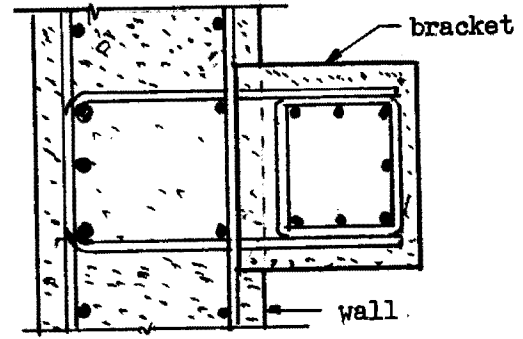
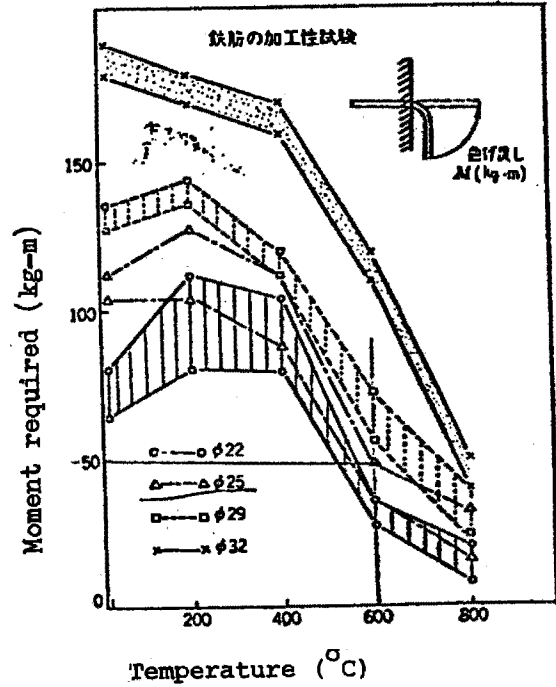
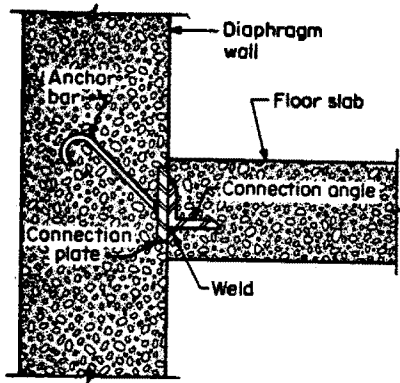
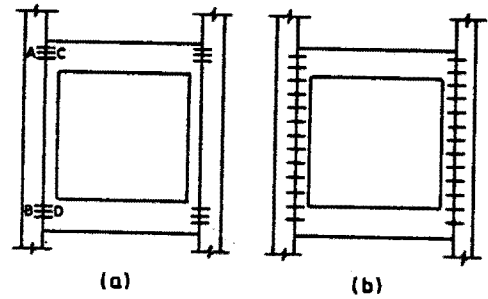


Fig. 15 Work necessary to bend bars at various temperatures.

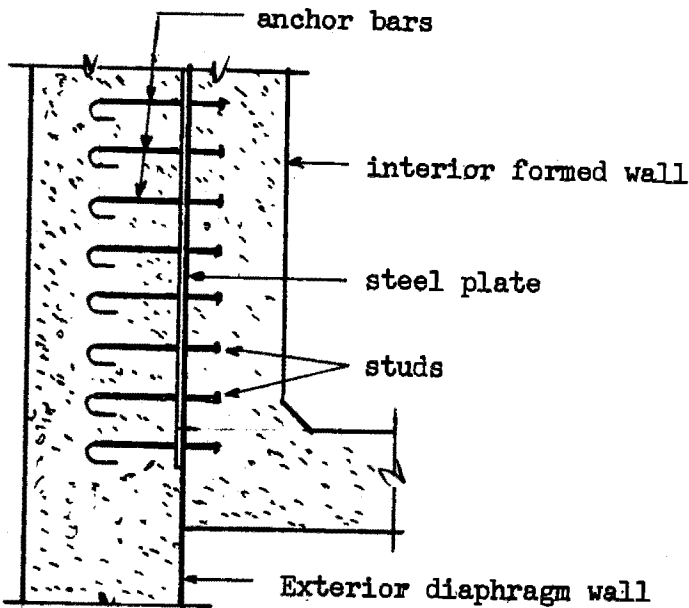




**Fig. 16** Shear connection, floor slab to diaphragm wall.

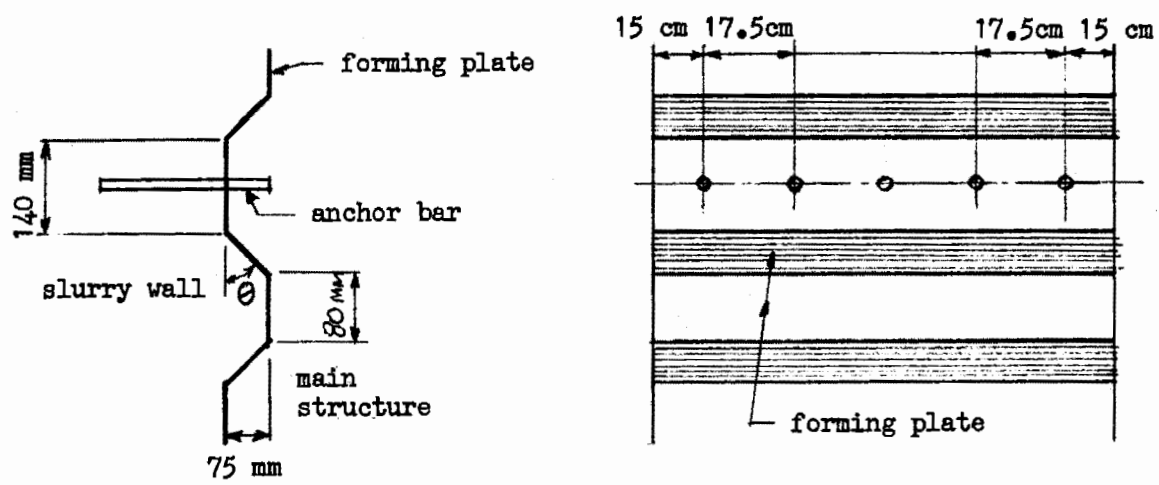


**Fig. 17** Composite box section; in (a) the section becomes integral by connecting the top and bottom slabs to the wall; in (b) the shear connectors extend for the entire height of the walls.



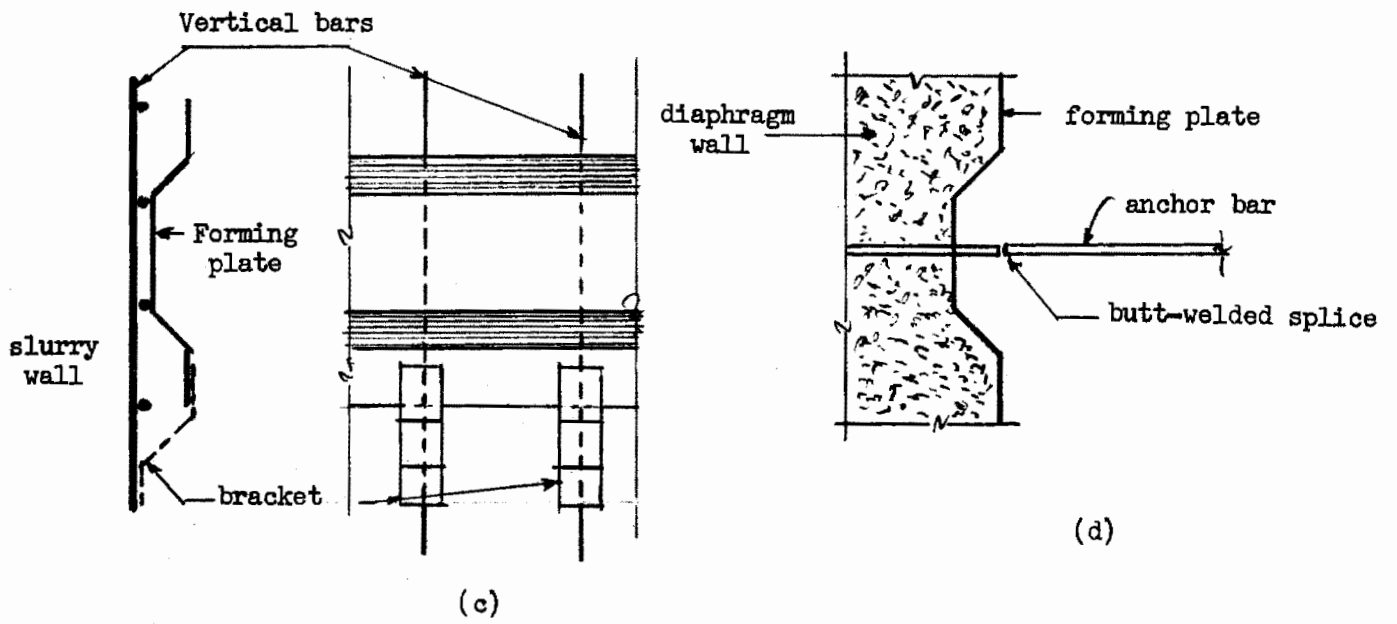
**Fig. 18** Composite wall using anchor bars and shear studs.





(a)

(b)



(c)

(d)

Fig. 19 Deck plate shear connector detail for composite walls.

SPEAKER: P. P. Xanthakos  
Consulting Engineer

Thomas Hill  
New York City Transit  
Authority

Xanthakos

Question:

At the beginning of your speech, you spoke about permanent tiebacks and the study that was going on. I was wondering if they are considering the electrolytic action due to the stray currents of a railroad.

Answer:

Yes, there are studies going on now. There are three forms of corrosion, one is electrochemical which is probably the most common type of corrosion, another is electrolytical corrosion, and the third is a space type of corrosion. I am sure that the investigation will consider all of these types. Also, besides this ongoing program, I can also mention some private work done in the same area, and it will not be long before we have a comprehensive understanding of the corrosion problem in tiebacks.

# ECONOMIC CONSIDERATIONS IN SLURRY WALL APPLICATIONS

by

ARTURO L. RESSI di CERVIA  
ICOS CORPORATION OF AMERICA  
NEW YORK, NEW YORK

## ABSTRACT

The origin of slurry wall construction will be explored briefly and the two main applications of this construction technique will be discussed.

Slurry wall can be used either as essentially a water-proofing structure to impede the flow of fluids from one underground area to another or as a structural component in a foundation scheme. Cost of slurry walls and trenches vary greatly depending upon geological conditions, site conditions, weather conditions, labor conditions, etc. Estimating practices will be explored together with some methods of contracting appropriate to the risk.

Further, the type of client, the magnitude of the job, the status of patents, proprietary methods and availability of specialized equipment will be discussed.

## ECONOMIC CONSIDERATIONS IN SLURRY WALL APPLICATIONS

### INTRODUCTION

Ladies and Gentlemen:

Let me start by remarking that the task I am about to accomplish is a difficult one. Unaccustomed as I am to public speaking I find it very difficult to address an audience for some forty minutes or so without the use of visual aids. Unfortunately, the subject does not lend itself very much to the use of slides, and I will just have to talk and try to hold your interest with words rather than with pretty or interesting pictures.

Before starting the discussion, I want you to understand that I will address myself only to economic considerations as they apply to slurry wall construction and I will not get into any discussion about slurry trenches other than explaining briefly a cost table which includes slurry trench data. In order to familiarize everybody with the terminology, I will define slurry walls as tremied concrete walls built by the bentonite method and composed of a combination of elements whose vertical dimension far exceeds the two dimensions in plan. The resulting walls are used for structural as well as for waterproofing purposes. Their physical characteristics require, and the construction procedure is hinged upon, the use of specialized tools and techniques and demands particular know-how as opposed to slurry trench construction which can be, in most cases, carried out with standard construction equipment.

From this first consideration we then realize that the use of specialized equipment constitutes the first economic factor in the total cost of slurry wall construction, stemming from the use of specialized equipment and by the very nature of this work. We immediately identify as a second component of cost the necessity of employing specialized personnel at least in the supervisory level, and often at the skilled operator level.

Since by no means can slurry walls be defined as a cheap construction procedure, it stands to reason that walls are utilized only when particular site or ground conditions necessitate their use. Once again we can identify as a cost factor both the physical location of the proposed wall and the subsurface conditions. Lastly, the possibility of integrating technical features of the walls into an overall design scheme, which takes advantage of the properties of such walls, give the clue to another important factor: proper engineering.

Having identified these four broad parameters as major components in the cost of slurry walls, we will then have to keep in mind other factors that are common to all kinds of construction: physical location, weather conditions, availability and cost of local labor and materials, rapport

between the contractor and the owner, local labor practices, etc.

In order to better understand the way by which all of these factors come into play, it may be appropriate to review the progress of one idealized slurry wall project from the moment in which it is conceived to its completion. By doing this we will identify all the economic forces coming into play and we will be able to give an order of magnitude to all the various components of a slurry wall price. We shall do this following the most prevalent contracting practice, where the role of engineer, owner and contractor are separate and in some way adversary.

As soon as a consulting engineer realizes that a slurry wall can be the solution to a particular problem, the knowledgeable designer analyzes it by comparing it and other types of construction. A value is placed on its engineering characteristics as applied to the particular problem and "ball park" prices are used to make cost comparisons.

The first obvious consideration which will make a slurry wall system competitive versus other solutions stems from the possibility of making full engineering use of the three key components of a slurry wall: its water-tightness, its loadbearing capacity, and its resistance to lateral pressures. By integrating their characteristics into a design scheme which makes the slurry wall a permanent part of the finished product, the designer can often reach a solution which saves money and construction time.

Consultation at the conceptual design stage with a contractor both knowledgeable of slurry wall construction and with an in-house design capacity will help the designer to take advantage of the latest innovations in the state of the art, since typically the contractor operates on the leading edge of this very specialized and competitive field.

On several occasions the slurry wall construction is performed at the beginning of a given project and it is only in minor ways connected with the subsequent phases of work. It stands to reason that whenever the owner can isolate as a separate entity the foundation work, composed by the slurry wall, by its support and excavation within it, it would be advantageous to him, from a pricing standpoint, to let out this portion of the work as a separate package. Indeed, to have a slurry wall work under the general contractor's umbrella, when the general contractor has not begun its work and cannot provide any substantial service to the slurry wall contractor, will only add a markup to the price of the slurry wall contractor. It is therefore my opinion that in order to diminish overall project costs, whenever such move is possible, the owner should consider letting out the foundation work as a separate contract.

When the desires of the owner, the input from the engineer (as modified by the conversation with the specialized contractor) result in a bid package, the contractor will begin to analyze the various components of the job, as he sees them, in order to prepare a bid price. The first decision he must make, which will condition all his subsequent thinking,

involves a choice of a construction procedure. As you know from having seen different presentations from previous speakers, there are many ways to skin a cat and even more ways to construct a slurry wall: equipment varies, and so do the approaches required by particular site conditions. What must be recognized is that a slurry wall job is basically a construction job founded upon one predominant operation: the excavation of the panels. Therefore the production rate of a chosen piece of equipment into soil is the only great variable in the estimate. Materials are substantially a given quantity and all other costs, equipment labor and supervision, are directly proportional to the excavation site.

Therefore the choice of the appropriate excavation procedure and the correct estimate of the production rate of a given tool in a given soil is the first hurdle that the estimator must face. From the initial choice, all the other components of the price will follow. The estimator, in making his choice, must always balance the use of more sophisticated and specialized equipment which may achieve a greater production versus the use of a simpler or more standard type of equipment which will achieve lesser production, but which will be more economical to use and be of more widespread and constant utilization.

A prime example of this dilemma is the continuing debate between slurry wall construction companies on the use of simple and relatively unsophisticated cable-hung mechanical clamshell versus the use of more expensive and complicated Kelly-mounted hydraulic clamshell, or even the more sophisticated boring machine as manufactured by Mitsubishi of Japan. The views of various companies differ on the subject and I can only say that our company has always believed that a tool less expensive but simpler to use and to repair on the job, capable of being used in many different soil conditions and under all different circumstances is, in the long run, a better tool to have than a more sophisticated but more limited one. Obviously from the choice of the excavating system stems the consideration of the type of personnel to be employed. Once again, more sophisticated equipment may require different types of people with different specializations, and the problem is further complicated by the prevailing attitude of labor unions in certain parts of the country of resistance to the introduction of specialized operators.

Materials, generally speaking, are a constant; except for small variations in the quantity of concrete going into an excavation which is somewhat dependent upon the method of construction. The amount of bentonite to be used on the job will also somewhat depend upon the method of construction and the recirculating techniques. Both of these variables are pretty small and do not play a major role in the ultimate price of the job. Likewise, supervision is strictly related to the duration of the job. When all the job expenditures are totalled up, the time has come to address the problem of the three numbers which have to be added to the costs.

The first number has to do with contingency. Contingency is a very real jobsite cost since foundation work is considered the riskiest segment

of the construction industry and a slurry wall job is possibly amongst the riskiest jobs in foundation work. It is very difficult to express contingency in terms of percentages because it really is a number which we all hope not to use but which, in reality, often makes the difference between a losing job and a break-even one. Every company develops its own policy on the matter; but not to recognize the fact that sizable contingencies have to be provided in jobs of this nature is unrealistic. Nevertheless, it is within the owner's capacity to limit the amount of money the contractor sets aside for contingencies. It can reduce the contractor's risk by putting into the construction contract clauses like the changed condition clause which will entitle the contractor to an equitable adjustment in case of unanticipated subsurface conditions. Likewise, a reputation of fairly administering the contract and the combination of demand for quality, but understanding any real problems faced by the contractor, usually result in lesser contingency being put into the final price.

The next item to be established is the overhead. Here, obviously, there are many variables: the size of the company, its efficiency, its work volume, etc.; but since overhead can be computed on an actual basis it is somewhat meaningless to spend time discussing this cost item. It may only be worth noting that in the overhead items many companies involved in slurry wall construction carry the cost of fees and royalties paid to licensors or organizations who provide special assistance to a company using patented or proprietary processes. These costs are not to be considered an additional burden, because in a free market economy they would not exist unless they meaningfully add to the capacity of a company by allowing it to call upon specialized expertise in particularly difficult jobs, without keeping such costly expertise constantly in-house.

The last item is profit. Profit is a word that certain owners have difficulty in accepting and yet it is obvious that construction companies have an economic reality in which they operate, and profit is the ultimate measure of their success and competence.

Beyond that, another factor must be recognized which few people do. In a field so risky as that of underground construction a specialized company, in order to survive, has to maintain what, for lack of better words, can be called a "war chest". This allows a company to weather a period without sacrificing technical quality or without going bankrupt. From my perspective of fifteen years in this industry, I have witnessed many situations where a company entered the field and disappeared after a few years because they were operating on too low a profit margin; or I have seen companies trying to renege on their obligations, or doing a less than satisfactory job because they were facing financial disaster. I, therefore, believe that a healthy profit margin in this industry is not a luxury, it is a necessity.

Let us for a moment assume that a job has been properly engineered and it has been properly priced as a result of a good analysis of cost, to which a proper margin of contingency overhead and profit has been added. The question is raised as to how should the owner best procure

a job of this nature.

The most common method of procurement in this country is competitive bidding. It is a method exclusively, or almost exclusively, used by all public agencies, and even the private industry uses it extensively with only one little modification: while in a public bid the low bidder gets the job at the bid price, in the private industry a squeeze often happens after the bid which results in a further chunk being bitten out of the bid price.

On the surface this method of procurement seems the fairest and the cheapest. In reality it has several short-comings in our particular industry.

First of all, it fails to discriminate between a good and a bad company insofar as the low bidder gets the job, regardless of its past performance or its technical competence. Before anybody remarks that prequalification criteria and bid and performance bonds are a safeguard against that happening, I would guarantee you that the construction industry is fraught with contractors who have been able to get bid and performance bonds and prequalify for jobs which they really could not perform.

Furthermore, the competitive bid format usually prevents a public owner from fully utilizing the input of a specialized contractor during the design phase, and effectively prevents many private owners from doing it because few contractors will take the chance of spending a lot of time and effort in contributing to the design of a job if they know that ultimately it will be procured on a competitive bid basis.

While I am not advocating abandoning the competitive bid procedure, I do believe that there is more room for negotiation in this type of work whenever the size, the difficulty or the design uncertainties of a project will require a constant effort by the owner and the contractor to modify and redefine the scope of work during the design, and sometimes during the construction phase.

Lastly, there is a quite obvious danger in the competitive bid system when the low bidder has bid too low. Let me once again bore you with a well-known truth in the industry: if a contractor realizes that he has not enough money in his price, the job becomes an unhappy one. Under these circumstances he will try one way or another to diminish his losses by either presenting claims or by cutting the quality, or in any event by being uncooperative and/or difficult to control and direct.

It is therefore not in the best interest of the owner to create such a situation, because an unhappy contractor on the job more often than not causes delays in completion which will ultimately cost the owner more than what he would have paid if he would have negotiated a fair price for the work being performed.



This obviously leads into discussing contract administration - which will not change the economic picture of a given job but will influence the contractor in his bid to the same owner the next time around. It is significant that when an owner, such as the Corps of Engineers, establishes a reputation of administering jobs fairly and of being understanding to the needs of the contractor, it is usually able to get responsive low bids to qualified contractors who vie for the privilege of working for such an owner.

A word has to be said about claims, now an undeniable economic factor in many construction jobs. It stands to reason that if a job is properly designed, the contract is written in a fair way; and if it is likewise administered, the amount of claims stemming from the work is greatly reduced. While nobody can guarantee that a job will be performed without claims, let me assure you that it is bad policy to foster a situation where a contractor feels that the only way he can possibly make money on a job is by constructing not a project but an intricate scheme of claims.

Another factor playing a role in the cost of a job is the cost of money. Cost of money means that the owner in his contract should consider giving the contractor a sizeable mobilization payment and should assure the contractor of timely payments. Furthermore, he should remember that retention money is properly kept to cover the cost of malperformance. It is therefore good practice to assure the contractor that retention will be kept to a minimum and will only amount to what is necessary to cover possible defects in the work performed. Furthermore, it must be recognized that the slurry wall contractors usually perform this work at the very beginning of a project. It would be inequitable to keep their portion of retention until the end of the general construction.

We will now examine a table showing with a certain approximation the price range of slurry wall installation as a function of its depth and soil characteristics.

In closing this speech I would like to remind you that this technique is gaining wider and wider acceptance and the state of the art is changing continually. Better equipment and better techniques become available, and it is therefore gratifying to note that as other types of construction have risen greatly in price, and certain construction methods have more than doubled in costs during the last five or six years, slurry wall construction has generally been growing at a much lesser rate and, in some cases, cost has even remained stationary.

|   | SLURRY TRENCH PRICES<br>IN 1979 DOLLARS |                          |                           | UNREINFORCED SLURRY WALL<br>PRICES IN 1979 DOLLARS |                           |                        |
|---|---|--------------------------|---------------------------|--|---------------------------|------------------------|
|   | DEPTH<br>≤ 30<br>FEET                   | DEPTH<br>30 - 75<br>FEET | DEPTH<br>75 - 120<br>FEET | DEPTH<br>≤ 60<br>FEET                              | DEPTH<br>60 - 150<br>FEET | DEPTH<br>> 150<br>FEET |
| SOFT TO MEDIUM SOIL<br>N ≤ 40   | 2-4                                     | 4-8                      | 8-10                      | 15-20  | 20-30                     | 30-75                  |
| HARD SOIL<br>N 40 - 200   | 4-7                                     | 5-10                     | 10-20                     | 25-30  | 30-40                     | 40-95                  |
| OCCASIONAL BOULDERS   | 4-8                                     | 5-8                      | 8-25                      | 20-30  | 30-40                     | 40-85                  |
| SOFT TO MEDIUM ROCK<br>N ≥ 200 (SANDSTONE, SHALE)   | 6-12                                    | 10-20                    | 20-50                     | 50-60  | 60-85                     | 85-175                 |
| BOULDER STRATA  | 15-25                                   | 15-25                    | 50-80                     | 30-40  | 40-95                     | 95-210                 |
| HARD ROCK<br>GRANITE, GNEISS, SCHIST  | ---                                     | ---                      | ---                       | 95-140   | 140-175                   | 175-235                |
| * NOMINAL PENETRATION ONLY  |   |                          |                           |  |                           |                        |
| FOR STANDARD REINFORCEMENT IN SLURRY WALLS ADD \$8.00 PER SQ.FT.<br>FOR CONSTRUCTION IN URBAN ENVIRONMENT ADD 25% TO 50% OF PRICE |   |                          |                           |  |                           |                        |

SPEAKER: Dr. A. L. Ressi di Cervia  
ICOS Corporation of America

Sol Katz  
New York City  
Transit Authority

Question:

You seem to put the owner in a bad light in the things that you were talking about. When you have a subcontractor acting for a contractor, and the situation is not too amiable? What is your answer when that is concerned?

Ressi

Answer:

First of all, I love owners. Without owners, we have no jobs. I want to dispel that feeling. I was joking. But in reality, our personal experience is that we would much rather work as prime contractors directly for owners instead of subcontractors because we deal much more effectively with the owner sometimes than with general contractors. The big thing is that the general contractor and a specialty contractor have less in common than a specialty contractor and the owner. The philosophy of a general contractor and a specialty contractor are so different that at times it is much easier to deal directly with the owner than with a general contractor. I would rather be a general contractor at any time.

Vincent B. Farrell  
MBTA

Question:

My question is, in regard to the chart, are those unit prices cumulative? In other words, the price of the slurry trench added to the price of the slurry wall?

Ressi

Answer:

No, those prices represent the price per sq. ft. of either the slurry trench or the slurry wall installed with the materials included, and typical reinforcement included. But these are ballpark figures. They're more significant in terms of relative prices than an absolute price on one particular type of construction because the variables are so many that we cannot just take a handbook and say: This job, this soil, this price.

Vincent B. Farrell

Question:

I appreciate that, but where you have a unit price per sq. ft. for the wall, does that include the trench also?

Ressi

Answer:

Yes.

David Jobling  
London Transport

Question:

Would you welcome the contract practice which is fairly normal in Britain where, whether it is by subcontract or main contract, the specialist contractor becomes a nominated subcontractor and usually is invited from a selected list, so that when you go out to tender for the slurry wall work, you would say the subcontract will be considered from the following five contractors.

Ressi

Answer:

It is certainly an improvement over the present practices and it is done to some extent even in the United States. Sometimes there are pre-qualifications required in some contracts. And in some states, it is mandatory that the general contractor identify the main subcontractors when he goes in with his bid. California is one of them, for instance. So it is done here to some extent and it is certainly a good improvement over present practices.

Joseph Minster  
Dames & Moore

Question:

Do you prefer to be supplied with specifications or do you prefer to work on your own?

Ressi

That is a question I can answer, making a case for both sides. Let me tell you my considerations. It is easier to work with specifications supplied to you because you have no responsibilities. You just do what you're told, and if it doesn't work, you throw your hands up and say, Ha! So from this point of view, it would be preferable to be

Ressi  
(Cont'd)

told what to do. In reality, I prefer the possibility of writing our own specifications or working on a performance basis because we can then utilize our know-how and our experience to the best advantage, and I think this is preferable from the point of view of the owners, but I would say the latter case is rare.

## LEGAL ASPECTS OF SLURRY WALL CONSTRUCTION

by

LOUIS CANTOR

GREENBERG, TRAYMAN, CANTOR, REISS AND BLASKY  
ATTORNEYS AND COUNSELLORS AT LAW  
NEW YORK, NEW YORK

### ABSTRACT

Slurry Wall construction raises some unique legal problems not usually encountered in other areas of construction work.

The principal problem is that of design responsibility. The slurry wall serves two distinct functions. It is both a temporary earth retaining structure and an integral part of the permanent structure. The contractor as well as the owner's engineer may contribute in the design or in design modifications. Questions of legal responsibility for adequacy of design to fulfill each of the two functions will depend upon the obligations assumed in the contract documents and the degree each participates in the design process.

Closely related to the question of design responsibility is that of constructability. Subsurface conditions differing materially from those assumed in design may result in excess costs in slurry wall construction or, at the extreme, practical impossibility of fulfillment.

Slurry Wall construction may endanger adjacent structures and may require them to be temporarily supported and protected. The contractor, the owner and his engineer each assume varying degrees of liability to adjacent property owners.

Finally, slurry walls constructed immediately adjacent to public streets and thoroughfares may interfere with existing utilities. Thus, there is the further issue as to respective rights and responsibilities of owner, contractor, and the utility companies for the maintenance and protection of these existing utility structures.

## LEGAL ASPECTS OF SLURRY WALL CONSTRUCTION

Gentlemen, it is an honor for me to speak before an engineering group, because I am extremely impressed by your ability to grasp engineering concepts and the mental organization of your work. I am totally incapable of both these aspects, but I serve an interesting function and a necessary one. I am an intermediary. If you have a problem and go to a law court, and you can advise me and have me understand what you are talking about, then I am capable of telling the judge and the jury and convincing him or them what the case is all about, because the concepts of engineering are very difficult to grasp in one application by a judge or the jury and they have to filter it down through the lawyer. The lawyer serves two other functions. First, he serves the owner. His prime function in this respect is to set up a contract that will exculpate his client from any liability or responsibility that is possible under the contract. His second function is serving the contractor, whose prime purpose is to evade and negate certain contract provisions and to try to get the problem down to a fair solution by common sense and equity, apart from restrictive contractual provisions.

Now I am genuinely in the second category, and I suppose the best way I can describe the methodology of doing the work involved is set forth in a story that was told to me by my partner, Jerry Reese, about the perennial and proverbial threesome, the lawyer, the engineer, and the doctor. In this particular story, they were playing cards. While playing, the doctor said, "You know there's a lot of talk about what was the first profession. We represent the three great professions, and one of our professions was the first profession. Let's put money on the table and see who can convince the others which was the first profession." So they all put their money down, and the doctor said: "I believe I suckered you in because, after all, the Bible says, 'From Adam's ribs, the Lord took Eve,' and this was the greatest surgical act ever performed; therefore, medicine was the first profession." "Not so fast," said the engineer. "As long as you go into biblical reference, let's look at the very beginning. 'Out of chaos, God created the universe.' And this act of creation was the greatest engineering act; therefore, engineering was the first profession." The doctor looked at the lawyer and said, "I think he's got us." "Hardly," said the lawyer, "After all, gentlemen, who created chaos?"

Now engineers, architects, and contractors are also capable of creating chaos in the law courts. And I must give you a relevant illustration. It was the case where we represented the contractor who was to build eight fender cells around a pier of a railroad bridge. This was the last in a series of contracts. The pier had already been constructed and the fender cells had already been built on the other side of the river on a prior contract. The contract was quite specific - it stated that the cells were to be made of sheet piling--circular sheet piling, eight separate cells. The sheet piling was to be driven down 45 feet, the last 10 feet into bedrock that was there. The contract prescribed how it was to be done--the steps to be taken. You go down 35 feet, clear out the mud, then you blast the trench underneath the footing, into which the piling was to be driven.

Now, it was conclusively established at the trial which was held in 1967 in Federal Court in Manhattan that blasting was improper. First of all, the rock was of such nature that blasting might damage the cofferdam because of outside pressure. There was a standstill, and the contractor volunteered a drilling method that didn't work. The contractor then said to the owner, "You come up and design something." The owner refused to do so and told the contractor to design it. There was a deadlock.

The owner completed the job by use of a built-in caisson method under which the sheets were never driven into the rock but the cells were stabilized by the built-in caisson. There was a lawsuit. The contention of the contractor was that this was a detailed specification, it couldn't work, and it was the obligation of the owner to come up with an answer. The owner took the position that the contractor had to come up with an answer, even though the contract said that blasting had to be used and blasting could not be used. The court found for the owner, holding that this was result specification and that the contractor had to come up with a method for stabilizing the cells.

It was an atrocious decision. I think I know contract law as well as anyone else, and this was an atrocious decision. But I couldn't blame the judge because this, in part, was a battle of experts, and we had two of the top experts in the country. The lawyer for the contractor testified that this was a detailed specification. Then he went off to Montreal where he was an honored guest at the opening of the 1967 exposition. And in his absence, the expert for the owner, who was a professor at MIT, I believe, and the leading partner in one of the most prestigious law firms in the country, testified that the work could have been done and that the sheeting could have been driven into the rock. I remind you that it was never driven into the rock by the method eventually used, but that it could have been done. And, he said, one method would have been to put in a second parallel sheet piling system outside the specified one in the water. This had nothing to do with the specifications. Moreover, it would interfere with the navigation of the channel, and that was prohibited under the contract. The second method was relevant. He said that the work could have been done by drilling and the use of a slurry wall technique, which he described.

Now this was in 1967 that the work was done, and the slurry wall technique had not even come into existence here in the United States. However, despite our relevant comments on his testimony, the judge bought it! Now I think this was a classic case of chaoticism on the part of the engineer, and he won the case. Not only did he win it, but the Circuit Court of Appeals affirmed and a petition for appeal to the Supreme Court was denied.

Now I do not tell you this story to impress you with my own inadequacy. I think it is relevant on two grounds. First, personal -- it was my introduction to the concept of the slurry wall -- a rather shocking one. Second, it shows you that no matter what you may know about specifications and engineering requirements and proper liability from an engineering standpoint, judges have a different concept because they are not as knowledgeable



as you are in such matters. Unless some things are in writing in a contract so they can better understand it, or where it is a common sense approach that they can follow clearly, you can't tell which way they are going. In determining what the law is and what the law should be--and in this case, the latter is relevant--you have to consider how a judge and a jury will react.

For a quick example, the Honorable Joseph Conroy was a very capable judge presiding in the Supreme Court of Queens County. He was a large and tough man who, when he sat in his courtroom, did not sit in his chair but on the bench itself, with his legs dangling down, and he ran the courthouse in a cracker-barrel fashion with cracker-barrel comments with rare and sometimes acid wit. He was a very funny man and made most appropriate comments, and found plenty of time to do so. We had a case with him one time - a contractor claiming delays, extra work, etc. He adjourned the case to his chambers. He said to the contractor, "You know what your case is all about, tell me what it is. The man was claiming \$60,000. And for ten or fifteen minutes the contractor went on and on and made a very good exposition of his case. The judge said, "I buy that, you make sense and you have established that you were damaged \$60,000." He said, "You know why I buy that? Because you are talking about a construction case, and there is very little I know about construction cases. I know very little and you are the expert, and because you are the expert, I must follow what you tell me." And then suddenly he said to the contractor, "But, mister, you are not involved in the construction work here. You are involved in a lawsuit, and when it comes to a lawsuit, I am the expert and I say it is worth \$30,000. The case was settled for \$30,000.

The issue is, your business is a very complicated business and to convince a judge is a very difficult thing. Now I say a judge rather than a jury because generally this has to be interpreted from the contract and the interpretation of a contract is a matter of law that is in the hands of the judge, unless there is just too much ambiguity. So the first thing that must be remembered is when you write a contract, it must be specific, it must state where the liability lies and the corollary that the other party does not have the liability for a certain portion of the work. In the old days it was simple enough, the architect ruled supreme, he designated the job and he supervised it. But more recently there are modern techniques and speciality contractors. The law becomes a little incoherent and unclear when you are dealing with the passing of liability back and forth for individual operations. I would say that the one thing to remember is that equity is and should be paramount in the formulation of the law. It was in the old days that the architect was responsible for everything he did and this continues but is being knocked out gradually. In specific cases, by nature of the work involved and the primary element that goes into equity, which is that of superior knowledge, who has superior knowledge in the aspect of the work under question. With respect to a third party, there is no doubt as to liability. The third party can collect from the architect, he can collect from the contractor, from the owner.

An interesting case was one in Arkansas in 1960 which involved workman's compensation. The contract said that the contractor was responsible for safety and not the architect (very specific). The contractor's employees were hurt. They could not sue their employer so they sued the architect. The court held that the safety requirement which excluded the architect's responsibility was superseded by a provision that the architect was to supervise, and since he was to supervise, the contract clause which excluded his liability no longer held. So third parties have no problem, and I don't think that we are involved with that except as it comes down to the ultimate responsibility because in third-party suits, if the third party was injured due to failure (that can be the owner) and sues the architect or contractor, then the architect and contractor can sue one another, based on the negligence. Here there is a doctrine in negligence. (In New York it is called the Doe vs. Dow theory, involving the Dow Chemical Company). The courts held that when you get down below the first tier into the ultimate liability, the jury can determine the percentage or proportion of liability, and therefore it comes down to a very common sense determination which a jury can make as to who is responsible, the owner or the architect. Of course your contract provisions will be applicable in that the jury may see that the architect's original responsibility was turned over to the contractor. So what we are really interested in here is the relationship between a contractor, an owner, and an architect. We can almost knock out an architect with respect to the contractor because in New York and many other jurisdictions there is no privity between them, so the contractor, if he sues, cannot sue the architect but has to sue the owner, who is responsible for the acts of his architect. And in other jurisdictions they allow direct suits by a contractor against an architect, and I think that they will be a growing thing just as direct suits grew against manufacturers.

But right now, let us deal with a suit between a contractor and an owner because of an architect's fault. Here again, it gets to a point where you have to classify something very specifically. If one man is to have the responsibility, it should be stated in the contract that he has that responsibility. A judge who is making the determination can interpret a contract, and the contract should be written for a judge to interpret (this man has the responsibility, the architect has none) because it is not his specialty. The architect, even in his contract with the owner, should specify that he will not have responsibility for that aspect of the work. Of course, this can go just so far. An architect cannot just get out of his responsibilities too easily, particularly where he has superior knowledge. It comes down to what is known as a detailed specification as opposed to a result specification. A detailed specification is self-defining. The details of how the work is to be done are in the specifications. The contractor is to follow them and if he follows them, there is the inherent warranty that it will work, but if it doesn't work, the designer is responsible. The result specification is different, and there is a definition of it. It is one where the contractor has contracted to produce the ultimate design objective by application of his own skills and by construction methods of his own choice and has thereby assumed the risk of achieving the end result

and must bear the consequences of any difficulties encountered in doing so. And that's the unique provision, particularly where it's a big contract, because you cannot really bid a contract of that sort. So when you're dealing with governmental authorities, they are severely limited in their right to put out the result specification and it is not found too often. And when it is found, it must be clear; it must be clear where the responsibility lies.

However, now we're dealing in closer territory. We're dealing generally in an area where there is a detailed specification which encompasses a limited result specification. We come down to a matter of temporary support. A temporary support is a form of performance actually, and the responsibility can be placed on the contractor. Of course there are always if's and but's to any situation. Suppose the contractor is given the responsibility for doing something that he must use a subcontractor for, and suppose it is specified that the design of the subcontractor is subject to the approval of the architect. Then I would say the contractor has the right to rely on the architect's approval of a specialized subcontractor. It's a matter of superior knowledge.

Of course, then there is a case (one in point) where you have the slurry wall, where the contractor is really the specialist. In such cases, where temporary support is concerned, particularly where there is a good contractual specification placing the responsibility on the contractor and he is specialty contractor in slurry wall, then he is responsible. An interesting thing, just to show how this goes, suppose - to make sure that the contractor is responsible under the contract - the contract tells him to hire his own engineer, which is a good thing to do to make sure the architect will not be responsible. Then I think there's little doubt that the contractor who hires his own engineer must rely on his own engineer. Suppose, however, on the other hand, that the contract doesn't say that but the contractor does hire his own engineer, then we'll have two separate situations--one contractor hires his own engineer and the other doesn't. Doing the same work, is one contractor to be more responsible than the other? Not under contract terms, because the contract terms leaves open in the first instance that the architect, if he has the responsibility of supervising and approving the plan, can still be responsible to the contractor, depending again on the nature of the work and the specialization involved. And when a contractor stamps his approval and says that it is only a limited responsibility and that he doesn't guarantee that it will work, it is understood that this is a limited responsibility and that the contractor does not guarantee his work.

When we come to the question of slurry walls, we have something special because the slurry wall is both a temporary structure and a permanent structure. I think that basically that difference is most important. As a temporary structure, it may be used for the purpose of eliminating underpinning in an adjoining building. It may also be used as a temporary support for the excavation and construction of tunnels for a subway or railroad. In such cases, the specialty contractor would be responsible that the temporary use of that installation is proper. Of course, he is always responsible that the performance of the work is proper. We're

talking now about design. Normally at this time a slurry wall is done by a combined design-contracting firm which is another inroad in the old theory that the architect is supreme. There the contractors come in as designers as well as contractors. This may not always be so. Slurry walls, as they develop, may be done also by contractors who are not design specialists but who follow specifications. But insofar as they are now the product of the design-contracting firm, it assumes the responsibility that the walls will work for the purpose intended, the temporary support subject to one further exception. In doing this work, of course, and in establishing the temporary support, subsurface information which is known to the owner or the architect must be given to the firm. If the owner has that information and doesn't give it to the firm and there is a failure because of an unusual subsurface condition, about which the slurry wall firm was not advised and of which it had no knowledge, then the liability would be passed over to the architect on the grounds that there is a contractual fraud. It's not really fraud, but the failure to give information is called contractual fraud. In this case the responsibility goes over to the owner.

Now we come to the permanent installation. Here the slurry wall is integrated into an overall structure which was designed by the architect. It may be a foundation wall which is supporting a large structure. Here, because it is so new, we must be more judgmental instead of historical on what the law would be. My impression is, at first blush, that the architect is responsible if there is a failure on the permanent wall operating in its permanent condition. The architect has the responsibility of hiring a consulting engineer. He would then have a claim against his consulting engineer, but the owner would be responsible. That's why sometimes if you're in a lawsuit you see so many names in the pile, because one firm is claiming over another until the ultimate liability is determined. When it's a matter of contract, it would be determined absolutely; one or the other is responsible. When it's a matter of negligence and the proportionate theory in *Doe vs. Dow* prevails, the ultimate liability may be dispersed amongst many. (I am dealing with contractual liabilities where there is a failure and the contractor has the responsibility. Does he have to rebuild it? And if he does rebuild it, does he have a claim over it? If he doesn't rebuild it, does the owner have a claim against him?) A determination would then have to be made if the failure was the result of the pressures on the wall (stresses and forces on the wall) created by the entire structure, or whether it failed in and of itself and therefore was not sufficient. This would be for a tunnel too because when you build the supporting walls for tunnels, there is the invert and cover of the tunnel that is placed upon it, and you may also have the forces by the trains going by. Those design techniques are the responsibility of the architect and structural engineer. If the architect gives to the slurry wall contractor the responsibility of building a wall to a certain strength, then the slurry wall contractor's obligation is only to build it to that strength. Even though the architect may approve it, may stamp it, this doesn't eliminate the slurry wall contractor's responsibility to build it to that strength. But if that strength proves to be insufficient by reason of the integration of the slurry wall into

the entire system, that becomes the fault of the designing engineer, and that's where the responsibility would lie. Coming down from the old common law principle that the architect is liable for everything because he is supreme, an architect at this stage cannot even give up his basic responsibilities. When you are getting into specialization, yes, he can. But he cannot just generally say, "You design the wall that will support the 80-story building that I'm placing upon it." That he cannot do. He cannot say, "You design the wall that will eliminate underpinning and act as a temporary support."

In summary, I wanted to tell you that the slurry wall brings to bear, actually, the fact that the law is changing from what it was, and must change, because the slurry wall is a unique technique. When you have such a unique technique, you have to reexamine the responsibility for design, even of a limited item of a general project. And in doing that, the best way to be sure that the court will understand where the liability should go is to do it in the contract, very specifically, to say where the liability is, to say where the liability is not. And to develop the law (this would not be your responsibility but the law should be developed), I believe, in such a way that the ultimate obligation in cases where we're dealing with limited operations of specialized knowledge, the obligation ultimately should be placed upon the one having superior knowledge. And that is generally an issue that can be easily determined in court.

Thank you.

SPEAKER: Louis Cantor  
Attorney-at-Law

Asaf Ali Qazilbash  
C. E. Maguire, Inc.

Question:

My question is related to these warranty clauses. We run into this quite often. Many of the agencies insist on writing a clause in the contract that says that the structure will perform the functions for which it is designed. Our lawyers tell us that is the warranty clause, that our professional liability insurance doesn't cover us if we give that type of warranty. We can't afford not to do business with these authorities so we have to take the risk on our own. Have you run into this? Do you have some comments?

Cantor

Answer:

Are you speaking as a specialty contractor?

Qazilbash

Question:

As a consultant for the authority, or some public agency.

Cantor

Answer:

You are saying that you will be ultimately responsible. I know the AIA form tries to take that responsibility from the contractor, and if they have you put it into your contract, that stands. As I say, if the judge reads that in your contract, that says you are responsible and, in addition, from a negligible point of view, you do have the superior knowledge that you design it--then you would assume the risk.

Unknown Questioner

Question:

What happens in the case of temporary structures? Am I better off saying that as a minimum you have to use steel sheeting or a slurry wall? Or am I better off writing it in general terms and saying, "That's the

Unknown Questioner  
(Cont'd)

contractor's responsibility to design adequate temporary support during construction," and I stay out of it completely.

Cantor

Answer:

Purely the latter. The more you write, the more it becomes a detailed specification. How they got away with it in the case I first described, I'll still never know, but they did. But it was bad law. If you put the responsibility clearly on the contractor and take it off yourself in writing, you are better off. However, you're still responsible to the public, and you are certainly responsible to the owner, but you'd have a claim over the contractor. Unless you agree with the owner that you won't be responsible for that, you are responsible as the designer, and supervisor, architect, or engineer.

Harry Sutcliffe  
Bechtel, Inc.

Question:

When a contractor proposes a change in the method of constructing a slurry wall and an owner accepts it, or the owner accepts a value engineering proposal from a contractor, how do you see that as changing the chain of liability?

Cantor

Answer

When the contractor proposes a change it would depend on the nature of the change. There are cases--there are cases in New York that say even though the contractor proposes a change in the nature of the work, if it is accepted by the owner or the architect, it becomes part of the original specifications. That, I say, is a form of the law that is very indistinct right now and you're going to get cases both ways depending on how a court may feel about it. They say that there are cases that say it doesn't change the responsibility of the owner if he approves it, and unless there is something really very specialized about it, again I would apply superior knowledge. If the

Cantor  
(Cont'd)

contractor comes up with an idea and it seems a reasonable idea to a contractor, and it is one that an architect should know whether it works or not, and the architect approves it, I think that the architect has accepted it.

Sutcliffe

Question:

And in a value engineering proposal, where the savings have been split by the owner and the contractor, does that weaken the situation for either side?

Cantor

Answer:

If the savings are being split by the owner and the contractor, then the owner does accept it; there is no question in my mind but he is getting the advantage of it. It's a change order in the contract.

Robert Alperstein  
Woodward-Clyde  
Consultants

Question:

In the case of a permanent slurry wall that is also used as temporary support for an excavation, who should be responsible for the design of the slurry wall, the contractor, the engineer, or the owner?

Cantor

Answer

That is a judgment that is made before the contract documents are formulated. An architect can put that responsibility on a slurry wall contractor or on the contractor for the job, saying he will not be responsible for somebody else but somebody else will be responsible. And I would assume that at this stage of the game, that this is what an architect would do.



INNOVATIONS IN SLURRY WALL TECHNIQUES, DESIGN AND  
CONSTRUCTION - THE POST-TENSIONED DIAPHRAGM WALL

by

MARTIN FUCHSBERGER  
ICOS, GREAT BRITAIN, LTD.  
LONDON, ENGLAND

ABSTRACT

After some historical notes and reference to the first full scale trials, the illustrated article describes the design principles of a post-tensioned diaphragm wall, outlines its use as a permanent structure at the Irlams O' Th' Height Underpass in Manchester with particular reference to the design verification by a fully instrumented test section, and concludes with notes on the economy of this new technique for similar applications.

# INNOVATIONS IN SLURRY WALL TECHNIQUES,

## DESIGN AND CONSTRUCTION

### THE POST-TENSIONED DIAPHRAGM WALL

#### INTRODUCTION

The diaphragm wall or slurry wall technique, developed and progressively improved over the past 30 years, is by now a well established construction method in foundation engineering.

Two innovations constitute the most recent advances in this technique: The use of pre-cast concrete, developed in France in the second half of the nineteen sixties, and the use of pre-stressed (post-tensioned) concrete in the early seventies, developed by ICOS in Italy.

#### First Tests.

Based on a concept by Dott. Ing. Jurina, Head of the design department of I.C.O.S., Milan, the first fully instrumented test section was constructed in 1969 to study the behaviour of a diaphragm wall section cast in the ground and subjected to post-tensioning whilst still embedded in the soil. The underlying concept was that due to the surrounding soil any bending or deformation of the concrete member resulting from the eccentric pre-stressing forces will be restrained by the corresponding counter-thrust of the surrounding soil.

The full scale test was performed on a wall element 5 metre long, 15 metre deep and 60 cm. wide, using a pre-stressed force of up to 300 tonnes with an eccentricity of 20 cm. (Fig. 1).

Five cross-sections of the wall were instrumented. (Fig. 2)

The test extended over a period of four months and the instrumentation permitted more than 100 measurements to be taken simultaneously.

The test results verified the original concept. No discernible deformations of the wall in the ground could be observed and no tensile stresses were measured in the five cross-sections not even by overstressing the cable strands.

These test results encouraged ICOS to apply the technique of post-tensioning - it was patented internationally and given the name ICOS-Flex - to a number of projects in Italy, Switzerland and later in Great Britain, mainly to temporary retaining walls in deep basement structures.

To date some 75,000 m<sup>2</sup>.of post-tensioned diaphragm walling have been constructed for this type of work.

#### The Design of Post-Tensioned Diaphragm Walls.

The increasing number of post-tensioned diaphragm wall projects required a clear definition of its design concept. It was mainly in Switzerland, with its greatest share of basement projects, where the design concept was formulated by Messrs. Gysi, Linder & Leoni, Geotechnical Consultants, and Sartori of Stahlton both Zurich, Switzerland, (see References).

In post-tensioned diaphragm walls the normal vertical steel bar reinforcement is replaced by high-tensile pre-stressing steel or cables of any proprietary systems, (BBRV, VSL, etc.).

In order to firmly fix and position the stressing cables to the designed eccentricity within the bentonite filled trench a light weight reinforcement cage is used which can even be fabricated in a simple modular construction.

The stressing forces and the eccentricity of the stressing steel are determined by the loads coming on to the final structure, i.e., the retaining wall.

The general principle of design for pre-stressing a concrete member is still maintained:- to introduce by pre-stressing a compressive stress in the concrete before final load application wherever under working load a tensile stress would develop so that the compressive stress has first to be reduced. Under continued strain, finally tension will develop. (After Leonhardt).

The advantage of pre-stressing in general is well known. By using pre-stressing the maximum permissible bending moment for a comparable rectangular cross-section of concrete can be more than doubled when compared with that of a conventionally reinforced cross-section of equal dimensions. (See Appendix).

The essential feature of the post-tensioned diaphragm wall design is that the stressing of the steel is carried out whilst the concrete section is still fully embedded in the ground. Thus the soil is used as a "stressing bed".

This results in an interaction between concrete and soil at stress-transfer.

The deformation of the concrete wall section is restrained by the soil resulting in a more even distribution of stresses induced in the concrete than in the case of restraint.

The amount of restraint depends on the nature of the soil and its deformability with the upper limit of the corresponding reaction or counterthrust being the total passive resistance of the soil.

A measure of the deformability of the soil is the Modulus of Sub-grade Reaction  $C$  ( $t/m^3$ ) which is defined as the ratio of pressure ( $t/m^2$ ) over the corresponding deformation ( $m$ ). (Westergaard).

An approximation of the Modulus  $C$  can be obtained from triaxial tests of the soil surrounding the diaphragm wall. (See Appendix).

In a practical analysis a wall panel can be regarded as a continuous beam supported by springs with a stiffness equivalent to the  $C$ -Modulus.

This method of calculation allows the  $C$ -Modulus to vary with depth and to cater to sudden changes in a layered soil.

Gysi et al. have worked out examples for uniform soil with the  $C$ -Modulus varying with depth; one of these with a parabolic - rectangular " $C$ " distribution is shown in the Appendix.

In order to effectively introduce pre-stressing over the whole depth of an embedded diaphragm wall section it is necessary that the concrete wall can deform elastically. One might think this is partially or wholly prevented by soil friction. However, when comparing the relevant moduli of deformation/elasticity of soil ( $E_s = 500 \text{ kg/cm}^2$ ) and concrete ( $E_c = 200,000 \text{ kg/cm}^2$ ), it follows that this influence cannot be significant, a fact which is borne out by field tests.

When designing post-tensioned diaphragm walls corrections to be applied pre-stressing forces have to be made in consequence of the following:-

- (i) Shrinkage of concrete.
- (ii) Creep of concrete (a) before soil excavation, i.e., at stress transfer in the fully embedded condition.  
(b) After soil excavation, i.e., at load transfer in the final stress condition.
- (iii) Relaxation of the stressing steel.
- (iv) Frictional loss within the pre-stressing cables (depending on type of cable and cable curvature).
- (v) Elastic deformation loss in case of looped cables due to stressing the cables in sequence.

Of these (ii) 'Creep of Concrete' is critically time dependent as it covers two distinctly different stress conditions of different magnitudes. (See Appendix).

The total correction to the pre-stressing force from all the above factors may vary between 10% and 15%.

#### Advantages

The design advantages gained by post-tensioning a diaphragm wall can be summarised as follows:-

- (1) The resistance moment of a post-tensioned diaphragm wall is more than double that of a conventionally reinforced wall of equal thickness, i.e. the unsupported height of a wall can be increased by about 50%, or alternatively, the thickness of the wall can be reduced accordingly.

- (2) A design can be made with only compressive stresses in the concrete at any cross-section.  
Therefore normal concrete strength can be used in the wall and no fissures or cracks are developed in the concrete. This is important for marine structures and water-retaining structures.
- (3) The unbonded pre-stressing of the steel with later grouting avoids uncertainties in the bond between steel and concrete when cast under bentonite, and the pre-stressing itself is a test of the integrity of the concrete.
- (4) The total weight of reinforcing steel is significantly reduced due to the high quality of pre-stressing steel. Consequently the reinforcing cages are lighter with wider spacing of the steel which greatly improves the free flow of concrete around reinforcing bars and cables.
- (5) The unsupported height of the wall can be greater which leads to a reduction in the number of supports and a simpler and faster excavation in front of the wall resulting in a significant reduction in construction time of the project as a whole.

Example of a Permanent Post-Tensioned Diaphragm Wall.-

Underpass at Irlams O' Th' Height.

The first large scale use of this new technique in permanent work was at Irlams O' Th' Height, Manchester, (England), where over 70% of the retaining walls to the 1200 lin. yard long dual-carriage way underpass were constructed as post-tensioned diaphragm walls by ICOS in 1976/77.

The underpass is part of an extensive road improvement scheme by the Greater Manchester Council. It required the construction of 1175 lin. yards of free cantilever retaining walls and 3 No. bridge abutments, one with an intermediate pier, all constructed by the diaphragm wall technique. (Fig. 3).

Two principal factors influenced the design of the new underpass:-

- (a) It was located within a built-up area, and
- (b) The traffic flow on the existing roads, adjacent and parallel to it, was not to be interrupted during construction.

A variety of reasons led to the decision to use the diaphragm wall technique which included low construction noise, minimum space requirement and overall economy.

The Authority's original design provided for 1175 lin. yards of standard diaphragm walling as free cantilever walls with a retained height of 10 ft. to 29 ft. and wall thickness ranging from 20 in. to 40 in. Because of the great cantilever height the walls were of necessity heavily reinforced, requiring close spacing of reinforcement bars in single or double layers, thereby reaching the practical limitations of satisfactory diaphragm wall construction.

As an alternative therefore, two thirds of the walls in length were re-designed by ICOS and eventually constructed as post-tensioned diaphragm walls having a wall thickness of 620 mm. (24 in.), 820 mm. (33 in.) and 1020 mm. (40 in.) and a minimum penetration depth of 20.70 m. (68 ft.) and to formation level a cantilever height of up to 29 feet.

The wall panels were about 5.50 m. (18 ft.) long with semi-circular ends and a nominal gap of 150 mm. (6 in.) between adjacent panels to allow for vertical drainage of the soil behind the wall by means of a perforated PVC pipe running vertically and sealed into position by guniting. (Fig. 4).

The pre-stressed reinforcement consisted of No. 4 U-shaped sheathed tendons to each 18 ft. wall panel. Each tendon was stressed to between 104 and 500 tonnes according to the design requirement in relation to the height of cantilever and depth of penetration. (Fig. 5).

The concrete used at Irlams for tremie concrete was a design mix of  $31.5 \text{ N/mm}^2$  (4500 p.s.i.) with a 175 mm. (7 in.) min. slump, whereas the concrete for the capping beam incorporating the top anchorage of the cables cast between shutters and vibrated in the usual way was a  $52.5 \text{ N/mm}^2$  (7600 p.s.i.) design mix.

Past experience on ICOS-Flex work indicated that a "loop" configuration of the cables for the bottom anchorage achieved better results than single anchor heads at the end of each cable.

After casting the capping beam and a suitable curing period the cables were stressed and the ducts grouted up.

The diaphragm retaining walls with capping beam were of course constructed in the ground before bulk excavation for the underpass roadway as a whole was commenced.

#### Bridge Abutments.

The abutments of the three bridges consisted, even in the original design, of a line of T-shaped diaphragm wall sections, post-tensioned in the stem by two pairs of U-shaped tendons with a stressing load of up to 200 tonnes each. The depth of these sections varied from 16.50 m. (52.5 ft.) to 22.10 m. (72.5 ft.) according to the sub-soil and the design load. (Fig. 6). As soon as the T-shaped panel had been constructed in the ground and the post-tensioning of the cables was complete, a further capping beam was cast on top of the diaphragm wall to carry the precast prestressed I-beam and in-situ slab bridge deck. The bridges were then ready and opened for traffic even before the bulk excavation of the ground below was commenced. (Fig. 7).

One of the three bridges, the Bank Lane Bridge, has two spans with an intermediate pier. This intermediate pier was built as a diaphragm wall panel from ground level, and after excavation was suitably faced all around with the same stone facing as used for the retaining wall of the underpass.

#### Test Section

Greater Manchester Council, as Client and the responsible Highway Authority for this work, required the design to be carried out strictly in accordance with the relevant Codes of Practices and Specifications for permanent pre-stressed concrete structures.

However, before work on the pre-stressed walling was allowed to proceed the client required a well instrumented trial to be constructed to verify the design assumptions and to check the performance of the wall at various stages. (Fig. 8 and Fig. 9).

The aims of the measurements in the test section were as follows:-

- To check the influence of the sub-soil during stressing.
- To check the assumed Modulus of Sub-grade Reaction, C.
- To check the creep occurring in the time between stress transfer and load transfer.



Three series of measurements were made:-

i) Immediately after stress transfer, (ii) at the fixed intervals before excavation of the soil in front of the wall and (iii) after excavation.

From a comparison between the calculated and measured E-Modulus of the concrete the conclusion could be drawn that all the pre-stressing forces were transferred into the concrete and the surrounding soil had no apparent influence on this stress transfer.

Except for minor (and permissible) tensile stresses in the bottom anchoring zone, only compressive stresses were measured in the various cross-sections with a more even trapezoidal distribution than calculated. (Fig.10).

From this one can conclude that the actual soil stiffness was greater than that assumed in the calculations.

The successive measurements after stress transfer and before excavation gave a good indication of the stress loss due to creep. This was an important factor in timing the bulk excavation, as not more than 50% to 55% of the total creep could be permitted to take place prior to bulk excavation in order to utilize the stressing steel economically.

From the test results it was concluded that the design assumptions and calculations adequately represented the actual behaviour of the wall and construction was allowed to proceed.

### Economy

The retaining walls and bridge abutments were constructed well within the General Contractor's planned programme and the project as a whole could be finished and opened to traffic as programmed. This together with the fact that a major part of the permanent structure of the underpass, namely, the retaining walls and bridges, could be completed prior to bulk excavation, contributed significantly to the economy of the construction works as a whole.

When comparing the total steel requirement of the Client's original project for the retaining walls of some 2715 tonnes using traditional diaphragm walling, with the 1090 tonnes total reinforcing steel for the predominantly post-tensioned diaphragm walls of the alternative project as adopted, one can understand the potential saving possible with this new technique.

At Irlams O' Th' Height a saving of over £ 80,000 on the retaining walls alone was achieved by using ICOS re-design with post-tensioned diaphragm walls.

### Conclusion

With growing awareness by clients, consultants, designers and contractors of the advantages of this new technique it is hoped that new applications will be found which in themselves may lead to further developments in this field of specialised engineering.

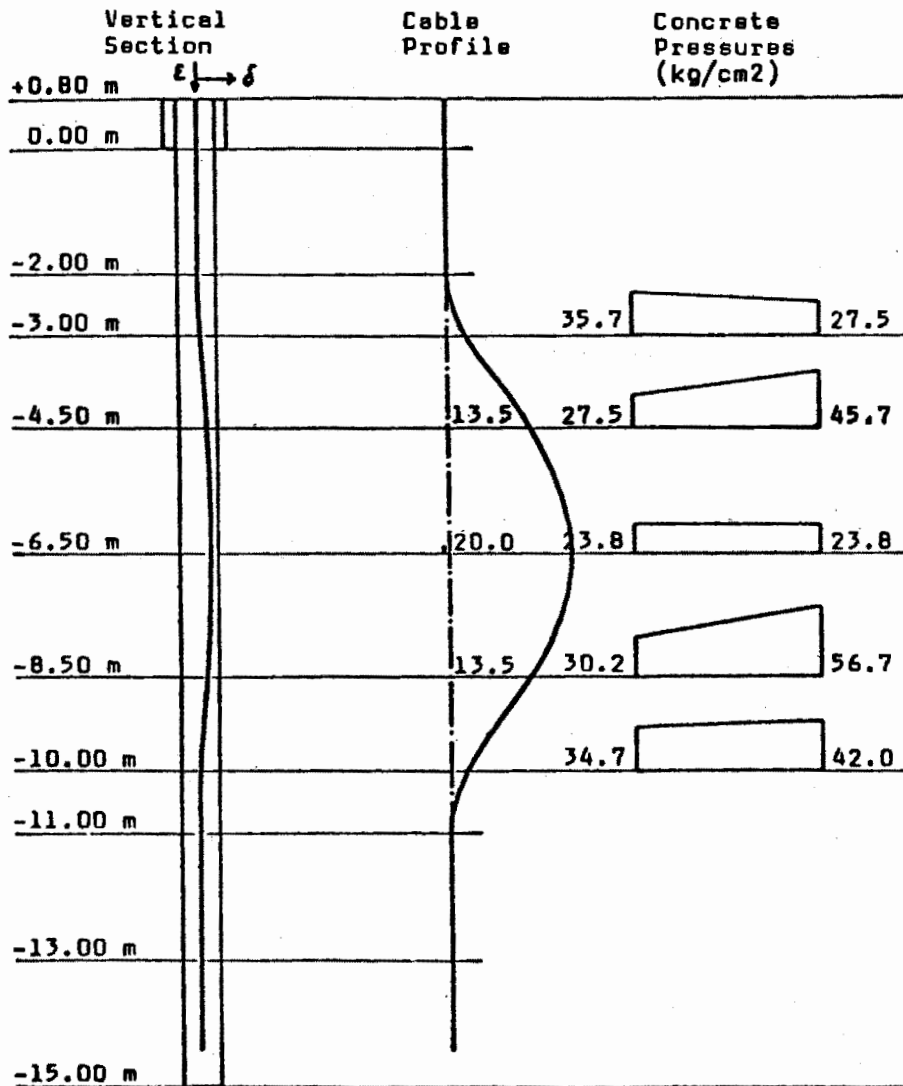
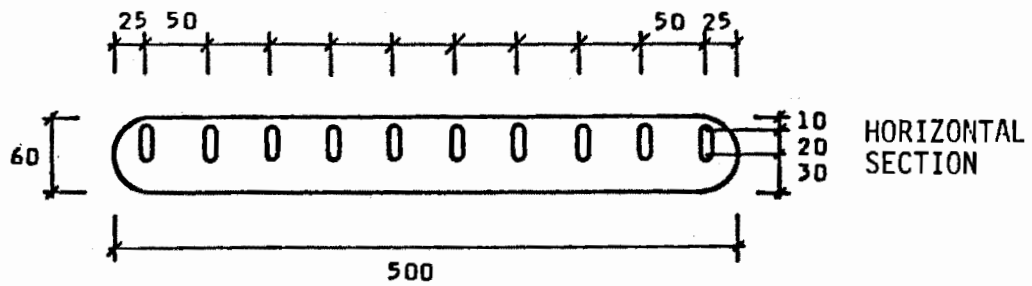
### Acknowledgement

The Client for the works at Irlams O' Th' Height was Greater Manchester Council represented by John Hayes, C.Eng, FICE, Dip. TP, County Engineer. The Main Contractor was Fairclough Civil Engineering Ltd., Adlington, Lancs. to whom ICOS (G.B.) LTD. was responsible under a sub-contract for the design and construction of the diaphragm walls.

ICOS in turn retained the services of A. Linder & Partners, Geotechnical Consultants of Zurich/Lugano (Switzerland) to whom the author is indebted for their permission to use some of the material contained in this paper..

### References

- Abeles, Bardhan-Roy & Turner (1976): "Prestressed Concrete Designer's Handbook", 2nd Ed., A Viewpoint Publication by C & CA, Slough (England).
- G. Sartoris (1975) "Bangrubensicherung mit vorgespannten Schlitzwaenden", Mitteilungen der Schweiz. Ges.f. Boden- & Felsmech., No. 92.
- Gysi, H.J. et.al. (1976), "Vorgespannte Schlitzwaende", Proc. 6th Europ. Conf. on Soil Mech. and Found. Engineering, Vol. 1.1, p. 141, Wien
- Gysi, H.J. et.al. (1977), "Behaviour of a Prestressed Diaphragm Wall", Proc. 9th Intl. Conf. on Soil Mech. and Found. Engineering, Vol. 2, 3/17 p.83, Tokyo.
- Fuchsberger M. & Gysi H.J. (1978) "Post-tensioned diaphragm wall at Irlams O' Th' Height - Manchester", Tech. Paper 8th Intl. Congress of F.I.P., London, May 1978.



Prestressing force = 158.4 t each cable, total 1584 t  
 Horizontal displacement  $\delta$  on top of element 0.65 mm  
 Vertical settlement  $\epsilon$  on top of element 1.82 mm

FIGURE 1 ICOS - FLEX DIAPHRAGM WALL ELEMENT TESTS (1969)  
 DIMENSIONS IN CM

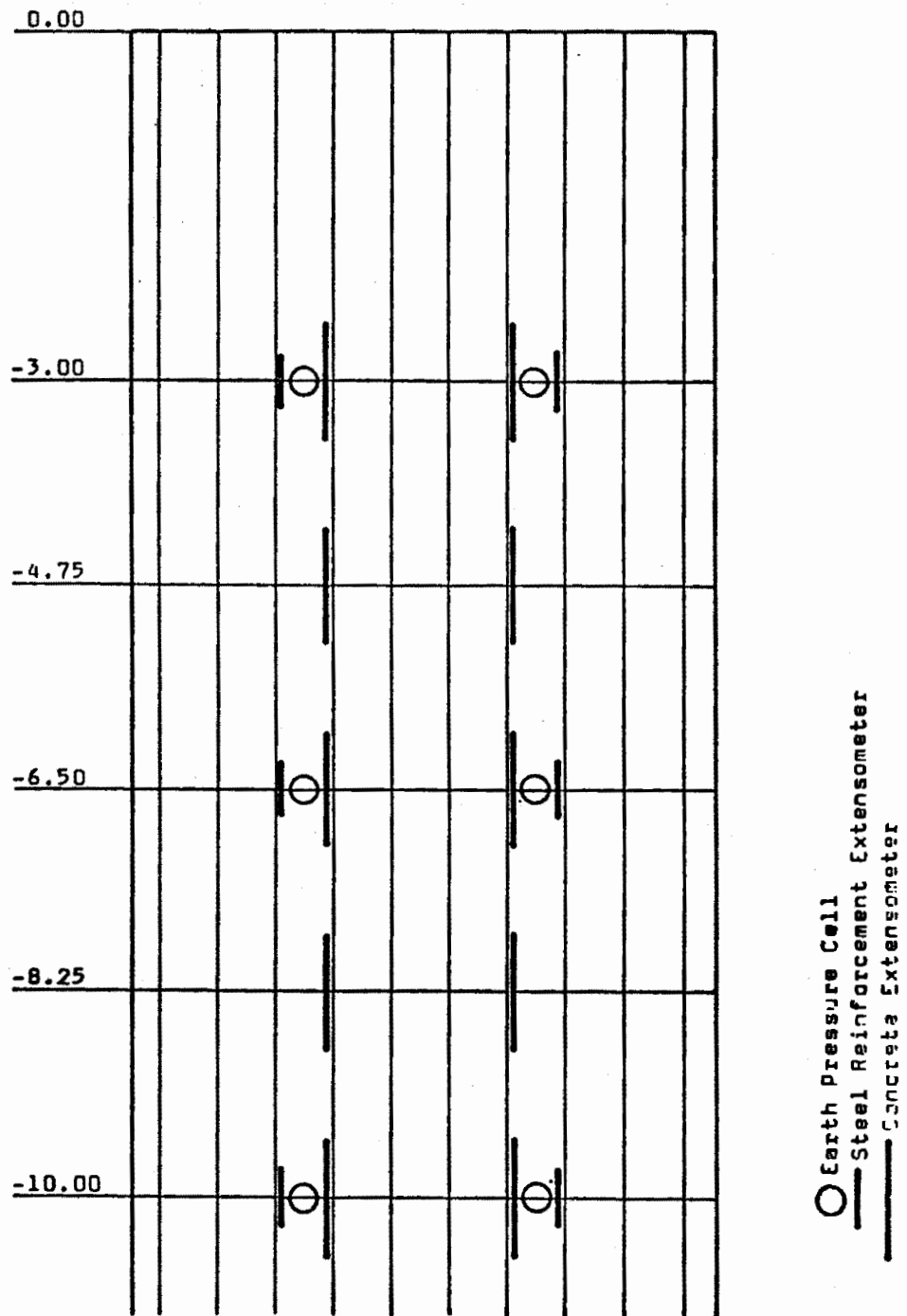


FIGURE 2. ICOS - FLEX DIAPHRAGM WALL ELEMENT TESTS

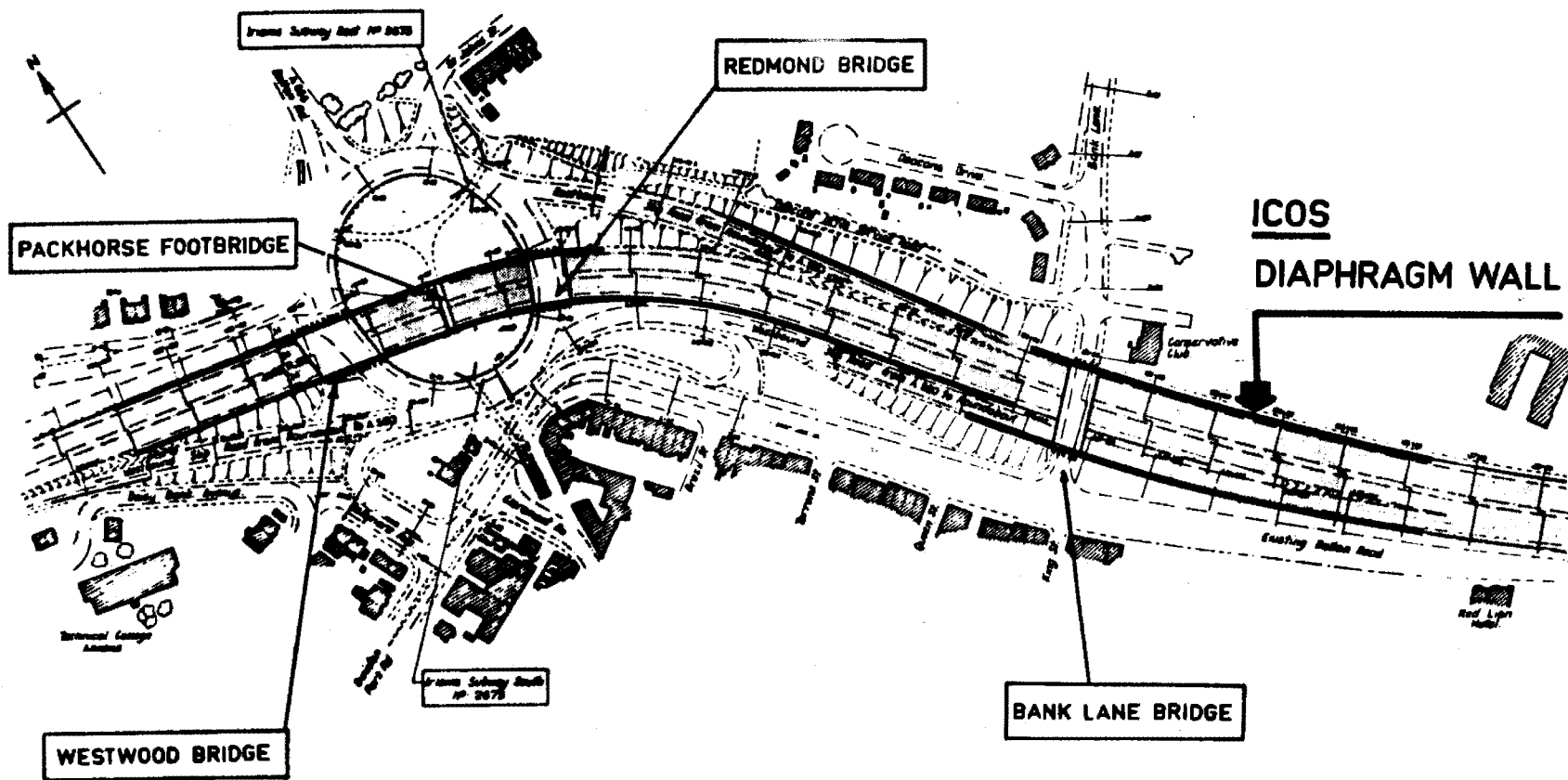


FIGURE 3 LOCATION PLAN

# TYPICAL SECTION THROUGH JOINT

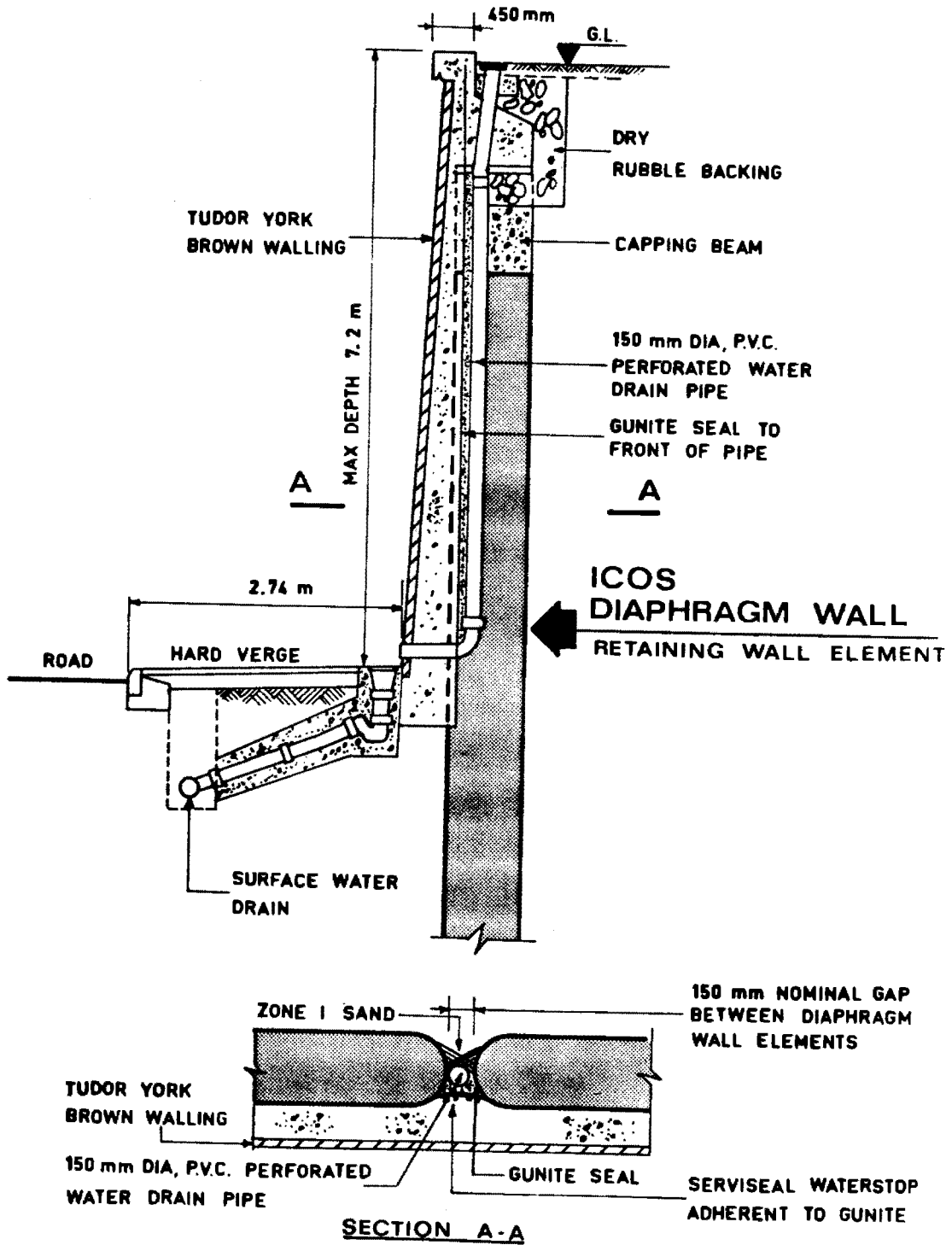


FIGURE 4 TYPICAL SECTION THROUGH JOINT

# TYPICAL RETAINING WALL ELEMENT

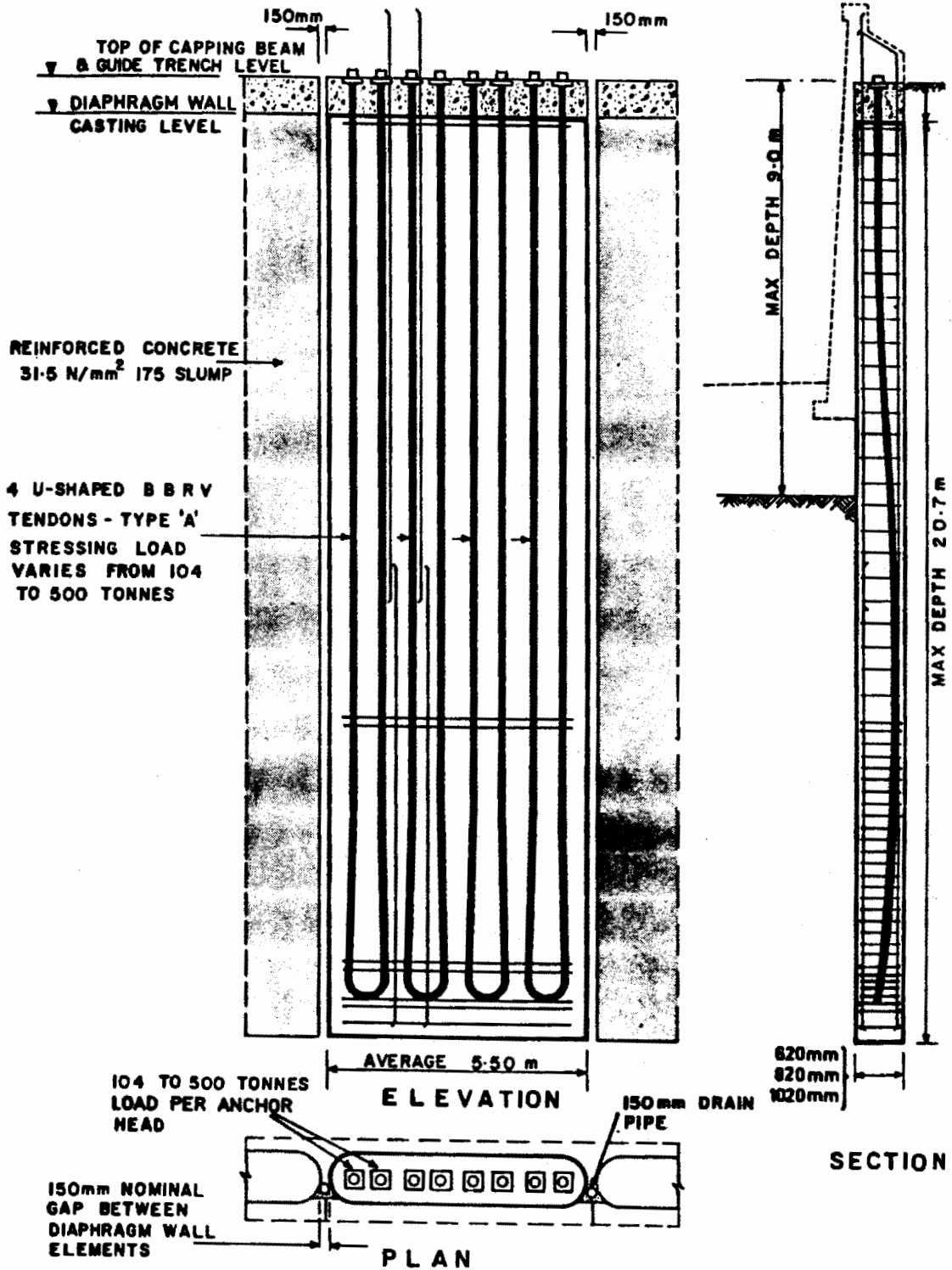


FIGURE 5 TYPICAL RETAINING WALL ELEMENT

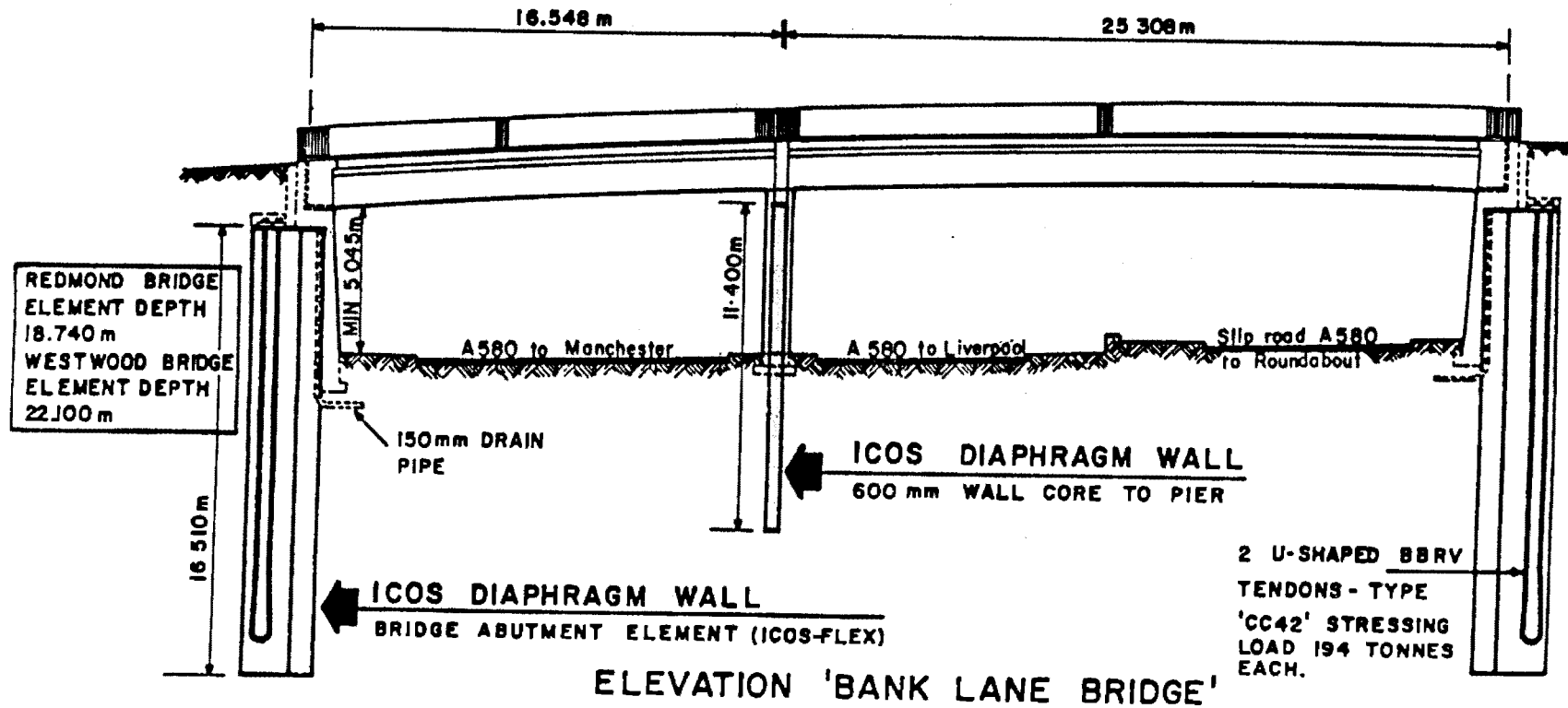


FIGURE 6 ELEVATION 'BANK LANE BRIDGE'



# 'BANK LANE BRIDGE'

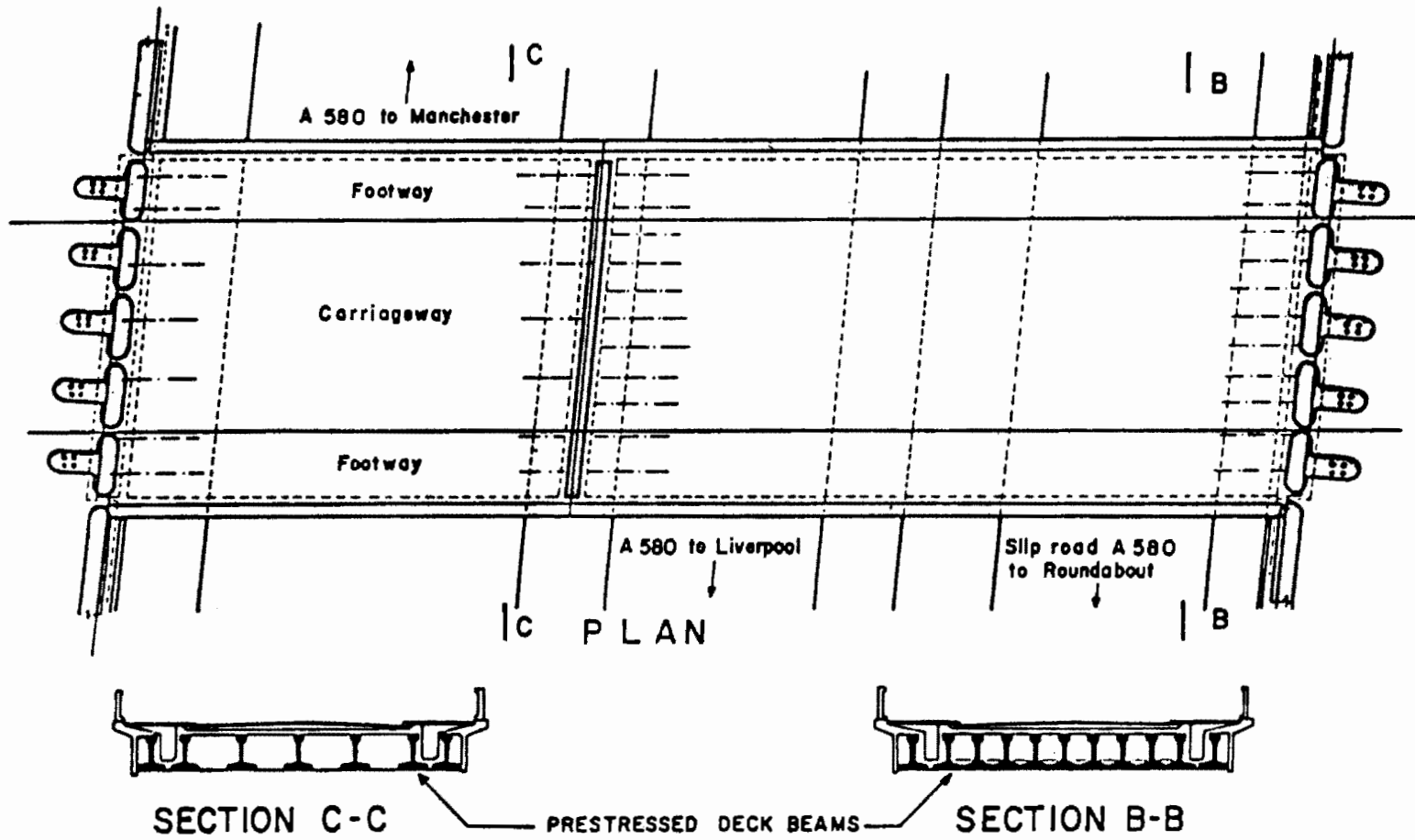
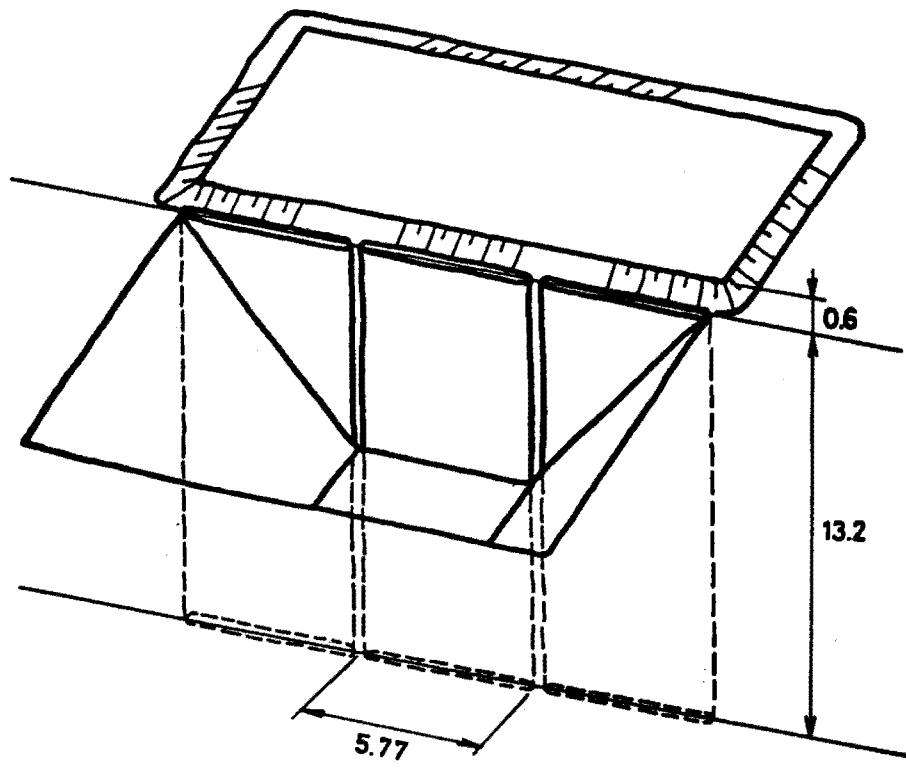


FIGURE 7 'BANK LANE BRIDGE'

# STEREOSCOPIC VIEW OF TEST SECTION



# SECTION

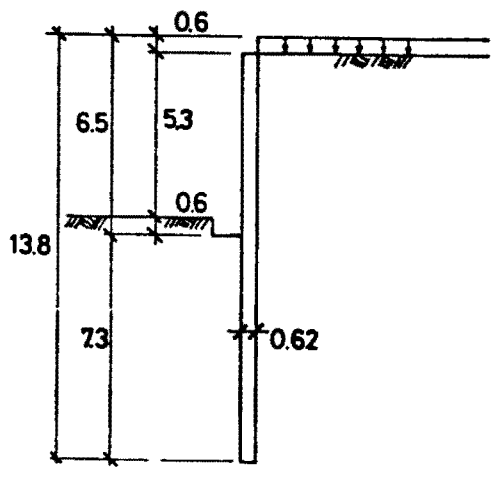


FIGURE 8 STEREOSCOPIC VIEW OF TEST SECTION

# POSITION OF MEASURING INSTRUMENTS

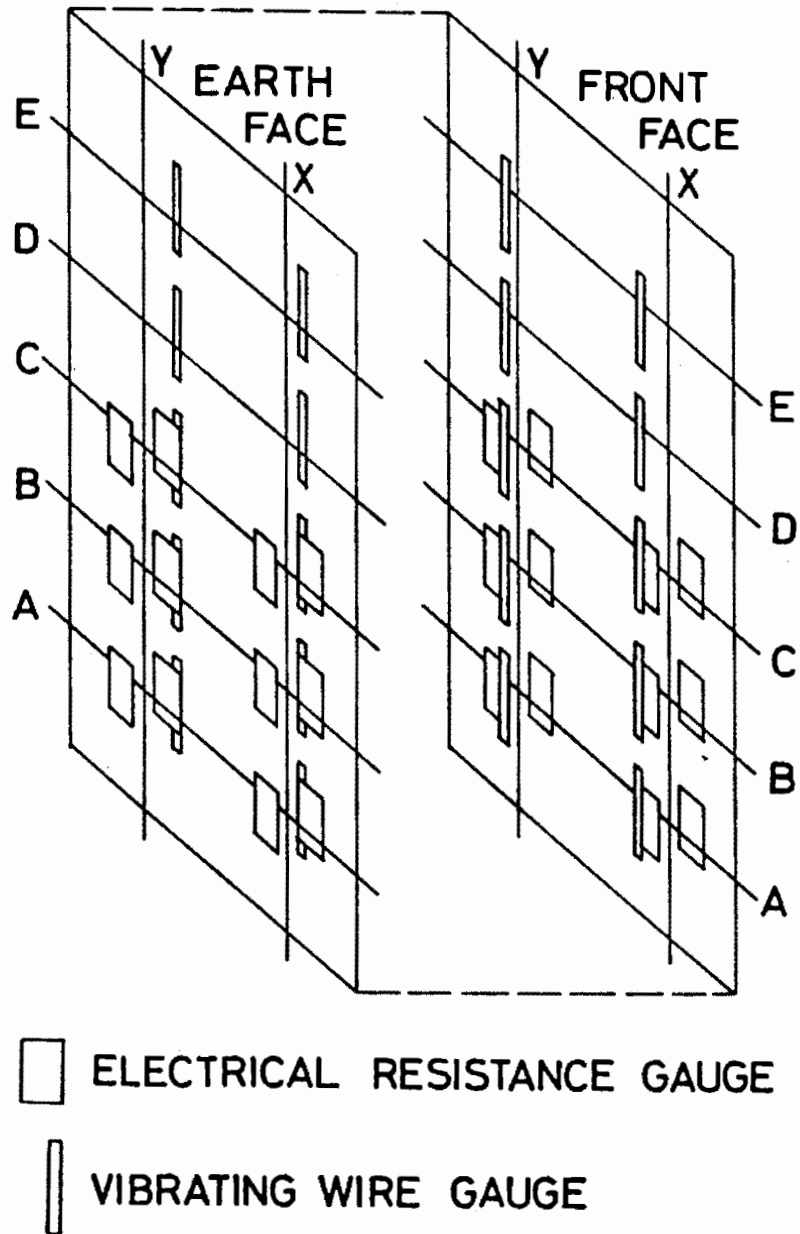


FIGURE 9 POSITION OF MEASURING INSTRUMENTS

# STRESS MEASUREMENTS BEFORE EXCAVATION

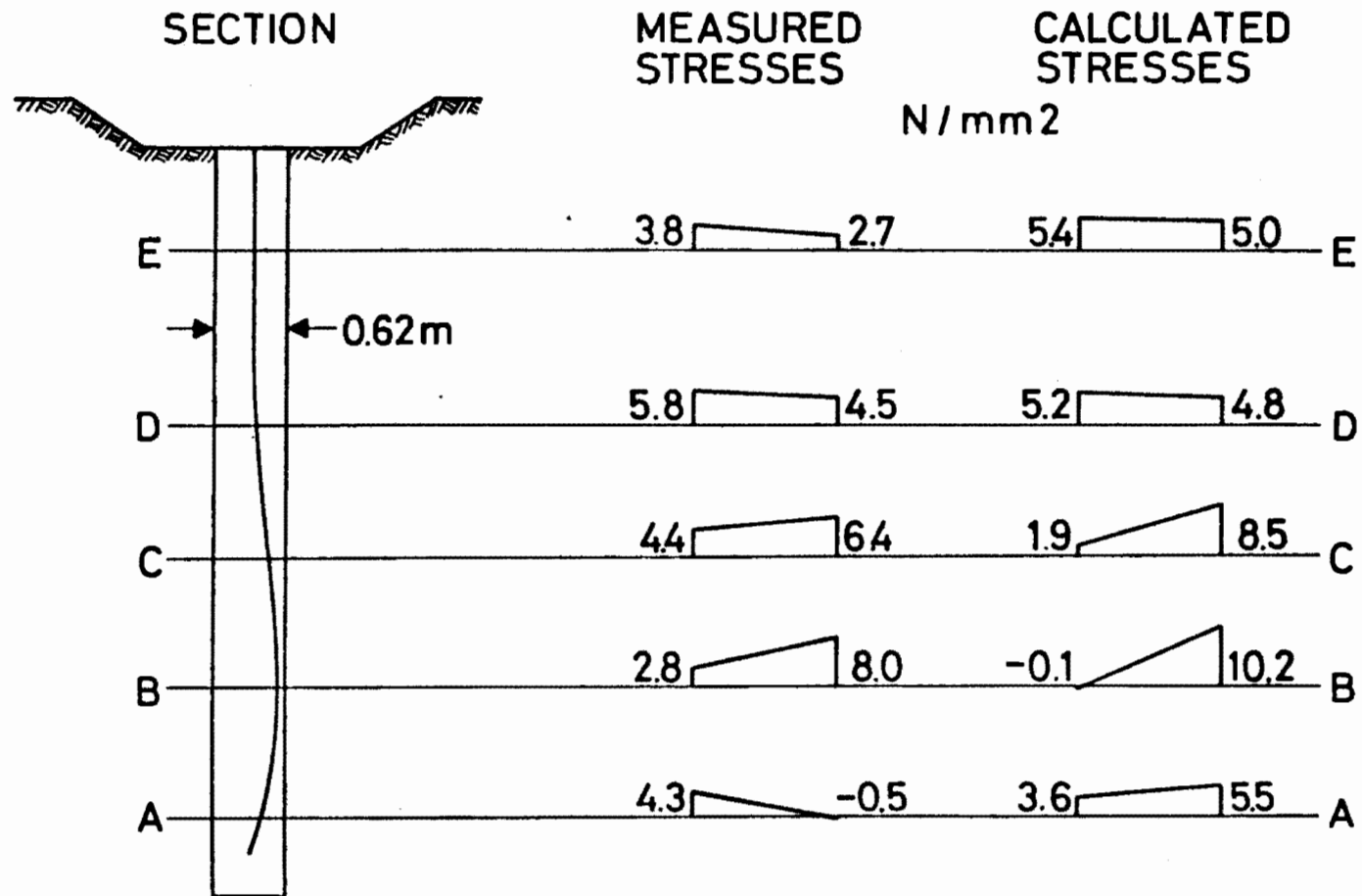


FIGURE 10 STRESS MEASUREMENTS BEFORE EXCAVATION

SPEAKER: Martin Fuchsberger  
ICOS Great Britain, Ltd.

F. A. Bares  
Parsons, Brinckerhoff,  
Quade & Douglas, Inc.

Question:

What is the price differential between a conventional bentonite slurry wall and a prestressed one?

Fuchsberger

Answer

That is a very easy question to answer. In fact, I wanted to make comment on the economy, but since the light was already flashing I had to cut it off. Let me just take this opportunity to say something about the economy. It is obviously since the retaining wall and the bridge abutment, which were the predominant features of the whole underpass, could be constructed from the ground level, together with the active bridge traffic put back to work, rounded the bridges as the excavations took place; of course this was a major factor contributing to the economy overall. Going into greater detail, a total saving of reinforcing steel by weight between the original scheme which would have required about 2,700 tons of steel reinforcement to be installed against the redesigned scheme of just about 1,100 tons requirement in weight of steel, including, of course, the prestressing elements. You can see it is a significant factor in the economy. Basically, by redesigning the wall, the total saving on the wall alone, not to talk about the project which was the main factor, we saved much more than the 80,000 pounds which was on the wall alone.

Bares

Question:

If the post-tensioned slurry wall is less expensive, why is it not more widely used?

Fuchsberger

Answer:

There are many other factors, of course, coming into play in this instance. One of them is that it is a great deal used in temporary works, mainly in Switzerland and Northern Italy. Switzerland uses it predominantly in order to avoid multiple anchorages

Fuchsberger  
(Cont'd)

during the excavation of deep basements. Usually, only one anchor level can suffice in this instance. Furthermore, probably the differential between the labor cost, which is an additional factor in post-tensioning, and the material costs in Switzerland may not be as great as in other countries. This is probably one of the possibilities.

Dru Sesai  
Daniel, Mann, Johnson,  
& Mendenhall

Question:

My first question is, were there any measurements made on the lateral deflection on the post-tension diagram wall at the free end of the cantilever wall?

Fuchsberger

Answer:

Yes, I was referring to a test section before. This test section also had inclinometers included in order to measure the deflections of the wall as a zero measurement before excavation or stressing, and then at intervals after the stress transfer and after the load transfer and then at a few intervals of depth. But this was the end of it because it was found that the deflections were exactly as calculated, or within the accuracy of calculation of measurements. And from that moment on, unfortunately, as it happens in many other countries, I don't know if it happens here, but the authorities had no further interest in measurements and did not want to spend more money on it. So, I must regret that continued measurements, unfortunately, were not made, which was a great pity because it was a unique example of where continued performance could be made on a major project.

Desai

Question:

I was concerned about the creep phenomena that are explained in post-tension systems at times. Because of the creep in the post-tension capacity of the diaphragm wall, you may experience movements at a later date, and if so, what would they be and what records are being kept?

Fuchsberger

Answer:

Of course when I say, "In concurrence with the calculations," this has taken into account that the stress transfer would have been 100% and the creep would have reached its final level. Therefore, the measurements were only made until these deformations ceased to increase further. No further measurements were made that we know of.

# USE OF SLURRY WALLS IN LIEU OF UNDERPINNING

by

KENNETH R. WARE, ROBERT N. EVANS,

and

JAMES G. BECK

BECHTEL, INC.

GAITHERSBURG, MARYLAND

## ABSTRACT

This paper summarizes the instrumentation data obtained on a slurry wall supported excavation and four adjacent buildings. The excavation for the Federal Center S. W. Station of the Washington, D. C. Rapid Transit System was 1065 feet long and 65 feet deep. Four large buildings were located so close to the excavation that they would normally have to be underpinned. However, the excavation was supported by the slurry wall method which reduced ground movement around the excavation to the extent that underpinning was not necessary.

Numerous settlement points were used to monitor both vertical and horizontal building movement. Twenty inclinometers were used to monitor the slurry wall movements. Extensive data is presented showing the relationship between the depth of excavation, slurry wall movement, and building movement.

This instrumentation program proved that slurry wall supported excavations can successfully eliminate the need for underpinning adjacent buildings.

## USE OF SLURRY WALLS IN LIEU OF UNDERPINNING \*

### I. INTRODUCTION

The Washington Metropolitan Area Transit Authority's rapid transit system (METRO), currently under construction, will ultimately require 21-mi. (34-km) of open-cut excavations. Most of these excavations are located in the congested downtown areas of Washington, D.C., where ground settlement is critical because of its effect on nearby buildings and underground utilities.

This paper summarizes the instrumentation data obtained on a slurry wall supported excavation and four adjacent buildings. The excavation for the Federal Center S.W. Station was 1065 feet long and 65 feet deep (see Figure 1 for a plan view of the project). Four large buildings were located so close to the excavation that underpinning would normally have been required. However, the excavation was supported by slurry walls rather than the more conventional soldier pile lagging walls. An extensive instrumentation program showed that ground movements around the excavation were reduced to such an extent that underpinning was not necessary.

\*The recommendations and opinions expressed herein are solely those of the authors and do not necessarily represent those of WMATA.

Kenneth R. Ware,  
Manager, Geotechnical Group, Bechtel Inc., Gaithersburg, Md.  
Formerly, Chief Tech Serv. Bechtel Assoc. METRO Subway Project,  
Washington, D.C.

Robert N. Evans,  
Senior V.P. District Engineering Services, Inc., Capital Heights, Md.  
Formerly, Soils Engineer, Bechtel Assoc. METRO Subway Project,  
Washington, D.C.

James G. Beck,  
Field Engineer, Bechtel Inc., N.E. Corridor Project, Washington, D.C.  
Formerly, Soils Assistant, Bechtel Assoc. METRO Subway Project,  
Washington, D.C.



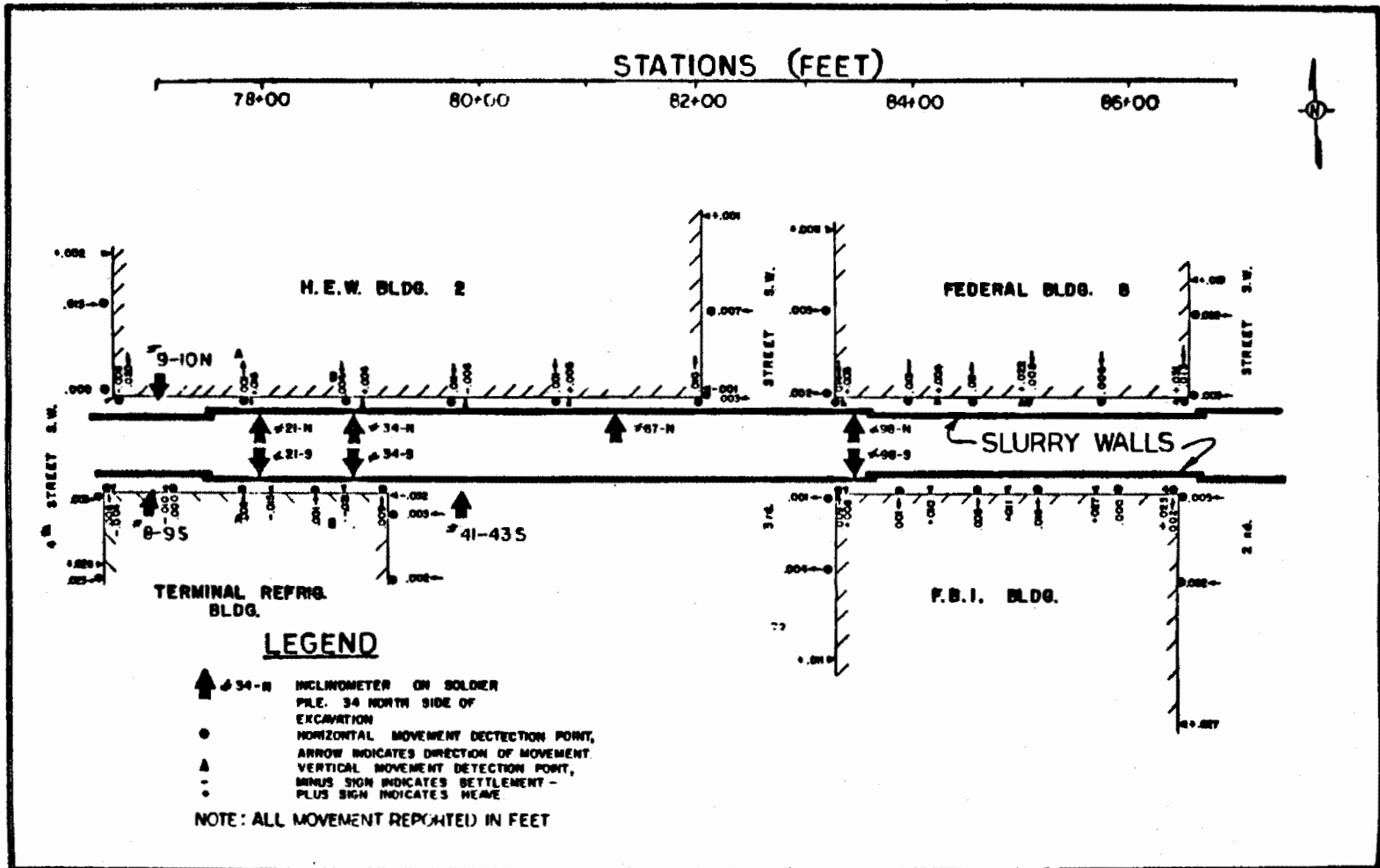


FIGURE 1 PLAN VIEW OF PROJECT

## II. DESCRIPTION OF PROJECT

### CONTRACT

The plans and specifications required that the excavation be supported by the soldier pile lagging method and the adjacent four large buildings be underpinned by either the jack pile or the pit pier method. As an option, the contractor was allowed to bid on a slurry wall supported excavation in lieu of underpinning the four buildings. The following is a summary of pertinent data on the four buildings which were required to be underpinned or protected by a slurry wall:

Table 1 - Building Data

| <u>Building</u>           | <u>Type</u>                | <u>Weight of Exterior<br/>Columns or Walls</u><br>( <sup>K</sup> /ft of bldg face) |
|---------------------------|----------------------------|--|
| Federal Building No. 8    | 6 Story with Marble Facing | ?  |
| FBI Building              | 6 Story with Brick Facing  | 34   |
| HEW Building No. 2        | 4 Story with Brick Facing  | 31   |
| Terminal Refrig. Building | 8 Story with Brick Facing  | 53   |

The contractor, Mergentime-Steers-Arundel, submitted the low bid for this subway station contract. The unit prices indicated the slurry wall option was \$2.3 million less expensive than the soldier pile lagging and underpinning scheme; consequently, the slurry wall option was adopted.

## CONSTRUCTION

The slurry walls were constructed as a series of individual panels. Each panel was 80 ft. (24.4 m) deep, 33 in. (0.84 m) wide and 7 ft. (2.13 m) long (8 ft. [2.44 m] excavated panel length). The joints between panels were formed by wide flange beams. Reinforcing bars were provided on each face of the panels. This produced a very rigid continuous concrete wall that was supported by struts at four levels during the excavation stage. Figure 2 shows a plan of a typical slurry wall panel.

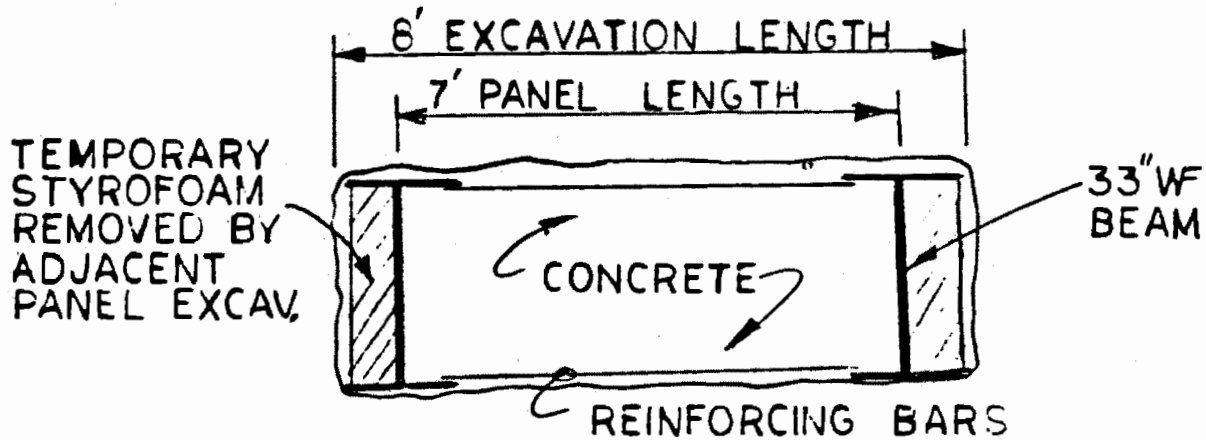


FIGURE 2 PLAN VIEW OF TYPICAL PANEL

The horizontal and vertical building movement data shown on Figure 1 were surveyed in March 1974. At that time, all of the excavation between the walls was completed except for the last few hundred feet on the east end of the project. In addition, most of the station invert slabs were in place and the lower strut levels had been removed on the western end of the project to allow the lower station walls to be constructed.

### SOIL PROPERTIES

Figure 3 is a cross section that shows the outline of the completed METRO station and the soil profile. Table 2 summarizes the important soil properties of the subsurface strata shown on the profile.

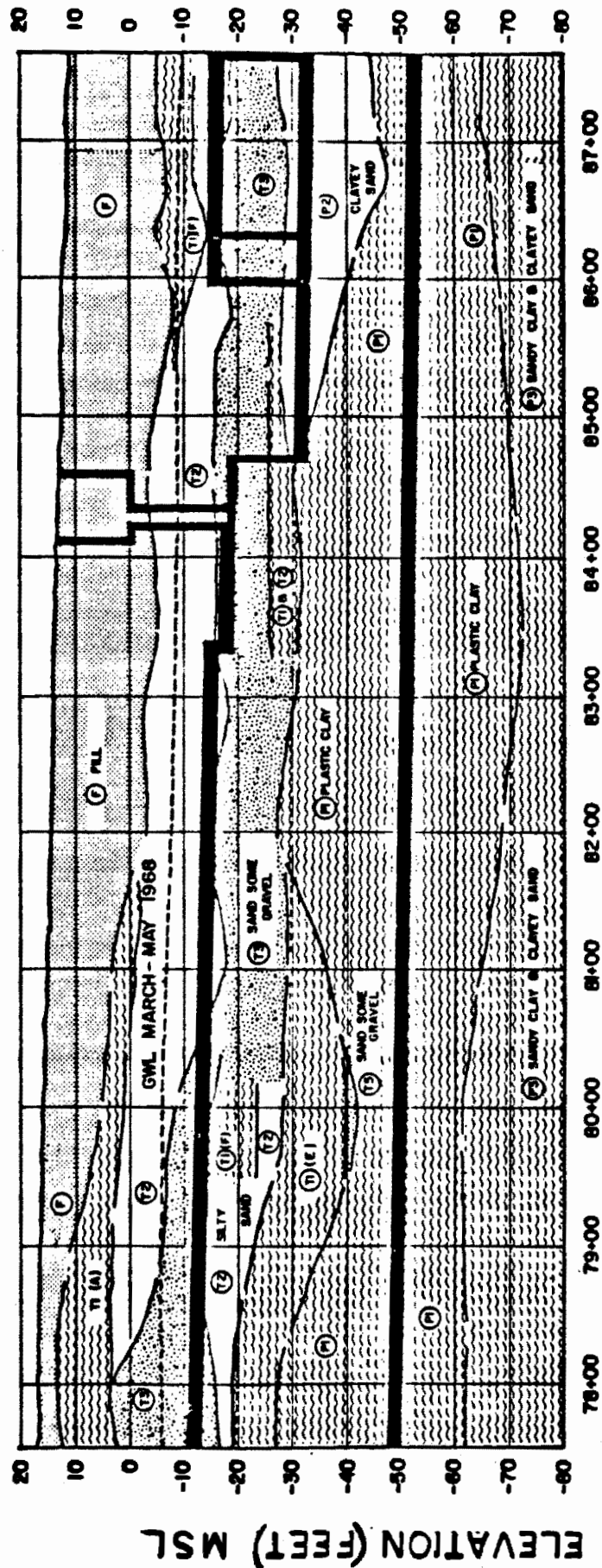


FIGURE 3 SOIL PROFILE

TABLE 2 SOIL DATA

|                  | SYMBOL              | DESCRIPTION  | UNIT WT.<br>PCF  | STRENGTH<br>(C or $\phi$ value) |
|------------------|---------------------|--|--|---------------------------------|
|                  | F                   | Fill, generally composed of inorganic soil obtained from nearby natural materials  | 120  | C=0 - 2.0<br>ksf                |
| TERRACE DEPOSITS | T1                  | Stiff to medium stiff light brown or gray or mottled brown-gray silty clay or clayey silt with lenses or brown silty fine sand                                 | 120 - 130  | C=1.0 - 2.0<br>ksf              |
|                  | T1(A)               | Stiff to very stiff dark gray silty clay   | 130  | C=1.5 - 2.5<br>ksf              |
|                  | T1(C)               | Soft to medium stiff dark gray silty clay  | 120  | C=0.7 - 0.9<br>ksf              |
|                  | T1(E)               | Stiff to very stiff dark gray silty clay   | 130  | C=2.0 - 3.0<br>ksf              |
|                  | T2                  | Compact brown and red-brown silty or clayey fine to medium sand with trace of gravel and occasional boulders   | 130  | $\phi = 32^\circ - 34^\circ$    |
|                  | T3                  | Compact brown and red-brown, fine to coarse sand with some silt and gravel and variable amounts of cobbles and boulders  | 130  | $\phi = 34^\circ - 38^\circ$    |
|                  | T4                  | Medium compact to compact gray and gray-brown fine to medium sand with some silt and gravel. Contains lenses of dark gray clay                                 | 130  | $\phi = 30^\circ - 34^\circ$    |
|                  | T5                  | Compact gray to gray brown fine to coarse sand with gravel, some silt and variable amounts of cobbles and boulders   | 130  | $\phi = 32^\circ - 38^\circ$    |
|                  | CRETACEOUS DEPOSITS | P1   | Hard mottled red-brown and gray or light gray and tan plastic clay occasional pockets of fine sand | 130                             |
| P2               |                     | Compact to very compact light gray or tan silty or clayey fine to medium sand with pockets of silty clay and trace of small gravel                             | 130  | $\phi = 33^\circ - 36^\circ$    |
| P3               |                     | Hard gray-green or gray blue-green silty or sandy clay and very compact silty or clayey fine to medium sand with occasional small gravel and boulders          | 130  | C=4.0 - 6.0<br>ksf              |
| P4               |                     | Very compact mottled light gray, tan, buff, or white silty or clayey fine to medium sand with some gravel. Frequently with dense nests of cobbles and boulders | 130  | $\phi = 34^\circ - 38^\circ$    |

### III. GENERAL DESCRIPTION OF INSTRUMENTATION

Inclinometers and conventional surveying equipment were used to monitor the slurry wall and the adjacent buildings. Figure 1 shows the location of the inclinometer casings in the slurry wall.

The contract specifications for the project read in part:

"The Engineer will monitor the inclinometer casings for movement. If there is any evidence to indicate that the cumulative displacement is likely to exceed 3/4 inch, the Contractor shall install additional tiers of bracing as required to stiffen the wall and to avoid exceeding this limit."

This created intense interest in the instrumentation program throughout the period of slurry wall construction and excavation.

#### INCLINOMETERS

An inclinometer casing is a specially grooved pipe that accurately orients an inclinometer as it moves through the casing. The inclinometer measures the tilt (deviation from vertical) of the casing at desired locations. When it is assumed that the bottom of the casing is stationary, the lateral movements above the base of the casing can be calculated and plotted to show the casing movements. A Model 200BL Inclinometer (manufactured by the Slope Indicator Co.) was used to make the readings. These instruments have an accuracy of 1 in 10,000.

Two sets of inclinometer casings were installed. One set, referred to as "Casings Outside the Slurry Wall" was used to monitor the ground movements caused by construction of the slurry wall. These movements are described in Section IV. The other set, referred to as "Casings Inside the Slurry Wall," was used to monitor movements of the slurry walls during the excavation process between the walls. These movements are described in Section V.

#### OPTICAL SURVEYS

The accuracy of the survey work, for both vertical and horizontal building movements, was better than normal for this type of construction. The contractor's survey crew surveyed each point at least weekly. In addition, the construction manager's survey crew ran check surveys on a random basis. In each case they found the contractor's data were accurate.

The contractor in turn checked the accuracy of inclinometer data obtained by the construction manager. The contractor's surveyors accurately measured the distance across the excavation at locations where inclinometer casings were located on both sides. This information was compared with the combined inclinometer data as a rough check on the inward movement of the walls. In each case the contractor's survey was in agreement with the inclinometer data.

Despite the relatively high quality of the survey work the vertical movements shown on Figure 1 are probably only accurate to within  $\pm 0.005$  ft. (1.5 mm). The horizontal movements are probably only accurate to within  $\pm 0.01$  ft. (3 mm).



#### IV. CASINGS OUTSIDE SLURRY WALL

The specification for the contract limited the maximum allowable length of the slurry panels in front of each building. These ranged from a maximum of 8 ft. (2.44 m) in front of the FBI Building and Federal Building No. 8 down to a minimum of 4 ft. (1.22 m) in front of the Terminal Refrigeration Building. The designer required small slurry panel lengths in front of the heavier buildings because of concern that wide panels would tend to squeeze shut under heavy building loads. Shortly after construction began, the contractor requested permission to excavate all panels 8 ft. (2.44 m) long to enable him to use the same excavating equipment throughout the project. Permission was granted contingent on an instrumentation program demonstration that excessive soil movement would not develop during excavation of the slurry wall.

The contractor installed seven inclinometer casings outside the wall. These were intended to determine ground movement during excavation and backfilling of selected slurry wall panels. Unfortunately, these instruments had limited usefulness because:

- a) For contractual reasons the instruments were installed to the same depth as the slurry wall. Consequently, it could not be assumed that the bottom of the instrument did not move as the panel was excavated. Fortunately, it was possible to assume fixity at the top of the inclinometer casing because the contractor installed 1 ft.

(.30 m) wide by 6 ft. (1.8 m) deep guide walls on each side of the slurry wall. These were intended to guide the slurry bucket during excavation, but they also helped protect the top of the inclinometer casings from disturbance during construction of the slurry wall.

- b) Despite a concerted effort to protect the tops of the inclinometer casings they were frequently disturbed during the excavation and concrete backfilling work on each panel.
- c) Scheduling difficulties between the construction and instrumentation personnel resulted in several panels being backfilled with concrete before measurements could be taken.

Out of the seven inclinometer casings installed outside the wall only three provided useful data, which are summarized in the following table:

TABLE 3  
CASINGS OUTSIDE SLURRY WALL

| Casing Number <sup>(1)</sup> | Station | Panel Length (Ft.) | Maximum Movement During Excavation (In.) | Net Movement After Concreting (In.) | Casing Location Relative to Panel |
|------------------------------|---------|--------------------|--|-------------------------------------|-----------------------------------|
| 9-10N                        | 77 + 40 | 8                  | ? <sup>(2)</sup>                         | 0.25                                | 5.2 ft. N                         |
| 8-9S                         | 76 + 97 | 8                  | 0.75                                     | 0.28                                | 7.5 ft. S                         |
| 41-43S <sup>(3)</sup>        | 79 + 35 | 15                 | 0.20                                     | 0.19                                | 7.0 ft. S                         |

NOTES:

- (1) The inclinometer casings installed outside the slurry wall were designated by the number of the panel they were intended to monitor (e.g., inclinometer casing 9-10N refers to the panel in the north wall bounded by soldier piles 9 and 10).
- (2) No readings obtained during excavation of panels.
- (3) Panel area where there are no buildings. Panels 41-42S and 42-43S were excavated simultaneously to form a 15 ft. (4.4 m) long slot.

The actual displacements of the three inclinometers are shown on Figures 4 through 6.

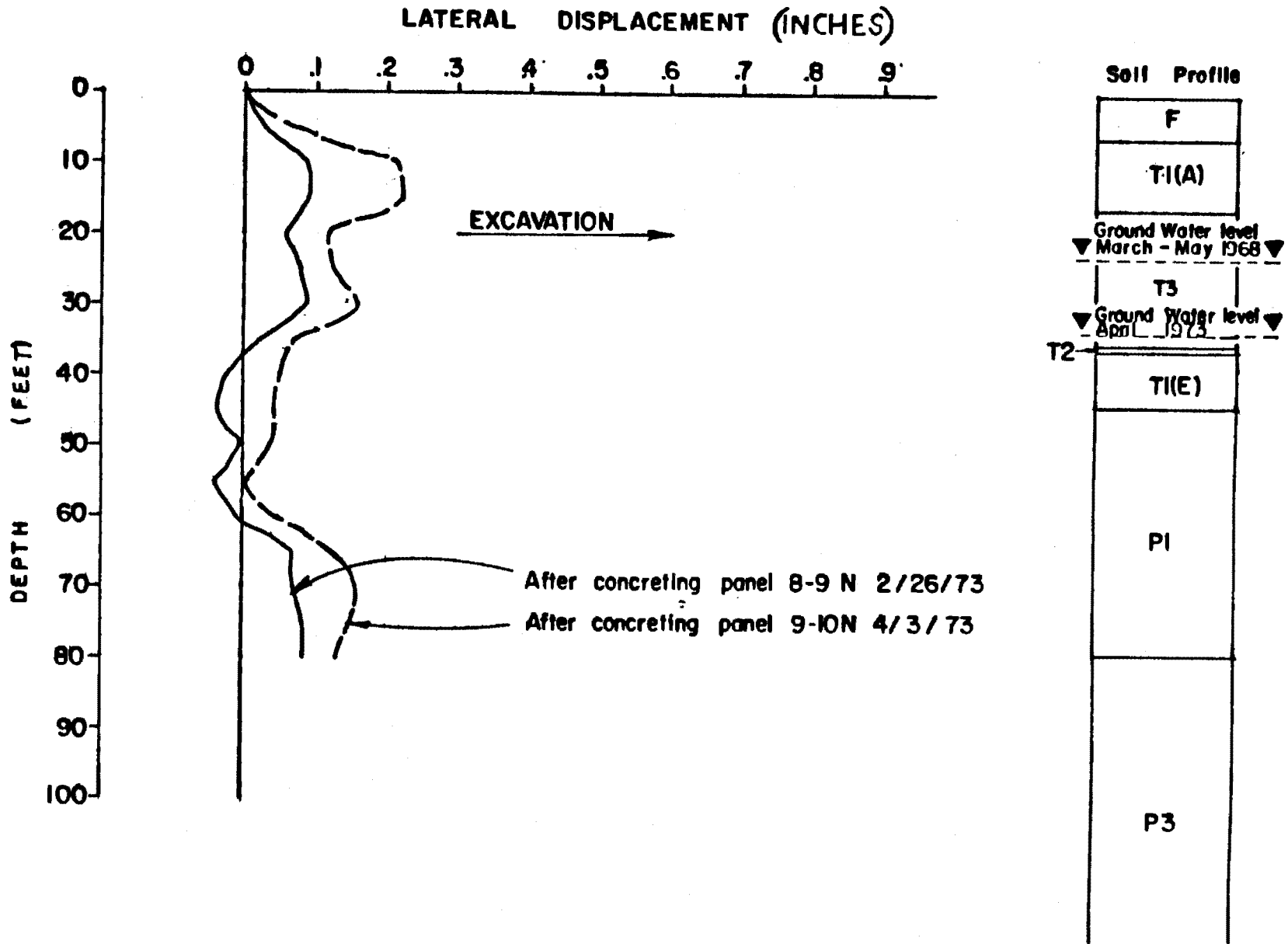


FIGURE 4 INCLINOMETER CASING 9-10 N

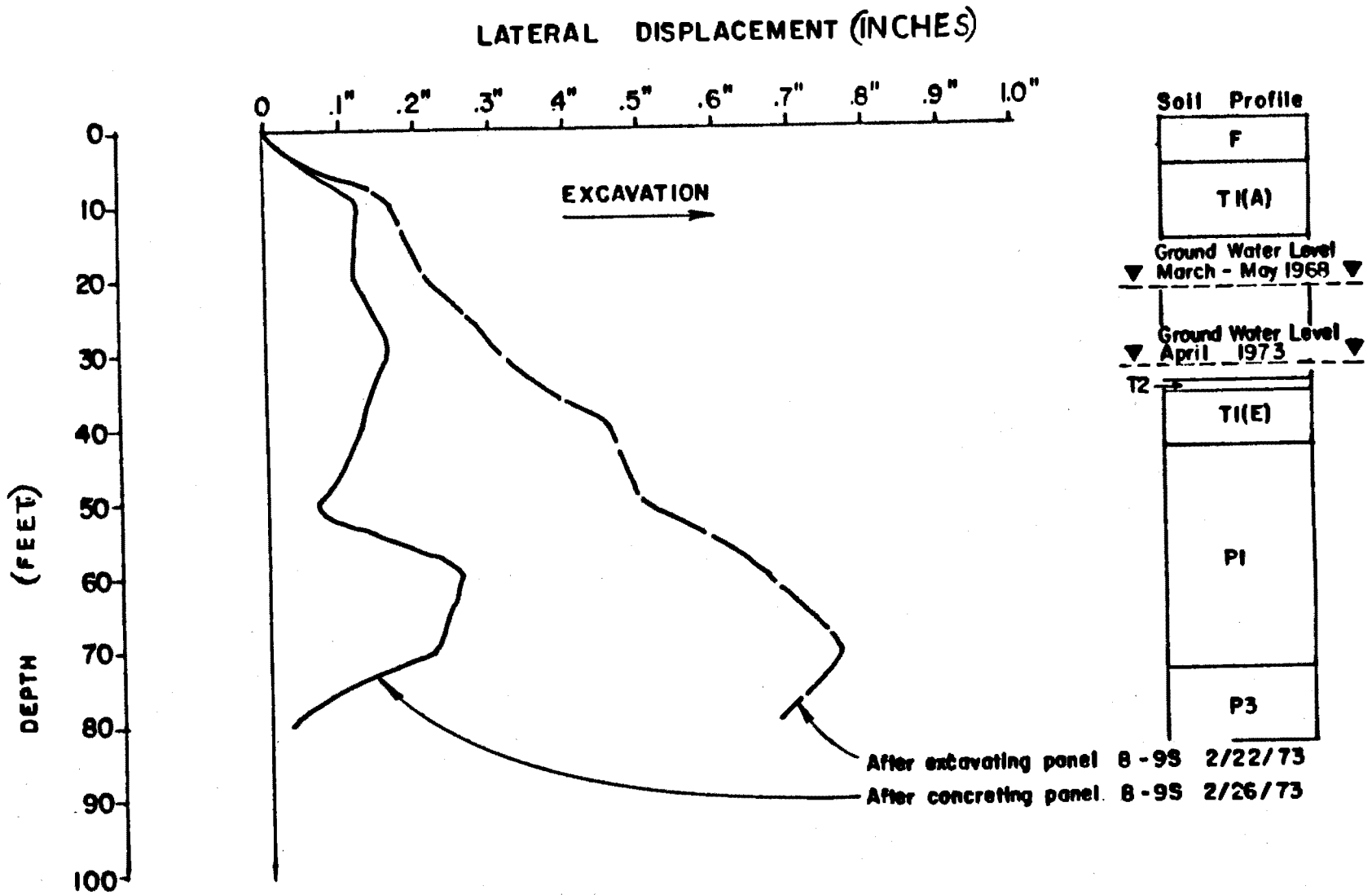


FIGURE 5 INCLINOMETETER CASING 8-9S

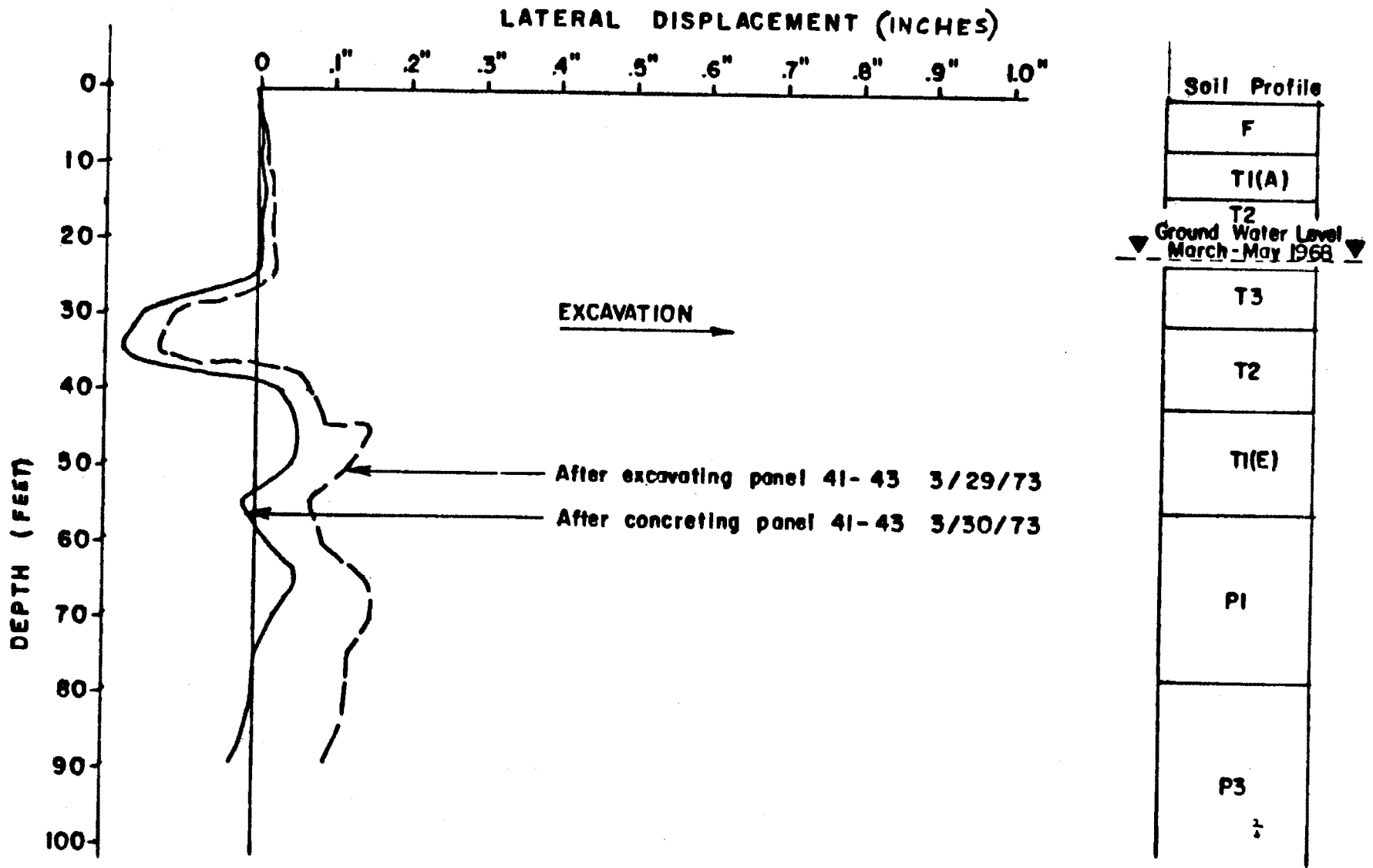


FIGURE 6 INCLINOMETER CASING 41-43S

Although this experimental work was not conclusive, it generally indicated that the net lateral ground movement during installation of the slurry wall would be on the order of 1/4 in. (6 mm). Consequently, it was decided to proceed with the 8 ft. (2.44 m) excavated panel length and carefully observe the adjacent buildings to see if movements developed. No significant movements were detected in any of the buildings during construction of the slurry walls.

## V. CASINGS INSIDE SLURRY WALL

The contract documents required that inclinometer casings be cast into the slurry wall during its construction. This was accomplished by attaching the casings to the soldier piles. The location of these casings is shown on Figure 1. The designation of each casing is the same as the number of the soldier pile it is attached to (e.g., inclinometer #21N refers to the 21st soldier pile from the west end of the excavation in the north wall). Numerous readings were made on each inclinometer casing as the excavation progressed. Figure 7 is an example of the type of data obtained during the excavation process.

The final displacements measured in each inclinometer casing are summarized on Figures 7 through 11. The solid line represents the maximum displacement that occurred during excavation. The dashed line indicates additional movement that occurred after pouring the station invert slab and removing the lowest strut level to construct the station walls.



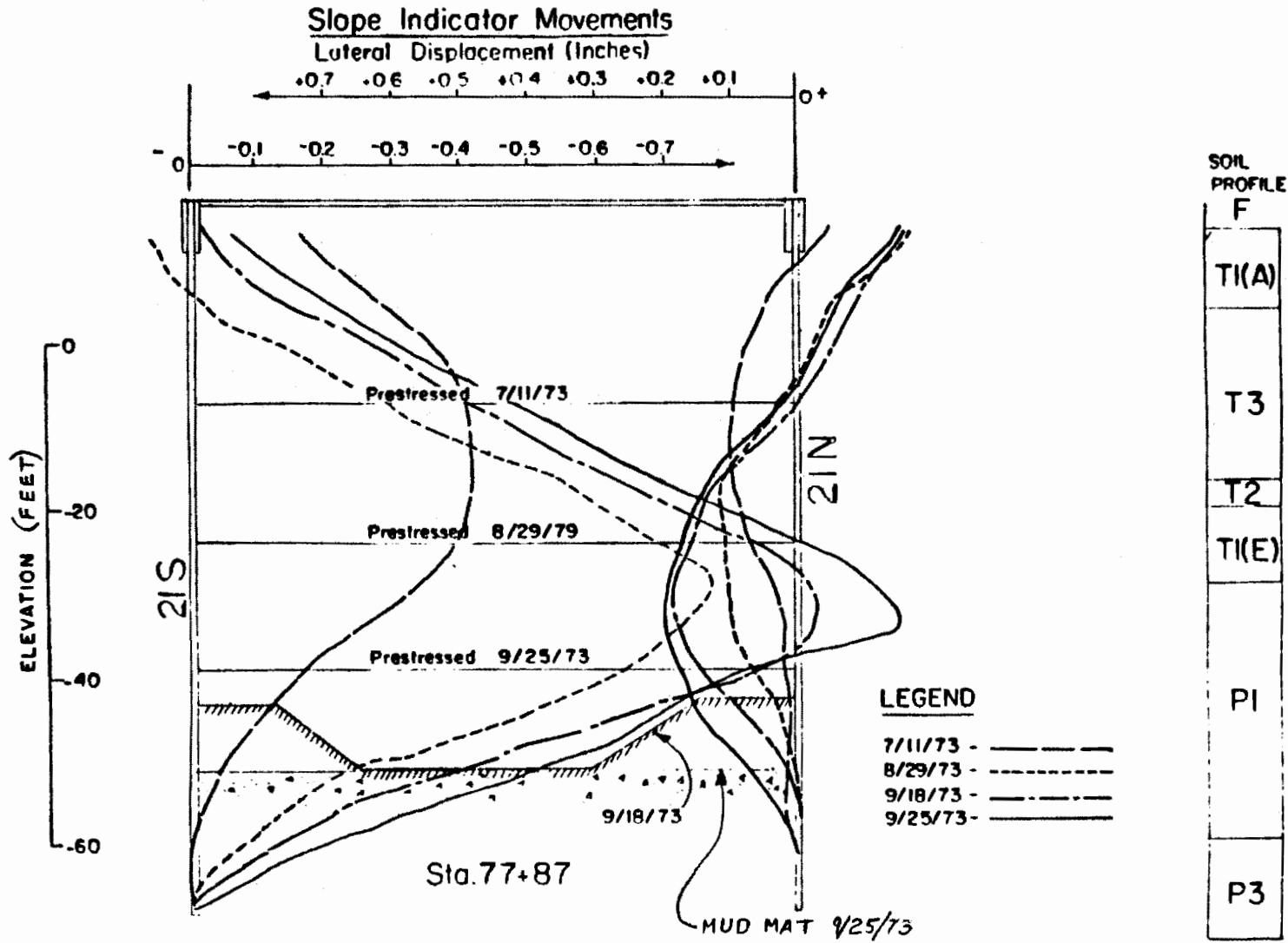


FIGURE 7 INCLINOMETER CASINGS 21-N & 21-S

# INCLINOMETER # 21-N & 21-S

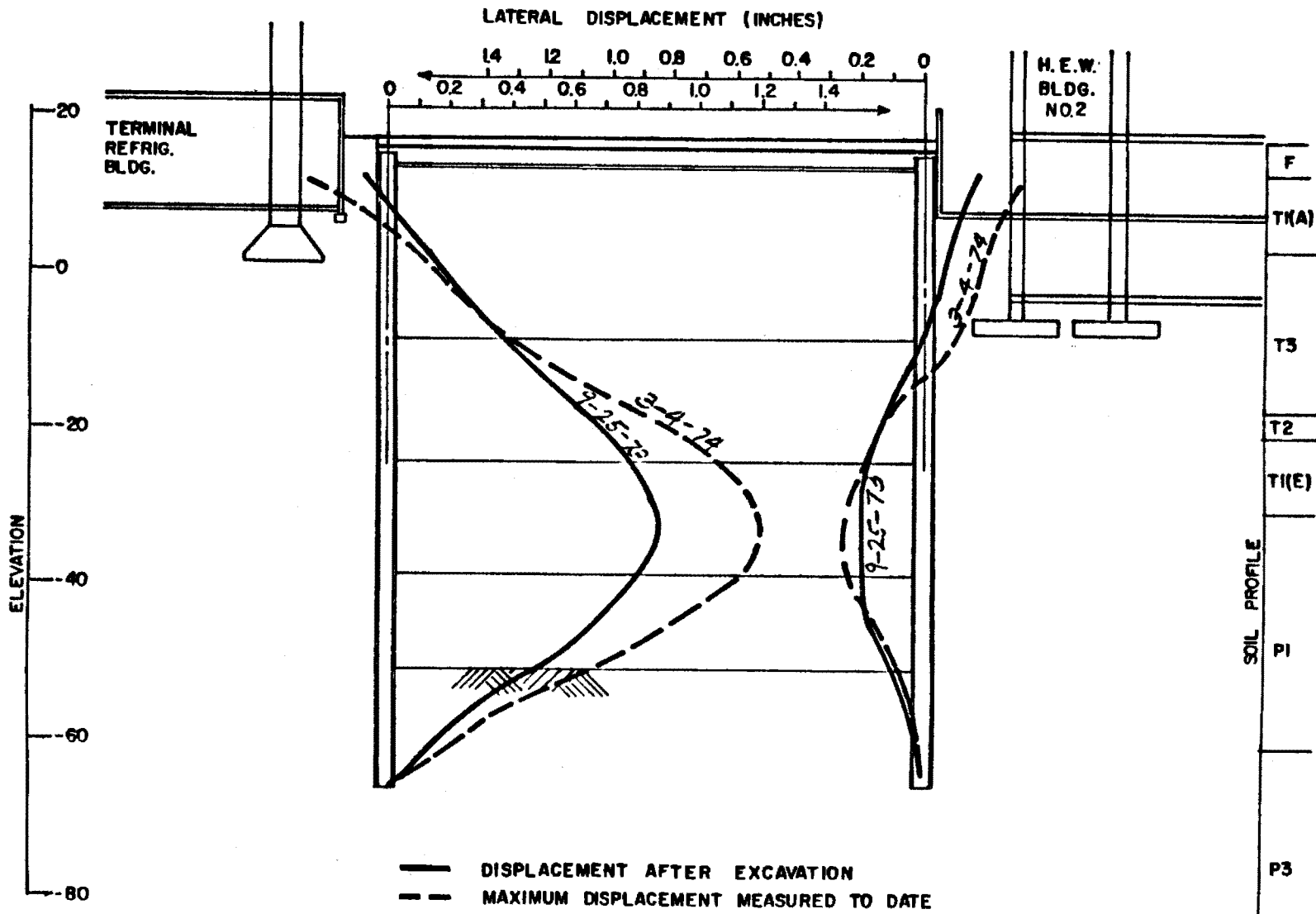


FIGURE 8 INCLINOMETER CASINGS 21-N & 21-S

# INCLINOMETER # 34-N & 34-S

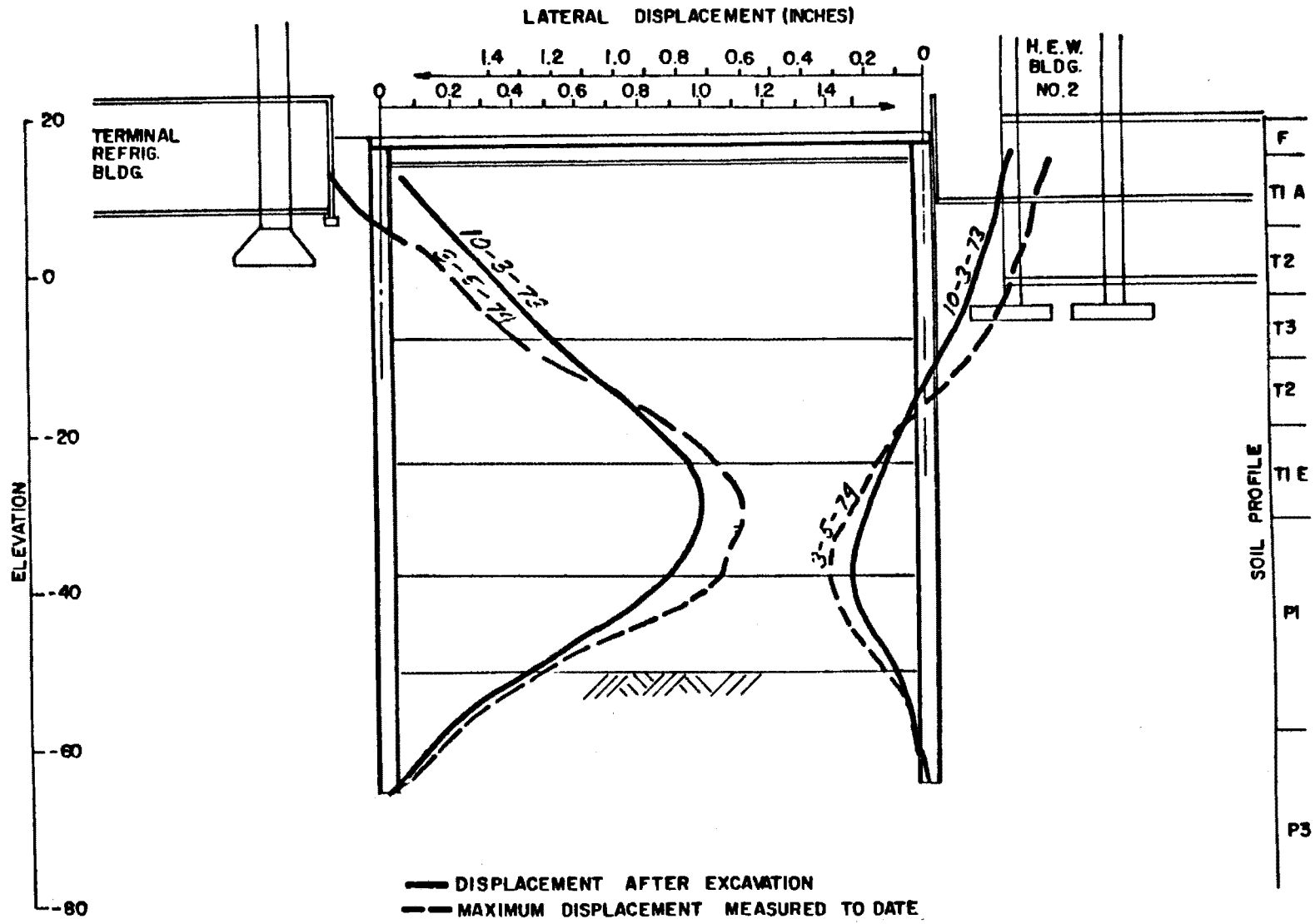


FIGURE 9 INCLINOMETER CASINGS 34-N & 34-S

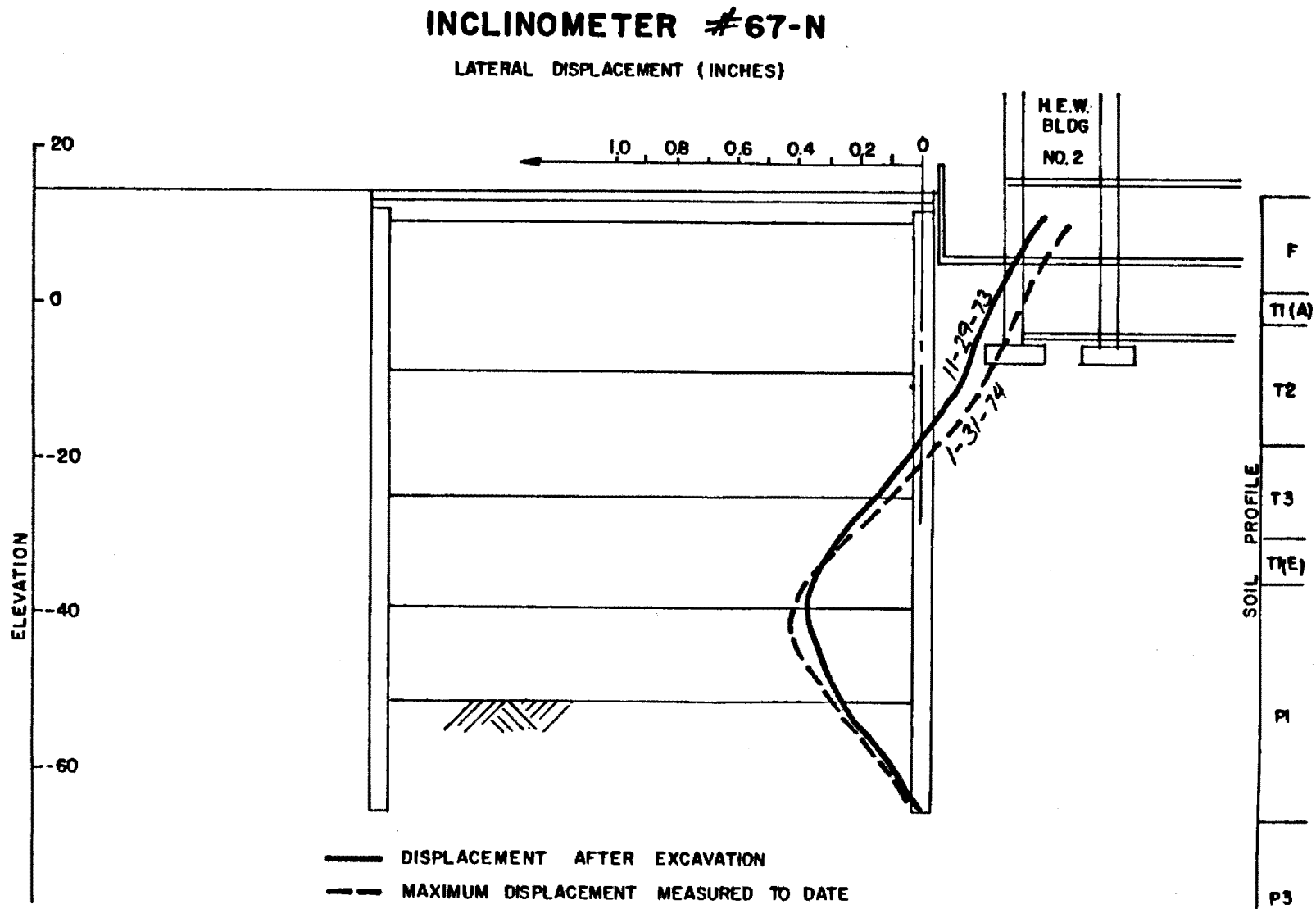


FIGURE 10 INCLINOMETER CASING 67-N

# INCLINOMETER # 98-N & 98-S

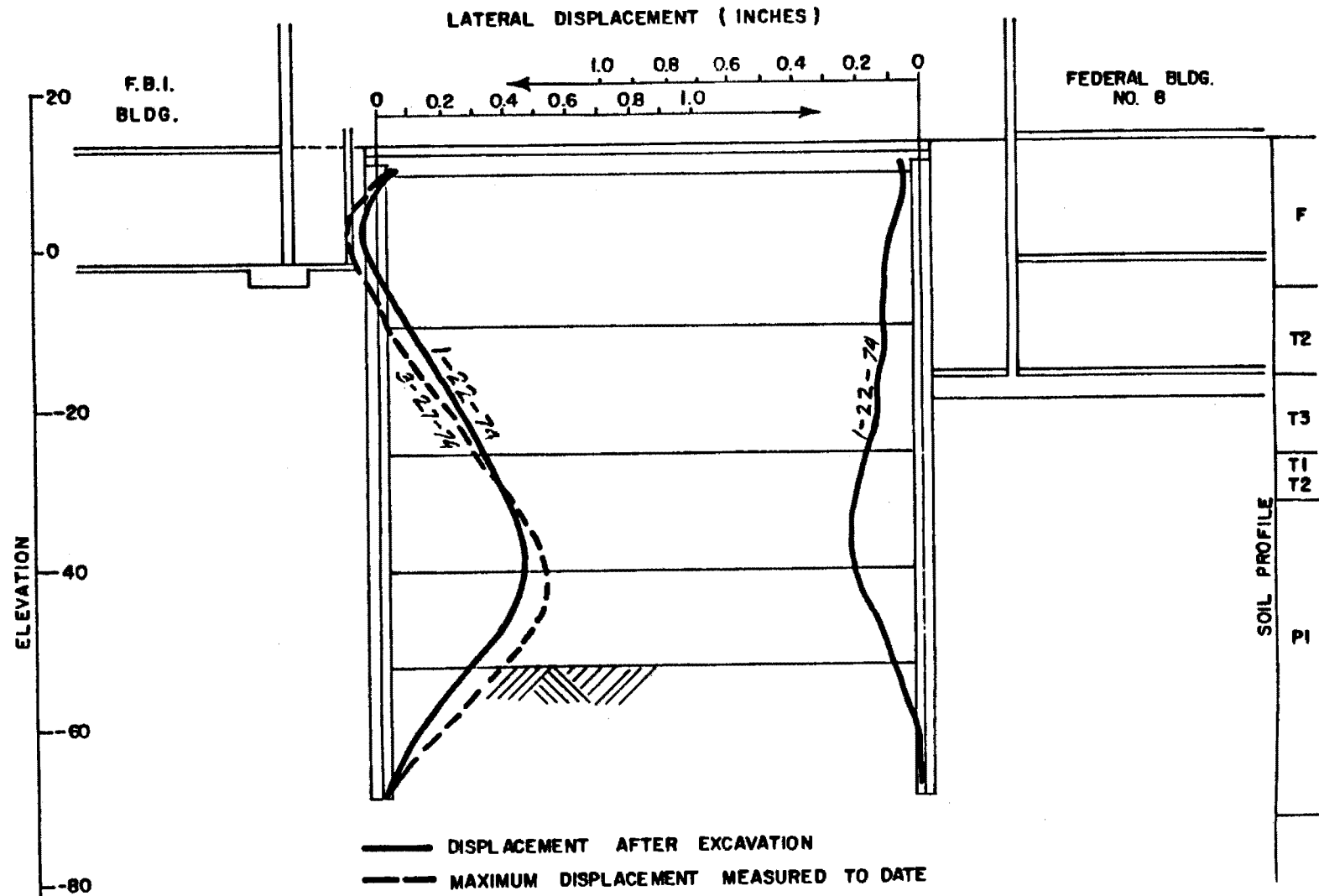


FIGURE 11 INCLINOMETER CASINGS 98-N & 98-S

## VI. DISCUSSION OF INSTRUMENTATION RESULTS

### INCLINOMETER DATA

In general, the inclinometer data in this paper do not present any surprises. Section IV, CASINGS OUTSIDE SLURRY WALL, indicates roughly the same magnitude of ground movement into the slurry panel excavation as reported by Lambe, et al.<sup>(1)</sup> Section V, CASINGS INSIDE SLURRY WALL, indicates that both the shape and magnitude of the slurry wall lateral movement were roughly comparable to the movement of soldier pile lagged walls for similar excavations.<sup>(2)</sup>

Excavation of the soil between the slurry walls generally proceeded from west to east. Consequently, the first deep excavation occurred in front of the Terminal Refrigeration Building. This was also the heaviest of the four buildings adjacent to the Federal Center S.W. Station excavation. As the excavation progressed, the movements shown in Figure 7 were observed and it became obvious that the wall movements would exceed the specified limit of 3/4 in. (20 mm). However, careful surveys of the adjacent buildings (Terminal Refrigeration Building and HEW Building 2) indicated they were not moving. Consequently, the excavation work was allowed to proceed without installation of additional tiers of bracing as required in the contract. Close monitoring continued until the excavation reached final grade, but no excessive movements developed.

As the excavation progressed eastward past the Terminal Refrigeration Building, the lateral wall movements were generally smaller and never again approached the specified maximum of 3/4 in. (2 mm).

## BUILDING MOVEMENT DATA

The horizontal building movements summarized in Figure 1 are generally less than the accuracy of the measurements, and can therefore be considered insignificant.

The vertical movements of the building faces are summarized on Figure 12. Although these movements are also relatively small, some of them are significant. Measurable settlement of the Terminal Refrigeration Building on the western end of the project was recorded, and both buildings on the eastern end of the project experienced heave.

The settlement or heave of these buildings during excavation can be explained by the following:

1. Building Weight. The Terminal Refrigeration Building is appreciably heavier than the other three buildings and, consequently it is the only building that experienced significant settlement.
2. Slurry Wall Movement. As the slurry wall moved laterally, the adjacent soil tended to move downward and laterally toward the wall. Initially, the shearing of the soil caused bulking (dilatancy) of the compact granular soil. Consequently, small lateral movements of the slurry wall did not cause comparable settlement of the buildings (e.g., the increased volume of soil bulking nearly equalled the volume of wall displacement). However the slurry wall

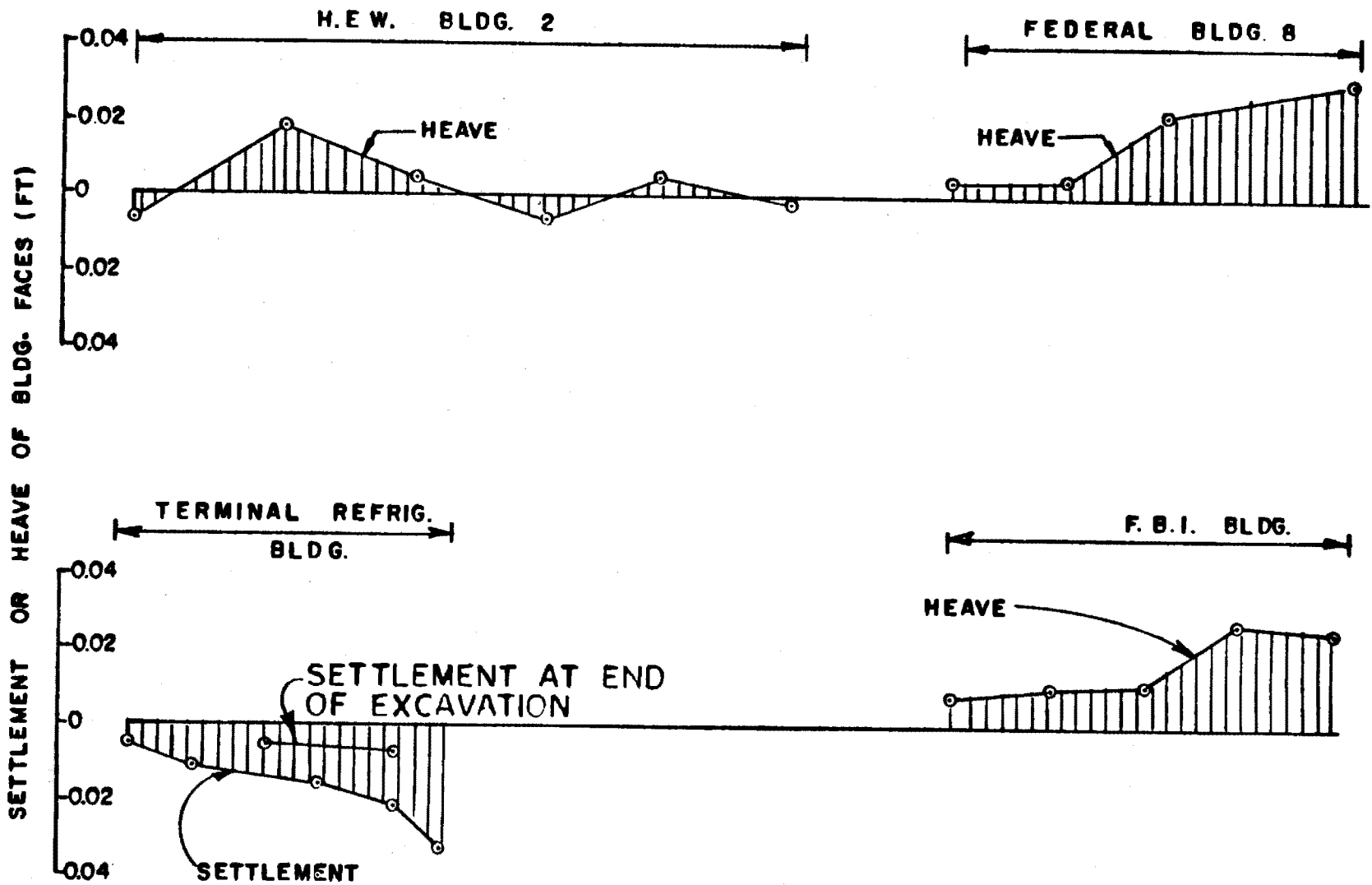
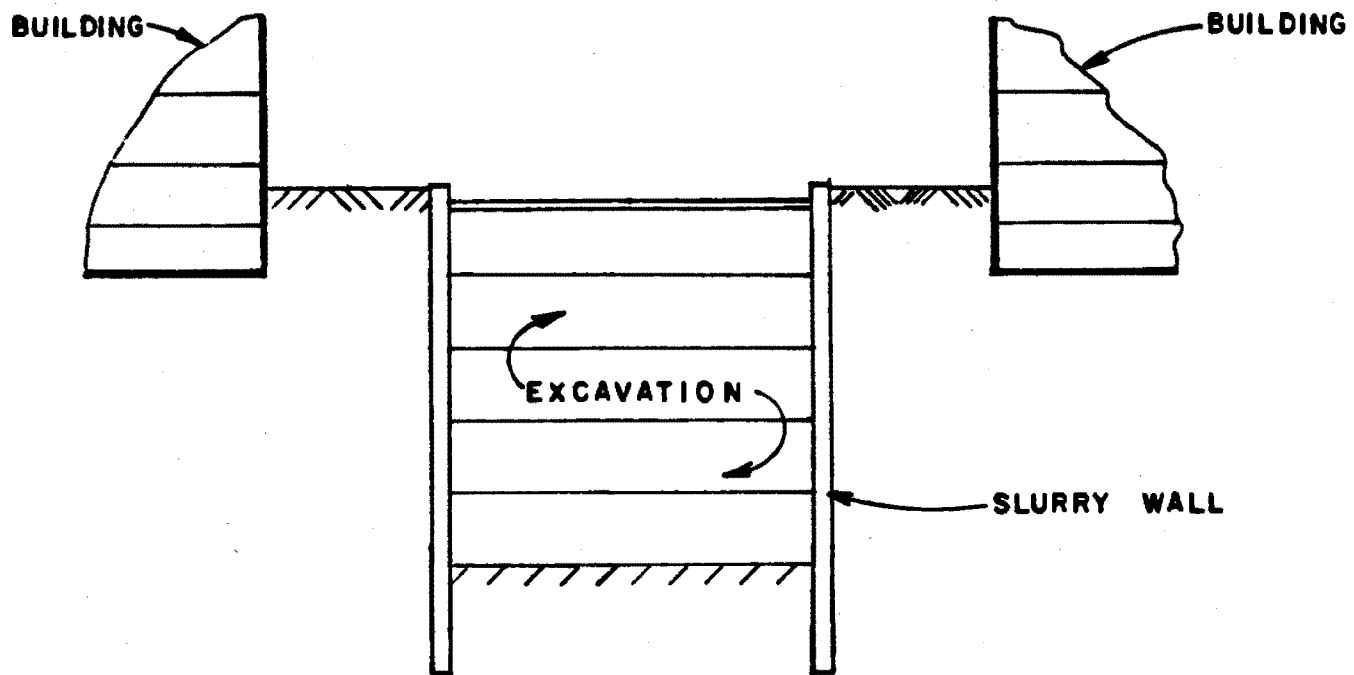


FIGURE 12 - Vertical Movement of Bldg. Faces



movements at the Terminal Refrigeration Building were eventually sufficient to cause significant settlement. This did not occur until after the excavation was completed and the METRO Station was under construction. Construction required the lower strut levels to be removed which allowed additional wall movement.

3. Foundation Heave. As indicated in Figure 13, the deep foundation material was unweighted by the excavation. Heave was not confined to the bottom of the excavation, but also affected areas outside the slurry walls, which may account for the slight heave of the buildings on the eastern end of the project.



DEEP SEATED HEAVE  
 CAUSED BY LOAD REDUCTION  
 DUE TO EXCAVATION

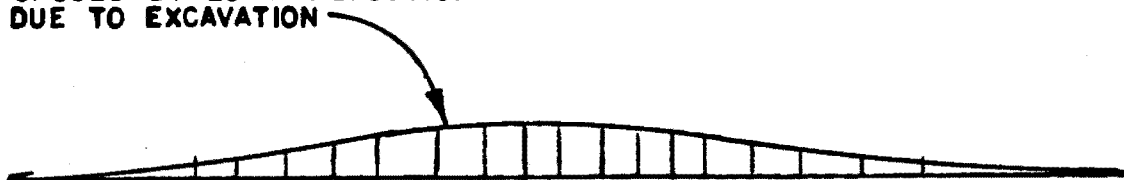


FIGURE 13 DEEP SEATED HEAVE  
 (NTS)

## VII. CONCLUSIONS

The use of slurry walls in lieu of underpinning was successful. They were less expensive and faster to install than underpinning. In addition, they probably caused less damage to the buildings than would have resulted from underpinning.<sup>(3)</sup> There was certainly no distress caused to any of the structures. Workers on the project were not able to detect even minor cosmetic cracking in any building.

As noted in Section VI, the movements of the slurry wall were roughly comparable to those resulting from use of a soldier pile lagged wall. However, the slurry walls were much more effective in preventing excessive movement of the nearby structures.<sup>(4)</sup> This indicates that soil loss during the lagging process and subsequent soil creep around soldier piles is a major cause of ground movement and building settlement behind soldier pile lagged walls.

#### ACKNOWLEDGMENTS

The writer acknowledges support received from the Washington Metropolitan Area Transit Authority. Appreciation is also due to the Section Designer, Praeger Kavanagh Waterbury; the General Soil Consultant, Mueser, Rutledge, Wentworth & Johnston; and the Contractor, Mergentime-Steers-Arundel.

## REFERENCES

1. Lambe, T. W., L. A. Wolfskill, and W. E. Jaworski, "The Performance Of A Subway Excavation," Proc. of ASCE Specialty Conf. on Perf. of Earth and Earth Supported Structures, Vol. 1, Part 2, pp. 1403-1424, 1972.
2. O'Rourke, T. D., E. J. Cording, and M. Boscardin, "The Ground Movements Related to Braced Excavation and Their Influence on Adjacent Buildings," Final Report Prepared for U.S. Dept. of Trans., Report No. DOT-TST 76T 23, 1976.
3. Ware, K. R., "Underpinning Methods and Related Movements," Proc. of the 1974 Rapid Excavation & Tunneling Conference, Vol. 2, pp. 1255-1274, 1974.
4. Peck, R. B., "Deep Excavations and Tunneling in Soft Ground," Proc. 7th Int'l. Conf. on Soil Mech. and Found. Eng., Mexico City, State-of-the-Art, Vol. 1, pp. 225-290, 1969.

SPEAKER: Kenneth Ware  
Bechtel, Inc.

Oliver Gilbert  
Woodward-Clyde

Question:

Do you have any transverse settlement sections cutting into the buildings?

Mr. Ware

Answer:

Yes, along the face of the buildings. Unfortunately, when you have buildings like the FBI building, you can't get into them to do any surveying inside--and it was just as difficult with the other buildings.

G. Wayne Clough  
Stanford University

Question:

Just a quick one, Ken. If this could possibly be a mechanism for those buildings on the right side heaving up, it seems like the system was kind of wracking in that direction and you were getting one inch movement on the other side and less movement on the right side. If it couldn't be due to the wracking, then the buildings on the right side were going up and the buildings on the left side were sinking down a little bit.

Mr. Ware

Answer:

I think that wracking was definitely the case on the western end of the project. But there was not much wracking at the eastern end of the project where we did have the heave-up; that is, both buildings on the eastern end heaved up. It is difficult to explain why those heaved up and not the other end, except that both buildings on the other end were significantly heavier, the Terminal Refrigeration Building being by far the heavier of the two.

F. A. Bares  
Parsons, Brinckerhoff

Question:

I would like to confirm what you have said about the heaves. This is something that puzzled us a long while ago. It was in 1960

Mr. Bares  
(Cont'd)

or 1961 in Milan, when we were constructing the subway there, there was a big excavation, a deep excavation, a large excavation. We started noticing that the buildings on the side were starting to come up and nobody could understand why. Then we started to think it was because we unloaded the ground and the ground practically lifted itself up. It was not a simple case because at that time the excavation was between the Cathedral of Milan and it is a rather huge, heavy building, and dealing with the cathedral was kind of a sensitive problem, so I wanted just to tell you.

Mr. Ware

Answer:

Thank you very much.

# DIAPHRAGM WALL EXPERIENCES IN JAPAN

by

SEIKEN FUKUI  
TOKYO METROPOLITAN GOVERNMENT  
TOKYO, JAPAN

## ABSTRACT

In Japan, it was in 1959 that the diaphragm wall was first used as a conventional temporary ground retaining wall.

Diaphragm walls were originally introduced to increase the strength and stability of temporary structures and to minimize damage to adjacent structures due to ground deformation. But in those early days their use was limited to temporary applications.

Later in 1961, diaphragm walls were used as parts of permanent structures as an economical measure. Since then diaphragm walls have frequently been used with the reverse construction method, in which the excavation and concrete placing processes are repeated from the top down. This type of construction has been adopted to minimize deformation and stresses.

Design problems, however, still arise when diaphragm walls are used as parts of permanent structures.

It is often the case that tunnel walls incorporating diaphragm walls are considered to withstand the same external loads as composite walls, even though there is fear that stresses in diaphragm walls may develop in excess of the allowable limits when final loads are applied. In Japan there is not yet any established way of dealing with this problem.

As for wall deviation, various types of trench excavating machinery and various techniques have been developed to minimize wall deviation. These machines and techniques have been successfully applied with various ground conditions.

Regarding the strength of slurry concrete and the control of slurry, most of the problems have been solved on the basis of past experience.



## DIAPHRAGM WALL EXPERIENCES IN JAPAN

### 1. Introduction

The first diaphragm wall in Japan was employed in the watertight facing of Hatanagi Dam of Chubu Electric Company in 1959 by the ICOS method, which was introduced from Italy. Thereafter, the Else, CCCF, Soletanche and other methods were introduced from 1961 to 1966. Japanese clients, contractors and equipment manufacturers improved and adapted these methods to Japanese ground conditions and social conditions and also developed new excavating machines. The method has now been successfully employed in so many structures that Japan can be considered one of the most developed countries in the world in the field of diaphragm wall construction.

The reason for this success is, needless to say, the characteristics of this method: safety and pollution-free execution, highly rigid retaining walls, a high degree of watertightness, little noise and vibration during construction, and the fact that deformation of adjoining structures and ground settlement are kept to a minimum.

This method was, in the early years of application, usually used for temporary retaining walls. Recently, however, it has been used as permanent structures or as a part of permanent structures, as design and construction techniques improved and as its advantages from the viewpoint of economy and durability became apparent.

The first diaphragm wall as a part of a permanent structure in transportation facilities was applied in the Honan-cho section of No. 4 subway line (Marunouchi Line) in Tokyo in 1961, and in the Kakigara-cho section of No. 2 subway line (Hibiya Line) in Tokyo in 1962. The ICOS method was employed to construct a retaining wall which would become the side wall of the completed subway tunnel. In those days this method was restricted to good ground conditions and comparatively shallow tunnels, and the wall was used as a permanent structure without a secondary wall. Later, improvement of construction joints, quality control of slurry and concrete, and other work controls have extended the range of the applications: it has become available for any ground condition, from a thick deposit of weak alluvium which is characteristic in Japan, to hard rock; it is now employed to form not only structure walls but free-shapes and large yield-strength foundations attained by joining walls polygonally in place of piles, wells, caisson foundations, etc.

However, at present this method is still undergoing technical development and there remain many problems. Among the undefined factors which we have to resolve relying on our experience in the future are a design method to be used when a secondary wall is cast incorporating a diaphragm wall. Further research and development will certainly lead to other new applications of this method.

2. Types of excavating machinery used and their characteristics

Typical excavating machines used in Japan today, are shown in the following table. Each type has its own special characteristics. (Table 2)

3. Diaphragm walls used as a part of a permanent structure (Table 3)

4. Types of construction joints used in diaphragm walls and their characteristics

While there have been many improvements in the structure of diaphragm wall joints, reinforcements, etc., further development is expected.

4.1 Types of panel construction joints (Fig. 4.1.)

4.2 An example of the arrangement of a steel cage and its joint (Fig. 4.2.)

4.3 An example of the bar arrangement for connecting a diaphragm wall and a slab (Fig. 4.3.)

4.4 An example of the joint connecting a diaphragm wall and a secondary wall to consist of one unit.

In the case of composite walls, unifying is undertaken by recovering bent reinforcements, shear connectors or steel plates, which are buried in a diaphragm wall, then welding them to reinforcements in a secondary wall in the same way as shown in Fig. 4.3.

## 5. Drawings of connection reinforcements

Doweling out of reinforcements is generally done by heat treatment. The result of a heating test conducted by Osaka Rapid Transit Railway Construction Headquarters is as follows:

- 1) Temperature between 400°C and 800°C effects 2 - 3 kg/mm<sup>2</sup> less yield strength than in normal temperature, 3 - 4 kg/mm<sup>2</sup> less tensile strength and 20% less elongation, but the standard value of SD30 (whose yield strength is 30 kg/cm<sup>2</sup>) is sufficient.
- 2) For doweling out 30 - 40 seconds are enough. It is reported that, because the base metal is threatened with melting when the heating temperature is high, it is desired to limit the temperature to 600°C occasionally checking by an optical thermometer, to use propane gas which has low temperature rise ratio for heating, and to employ experts.

## 6. Design types of diaphragm walls used as a part of a permanent structure.

Four methods are considered:

### (1) Single wall method (Fig. 6.1)

This method uses the diaphragm wall for a vertical structure wall. In this case, the wall is required to have a high strength section in order to bear not only earth and water pressure but also all loads as a rigid-frame member. Vertical and horizontal loads, temperature stress, drying shrinkage stress, etc. must be considered. As wall thickness depends on the excavators used, the depth of the wall is limited.

Because this method does not need a secondary wall, the stress analysis is considered to be simpler than that of other methods. There are, however, some cases where the thickness of the upper part of the wall is uneconomical. Fig. 6.6 shows this design method.

### (2) Built-up wall method (Fig. 6.2)

In this method a secondary wall is cast contacting the diaphragm wall in order to use it for a part of a permanent structure.

In this structure type, shear between the two walls is not expected, but deformation by moment must be considered.

Though design calculations must be performed separately for the two walls which, though not connected, are in contact, the stresses produced after contact are generally divided between them in proportion to the stiffness ratio in order to avoid extremely complicated calculation. Fig. 6.7 shows the idea of this design method.

$$M_1 = \frac{I_1}{I_1 + I_2} M_o , \quad N_1 = \frac{A_1}{A_1 + A_2} N_o$$

$$M_2 = \frac{I_2}{I_1 + I_2} M_o , \quad N_2 = \frac{A_2}{A_1 + A_2} N_o$$

Where,  $M_o$  : total moment  
 $N_o$  : total axial force  
 $I_1$  : moment of inertia of area of the diaphragm wall  
 $I_2$  : that of the secondary wall  
 $A_1$  : area of the diaphragm wall  
 $A_2$  : that of the secondary wall

### (3) Composite wall method (Fig. 6.3)

In this method the diaphragm wall and its secondary wall are integrated in order to resist the shear stress in the connection by means of shear connectors, etc. buried in the diaphragm wall after cutting the inside face of it. Fig. 6.8 shows the design method. The stress distribution of the composite wall after completion will be as shown in Fig. 6.9.

In this case stresses in the diaphragm wall during construction grow so large that the wall can yield if there is not enough space to contain the increased stresses.

To prevent this, it is necessary to install a thick secondary wall so that the stiffness ratio to the primary wall becomes sufficiently large. In this method, it is possible to assume a larger moment of inertia of area and larger strength for the same total thickness than in the built-up wall method.

But the difference of drying shrinkage strain between the two concrete layers is considered to develop large stresses. Additionally, as is the case of the single wall and the built-up wall, stresses develop according to the location of struts and horizontal members and stresses also develop due to temperature and drying shrinkage.

(4) Separate wall method (Fig. 6.4)

In this method the diaphragm wall and its secondary wall are installed in a structurally separate form as shown in Fig. 6.4. The diaphragm wall bears the earth and water pressure, while slabs of the permanent structure are expected to serve simply as struts.

Therefore, it is not necessary to consider that rigid-frame stresses are transferred to the diaphragm wall.

Even with the greatest thickness of the existing diaphragm wall, difficulties arise from the viewpoint of strength. In such cases, it is possible to reduce the stresses in the diaphragm wall by providing intermediate supports between horizontal members as shown in Fig. 6.5.

But in this case the inner vertical wall is considered to bear earth and water pressure in proportion to its stiffness ratio to the diaphragm wall, and thus characteristics similar to the built-up wall method are produced. Fig. 6.10 shows the idea of this design method.

7. Thickness of diaphragm walls

Excavation thickness is in many cases decided by the bit diameter or bit width (nominal thickness) of the excavating machine. However, in the case of dense slurry, mud cake coheres to the face of the trench wall and reduces the effective section. In addition the machine can displace the face of the wall. Therefore the design thickness generally employed is about 40 mm less than the bit diameter.

8. Allowable unit stress

The allowable unit stress in the concrete and reinforcement of diaphragm walls is rather less than usual as shown in Table 8.

## 9. Work Control

### 9.1 Deviation Control in Vertical Accuracy of Excavated Trench

Any perfect apparatus has not yet been found for measuring and controlling the vertical accuracy of excavated trenches.

In most cases, the accuracy is ensured on the basis of past experiences.

#### 1) Vertical-Accuracy Measuring Apparatus of B-W Drill (Fig. 9.1)

Since required feed pressure for drill bits is provided by a portion of the weight of the motor drill, the remaining downward force tends to direct the motor drill in true vertical direction by gravity. Consequently the BW drill has natural tendency for vertical excavation.

To ensure maximum vertical accuracy, the BW drill is equipped with correcting device against deflection.

A pick-up of deflection indicator, which detects the deflection of the motor drill from vertical and horizontal direction, is equipped into the motor drill.

Detected deflection appears on the gauges in front of operator's platform.

Operator can then correct the deflection of the motor drill by the manipulation of adjustable guide provided on upper part of the motor drill.

The operation of adjustable guide can be done with valve box which is connected with adjustable guide by remote control.

Thus, the BW drill can carry out the excavation always ensuring the accuracy by this device, and enables building the diaphragm wall within specified allowance. This mechanism is unique and only available in the BW drill.

#### 2) Ultrasonic-wave Measuring Apparatus (free from excavation systems)

This apparatus, as shown in Fig. 9.2, transmits an ultrasonic wave to both walls of a vertical trench, and receives the wave which is reflected by the walls.

This apparatus has an automatic recording system, which can record the depth of trench at one-meter interval, the condition of the trench wall face, and the trench wall width simultaneously.

The frequency of transmitted ultrasonic wave is 200 K Hz which can work even in thick slime. Also, it has a special wiring device so that error in measuring accuracy can be minimized in deep trenches.

This device is light in weight, and easy to move.

### 3) Contact Measuring Apparatus

As shown in Fig. 9.3, this apparatus measures the width of trench by opening two arms towards each trench wall.

These arms are driven by motor equipped in the apparatus. The apparatus can keep its vertical position by hanging a weight below the apparatus.

When the arm reaches the trench wall and contacts the wall face, the opening action of the arm stops, and the opening width between one arm and the other (Trench width) is recorded.

## 9.2 Slurry Control

Generally, bentonite or polymer is used as stabilizing fluids, and let me explain about the control of a bentonite slurry which is the most popular.

### 1) Design of Mix Proportion

In Japan, the required Funnel Viscosity (F. V.) has been obtained on the basis of past experiences, in accordance with differences of soil condition, and differences of excavating system and circulation type of slurry.

The concentration of bentonite and CMC (filtration control agent) to be added is determined by a chart showing the relation between the concentration of various bentonite slurries and the Funnel Viscosity.

The dispersing agent is used at the concentration of 0 to 0.5%, and when the viscosity is decreasing, it can be adjusted by adding the amount of bentonite and CMC.

The standard specific gravity of slurry, or stabilizing fluids, is 1.03 to 1.07, but in some specific cases, some weighting agents are added on the basis of an empirical formula.

Also, the density of agents to be added for preventing the escape of slurry is difficult at first, and therefore, the density should be changed little by little, in accordance with the degree of slurry loss during excavation.

As soon as the design of mix proportion is decided, the adaptability of the specific slurry to the soil should be checked by trial mix, but in case that the required performance cannot be obtained, the basic change in the design of mix proportion is required. (The first panel should be checked.)

## 2) Slurry Control

It is recommended to make criteria for characteristics of slurry, applicable to ground conditions, and to change the criteria in accordance with the construction procedures.

The following items are generally used for the slurry control test in Japan.

By evaluating the results of these tests, with the control criteria which are based on the actual application, the degree of slurry deterioration, the cause of deterioration, modification of mix proportion and re-use of slurry already used should be determined.

- (1) Specific Gravity
- (2) Viscosity
- (3) Formation of a Satisfactory Impermeable Mud Cake (fluid loss, cake thickness and strength)
- (4) Sand Content
- (5) Stability Against Gravity
- (6) Salt Content
- (7) PH

The test on item (1) through (3) should be carried out without fail.



In order to maintain the prescribed quality, constant check on the bentonite slurry must be done at the following five stages.

- (1) The fresh bentonite slurry. (Once every 100 m<sup>3</sup> of the slurry just after mixing and in 24 hours after mixing.)
- (2) Slurry to be supplied into the trench. (Slurry in the storage tank.)
- (3) Slurry in the trench. (During the initial excavation stage, and during the period from the final excavation till preparation for concreting.)
- (4) Recycling slurry during excavation.
- (5) Slurry displaced with concrete.

### 9.3 Quality Control of Concrete

#### 1) Mixing of Concrete

For mixing, concrete should generally have such good workability that it should have more than 370 kg of cement by weight per 1 m<sup>3</sup> of concrete, that water-cement ratio should be less than 50%, and that the slump test value should be about 18 to 22 cm.

Such workable concrete, when it is deposited, will have no problem in compressive strength (vertical, horizontal and width direction), bond strength of concrete (for deformed reinforcing bar), and tensile strength against the specified standard strength of concrete.

#### 2) Quality Control of Concrete

The following items should be required for quality control.

- (1) Trial mixing should be done prior to placing the concrete, and it should be confirmed that the concrete has the strength sufficient to the required standards, by testing the compressive strength of the concrete when it is aged 3 days, 7 days and 28 days respectively.
- (2) The slump and air content of concrete at the job site should be tested more than twice for each panel.

- (3) Sampling of test piece of concrete at the job site should be done, and the compressive strength test should be carried out for each panel, or once a day.

#### 9.4 Control of Concrete Placement

The following should be done:

- (1) The slime (excavated earth particles) of trench bottom should be removed cleanly before depositing concrete.
- (2) Concrete placing should be completed within 1.5 hours after mixing. (Within 1 hour in warm weather.)
- (3) When the slump and flow characteristics are found to be decreasing when concrete arrives at a job site, such concrete should not be used.
- (4) The tremie pipes which are used for concrete placing should have as large diameter as possible.
- (5) The tremie pipes should be well cleaned and inspected, especially care should be taken for the watertightness of joints.
- (6) Concrete should be placed continuously, and not intermittently.
- (7) When a hopper is used, a pipe for air duct should be inserted into the concrete in hopper.
- (8) The tremie pipes which are inserted into the concrete should always be positioned at the depth of more than 1.5 meters.
- (9) The volume of the deposited concrete and its level should always be calculated accurately.
- (10) In case the concrete does not deposit easily, the tremie pipes are often moved up and down. But, such movement should not exceed 30 cm.
- (11) The tremie pipes should not be moved horizontally during concrete placing.
- (12) Contamination of concrete to slurry causes the slurry deterioration. Therefore, concrete should not be spilt into the trench during concrete placing.

- (13) The top portion of deposited concrete always has contact with bentonite slurry, and sometimes it is contaminated with soil. Therefore, the concrete should be deposited additionally by 50 cm higher, and the lean concrete topping should be removed after its hardening.

## 10. Construction Examples

- 10.1 Example of the design and execution of the built-up wall method using diaphragm walls as a part of a permanent structure. Kudan-shita No. 1 section of No. 10 Subway Line and No. 11 Subway Line in Tokyo (1976 - 1978).

1) General view of this section (Fig. 10.1)

This section is an approximately 230 m long station structure having four irregular stories with a width of approximately 41 m and an excavation depth of approximately 20 - 33 m, since subway No. 10 and No. 11 run parallel. Because the construction area had a surface with a gradient of 7%, a moat of the former Edo castle on one side and tall buildings standing nearby on the other side, there was eccentric pressure in the excavation. Due to the fact that the excavation width was broader than the road width, decking had to be laid partially over private land. In addition, the working area was difficult to maintain and working time was restricted.

2) Ground condition (Fig. 10.2)

3) Reason for employing the diaphragm wall and a general view of the construction.

A diaphragm wall was constructed in the 80 m long section at the end of the station as shown in Fig. 10.1.

The diaphragm wall of this section was planned to prevent entrance of moat water and to excavate the water-bearing sand ground.

Where the construction was directly from the road surface, the working area was difficult to maintain, working time was restricted, and problems were presented by the road gradient of 7%. There were also obstacles such as buried equipment or previously constructed utilities. Therefore two-step retaining walls were employed and H-piles were installed with an earth-auger as shown in Fig. 10.1.

Then the first step excavation was executed to a depth of approximately 10 m below the ground level, the working face was finished flat, and under-road type diaphragm walls were constructed under the decking.

The diaphragm wall thickness is 80 cm, and the maximum depth is 28 m. The construction joint used is shown in Fig. 10.3, and the arrangement of steel cage bars in Fig. 10.4.

The element length is 5 m. Two CIS58HS II-type of SOLE-TANCHE was used as an excavating machine. Controlled by an ultrasonic measuring apparatus the vertical accuracy of the elements was between 1/150 and 1/1300.

The mix proportion of the ready-mixed concrete and the result of the strength test of cast-in-place concrete cores are shown in Fig. 10.1 and Fig. 10.2. The slurry mixing ratio is shown in Table 10.3.

#### 4) Construction of the permanent structure

By means of the reverse construction method, a rigid-frame structure was constructed on the inner side of the diaphragm wall as a built-up wall. The reasons for employing the reverse construction method are as follows: Due to the large excavation width and depth, the ordinary cut-and-cover method would have required an excessive amount of steel timbering, so it would not have been a good plan from the viewpoint of economy and working term. Each side of the road had a different landform which produced the eccentric pressures as mentioned; therefore the retaining method would have been complicated, timbering would have been so extensive, and a great many joints (which can be weak points), would have been required. Construction accuracy would have been lowered, and adjoining buildings might have suffered settlement or deformation.

Therefore the safest and most reliable method was selected. The reverse construction method employs a high-stiffness reinforced concrete slab, a part of the structure, instead of steel timbering.

The slab of the permanent structure was executed after flattening the excavation face and then casting 10 cm - thick flattening concrete as a form. In order to insure the connection of diaphragm walls and slabs, connection bars which had been buried in the diaphragm walls were recovered, then bent out by heating, and connected. As for

the side wall part, in order to construct the built-up wall, the entire inner face of the diaphragm wall was cut and smoothed; then the secondary wall was cast sufficiently thick according to the depth. Consequently a unified structure was formed.

In this reverse construction method, because the excavation uses the slabs of the permanent structure as struts, the rigidity of the struts fits the stiffness of the diaphragm wall. Besides, with this method the deformation of the diaphragm walls is the least of all, and the allowance of unit stress is high enough. Thus this can be considered a safe and reliable construction method.

5) Arrangement of construction equipment (Fig. 10.5)

10.2 Example of the design and execution of either the single wall method or the composite wall method using diaphragm walls as a part of a permanent structure. Kire Station construction of No. 2 Subway Line in Osaka (1975 - 1976)

1) General view of this section

This section has a total length of 464 m and consists of a station section (including a crossover section) and a three-track section. Since the side of this section was very close to a buried trunk sewer (horseshoe-shaped with a inner section of 2.5 x 2.5 m), an underground diaphragm wall was employed to protect it. This diaphragm wall, a part of the permanent structure, was designed and built as a composite wall in the crossover section and as a single wall in the other sections.

2) Ground conditions

From the surface of the road to a depth of 6 m was a deposit of alluvium, under which was clay and sand interbedded with diluvium. The water level was GL-2.0 m.

3) General view of the diaphragm walls

Preceding the diaphragm wall construction, working space was created by excavating to a shallow depth between two lines of intermediate steel piles. Construction equipment was then placed under the road in order to reduce construction noise as well as to restrict the area of the road surface occupied by machinery. Consequently, the road surface suffered only the occupation by excavators and cranes, and night-and-day work was possible.

The diaphragm wall thickness and the excavation depth were 80 cm and 20.5 m maximum respectively in the station section, and 70 cm and 16.8 m maximum respectively in the three-track section. The element length was 5.5 m. Construction joints were made by the common interlocking method. Three BWN5580 were used as excavators. Panel verticalness (the aim was to attain 1/150) was tested throughout the excavation by a deflection indicator provided in the BW, and was adjusted with correcting equipment. In addition, when the excavation was completed ultra-sonic tests were carried out; as a result a few low-accuracy elements were found.

The result of the strength test of cast-in-place concrete cores was between 291 kg/cm<sup>2</sup> and 343 kg/cm<sup>2</sup>.

#### 4) Construction of the permanent structure

Normal construction methods were employed to construct it from the floor slab to the roof slab. For the crossover section, a 70 m - thick wall was cast on the inner side of the diaphragm wall to form a composite wall. Connection bars were bent in styrofoam placed along the inner-side main reinforcements of the diaphragm wall for easy recovery.

The bars were bent out by heating. For waterproofing in the station section, the roof slab was covered with sheets the ends of which were bent up at the wall face. For the floor slab, an expansive concrete was used. In order to waterproof the connection between the diaphragm wall and the secondary slab where it is difficult to prevent leaks, the expansion of the concrete and the resulting compressive stress (though it is very small) will cause the encroachment of the concrete into the already finished diaphragm wall concrete and thus insure a tight connection. As a result water leakage from the connection was not seen, neither was there any crack in the slab.

#### 5) Problems

In the case of single walls, water often leaks from construction joints on low-vertical parts. In such cases it is necessary to cut the leaking point and fill with waterproofing mortar, or grout if the leakage is considerable. Since the repair work, no leakage has been seen.

#### 6) Analysis by instrumentation

Various instruments were installed into the composite wall of the crossover section to examine its mechanical behavior.



Table 3. Diaphragm walls used as integral parts of permanent structures  
in transportation facilities

3-1

| Project   | Client                               | Contractor                      | Outset of<br>Constr. | Particulars of<br>diaphragm wall |                |                           | Wall<br>Application  | Soil<br>Condition     | Excavating<br>Machinery         |
|---|--------------------------------------|---------------------------------|----------------------|----------------------------------|----------------|---------------------------|----------------------|-----------------------|---------------------------------|
|   |                                      |                                 |                      | Width<br>(mm)                    | Depth<br>(M)   | Area<br>(M <sup>2</sup> ) |                      |                       |                                 |
| NO. 4 Subway Line in Tokyo<br>Ogikubo turnout track           | Teito Rapid<br>Transit Authority     | Hazama-Gumi<br>Ltd.             | April,<br>1961       | 650                              | 15             | 504                       | side wall            | loam, gravel          | ICOS<br>clamshell               |
| NO. 2 Subway Line in Tokyo<br>Kakigara-cho Section            | ditto                                | ditto                           | Mar., '62            | 750                              | 17             | 1206                      | side wall            | silty clay            | ditto                           |
| NO. 2 Subway Line in Osaka<br>Tenmanbashi Section             | Osaka Municipal<br>Subway            | ditto                           | Nov., '64            | 550                              | 18             | 4600                      | side wall            | sand, clay            | ditto                           |
| Pier of Tamagawa Bridge                                       | Odakyu Electric<br>Railway Co. Ltd.  | ditto                           | Jan., '65            | 600                              | 10.5           | 586                       | bridge<br>foundation | gravel                | ICOS<br>bit                     |
| ditto   | ditto                                | ditto                           | ditto                | 600                              | 10.5           | 403                       | ditto                | ditto                 | ICOS<br>clamshell               |
| NO. 5 Subway Line in Tokyo<br>Reigan Bridge Section           | Teito Rapid<br>Transit Authority     | Mitsui<br>Constr. Co. Ltd.      | April, '65           | 800                              | 11             | 775                       | side wall            | silty clay            | ditto                           |
| Pier of Sakawagawa Bridge                                     | Odakyu Electric<br>Railway Co. Ltd.  | Hazama-Gumi<br>Ltd.             | April, '66           | 600                              | 8              | 498                       | bridge<br>foundation | gravel                | ICOS<br>bit                     |
| NO. 6 Subway Line in Osaka<br>Kitahama Station                | Osaka<br>Municipal Subway            | ditto                           | Sept., '66           | 550                              | 19-22          | 9940                      | side wall            | sand, silt            | ICOS<br>clamshell               |
| Nambu Line<br>Pier of Tamagawa Bridge                         | JNR                                  | Nippon ICOS<br>Co.              | Dec., '66            | 600                              | 10             | 1292                      | bridge<br>foundation | gravel                | ICOS<br>bit                     |
| NO. 1 Subway Line in Osaka<br>Higashiumeda Station, Extension | Osaka<br>Municipal Subway            | Hazama-Gumi<br>Ltd.             | Dec., '67            | 600                              | 22             | 416                       | side wall            | sand, silt            | ICOS<br>clamshell               |
| Musashino Line<br>Urawa Tunnel                                | Japan Railway<br>Constr. Corporation | Kumagai-Gumi<br>Co. Ltd.        | '67                  | 500                              | 16.5           | 12256                     | side wall            | loam, sand            | ELSE                            |
| NO. 4 Subway Line in Osaka<br>NO. 22 Section                  | Osaka<br>Municipal Subway            | Taisei Constr.<br>Co. Ltd.      | Feb., '68            | 600                              | 16             | 582                       | side wall            | silty clay            | ICOS<br>clamshell               |
| Pier of Sakawagawa Bridge                                     | Odakyu Electric<br>Railway Co. Ltd.  | Hazama-Gumi<br>Ltd.             | May, '68             | 600                              | 8              | 544                       | bridge<br>foundation | gravel                | ICOS<br>bit                     |
| ditto   | ditto                                | ditto                           | Oct., '68            | 600                              | 8              | 738                       | ditto                | gravel                | ditto                           |
| Tokyo Underground Terminal Station                            | JNR                                  | Ohbayashi-Gumi<br>Ltd.          | June, '68            | 600                              | 20.3 ~<br>25.5 | 15950                     | side wall            | silt, gravel          | Soletanche<br>clamshell,<br>bit |
| Viaduct of Osaka Station<br>for Reconstruction                | JNR                                  | ditto                           | Oct., '68            | 600                              | 11.2 ~<br>18.2 | 3321                      | side wall            | silt, clay            | Soletanche<br>clamshell         |
| NO. 9 Subway Line in Tokyo<br>Nagata-cho Section              | Teito Rapid<br>Transit Authority     | Kumagai-Gumi<br>Co. Ltd.        | '68                  | 600                              | 30             | 3300                      | side wall            | sand                  | Soletanche<br>bit               |
| Viaduct of Osaka Station for Reconstr.                        | JNR                                  | Ohbayashi-Gumi<br>Ltd.          | April, '69           | 600                              | 10.8 ~<br>11.2 | 1519                      | side wall            | silt, clay            | Soletanche<br>clamshell,<br>bit |
| NO. 9 Subway Line in Tokyo<br>Minamiyama Section              | Teito Rapid<br>Transit Authority     | Sato Kogyo<br>Co. Ltd.          | July, '69            | 600                              | 27             | 2610                      | side wall            | loam, gravel          | BW                              |
| Sobu Line<br>Kodenna-cho Station                              | JNR                                  | ditto                           | Aug., '69            | 600                              | 25             | 2800                      | side wall            | silt, gravel          | BW                              |
| Tokyo Underground Terminal Station                            | JNR                                  | The Shimizu<br>Constr. Co. Ltd. | Oct., '69            | 600                              | 21.6           | 3890                      | side wall            | silt, sand,<br>gravel | BW                              |
| ditto   | JNR                                  | Kajima<br>Corporation           | ditto                | 600                              | 20             | 3091                      | side wall            | ditto                 | CCCF                            |

Table 3. Diaphragm walls used as integral parts of permanent structures in transportation facilities

364



|   |                                     |                           |            |            |             |       |                   |                    |                           |
|---|-------------------------------------|---------------------------|------------|------------|-------------|-------|-------------------|--------------------|---------------------------|
| Pier of Tamagawa Bridge                               | Odakyu Electric Railway Co. Ltd.    | Hazama-Gumi Ltd.          | Nov., '69  | 600        | 8           | 1187  | bridge foundation | gravel             | ICOS bit                  |
| Pier of Sakawagawa Bridge                             | ditto                               | ditto                     | Dec., '69  | 600        | 12          | 620   | ditto             | gravel             | ditto                     |
| NO. 9 Subway Line in Tokyo Omotesando NO. 1 Section   | Teito Rapid Transit Authority       | ditto                     | ditto      | 750        | 18          | 829   | side wall         | loam, sand         | ICOS clamshell            |
| Pier of Toyama Bridge                                 | Ministry of Construction            | ditto                     | Jan., '70  | 600        | 10          | 540   | bridge foundation | gravel             | ICOS bit                  |
| NO. 3 Subway Line in Osaka Suminoe Station            | Osaka Municipal Subway              | ditto                     | ditto      | 500        | 17.5        | 2600  | side wall         |                    | ICOS clamshell            |
| NO. 9 Subway Line in Tokyo Kasumigaseki Section       | Teito Rapid Transit Authority       | Tobishima Constr. Co.Ltd. | Feb., '70  | 800        | 13          | 2600  | side wall         | sand               | BW                        |
| Nippori Station Underpass                             | JNR                                 | Hazama-Gumi Ltd.          | ditto      | 600        | 9           | 348   | side wall         | loam, sand         | ICOS clamshell            |
| NO. 9 Subway Line in Tokyo Minamiayama Section        | Teito Rapid Transit Authority       | ditto                     | Sept., '70 | 800        | 18          | 1145  | side wall         | ditto              | ditto                     |
| ditto   | ditto                               | The Zenitaka Corporation  | Oct., '70  | 800        | 18          | 1200  | ditto             | ditto              | ditto                     |
| Pier of Arakawa Bridge                                | Ministry of Construction            | Hazama-Gumi Ltd.          | Nov., '70  | 600        | 15          | 1040  | bridge foundation | gravel             | ICOS bit                  |
| Pier of Sakawagawa Bridge                             | Odakyu Electric Railway Co. Ltd.    | ditto                     | ditto      | 600        | 8           | 1224  | ditto             | gravel             | ditto                     |
| NO. 9 Subway Line in Tokyo Yoyogihachiman Section     | Teito Rapid Transit Authority       | Ohbayashi-Gumi Ltd.       | May, '70   | 800        | 12.8 ~ 21.1 | 4788  | side wall         | silt, loam         | ICOS clamshell            |
| Tokyo Underground Terminal Station                    | JNR                                 | ditto                     | Nov., '70  | 600        | 13.4 ~ 21.1 | 644   | side wall         | sand, silt         | Soletanche bit            |
| NO. 2 Subway Line in Osaka Nakasaki-cho Station       | Osaka Municipal Subway              | Sato Kogyo Co. Ltd.       | Jan., '71  | 800        | 16          | 2434  | side wall         | sand, gravel       | BW                        |
| Pier of Viaduct NO. 522 Section                       | Tokyo Expressway Public Corporation | Maeda Constr. Co.Ltd.     | May, '71   | 1000       | 15          | 4200  | side wall         | ditto              | HB                        |
| NO. 4 Subway Line in Nagoya Aratamabashi Section      | Nagoya Municipal Subway             | Sato Kogyo Co. Ltd.       | July, '71  | 500        | 13~19       | 4512  | side wall         | ditto              | BW                        |
| NO. 10 Subway Line in Tokyo Bakuro-cho Station        | Tokyo Metropolitan Government       | ditto                     | Sept, '71  | 600        | 25~30       | 3800  | side wall         | silt, gravel       | BW                        |
| NO. 3 Subway Line in Yokohama Ogami-cho Section       | Yokohama Municipal Subway           | Ohbayashi-Gumi Ltd.       | ditto      | 800        | 35~45       | 29413 | side wall         | silt, clay         | Soletanche clamshell, bit |
| NO. 8 Subway Line in Tokyo Minamikebukuro Section     | Teito Rapid Transit Authority       | Kumagai-Gumi Co. Ltd.     | Oct., '71  | 800        | 12.9        | 880   | side wall         | loam, clay, gravel | BW                        |
| Pier of Toyama Bridge                                 | Ministry of Construction            | Sato Kogyo Co. Ltd.       | Sept., '72 | 600        | 15          | 2550  | bridge foundation | gravel             | ICOS bit                  |
| Subway Seishin-Line in Kobe Nagata to Suma Section    | Kobe Municipal Subway               | ditto                     | Oct., '72  | 500        | 15          | 10740 | side wall         | silt, gravel       | BW                        |
| Pier of Toyama Bridge                                 | Ministry of Construction            | Hazama-Gumi Ltd.          | Nov., '72  | 600        | 8           | 2249  | bridge foundation | gravel             | ICOS bit                  |
| NO. 111 Supplementary Road and Echujima-Line Crossing | Tokyo Metropolitan Government       | Okumura Constr. Co.Ltd.   | '72        | 400 ~ 1000 | 11~31       | 5110  | breast wall       | sand, clay         | OCW                       |
| Suminoe Ramp  | Hanshin Superhighway Corp.          | ditto                     | '72        | 600        | 10          | 1470  | breast wall       | sand, silty sand   | OCW                       |

Table 3. (Con't) Diaphragm walls used as integral parts of permanent structures in transportation facilities

|  |                                     |                          |            |          |             |       |                   |                       |                           |
|--|-------------------------------------|--------------------------|------------|----------|-------------|-------|-------------------|-----------------------|---------------------------|
| Reconstruction of Keisei Ueno Station                        | Keisei Electric Railway Co. Ltd.    | Ohbayashi-Gumi Ltd.      | Jan., '73  | 600      | 18-26.5     | 4961  | side wall         | sand, clay            | Soletanche clamshell      |
| Extension of Kintetsu Nanba Station                          | Kintetsu Electric Railway Co. Ltd.  | Kajima Corporation       | April, '73 | 700      | 22          | 3860  | side wall         | sand, silt, gravel    | BW                        |
| Subway Seishin Line in Kobe Itajuku Section                  | Kobe Municipal Subway               | ditto                    | Sept., '73 | 500,1000 | 24-28.5     | 1916  | side wall         | silt, gravel          | clamshell                 |
| No.11 Subway Line in Tokyo Muromachi NO. 2 Section           | Teito Rapid Transit Authority       | Sato Kogyo Co. Ltd.      | April, '73 | 600-800  | 20          | 3870  | side wall         | silty clay sand, silt | Soletanche bit            |
| Tokaido Line, Additional Line between Tsurumi and Ofuna      | JNR                                 | Hazama-Gumi Ltd.         | Oct., '73  | 600      | 11          | 585   | side wall         |                       | ICOS clamshell            |
| Highway in Yokohama Kannai Section                           | Yokohama City                       | ditto                    | Nov., '73  | 800      | 43.6        | 2295  | side wall         | silt, sand            | ditto                     |
| Pier of Viaduct NO. 551 Section                              | Tokyo Expressway Public Corporation | Okumura Constr. Co.Ltd.  | '73        | 1200     | 28.5        | 920   | bridge foundation | loam, sand, gravel    | ditto                     |
| Chuo Line Pier of Tamagawa Bridge                            | JNR                                 | Nippon ICOS Co.          | Nov., '73  | 600      | 10          | 1981  | ditto             | gravel                | ICOS bit                  |
| NO. 11 Subway Line in Tokyo Hirakawa-cho Section             | Teito Rapid Transit Authority       | Kumagai-Gumi Co. Ltd.    | '73        | 600,800  | 45          | 3670  | side wall         | sand                  | Soletanche clamshell, bit |
| ditto  | ditto                               | ditto                    | '73        | 600,800  | 35          | 970   | side wall         | sand                  | Soletanche bit            |
| NO.10 Subway Line in Tokyo Shinjuku Station                  | Keio Electric Railway Co. Ltd.      | Ohbayashi-Gumi Ltd.      | Jan., '74  | 500      | 21.8        | 4189  | side wall         | sand, clay            | Soletanche clamshell      |
| Subway Seishin Line in Kobe Shinnagata Station               | Kobe Municipal Subway               | ditto                    | Mar., '74  | 500      | 18.9        | 8398  | side wall         | sand, clay            | ditto                     |
| Tohoku Shinkansen Viaduct of Sendai Station                  | JNR                                 | ditto                    | April, '74 | 600      | 6.3         | 1537  | wall              | gravel                | ditto                     |
| NO. 11 Subway Line in Tokyo Shibuya NO. 1 Section            | Teito Rapid Transit Authority       | ditto                    | June, '74  | 600      | 14.4        | 3097  | side wall         | gravel, silt          | Soletanche bit            |
| NO. 2 Subway Line in Osaka Kire Station                      | Osaka Municipal Subway              | Kajima Corporation       | ditto      | 700,800  | 17          | 14100 | side wall         | silt, sand            | BW                        |
| NO. 11 Subway Line in Tokyo Otemachi NO. 5 Section           | Teito Rapid Transit Authority       | The Zenitaka Corporation | Nov., '74  | 900      | 23.1 ~ 23.5 | 2205  | side wall         | sandy silt            | Soletanche bit            |
| Nambu Line Pier of Tamagawa Bridge                           | JNR                                 | Nippon ICOS Co.          | Dec., '74  | 600      | 10          | 643   | bridge foundation | gravel                | ICOS bit                  |
| NO. 11 Subway Line in Tokyo Takehira-cho Section             | Teito Rapid Transit Authority       | Ohbayashi-Gumi Ltd.      | Mar., '75  | 900      | 27.4 ~ 32   | 3563  | side wall         | sand                  | Soletanche bit            |
| NO. 11 Subway Line in Tokyo Motoishi-cho Section             | ditto                               | Maeda Constr. Co.Ltd.    | April, '75 | 600,800  | 24.5        | 2600  | side wall         | sand                  | ditto                     |
| NO. 3 Subway Line in Tokyo Reconstr. of Akasakamitsu Station | ditto                               | Kajima Corporation       | June, '75  | 600,800  | 17 ~ 20.5   | 2620  | side wall         | gravel, sand          | BW                        |
| Pier of Tamagawa Bridge                                      | Odakyu Electric Railway Co. Ltd.    | Hazama-Gumi Ltd.         | Jan., '76  | 600      | 10.9        | 841   | bridge foundation | gravel                | ICOS bit                  |
| Tohoku Highway Shiba Section                                 | Japan Highway Public Corporation    | Fujita Corporation       | '76        | 600      | 11-14       | 2355  | breast wall       | gravel                | FEW clamshell             |
| NO. 10 Subway Line in Tokyo Kudanshita NO. 1 Section         | Tokyo Metropolitan Government       | Ohbayashi-Gumi Ltd.      | Aug., '76  | 800      | 19.7 ~ 28.5 | 4670  | side wall         | sand                  | Soletanche bit            |
| NO. 1 and NO. 2 Subway Line in Fukuoka Hakata Section        | Fukuoka Municipal Subway.           | Hazama-Gumi Ltd.         | Dec., '76  | 600,800  | 29.5 ~ 31.5 | 12055 | side wall         | silt, gravel          | ICOS clamshell            |

Table 3. (Con't) Diaphragm walls used as integral parts of permanent structures in transportation facilities

|   |   |                           |            |                 |           |       |                   |              |                      |
|---|---|---------------------------|------------|-----------------|-----------|-------|-------------------|--------------|----------------------|
| M.T.R. in Hong Kong NO.205 Section                      | M.T.R.C.                                    | Kumagai-Gumi Co. Ltd.     | '76        | 1000            | 18~21     | 4000  | side wall         | granite      | BW                   |
| Subway in Rio de Janeiro                                | Companhia do Metropolitan do Rio de Janeiro | The Zenitaka Corporation  | Feb., '77  | 1200            | 24~30     | 12500 | side wall         | sandy silt   | BW                   |
| NO. 1 Subway Line in Fukuoka Obori Section              | Fukuoka Municipal Subway                    | Goyo Constr. Co. Ltd.     | April, '77 | 500             | 29~32     | 17770 | side wall         | sandy soil   | clamshell            |
| Highway in Tokyo NO. Y123 Section                       | Tokyo Expressway Public Corporation         | Kajima Corporation        | Nov., '77  | 300,1000        | 9.2~15    | 750   | breast wall       | silt, dotan  | BW                   |
| Kanetsu Highway Maebashi Section                        | Japan Highway Public Corporation            | Hazama-Gumi Ltd.          | Jan., '78  | 1000            | 16        | 4300  | wall              | gravel       | ICOS clamshell       |
| Tohoku Line Pier of Hebiogawa Bridge                    | JNR   | Totetsu Kogyo Ltd.        | Mar., '78  | 600             | 5         | 100   | bridge foundation | gravel       | ICOS bit             |
| Highway in Tokyo NO. Y123 Section                       | Tokyo Expressway Public Corporation         | Kajima Corporation        | May, '78   | 1000            | 22~26     | 1824  | breast wall       | silt, dotan  | BW                   |
| Tohoku Shinkansen Reconstr. of Ueno Underground Station | JNR   | Konoike Constr. Co. Ltd.  | Aug., '78  | 600             | 35        | 14730 | side wall         | sand, silt   | BW                   |
| Pier of Shirotakiri Bridge                              | Ministry of Construction                    | Hazama-Gumi Ltd.          | Sep., '78  | 600             | 9.5       | 576   | bridge foundation | gravel       | ICOS bit             |
| Tohoku Shinkansen Shitaya Shaft                         | JNR   | Sato Kogyo Co. Ltd.       | Dec., '78  | 800             | 31        | 2310  | shield shaft      | sand         | BW                   |
| M.T.R. in Hong Kong NO. 302 Section                     | M.T.R.C.                                    | Kumagai-Gumi Ltd.         | '78        | 1200            | 18~19     | 8500  | side wall         | silt, gravel | Soletanche clamshell |
| Highway in Tokyo NO. Y125 Section                       | Tokyo Expressway Public Corporation         | Nishimatsu Constr.Co.Ltd. | Mar., '79  | 800             | 26.8      | 2951  | breast wall       | silt, dotan  | BW                   |
| Tohoku Shinkansen Iisakakaido Section                   | JNR   | Tekken Kensetsu Co. Ltd.  | April, '79 | 1000, 1200,1500 | 29, 23,24 | 1975  | bridge foundation | gravel       | Soletanche clamshell |
| ditto   | JNR   | Ohbayashi-Gumi Ltd.       | July, '79  | 1000, 1200,1500 | 23.5~29.5 | 1900  | ditto             | gravel       | ditto                |
| Tohoku Shinkansen Reconstr. of Ueno Underground Station | JNR   | Tekken Kensetsu Co. Ltd.  | ditto      | 600             | 32        | 10880 | side wall         | sand         | BW                   |
|   |   |                           |            |                 |           |       |                   |              |                      |
|   |   |                           |            |                 |           |       |                   |              |                      |
|   |   |                           |            |                 |           |       |                   |              |                      |
|   |   |                           |            |                 |           |       |                   |              |                      |
|   |   |                           |            |                 |           |       |                   |              |                      |
|   |   |                           |            |                 |           |       |                   |              |                      |
|   |   |                           |            |                 |           |       |                   |              |                      |
|   |   |                           |            |                 |           |       |                   |              |                      |
|   |   |                           |            |                 |           |       |                   |              |                      |
|   |   |                           |            |                 |           |       |                   |              |                      |
|   |   |                           |            |                 |           |       |                   |              |                      |
|   |   |                           |            |                 |           |       |                   |              |                      |
|   |   |                           |            |                 |           |       |                   |              |                      |

Table 3. (Con't) Diaphragm walls used as integral parts of permanent structures in transportation facilities

367

Diaphragm walls used as integral parts of permanent structures in transportation facilities

( Addition )

| Project   | Client                           | Contractor          | Outset of Constr. | Particulars of diaphragm wall |           |                        | Wall Application  | Soil Condition  | Excavating Machinery |
|---|----------------------------------|---------------------|-------------------|-------------------------------|-----------|------------------------|-------------------|-----------------|----------------------|
|   |                                  |                     |                   | Width (mm)                    | Depth (M) | Area (M <sup>2</sup> ) |                   |                 |                      |
| Prefectural road Tenryu-Minakubo Line Disaster Repair Work        | Shizuoka Prefecture              | Nippon ICOS Co.     | Dec., '62         | 700                           | 12        | 1680                   | breast wall       | clay, mud stone | ICOS bit             |
| No. 17 National Road Pile Foundation                              | Ministry of Construction         | ditto               | July, '62         | 600                           | 10.9      | 118                    | bridge foundation | ditto           | ditto                |
| Prefectural Road Tenryu-Minakubo Line Disaster Repair Work        | Shizuoka Prefecture              | ditto               | April, '63        | 700                           | 12        | 3973                   | breast wall       | ditto           | ditto                |
| ditto   | ditto                            | ditto               | Dec., '63         | 700                           | 12        | 5670                   | breast wall       | ditto           | ditto                |
| Ohwu Line Itaya Section Retaining Wall Foundation                 | JNR                              | Hazama-Gumi Ltd.    | July, '68         | 600                           | 14        | 330                    | breast wall       | gravel          | ICOS bit             |
| Senhoku Rapid Transit Railway Constr. NO. 1 Section               | Osaka City                       | Ohbayashi-Gumi Ltd. | Nov., '69         | 600                           | 13.5      | 1492                   | side wall         | gravel          | Soletanche bit       |
| Musashino Line Kosugi Tunnel                                      | Japan Railway Construction Corp. | Mitsui Constr. Co.  | April, '71        | 500, 1000                     | 18        | 11610                  | side wall         | sand            | HB                   |
| NO. 8 Subway Line in Tokyo Shin'ogawa-cho NO. 2 Section           | Teito Rapid Transit Authority    | ditto               | ditto             | 800~1000                      | 11.5-13   | 4440                   | side wall         | sand            | HB                   |
| Tokaido Line Hazawa Station Underpass                             | JNR                              | Ohbayashi-Gumi Ltd. | March, '74        | 800, 1000                     | 9 11      | 4688                   | side wall         | silt, clay      | Soletanche bit       |
| Tokaido Line, Additional Line Tamachi Shaft                       | JNR                              | Kajima Corporation  | March, '75        | 600                           | 33        | 1390                   | shaft             | silt, clay      | ICOS bit             |
| Prefectural Road Fujieda-Shizuoka Line Abekawa Bridge Repair Work | Shizuoka Prefecture              | Nippon ICOS Co.     | Aug., '69         | 600                           | 13        | 600                    | bridge foundation | gravel          | ICOS clamshell       |
| ditto   | ditto                            | ditto               | Nov., '69         | 600                           | 13        | 1200                   | ditto             | gravel          | ditto                |
|   |                                  |                     |                   |                               |           |                        |                   |                 |                      |
|   |                                  |                     |                   |                               |           |                        |                   |                 |                      |
|   |                                  |                     |                   |                               |           |                        |                   |                 |                      |
|   |                                  |                     |                   |                               |           |                        |                   |                 |                      |
|   |                                  |                     |                   |                               |           |                        |                   |                 |                      |
|   |                                  |                     |                   |                               |           |                        |                   |                 |                      |
|   |                                  |                     |                   |                               |           |                        |                   |                 |                      |
|   |                                  |                     |                   |                               |           |                        |                   |                 |                      |
|   |                                  |                     |                   |                               |           |                        |                   |                 |                      |
|   |                                  |                     |                   |                               |           |                        |                   |                 |                      |
|   |                                  |                     |                   |                               |           |                        |                   |                 |                      |

368

Table 3. (Con't) Diaphragm walls used as integral parts of permanent structures in transportation facilities

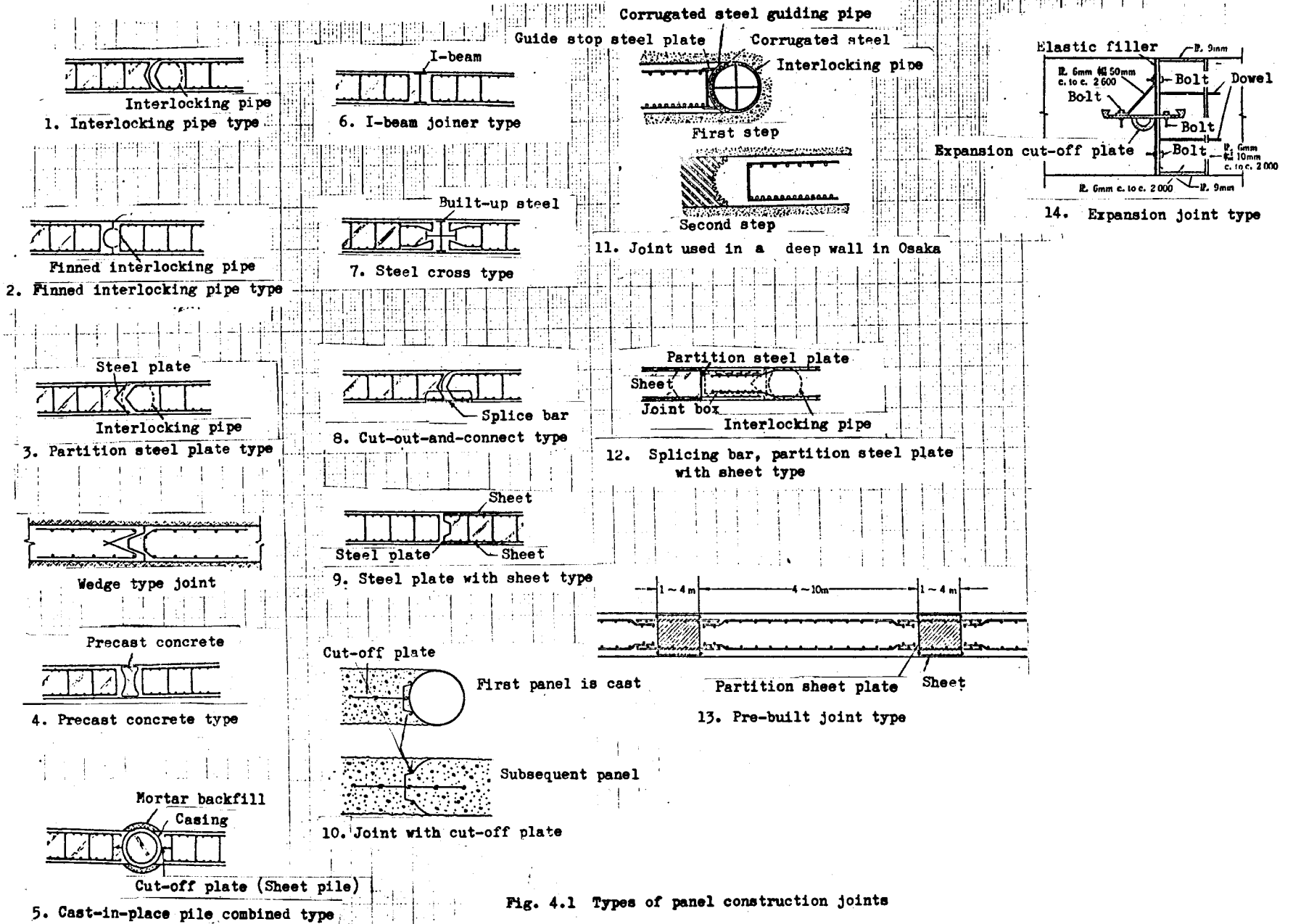


Fig. 4.1 Types of panel construction joints

Figure 4.1 Types of panel construction



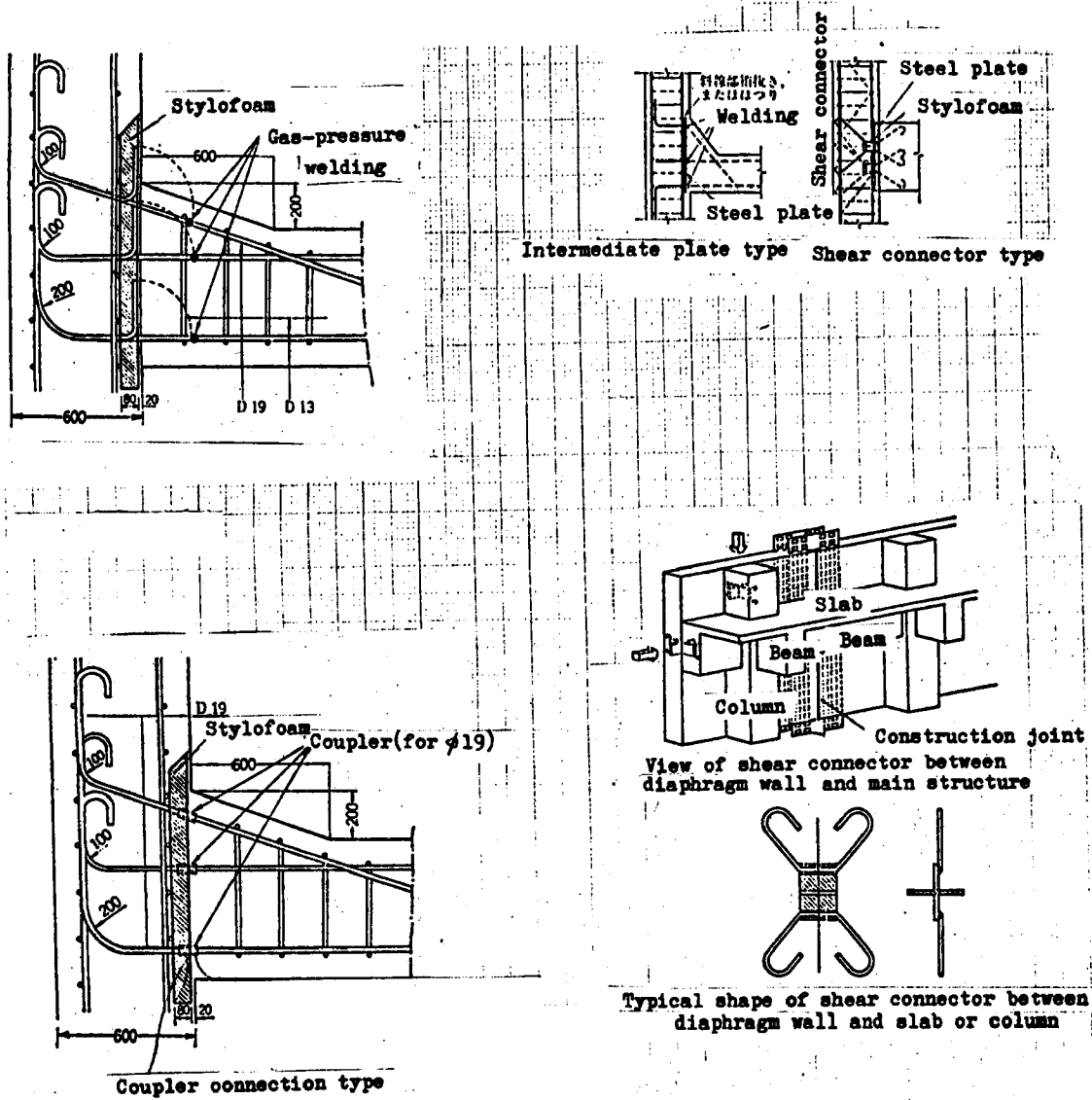


Fig. 4.3 Examples of the bar arrangement for connecting a diaphragm wall and a slab

Figure 4.3 Examples of the bar arrangement for connecting a diaphragm wall and a slab

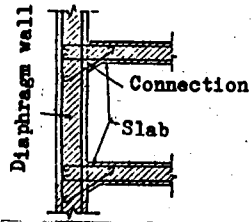


Fig. 6.1 Single wall

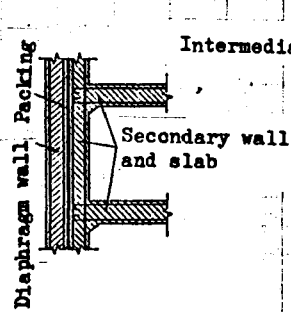


Fig. 6.2 Built-up wall (with packings in between)

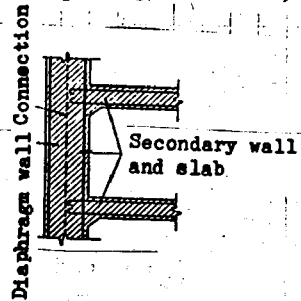


Fig. 6.3 Composite wall

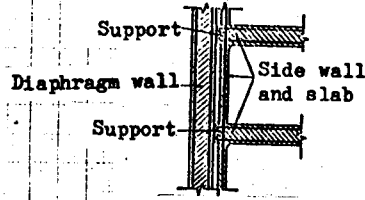


Fig. 6.4 Separate wall

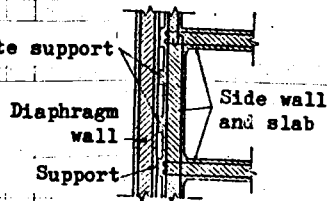


Fig. 6.5 Separate wall with intermediate supports

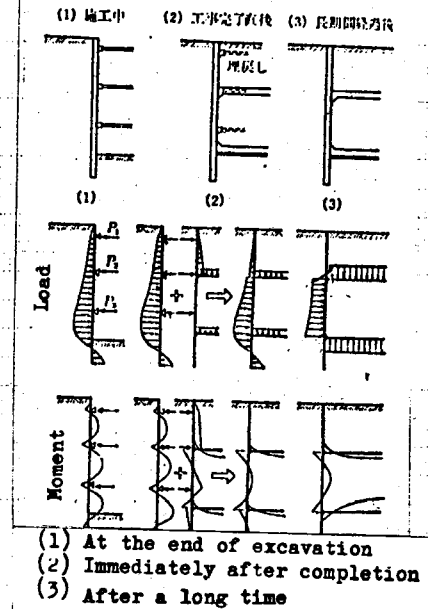


Fig. 6.6 Loads and bending moments acting on single wall

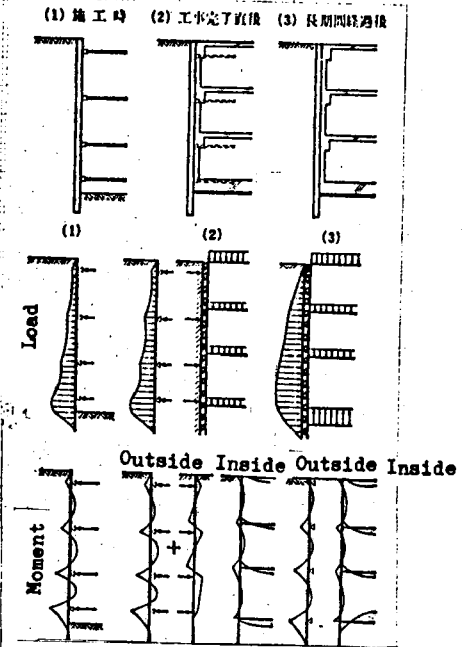


Fig. 6.7 Loads and bending moments acting on built-up wall

**Notice**

At the second stage vertical loads on rigid frame and horizontal loads on the points of removed struts are assumed to act on the unified structure, taking account of ground reaction corresponding to incremental deformation. Lastly, apart from the second stage, the stresses at the final stage should also be examined. At the final stage the earth and water pressures are assumed to return to the rest condition.



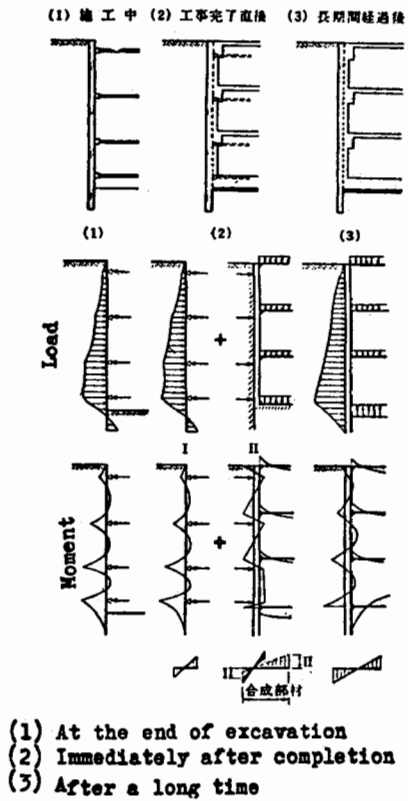


Fig. 6.8 Loads and bending moments acting on composite wall

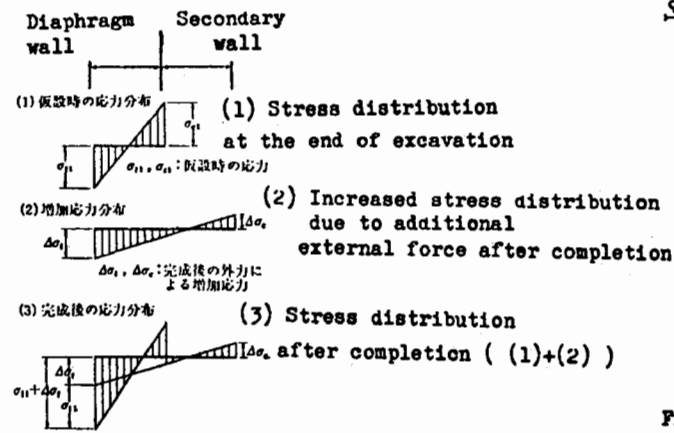


Fig. 6.9 Stresses of composite wall

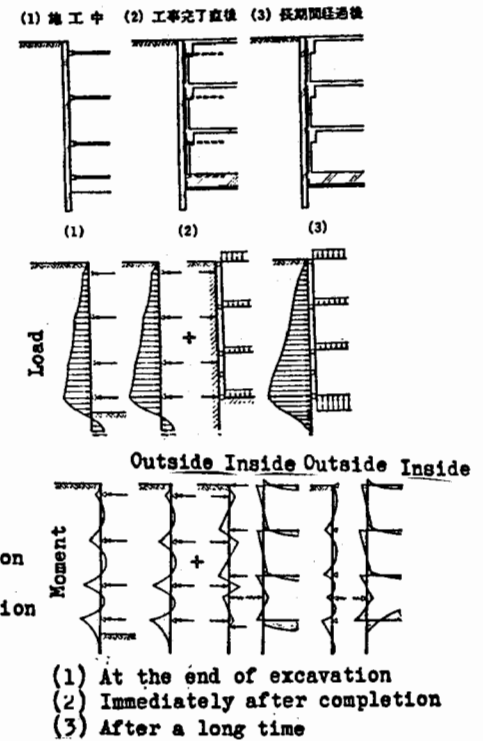


Fig. 6.10 Loads and bending moments acting on separate wall

|                   |  |   |                         |  |
|-------------------|--|---|-------------------------|--|
|                   | Specified standard strength of concrete = 210 Kg/cm <sup>2</sup> |   |                         |  |
| Concrete          | Compressive stress   |   | 70 Kg/cm <sup>2</sup>   |  |
|                   | Shearing Stress  | When diagonal tension bar is omitted    | Slab<br>Beam            | 8.5 Kg/cm <sup>2</sup><br>6.5 Kg/cm <sup>2</sup> |
|                   |  | When diagonal tension bar is considered | Beam                    | 18.5 Kg/cm <sup>2</sup>                          |
|                   | Bond stress  |   | Round bar               | /  |
|                   |  |   | Deformed bar            | 15.0 Kg/cm <sup>2</sup>                          |
| Bearing stress    |  |   | 63.0 Kg/cm <sup>2</sup> |  |
| Reinforcement bar | Tensile compressive stress                                       | SD30                                    | 1600 Kg/cm <sup>2</sup> |  |

( Rapid Transit Railway Construction Headquarters of Tokyo Metropolitan Government code )

Table 8 Allowable stress

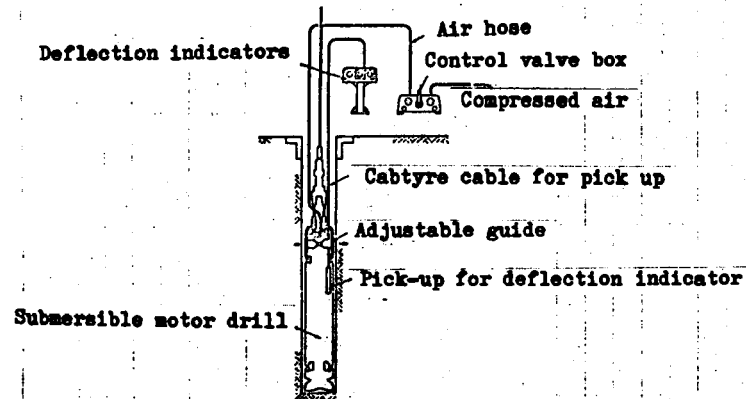


Fig. 9.1 Deflection corrector

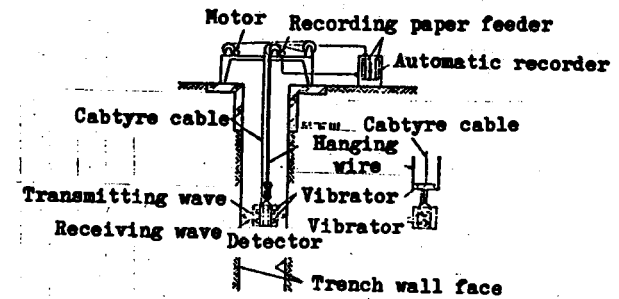


Fig. 9.2 Ultrasonic wave measuring apparatus

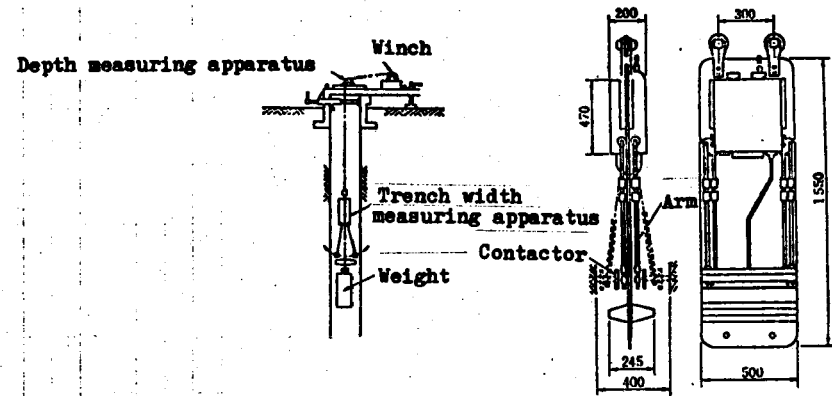
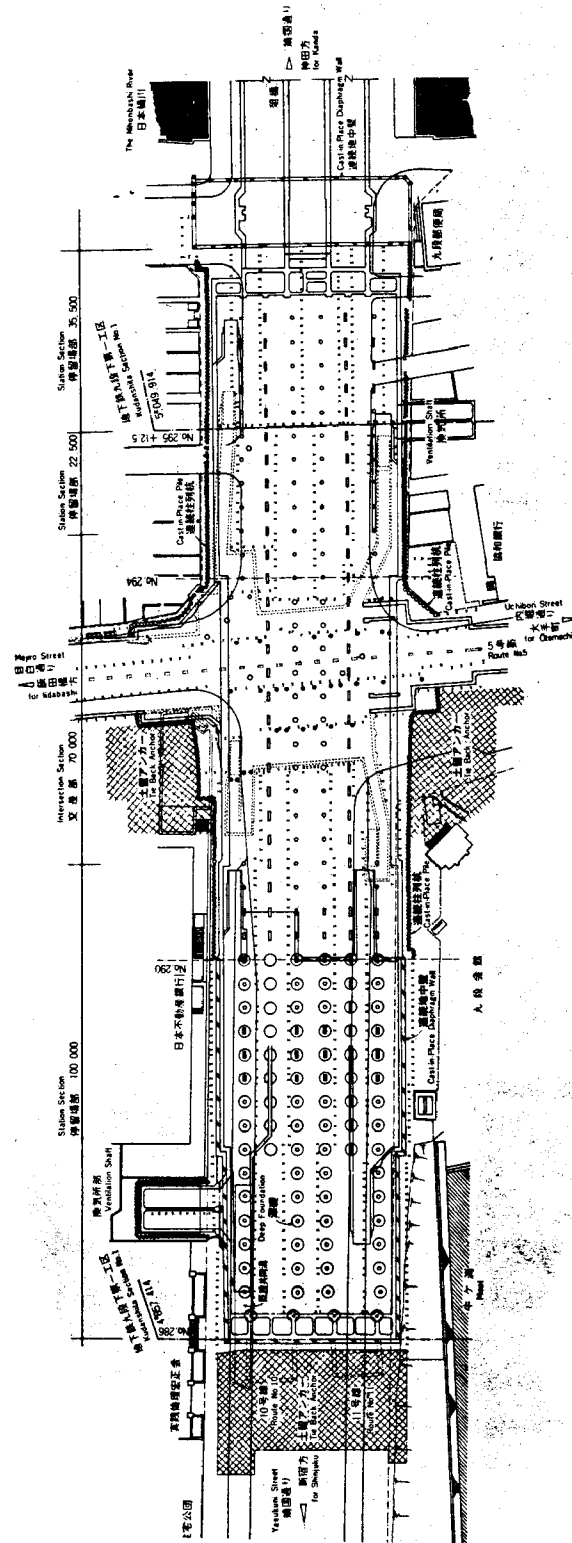
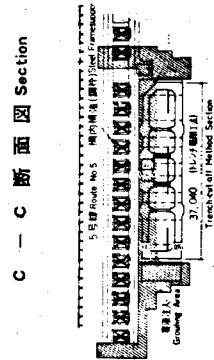
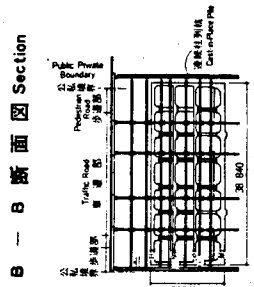
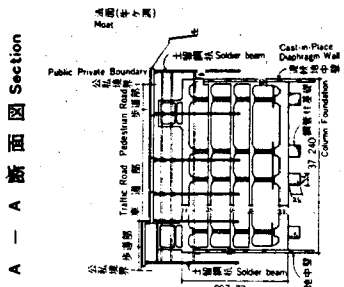


Fig. 9.3 Contact-type measuring apparatus

平 面 図 Plain View



縦 断 面 図 Cross Section

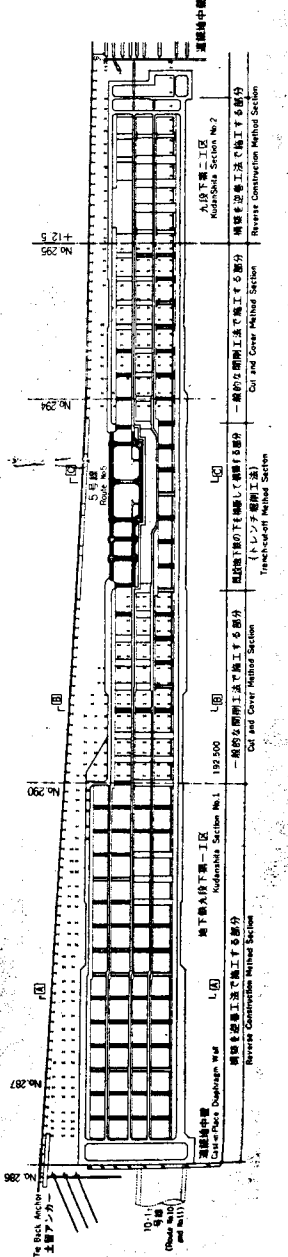
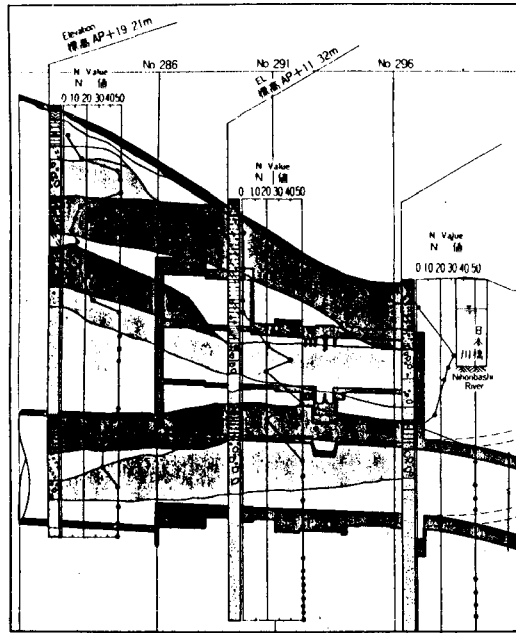


Fig. 10.1 General view of the Kudan-shita NO.1 section

地質状況図 Soil profile



- 凡例
- 表土 Topsoil
  - — △ Loam
  - 粘土 Clay
  - 砂 (細砂) Fine Sand
  - シルト Silt
  - 砂 礫 Gravel
  - 砂質粘土 Sandy Clay
  - 砂混粘土 Sand Mixed Clay

Fig. 10.2 Soil profile

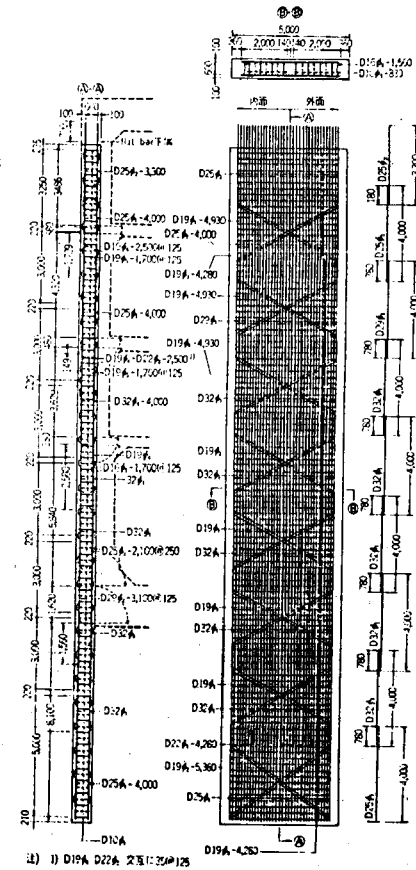


Fig.10.4 Reinforcement cage

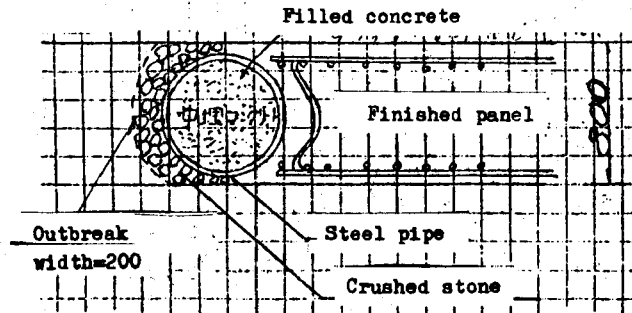


Fig. 10.3 Construction joint

| Item                                    | Slurry concrete                |
|---|--------------------------------|
| Specified standard strength of concrete | $f_{28} = 270 \text{ Kg/cm}^2$ |
| Slump test value                        | 18±2 Cm                        |
| Maximum size of coarse aggregate        | 25 mm                          |
| Volume of entrained air                 | 3-4 %                          |
| Cement                                  | 370 $\text{Kg/m}^3$            |
| Water                                   | 167 $\text{Kg/m}^3$            |
| Water cement ratio                      | 45 %                           |
| Fine aggregate                          | 810 $\text{Kg/m}^3$            |
| Coarse aggregate                        | 988 $\text{Kg/m}^3$            |
| Admixture ( Vinsol )                    | 71 CC                          |

Table 10.1 Specific standard strength and mixing ratio of ready-mixed concrete

| Test piece NO. | $f_{28} = 346 \text{ Kg/cm}^2$ |                                |
|----------------|--------------------------------|--------------------------------|
| 2              | 367                            | Sampled from center of pannels |
| 3              | 354                            |                                |
| 4              | 367                            |                                |
| 5              | 357                            | Sampled from edge of pannels   |
| 6              | 373                            |                                |

Table 10.2 Test results of concrete strength

| Material                    | Brand            | Concentration (%) |
|-----------------------------|------------------|-------------------|
| Bentonite                   | Kyoritsu 250     | 7.5               |
| Polymer                     | O.P.-4           | 0.2               |
| Dispersing agent            | Sodium carbonite | 0.2               |
| Fluid loss preventing agent | Asbestos         | 0.5               |

Table 10.3 Mixing ratio of bentonite slurry

| Control item            | Criteria              |
|-------------------------|-----------------------|
| Specific gravity        | 1.04~1.10             |
| Viscosity               | 22~25 sec (500/500cc) |
| Fluid loss              | < 6 cc                |
| Sand content            | At concreting < 0.5%  |
| Bentonite concentration | > 6 %                 |
| P.H.                    | 8~10                  |

Table 10.4 Design criteria

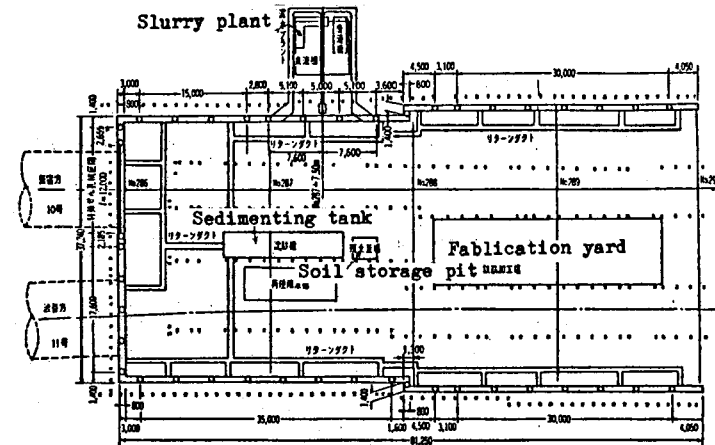


Fig. 10.5

Plant arrangement

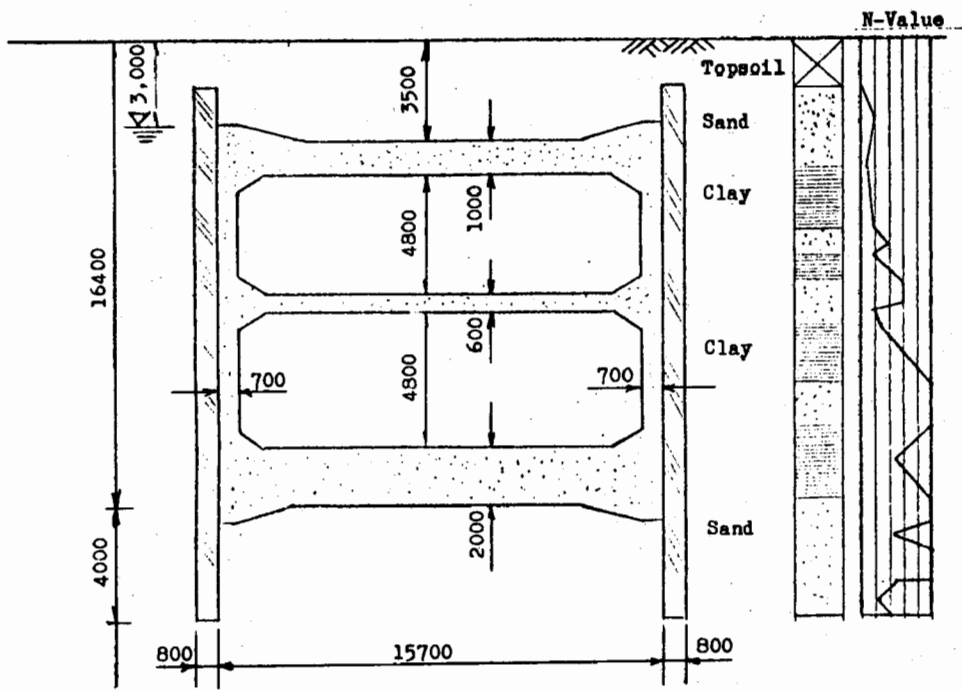
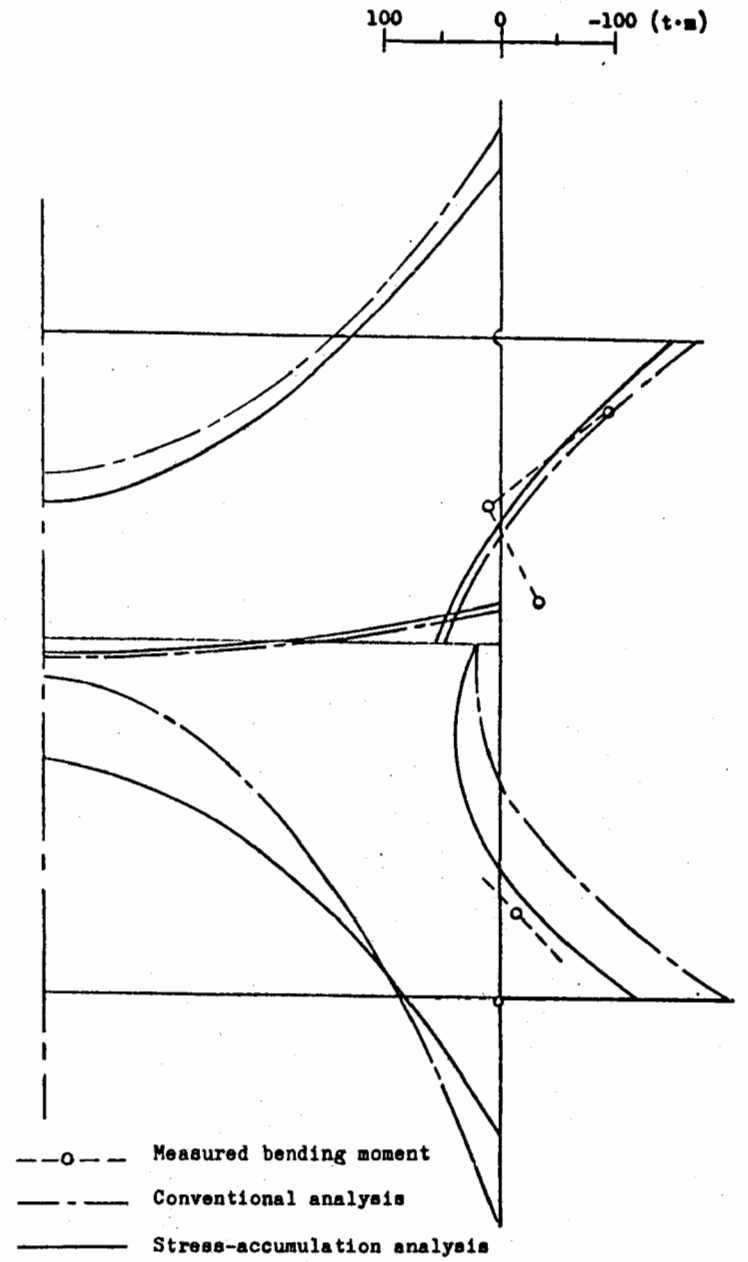


Fig. 10.6 Composite wall in KIRE station



Comparison between measurement and calculation (Kire)

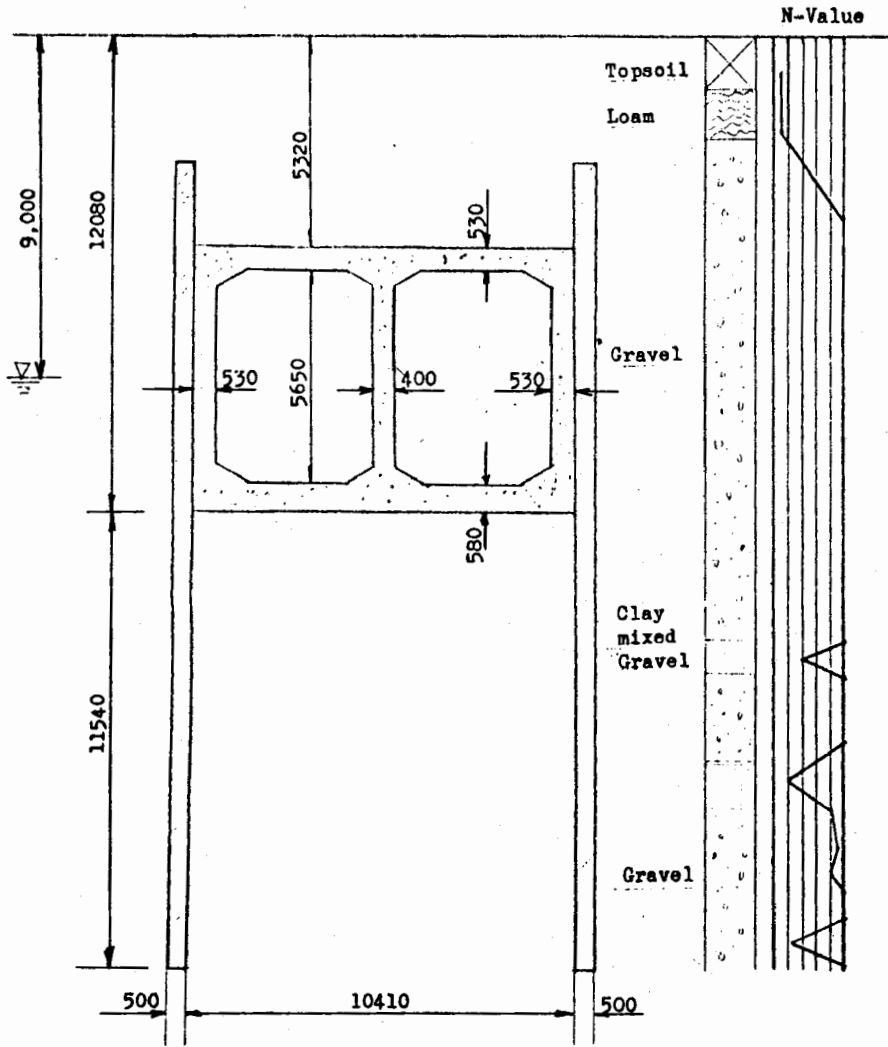
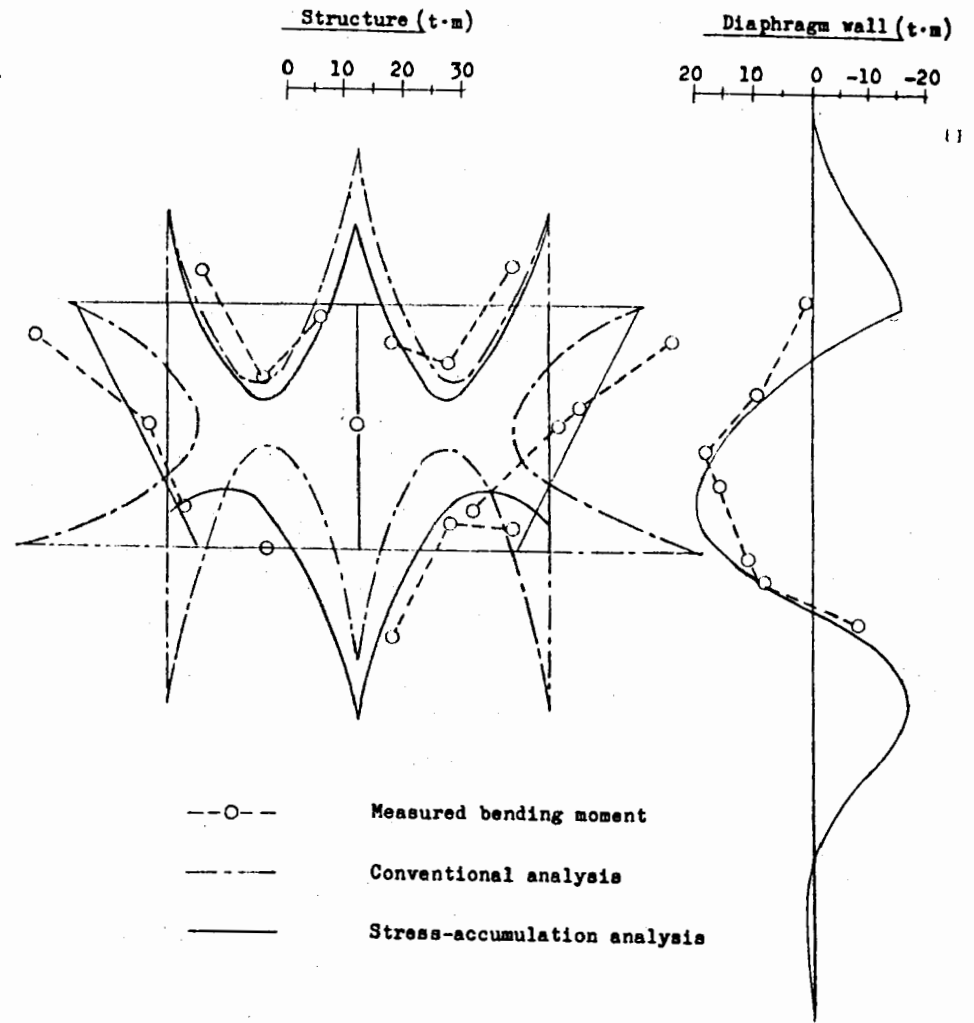
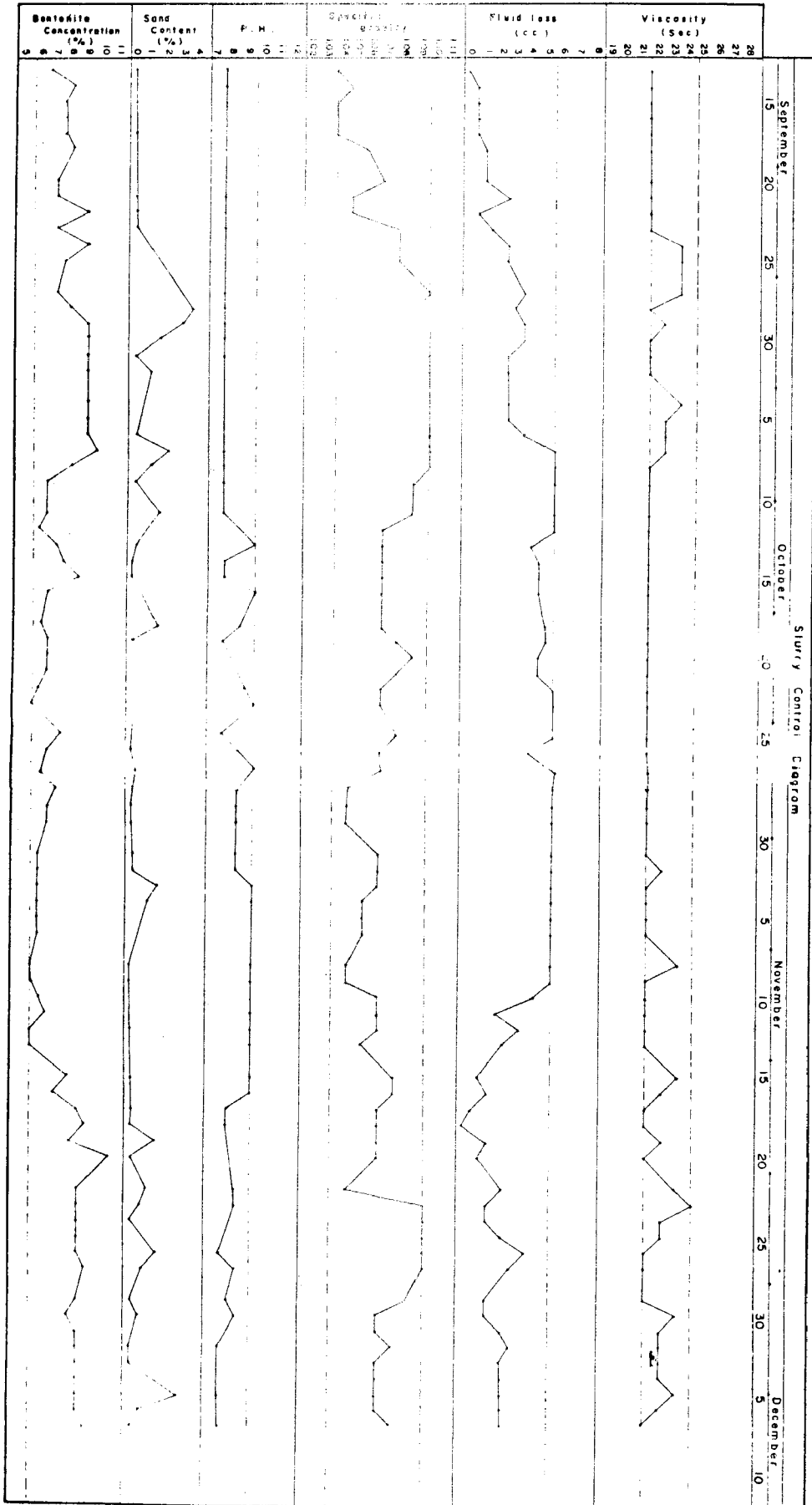


Fig. 10.7 Separate wall in Higashimurayama tunnel section



Comparison between measurement and calculation (Higashimurayama)

Control item





SPEAKER: Seiken Fukui  
Tokyo Metropolitan Government

John Wong  
Okinawa Associates

Question:

Can you elaborate on some of the difficulties you run into on your construction technique-- things like your equipment, which is very well controlled with different automation. Can you elaborate on construction difficulties that you have encountered?

Mr. Fukui

Answer:

Yes. This diaphragm walling is undergoing technical development in Japan, but regarding strength of concrete and control of slurry, most of the problems have been solved. But I think there is an urgent need to develop an instrumentation system by which we can examine the stress area of the permanent structure automatically and continuously for a long time, from the construction stage to a long time after completion of the structure. Only by doing so can we determine the stress distribution and performance of walls. And thus we can also improve construction methods and designing methods. Otherwise we cannot conclude which type structure is the most economical or what kind of method is the safest and most reliable construction method.

F. A. Bares  
Parsons, Brinckerhoff

Question:

Can you briefly elaborate on a few reasons why the B.W. Longwall machine doesn't have any success on the US market?

Mr. Fukui

Answer:

Your question is whether Japanese contractors have had experience with it in the US.

Mr. Bares

Question:

Yes, they have had experience, but if you look around, the machinery which is used presently and mostly by contractors in the states--I am

Mr. Bares  
(cont'd)

not mentioning contractors coming from Europe but local contractors--tend to use what I would call more conventional machinery. I know that the Tone Boring machine is a very good machine, but apparently there must be a reason. Either it is a labor reason--a machine which needs too much labor to be used, which makes it too expensive. It could be a question of its being too expensive.

Mr. Fukui

Answer:

I think it would depend on their propaganda. So they would have to do the best thing. I cannot answer you exactly, especially for such a market condition.

EXPERIENCE WITH SLURRY WALLS IN SOFT CLAY

by

KJELL KARLSRUD, ELMO DIBIAGIO, GUNNAR AAS  
NORWEGIAN GEOTECHNICAL INSTITUTE  
OSLO, NORWAY

ABSTRACT

(ABSTRACT NOT AVAILABLE - PAPER FOLLOWS)

## EXPERIENCE WITH SLURRY WALLS IN SOFT CLAY

### INTRODUCTION

In connection with construction of a railway and subway tunnel through the center of Oslo, two slurry trench projects were carried out in Studentertunden (S.L.) and at Jernbanetorget (J.B.T.) respectively.

The S.L. project involved a two-story tunnel, Fig. 1, necessitating a 15 m deep excavation in a soft clay with properties as indicated in Figure 2.

The longitudinal tunnel walls were constructed first down to 20 m depth. Thereafter, cross-lot slurry-trench walls were excavated at 4.5 m intervals along the tunnel. These were cast with concrete in the lower 5 metres below tunnel bottom. A temporary support was also placed or cast in the cross-lot trenches just below the middle deck in the tunnel. The purpose of the cross-lot walls was mainly to prevent bottom heave, but they also served the purpose of bracing the tunnel walls prior to any excavation. For a more detailed description of this new construction principle, it is referred to in Eide et al. (1972). Figure 3 illustrates the construction sequence.

The tunnel at J.B.T., Figure 4, was only one-story involving an 8-10 m deep excavation. Because the clay here was softer ( $s_u$  20kN/m<sup>2</sup>) than in S.L., cross-lot walls were called for in this case. In the shallowest eastern part, however, where the distance between the walls in the tunnel was 20 m, the primary purpose of the cross-lot walls was to act as bracing.

Totally, these two projects involved 31.000 m<sup>2</sup> of slurry trenches. At the time there was little published experience relating to application of slurry-trench technique in soft clay. These projects therefore initiated some fundamental investigations by the Norwegian Geotechnical Institute into the stability of trenches in soft clay, which will be referred to herein.

The new construction principle employed on these projects also called for a thorough program for performance control. At the S.L. site, this included one heavily instrumented section, Figure 5, involving the following instrumentation:

- 7 settlement anchors near ground surface
- 5 magnetic settlement devices, of which 2 were inside the tunnel
- 4 inclinometer casings, of which one was inside the wall
- 19 piezometers in the clay around the tunnel
- 10 earth pressure cells on each face of the wall
- 10 pore pressure cells on each face of the wall
- 25 strain gauges on the reinforcement.

In addition, another 56 surface settlement points and 9 inclinometer tubes were distributed along the entire length of the tunnel in S.L. At J.B.T., the instrumentation included 15 earth pressure cells, 5 pore pressure cells, 2 inclinometer tubes, 2 magnetic settlement devices within

the tunnel, and settlement pins on neighboring buildings. It is beyond the limits of this article to give a full account of all data collected, but the most important findings will be presented. The article also contains some comments on the design of slurry walls.

#### STABILITY OF THE TRENCHES

To the knowledge of the authors, all slurry trench works prior to these projects were carried out by means of bentonite mud. The primary purpose of the bentonite mud is to stabilize the trench walls in non-cohesive materials and prevent loss of the supporting fluid in the trench. In soft clay, however, it was anticipated that the main problem would be to ensure overall stability of the trenches. Furthermore, in-situ pull-out tests on concrete piles cased in bentonite mud in S.L. had indicated that use of bentonite mud would adversely affect the shear resistance which could be mobilized between concrete and clay, and which the principal use to prevent bottom heave failure relied upon (Eide et al. 1972).

In 1970, the Norwegian Geotechnical Institute carried out a test trench in S.L. to look into the problem of overall stability of the trenches and use of different types of supporting fluids (DiBiagio and Myrvoll, 1972). The test included the following steps:

1. A trench of minimum size compatible with the excavation equipment was excavated to 28 m using slurry with a unit weight of  $12.4 \text{ kN/m}^3$ . Deformations and pore pressure changes were observed.
2. The excavation was enlarged to form a trench  $1 \times 5 \times 28\text{m}$ . Instruments were installed in the trench to monitor changes in width of the trench. Deformations and pore pressure changes were observed for an interval of 12 days with slurry having a unit weight of  $12.4 \text{ kN/m}^3$  in the trench.
3. The slurry was diluted to a unit weight of  $11.0 \text{ kN/m}^3$  and observations continued for 7 additional days.
4. Slurry was replaced by water and observations continued for 11 days.
5. The water in the trench was replaced with concrete by the tremie method to form an in-situ wall element, and the response of the surrounding soil was observed.

Observed changes in width of the trench during the test, summarized in Figure 6, and Figure 7, show settlement of the ground surface at various stages. Notice the almost constant creep rate at each stage of loading and that the maximum surface settlement at the end of the testing period only amounted to 8 mm. Furthermore, it was clear that the trench was stable with only water in it.

Subsequently, another three test trenches were carried out at different sites in Oslo, and all of these were brought to failure by lowering the liquid level in the trench below ground surface level. On this basis, and experience gained during the projects described herein, a semi-empirical method of evaluating the stability of the trenches was developed (Aas, 1976). The assumed failure condition is shown in Figure 8. It consists of two separate blocks; a lower wedge-shaped body which is assumed to slide down and into the trench along two planes inclined at 45°; and an upper body which is assumed to move only vertically. Observed displacement patterns in the test trenches have confirmed that this type of body failure is relevant.

When evaluating proper shear strength parameters to put into the analysis, the anisotropic nature of the undrained shear strength must be taken into account (Bjerrum, 1973). On the two 45° planes, the undrained shear strength determined by triaxial (or plane strain) compression tests must be applied, whereas on the vertical side- and end-planes shear strength determined by in-situ vane tests (or possible direct simple shear tests) are relevant. However, herein one must take into account rate effects, and the fact that vertical cracks exist or will easily form in the upper weathered crust. For Oslo conditions Aas (1976) therefore suggested some simplifying and approximate assumptions leading to the following formula for evaluating the safety factor of a trench:

$$F = \frac{\tau_{VD}}{D(\gamma - \beta^2 \gamma)} \times \left( 2 \frac{\tau_{TD}}{\tau_{TD}} + 0.6 + 0.86 \frac{D}{L} \right)$$

where:

D = Depth to bottom of assumed failure surface

L = Length of trench

(D - βx D) = Depth from ground surface to fluid surface

γ = Unit weight of clay

γ<sub>f</sub> = Unit weight of fluid in trench

τ<sub>VD</sub> = Vane shear strength at depth D

τ<sub>TD</sub> = Triaxial compression strength at depth D

It seems that the formula is of similar form as the bearing capacity formula, but in this case the stability number is dependent both upon geometrical dimensions and anisotropy of the clay.

Applications of this semi-empirical formula have given safe and consistent results. For a normal 4.5 m long trench in the S.L. the safety factor with only water in the trench was 1.4-1.5 and similarly

1.2-1.3 at J.B.T. On that basis, it was decided to use only water in the majority of the slurry trench work at these two sites, amounting to 18.000 m<sup>2</sup> of trenches (out of a total of 31.000 m<sup>2</sup>).

Wherever the tunnel reached down to bedrock an 80 cm deep key was chiseled out for the wall panels. In order to stabilize a 0-4 m thick layer of bottom moraine (which often was a medium sand) overlying the rock surface, an ordinary bentonite mud was used in these cases. A thixotropic mud was also needed for pumping the chiseled-out rock to the surface.

At J.B.T. there were 4-5 story buildings on raft foundations within 3-5 m distance of the southern wall, Figure 4. To achieve a desired safety factor of 1.4 against these buildings, required a heavy slurry with unit weight as high as 13 kN/m<sup>3</sup> in places. A heavy slurry was also called for in this area because the contractor, for practical reasons, decided to carry out the slurry trench work from a level 0-2 m below original and surrounding ground surface.

The overall stability of the longitudinal tunnel walls never caused any problems. Beforehand, however, one realized (Eide, 1972) that construction of the cross-lot walls represented a special problem. The heart of the problem was that since a block of clay of only 3.5 m width was left in between neighboring cross-lot walls, and since only part of the trench had to be cast with concrete, backfilling of the remainder of a trench could adversely affect the stability of the next trench to be constructed. Originally it was therefore planned to use crushed rock as backfilling, and require that the crushed rock should be drained out completely after backfilling to ensure that its frictional resistance would be as high as possible. Different alternatives of dividing the 11 m long cross-lot trenches into sections were also looked at (Figure 9).

A special test trench in S.L. (Karlsrud, 1975 and Aas 1976) showed early that Alt. A and B would require a heavy slurry of unit weight 11-12 kN/m<sup>3</sup>. As the work in S.L. got under way, primarily using Alt. B, problems with loss of trench fluid from a trench under excavation into the drained-out crushed rock in the previous trench occurred on three occasions and caused collapse of the trenches in question (Karlsrud, 1975). This method was therefore unsafe in practice. The problem was finally overcome by the use of Alt. C, where half of the trench was backfilled with low-grade concrete. By first constructing alternately the southern and northern half of the trenches and backfilling with lean concrete, and then coming after with the section to be backfilled with crushed rock, one ensured that next to a trench under excavation there would be either intact clay or a trench filled with lean concrete. Thus it was not necessary any longer to drain out the crushed rock. This principle was also used with success at J.B.T., but the widest cross-lot walls (20 m) were here divided into three sections (panels) (Karlsrud, 1975, 1979).

After completion of the longitudinal tunnel walls, surface settlements of only 3-10 mm were observed, see for instance Figure 11. Construction of the cross-lot walls on the other hand caused comparatively large settlements

and inward displacements of the longitudinal walls, amounting to 10-20 mm inward displacement and settlements of 20-40 mm closest to the tunnel. The reason for these relatively large displacements was apparently that construction of the cross-lot walls caused a general reduction of lateral stress within the tunnel walls. This was confirmed by the earth pressure measurements.

#### PRACTICAL ASPECTS OF SLURRY TRENCH WORK

All aspects of the slurry trench operations were closely supervised, both during excavation, chiseling and concreting of the panels. In addition, some special control measurements were made of verticality and width of trenches, change in width during concreting, and settlement of panels after concreting. The experience gained has been presented by Karlsrud (1975, 1979), and will only be briefly summarized here.

Measured width of trenches showed no difference between panels excavated in pure water or in bentonite mud, see for instance, Figure 10. It has later been confirmed both by concrete consumption and inspection of the completed tunnel, that use of pure water as trench fluid caused no particular problems with local instability and overbreak. On the other hand, it was early recognized that in spite of bentonite mud being used, large overbreaks occurred in the bottom morainic material. This is a problem of "dynamic instability" mainly caused by the chiseling operations, and has been a problem on other slurry trench projects in Norway as well (Roti, 1977).

On a number of occasions, in particular in S.L., large overbreaks also occurred due to inaccurate excavation and concrete by-passing the stop-end tube (which has a diameter 10 cm less than the trench width). This problem was partially overcome by placing two smaller pipes alongside the stop-end tube.

The net overbreak is summarized in the table below:

|                         |               | Overbreak (%) |
|-------------------------|---------------|---------------|
| Studenterlunden (S.L.)  | Panel on rock | 33.6          |
|                         | Panel in clay | 21.3          |
| Jernbanetorget (J.B.T.) | Panel on rock | 22.0          |
|                         | Panel in clay | 15.7          |

However, it should be noted that where no problems occurred during excavation, the normal overbreak was ~ 10%.

At J.B.T., where a heavy slurry was called for in places, the contractor Entrepren Service A/S, successfully designed equipment to make slurry out of



in-situ clay. The equipment in principle consisted of a high-speed cutting tool. Slurry out of pure clay showed, however, a tendency for rapid sedimentation. By adding some silica powder and a dispersing agent, one did, however, arrive at a sufficiently stable slurry (Karlstrud, 1975, 1979). The use of slurry with unit weight as high as  $13 \text{ kN/m}^3$  did not cause problems with the concreting operations, and neither have any adverse effects been observed after excavation of the tunnels.

The verticality of several trenches was controlled during the works by lowering an inclinometer tube down into the trench and pushing it in contact with the trench wall by means of hydraulic jacks attached to the tube. All cases showed acceptable results, the maximum observed deviation from the vertical being 1:200.

Concreting of the panels caused permanent outward displacement of the walls, corresponding to about 10 mm increase in width. After concreting, panels not founded on rock settled into the ground by as much as 100 mm by the time piling to bedrock was carried out (piling was done through open steel tubes put into the reinforcement cage). This settlement was actually taken into account when positioning the reinforcement cages in the trenches.

#### PERFORMANCE OF TUNNEL STRUCTURES

By the time the tunnel in S.L. was completed, the surface settlement had increased to maximum 70-80 mm, and the horizontal displacement to ~40 mm, as seen in Figures 11 and 12. From the deformation patterns indicated in Figure 11, it seems clear that the deformation during excavation of the tunnels was more deep-seated than during the slurry-trench works. Unfortunately the magnetic settlement devices within the tunnel did not function properly until the upper OTB-tunnel was excavated. During excavation of the lower NSB-tunnel, however, a maximum bottom heave of ~20 was measured, Figure 12. This shows that the cross-lot walls functioned as intended in preventing bottom heave failure (theoretically the safety factor was 1.3-1.4, see Eide et al., 1972). Lateral displacements of the tunnel walls at all levels indicated that one did not quite succeed in getting perfect contact between the cross-lot walls and the tunnel walls. The continuing settlements after completion of the tunnels are probably associated with pore pressure changes and consolidation of the clay.

At J.B.T., the final maximum lateral displacement was 20 mm and the maximum bottom heave during excavation of the tunnel 30 mm, see Figure 17.

Originally, the pore pressures in S.L. were hydrostatic and corresponding to G.W.L. at elevation +4.0. As shown in Figure 13, the slurry-trench work caused up to 3.0 m increase in piezometric elevations closest to the tunnel, which must be associated with some flow of water from the trenches and out into the surroundings. The pore pressures remained at this level until excavation of the tunnels started, which caused a steady decline in pore pressure. Thus, after completion of the tunnel, the pore pressures reached a new constant level which, along the outside face of

the tunnel, is 2-3 m below normal. From the equipotential lines in Figure 13, it is furthermore clear that there is a tendency for flow down below and up through the bottom of the tunnel. The pore pressure against the bottom plate is actually 8-9 m below the original hydrostatic level. In spite of this, there is no pronounced leakage to be seen within the tunnel.

Excavation of the tunnel caused relatively small earth pressure changes on the outside face, but as a whole they are close to the theoretical active pressure based on undrained triaxial tests, Figure 14. The distribution indicates, however, some arching effects. The earth pressures along the inside face correspond to almost twice the overburden pressure at the end of construction. This relatively high pressure is probably mainly caused by the restraint represented by the cross-lot walls, and to a lesser extent by inward lateral displacement of the wall. Similar observations were made at J.B.T., see Figure 18.

Shortly after concreting, all vibrating-wire strain gauges showed compressive stresses in the reinforcement. After the maximum curing temperature of  $50^{\circ}$  was reached, the compressive stresses declined again in parallel to declining temperature. Thus, at the end of the curing process, one ended up with net tensile stresses ranging between 5 and  $30 \text{ N/mm}^2$ . A similar pattern of stress changes was observed by DiBiagio and Roti (1972).

During excavation of the tunnels, subsequent stress changes in the reinforcement was at the most  $100 \text{ N/mm}^2$  at a level just below the bottom deck. On the basis of these stress changes, bending moments in the wall have been computed. This is actually not as easy as it might seem at first (to a geotechnical engineer). It requires knowledge of the stiffness,  $E \times I$ , of the wall, which is both stress and time dependent. Thus there is clearly some room for uncertainty in the computed values shown in Figure 15.

Bending moments have also been computed on the basis of angular distortions measured in inclinometer tubes cast within the wall, and are given by solid lines in Figure 15. Due to the very small distortions in question, it was necessary to look at a statistical average of a number of readings, e.g., Figure 16. The moments computed from the angular distortions do, however, agree rather well with the values computed from observed stresses. The discrepancy with the dashed curve, computed on the basis of measured resultant earth pressures, can to a large extent be explained by the fact that some displacements occurred at the support levels. Thus there is, after all, reasonably good correspondence between observed earth pressures against the wall and resulting bending moments.

#### COMMENTS ON DESIGN OF SLURRY WALLS

The design of slurry-trench walls is in principle not different from the design of any other flexible earth retaining structures. Its stiffness and strength are high, however, compared to, for instance, ordinary sheet pile walls. Slurry walls often form part of the permanent structure, and the construction costs are relatively high. It is therefore desirable

to use more accurate and advanced methods of analyses when designing slurry wall structures than normally applied in design of other temporary earth retaining structures.

This necessitates use of analytical methods which model the interaction between the soil-wall and support system, making due account for the stress-strain characteristics of the different media. As of today, it is the finite element method which can get the best and most rigorous solution to such problems. This method has successfully, and with exceptionally high costs, been applied by the first author on several occasions in connection with slurry-trench walls. Two examples will be given.

Figures 19 through 21 show results of a back analysis of a slurry-trench wall constructed for a building in Kongensgt, Oslo (Karlsrud, 1970). A simple bilinear material model was used for the clay. It is seen that the results agree rather well with the observed performance as reported by DiBiagio and Roti (1972), both with respect to deformations, earth pressures and bending moments. Actually, the greatest uncertainty was associated with the question as to what extent the key-in would fix the wall at the bedrock interface. Notice in particular that due to the continuous inward movement of the wall as excavation proceeded, in reality there were at all times positive bending moments along the entire height of the wall. In comparison, in the original design carried out on the basis of wall on rigid supports (Holm, 1971), negative bending moments over the supports were critical.

In many cases it can be difficult to assess the stress-strain characteristics of the different media correctly, which can make it desirable to carry out parametric studies. This will also often be desirable to get at the most economical wall thickness, support system, etc.

An example of such a parametric study, carried out in connection with design of a slurry-trench wall for Drammen Hospital, is shown in Figure 22. Without going into details, one arrived on this basis at a more economical design than originally planned on the basis of more traditional analyses. Furthermore, field observations have revealed that the analyses gave fairly good assessment of the real behavior (Mørk and Roti, 1979).

## CONCLUSIONS

There does not seem to be any particular problem associated with construction of slurry-trench walls in soft clay, and it is in this case possible to use only water as supporting fluid in the trench. It is, however, possible that use of water requires that the clay is fairly homogeneous without layers or inclusions of coarser materials. The semi-empirical method of analyzing the stability of trenches in soft clay developed by Aas (1976) has given good and reliable results. Application to other types of clays might however require verification by new test trenches.

The special method applied on the tunnel projects presented herein, involving construction of cross-lot walls to prevent bottom heave and reduce lateral movements has functioned well. This has been confirmed by extensive instrumentation and supervision.

To arrive at the most economical design of slurry-trench wall structures, it is recommended to apply methods of analyses that can make due account for the interaction between the soil-wall and support system.

## REFERENCES

Aas, G. (1976)

Stability of Slurry Trench Excavation in Soft Clay  
European Conference on Soil Mechanics and Foundation Engineering,  
6 Wien 1976  
Proceedings, Vol. 1.1, pp. 103-110.  
Also publ. in: Norwegian Geotechnical Institute, Oslo Publication, 111.

Bjerrum L. (1973)

Problems of Soil Mechanics and Construction on Soft Clays.  
State-of-the-art report to Session IV.  
Internat'l Conf. on Soil Mechanics & Foundation Engineering, 8 Moscow 1973.  
Proceedings, Vol. 3, pp. 111-159  
Also publ. in: Norwegian Geotechnical Institute, Oslo Publications, 100.

DiBiagio, E. and J.A. Roti (1972)

Earth Pressure Measurements on a Braced Slurry-trench Wall in Soft Clay  
European Conference on Soil Mechanics and Foundation Engineering  
5 Madrid 1972  
Proceedings, Vol. 1, pp. 473-483.  
Also publ. in: Norwegian Geotechnical Institute, Oslo, Publication 91.

Eide, O., G. Aas and T. Josang (1972)

Special Application of Cast-in-place Walls for Tunnels in Soft Clay in Oslo  
European Conference on Soil Mechanics and Foundation Engineering  
5 Madrid 1972  
Proceedings, Vol. 1, pp. 485-498  
Also publ. in: Norwegian Geotechnical Institute, Oslo. Publication 91

Holm, O.S. (1971)

Prosjektering og gjennomføring av utgraving med slissevegger -Kongensgt  
8 Oslo, 15pp.  
Norske ingeiorforening. Slissevegger, kurs, Hamar 1971

Karlsrud, K. (1972)

Finite element analysis of the cast-in-situ wall at Kogens gate 8  
Norwegian Geotechnical Institute, Oslo  
Internal report, 52601-4, 7 pp.

Karlsrud K. (1975)  
Practical Experience from the Excavation of Slurry Trenches in Oslo Clay  
Norwegian Geotechnical Institute, Oslo  
Publication 110, 1976  
First publ. in Norwegian in: Nordisk geoteknikermode, Copenhagen 1975.  
Foredrag, Copenhagen Polyteknisk forlag, pp. 529-542

Karlsrud, K. (1979)  
Eksempler på malt og beregnet oppforset av noen slisseveggkonsstruksjoner  
Norwegian Geotechnical Institute, Oslo  
Report 52300-1, 27 pp.

Karlsrud, K. (1979)  
Praktiske erfaringer fra gjennomføringen av slisseveggarbeidene for OTB  
og NSB i Studenterlunden og på Jernbanetorget  
Norwegian Geotechnical Institute, Oslo  
Report 52256-2, 28 pp.

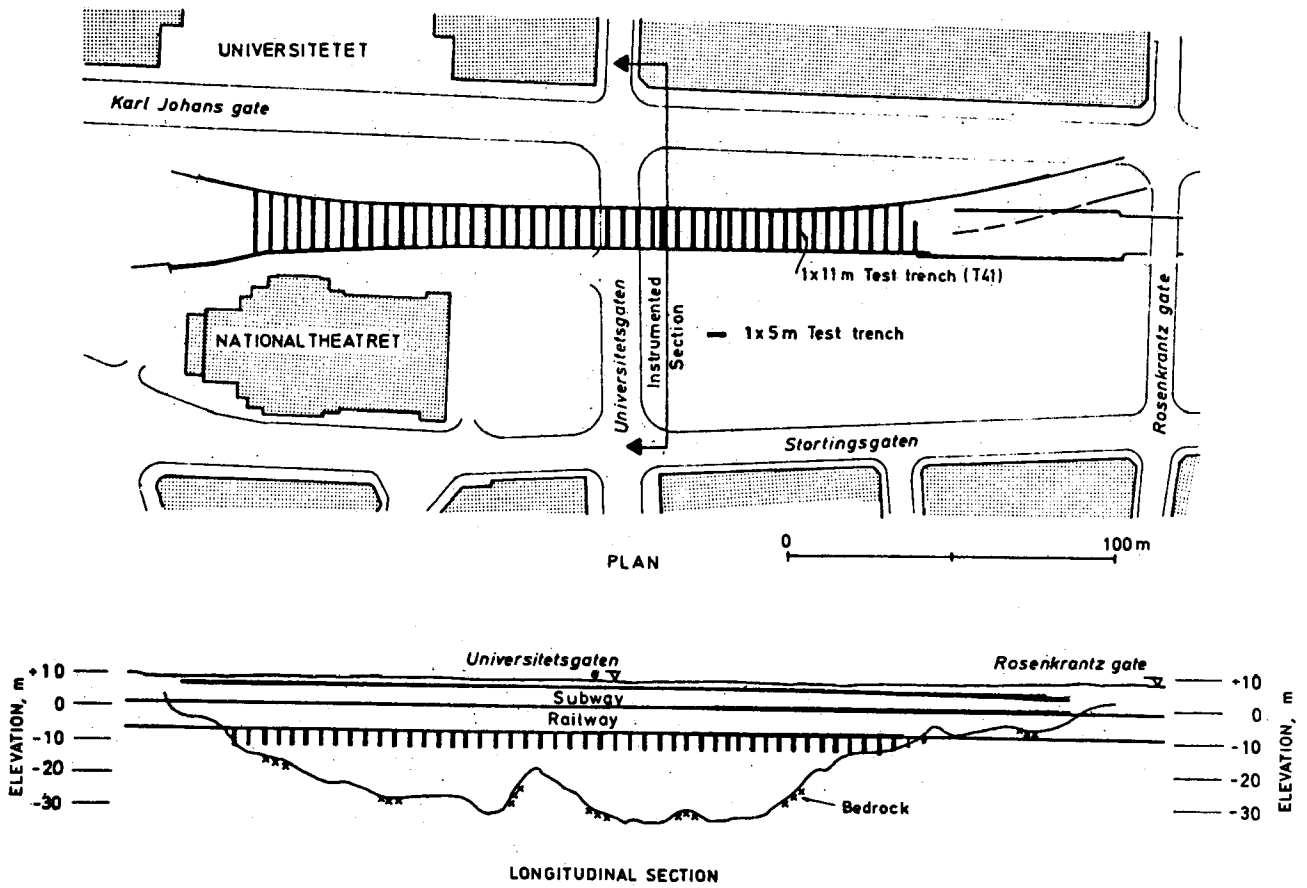


Fig. 1 Tunnel project, Studenterlunden



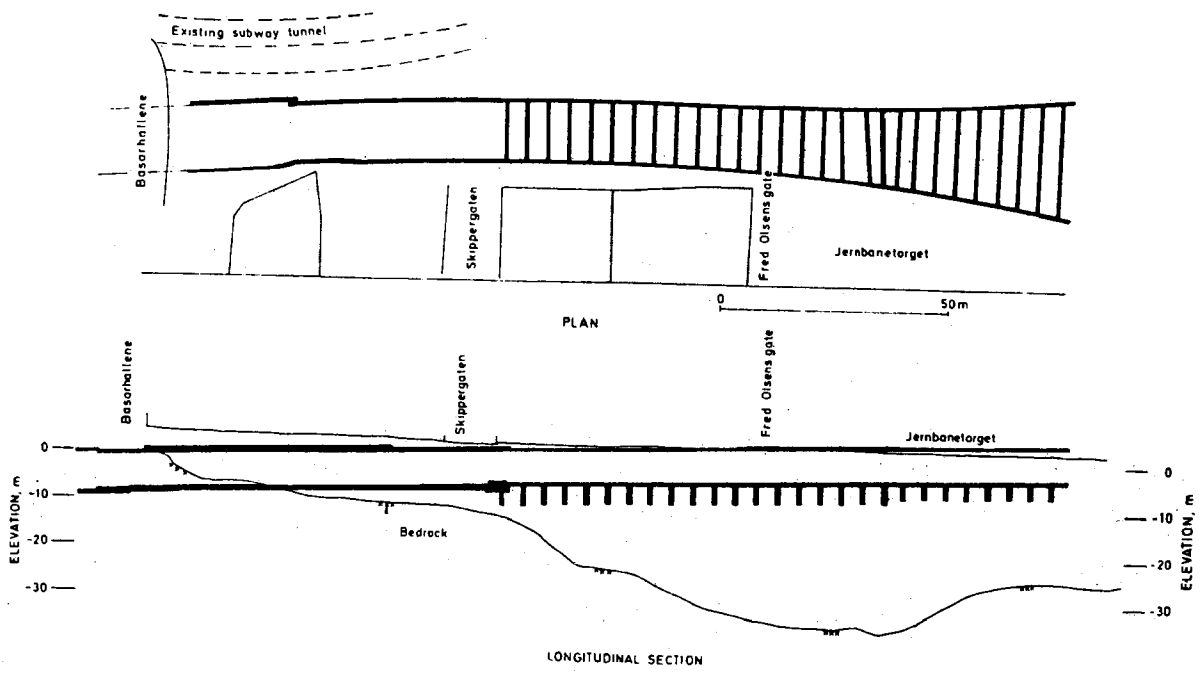


Fig. 4 Tunnel project, Jernbanetorget

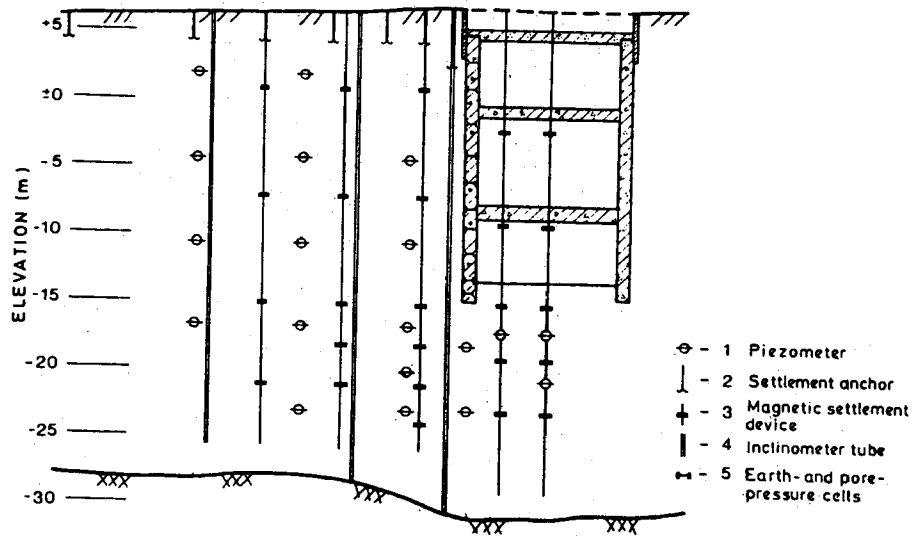


Fig. 5 Instrumented section, Studenterlunden



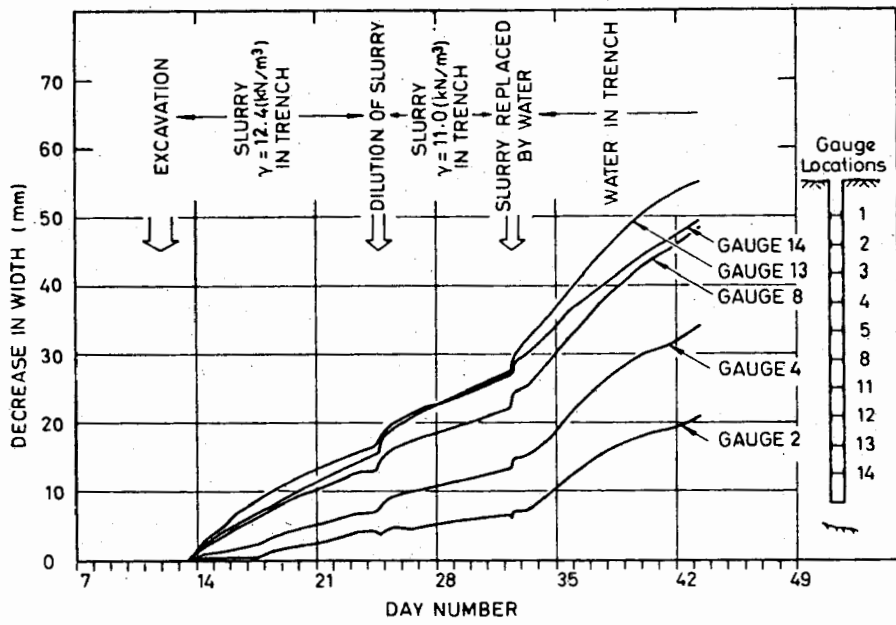


Fig. 6 Change in width for typical gauge points, test trench, Studenterlunden

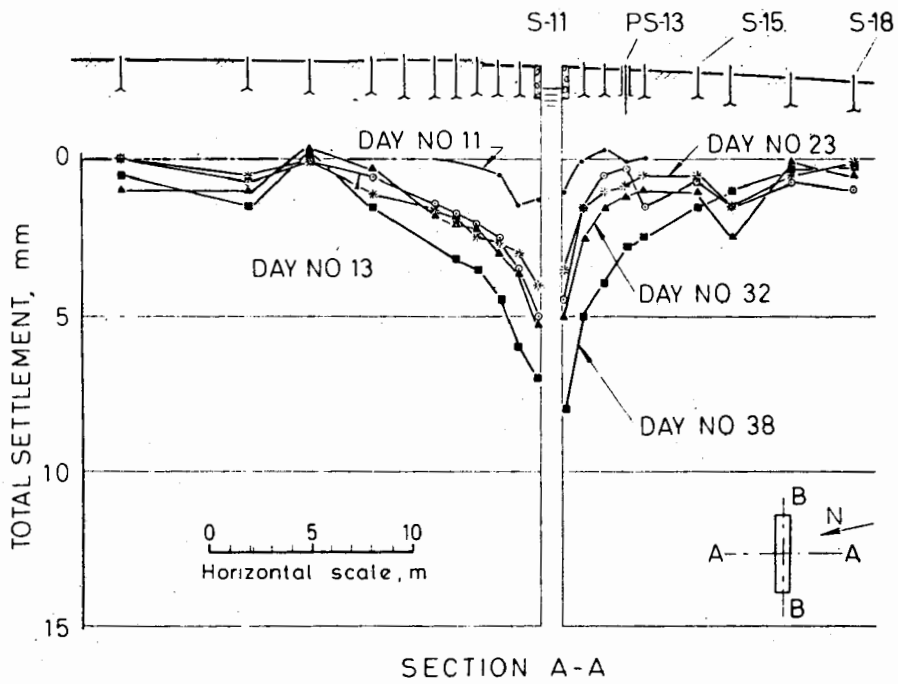


Fig. 7 Settlement profiles at key stages of test trench, Studenterlunden

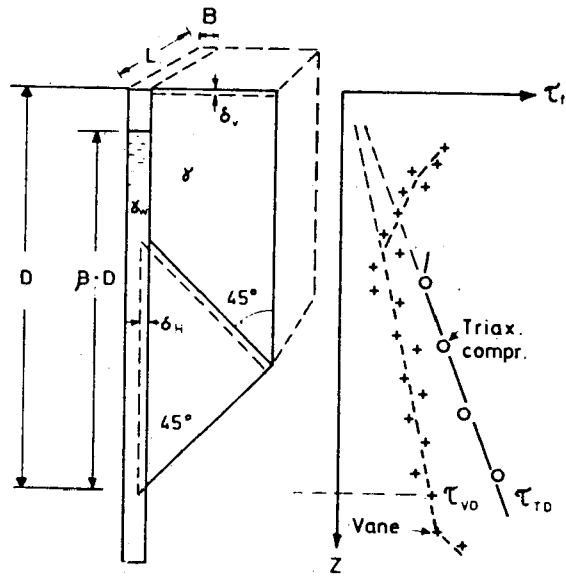


Fig. 8 Assumed failure condition in trench

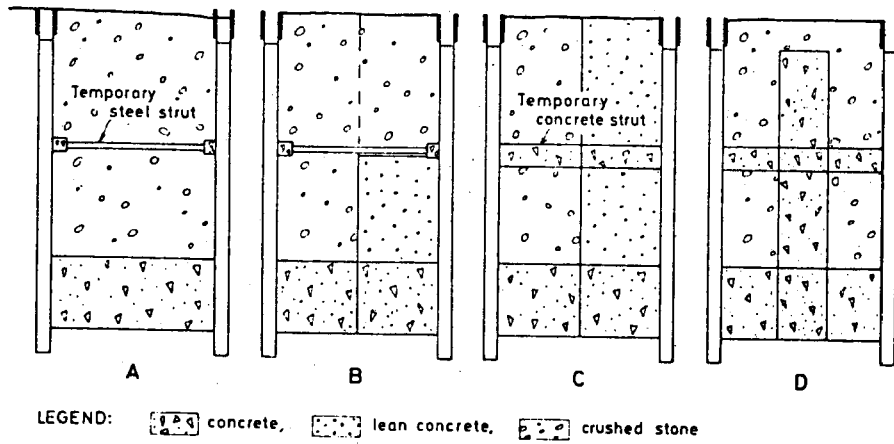


Fig. 9 Alternative methods of constructing cross-lot walls, Studenterlund

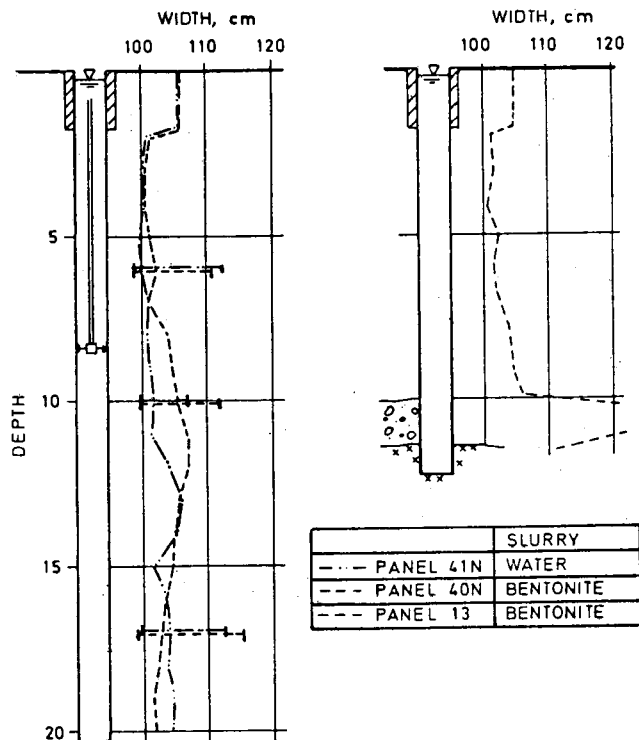


Fig. 10 Measured width of three trenches after excavation, Studenterlunden

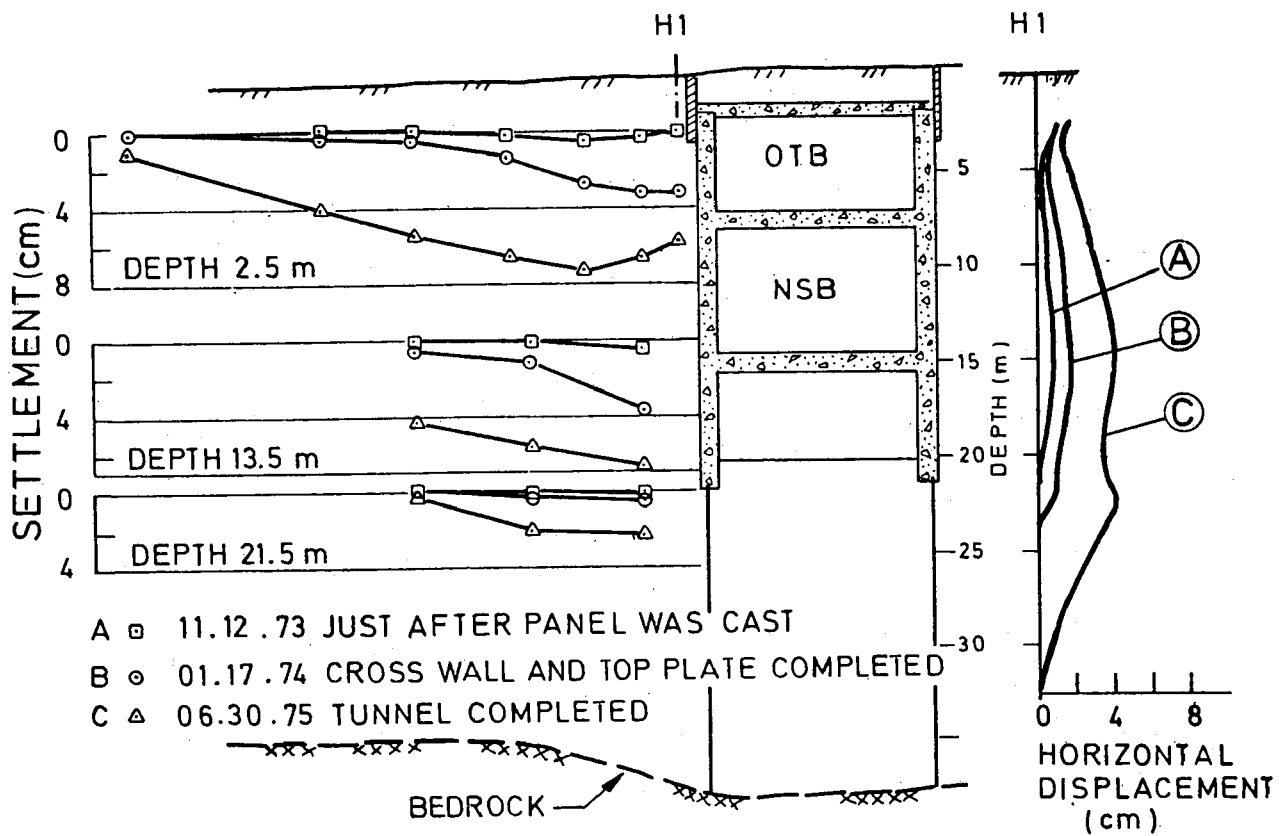


Fig. 11 Observed displacement patterns, Studenterlunden

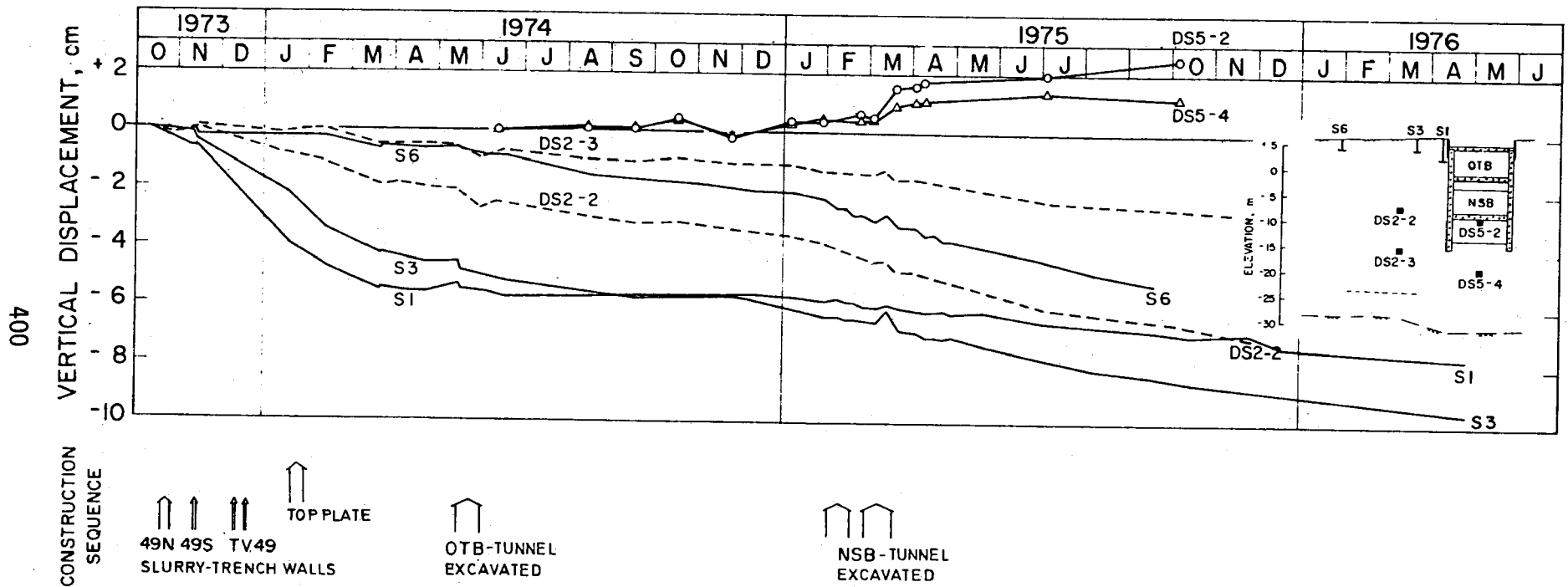
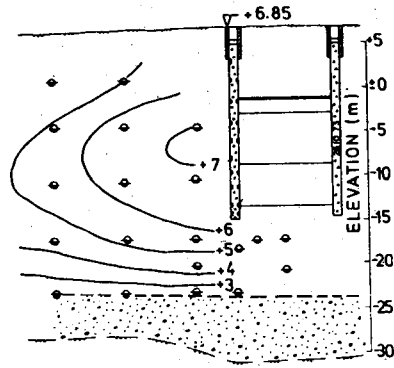
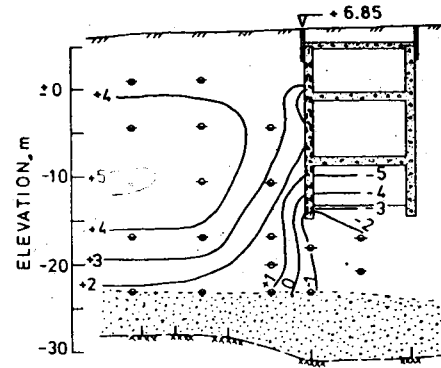


Fig. 12 Development of settlement, Studenterlunden



a) after slurry-trench work



b) after completion of tunnel

Fig. 13 Pore pressure distributions, Studenterlunden  
(expressed as piezometric elevations)

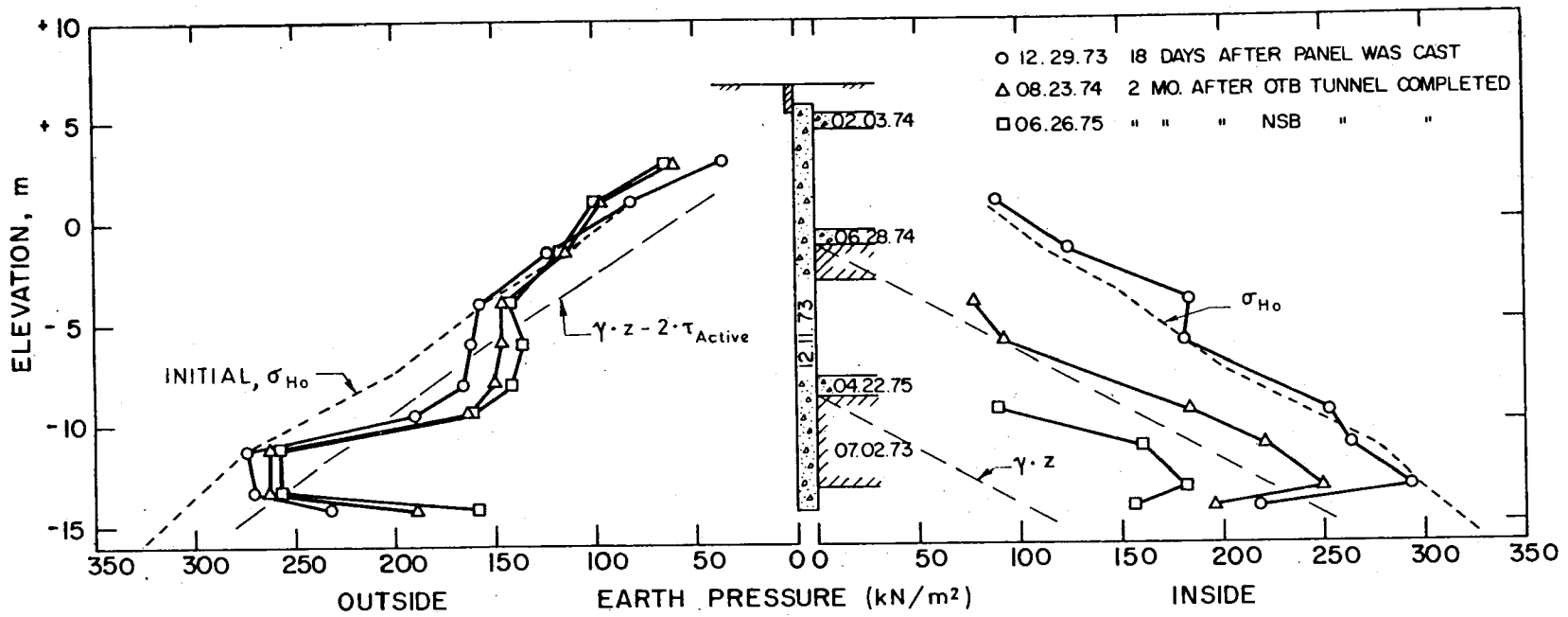
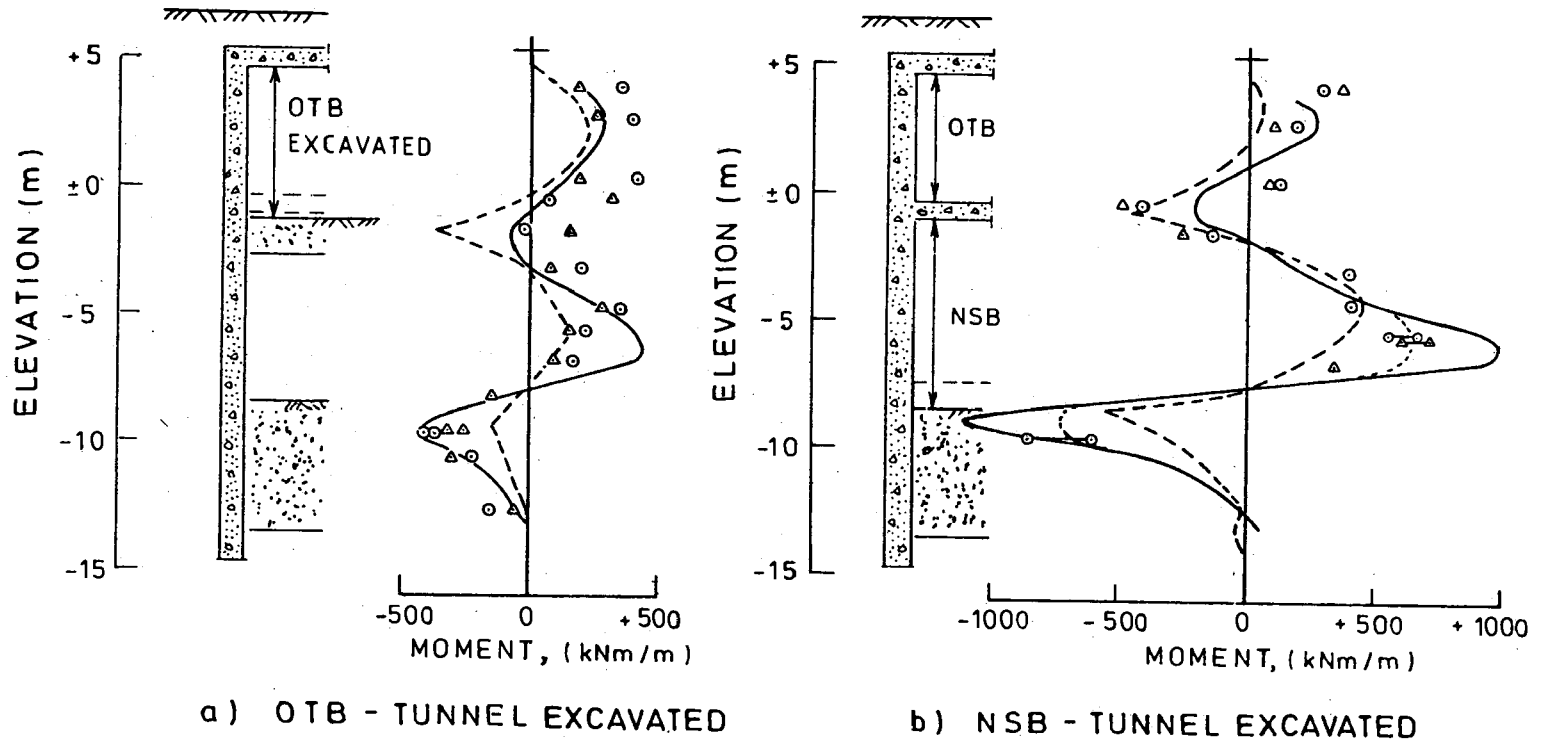


Fig. 14 Typical earth pressure distributions, Studenterlunden



----- Computed from measured earth pressure (fixed supports)

————— Deduced from measured slope changes

|   |                       |                              |
|---|-----------------------|------------------------------|
| △ | Just after excavation | } Computed from strain gages |
| ○ | 1 - 2 month later     |                              |

Fig. 15 Moment distributions, Studenterlund

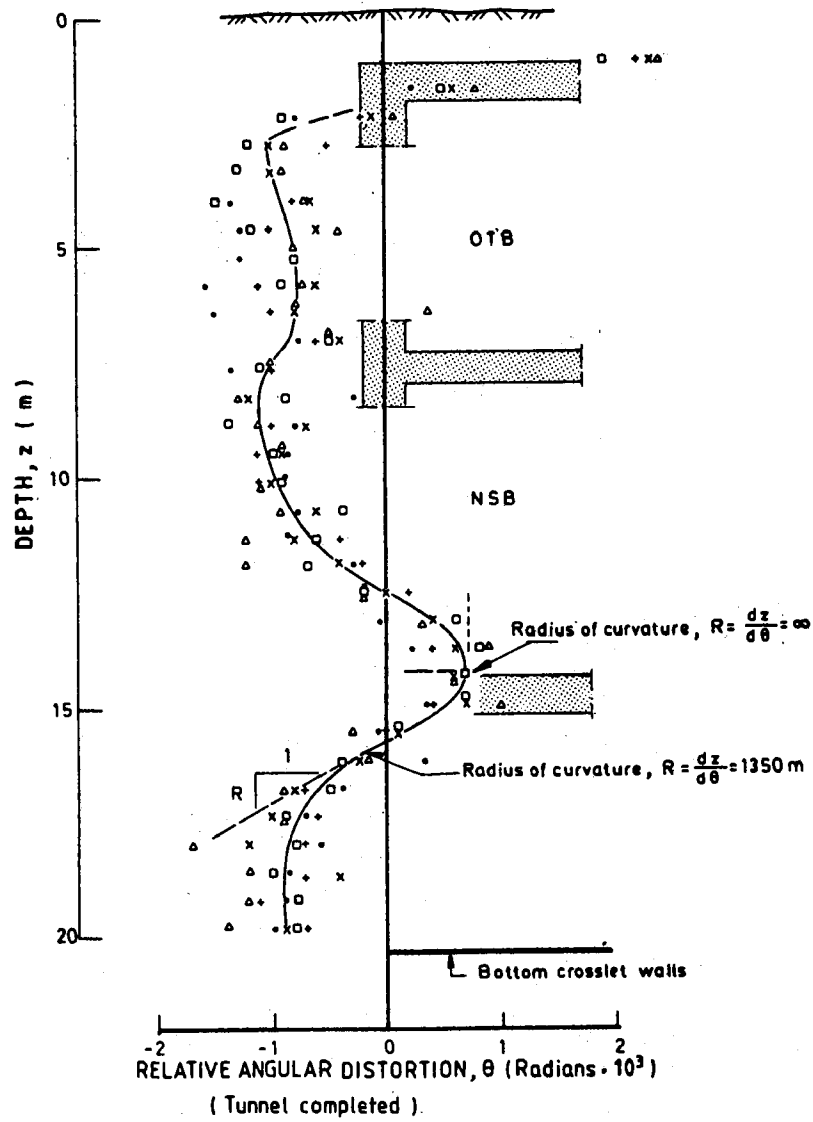


Fig. 16 Example of observed angular distortions of wall, Studenterlunden

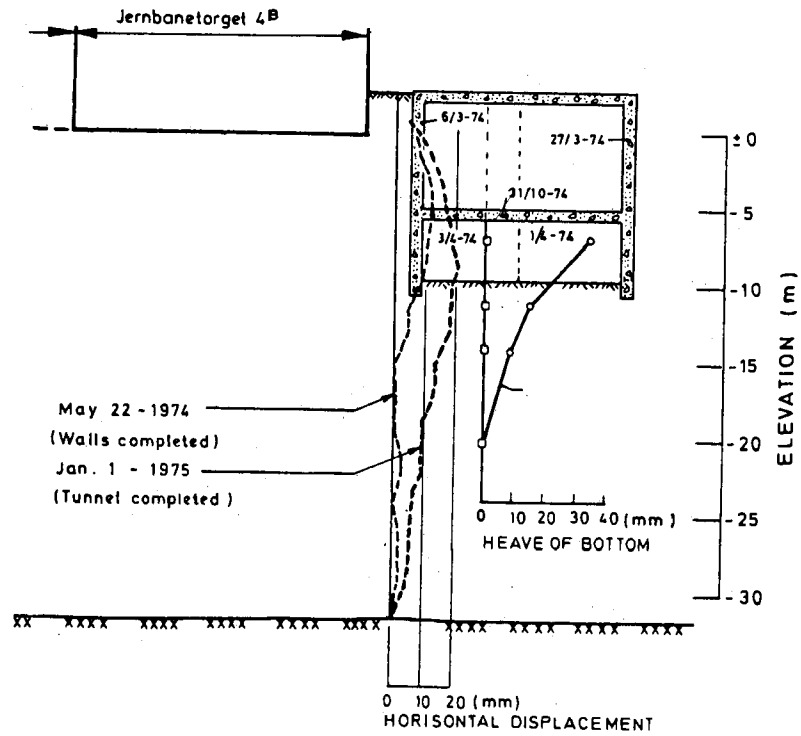


Fig. 17 Displacement patterns, Jernbanetorget

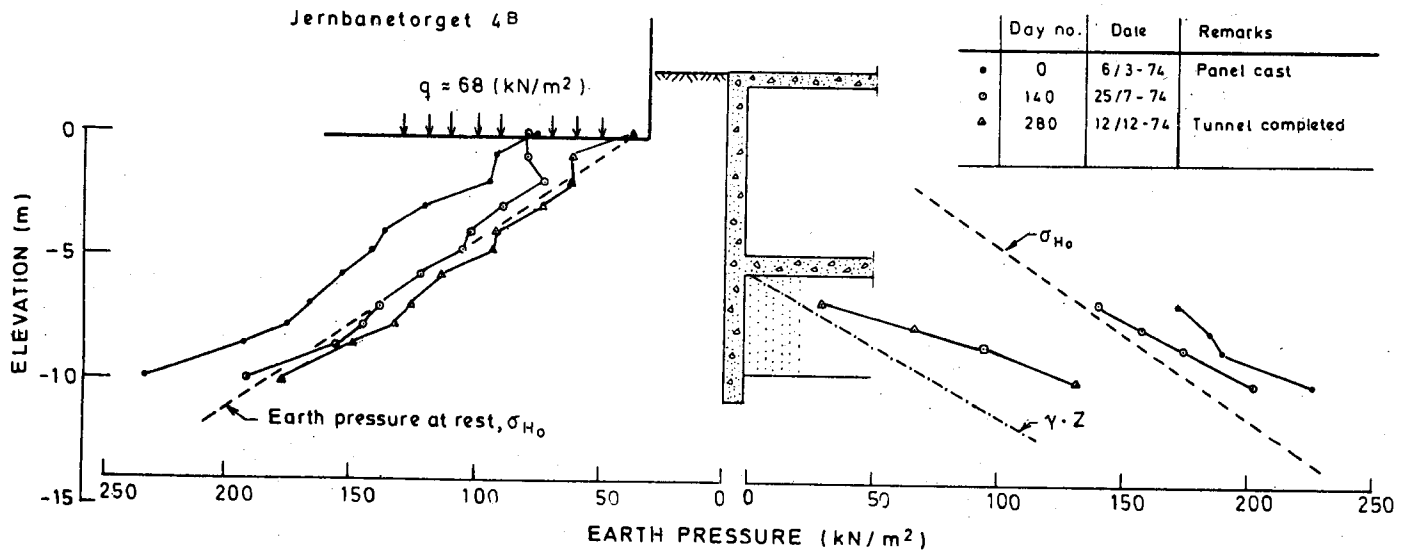


Fig. 18 Earth pressures, Jernbanetorget



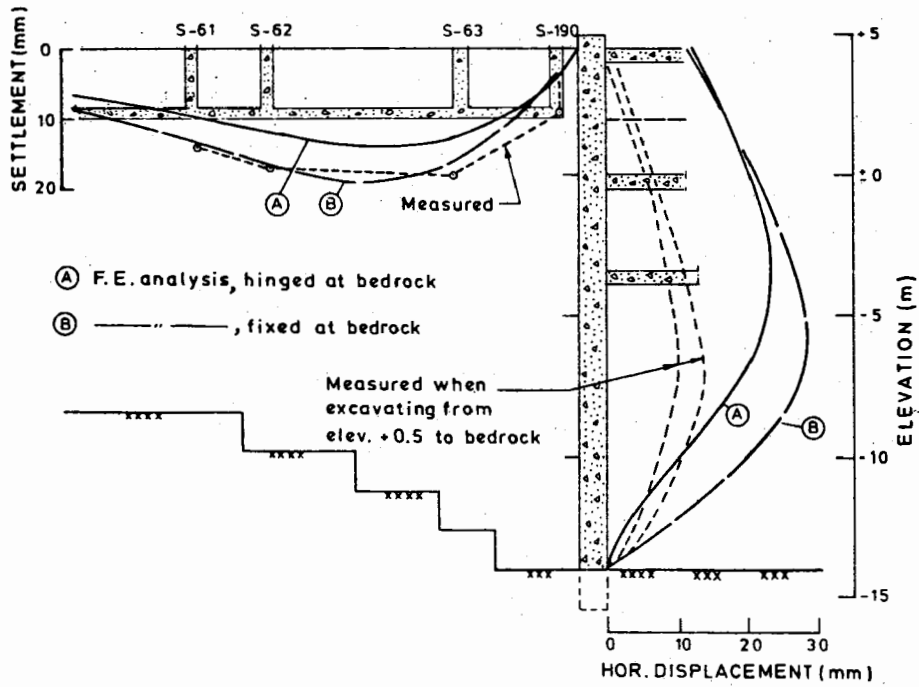


Fig. 19 Computed and measured displacements, Kongensgt.

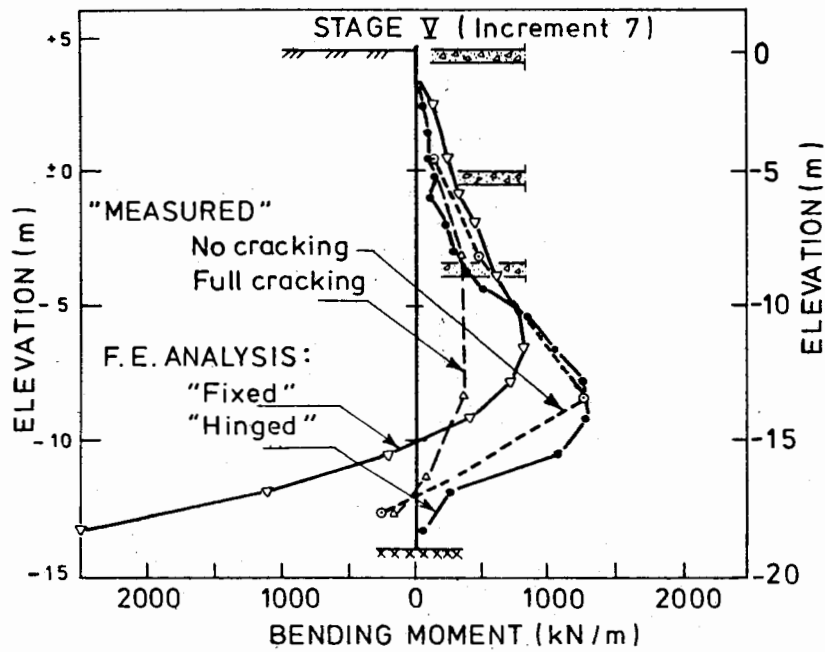


Fig. 20 Computed and measured earth pressures, Kongensgt.

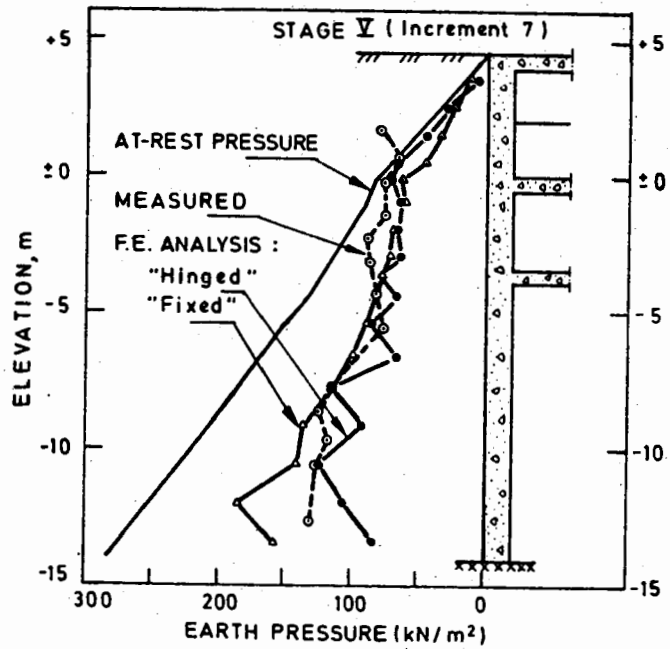
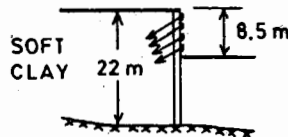


Fig. 21 Computed and "measured" bending moments, Kongensgt.



| CASE | SHEAR STRENGTH | WALL STIFFNESS | SOIL STIFFNESS | PRESTRESS. FORCE | MAX. BENDING MOMENT, kNm/m |      |
|------|----------------|----------------|----------------|------------------|----------------------------|------|
|      |                |                |                |                  | Pos.                       | Neg. |
| 1    | A              | A              | A              | A                | 1000                       | 590  |
| 2    | A              | A              | A              | B                | 2130                       | 1360 |
| 3    | A              | A              | C              | A                | 1750                       | 200  |
| 4    | A              | B              | A              | A                | 2090                       | 410  |
| 5    | C              | A              | A              | A                | 1750                       | 500  |
| 6    | C              | B              | A              | A                | 2690                       | 590  |

A - " Normal " ( Most resonable, best estimated )  
 B - Exstreme high  
 C - Exstreme low

Fig. 22 Parametric finite element study, Drammen hospital

SPEAKER: Kjell Karlsrud  
Norwegian Geotechnical Inst.

F. A. Bares  
Parsons, Brunckerhoff

Question:

What was the maximum length of excavations that you tested?

Mr. Karlsrud

Answer:

You are talking now about the maximum length of the panels we tested?

Mr. Bares

Question:

You mentioned the length of 20 meters and thickness of one meter.

Mr. Karlsrud

Answer:

Well actually it was four test panels at different sites and at different lengths. The one you saw was 5 meters long.

Mr. Bares

Question:

What was the maximum length?

Mr. Karlsrud

Answer:

The maximum length was 5 meters.

Mr. Bares

Question:

That was the maximum length excavated, using only water?

Mr. Karlsrud

Answer:

Yes, on that test panel there. To look at the effect of the length of the panels, we carried out test panels varying in length from 1.8 meters to 11 meters in one piece. We carried out one piece in 11-meter length. Actually it was just barely stable with water as slurry.

Mr. Bares

Question:

At 11 meters you were barely stable?

Mr. Karlsrud

Answer:

Barely stable at 11 meters. And that was just as predicted with the method of analysis we adopted.

Mr. Bares

Question:

Would you use water for support of excavation in any type of clay, or would you make a study to determine if you could use water for a particular clay?

Mr. Karlsrud

Answer:

Well, I'm not prepared to say in any type of clay. This clay was fairly homogenous, although there were some sand lenses in it. I would be a little bit cautious about stiffness of clay. I would certainly make a test panel if I were to use water in other types of clay. I think I would make a test panel first to see if it worked. But I think if you talk about normally consolidated clays, I think water would work under most conditions.

Mr. Bares

Question:

Would you use the same system in London clay?

Mr. Karlsrud

Answer:

Well I'm no expert on London clay so I would be a little bit cautious in answering that.

Drupad Desai  
Daniel, Mann, Johnson &  
Mendenhall

Question:

What was the subgrade modulus of the clay that you experimented with?

Mr. Karlsrud

Answer:

Well the Young's modulus was in the range of between 1500 and 2000 tons per square meter. But, of course, in the final element analysis, we used a variation.

FUTURE RESEARCH

BY

DONALD A. LINGER  
FEDERAL HIGHWAY ADMINISTRATION  
WASHINGTON, D.C.

ABSTRACT NOT AVAILABLE

PAPER NOT AVAILABLE

QUESTIONS & ANSWERS FOLLOW

SPEAKER: Dr. D. A. Linger  
Federal Highway Administration

John Dunicliff  
Geotechnical Instrumentation  
Consultant

Question:

Don, you talked of your three-pronged approach, the end product of which seemed to me to be some words on paper. Now you and I have talked many times about problems of dissemination of these goodies that we come up with. I'd like to have your current thoughts on this. Are we wise to express our research thoughts on paper and distribute them to the profession? Is this forum we have had these two days the best way or are we all too busy as engineers to attend many of these things? What are your thoughts on dissemination of material?

Dr. Linger

Answer:

Well, John, it's a very good point. One of the problems that we have as engineers is that we often overlook or forget the institutional problems, and we may come up with a beautiful answer that simply will never be used. And we could have the best managed and the best engineered tunnel in the entire world--contracting prices and everything--and we may never hear about it because two of those things I talked about aren't done in general. We don't take the construction monitoring instrumentation and require it to be analyzed, interpreted, and presented. And we very seldom have a history of a construction project here in the U.S. which has any documentation at all. So what John has asked is, What do we do? Well, in most cases we are too busy adding numbers, dotting i's and crossing t's to get into this. What I've done, and it has fallen on deaf ears, is to write people above me in the Department of Transportation, saying, "Hey, we ought to do this." And, of course, you know one of the problems we have is that when we get layers of people in a design and you drop this thing down through them, it doesn't get more and more sophisticated and better and cheaper and less expensive. It gets more conservative and more conservative because everybody's got a question about it, and by the time it gets to the bottom, it's so conservative

Dr. Linger  
(cont'd)

that it's absolutely outrageous in cost. I say that because I'm at the bill-paying end. But, anyway, when I send something up through the layers of people, by the time it gets to the top I don't know what it says and nothing gets done. So what I am doing is finding projects in which we in Federal Highway will be doing the project with "hands on" and then I'm getting myself over there and writing up what I consider to be a program that they should follow. You know, this program includes all those niceties I just mentioned. I mean, they don't know the difference. So once I do this and grind this through a couple of times, maybe it will become something that everyone sees as a potential cost-saving procedure. How do we do this? I think if we make ourselves known by requiring or proposing--and we can't require--but if we could, with our professional societies, indicate the desirability of doing some of these things, I think that the people would listen. They have a tendency not to listen to one person. I don't know, John, I really don't. I don't know how to do it. I've been trying, but to little avail. But you notice everything we have heard that really provoked a lot of interest made people gain some confidence. If you came in here not knowing anything about a slurry wall and you saw some of the numbers, you would begin to realize that, in fact, this thing is realistic. You can control it; you can predict. And all of a sudden, as an engineer, you will accept its use. And we have to do the same thing to further this.

Mr. Dunnicliff

Question:

I personally feel that the best way to disseminate knowledge is through these conferences. I don't know whether you will agree with this or not.

Dr. Linger

Answer:

Well, what would you advocate, John?

Mr. Dunnicliff

Question:

More conferences.

Dr. Linger

Answer:

Oh, yes, okay, more conferences. Well I can tell you that the frozen ground research that we're doing will culminate in a conference like this on frozen ground. And I think, and Dick Sallberg can correct me if I'm wrong, that we anticipate doing the same thing-- addressing the question of design for grouting; that is, the use of grouting in the design, not as a post-mortem in the way of how to get out of a hell-of-a-fix problem, but how to use grout in the design at the very outset. And I think, in fact, we are developing techniques now where one can predict the extent of the grout curtain or grout permeation and the effect of the grout permeation, and I think that we have in the offing next year a similar conference on grouting. There are a number of ground control conferences coming up.

Nelson G. Chenaux  
Booz, Allen

Question:

I appreciate the comment just brought up about getting this information out, but suppose you are not at one of these conferences, and you cannot be at all of them. They are kind of expensive for our company. Furthermore, you have to do research. You need to have these things in your hand to study them, work with them. So I'd like to recommend that you get your findings published in the professional journals. They go into libraries where they can be found again. They are available to everybody. There's a chance to study the data and, in my view, that would be one of the best ways to get the information out--professional journals.

Dr. Linger

Answer:

Thank you. I think for the most part we do. But we may not do it enough. And there is no one single tunneling professional society, which lends some difficulties to us. Some of it shows up in TRB and some of it shows up in ASCE and some in RETC, but if you join all those, you might as well go to the conferences. But anyway, I appreciate your comment.



