

Test Bed Transit Bus Fuel Economy Tests



U.S. Department
of Transportation

Urban Mass
Transportation
Administration

Office of Technical Assistance
Office of Bus and Paratransit
Systems

Prepared by:
Battelle
Columbus Laboratories

November 1983

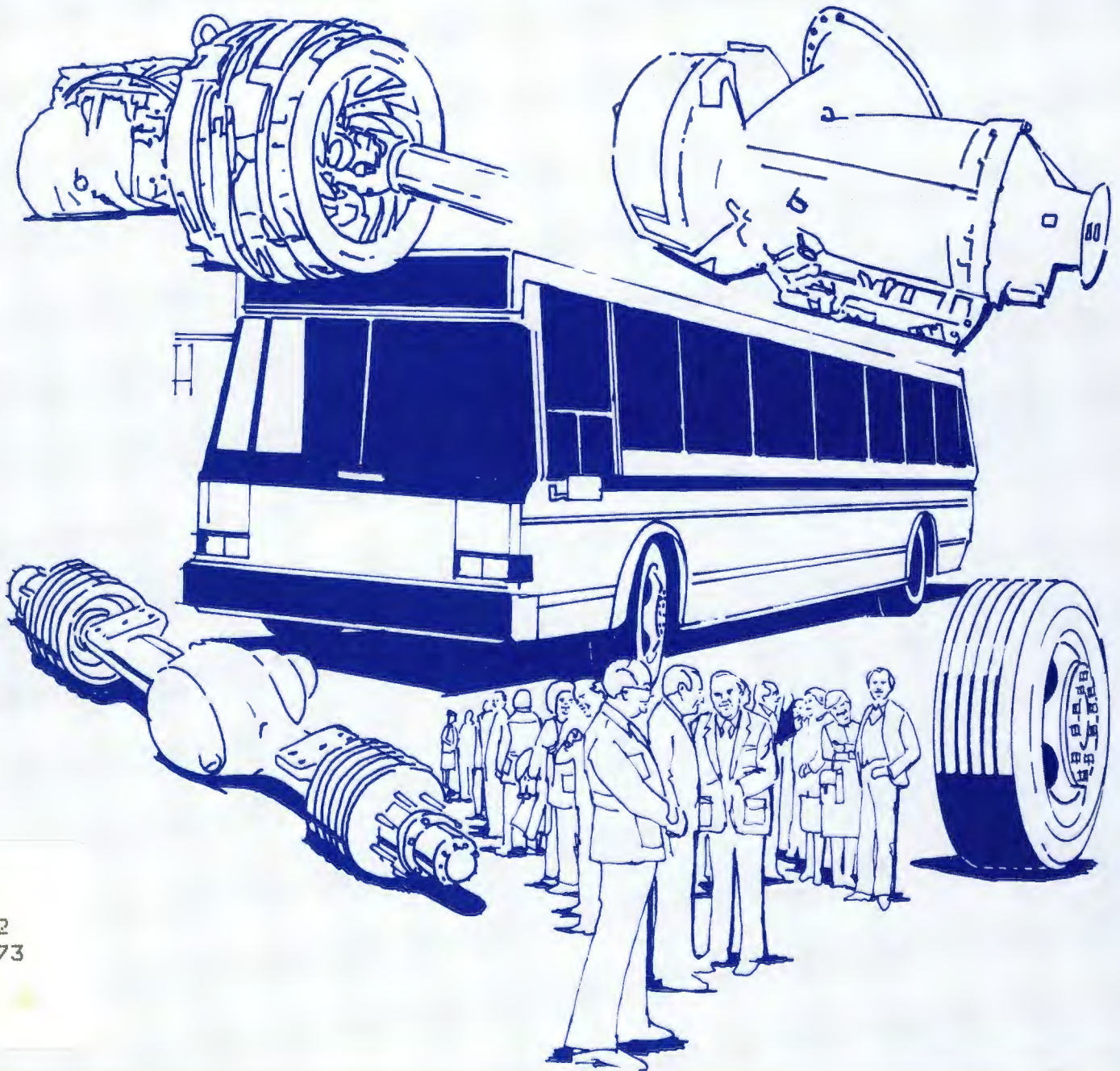

TL
232
.F73

NOTICE

This document is disseminated under the sponsorship of the Department of Transportation in the interest of information exchange. The United States Government assumes no liability for its contents or use thereof.

NOTICE

The United States Government does not endorse products or manufacturers. Trade manufacturers' names appear herein solely because they are considered essential to the object of this report.

TEST BED TRANSIT BUS
FUEL ECONOMY TESTS

to

DEPARTMENT OF TRANSPORTATION/UMTA
Office of Bus and Paratransit Systems

November 1983

by

G. A. Francis, S. R. Nelson, J. L. Ruckman

BATTELLE
Columbus Laboratories
505 King Avenue
Columbus, Ohio 43201

05635

TL
232
.F73

Technical Report Documentation Page

1. Report No. UMTA-IT-06-0219-11-2	2. Government Accession No.	3. Recipient's Catalog No.	
4. Title and Subtitle Test Bed Transit Bus Fuel Economy Tests		5. Report Date November 1983	6. Performing Organization Code
		8. Performing Organization Report No. UMTA-IT-06-0219-11-2	
7. Author(s) G. A. Francis, S. R. Nelson, J. L. Ruckman		10. Work Unit No. (TRAIS)	
9. Performing Organization Name and Address Battelle's Columbus Laboratories 505 King Avenue Columbus, Ohio 43201		11. Contract or Grant No. DTUM60-81-C-71103	
		13. Type of Report and Period Covered Final Report May 1983 to November 1983	
12. Sponsoring Agency Name and Address U.S. Department of Transportation Urban Mass Transportation Administration 400 Seventh Street, S.W. Washington, D. C. 20590		14. Sponsoring Agency Code URT-20	
15. Supplementary Notes			
<p>16. Abstract</p> <p>This report documents a series of thirteen proving ground fuel economy tests conducted on two 40-foot transit buses to determine the effect of weight or component changes on fuel economy. One bus featured a transverse-mounted engine; one an in-line-mounted engine. The buses were subjected to tests based on the Advanced Design Bus (ADB) Cycle and SAE J1321 Type II test procedures. Weights and driveline components were changed and the effects of these changes were documented.</p> <p>These tests were performed under contract to UMTA at the Transportation Research Center of Ohio. Battelle-Columbus planned, managed, and participated in conducting the tests with excellent cooperation from the transit industry.</p>			
17. Key Words Bus Fuel economy MPG test planning Test procedures Testing		18. Distribution Statement Available to the Public through the National Technical Information Service, Springfield, Virginia 22161.	
19. Security Classif. (of this report) Unclassified	20. Security Classif. (of this page) Unclassified	21. No. of Pages	22. Price

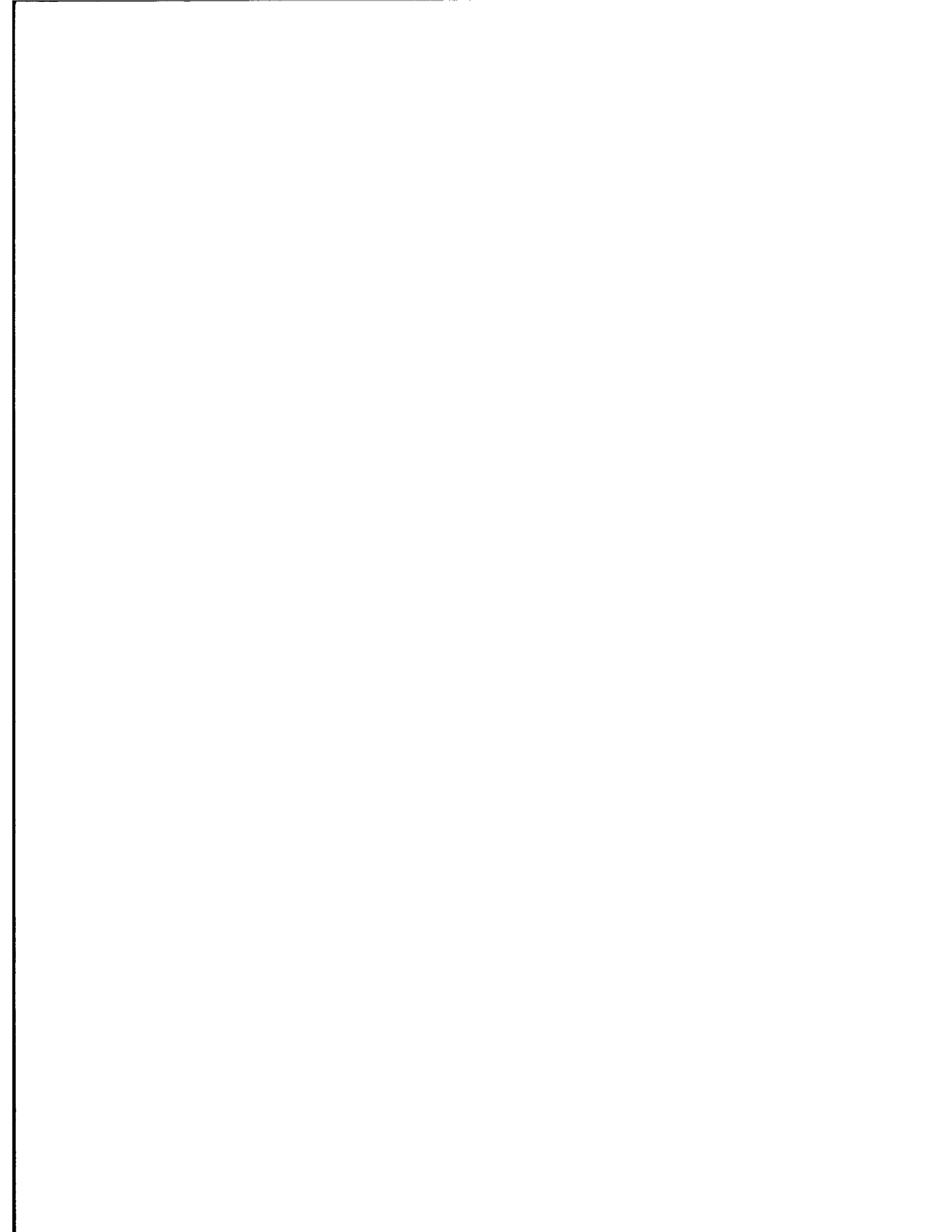

METRIC CONVERSION FACTORS

When You Know	Multiply by	To Find	Symbol
LENGTH			
millimeters	0.04	inches	in
centimeters	0.4	inches	in
meters	3.3	feet	ft
kilometers	1.1	yards	yd
	0.6	miles	mi
AREA			
square centimeters	0.16	square inches	in ²
square meters	1.2	square yards	yd ²
square kilometers	0.4	square miles	mi ²
hectares (10,000 m ²)	2.5	acres	ac
MASS (weight)			
grams	0.035	ounces	oz
kilograms	2.2	pounds	lb
tonnes (1000 kg)	1.1	short tons	st
VOLUME			
milliliters	0.03	fluid ounces	fl oz
liters	2.1	pints	pt
liters	1.06	quarts	qt
liters	0.26	gallons	gal
cubic meters	35	cubic feet	ft ³
cubic meters	1.3	cubic yards	yd ³
TEMPERATURE (exact)			
°C	Celsius temperature	°F (Fahrenheit temperature)	°F

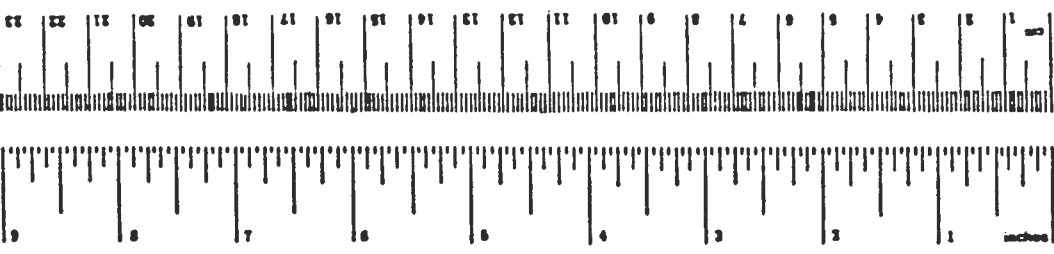

When You Know	Multiply by	To Find	Symbol
LENGTH			
inches	2.5	centimeters	cm
feet	30	centimeters	cm
yards	0.9	meters	m
miles	1.6	kilometers	km
AREA			
square inches	6.6	square centimeters	cm ²
square feet	0.09	square meters	m ²
square yards	0.8	square meters	m ²
square miles	2.6	square kilometers	km ²
acres	0.4	hectares	ha
MASS (weight)			
ounces	28	grams	g
pounds	0.45	kilograms	kg
short tons (2000 lb)	0.9	tonnes	t
VOLUME			
teaspoons	5	milliliters	ml
tablespoons	15	milliliters	ml
fluid ounces	30	milliliters	ml
cup	0.24	liters	l
pint	0.47	liters	l
quart	0.96	liters	l
gallon	3.8	liters	l
cubic feet	0.03	cubic meters	m ³
cubic yards	0.76	cubic meters	m ³
TEMPERATURE (exact)			
°F	Fahrenheit temperature	°C (Celsius temperature)	°C

* 1 in = 2.54 exactly. For other exact conversions and more detailed tables, see NBS Misc. Publ. 288, Units of Weight and Measure, Price \$2.95, SD Casting Inc. C13.10286.

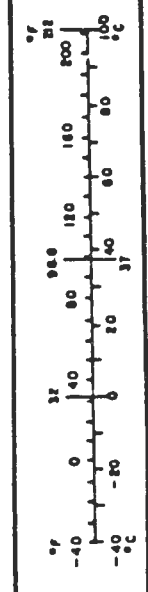

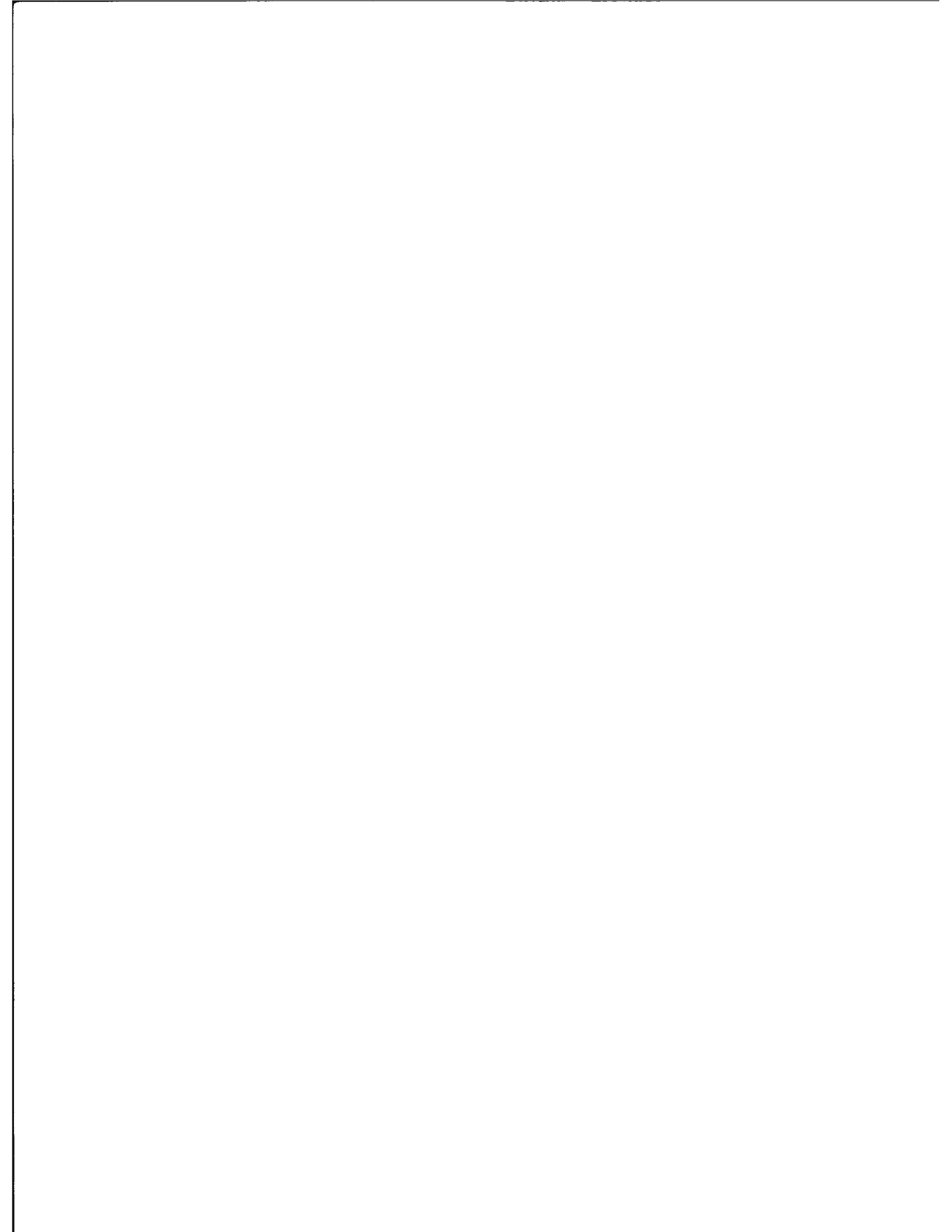

ACKNOWLEDGMENTS

The authors acknowledge and appreciate the industry's support of this effort. The support included supplying control and test buses, and consultation during tests.

Thanks to the following organizations:

American Public Transit Association

Detroit Diesel Allison Division (DDA)

Flxible Corporation

GMC Truck and Coach Division

Goodyear Tire and Rubber Company

Neoplan USA Corporation

Office of Bus and Paratransit Systems, UMTA

Port Authority of Allegheny County (PAT)

Society of Automotive Engineers

Telma Retarders, Inc.

Transportation Research Center of Ohio (TRC)

Transportation Systems Center, Department of Transportation

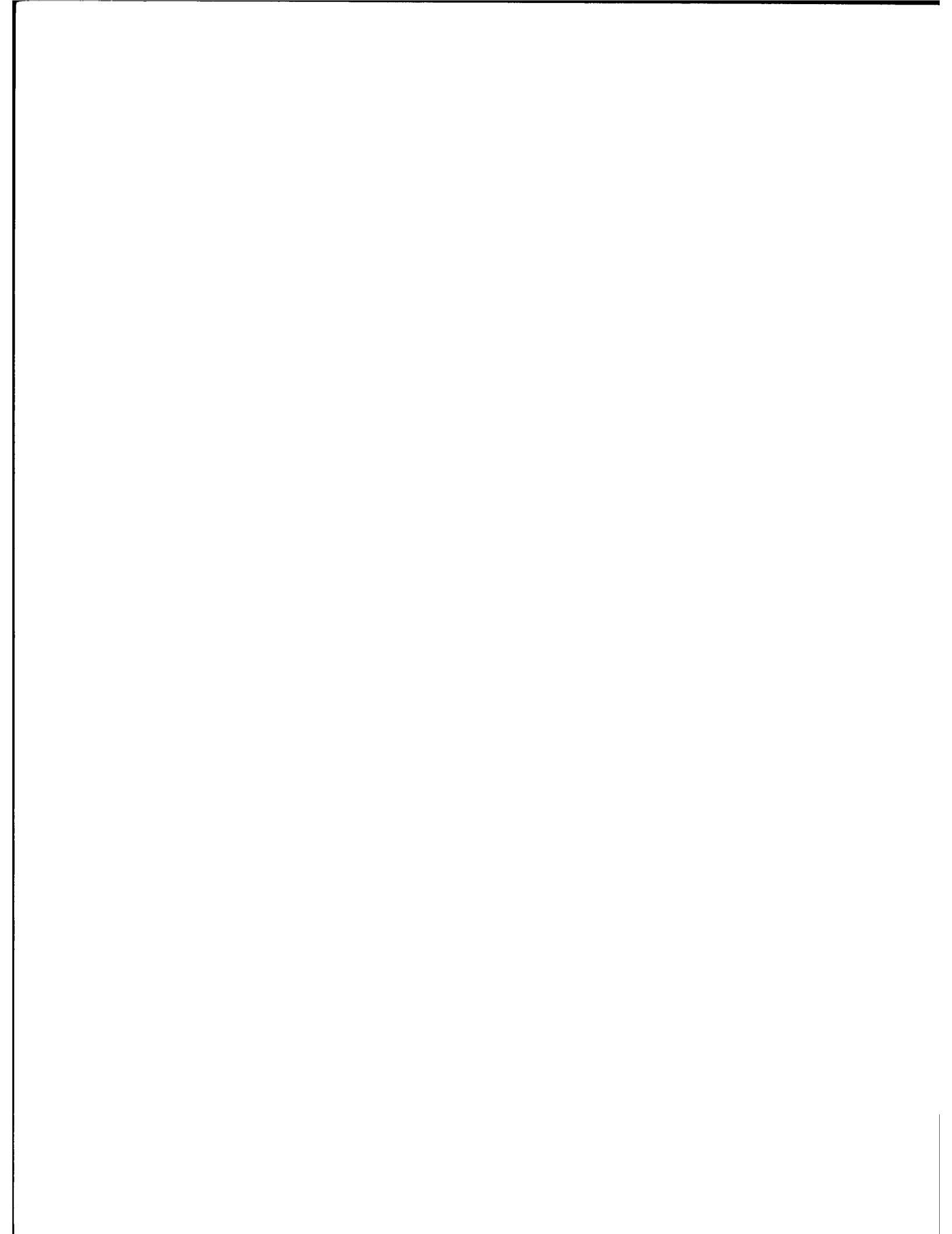

EXECUTIVE SUMMARY

The importance of life-cycle cost analysis in transit bus procurement is recognized by the industry and is of increasing concern to grantees in specifying new buses. In order to assist transit authorities and the industry's suppliers, the Urban Mass Transportation Administration (UMTA) Office of Bus and Paratransit Systems has performed the test-bed fuel economy tests described in this report. The purpose of these tests is to determine the fuel economy impact of changes in vehicle weight or selected components. This information is being used in the development of HEVSIM, a computer simulation program capable of predicting the fuel economy of a particular transit bus with specific components, carrying a specific weight, over a specified duty cycle, without the need for further testing. This model was developed at Transportation Systems Center in Cambridge, Massachusetts.

These fuel economy tests were conducted at the Transportation Research Center of Ohio (TRC) by TRC and Battelle personnel. Battelle's Columbus Laboratories, under contract to UMTA, with the assistance of the three bus manufacturers, the Port Authority of Allegheny County (PAT), Detroit Diesel Allison, and Telma planned and conducted the test program. The preparation of the buses, running of the tests, and pickup/return of the inline test bus was performed by TRC personnel experienced in bus fuel economy testing. Driveline components that were changed on the transverse engine test bus, a Grumman 870, were changed by Flexible mechanics at the Loudonville, Ohio, facility. The components changed on the inline engine test bus, a Neoplan USA vehicle supplied by PAT, were the Telma retarder and tires. The retarder change was made at TRC according to a procedure provided by Telma. The tires were also changed by TRC personnel.

Planning began in May of 1983. On June 30, 1983, a test plan was released which was based on the plan used in the previous fuel economy tests. Section 2.0 of this report describes the implementation of this fuel economy test plan.

The control vehicle used in this test was the GMC Truck and Coach RTS-II-04 control bus used in the previous testing referenced in this report. The transverse engine bus used in the "T" series of tests was the Grumman 870 previously used as a control vehicle. The inline engine bus used in the "I" series of tests was a Neoplan USA bus supplied by PAT. All of these buses were prepared for testing by TRC mechanics to assure that they were in proper working order.

Table 1 shows the change in fuel economy for both test bed buses as single changes were made from the baseline configurations. The percent change figures in the combined columns are accurate to within ± 1 percent as defined by SAE J1321. The other percent change figures are somewhat less accurate due to the fact that less fuel was used on the individual phases, so weighing accuracy limits and a small variation in fuel consumed became important. The plus percentages show increases in fuel economy (higher MPG) resulting from the configuration change. The minus percentages represent reductions in fuel economy (lower MPG). The baseline run of the Neoplan bus is run I-2. Runs I-1 and I-6 were completed with the Telma retarder installed.

This report is organized to present an overview of the fuel economy tests in Section 2.0. Results and conclusions are presented in Section 3.0. The test plan and the tests are described in Section 3.0, and the appendices then give detailed information on the SAE test procedure, the test facility, and the test data.

TABLE 1. FUEL ECONOMY TEST RESULTS

Test Number	Configuration Change	Commuter	Arterial	CBD	Combined*
I-1	With Retarder	0	0	0	0
I-2	Baseline**	0	0	0	0
I-3	1.5xSLW	-2	-6	-1	-2
I-4	Empty	8	9	12	10
I-5	Radial Tires	10	8	9	9
I-6	Retest With Retarder	0	-4	0	-1
T-1	Baseline	0	0	0	0
T-2	1.5xSLW	-6	-7	-7	-7
T-3	Empty	7	11	13	11
T-4	5.375 Axle Ratio	-14	6	-2	-2
T-5	UEC Transmission (Optional PROM)	0	2	-5	-2
T-6	UEC Transmission (Fuel Economy PROM)	1	11	-2	2
T-7	Retest Baseline	1	0	-3	-1

* Percent change in fuel economy; plus numbers are increases in fuel economy from the baseline configuration and minus numbers are decreases. The baseline test for each bus was run with:

- (1) Seated load weight (SLW)
- (2) Air conditioning off
- (3) Evaporator fan or ventilation fan on
- (4) Diesel No. 2 Supreme fuel
- (5) Exterior and interior lights on.

** The baseline test was run without the retarder installed.

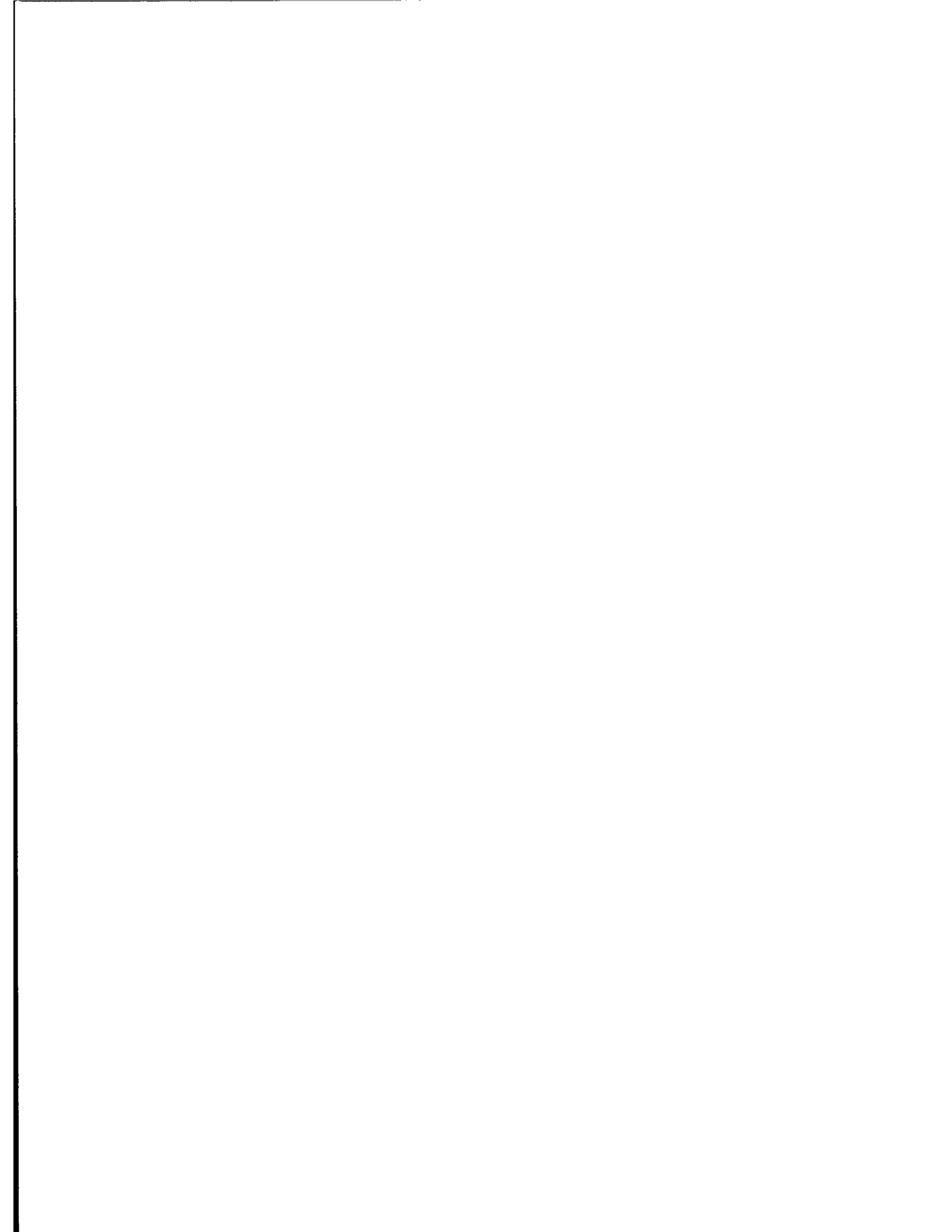

TABLE OF CONTENTS

	<u>Page</u>
1.0 INTRODUCTION	1
1.1 Purpose of Tests	1
1.2 Buses Used in Tests	1
1.3 Brief Test Description	1
2.0 TECHNICAL APPROACH	3
2.1 Program Participants and Supporters	3
2.2 Test Procedure and Implementation	3
2.2.1 Overall Description of Test Procedures	3
2.2.1.1 Modifications to SAE and ADB Procedure Test	4
2.2.1.2 Additional Testing	11
2.2.2 Vehicle Preparation	11
2.2.2.1 Initial Service	11
2.2.2.2 Documentation	12
2.2.2.3 Vehicle Preparation	12
2.2.2.4 Daily Inspection	12
2.2.2.5 Gravimetric Tank System Installation	12
2.3 Maintenance	15
2.4 Test Procedure	15
2.4.1 Fuel Economy Test Cycle	15
2.4.1.1 Morning Inspection	15
2.4.1.2 Warm-Up	15
2.4.1.3 Fuel Economy Testing	15
2.4.2 Fuel Analysis	17
2.4.3 Weather Conditions	17
3.0 RESULTS AND CONCLUSIONS	18
3.1 Results	18
3.2 Conclusions	27

TABLE OF CONTENTS

	<u>Page</u>
APPENDIX A	
JOINT TMC/SAE FUEL CONSUMPTION TEST PROCEDURE-TYPE II - SAE J1321 OCT81	A-1
APPENDIX B	
TRACK DESCRIPTION	B-1
APPENDIX C	
FUEL ECONOMY TEST DATA	C-1

LIST OF TABLES

	<u>Page</u>
TABLE 2.1. BUS FUEL ECONOMY TEST CYCLE	5
TABLE 3.1. SPECIFICATIONS OF FLXIBLE TEST BUS.....	20
TABLE 3.2. SPECIFICATIONS OF NEOPLAN TEST BUS	21
TABLE 3.3. TEST BED BUS CONFIGURATIONS	22
TABLE 3.4. FUEL ECONOMY TEST RESULTS	23

LIST OF FIGURES

FIGURE 2.1. BUS FUEL ECONOMY TEST CYCLE	6
FIGURE 2.2. TRANSIT COACH DESIGN OPERATING DUTY CYCLE	7
FIGURE 2.3. TRANSIT COACH DESIGN OPERATING PROFILE DUTY CYCLE	8
FIGURE 2.4. VIEW OF SIGNS AT BEGINNING AND END OF TEST CYCLE	10
FIGURE 2.5. GRAVIMETRIC TANK AND GRUMANN TEST BUS	10
FIGURE 2.6. UMTA BUS FUEL ECONOMY TEST FUEL SYSTEM SCHEMATIC	13
FIGURE 2.7. FUEL WEIGHING SYSTEM	14
FIGURE 2.8. TEST FUEL SYSTEM INSTALLED IN BUS	14
FIGURE 2.9. BATTELLE COLUMBUS LABORATORIES TESTBED TRANSIT BUS FUEL ECONOMY TESTS	16
FIGURE 3.1. FLXIBLE TEST BUS	19
FIGURE 3.2. NEOPLAN TEST BUS	19
FIGURE 3.3. RESULTS OF TRANSVERSE BUS TESTS	24
FIGURE 3.4. RESULTS OF INLINE BUS TESTS	25
FIGURE B-1. HIGH SPEED TEST TRACK	B-2



1.0 INTRODUCTION

This report documents a program to determine the fuel economy changes on a test-bed transit bus as a result of weight and/or component changes. The tests were conducted by Battelle's Columbus Laboratories at the Transportation Research Center of Ohio (TRC). TRC was responsible for test execution during the period starting in late June and ending in mid September, 1983. The program was performed under contract to the Urban Mass Transit Administration (UMTA) as part of their Technical Assistance Program.

1.1 Purpose of Tests

The specific purpose of this series of tests is to provide the Transportation Systems Center (TSC) with data for correlation with the HEVSIM computer simulation results.

1.2 Buses Used in Tests

Three buses were used during these tests. The GMC Truck and Coach RTS-II-04 used as a control bus during the fuel economy testing of six 40-foot transit buses last fall was used as the control bus during these tests. The Grumman Flxible 870 used as the other control bus in last fall's tests was used as the transverse-mounted engine test bus. Finally, a Neoplan USA 40-foot transit bus was leased from the Port Authority of Allegheny County (PAT) as the inline-mounted engine test bus.

1.3 Brief Test Description

The overall fuel economy test procedure was very similar to that used in the previous 40-foot transit bus fuel economy testing.* The buses were tested over a course

* Francis, G. A., and Nelson, S. R., "Fuel Economy Testing of Six 40-Foot Transit Buses", Report No. UMTA-IT-06-0219-11-1. Prepared by Battelle's Columbus Laboratories, March, 1983.

based on the Transit Coach Operating Duty Cycle (ADB Cycle) at various load weights and with different components installed using a procedure based on Joint TMC/SAE Fuel Consumption Test Procedure - Type II - SAE J1321 OCT81 (see Appendix A). This procedure, with the control bus ballasted to seated load weight (SLW), allowed the differences in fuel economy with configuration changes to be accurately measured.

The fuel economy tests were performed at the Transportation Research Center of Ohio on the inside lane of the 7.5-mile test track (see Appendix B). Signs were erected at carefully measured points to mark the test course for the drivers. The course included 8 miles of commuter, 8 miles of arterial, and 14 miles of CBD. An electronic fuel weighing system, developed for the previous test program, permitted an accurate determination of fuel consumption for each of these three phases. At least one control and one test vehicle were involved in each test run. The test runs were repeated until there were three test runs in which the fuel used by the test bus divided by the fuel used by the control bus, the T/C ratio, for each 30-mile run were within two percent of each other. This set of three valid runs completed one valid test. The test was then repeated for a total of six valid runs before the T/C ratios were accepted as accurately reflecting the fuel economy of that particular test configuration.

After the completion of each pair of tests, the vehicle configuration (weight of components installed) was changed. The fuel economy test was repeated in the new configuration. At the end of this test program, the GMC control bus was returned to GMC, the Neoplan test bus was returned to PAT, and the Flxible test bus was returned to Flxible Corporation.

2.0 TECHNICAL APPROACH

The program management and technical approach for this fuel economy study was to perform tests under carefully controlled test track conditions and to use the largest practicable body of industry knowledge and experience in planning the tests. The approach was to identify the data required to support further development of the HEVSIM computer simulation program at TSC and to obtain those data.

2.1 Program Participants and Supporters

The Urban Mass Transportation Administration (UMTA), through the Office of Bus and Paratransit Systems, was responsible for technical direction of the program. Battelle's Columbus Laboratories (BCL) was responsible for planning, coordinating, and conducting the test-bed fuel economy study and for evaluating and reporting the program results. The testing was performed by the Transportation Research Center of Ohio (TRC) personnel with BCL staff on-site supporting and monitoring test personnel.

Both General Motors Corporation Truck and Coach Division and Grumman Flexible Corporation supplied buses and they, along with Neoplan USA Corporation, reviewed the test plan. Cooperation was excellent. The Port Authority of Allegheny County (Pittsburgh, Pennsylvania) also supported the program in an extremely meaningful way by supplying the Neoplan test bus from its fleet.

American Public Transit Association also played an important role in acquainting the bus manufacturers and transit authorities with test program and the potential of the HEVSIM program through discussions at the Bus Technology Liaison Board meeting.

2.2 Test Procedure and Implementation

This series of tests was performed at TRC located at East Liberty, Ohio. The 7.5-mile test track is described in Appendix B.

2.2.1 Overall Description of Test Procedures

Control and test buses were provided by the bus manufacturers and the transit authority named in Section 1.2. One test bus and the control bus were already at TRC at

the start of this program. The other test bus was driven to the test site from Pittsburgh. The buses received a complete vehicle preparation which included service (oil changes, filter changes, brake inspections, etc.), wheel alignment, front wheel balance, and all other necessary preparations for testing.

Each bus in each configuration was tested for fuel economy using the test cycle described in Table 2.1 Bus Fuel Economy Test Cycle, and Figure 2.1 Bus Fuel Economy Test Cycle. These fuel economy tests were based on Joint TMC/SAE Fuel Consumption Test Procedure - Type II - SAE J1321 OCT81. The test cycle is made up of the individual start, stop, and top speed elements of the ADB Cycle arranged to permit obtaining relative fuel consumption for each of the three phases.

2.2.1.1 Modifications to SAE and ADB Procedure Test. In the course of planning and executing this test program, modifications were made in some established procedures. This section describes how the ADB cycle was run and how SAE J1321 was used. The operating cycle described in the "White Book"* is shown by Figures 2.2 and 2.3. The basic acceleration, cruise, and deceleration profiles of the CBD, arterial, and commuter phases shown in Figure 2.3 were maintained for this series of tests. However, the changes were made in the overall sequence of phases to produce compatibility among the ADB cycle, the SAE procedure, T/C** data desired, and the test facility. None of the changes made reduce the accuracy of the results.

There were three modifications that were made to the ADB cycle.

- o The ADB cycle is structured as a set number of miles on fixed time in the following order: CBD, idle, arterial, CBD, arterial, CBD, commuter. The cycle used in our test program collected these phases together into the following order: commuter, arterial, and CBD. This phase sequence permitted the reporting of fuel economy for each of these phases separately and should make the data more useful to bus manufacturers and transit properties. Idle fuel consumption tests were not performed in this series of tests.

* Baseline Advanced Design Transit Coach Specification, Urban Mass Transportation Administration, U.S. Department of Transportation, Washington, D.C., November 1978.

** See explanation in Appendix C.

TABLE 2.1. BUS FUEL ECONOMY TEST CYCLE

Phase	Stops/ Mile	Top Speed, mph	Miles	Acceleration		Cruise		Deceleration			Dwell Time, sec	Cycle Time, min-sec	Total Stops
				Distance, ft	Time, sec	Distance, ft	Time, sec	Rate, ft/sec ²	Distance, ft	Time, sec			
Commuter	1 per 4 mile	55 or maximum, if less than 55	8	5,500	90	15,140	188	6.78	480	12	20	10-20	2
Arterial	2	40	8	1,035	29	1,350	22.5	6.78	255	9	7	18-00	16
CBD	7	20	14	155	10	510 (95) 887 (2)	18.5 32	6.78	90	6	7	65-20	97
Idle	-	-	-	-	-	-	-	-	-	-	-	-	-
Totals			30									93-40	115

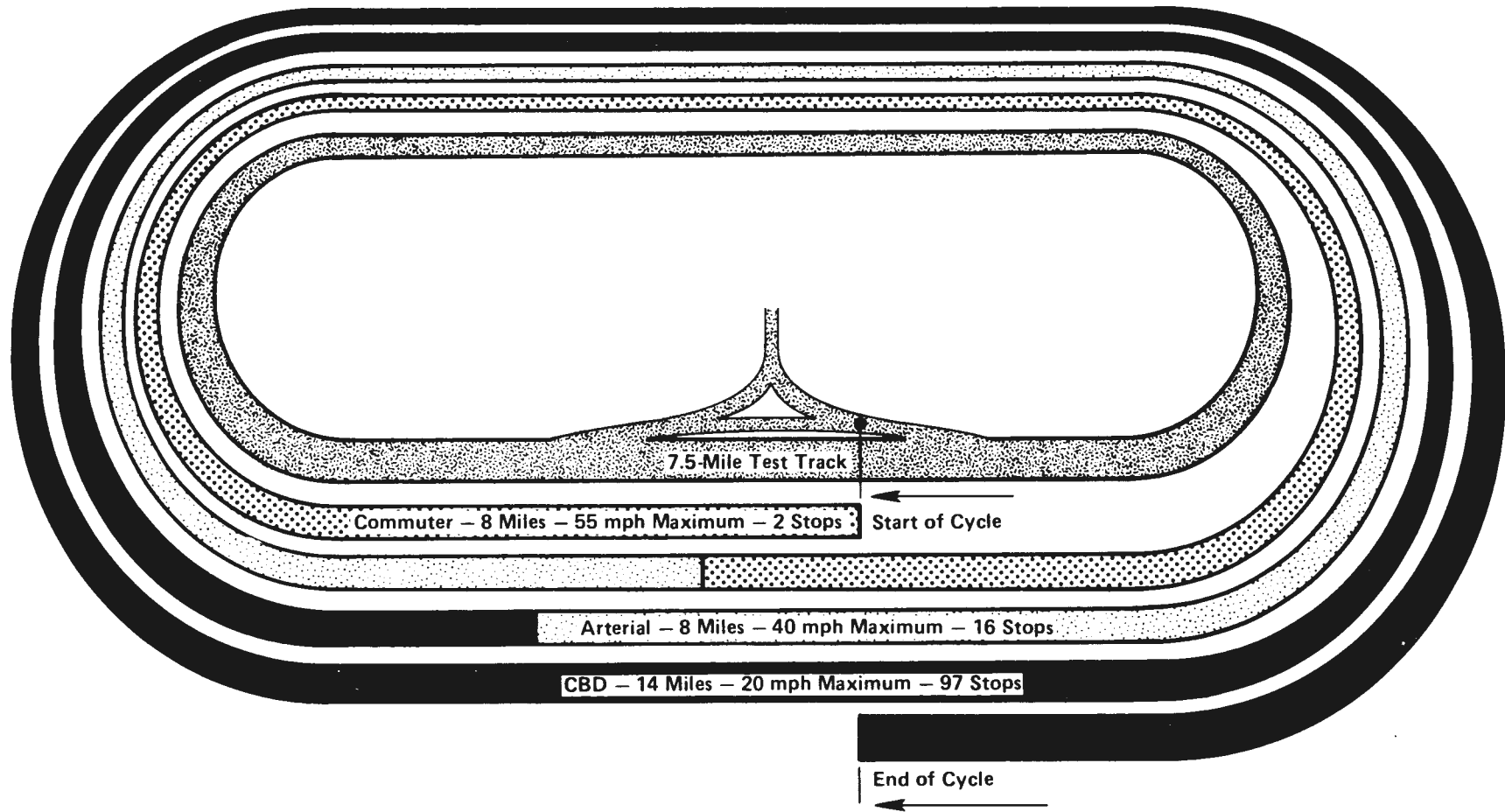

FIGURE 2.1. BUS FUEL ECONOMY TEST CYCLE

Phase	Stops/ Miles	Top Speed (mph)	Miles	Accel. Distance (ft)	Accel. Time (sec)	Cruise Distance (ft)	Cruise Time (sec)	Decel. Rate (fpsps)	Decel. Distance (ft)	Decel. Time (sec)	Dwell Time (sec)	Cycle Time (min- sec)	Total Stops
CBD	7	20	2	155	10	540	18.5	6.78	60	4.5	7	9-20	14
Idle	-	-	-	-	-	-	-	-	-	-	-	5-0	-
Arterial	2	40	2	1035	29	1350	22.5	6.78	255	9	7	4-30	4
CBD	7	20	2	155	10	510	18.5	6.78	60	4.5	7	9-20	14
Arterial	2	40	2	1035	35	1350	22.5	6.78	255	9	7	4-30	4
CBD	7	20	2	155	10	510	18.5	6.78	60	4.5	7	9-20	14
Commuter	1 stop for phase	Maximum or 55	4	55(0)	90	2 mile + 4580 ft	188	6.78	480	12	20	5-10	1
Total			14									47-10	51

Average Speed - 17.8 mph

FIGURE 2.2. TRANSIT COACH DESIGN OPERATING DUTY CYCLE

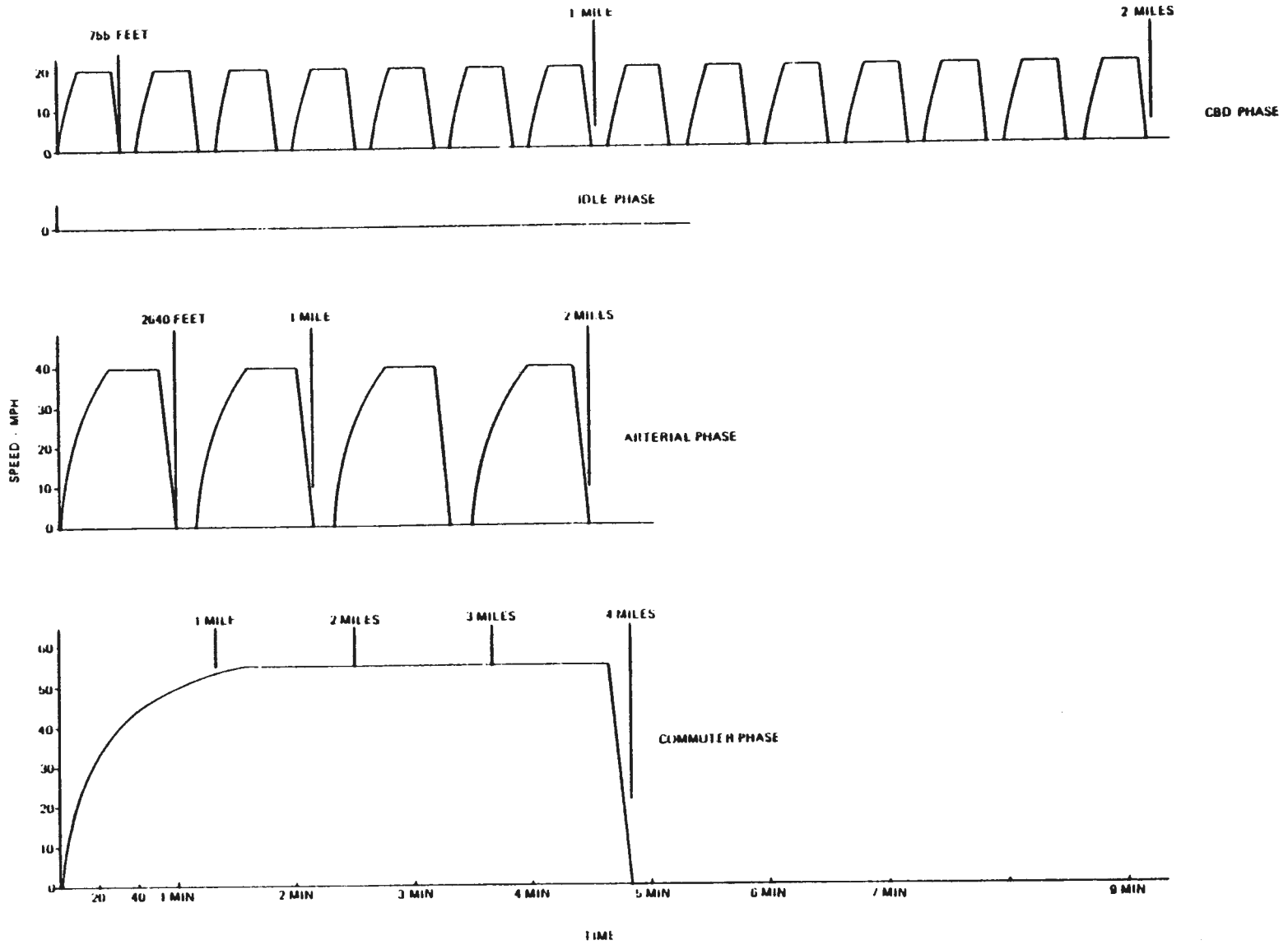

FIGURE 2.3. TRANSIT COACH DESIGN OPERATING PROFILE DUTY CYCLE

- The ADB cycle is 14 miles long and is usually doubled to 28 miles for SAE J1321 tests. This distance was increased to 30 miles in our test and the percentage of distance traveled on each phase was altered also to:

	Percentage on Phase		
	<u>Commuter</u>	<u>Arterial</u>	<u>CBD</u>
ADB Cycle	28.6	28.6	42.8
Test Program ADB Cycle	26.7	26.7	46.6

These percentages result from adding two miles to the CBD portion of the total cycle. This change allowed the test to start and end at the same point on TRC's 7.5-mile test track, and allowed enough fuel consumption during a test run to comply with SAE J1321. The increased percentage of the cycle in CBD could give a very small advantage to buses configured for best fuel economy in the CBD phase.

- The individual start-stop cycle in the ADB cycle remained unaltered except for increasing the start-stop cycle length on two of the 97 start-stop cycles of the CBD cycles by 50 percent. The change was made so that separate signs would not be required on the track for the first and the second lap of CBDs. This change reduced the probability of driver error by reducing the number of signs as shown in Figure 2.4.

Four changes were made to the Joint TMC/SAE Fuel Consumption Test Procedure - Type II - SAE J1321 OCT81: (See Appendix A for procedures as published by SAE.)

- J1321 requires the use of at least a 16-gallon fuel tank. Such a fuel tank when full would weigh about 160 pounds. It was judged that a 12-gallon tank weighing less than 120 pounds would be sufficient for this test and much easier for the driver and observer to handle. The size of the tank is shown in Figure 2.5 with the engineer carrying an empty tank from the Grumman test bus.
- J1321 mentions the use of a mechanical scale or a flowmeter system. This program used a load cell/readout combination which allowed accuracy of 0.5 percent in weight and permitted onboard weighing of the gravimetric



FIGURE 2.4. VIEW OF SIGNS AT BEGINNING AND END OF TEST CYCLE



FIGURE 2.5. GRAVIMETRIC TANK AND GRUMMAN TEST BUS

tanks at the end of each phase. This permitted the determination of a fuel economy figure for each phase as well as the overall cycle.

- J1321 recommends that the driver and observer stay with a vehicle throughout the test. This approach is helpful in quickly establishing a valid test (3 T/C ratios within 2 percent) but was found to be unnecessary in earlier tests. During this series of tests, the same drivers stayed with the buses but observers changed.
- J1321 requires run times to be within ± 0.5 percent for a valid test. During the preceding series of tests, it was noted that a number of runs which fell outside this time limit were still well within the 2 percent T/C ratio limit. It was concluded that with a cycle as complex as the one used in this program (115 start-stop sequences), the ± 0.5 percent time limit is too restrictive. The time limit was, therefore, raised to ± 1.0 percent without test accuracy compromise.

2.2.1.2 Additional Testing. During this series of tests certain data were taken which, while not necessary to the successful completion of the tests, were of use to TSC for correlation between the test series and the HEVSIM computer simulation program results. These data included tire and rim weight data, tire rolling radius data, electrical system load, and driver profile data for each test bus configuration. The driver information was obtained by using a fifth wheel and strip chart recorder on each bus configuration tested. At least two runs of each configuration were performed with the fifth wheel in use.

2.2.2 Vehicle Preparation

The buses were prepared for testing in the following manner.

2.2.2.1 Initial Service. Mechanics at TRC replaced the existing tires with Goodyear City Cruiser XT 12.5 x 22.5 G Series on the GMC control vehicle and H Series on both test buses. All fluids and lubricants were replaced with manufacturer's recommended products and all filters were replaced. The front wheels of each bus were dynamically balanced and the buses were aligned.

2.2.2.2 Documentation. The make, model, engine, drivetrain components, and other features important to fuel economy were documented. This information was cross-checked with descriptive material obtained from the manufacturers and PAT and differences were resolved.

2.2.2.3 Vehicle Preparation. All vehicles were inspected to insure that the buses tested were in safe and operating condition at the start of the test.

2.2.2.4 Daily Inspection. Each morning before testing, each bus was inspected to determine that the vehicle was properly prepared and configured for the test.

2.2.2.5 Gravimetric Tank System Installation. Gravimetric tanks were used to measure fuel consumptions. The tanks are cylindrical with a diameter of 9 inches and a length of 44 inches. These tanks were weighed by utilizing a load cell as a part of the fuel system shown in Figure 2.6. The load cell which supports the tank was secured to a bar running transversely between the hand rails attached to the ceiling and each bus as shown in Figure 2.7. Figure 2.8 shows the remainder of the test fuel system. Support instrumentation included the strain gage amplifier and digital readout unit. Solenoid valves with observer-operated switches directed fuel flow between the gravimetric and main fuel tanks. Whenever fuel flowed from a gravimetric tank, an electronic timer was activated thus assuring an accurate timing of each test. A heat exchanger was installed in a gravimetric tank return line to assure that the fuel temperature remained below 160 F as required by SAE J1321. This fuel temperature was monitored using a thermocouple as shown in Figure 2.6. The fuel-weighing system was highly repeatable and accurate. It included the following important components.

- Load cell: Lebow Model 3397-200
- Strain gage transducer indicator: Daytronics Model 3270B
- Boost pump: Holley electric fuel pump Model 12-801.

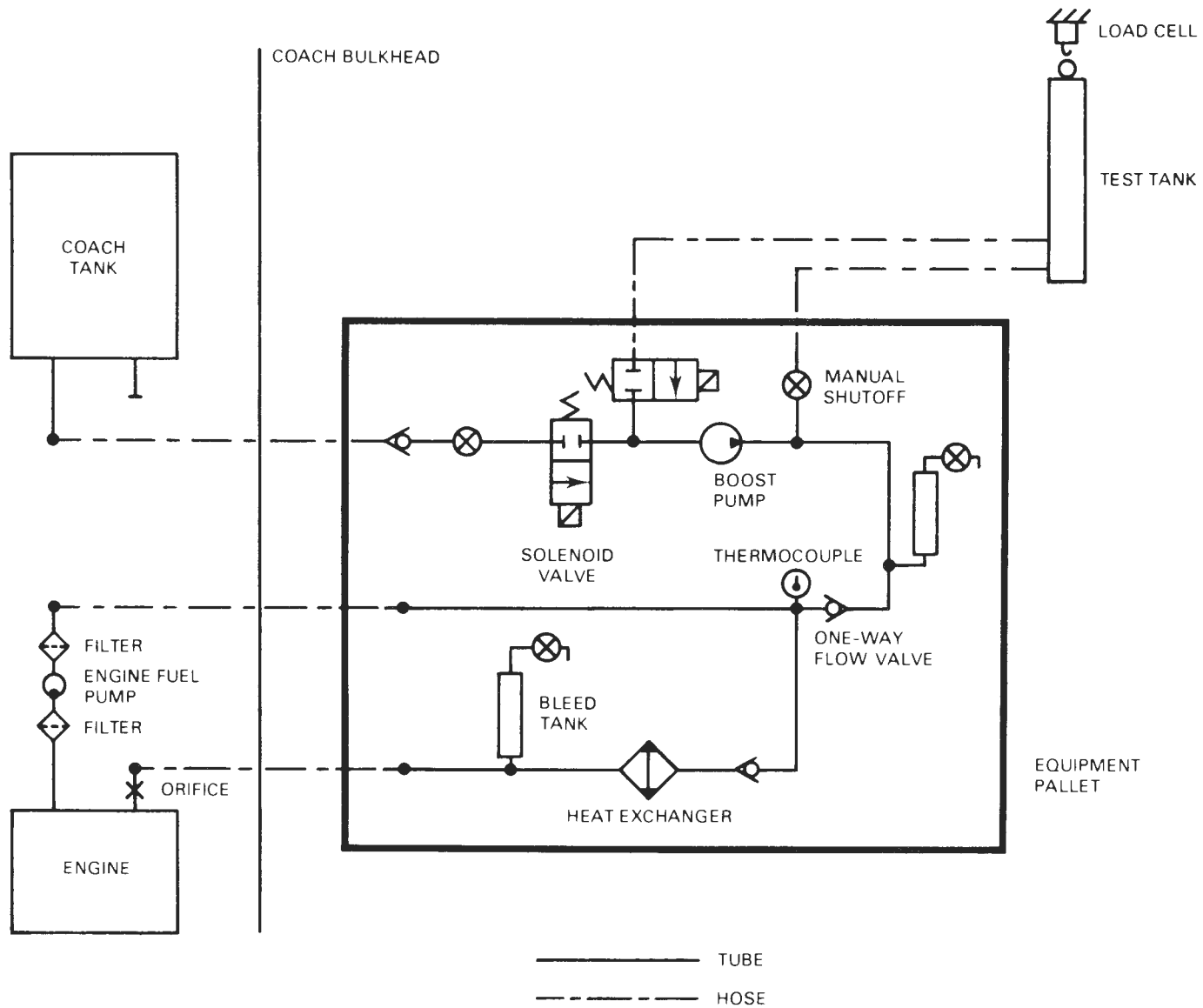

FIGURE 2.6 UMTA BUS FUEL ECONOMY TEST FUEL SYSTEM SCHEMATIC

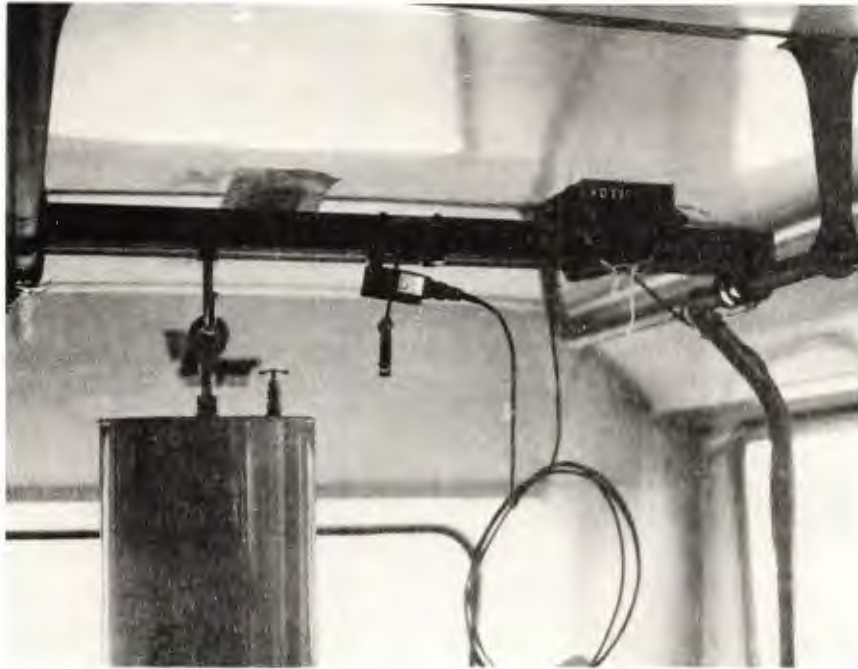

FIGURE 2.7. FUEL WEIGHING SYSTEM



FIGURE 2.8. TEST FUEL SYSTEM INSTALLED IN BUS

2.3 Maintenance

Vehicle maintenance was classified into two categories--scheduled and unscheduled. Where possible, maintenance followed the manufacturer's recommended schedule. During this series of tests, items such as tires and brakes were serviced on an as-needed basis. Tires were replaced when original tread wear reached 50 percent. Unscheduled maintenance due to unanticipated vehicle failure was provided as required. After testing started, no major unscheduled maintenance was required.

2.4 Test Procedure

All tests were performed with drivers and observers experienced in bus and truck fuel economy testing and were conducted on the first lane of concrete on the 7.5-mile test track described in Appendix B. The tests were performed on a 6:30 a.m. to 3:30 p.m. shift.

2.4.1 Fuel Economy Test Cycle

2.4.1.1 Morning Inspection. Each morning before the first test run, each bus was inspected to determine that it was properly prepared and configured for that day's testing. Some portions of the inspection were performed immediately following warm-up.

2.4.1.2 Warm-Up. Warm-up consisted of driving one hour on the bus fuel economy test cycle according to the course layout. The course layout was prepared by using green, red, and blue signs, respectively, for the commuter, arterial, and CBD portions of the test to indicate changes in speed, cycles, and stop points. The observer coached the driver through the course along with recording cycle run times, fuel temperature, and weather conditions before and after each phase of each cycle using the data sheet as shown in Figure 2.9.

2.4.1.3 Fuel Economy Testing. The course layout described above was used for all tests. The Neoplan (inline mounted engine) bus was tested with five different configurations. The Grumman (transverse mounted engine) bus was tested with six

**FIGURE 2.9. BATTELLE COLUMBUS LABORATORIES
TESTBED TRANSIT BUS FUEL ECONOMY TESTS**

Bus _____

Driver _____

Date _____

Observer _____

BUS CONFIGURATION

	Load Cell Digital Readout				Fuel Temp. (F)		Timer Reading (HR.MIN.SEC)	Start
	Zero (lbs.)		Fuel Wt. (lbs.)		Start	Finish		
	Start	Finish	Start	Finish				
Comm						—		Time
Art					—	—		Temp(F)
CBD					—			Winds
Comm						—		Time
Art					—	—		Temp(F)
CBD					—			Winds
Comm						—		Time
Art					—	—		Temp(F)
CBD					—			Winds

Transmission _____

Weight _____

Axle _____

Retarder _____

Tires _____

Engine _____

Injector _____

Converter _____

Fuel _____

A/C _____

different configurations. In nearly all of the tests the two test buses were on the track at the same time. The baseline test conditions for this series of tests were:

- (1) Air conditioning off
- (2) Evaporator fan or ventilation fan on
- (3) Seated load weight
- (4) Diesel No. 2 Supreme Fuel
- (5) Exterior and interior lights on.

Before starting each test, the gravimetric tank was filled, weighed, and documented. The cycle was started adjacent to the entrance of the high-speed pit lane. The cycle is described in Figure 2.1 and Table 2.1. As shown, the cycle has been grouped according to the phase; commuter, arterial, and CBD. Fuel was weighed at the end of each phase without refueling the gravimetric tank. The solenoid valve in the fuel system switched the fuel supply in the gravimetric tank to the main fuel tank at the end of the phase. The gravimetric tank was weighed and fuel flow was switched back to the gravimetric tank before continuing with the next phase.

As described in SAE J1321 (see Appendix A), three cycles were run that fell within a 2 percent window of T/C ratios for a valid test. Test run times were within ± 1.0 percent. The test cycle was then repeated to obtain three more valid T/C ratios falling within 2 percent of each other. The average of these two groupings of T/C ratios fell within 2 percent to show test repeatability.

2.4.2 Fuel Analysis

Standard Oil of Ohio's No. 2 Diesel Supreme was placed in a separate tank at the TRC fuel plaza for control and test buses during these tests. During the course of testing, this tank was refilled once. Results of the fuel analyses are shown in Appendix C.

2.4.3 Weather Conditions

During this series of fuel economy tests, temperatures ranged from 58 to 94 F, maximum wind was 20 MPH gusting to 25 MPH, and the pavement was dry. Precipitation did not occur to the extent that the drivers required the use of windshield wipers for safe operation of the vehicles.

3.0 RESULTS AND CONCLUSIONS

This section presents the quantitative results of this series of tests along with conclusions reached during this test series and the previous tests on 40-foot transit buses' fuel economy.

3.1 Results

Figures 3.1 and 3.2 show the two test vehicles used during this test series. Figure 3.1 shows the bus supplied by Grumman Flexible Corporation with the transverse mounted engine (transverse test bus). Figure 3.2 shows the bus supplied by Neoplan USA with the inline mounted engine (inline test bus). The baseline descriptions of the test buses are presented in Tables 3.1 and 3.2 for the transverse and inline test buses, respectively. Baseline fuel consumption was determined in Tests T-1 and I-2. In other tests a load weight or a component was changed, and the vehicle's fuel consumption in this new configuration was determined. Finally, the vehicles were restored to T-1 and I-1 test configurations and retested to make sure that some undiscovered factor had not altered the vehicles' fuel consumption during the course of testing. Table 3.3 shows the changes which were made during testing. Table 3.4 and Figures 3.3 and 3.4 present the results of the tests as a percent change in fuel economy from the baseline configuration. Figures 3.3 and 3.4 reflect the fact that SAE J1321 permits determination of fuel economy to an accuracy of ± 1 percent. Thus when reading Figure 3.3 for 1.5 x SLW one should realize that even though the tests showed a decrease in fuel economy of 7 percent, the actual change in fuel economy could range from -6 percent to -8 percent, i.e., anywhere in the light gray band of the bar chart. It must be realized that these percent changes are not additive; one cannot add two 5-percent fuel economy improvements due to component changes and conclude that if both components were changed that the fuel economy improvement would be 10 percent.



FIGURE 3.1. FLXIBLE TEST BUS

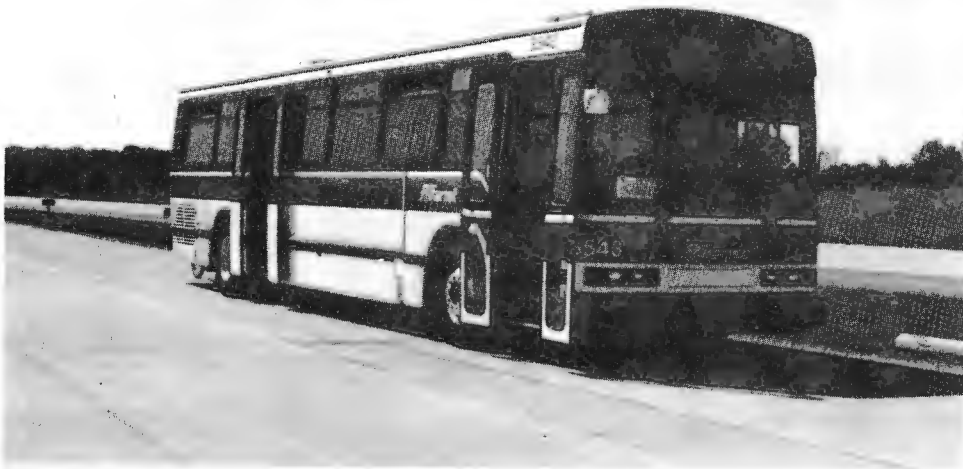

FIGURE 3.2. NEOPLAN TEST BUS

TABLE 3.1. SPECIFICATIONS OF FLXIBLE TEST BUS

Bus Manufacturer: Grumman Flxible Corp.
Model Number: 870
Date of Manufacture: August 1982
Vehicle Identification Number: 1GF4AA5K1CD094968

Length, ft: 40
Width, in.: 102
Height, in.: 118.9
Wheelbase, in.: 299
Passenger seats, no.: 48
Wheelchair lift: No
Engine: 6V92TA
Fuel injectors: 7G75
Transmission: V730 D
Torque converter: 490
Axle ratio: 4.556
Tires: Goodyear City Cruiser XT 12.5x22.5 "H" Series
Fuel Tank Capacity, US gallons: 135
Air-conditioning system: Yes
Power steering pump: Vickers ATM-42
Empty Weight (as run with test equipment, driver, and observer):
 Front axle: 7940
 Rear axle: 18240
 Total: 26180
Seated load weight:
 Front axle: 10970
 Rear axle: 21970
 Total: 32940
1.5 x Seated Load Weight:
 Front axle: 12820
 Rear axle: 24050
 Total: 36870

TABLE 3.2. SPECIFICATIONS OF NEOPLAN TEST BUS

Bus Manufacturer: Neoplan USA
Model Number: AN-440-A
Date of Manufacture: 1983
Vehicle Identification Number: 1N9TAS2AXDL013310

Length, ft: 40
Width, in.: 102
Height, in.: 129.5
Wheelbase, in.: 272
Passenger seats, no.: 42
Wheelchair lift: No
Engine: 6V92TA
Fuel injectors: 7G75
Transmission: HT747
Torque converter: 495
Retarder: Telma Focal 155 (Installed for tests I-1 and I-6)
Axle ratio: 4.889
Tires: Goodyear City Cruiser XT 12.5x22.5 "H" Series
Fuel Tank Capacity, US gallons: 125
Air-conditioning system: Yes
Power steering pump: Vickers
Empty weight (as run without retarder and with test equipment, driver, and observer):
 Front axle: 8990
 Rear axle: 18840
 Total: 27830
Seated load weight: (without retarder)
 Front axle: 11650
 Rear axle: 22480
 Total: 34130
1.5 x Seated Load Weight:
 Front axle: 12900
 Rear axle: 24780
 Total: 37680

TABLE 3.3. TEST BED BUS CONFIGURATIONS

Test No.	Engine	Injector	Transmission	Torque Converter		Axle Ratio		Fuel	A/C	Height		Route Operating Cycle	Retarders	Others				
				490	495	5.375	4.556			4.889	SLW			Empty	20 seated	1.5 x SLW	ADB	Tire #1
	6V92 TA	7675	V 730 V 731UEC#1* V 731UEC#2* HT 747	490	495	5.375	4.556	4.889	#2	Off	SLW	Empty	20 seated	1.5 x SLW	ADB	• Commuter • Arterial • CBD	Telma, Focal 155	Tire #1 Tire #2
T-1**	●	●	●	●	●	●	●	●	●	●	●	●	●	●	●	●	●	●
T-2	●	●	●	●	●	●	●	●	●	●	●	●	●	●	●	●	●	●
T-3	●	●	●	●	●	●	●	●	●	●	●	●	●	●	●	●	●	●
T-4	●	●	●	●	●	●	●	●	●	●	●	●	●	●	●	●	●	●
T-5	●	●	●	●	●	●	●	●	●	●	●	●	●	●	●	●	●	●
T-6	●	●	●	●	●	●	●	●	●	●	●	●	●	●	●	●	●	●
T-7	●	●	●	●	●	●	●	●	●	●	●	●	●	●	●	●	●	●
I-1***	●	●	●	●	●	●	●	●	●	●	●	●	●	●	●	●	●	●
I-2	●	●	●	●	●	●	●	●	●	●	●	●	●	●	●	●	●	●
I-3	●	●	●	●	●	●	●	●	●	●	●	●	●	●	●	●	●	●
I-4	●	●	●	●	●	●	●	●	●	●	●	●	●	●	●	●	●	●
I-5	●	●	●	●	●	●	●	●	●	●	●	●	●	●	●	●	●	●
I-6	●	●	●	●	●	●	●	●	●	●	●	●	●	●	●	●	●	●

* These transmissions are currently designated V 731ATEC (Allison Transmission Electronic Control).
 ** Bus with transverse mounted engine.
 *** Bus with in-line mounted engine.

TABLE 3.4. FUEL ECONOMY TEST RESULTS

Test Number	Configuration Change	Commuter	Arterial	CBD	Combined*
I-1	With Retarder	0	0	0	0
I-2	Baseline**	0	0	0	0
I-3	1.5xSLW	-2	-6	-1	-2
I-4	Empty	8	9	12	10
I-5	Radial Tires	10	8	9	9
I-6	Retest With Retarder	0	-4	0	-1
T-1	Baseline	0	0	0	0
T-2	1.5xSLW	-6	-7	-7	-7
T-3	Empty	7	11	13	11
T-4	5.375 Axle Ratio	-14	6	-2	-2
T-5	UEC Transmission (Optional PROM)	0	2	-5	-2
T-6	UEC Transmission (Fuel Economy PROM)	1	11	-2	2
T-7	Retest Baseline	1	0	-3	-1

* Percent change in fuel economy; plus numbers are increases in fuel economy from the baseline configuration and minus numbers are decreases. The baseline test for each bus was run with:

- (1) Seated load weight (SLW)
- (2) Air conditioning off
- (3) Evaporator fan or ventilation fan on
- (4) Diesel No. 2 Supreme fuel
- (5) Exterior and interior lights on.

** The baseline test was run without the retarder installed.

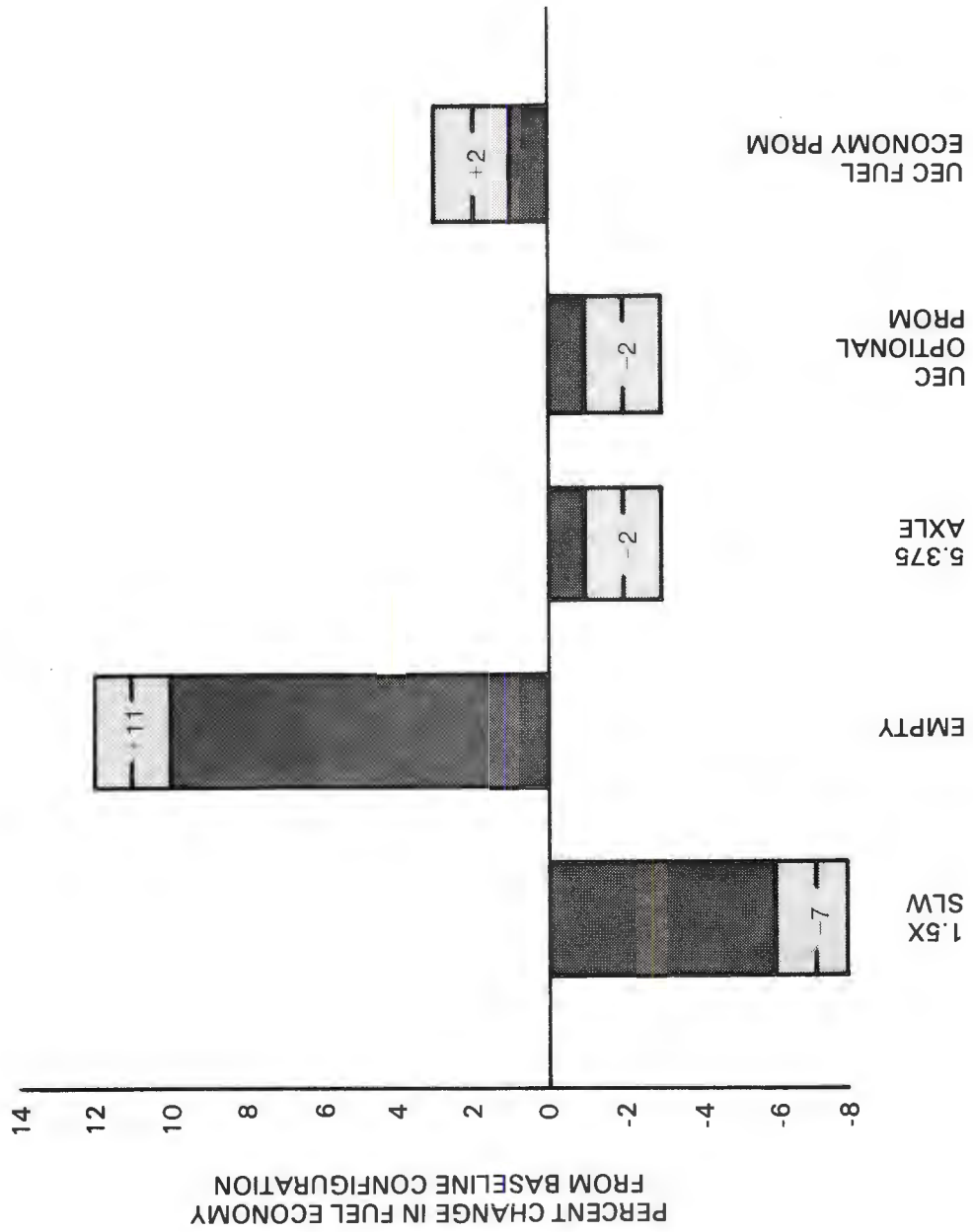

FIGURE 3.3 RESULTS OF TRANSVERSE BUS TESTS

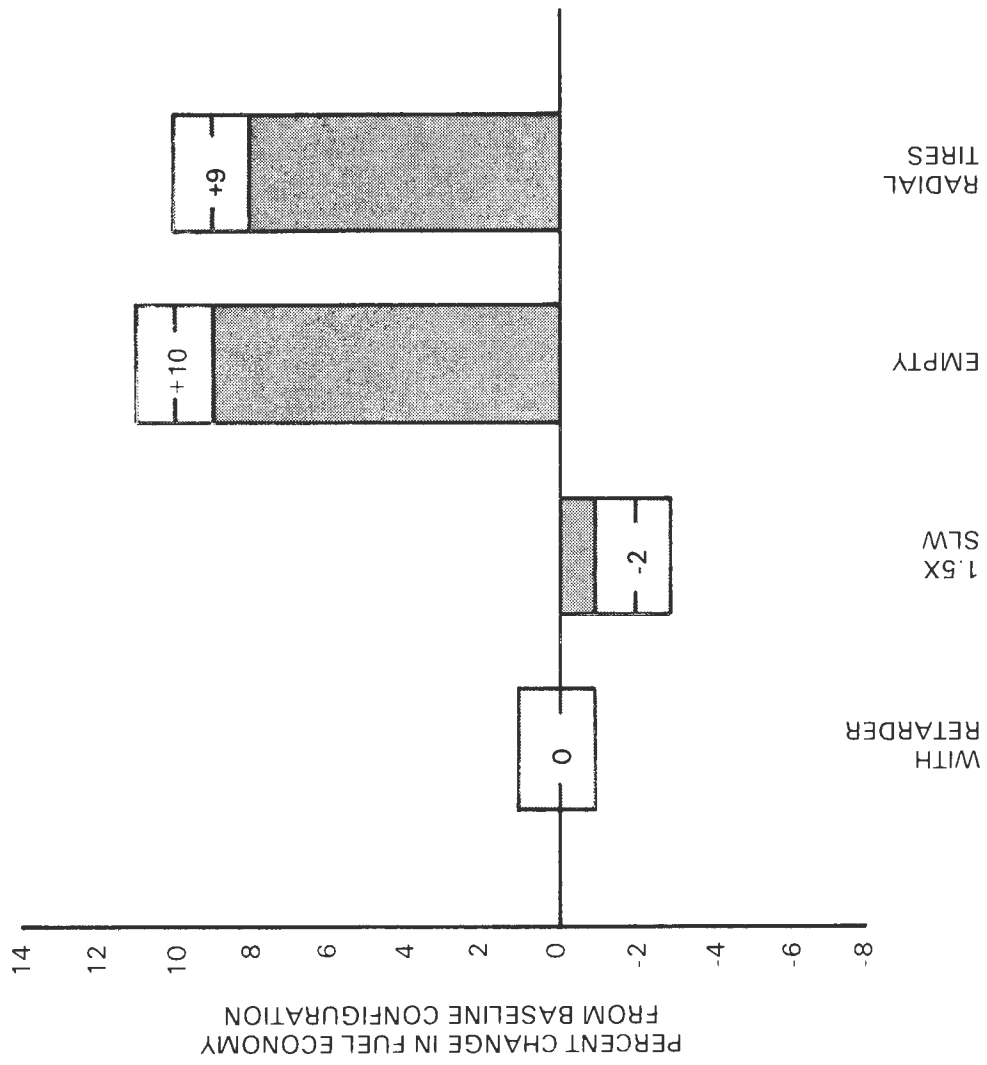

FIGURE 3.4 RESULTS OF INLINE BUS TESTS

Briefly stated, the results of this series of tests are:

- (1) For the inline bus:
 - (A) The absence or presence of the Telma retarder has no measurable effect on fuel economy.
 - (B) Loading the bus to 1.5 times seated load weight from seated load weight decreased its fuel economy by 2 percent.
 - (C) Unloading the bus from seated load weight to empty increased the vehicle's fuel economy by 10 percent.
 - (D) Radial tires improved the fuel economy by 9 percent when compared with bias ply tires, both at seated load weight.
 - (E) When retested in its baseline configuration, the vehicle's fuel economy had changed by 1 percent. Since the test results presented, based on J1321, are accurate to within ± 1 percent, we conclude that the bus baseline fuel economy did not change during the test and thus all of the results are valid.
- (2) For the transverse bus:
 - (A) Loading the bus to 1.5 seated load weight from seated load weight decreased its fuel economy by 7 percent.
 - (B) Unloading the bus from seated load weight to empty improved its fuel economy by 11 percent.
 - (C) Changing from the 4.556 axle ratio to a 5.375 axle ratio decreased the overall fuel economy by 2 percent. However, in the commuter phase there was a 14 percent measured decrease in fuel economy.
 - (D) Changing from the standard shift sequence hydromechanical transmission to the electronic transmission (UEC), with the PROM installed which duplicated the hydraulic optional shift sequence, reduced fuel economy by 2 percent.
 - (E) Changing to the fuel economy PROM with reduced modulation shift increased fuel economy by 2 percent from baseline and by 4 percent from operation with the hydraulic optional shift sequence PROM.
 - (F) When retested in its baseline configuration, the fuel economy of the bus had not significantly changed. Thus, all of the results are valid.

3.2 Conclusions

The objective of this program was to determine the fuel economy impact of changes in vehicle weight or selected componentry of two 40-foot transit buses. This objective has been satisfied.

The data demonstrates that these tests are accurate to the level expected for the fuel consumption test procedure, SAE J1321. The results were also repeatable, within ± 1 percent. The overall success rate of testing (number of valid runs/total number of runs) was 84 percent.

An analysis was done of the requirement for 6 runs to complete the test for a particular configuration. In this program, 13 configurations were tested. Eleven of the 13 combined T/C ratios would have been the same if 3 runs had been considered a complete valid test. In the other two tests, the requirement of 6 valid runs changed the results by 1 percent.

This series of tests, and the previous series of tests on six 40-foot transit buses, were run with temperatures ranging from 23 F to 94 F. This shows that SAE J1321 can be used successfully over a wide range of temperatures when the control and test vehicles are equipped with the same basic engine.

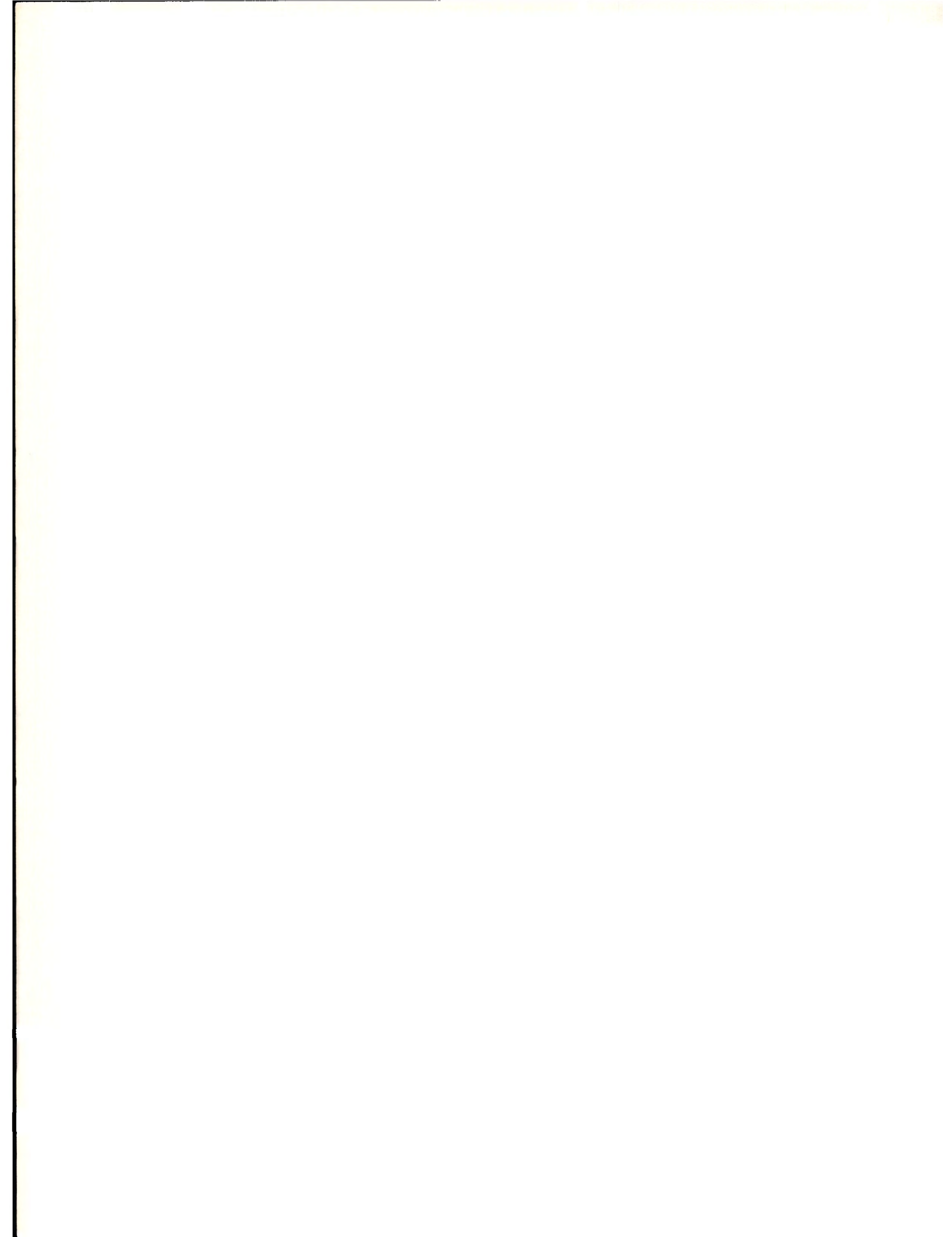

APPENDIX A

JOINT TMC/SAE FUEL CONSUMPTION TEST PROCEDURE -
TYPE II - SAE J1321 OCT 81

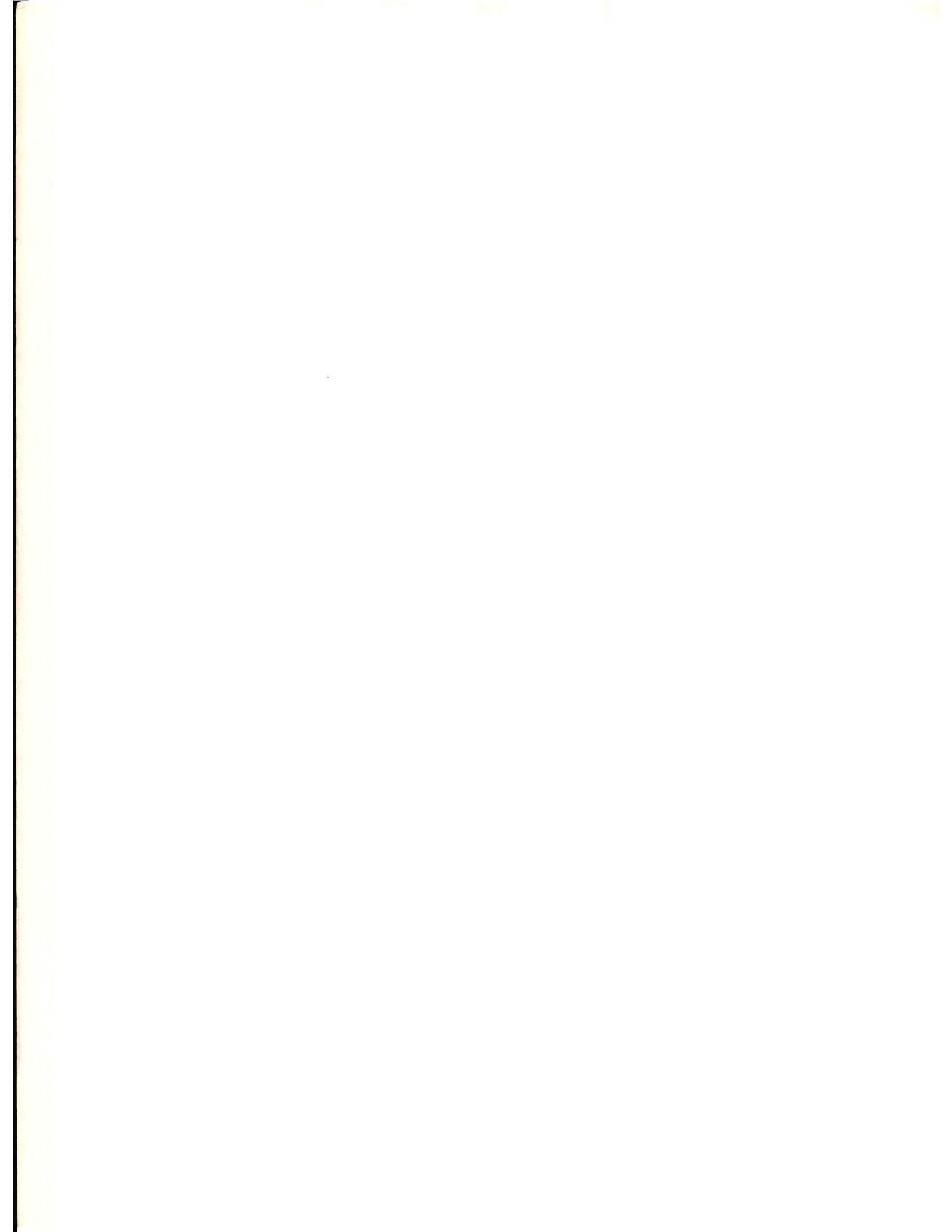

**Joint TMC/SAE Fuel Consumption
Test Procedure — Type II
— SAE J1321 OCT81**

SAE Recommended Practice
Approved October 1981

THIS IS A PREPRINT WHICH IS
SUBJECT TO REVISIONS AND
CORRECTIONS. THE FINAL
VERSION WILL APPEAR IN THE
1983 EDITION OF THE SAE
HANDBOOK.

SAE *The Engineering
Resource For
Advancing Mobility*

PREPRINT

JOINT TMC/SAE FUEL CONSUMPTION TEST PROCEDURE—TYPE II—SAE J1321 OCT81

SAE Recommended Practice

Report of the SAE/DOT Advisory Committee, approved October 1981.

1. Scope—This recommended practice provides a standardized test procedure for comparing the in-service fuel consumption of two conditions of a test vehicle or of one test vehicle to another when it is not possible to run the two or more test vehicles simultaneously. An unchanging control vehicle is run in tandem with the test vehicle(s) to provide reference fuel consumption data. This procedure is especially suitable for testing components which require substantial time for removal and replacement or modification, such as engines, transmissions, tag-axles, and cab sheet metal. This procedure may also be used for comparison of entire vehicles and for easy-to-change components (those referenced in the Type I test described in SAE Recommended Practice, SAE J1264). The test may utilize fleet vehicles operating over representative routes.

The result of a test using this procedure is the percent difference in fuel consumption between two test vehicles or the difference in fuel consumption of one vehicle in two different test conditions.

The fuel measurement method is a key factor in determining the overall accuracy achievable with this procedure. If the weighing method is used, overall test accuracy is best and, based on test experience, will be within $\pm 1\%$ (for example, 6% measured improvement can be from 5–7% actual improvement). (See Section 6, Test Accuracy.)

The following four basic rules must be applied to this procedure to insure test result validity:

(a) The test routes and cargo weight should be representative of actual operation.

(b) *A single test is inconclusive regardless of the results. A single test should be taken as an indicator. Test results must be repeatable to have validity.*

(c) The more variables controlled, the more conclusive the results.

(d) All test procedures or methods are accurate within prescribed limits. If the component or system being tested by a given procedure shows a degree of improvement which is equal to or less than the accuracy limit of the procedure, an additional number of tests should be conducted to determine its true value. If a number of such tests do not show consistent results, then one must conclude that the changes caused by the component or vehicle system are less than can be measured by the test procedure.

2. Identification—Sufficient information is to be recorded to identify the vehicles under test and the route over which the test is conducted. Minimum information required is shown on the Type II Test Data Form #1 (Vehicle Identification).

3. Definitions

3.1 Vehicles "C" and "T"—The vehicles being used for test purposes are identified "C" and "T." This identification applies to the vehicles and associated equipment, including the trailer, in the case of tractor/trailer combinations. Vehicle "C" is the control and is not modified in any way during the entire test. Control vehicle fuel consumption is used only to generate control data. It is necessary that Vehicle "C" be dedicated to the test and not used for other purposes until the entire series of tests is completed. The singular purpose of Vehicle "C" is to monitor the test route, ambient conditions, and test procedures for each test run. Vehicle "T" is the test vehicle used to evaluate components. The procedure also has the capability to test two test vehicles, comparing one to the other. (See paragraphs 5.12 and 5.13 for explanation of the two-vehicle test.)

3.2 Test Run—A test run is a complete circuit of the test route. A test run always starts and ends at a common point. This may be accomplished by using either a closed loop of highways or a single highway with one-half of the test run outbound, a turnaround point, and one-half of the test inbound, or a test track. Each vehicle test run generates one data point. To be usable, a test run must meet the constraints of paragraph 5.9.

3.3 Data Point—A data point is the quantity of fuel consumed by a vehicle on a test run.

3.4 T/C Ratio—A T/C ratio is the ratio of the quantity of fuel consumed (data point) by the test vehicle to the quantity of fuel consumed (data point) by the control vehicle during one test run.

3.5 Baseline Segment—A baseline segment is composed of a minimum of three valid T/C ratios. A baseline segment establishes baseline fuel consumption of the test vehicle or the first of two vehicles to be tested. (See

paragraphs 5.10, 5.11, 5.12, and Appendix I, Sample Calculations, for further explanation.)

3.6 Test Segment—A test segment is also composed of a minimum of three valid T/C ratios. A test segment establishes the fuel consumption of the test vehicle after modification or the fuel consumption of the second of two vehicles tested. A valid test segment must be compared to a valid baseline segment. (See paragraphs 5.10, 5.11, 5.12, and Appendix I, Sample Calculations, for further explanation.)

3.7 Complete Test—A complete test is composed of a baseline segment and a test segment.

4. Test Preparations

4.1 Test Route Selection

4.1.1 For Long-Haul Operations—A test route representative of actual operation of not less than 40 miles (64.4 km) should be selected for conducting the test. The route selected must allow high probability of an uninterrupted test. (Record on Test Data Form #1.)

4.1.2 For Other Operations (Pick-up and Delivery (P&D), Construction, Transit Buses, etc.)—A representative test route must be selected which will provide sufficient distance and time to consume a minimum of 30% of the test tank capacity or a minimum of 6 gal (22.7 L) of fuel, whichever is greater. The route selected must allow high probability of an uninterrupted test. (Record on Test Data Form #1.)

4.2 Vehicle Test Speeds—The test speeds selected should be representative of average operation as determined by the operator conducting the test and be within the capability of the test vehicles. Vehicles are to be operated according to vehicle, engine, and transmission manufacturers' recommendations (engine speeds and shift points). If the test vehicles can be operated in more than one transmission or differential ratio over any part of the test route at the speed selected, a pre-determined driving procedure must be specified. At no time during the test cycle should one vehicle control the speed or performance of the other vehicle; however, they should be run at basically the same time in order to experience the same ambient operating conditions. (See paragraph 5.4.)

4.3 Vehicle Type and Configuration—Vehicles "C" and "T" are not required to be of the same general configuration. However, it may require more test runs to obtain three valid T/C ratios when extreme differences in configuration exist between control and test vehicles. All vehicles must be in proper operating condition as determined by the operator conducting the test. (See paragraph 7.7.) Vehicle "C" need not have the same engine, driveline, axle ratio, or tire size as the test vehicle. (Record on Test Data Form #1.)

4.4 Cargo Weights—The cargo weights selected for the test should be representative of the fleet operations and be within the capability of the vehicles under test. Equal gross weights for Vehicles "C" and "T" are not necessary but are desirable. If two test vehicles are being compared, the cargo weights must be the same. Cargo weight must not change during a test unless a change in weight is a factor being tested. (Record measured weights of control and test vehicles on Test Data Form #1.)

4.5 Driver Selections—Drivers selected should be sufficiently skilled so that test results are not affected by the driver's technique improvement during the test period. Drivers should also have a strong motivation for unbiased results and excellence of test procedure conduct.

4.6 Observers—Observers should be assigned to each vehicle. The observer records the data outlined in paragraph 5.5. Complex driving cycles require observers; simple driving cycles may not require observers.

4.7 Fuel Measuring

4.7.1 Portable Weigh Tank Method—This method of fuel consumption measurement requires that a portable tank of at least 16 gal (60.6 L) capacity be installed on each vehicle. The portable tank¹ must have provisions for both supply and return of fuel. The fuel line connections to the portable tank must be fitted with quick-disconnect fittings to allow for removal without spillage. The portable tank weigh method requires a good quality scale², accurately calibrated in increments of 0.1 lb (45 g) or 1 oz (28.4 g). (Use Test Data Form #2 for recording data.) When

¹ It is strongly recommended that the portable tanks selected have a high degree of mechanical integrity. Temporary installation of an automobile fuel tank is not recommended.

² A good scale for this purpose is Accu-weight Model 200 or equivalent.

NOTE: TMC—The Maintenance Council of the American Trucking Association, Inc.

reading a scale with graduations marked at each ounce, it is a simple matter to interpolate to 1/4 oz. A deadweight of approximately 100 lb (45.4 kg) is required to check scale repeatability immediately preceding each series of fuel tank weighings. (See paragraph 7.4.)

4.7.2 Flow Meter Method—If vehicles are fitted with on-board flow meters, these meters must be capable of temperature density compensation and must be calibrated to a minimum accuracy of $\pm 1\%$ at a flow rate consistent with the vehicle being tested. (Use Form #2 for recording data.) (See paragraph 6.2 for test accuracy with fuel meter.)

4.7.3 Fuel Temperatures—The fuel temperature in the portable weighing tanks should be kept below 160°F (71°C). Fuel coolers can be used to maintain the temperature below that value but positioning the portable weigh tank in an area of good air flow is an easier solution.

4.8 Baseline Segment—Vehicles "C" and "T" must make sufficient test runs to complete a baseline segment. (See Appendix I, Sample Calculations.) After the baseline has been established, modification is made to Vehicle "T". No change is made to Vehicle "C" for the duration of the test. Vehicle "C" must remain the same vehicle, without change, and used for test purposes only, even if modification to Vehicle "T" requires several weeks. If trailers are used, the trailers and loads must be used for test purposes only, or be set aside, unchanged, until the test is completed.

4.9 Test Segment—Vehicle "C" and modified or new Vehicle "T" must make sufficient test runs to complete a segment. (See Appendix I, Sample Calculations.)

5. Test Procedure

5.1 Vehicles "C" and "T" must follow the same start and warm-up procedures. Warm-up speeds should be at or near test speeds. The time of warm-up must not be less than 1 h. Longer warm-up periods may be required at colder temperatures. Warm-up and driver familiarization with the test route can be accomplished at the same time. This test procedure is structured to measure fuel consumption differences of warmed-up vehicles.

5.2 Record weather, road conditions, traffic conditions, wind velocity, wind direction, temperature, humidity, and barometric pressure for each test run. (Record on Test Data Form #2.) These data are not used in calculation but are useful in evaluation of test results.

5.2.1 Wind velocity may be checked with an inexpensive marine type³ hand held wind indicator.

5.2.2 Weather data may be obtained from a local airport or other weather bureau service.

5.3 Vehicles "C" and "T" are moved to the marked starting point and parked with engines stopped. Portable fuel tanks are topped off, weighed, and the weight recorded. Fuel measuring equipment, if used, and odometers are read and the data recorded. (Use Test Data Form #2.) Vehicles must be fueled from the same dispenser during the entire test to insure consistent fuel grade and quality.

5.4 The driver of Vehicle "T" should start the engine and leave the starting area on a predetermined test route. (Engine start time is recorded on Test Data Form #2-2.) After approximately 5 min, the driver of Vehicle "C" should start the engine and leave on the test route. (Engine start time is recorded on Test Data Form #2-1.) The interval spacing is to insure that one vehicle will not impose an artificial performance limit on the following vehicle and will also allow fueling between runs without disproportionate cooling. Care should be taken to insure that cool-down periods are identical for both vehicles and for all test runs. Cool-down periods at start of test and between runs should not be more than 5 min.

5.5 Observers, if used, should make and record a minimum of ten elapsed time recordings on each run using the Observer's Worksheet. These calculations are made using stopwatches and mile (km) posts. If mile (km) posts do not exist on the test route, measured miles (km) must be laid out prior to conducting the test. Using a stopwatch, observers also record the time the vehicle is stopped at any point on the test route other than at the start and finish point. The time stopped on the course should occur only at stop signs. The vehicle stopped time is subtracted from the total time to obtain running time for each run. (See Form #4, the Observer's Worksheet.)

5.6 If, due to conditions or vehicle specifications, a pre-determined driving cycle is specified for the test, the observer is to coach the driver, making sure that the vehicle is operated as described in the pre-determined

driving cycle.

5.7 At the end of each test run, each vehicle must stop at the start (fueling) point. Immediately after full stop, engines are idled for 1 min and then shut down. (Time is recorded using Forms #2-1 and #2-2.) Fuel measurement equipment and odometers are read and recorded. (Use Forms #2-1 and #2-2.)

5.8 The driver of Vehicle "C" should drive that vehicle for the complete test. The driver of Vehicle "T" should drive that vehicle for the complete test. After refueling occurs, repeat paragraph 5.3. (Record weather, road, traffic conditions, wind velocity, and wind direction on Forms #2-3 and #2-4.) Observers should also remain with their respective vehicles throughout the complete test since their instructions may influence driver performance.

5.9 At the conclusion of each test run, all data are recorded and the next test run is started by repeating paragraphs 5.3 through 5.6. Time to complete a test run must be repeated within $\pm 0.5\%$. For a run which requires 1 h to complete, repeatability must be ± 18 s. Fuel consumption data should not be used from runs which failed to repeat time within $\pm 0.5\%$ of other runs in the same segment for the same vehicle. With a 40–50 mile (64.4–80.5 km) long haul course, the use of runs that do not repeat within $\pm 0.5\%$, excluding time stopped on the test route, will affect the accuracy of the results. The operational events of these runs must be identical. The only allowed variable is time stopped at scheduled stops. More complex test schedules may be less tolerant of variations in stop time.

5.10 A test consists of two segments, a baseline segment and a test segment. Each segment is made up of a minimum of three valid T/C ratios (Test Vehicle Fuel Used/Control Vehicle Fuel Used.) Valid T/C ratios must fit within a 2% band. (See Appendix I, Sample Calculations.) The 2% band means that the lowest T/C ratio cannot be more than 2% below the highest.

5.11 If only one test vehicle is used, a baseline segment is run. The vehicle is then modified and a test segment is run as outlined in paragraphs 4.1 through 4.9 and 5.1 through 5.9. The comparison of the baseline and test segments for the test vehicle gives the test results. (See Appendix I, Sample Calculations.)

5.12 If two complete vehicles are to be compared, the Control Vehicle (C) and Test Vehicle One (T₁) are used in the baseline segment. The Control Vehicle (C) and Test Vehicle Two (T₂) are used in the test segment. Both segments are run as outlined in paragraphs 4.1 through 4.9 and 5.1 through 5.9. The comparison of the baseline and test segments of the test vehicle(s) gives the test results. More than one test vehicle can be run simultaneously in which case the divisor of the ratio is always the Control Vehicle (C). (T₁/C, T₂/C, T₃/C, etc.) (See Appendix I, Sample Calculations.)

5.13 This test procedure is for use when testing a modification to a test vehicle or when comparing two vehicles employing a switch of the complete test vehicle between baseline segment and test segment. For example, when comparing one test tractor to another, the driver and trailer of the baseline segment vehicle are the driver and trailer of the test segment vehicle. The test segment is then comparable to the baseline segment. More than one test can be conducted and several test vehicles can be operated at the same time. When more than one test vehicle is run at the same time, the control vehicle should be run between the test vehicles and as near the middle as possible. A single test is inconclusive regardless of the results. A single test should be taken as an indicator. Test results must be repeatable to have validity.

6. Test Accuracy

6.1 Properly conducted tests using portable tank weigh methods are considered, based on test experience with long-haul test routes, to have an overall accuracy within $\pm 1\%$ (for example, 6% measured difference can be from 5–7% actual difference.)

6.2 The use of on-board meters has not been successfully demonstrated during the validation of this procedure.

7. Cautionary Notes

7.1 Test Route—It has been determined during validation of the procedure that the optimum long haul test route is one that starts and stops at a common point, has a fueling point with easy access to the test route, and has no traffic control lights. The turnaround should be either the cloverleaf type or an off ramp with a stop sign, an overhead (or underneath) cross-over, and an on ramp. A turnaround point with traffic control lights must be avoided. A test route that has had mile (km) markers installed is recommended. For other test routes (P&D, construction, transit buses, etc.) experience has shown that this procedure is acceptable. However, care must

³Edmund Scientific Co., Barrington, NJ, or Dwyer Instrument, Inc., Michigan City, IN, or equivalent.

be taken in establishing routes and their inherent driving cycles to insure they are representative of the operating parameters of the equipment under test.

7.1.1 For transit buses, the Transit Coach Operating Profile Duty Cycle⁴ may be used.

7.2 Trailers and Weight Dedication—If trailers are used, the trailers matched to Vehicles "C" and "T" should stay with their respective tractors throughout the entire test. If this cannot be done with the operator's revenue equipment, consideration should be given to renting trailers for the duration of the series of test segments. Under no circumstances should the trailers be exchanged between Vehicles "C" and "T". The use of revenue cargo for test weight should be avoided to prevent delay of freight or loss of costly test data due to an unavoidable extension of the test period and/or cargo delivery commitments.

7.3 Vehicles "C" and "T" should be operated at test speeds for not less than 1 h, for warmup before test cycles are run, to insure that the vehicles approach temperature stabilization in all components. Invalid test runs may result if higher fuel consumption is caused by temperature-induced frictional resistance in one, but not all, of the vehicles used to conduct the test. If fuel consumption during warm-up is being tested, Vehicles "C" and "T" should not be operated for a minimum of 12 h prior to starting each test run.

7.4 Portable tanks must be weighed on the same portable scales. (See paragraph 4.7.1.) The outside of the portable fuel tanks should be wiped clean of dirt and fuel each time they are weighed. The scale site should be protected from winds. Scales must be checked with a known deadweight of approximately 100 lb (45.4 kg) before each series of readings. The portable scales should not be moved between the initial and final weighing of a given test run unless particular attention is paid to checking the scale's repeatability in a second location. (See paragraph 4.7.1, etc.)

7.5 It is strongly recommended that all drivers and observers of Vehicles "C" and "T" be required to drive and ride over the test route at least once before testing. Familiarity with grades, required shifting, braking, speed maintenance, etc., will lead to greater accuracy and repeatability.

7.6 To minimize test variability when driving the warm-up run or first test run, it is recommended that each driver mentally note the precise location on the test route where he applies the brakes and for how long, where he shifts gears, and where he accelerates and decelerates. Each subsequent run should be an exact duplicate of the previous run and no attempt to improve should be made.

The use of stopwatches by observers and/or drivers to facilitate the measurement of time and speed between mile (km) markers has been found to be a valuable aid in meeting the time requirements of this test procedure.

It has also been found useful to select mile (km) marker check points along the route and record the time between markers, the time to negotiate a cloverleaf, and the time elapsed from interstate ramp to ramp. The selected check points should remain the same for each test run. No attempt should be made to compensate for a fast or slow elapsed time between two previous check points.

7.7 To minimize test variability, it is recommended that all vehicles (C and T) being tested be in similar mechanical conditions, be representative of the operator's vehicle(s) involved in the test, and have (except in the case where this is the item being evaluated):

- (a) Each engine governor set to manufacturer's recommendation or the operator's standard.
- (b) New air cleaner element and new fuel filters. Installation of new air cleaner element can be waived if vehicle's inlet restriction does not exceed 15 in H₂O (3.7 kPa).
- (c) Each vehicle reasonably clean and free of sheet metal dents, tears, or missing body parts. Fiberglass hoods should be intact.
- (d) Cab side window openings the same in each vehicle, open or closed, for the entire test. For transit buses, all windows should stay the same (open or closed) for entire test.
- (e) Accessory load for each vehicle as consistent as possible (for example, by turning air conditioning off, defroster off, heat switch at the same position, and lights on).
- (f) Trailer free of damage to exterior surfaces that would affect aerodynamic drag.

(g) Truck/tractor alignment checked and proper. Trailer axle alignment checked and proper.

(h) Each vehicle properly lubricated prior to test. All fluid levels should be checked and be at prescribed levels.

(i) Temperature controlled fan drives and shutters locked in the same operating mode throughout the test.

(j) Cold tire pressures measured and inflated to operator's standard.

(k) A stall check made on vehicles equipped with automatic transmissions and torque converters.

(l) Exhaust system back pressure below engine manufacturer's maximum recommended limit and within 0.5 in Hg (1.7 kPa) between test vehicle engines of the same make and model.

(m) Proper brake adjustment.

7.8 At the end of each warm-up and at the end of each test run, all vehicles must be checked for mechanical changes that would affect test results. Typical checks would include:

- (a) Oil pressure and leaks.
- (b) Coolant temperature and leaks.
- (c) Exhaust gas temperature.
- (d) Engine air filter restriction
- (e) Electrical load.
- (f) Tire pressures.
- (g) Brake dragging (i.e. temperature).
- (h) Exhaust smoke.
- (i) Observed ability to maintain selected test speed.
- (j) Transmission or differential leaks.
- (k) Intake manifold pressure (turbocharger boost).

7.9 Drivers of Vehicles "C" and "T" should be interviewed between test runs to ascertain any differences in the apparent handling, power, and braking characteristics of their respective vehicles. If changes occur between the test runs of either the baseline segment or the test segment, the test data should be discarded and the test re-run after correction of the problem.

7.10 In order to obtain results which may be considered representative of actual service conditions, it is important to reproduce typical service conditions during the test. This applies to load weights, routes, grades, vehicle speeds, weather, wind conditions, drivers, etc. For example, if the actual service vehicles generally operate in a part of the country where hills exist over a substantial portion of the routes, the test should be conducted on similar terrain in order to obtain the most representative results.

7.11 Because of the special nature of aerodynamic drag reduction equipment (deflectors, body fairings, roof fairings, vortex stabilizers, etc.) comparison tests between brands or types should not be run with two trucks. If comparative results are required, additional test trucks are recommended during any given test. The entire range of results may be either higher or lower than average conditions depending upon the weather (wind velocity and direction) on the days during which the tests were conducted. To minimize the effects of high or low yaw angle wind effects, a circular route or closed loop of highways is recommended.

7.12 The accuracy of odometers and speedometers of Vehicles "C" and "T" should be determined during the warm-up test and compensations made for error during actual test runs. If odometer readings (total miles (km)) between two vehicles differ, it is recommended that the two elapsed mileage (km) readings be averaged and this value be used for calculation purposes. Another acceptable method would be to use a vehicle with known speedometer and odometer accuracy and use that distance for calculations of mpg (km/L) conversions.

7.13 If test participants are extremely careful and pay attention to all details of the procedure, it has been found that it is highly unusual that more than five test runs are required to complete a segment. It has also been found that, almost without exception, a procedural error or a mechanical problem can be identified when it is necessary to throw out a test run.

8. Bibliography

TMC Report, "Report of Frederick, Maryland, Truck and Bus Fuel Economy Demonstration, Conducted October 22–November 1, 1979, by the Joint TMC/SAE Task Force for In-Service Test Procedures of the American Trucking Industry," November 1980.

Proposed SAE Information Report, "Bus Advisory Group—Information Report."

SAE Paper No. 810025.

⁴Baseline Advanced Design Transit Coach Specification, Part II, paragraph 1.2 (17), Guideline procurement document for new 30 and 40 ft (10.4 and 12.2 m) coach design. Published by DOT and UMTA.

APPENDIX I

SAMPLE CALCULATIONS

A1. Derivation of Baseline Data

A1.1 Baseline Segment

A.

Test Run No.	Fuel Consumed, lb or kg, Test Vehicle (Data Point)	÷	Fuel Consumed, lb or kg, Control Vehicle (Data Point)	= T/C Ratio
1	78.94		68.04	1.1602
2	79.41		66.84	1.1881
3	77.50		66.84	1.1595

Check: T/C values must be within 2%¹:

After three test runs:

- B. Highest T/C ratio x .98 = minimum acceptable T/C ratio
 $1.1881 \times .98 = 1.1643$

The T/C ratios derived by test runs #1 and #3 are less than the minimum acceptable T/C ratios calculated in B. Therefore, additional baseline data are required. This comparative test to assure T/C ratios within 2% should be made after the third test run and then after each succeeding test run that is required. When three test runs repeated within 2% of each other, as checked in B, have been computed, the baseline segment is complete. In this example, an additional test run is required.

Test Run No.	Fuel Consumed, lb or kg, Test Vehicle (Data Point)	÷	Fuel Consumed, lb or kg, Control Vehicle (Data Point)	= T/C Ratio
1	78.94		68.04	1.1602
2	79.41		66.84	1.1881
3	77.50		66.84	1.1595
4	78.54		67.84	1.1577

After four test runs:

C.

1. Highest T/C ratio x .98 = minimum acceptable T/C ratio
 $1.1881 \times .98 = 1.1643$
2. Second highest T/C ratio x .98 = minimum acceptable T/C ratio
 $1.1602 \times .98 = 1.1370$

Because there are three T/C ratios greater than the minimum acceptable T/C ratio as determined by calculation C.2., the requirement that three test runs fall within a 2% band has been met and the baseline segment is complete.

Test runs #1 and #3 were valid when tested by comparison with test run #4. Therefore, run #2 is considered faulty and is deleted as part of the baseline segment. Since test runs #1, #3, and #4 meet the 2% requirement, a #5 test run is not required.

The same procedure shown at A and B is repeated as in C.

If a fifth test is required to get three valid T/C ratios, the determination of those runs is done per item D.

- D.
- Highest T/C ratio x .98 = minimum acceptable T/C ratio
 - Second highest T/C ratio x .98 = minimum acceptable T/C ratio
 - Third highest T/C ratio x .98 = minimum acceptable T/C ratio

Note: If test participants are extremely careful and pay attention to all details of the procedure, it has been found that it is highly unusual that more than five test runs are required to complete a segment. It has also been found that, almost without exception, a procedural error or a mechanical problem can be identified when it is necessary to throw out a test run.

The test segment may now be started.

A1.2 Test Segment—Make similar calculations as in baseline segment. (Typical test segment results are shown in paragraph A2.2.)

A2. Calculation of Results—After finishing a baseline segment and a test segment, calculate the result. That is, compare the baseline segment, per-

formed before the component change was made to the truck, to the test segment, performed after the change. Each segment was run until three T/C ratios of fuel consumption were obtained which met the 2% test. For calculating the results, we must now compare them.

A2.1 Baseline Segment T/C Ratios

Test Run =1	1.1602
=3	1.1595
=4	1.1577
Ave.	$3.4774 \div 3 = 1.1591$

A2.2 Test Segment T/C Ratios—(See A1.2.)

Test Run =2	1.0959
=3	1.1080
=4	1.0936
Ave.	$3.2975 \div 3 = 1.0992$

The T/C ratios derived in each segment are ratios comparing the fuel consumption of the test vehicle (T) to the control vehicle (C). It is by comparing these ratios that we derive the percentage improvement (positive or negative) between the baseline segment (before the component change) and the test segment (after the component change).

A2.3 Percent Fuel Saved

$$= (\text{Ave. Baseline T/C} - \text{Ave. Test T/C}) \div \text{Ave. Baseline T/C}$$

$$= (1.1591 - 1.0992) \div 1.1591$$

$$= (0.0517 \times 100) = 5.17\% \text{ Fuel Saved.}$$

A2.4 Percent Improvement

$$= (\text{Ave. Baseline T/C} - \text{Ave. Test T/C}) \div \text{Ave. Test T/C}$$

$$= (1.1591 - 1.0992) \div 1.0992$$

$$= (0.0545 \times 100) = 5.45\% \text{ Improvement.}$$

A3. mpg (km/L) Conversion—The preferred method of expressing the result of a test is as a percent of fuel saved, as described in paragraph A2.3. If it is desired to see fuel consumption stated in mpg (km/L) it must be emphasized that these values apply to the specific test conditions only.

This section of the procedure describes how to state the results in consistent mpg (km/L) values. The fuel consumption of the control vehicle is used, in an arbitrary role, in this calculation. For reasons of consistency, so that the resulting mpg (km/L) values can be compared with each other, it is important that the same control vehicle mpg (km/L) value be used to derive all test vehicles' mpg (km/L) values. Two ways of calculating this representative control vehicle mpg (km/L) are shown and the choice between them is not important. It is important that the precaution be followed of using only one representative control vehicle (including driver) mpg (km/L) value to calculate all mpg (km/L) values which might be compared with each other.

The fuel specific weight of the actual test fuel should be determined and used for this calculation. As an alternative, a value of 7.05 lb/gal (0.84 kg/L) for #2 diesel and 6.0 lb/gal (0.72 kg/L) for gasoline may be used.

A3.1 Representative Control Vehicle mpg (km/L)—The control vehicle representative mpg (km/L) can be obtained from valid fuel consumption for one day or from the valid fuel consumption for every time that control vehicle was used². For this example, the baseline segment valid runs will be used:

68.04	Run =1
66.84	Run =3
67.84	Run =4

202.72 lb for 3 runs

$$202.72 \text{ lb} \div 7.05 \text{ lb/gal} = 28.75 \text{ gal}$$

$$(91.95 \text{ kg} \div 0.85 \text{ kg/L} = 108.17 \text{ L})^3$$

$$50 \text{ miles} \times 3 \text{ runs} = 150 \text{ miles}$$

$$(80.5 \text{ km} \times 3 \text{ runs} = 241.4 \text{ km})^4$$

$$150 \text{ miles} \div 28.75 \text{ gal} = 5.22 \text{ miles/gal}^4$$

$$(241.4 \text{ km} \div 108.17 \text{ L} = 2.23 \text{ km/L})$$

¹Use .98 as a multiplier for this purpose.

A3.2 Test Vehicle Baseline mpg (km/L)

Control vehicle representative mpg (km/L) ÷ Ave. Baseline T/C Ratio

$$5.22 \text{ mpg} \div 1.1591 = 4.50 \text{ mpg}$$

$$(2.23 \text{ km/L} \div 1.1591 = 1.92 \text{ km/L})$$

Test Vehicle Test mpg (km/L)

Control vehicle representative mpg (km/L) ÷ Ave. Test T/C Ratio

$$5.22 \text{ mpg} \div 1.0992 = 4.75 \text{ mpg}$$

$$(2.23 \text{ km/L} \div 1.0992 = 2.03 \text{ km/L})$$

A3.3 Improvement in mpg (km/L)

Test - Baseline

$$4.75 - 4.50 = 0.25 \text{ mpg improvement}$$

$$(2.02 - 1.92 = 0.10 \text{ km/L improvement})$$

²5.22 mpg (2.23 km/L) has been established as representative of this control vehicle recognizing that tests run on other days under different weather conditions will result in a different mpg (km/L) value for the control vehicle. However, for other tests where this control vehicle is used for the purpose of converting to mpg (km/L) the 5.22 mpg (2.23 km/L) must be used as the representative value if a valid mpg (km/L) conversion is to be made. If a new representative value is used, all previous mpg (km/L) improvements must be recalculated using the new representative value.

³To convert lb to kg multiply lb by 0.4536.

⁴To convert miles to km multiply miles by 1.6093.

TYPE II TEST DATA FORM #1 (VEHICLE IDENTIFICATION)

Power Unit

Fleet _____ Date _____ Test # _____

	<u>Control Vehicle</u>	<u>Test Vehicle</u>
Unit Number	_____	_____
Make	_____	_____
Model	_____	_____
Year	_____	_____
Number of Axles	_____	_____
Number of Drive Axles	_____	_____
Engine Make/Model	_____	_____
Governed Speed @ No Load (High Idle)	_____ RPM	_____ RPM
Rated Power (bhp)	_____ hp (kw)	_____ hp (kw)
Rated Speed	_____ RPM	_____ RPM
Peak Torque	_____ lb-ft	_____ lb-ft
Peak Torque Speed	_____ RPM	_____ RPM
Transmission Make/Model	_____	_____
Geared For	_____ mph (km/h)	_____ mph (km/h)
	at _____ RPM	at _____ RPM
	in _____ gear	in _____ gear
Differential Make/Model	_____	_____
Differential Ratio	_____	_____
Tire Size/Type/Make/Model	_____/_____/_____	_____/_____/_____
Tire Pressure (Cold)	_____ psi (kPa)	_____ psi (kPa)
5th Wheel Setting (express in in (mm) the distance 5th wheel fulcrum is ahead or behind the center line of bogie)	_____ in (mm)	_____ in (mm)

Note: In areas where two units are shown [i.e., hp (kw)] circle the unit used.

TYPE II TEST DATA FORM #1 (VEHICLE IDENTIFICATION) (Continued)

Trailer/Body

Fleet _____ Date _____ Test # _____

	<u>Control Vehicle</u>	<u>Test Vehicle</u>
Unit Number	_____	_____
Make	_____	_____
Model	_____	_____
Year	_____	_____
Type (Van, Flatbed, Tank, Etc.)	_____	_____
Type of Side	_____	_____
Type of Corner	_____	_____
Height	_____	_____
Length	_____	_____
Tire Size/Type/Make/Model	_____/_____/_____/_____	_____/_____/_____/_____
Tire Pressure (Cold)	_____ psi (kPa)	_____ psi (kPa)
Number of Axles on Trailer(s)	_____	_____
G.V.W. (Measured on Scale)	_____	_____
Kingpin Setting	_____ in (mm)	_____ in (mm)
Cab-to-Trailer Gap	_____ in (mm)	_____ in (mm)

TYPE II TEST DATA FORM #1 (VEHICLE IDENTIFICATION) (Continued)

Devices, Components, or Systems That Are Incorporated into Control and Test Vehicle Specifications

Fleet _____ Date _____ Test # _____

	Control Vehicle			Test Vehicle		
	No	Yes	Type	No	Yes	Type
Radiator Shutters (on-off or modulating)						
Engine Cooling Fan Sys. (Describe below-A)						
Aerodynamic Device (Describe below-B)						
Engine Oil						
Transmission Lube						
Differential Lube						
Fuel Heater						
Oil Cooler						
Tag Axle						
Air Lift Axle(s)						
Low Back Pressure Exhaust System						
Other:						

A _____

B _____

TYPE II TEST DATA FORM #1 (VEHICLE IDENTIFICATION) (Continued)

Fleet _____ Date _____ Test # _____

Detailed Description of Vehicle, Component, or System Modification Being Tested:

Length of Test Route from Start to Stop Point: _____ miles (km)

Test Route: (Describe in detail number of lanes; type of road surface; type of turnarounds; type, if any, of traffic control devices; type of terrain, hills, cuts, curves; special driving instructions; etc.)

Driver(s) Interview

Handling, Power, and Braking Characteristics of Vehicle(s) during Test (see paragraph 7.5):

Control Vehicle _____

Test Vehicle _____

TYPE II—FUEL ECONOMY TEST DATA FORM =2-1

BASELINE SEGMENT OF THE CONTROL VEHICLE

Type II Test—Portable Fuel Tank Weighing Method or Fuel Flow Meter Method

Fleet _____ Control Tractor = _____ Control Trailer = _____

Driver _____ Observer _____

Test = _____ Date _____

Test Speed _____ Route _____

Test Run #1

Scale Repeatability Check Weight _____

	<u>Fuel Weight/Fuel Meter Reading</u>	<u>Odometer</u>	<u>Time</u>
Start	_____	_____	_____
Finish	_____	_____	_____

Fuel Used _____ lb/gal kg/L (circle one)

Time from Start to Finish _____ h _____ m _____ s

Subtract Vehicle Stopped Time _____ h _____ m _____ s

Vehicle Running Time¹ _____ h _____ m _____ s

Test Run #2

Scale Repeatability Check Weight _____

	<u>Fuel Weight/Fuel Meter Reading</u>	<u>Odometer</u>	<u>Time</u>
Start	_____	_____	_____
Finish	_____	_____	_____

Fuel Used _____ lb/gal kg/L (circle one)

Time from Start to Finish _____ h _____ m _____ s

Subtract Vehicle Stopped Time _____ h _____ m _____ s

Vehicle Running Time¹ _____ h _____ m _____ s

Test Run #3

Scale Repeatability Check Weight _____

	<u>Fuel Weight/Fuel Meter Reading</u>	<u>Odometer</u>	<u>Time</u>
Start	_____	_____	_____
Finish	_____	_____	_____

Fuel Used _____ lb/gal kg/L (circle one)

Time from Start to Finish _____ h _____ m _____ s

Subtract Vehicle Stopped Time _____ h _____ m _____ s

Vehicle Running Time¹ _____ h _____ m _____ s

Test Run =4

Scale Repeatability Check Weight _____

	<u>Fuel Weight/Fuel Meter Reading</u>	<u>Odometer</u>	<u>Time</u>
Start	_____	_____	_____
Finish	_____	_____	_____

Fuel Used _____ lb/gal kg/L (circle one)

Time from Start to Finish _____ h _____ m _____ s

Subtract Vehicle Stopped Time _____ h _____ m _____ s

Vehicle Running Time¹ _____ h _____ m _____ s

Test Run =5

Scale Repeatability Check Weight _____

	<u>Fuel Weight/Fuel Meter Reading</u>	<u>Odometer</u>	<u>Time</u>
Start	_____	_____	_____
Finish	_____	_____	_____

Fuel Used _____ lb/gal kg/L (circle one)

Time from Start to Finish _____ h _____ m _____ s

Subtract Vehicle Stopped Time _____ h _____ m _____ s

Vehicle Running Time¹ _____ h _____ m _____ s

Control Vehicle MPG Calculation

Total Fuel Used _____ lb/gal kg/L (circle one) Time _____ h _____ m _____ s

Total Fuel Used lb/gal kg/L² _____ ÷ 3 _____ = _____ gal (L)

Total Miles (km) Run _____ ÷ _____ gal (L) used = _____ miles/gal (km/L)

Miles (km) Run _____ ÷ _____ h = _____ miles/h (km/h)

Weather:	Temperature	Humidity	Barometric Pressure	Wind Speed	Wind Direction
Run =1	_____	_____	_____	_____	_____
Run =2	_____	_____	_____	_____	_____
Run =3	_____	_____	_____	_____	_____
Run =4	_____	_____	_____	_____	_____
Run =5	_____	_____	_____	_____	_____

¹Running Time must repeat within ±18 s for 1 h run or ±0.5% of the time required to complete the test run or run data point must not be used. See paragraphs 3.2, 3.3, 5.5, 5.9.

²If fuel meter is used record meter readings in this column.

³For No. 2 diesel, use 7.05 lb/gal (0.84 kg/L); or for gasoline use 6.0 lb/gal (0.72 kg/L); or actual specific weight of fuel can be used.

TYPE II - FUEL ECONOMY TEST DATA FORM -2-2

BASELINE SEGMENT OF THE TEST VEHICLE

Type II Test - Portable Fuel Tank Weighing Method or Fuel Flow Meter Method

Fleet _____ Test Tractor = _____ Test Trailer = _____
 Driver _____ Observer _____
 Test # _____ Date _____
 Test Speed _____ Route _____

Test Run #1

Scale Repeatability Check Weight _____

	<u>Fuel Weight/Fuel Meter Reading</u>	<u>Odometer</u>	<u>Time</u>
Start	_____	_____	_____
Finish	_____	_____	_____

Fuel Used _____ lb/gal kg/L (circle one)

Time from Start to Finish _____ h _____ m _____ s
 Subtract Vehicle Stopped Time _____ h _____ m _____ s
 Vehicle Running Time¹ _____ h _____ m _____ s

Test Run #2

Scale Repeatability Check Weight _____

	<u>Fuel Weight/Fuel Meter Reading</u>	<u>Odometer</u>	<u>Time</u>
Start	_____	_____	_____
Finish	_____	_____	_____

Fuel Used _____ lb/gal kg/L (circle one)

Time from Start to Finish _____ h _____ m _____ s
 Subtract Vehicle Stopped Time _____ h _____ m _____ s
 Vehicle Running Time¹ _____ h _____ m _____ s

Test Run #3

Scale Repeatability Check Weight _____

	<u>Fuel Weight/Fuel Meter Reading</u>	<u>Odometer</u>	<u>Time</u>
Start	_____	_____	_____
Finish	_____	_____	_____

Fuel Used _____ lb/gal kg/L (circle one)

Time from Start to Finish _____ h _____ m _____ s
 Subtract Vehicle Stopped Time _____ h _____ m _____ s
 Vehicle Running Time¹ _____ h _____ m _____ s

Test Run #4

Scale Repeatability Check Weight _____

	<u>Fuel Weight/Fuel Meter Reading</u>	<u>Odometer</u>	<u>Time</u>
Start	_____	_____	_____
Finish	_____	_____	_____

Fuel Used _____ lb/gal kg/L (circle one)

Time from Start to Finish _____ h _____ m _____ s

Subtract Vehicle Stopped Time _____ h _____ m _____ s

Vehicle Running Time¹ _____ h _____ m _____ s

Test Run #5

Scale Repeatability Check Weight _____

	<u>Fuel Weight/Fuel Meter Reading</u>	<u>Odometer</u>	<u>Time</u>
Start	_____	_____	_____
Finish	_____	_____	_____

Fuel Used _____ lb/gal kg/L (circle one)

Time from Start to Finish _____ h _____ m _____ s

Subtract Vehicle Stopped Time _____ h _____ m _____ s

Vehicle Running Time¹ _____ h _____ m _____ s

Weather:	Temperature	Humidity	Barometric Pressure	Wind Speed	Wind Direction
Run #1	_____	_____	_____	_____	_____
Run #2	_____	_____	_____	_____	_____
Run #3	_____	_____	_____	_____	_____
Run #4	_____	_____	_____	_____	_____
Run #5	_____	_____	_____	_____	_____

¹Running Time must repeat within ±18 s for 1 h run or ±0.5% of the time required to complete the test run or run data point must not be used. See paragraphs 3.2, 3.3, 5.5, 5.9.

TYPE II—FUEL ECONOMY TEST DATA FORM #2-3

TEST SEGMENT OF THE CONTROL VEHICLE

Type II Test—Portable Fuel Tank Weighing Method or Fuel Flow Meter Method

Fleet _____ Control Tractor = _____ Control Trailer = _____

Driver _____ Observer _____

Test # _____ Date _____

Test Speed _____ Route _____

Test Run #1

Scale Repeatability Check Weight _____

	<u>Fuel Weight/Fuel Meter Reading</u>	<u>Odometer</u>	<u>Time</u>
Start	_____	_____	_____
Finish	_____	_____	_____

Fuel Used _____ lb/gal kg/L (circle one)

Time from Start to Finish _____ h _____ m _____ s

Subtract Vehicle Stopped Time _____ h _____ m _____ s

Vehicle Running Time¹ _____ h _____ m _____ s

Test Run #2

Scale Repeatability Check Weight _____

	<u>Fuel Weight/Fuel Meter Reading</u>	<u>Odometer</u>	<u>Time</u>
Start	_____	_____	_____
Finish	_____	_____	_____

Fuel Used _____ lb/gal kg/L (circle one)

Time from Start to Finish _____ h _____ m _____ s

Subtract Vehicle Stopped Time _____ h _____ m _____ s

Vehicle Running Time¹ _____ h _____ m _____ s

Test Run #3

Scale Repeatability Check Weight _____

	<u>Fuel Weight/Fuel Meter Reading</u>	<u>Odometer</u>	<u>Time</u>
Start	_____	_____	_____
Finish	_____	_____	_____

Fuel Used _____ lb/gal kg/L (circle one)

Time from Start to Finish _____ h _____ m _____ s

Subtract Vehicle Stopped Time _____ h _____ m _____ s

Vehicle Running Time¹ _____ h _____ m _____ s

Test Run #4

Scale Repeatability Check Weight _____

	<u>Fuel Weight/Fuel Meter Reading</u>	<u>Odometer</u>	<u>Time</u>
Start	_____	_____	_____
Finish	_____	_____	_____

Fuel Used _____ lb/gal kg/L (circle one)

Time from Start to Finish _____ h _____ m _____ s
 Subtract Vehicle Stopped Time _____ h _____ m _____ s
 Vehicle Running Time¹ _____ h _____ m _____ s

Test Run #5

Scale Repeatability Check Weight _____

	<u>Fuel Weight/Fuel Meter Reading</u>	<u>Odometer</u>	<u>Time</u>
Start	_____	_____	_____
Finish	_____	_____	_____

Fuel Used _____ lb/gal kg/L (circle one)

Time from Start to Finish _____ h _____ m _____ s
 Subtract Vehicle Stopped Time _____ h _____ m _____ s
 Vehicle Running Time¹ _____ h _____ m _____ s

Control Vehicle MPG Calculation

Total Fuel Used _____ lb/gal kg/L (circle one) Time _____ h _____ m _____ s
 Total Fuel Used lb/gal kg/L² _____ ÷³ _____ = _____ gal (L)
 Total Miles (km) Run _____ ÷ _____ gal (L) used = _____ miles/gal (km/L)
 Miles (km) Run _____ ÷ _____ h = _____ miles/h (km/h)

Weather:	Temperature	Humidity	Barometric Pressure	Wind Speed	Wind Direction
Run #1	_____	_____	_____	_____	_____
Run #2	_____	_____	_____	_____	_____
Run #3	_____	_____	_____	_____	_____
Run #4	_____	_____	_____	_____	_____
Run #5	_____	_____	_____	_____	_____

¹Running Time must repeat within .18 s for 1 h run or .05% of the time required to complete the test run or run data point must not be used. See paragraphs 3.2, 3.3, 5.5, 5.9.

²If fuel meter is used record meter readings in this column.

³For No. 2 diesel, use 7.05 lb/gal (0.84 kg/L); or for gasoline use 6.0 lb/gal (0.72 kg/L); or actual specific weight of fuel can be used.

TYPE II—FUEL ECONOMY TEST DATA FORM -2-4

TEST SEGMENT OF THE TEST VEHICLE

Type II Test—Portable Fuel Tank Weighing Method or Fuel Flow Meter Method

Fleet _____ Test Tractor = _____ Test Trailer = _____
 Driver _____ Observer _____
 Test = _____ Date _____
 Test Speed _____ Route _____

Test Run =1

Scale Repeatability Check Weight _____

	<u>Fuel Weight/Fuel Meter Reading</u>	<u>Odometer</u>	<u>Time</u>
Start	_____	_____	_____
Finish	_____	_____	_____

Fuel Used _____ lb/gal kg/L (circle one)

Time from Start to Finish _____ h _____ m _____ s

Subtract Vehicle Stopped Time _____ h _____ m _____ s

Vehicle Running Time¹ _____ h _____ m _____ s

Test Run =2

Scale Repeatability Check Weight _____

	<u>Fuel Weight/Fuel Meter Reading</u>	<u>Odometer</u>	<u>Time</u>
Start	_____	_____	_____
Finish	_____	_____	_____

Fuel Used _____ lb/gal kg/L (circle one)

Time from Start to Finish _____ h _____ m _____ s

Subtract Vehicle Stopped Time _____ h _____ m _____ s

Vehicle Running Time¹ _____ h _____ m _____ s

Test Run =3

Scale Repeatability Check Weight _____

	<u>Fuel Weight/Fuel Meter Reading</u>	<u>Odometer</u>	<u>Time</u>
Start	_____	_____	_____
Finish	_____	_____	_____

Fuel Used _____ lb/gal kg/L (circle one)

Time from Start to Finish _____ h _____ m _____ s

Subtract Vehicle Stopped Time _____ h _____ m _____ s

Vehicle Running Time¹ _____ h _____ m _____ s

Test Run =4

Scale Repeatability Check Weight _____

	<u>Fuel Weight/Fuel Meter Reading</u>	<u>Odometer</u>	<u>Time</u>
Start	_____	_____	_____
Finish	_____	_____	_____

Fuel Used _____ lb/gal kg/L (circle one)

Time from Start to Finish _____ h _____ m _____ s
 Subtract Vehicle Stopped Time _____ h _____ m _____ s
 Vehicle Running Time¹ _____ h _____ m _____ s

Test Run =5

Scale Repeatability Check Weight _____

	<u>Fuel Weight/Fuel Meter Reading</u>	<u>Odometer</u>	<u>Time</u>
Start	_____	_____	_____
Finish	_____	_____	_____

Fuel Used _____ lb/gal kg/L (circle one)

Time from Start to Finish _____ h _____ m _____ s
 Subtract Vehicle Stopped Time _____ h _____ m _____ s
 Vehicle Running Time¹ _____ h _____ m _____ s

Weather:	Temperature	Humidity	Barometric Pressure	Wind Speed	Wind Direction
Run =1	_____	_____	_____	_____	_____
Run =2	_____	_____	_____	_____	_____
Run =3	_____	_____	_____	_____	_____
Run =4	_____	_____	_____	_____	_____
Run =5	_____	_____	_____	_____	_____

¹Running Time must repeat within .18 s for 1 h run or .05% of the time required to complete the test run or run data point must not be used. See paragraphs 3.2, 3.3, 5.5, 5.9.

TYPE II—FUEL ECONOMY TEST DATA FORM #3

CALCULATION SUMMARY SHEET

Fleet _____ Date _____ Test = _____

Baseline Runs	Test Vehicle Fuel Used, lb/gal kg/L (circle one) Form #2-2		Control Vehicle Fuel Used, lb/gal kg/L (circle one) Form #2-1		T/C Ratio	Check Valid T/C Ratios Used
	lb/gal	kg/L	lb/gal	kg/L		
1	_____	_____	_____	_____	_____	_____
2	_____	_____	_____	_____	_____	_____
3	_____	_____	_____	_____	_____	_____
4	_____	_____	_____	_____	_____	_____
5	_____	_____	_____	_____	_____	_____

Note: Use only valid T/C ratios for calculation of average T/C.
 Sum of valid baseline T/C ÷ No. of valid baseline T/C's = average baseline T/C
 _____ ÷ _____ = _____

Test Runs	Test Vehicle Fuel Used, lb/gal kg/L (circle one) Form #2-4		Control Vehicle Fuel Used, lb/gal kg/L (circle one) Form #2-3		T/C Ratio	Check Valid T/C Ratios Used
	lb/gal	kg/L	lb/gal	kg/L		
1	_____	_____	_____	_____	_____	_____
2	_____	_____	_____	_____	_____	_____
3	_____	_____	_____	_____	_____	_____
4	_____	_____	_____	_____	_____	_____
5	_____	_____	_____	_____	_____	_____

Note: Use only valid T/C ratios for calculation of average T/C.
 Sum of valid test T/C ÷ No. of valid test T/C = average test T/C
 _____ ÷ _____ = _____

CALCULATION OF T/C LIMITS FORM #3-1

Fleet _____ Date _____ Test # _____

After 3 Runs:

Highest T/C Ratio _____ x 0.98 = _____ minimum acceptable T/C ratio

After 4 Runs:

Highest T/C Ratio _____ x 0.98 = _____ minimum acceptable T/C ratio

Second Highest T/C Ratio _____ x 0.98 = _____ minimum acceptable T/C ratio

After 5 Runs:

Highest T/C Ratio _____ x 0.98 = _____ minimum acceptable T/C ratio

Second Highest T/C Ratio _____ x 0.98 = _____ minimum acceptable T/C ratio

Third Highest T/C Ratio _____ x 0.98 = _____ minimum acceptable T/C ratio

CALCULATION OF % FUEL SAVED FORM #3-2

Fleet _____ Date _____ Test # _____

% Fuel Saved = (Ave. Baseline T/C - Ave. Test T/C) ÷ Ave. Baseline T/C

% Fuel Saved = (_____ - _____) ÷ _____

% Fuel Saved = _____

Calculation of % Improvement:

% Improvement = (Ave. Baseline T/C - Ave. Test T/C) ÷ Ave. Test T/C

% Improvement = (_____ - _____) ÷ _____

% Improvement = _____

Note: See Appendix I, Sample Calculations, to convert to mpg (km/L).

**TYPE II - FUEL ECONOMY TEST
THE OBSERVER'S WORKSHEET FORM #4**

Fleet _____ Date _____ Test # _____

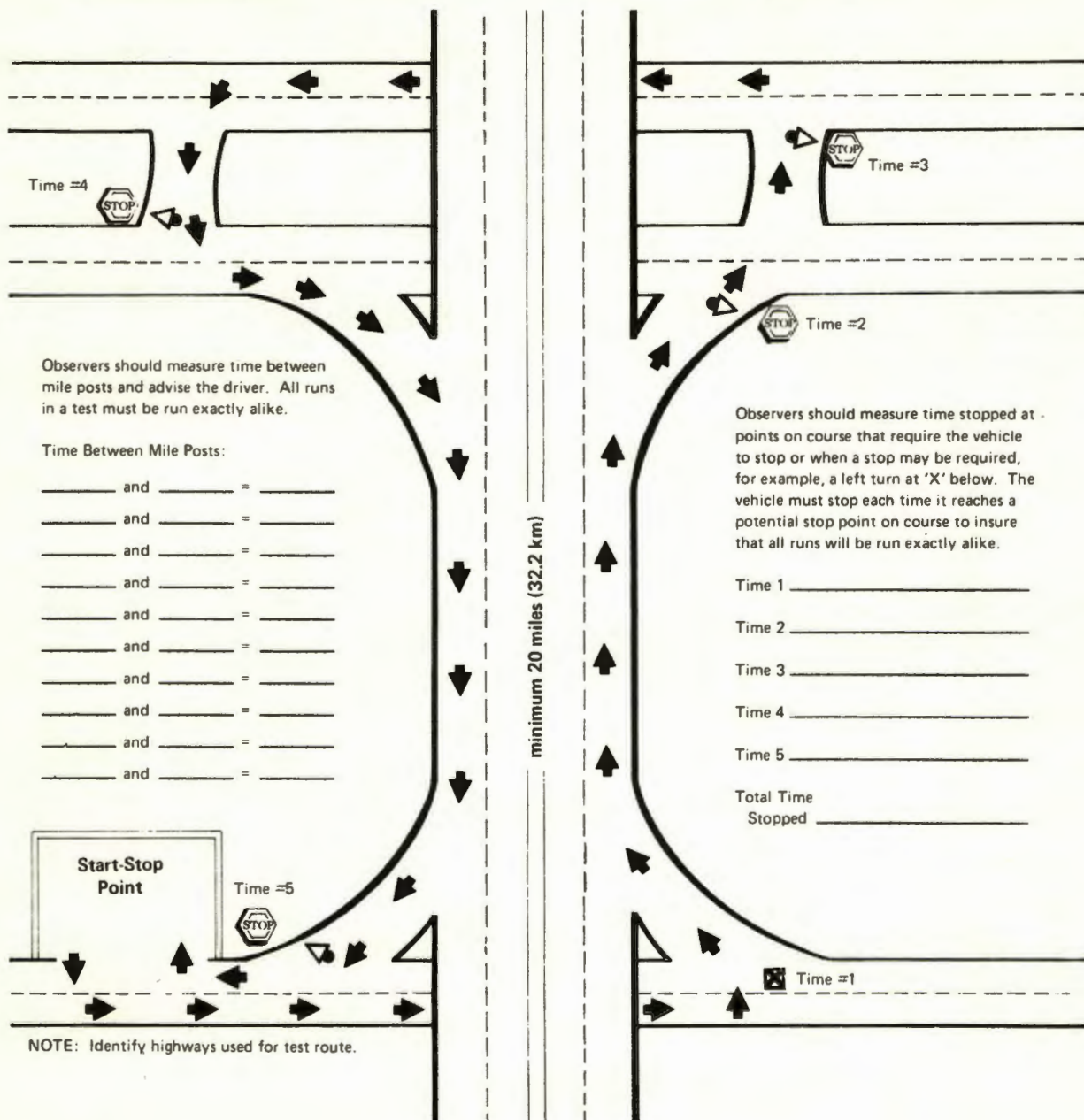

Observers should measure time between mile posts and advise the driver. All runs in a test must be run exactly alike.

Time Between Mile Posts:

_____ and _____ = _____

_____ and _____ = _____

_____ and _____ = _____

_____ and _____ = _____

_____ and _____ = _____

_____ and _____ = _____

_____ and _____ = _____

_____ and _____ = _____

_____ and _____ = _____

Observers should measure time stopped at points on course that require the vehicle to stop or when a stop may be required, for example, a left turn at 'X' below. The vehicle must stop each time it reaches a potential stop point on course to insure that all runs will be run exactly alike.

Time 1 _____

Time 2 _____

Time 3 _____

Time 4 _____

Time 5 _____

Total Time Stopped _____

OBSERVER'S NAME _____

All technical reports, including standards approved and practices recommended, are advisory only. Their use by anyone engaged in industry or trade or their use by governmental agencies is entirely voluntary. There is no agreement to adhere to any SAE Standard or Recommended Practice, and no commitment to conform to or be guided by any technical report. In formulating and approving tech-

nical reports, the Technical Board, its councils, and committees will not investigate or consider patents which may apply to the subject matter. Prospective users of the report are responsible for protecting themselves against liability for infringement of patents, trademarks, and copyrights.

PRINTED IN U.S.A.

APPENDIX B

TRACK DESCRIPTION



APPENDIX B

TRACK DESCRIPTION

The 7.5-mile test track at TRC was used for fuel economy testing. It encloses a 1600-acre area, one mile wide, and 3-1/2 miles long (see Figure B-1). The track has a downward grade, north to south, of 0.288 percent and a cross slope in the straightaways of 3/16 inch per foot. The 1.88-mile-long straightaways flow into transition areas 2300 feet in length, and then into 5275-foot-long curves with a constant radius of 2400 feet. The 36-foot-wide straightaways and the 42-foot-wide curves provide three test lanes. Paved berms, 12 feet in width, border the straightaways and the inside of the curves.

As a vehicle moves toward the outside of the track in the curves, it encounters a progressively steeper bank. The inside lane, which was used in this test program, has a bank of 13 degrees, allowing a neutral speed of 80 mph with no side forces. In the center lane the slope increases to 19 degrees, resulting in a neutral speed of 110 mph. The outside lane's 25-degree bank allows a 140 mph neutral speed. Rimming the outer lane is a 7-foot safety lane culminating in a 34-degree slope at the guardrail.

The facility is paved with Portland cement concrete. It carries a maximum single axle load weight of 48,000 pounds.

High Speed Test Track

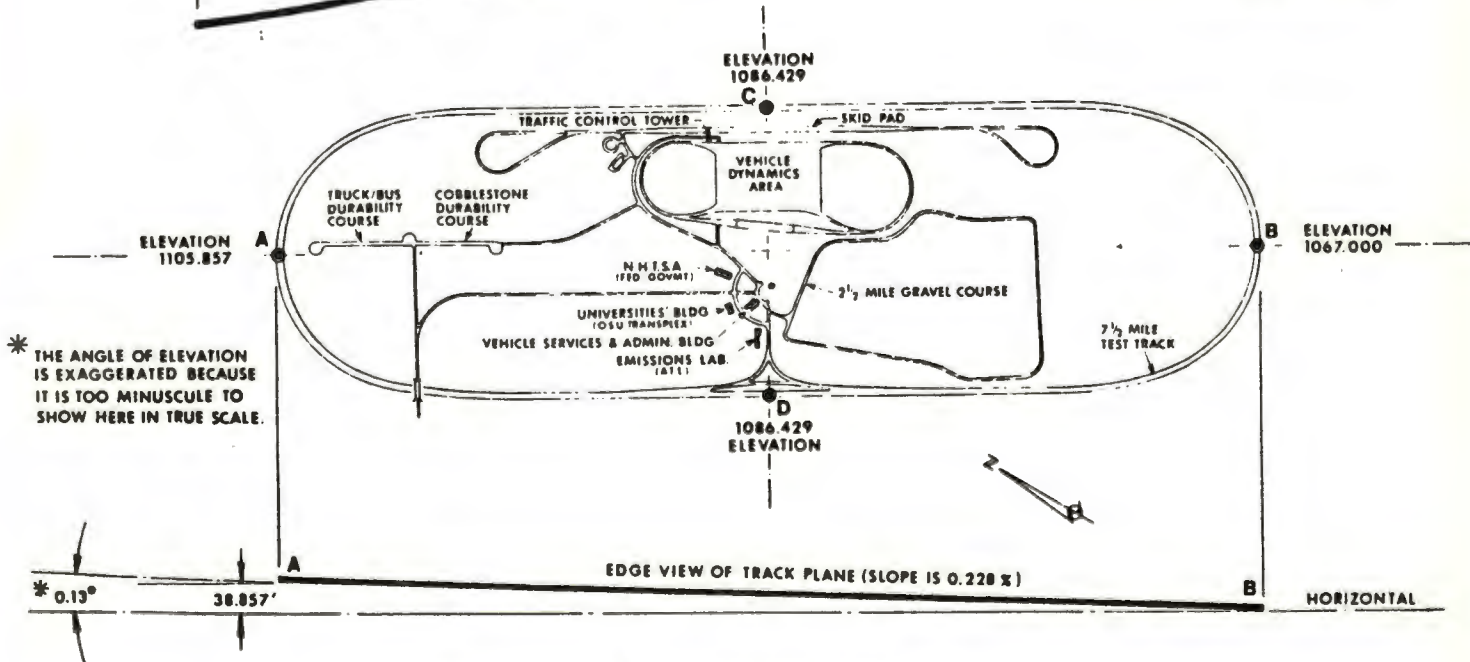
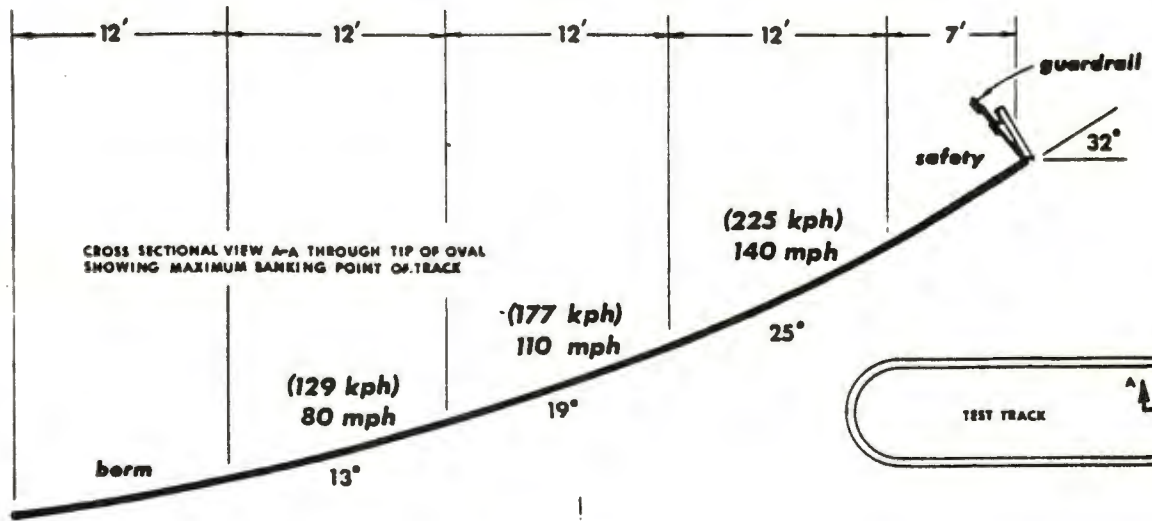
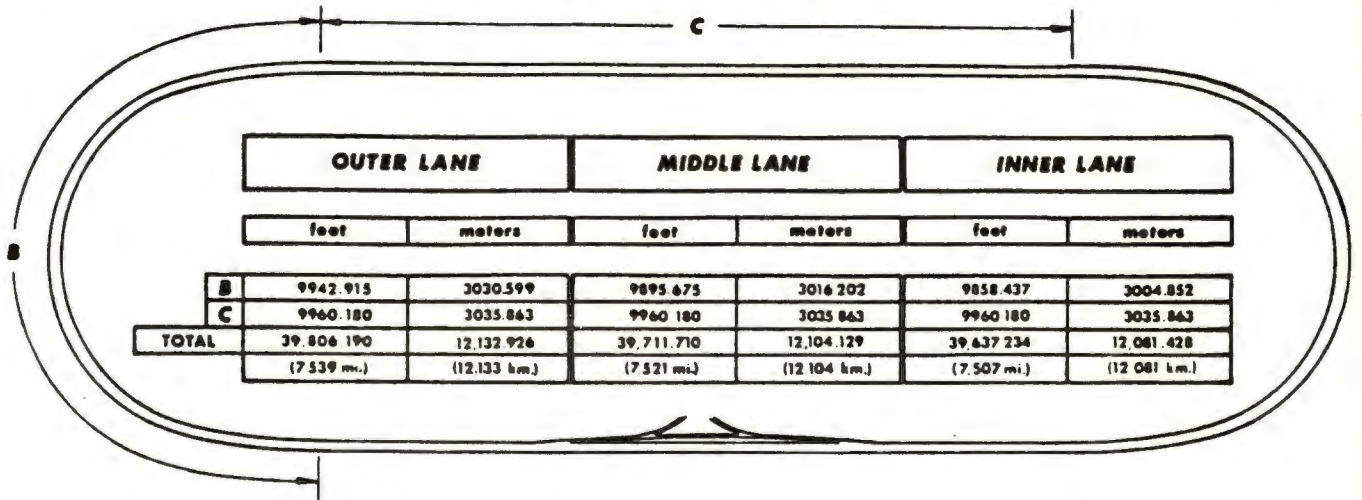

AB, THE LONG AXIS, IS APPR. 3 1/2 MILES, WITH SLOPE AS SHOWN.
 CD, THE SHORT AXIS, IS 5000 FEET, AND THE SLOPE IN THIS DIRECTION IS 0.

FIGURE B-1. HIGH SPEED TEST TRACK

APPENDIX C

FUEL ECONOMY TEST DATA



APPENDIX C

FUEL ECONOMY TEST DATA

The test data in this appendix were generated during the period from July 6 to September 8, 1983, at the Transportation Research Center of Ohio. It includes both fuel analyses and records of fuel consumed during the tests.

Pages C-3 and C-4 show the results of the two fuel analyses done during the test series. They indicate that the energy content of the two samples (BTU/lb) are within 0.2 percent of each other.

The remainder of the appendix contains fuel consumption data and the results of calculations presented as T/C ratios. A T/C ratio is the amount of fuel used by the test bus on a specific run or set of runs divided by the amount of fuel used by the control bus on that same run or runs. The use of the control bus and T/C ratio is consistent with SAE J1321, and permits the comparison of fuel consumption for two conditions of a test vehicle. In this series of tests each bus tested under several conditions but each test was run with only one change from the baseline. The change is noted in the heading of the data tabulations.

The valid T/C ratios for the six runs of each test condition were calculated. The calculations show that the combined ratios are within the tolerance band required by J1321. The bottom line of T/C ratios is the ratios of total fuel consumptions during the valid runs. For example, in the case of Test T-1 the total fuel consumption of the test bus on the combined cycle was 309.45 pounds and the total fuel consumption of the control bus on the same runs was 330.45 pounds. The calculated T/C ratio was

$$\frac{309.45}{330.45} = 0.936.$$

These Ratios of Totals were used in the comparisons which produced the results presented in Table 1 and Table 3.4. The tables are rounded to the nearest one percent on the basis of a desire for clarity in reporting and the recognized ± 1 percent accuracy of the J1321 test procedure.

The following sample calculation compares the combined fuel economy of test bus configuration T-2 to that of the baseline bus configuration (T-1).

$$\frac{\text{T/C Ratio of Totals, T-1 Combined} - \text{T/C Ratio of Totals, T-2 Combined}}{\text{T/C Ratio of Totals, T-1 Combined}} \times 100\%$$

$$= \frac{0.936 - 1.003}{0.936} \times 100\% = -7.158\%$$

This calculation shows a 7 percent decrease in fuel economy from the baseline configuration when the bus is loaded to 1.5 times seated load weight.

CLEVELAND TECHNICAL CENTER, INC.

13600 DEISE AVENUE
CLEVELAND, OHIO 44110
216-451-6455

CLIENT No. **3045-000** ADVISORY No. **145120**
UNIT/N No. **Diesel Fuel** ENGINE SERIAL No. **003161 Diesel Supreme**
SAMPLE DATE **7-5-83** DATE TESTED **7-20-83**

SPECTRA - CHECK®

Kevin R. Boyne
Transportation Research Center
St. Rt. 33 - Logan County
East Liberty, OH 43319

TYPE SERVICE RENDERED: I - II - III OTHER

PHYSICAL TEST RESULTS

FLASH DEGREES F. _____ VISCOSITY SSU 100°F. **34.29**
H₂O% _____ VISCOSITY SSU 210°F. _____
DETERGENCY _____ ANTI FREEZE _____
INSOLUBLES OIL MI/HR. _____
NAPHTHA % VOL. _____ ENG MI/HR. _____

I ANALYSIS OF PHYSICAL TESTS:

NO CORRECTIVE ACTION INDICATED BY TESTS PERFORMED.

TEST RESULTS INDICATE OIL CONDITION IS SATISFACTORY.

API Gravity @ 60°F. = 39.4 **Distillation: IBP = 368°F. 90% = 548°F.**
Cetane No. = 51.5 **10% = 426°F. End Point = 578°F.**
Sulfur = .12% **50% = 488°F. % Return = 98**

II SPECTROCHEMICAL ANALYSIS:

NO CORRECTIVE ACTION INDICATED BY ANALYSIS PERFORMED.

TEST RESULTS INDICATE WEAR METAL LEVELS ARE SATISFACTORY.

Carbon Residue on 10% Bottoms = 0.014 **Water = Nil**
Flash (COC) = 170°F. **Sediment = Nil**
Cloud Point = 0° **Heating Value = 19,797.2 BTU/lb**
136,482 BTU/gal

NOTE: RESULTS OF TESTS PERFORMED ARE WITHIN #2 DIESEL FUEL OIL SPECIFICATIONS.

WHEN CORRECTIVE ACTION IS INDICATED, PLEASE ADVISE RESULTS OF YOUR FINDINGS AND CORRECTIVE ACTION TAKEN ON ENCLOSED POSTCARD.

Since Spectra-Check services are based on samples and information supplied by others, and since corrective action, if any is necessarily taken by others, these services are rendered without any warranty or liability of any kind beyond the actual amount paid to Cleveland Technical Center, Inc. for the services.

PLEASE DIRECT ANY INQUIRIES YOU MIGHT HAVE TO MANAGER - SPECTRA-CHECK SERVICES.

CLEVELAND TECHNICAL CENTER, INC.

13600 DEISE AVENUE
CLEVELAND, OHIO 44110
216-451-6455

F
R
O
M

CLIENT No. **3045-000** ADVISORY No. **145172**

UNIT/N No. **Diesel Fuel** ENGINE SERIAL No. **083161 Pump 7**

SAMPLE DATE **7-22-83** DATE TESTED _____

TYPE SERVICE RENDERED: I II III OTHER

SPECTRA - CHECK®

Kevin R. Boyne
Transportation Research Center
St. Rt. 33 - Logan County
East Liberty, OH 43319

T
O

PHYSICAL TEST RESULTS

FLASH DEGREES F: _____ VISCOSITY SSU 100° F **34.35**

H₂O%: _____ VISCOSITY SSU 210 F _____

DETERGENCY _____ ANTI FREEZE _____

INSOLUBLES NAPHTHA % VOL _____ OIL MI/HR _____
ENG MI/HR _____

I ANALYSIS OF PHYSICAL TESTS:

NO CORRECTIVE ACTION INDICATED BY TESTS PERFORMED.

TEST RESULTS INDICATE OIL CONDITION IS SATISFACTORY.

API Gravity @ 60° F. = 38.1 **Distillation: IBP = 374° F.** **90% = 556° F.**
Cetane No. = 49.5 **10% = 436° F.** **End Point = 578° F.**
Sulfur = 0.15% **50% = 490° F.** **% Return = 98**

II SPECTROCHEMICAL ANALYSIS:

NO CORRECTIVE ACTION INDICATED BY ANALYSIS PERFORMED.

TEST RESULTS INDICATE WEAR METAL LEVELS ARE SATISFACTORY.

Carbon Residue on 10% Bottoms = 0.01% **Water = Trace**
Flash (COC) = 180° F. **Sediment = Trace**
Cloud Point = +8° F. **BTU = 19,764 BTU/lb (137,303 BTU/gal)**

NOTE: RESULTS OF TESTS PERFORMED ARE WITHIN #2 DIESEL FUEL OIL SPECIFICATIONS.

WHEN CORRECTIVE ACTION IS INDICATED, PLEASE ADVISE RESULTS OF YOUR FINDINGS AND CORRECTIVE ACTION TAKEN ON ENCLOSED POSTCARD.

Since Spectra-Check services are based on samples and information supplied by others, and since corrective action, if any is necessarily taken by others, these services are rendered without any warranty or liability of any kind beyond the actual amount paid to Cleveland Technical Center, Inc. for the services.

PLEASE DIRECT ANY INQUIRIES YOU MIGHT HAVE TO MANAGER - SPECTRA-CHECK SERVICES.

Test T-1. Flexible Bus Baseline Test

Test Bus Fuel Consumption (lbs.)

<u>Run No. *</u>	<u>Commuter</u>	<u>Arterial</u>	<u>CBD</u>	<u>Combined</u>
1	10.55	15.10	25.65	51.30
2	10.40	15.40	25.85	51.65
3	10.85	15.30	25.45	51.60
4	10.45	15.45	25.10	51.00
5	10.50	15.40	25.90	51.80
6	<u>11.05</u>	<u>15.30</u>	<u>25.75</u>	<u>52.10</u>
Totals	63.80	91.95	153.70	309.45

Control Bus Fuel Consumption (lbs.)

<u>Run No.</u>	<u>Commuter</u>	<u>Arterial</u>	<u>CBD</u>	<u>Combined</u>
1	11.20	14.60	29.05	54.85
2	11.40	14.85	28.90	55.15
3	11.35	14.75	29.05	55.15
4	10.95	14.50	28.65	54.10
5	11.35	14.90	29.25	55.50
6	<u>11.65</u>	<u>14.95</u>	<u>29.10</u>	<u>55.70</u>
Totals	67.90	88.55	174.00	330.45

Valid T/C Ratios

<u>Run No.</u>	<u>Commuter</u>	<u>Arterial</u>	<u>CBD</u>	<u>Combined</u>
1	.94	1.03	.88	.94
2	.91	1.04	.89	.94
3	.96	1.04	.88	.94
4	.95	1.07	.88	.94
5	.93	1.03	.89	.93
6	.95	1.02	.88	.94

T/C Ratios

Ratio of Totals	.940	1.038	.883	.936
-----------------	------	-------	------	------

* Six valid runs out of a total of 8 runs. Average run time: 95 minutes, 42 seconds.

Test T-2. Flexible Bus at 1.5 X SLW

Test Bus Fuel Consumption (lbs.)

<u>Run No. *</u>	<u>Commuter</u>	<u>Arterial</u>	<u>CBD</u>	<u>Combined</u>
1	11.55	16.50	27.35	55.40
2	11.15	16.50	27.35	55.00
3	11.00	16.20	27.50	54.70
4	10.90	16.50	27.55	54.95
5	10.95	16.50	27.65	55.10
6	10.90	16.50	27.75	55.15
Totals	66.45	98.70	165.15	330.30

Control Bus Fuel Consumption (lbs.)

<u>Run No.</u>	<u>Commuter</u>	<u>Arterial</u>	<u>CBD</u>	<u>Combined</u>
1	11.20	14.80	29.50	55.50
2	11.20	14.60	29.10	54.90
3	11.05	14.80	28.65	54.50
4	11.05	14.65	28.35	54.05
5	11.15	14.80	29.15	55.10
6	11.05	14.85	29.45	55.35
Totals	66.70	88.50	174.20	329.40

Valid T/C Ratios

<u>Run No.</u>	<u>Commuter</u>	<u>Arterial</u>	<u>CBD</u>	<u>Combined</u>
1	1.03	1.11	.93	1.00
2	1.00	1.13	.94	1.00
3	1.00	1.09	.96	1.00
4	.99	1.13	.97	1.02
5	.98	1.11	.95	1.00
6	.99	1.11	.94	1.00

T/C Ratios

Ratio of Totals	.996	1.115	.948	1.003
-----------------	------	-------	------	-------

* Six valid runs out of a total of 8 runs. Average run time: 96 minutes, 29 seconds.

Test T-3. Flexible Bus Empty

Test Bus Fuel Consumption (lbs.)

<u>Run No.*</u>	<u>Commuter</u>	<u>Arterial</u>	<u>CBD</u>	<u>Combined</u>
1	9.70	13.50	22.75	45.95
2	9.60	13.70	22.65	45.95
3	9.80	13.65	22.70	46.15
4	9.80	13.45	22.45	45.70
5	9.55	13.55	22.65	45.75
6	<u>9.70</u>	<u>13.45</u>	<u>23.10</u>	<u>46.25</u>
Totals	<u>58.15</u>	<u>81.30</u>	<u>136.30</u>	<u>275.75</u>

Control Bus Fuel Consumption (lbs.)

<u>Run No.</u>	<u>Commuter</u>	<u>Arterial</u>	<u>CBD</u>	<u>Combined</u>
1	11.20	14.75	29.50	55.45
2	10.85	14.60	29.30	54.75
3	11.15	14.70	29.25	55.10
4	11.20	14.95	29.95	56.10
5	11.20	14.55	29.75	55.50
6	<u>11.20</u>	<u>14.95</u>	<u>29.70</u>	<u>55.85</u>
Totals	<u>66.80</u>	<u>88.50</u>	<u>177.45</u>	<u>332.75</u>

Valid T/C Ratios

<u>Run No.</u>	<u>Commuter</u>	<u>Arterial</u>	<u>CBD</u>	<u>Combined</u>
1	.87	.92	.77	.83
2	.88	.94	.77	.84
3	.88	.93	.78	.84
4	.88	.90	.75	.81
5	.85	.93	.76	.82
6	.87	.90	.78	.83

T/C Ratios

Ratio of Totals	.871	.919	.768	.829
-----------------	------	------	------	------

* Six valid runs out of a total of 6 runs. Average run time: 93 minutes, 52 seconds.

Test T-4. Flexible Bus with 5.375 Axle Ratio

Test Bus Fuel Consumption (lbs.)

<u>Run No. *</u>	<u>Commuter</u>	<u>Arterial</u>	<u>CBD</u>	<u>Combined</u>
1	11.95	14.45	26.20	52.60
2	12.30	14.55	26.40	53.25
3	12.00	14.60	26.90	53.50
4	12.20	14.80	27.30	54.30
5	12.25	14.70	27.25	54.20
6	12.20	14.90	27.85	54.95
Totals	72.90	88.00	161.90	322.80

Control Bus Fuel Consumption (lbs.)

<u>Run No.</u>	<u>Commuter</u>	<u>Arterial</u>	<u>CBD</u>	<u>Combined</u>
1	11.25	15.05	29.60	55.90
2	11.40	14.50	29.90	55.80
3	11.20	15.10	30.00	56.30
4	11.55	14.75	30.30	56.60
5	11.10	15.55	29.80	56.45
6	11.65	15.10	30.10	56.85
Totals	68.15	90.05	179.70	337.90

Valid T/C Ratios

<u>Run No.</u>	<u>Commuter</u>	<u>Arterial</u>	<u>CBD</u>	<u>Combined</u>
1	1.06	.96	.89	.94
2	1.08	1.00	.88	.95
3	1.07	.97	.90	.95
4	1.06	1.00	.90	.96
5	1.10	.95	.91	.96
6	1.05	.99	.93	.97

T/C Ratios

Ratio of Totals	1.070	.977	.901	.955
-----------------	-------	------	------	------

* Six valid runs out of a total of 6 runs. Average run time: 93 minutes, 02 seconds.

Test T-5. Flexible Bus With UEC Transmission (Optional PROM)

Test Bus Fuel Consumption (lbs.)

<u>Run No.*</u>	<u>Commuter</u>	<u>Arterial</u>	<u>CBD</u>	<u>Combined</u>
1	10.60	15.15	27.80	53.55
2	10.65	15.25	27.65	53.55
3	10.60	15.50	28.00	54.10
4	10.65	15.20	27.85	53.70
5	10.35	14.85	27.00	52.20
6	<u>10.65</u>	<u>15.00</u>	<u>27.55</u>	<u>53.20</u>
Totals	63.50	90.95	165.85	320.30

Control Bus Fuel Consumption (lbs.)

<u>Run No.</u>	<u>Commuter</u>	<u>Arterial</u>	<u>CBD</u>	<u>Combined</u>
1	10.85	14.40	30.50	55.75
2	11.65	14.95	29.40	56.00
3	11.40	15.00	29.80	56.20
4	11.35	14.95	30.00	56.30
5	11.15	14.85	29.40	55.40
6	<u>11.35</u>	<u>15.10</u>	<u>29.85</u>	<u>56.30</u>
Totals	67.75	89.25	178.95	335.95

Valid T/C Ratios

<u>Run No.</u>	<u>Commuter</u>	<u>Arterial</u>	<u>CBD</u>	<u>Combined</u>
1	.98	1.05	.91	.96
2	.91	1.02	.94	.96
3	.93	1.03	.94	.96
4	.94	1.02	.93	.95
5	.93	1.00	.92	.94
6	.94	.99	.92	.94

T/C Ratios

Ratio of Totals	.937	1.019	.927	.953
-----------------	------	-------	------	------

* Six valid runs out of a total of 6 runs. Average run time: 92 minutes, 53 seconds.

Test T-6. Flexible Bus With UEC Transmission (Fuel Economy PROM)

Test Bus Fuel Consumption (lbs.)

<u>Run No.*</u>	<u>Commuter</u>	<u>Arterial</u>	<u>CBD</u>	<u>Combined</u>
1	10.45	13.85	26.45	50.75
2	10.45	14.00	26.50	50.95
3	10.50	13.95	26.35	50.80
4	10.60	14.00	26.45	51.05
5	10.40	13.75	26.45	50.60
6	10.55	13.80	26.45	50.80
Totals	62.95	83.35	158.65	304.95

Control Bus Fuel Consumption (lbs.)

<u>Run No.</u>	<u>Commuter</u>	<u>Arterial</u>	<u>CBD</u>	<u>Combined</u>
1	11.25	14.75	29.15	55.15
2	11.35	15.00	29.65	56.00
3	11.35	14.90	29.30	55.55
4	11.35	14.90	29.70	55.95
5	11.10	15.35	29.50	55.95
6	11.15	14.80	29.50	55.45
Totals	67.55	89.70	176.80	334.05

Valid T/C Ratios

<u>Run No.</u>	<u>Commuter</u>	<u>Arterial</u>	<u>CBD</u>	<u>Combined</u>
1	.93	.94	.91	.92
2	.92	.93	.89	.91
3	.93	.94	.90	.91
4	.93	.94	.89	.91
5	.94	.90	.90	.90
6	.95	.93	.90	.92

T/C Ratios

Ratio of Totals	.932	.929	.897	.913
-----------------	------	------	------	------

* Six valid runs out of a total of 7 runs. Average run time: 92 minutes, 28 seconds.

Test T-7. Flexible Bus Baseline Retest

Test Bus Fuel Consumption (lbs.)

<u>Run No. *</u>	<u>Commuter</u>	<u>Arterial</u>	<u>CBD</u>	<u>Combined</u>
1	10.85	15.65	27.15	53.65
2	10.80	15.75	27.15	53.70
3	10.70	15.55	27.10	53.35
4	10.50	15.20	26.85	52.55
5	10.50	15.40	26.85	52.75
6	10.40	15.45	26.85	52.70
Totals	63.75	93.00	161.95	318.70

Control Bus Fuel Consumption (lbs.)

<u>Run No.</u>	<u>Commuter</u>	<u>Arterial</u>	<u>CBD</u>	<u>Combined</u>
1	11.55	15.05	30.15	56.75
2	11.65	15.05	30.25	56.95
3	11.45	15.10	29.95	56.50
4	11.45	14.95	29.20	55.60
5	11.35	14.75	29.60	55.70
6	11.10	14.65	29.25	55.00
Totals	68.55	89.55	178.40	336.50

Valid T/C Ratios

<u>Run No.</u>	<u>Commuter</u>	<u>Arterial</u>	<u>CBD</u>	<u>Combined</u>
1	.94	1.04	.90	.95
2	.93	1.05	.90	.94
3	.93	1.03	.90	.94
4	.92	1.02	.92	.95
5	.93	1.04	.91	.95
6	.94	1.05	.92	.96

T/C Ratios

Ratio of Totals	.930	1.039	.908	.947
-----------------	------	-------	------	------

* Six valid runs out of a total of 6 runs. Average run time: 93 minutes, 20 seconds.

Test I-1. Neoplan Bus With Retarder

Test Bus Fuel Consumption (lbs.)

<u>Run No. *</u>	<u>Commuter</u>	<u>Arterial</u>	<u>CBD</u>	<u>Combined</u>
1	12.95	14.20	31.60	58.75
2	12.60	15.15	31.60	59.35
3	11.65	14.95	32.70	59.30
4	11.00	14.85	33.00	58.85
5	11.80	14.90	32.95	59.65
6	<u>12.20</u>	<u>15.00</u>	<u>33.20</u>	<u>60.40</u>
Totals	72.20	89.05	195.05	356.30

Control Bus Fuel Consumption (lbs.)

<u>Run No.</u>	<u>Commuter</u>	<u>Arterial</u>	<u>CBD</u>	<u>Combined</u>
1	11.40	14.60	28.40	54.40
2	11.20	14.60	29.05	54.85
3	11.40	14.85	28.90	55.15
4	11.35	14.75	29.05	55.15
5	11.35	14.90	29.25	55.50
6	<u>11.65</u>	<u>14.95</u>	<u>29.10</u>	<u>55.70</u>
Totals	68.35	88.65	173.75	330.75

Valid T/C Ratios

<u>Run No.</u>	<u>Commuter</u>	<u>Arterial</u>	<u>CBD</u>	<u>Combined</u>
1	1.14	.97	1.11	1.08
2	1.13	1.04	1.09	1.08
3	1.02	1.01	1.13	1.08
4	.97	1.01	1.14	1.07
5	1.04	1.00	1.13	1.07
6	1.05	1.00	1.14	1.08

T/C Ratios

Ratio of Totals	1.056	1.005	1.123	1.077
-----------------	-------	-------	-------	-------

* Six valid runs out of a total of 7 runs. Average run time: 96 minutes, 37 seconds.

Test I-2. Neoplan Bus Without Retarder (Baseline)

Test Bus Fuel Consumption (lbs.)

<u>Run No. *</u>	<u>Commuter</u>	<u>Arterial</u>	<u>CBD</u>	<u>Combined</u>
1	11.80	15.25	32.95	60.00
2	12.00	15.10	32.60	59.70
3	11.10	14.85	32.15	58.10
4	11.45	14.65	32.60	58.70
5	11.70	14.60	32.50	58.80
6	12.40	14.25	32.70	59.35
Totals	<u>70.45</u>	<u>88.70</u>	<u>195.50</u>	<u>354.65</u>

Control Bus Fuel Consumption (lbs.)

<u>Run No.</u>	<u>Commuter</u>	<u>Arterial</u>	<u>CBD</u>	<u>Combined</u>
1	11.20	14.80	29.50	55.50
2	11.20	14.60	29.10	54.90
3	11.05	14.80	28.65	54.50
4	11.05	14.65	28.35	54.05
5	11.15	14.80	29.15	55.10
6	11.05	14.85	29.45	55.35
Totals	<u>66.70</u>	<u>88.50</u>	<u>174.20</u>	<u>329.40</u>

Valid T/C Ratios

<u>Run No.</u>	<u>Commuter</u>	<u>Arterial</u>	<u>CBD</u>	<u>Combined</u>
1	1.05	1.03	1.12	1.08
2	1.07	1.03	1.12	1.09
3	1.00	1.00	1.12	1.07
4	1.04	1.00	1.15	1.09
5	1.05	.99	1.11	1.07
6	1.12	.96	1.11	1.07

T/C Ratios

Ratio of Totals	1.056	1.002	1.122	1.077
-----------------	-------	-------	-------	-------

* Six valid runs out of a total of 8 runs. Average run time: 96 minutes, 44 seconds.

Test I-3. Neoplan Bus at 1.5 X SLW

Test Bus Fuel Consumption (lbs.)

<u>Run No. *</u>	<u>Commuter</u>	<u>Arterial</u>	<u>CBD</u>	<u>Combined</u>
1	12.00	15.80	32.35	60.15
2	12.15	15.65	33.60	61.40
3	12.00	15.70	33.45	61.15
4	11.90	15.80	34.10	61.80
5	11.90	15.65	33.55	61.10
6	12.00	15.80	34.15	61.95
Totals	<u>71.95</u>	<u>94.40</u>	<u>201.20</u>	<u>367.55</u>

Control Bus Fuel Consumption (lbs.)

<u>Run No.</u>	<u>Commuter</u>	<u>Arterial</u>	<u>CBD</u>	<u>Combined</u>
1	10.85	14.60	29.30	54.75
2	11.20	14.95	29.95	56.10
3	11.20	14.55	29.75	55.50
4	11.20	14.95	29.70	55.85
5	11.25	15.05	29.60	55.90
6	11.40	14.50	29.90	55.80
Totals	<u>67.10</u>	<u>88.60</u>	<u>178.20</u>	<u>333.90</u>

Valid T/C Ratios

<u>Run No.</u>	<u>Commuter</u>	<u>Arterial</u>	<u>CBD</u>	<u>Combined</u>
1	1.11	1.08	1.10	1.10
2	1.08	1.05	1.12	1.09
3	1.07	1.08	1.12	1.10
4	1.06	1.06	1.15	1.11
5	1.06	1.04	1.13	1.09
6	1.05	1.09	1.14	1.11

T/C Ratios

Ratio of Totals	1.072	1.065	1.129	1.101
-----------------	-------	-------	-------	-------

* Six valid runs out of a total of 8 runs. Average run time: 97 minutes, 30 seconds.

Test I-4. Neoplan Bus Empty

Test Bus Fuel Consumption (lbs.)

<u>Run No.*</u>	<u>Commuter</u>	<u>Arterial</u>	<u>CBD</u>	<u>Combined</u>
1	11.00	13.55	29.15	53.70
2	10.90	13.35	29.65	53.90
3	10.85	13.30	29.65	53.80
4	10.95	14.20	29.15	54.30
5	11.10	13.50	29.80	54.40
6	<u>11.10</u>	<u>13.50</u>	<u>29.65</u>	<u>54.25</u>
Totals	65.90	81.40	177.05	324.35

Control Bus Fuel Consumption (lbs.)

<u>Run No.</u>	<u>Commuter</u>	<u>Arterial</u>	<u>CBD</u>	<u>Combined</u>
1	10.85	14.40	30.50	55.75
2	11.65	14.95	29.40	56.00
3	11.40	15.00	29.80	56.20
4	11.35	14.95	30.00	56.30
5	11.05	14.90	29.75	55.70
6	<u>11.35</u>	<u>15.10</u>	<u>29.85</u>	<u>56.30</u>
Totals	67.65	89.30	179.30	336.25

Valid T/C Ratios

<u>Run No.</u>	<u>Commuter</u>	<u>Arterial</u>	<u>CBD</u>	<u>Combined</u>
1	1.01	.94	.96	.96
2	.94	.89	1.01	.96
3	.95	.89	1.00	.96
4	.96	.95	.97	.96
5	1.00	.91	1.00	.98
6	.98	.89	.99	.96

T/C Ratios

Ratio of Totals	.974	.912	.987	.965
-----------------	------	------	------	------

* Six valid runs out of a total of 8 runs. Average run time: 94 minutes, 39 seconds.

Test I-5. Neoplan Bus With Radial Tires*

Test Bus Fuel Consumption (lbs.)

<u>Run No.**</u>	<u>Commuter</u>	<u>Arterial</u>	<u>CBD</u>	<u>Combined</u>
1	10.85	13.90	29.70	54.45
2	10.60	13.85	30.90	55.35
3	11.15	13.40	30.80	55.35
4	10.85	15.00	29.75	55.60
5	10.80	13.60	30.55	54.95
6	10.65	13.60	30.05	54.30
Totals	64.90	83.35	181.75	330.00

Control Bus Fuel Consumption (lbs.)

<u>Run No.</u>	<u>Commuter</u>	<u>Arterial</u>	<u>CBD</u>	<u>Combined</u>
1	11.20	15.10	30.00	56.30
2	11.55	14.75	30.30	56.60
3	11.10	15.55	29.80	56.45
4	11.65	15.10	30.10	56.85
5	11.40	15.15	29.40	55.95
6	11.55	14.70	29.25	55.50
Totals	68.45	90.35	178.85	337.65

Valid T/C Ratios

<u>Run No.</u>	<u>Commuter</u>	<u>Arterial</u>	<u>CBD</u>	<u>Combined</u>
1	.97	.92	.99	.97
2	.92	.94	1.02	.98
3	1.00	.86	1.03	.98
4	.93	.99	.99	.98
5	.95	.90	1.04	.98
6	.92	.93	1.03	.98

T/C Ratios

Ratio of Totals	.948	.923	1.016	.977
-----------------	------	------	-------	------

* Michelin "H", 16-ply rating, regroovable, 12R22.5, XZA.

** Six valid runs out of a total of 6 runs. Average run time: 96 minutes, 32 seconds.

Test I-6. Neoplan Bus With Retarder Retest

Test Bus Fuel Consumption (lbs.)

<u>Run No.*</u>	<u>Commuter</u>	<u>Arterial</u>	<u>CBD</u>	<u>Combined</u>
1	11.90	15.40	33.20	60.50
2	12.00	15.70	33.25	60.95
3	12.00	15.60	33.75	61.35
4	12.00	15.60	33.85	61.45
5	11.85	15.50	32.95	60.30
6	<u>11.70</u>	<u>15.30</u>	<u>32.65</u>	<u>59.65</u>
Totals	71.45	93.10	199.65	364.20

Control Bus Fuel Consumption (lbs.)

<u>Run No.</u>	<u>Commuter</u>	<u>Arterial</u>	<u>CBD</u>	<u>Combined</u>
1	11.10	15.35	29.50	55.95
2	11.15	14.80	29.50	55.45
3	11.65	15.05	30.25	56.95
4	11.45	15.10	29.95	56.50
5	11.10	14.65	29.25	55.00
6	<u>11.05</u>	<u>14.70</u>	<u>28.95</u>	<u>54.70</u>
Totals	67.50	89.65	177.40	334.55

Valid T/C Ratios

<u>Run No.</u>	<u>Commuter</u>	<u>Arterial</u>	<u>CBD</u>	<u>Combined</u>
1	1.07	1.00	1.13	1.08
2	1.08	1.06	1.13	1.10
3	1.03	1.04	1.12	1.08
4	1.05	1.03	1.13	1.09
5	1.07	1.06	1.13	1.10
6	1.06	1.04	1.13	1.09

T/C Ratios

Ratio of Totals	1.059	1.038	1.125	1.089
-----------------	-------	-------	-------	-------

* Six valid runs out of a total of 9 runs. Average run time: 96 minutes, 06 seconds.

11

Limited Warranty

STRATITEC warrants to the original purchaser of this inkjet refill kit that this kit shall be free of defects in assembly, or workmanship, and will repair, or replace, at its option, any defective product free of charge (the "Product Warranty"), subject to the conditions, limitations and exclusions set forth herein.

Conditions and limitations applicable to the Product Warranty are as follows. All costs of shipping the STRATITEC inkjet refill kit and any equipment to and from STRATITEC shall be borne solely by the purchaser. STRATITEC'S LIABILITY IS LIMITED TO REPLACEMENT OR REIMBURSEMENT OF THIS STRATITEC PRODUCT.

The Product Warranty is the only warranty made by STRATITEC. THERE ARE NO OTHER WARRANTIES, EXPRESSED OR, EXCEPT AS REQUIRED BY LAW, IMPLIED, including the implied warranty or condition of quality, merchantability or fitness for particular purpose, and such implied warranties, if any, are limited in duration to twelve (12) months from the date of original purchase. Some states do not allow limitations on how long an implied warranty lasts, so the above limitations may not apply to you. In no event shall STRATITEC be liable for incidental, special, direct, indirect, consequential or multiple damages such as, but not limited to, lost business or profits arising out of sale or use of any STRATITEC inkjet refill kit, even if advised of the possibility of such damages. Some states do not allow the exclusion of implied warranties or exclusion of incidental or consequential damage, in which case the above limitations do not apply to you. Nothing herein shall be construed as an exclusion or limitation of any implied warranties or an exclusion or limitation of any remedies for breach of an implied warranty in those states in which such exclusions and/or limitations are prohibited by state law. If you are an individual and purchased the STRATITEC inkjet refill kit in Kansas, you have rights based on implied warranties and none of the limitations and disclaimers set forth in this paragraph apply to you.

The Product Warranty is valid only for the original end user purchaser of the product. The Product Warranty is valid only to STRATITEC inkjet refill kits purchased and used in the USA.

Stratitec, Inc.
Wichita, KS
316.618.3500

**EASY TO USE
STEP-BY-STEP INSTRUCTIONS
FOR COLOR, BLACK AND
PHOTO INKJET CARTRIDGES**

**QUESTIONS?
CALL OR VISIT OUR WEBSITE FOR
FREE TECHNICAL SUPPORT
316.618.3500
www.stratitec.com**

 **Stratitec®**

**INKJET REFILL
INSTRUCTION
MANUAL**



Quickstart Guide

Get started in three easy steps

Prepare – Read the important information on pages 3, 4, and 5

Refill – Follow the directions on the page for your cartridge

Identify – Find your cartridge on the table of contents on pages 6-7

Need help?

We have you covered: Start with our troubleshooting table on the inside back cover, check www.stratitec.com for updated information, or call tech support at 316.618.3500

This manual is copyright 2003 Stratitec, Inc. Stratitec and the Stratitec logo are registered trademarks, and the Stratitec rainbow mark is a trademark of Stratitec, Inc. HP is a registered trademark of Hewlett-Packard Company. Apple is a registered trademark of Apple Computer, Inc. Canon is a registered trademark of Canon, Inc. Epson is a registered trademark of Seiko Epson Corporation. Lexmark is a registered trademark of Lexmark International, Inc. All other trademarks are registered to their respective owners.

Troubleshooting Table

Problem	Cause	Solution(s)
Leaking sponge-based cartridge	Overfilled cartridge: sponge can't hold all ink	Use syringe to remove excess ink
Leaking Canon chambered cartridge	Leaking or incomplete seal allows ink to slowly drain from cartridge	Make sure holes are smooth and plugs are tight Consider enlarging hole and using larger plug
Leaking HP black cartridge	Cartridge not pressurized properly	Repeat pressurization steps
Drips of ink on paper	Overfilled cartridge: ink pooling on print head	Use syringe to remove excess ink
Printing only on part of a line or page	Overfilled cartridge: ink pooling on print head	Use syringe to remove excess ink
Unsatisfactory print results or incorrect colors	Color contamination, often caused by overfilled cartridge	Print many pages of solid colors Prime the cartridge
Streaky prints	Clogged nozzles	Prime the cartridge or print head
No printing	Vacuum forming in a sponge-based cartridge, such as HP 17/23/25/78	Remove extra plugs or tape applied to the cartridge, but not required in instructions
No printing	Overfilled cartridge: ink droplets pool and can't reach paper	Use syringe to remove excess ink
Printer stops printing after sitting for a few days	Overfilled cartridge: excess ink seeps onto print head and dries	Clean print head and use syringe to remove excess ink
Cartridge empty after sitting for a few days	Incomplete seal allows ink to drain slowly	Reseal cartridge
Can't inject enough ink into the cartridge	Air is not able to escape as ink is injected	Seal cartridge openings. Use syringe and small priming tip to pull air out and allow resulting vacuum to pull ink in

Troubleshooting Table

Problem	Cause	Solution(s)
Poor print quality	Old cartridge	Use only recently-emptied cartridges for best results
Printer lights flash, indicating error	Incorrectly inserted cartridge, or cartridge contacts are dirty	Remove and reinstall cartridge Clean contacts with a damp paper towel
Canon cartridges run out quickly after refill	Cartridges contain "fuzz" instead of sponge and can't reabsorb ink well	Refill frequently Use "compatible" ink cartridges containing sponges
Prints have scattered droplets	Slightly-overfilled cartridge: ink droplets not forming properly	Print solid pages of black and/or color to clear overflow condition
Black and white photos have color tint	Color balance not perfectly matched	Use software to add counter-tint before printing
Cracked or wrinkled prints	Paper quality low or paper setting incorrect	Use high-quality paper Try another brand or type of paper
Cannot remove top of cartridge	Securely attached cartridge top	Drill through top to reach sponges inside cartridge
Ink levels report empty	Ink tracking indicates cartridge should be empty	Keep printing anyway Reset ink levels on HP cartridges, or in Lexmark drivers
After refill, Epson still reports cartridge empty	Smart chip reports empty cartridge, needs to be reset	Buy and use a chip reset device, or check for options at www.stratitec.com
Cartridge not listed	Most cartridges will work, but instructions may not be available	Check www.stratitec.com for instructions, then check www.google.com
Ink stains	Spilled ink	Wash with soap and water. Skin will wash clean in a few days.

Tool Identification and Reference



Cartridge Opening Tool

The cartridge opening tool is used to remove the top from specific HP and Lexmark color cartridges.



Cartridge Refill Clip with Rubber Tip

The cartridge refill clip is used to refill and prime HP 15 and 45 style cartridges. It doubles as a priming and evacuating tool for HP 17, 23, 25 and 78 type cartridges.

Note: If not pre-assembled, insert the rubber tip into the hole at the base end of the clip.



Small Plug

The small plug has an extended top for easy handling and insertion. The low-profile small plug (below left) is used when the plug must be nearly flush with the surface of the cartridge.



Low-Profile Small Plug

Note: Plugs may come in a sheet (as shown at left). Pull firmly to remove them for use.



Large Plug

The large plug is used for the pre-existing holes in some cartridges. The large plug can also be used to make a tight seal when a small plug does not seal properly.



Screw Tool

The screw tool is used to remove plugs and enlarge refill holes.



Drill Bit

The drill bit is used to enlarge or create new refill holes. Apply firm pressure when drilling to minimize debris and to make drilled holes smooth for a proper seal.



Large Priming Tip

The large priming tip is used to prime print heads and cartridges. It fits on the end of an empty syringe, and can draw ink, air, or clogs from the cartridge or print head.



Small Priming Tip

The small priming tip is used for priming individual nozzles. It may also be used to create pressure or a vacuum in certain cartridges.



Rubber Sealing Pad

The rubber sealing pad is used to temporarily seal a vent hole or ink outlet. Apply the smooth side of the rubber to the surface to be sealed and maintain pressure with a thumb or forefinger.

General Refill Guidelines

⚠ SAFETY WARNING: INK IS NONTOXIC BUT IS NOT SUITABLE FOR INGESTION. Successfully refilling ink cartridges may take some practice, but the process gets easier each time. It is extremely important that you read these refill guidelines and the instructions for your cartridge carefully to ensure desired results and avoid mishaps.

Prepare a Work Area



- ✓ Refill cartridges in an area that is well-suited for the work.
- ✓ Ink may spill; place a large sheet of aluminum foil and/or a thick pile of newspaper on your work surface.
- ✓ Keep distractions to a minimum.
- ✓ Use a workbench and wear an apron or older clothes in case of a spill.
- ✓ Wear plastic gloves to protect your hands from ink stains.
- ✓ Clean up immediately with soap and water.
- ✓ Ink on hands or arms will wash off in a few days.
- ⚠ Do not refill over carpeted areas or near fine furniture.

Use Recently Emptied Cartridges



- ✓ Always refill inkjet cartridges just before or immediately after they run out of ink.
- ✓ Do not leave cartridges out of the printer for more than an hour.
- ⚠ Old and/or dry cartridges may not work, even after refilling, priming and cleaning.
- ⚠ When the cartridge is allowed to remain empty for long periods of time, the ink in the ink supply outlets or print heads will dry out, making it difficult to successfully refill the cartridge.

Know The Colors



- ✓ Inkjet printers require special colors to produce high-quality printouts. Two of these colors are blends: "cyan," similar to light blue, and "magenta," similar to purple-red.
- ✓ Many inkjet printers require, or can use, "photo" cartridges that include light or "photo" cyan and magenta. These are called "six-color" printers.
- ⚠ Photo cyan and photo magenta inks are only for six-color printers. They are not intended for use in standard four-color printers, even when printing photos. If photo cyan and/or photo magenta are used in a standard four-color printer, the color balance will be incorrect and the quality will be reduced.

Check and Correct Overfill

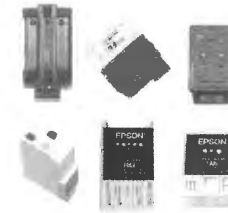

It's easy to overfill some cartridges, especially multi-chambered color cartridges with opaque plastic. Many popular cartridges, such as the HP 17/23/25/78 and 28/57/58 types, Lexmark 20/65/80/90 and 26/83 types, Canon BCI-21/24 and virtually all Epson types are constructed in this manner.

In multi-chambered cartridges, colors are used at different rates, and there is no way to tell how much ink remains in any given chamber. This makes it easy to overfill at least one color. It is very important to carefully check for and correct any possible overfill condition.

Epson and Canon:



1. Epson and most Canon color cartridges do not have built-in print heads. (For older Canon cartridges with built-in heads, please follow the HP and Lexmark instructions below.)
2. After filling, let the cartridge sit upright on a thickly folded stack of paper towels for about 5 minutes. This lets ink soak into the internal sponge and excess ink to run from the bottom of the cartridge.
3. Flip the cartridge upside-down and place it on a thickly-folded stack of paper towels for 5-10 minutes to allow any remaining excess ink to drain into the towels.
4. Repeat with fresh paper towels until no more ink drains from the cartridge.

HP and Lexmark:



1. These cartridges contain a built-in print head. After filling the cartridge, wipe the print head with a damp paper towel. Ink from each color in the cartridge should soak into the paper towel. If all the ink colors do not appear on the paper towel, the print head may be clogged, making it hard to detect an overfill condition for the clogged color. When the clog clears, excess ink may flow out quickly and contaminate other colors.
2. Use the clip tool for large HP cartridges, and the large priming tip for all others. Once you are sure that the seal is tight, draw from the cartridge until ink begins to flow into the syringe. Never push ink back into a color cartridge.
3. After you have finished, wipe the head and contacts with a damp paper towel.
4. Place the cartridge into your printer and run test/cleaning cycles as described in your printer manual.



Cartridge Top Removal

Cartridge Top Removal Tool:



1. The cartridge top removal tool is designed for specific HP and Lexmark color cartridges.
2. Prepare the tool by turning the handle counter clockwise to make sure the removal bar and wedge are out of the way.
3. If removing the top from an HP cartridge, fit the insert spacer into the tool (see photo at left).
4. Insert the cartridge into the tool with the front label facing out, as shown. The edges of the cartridge top should slide snugly into the grooves in the tool.
5. Turn the handle clockwise to apply pressure to the cartridge top. This will push against the cartridge top as the wedge separates the top from the base.
6. Continue turning the handle firmly until the top cracks or pops loose. Loosen the handle and remove the cartridge.
7. Use a flat screw driver or pliers if necessary to completely remove the top from the cartridge.

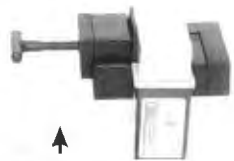
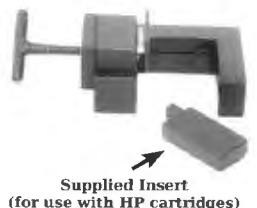

Turn Handle clockwise to apply pressure

Alternate methods

1. If the top removal tool does not work for your cartridge, try to remove the top with a screw driver or with large pliers (see photos, below). Please use care when using tools.
2. Some cartridge tops are very securely attached and cannot be removed. If this is the case, drill through the top to make a filling hole for each color. Refer to the color location diagrams included with the specific instructions for your cartridge, and drill straight down into the center of each color area. Be very careful to avoid overfilling, as ink may overflow into other color chambers under the lid.

Alternate Methods



⚠ WHEN USING CUTTING OR DRILLING EQUIPMENT, WEAR SAFETY GOGGLES AND FOLLOW ALL OPERATING AND SAFETY INSTRUCTIONS FOR YOUR EQUIPMENT.

Use Colors Correctly



- ✓ Be careful with colors. Inject ink into the correct color chamber.
- ✓ Before refilling, always verify the ink colors by inserting a wooden toothpick into each refill hole, withdrawing it, and checking the color.
- ⚠ Injecting the wrong ink into the cartridge chamber will cause unfavorable print results and incorrect color.

Prepare Ink and Syringes



- ✓ Unused ink may be stored in syringes. Be sure to label the syringes with the included color identification labels and replace the scabbard on the tip of the needle.
- ✓ Attach the needles securely to each syringe.
- ✓ Use the large syringe for black ink.
- ✓ Do not open bottles or fill syringes with ink until needed.
- ⚠ Be sure to rinse needles and syringes thoroughly before changing from cyan to photo cyan, or magenta to photo magenta, to avoid color contamination.

Do Not Remove Seal



- ✓ To reduce the chance of a spill, do not remove the bottle seal.
- ✓ Use the needle or the screw tool to create a small hole in the seal.
- ✓ Draw the ink into the syringe through the small hole.
- ✓ Keep the lids on the bottles when not in use.

Avoid Overfilling



- ✓ Take care to avoid overfilling cartridges, as they will not print if overfilled.
- ✓ Use only enough ink to fill the cartridge.
- ✓ Remove any excess ink with the syringe if overfilled.
- ⚠ Never install a leaking, dripping, seeping, or oozing cartridge into a printer.
- ⚠ Overfilled cartridges may leak and cause color contamination.

Alphabetical Index

Apple®

M1949.....18
M1950.....18
M1951.....18
M1952.....18
M3240.....19
M3329.....20
M3330.....20
M3822.....18
M3852.....18
M3908.....20
M3909.....20
M3910.....20
M3911.....20
M3912.....20
M4609.....22
M5658.....8
M5659.....8
M5693.....12
M5694.....11
M8041.....21
M8049.....21
M8052.....21

Brother®

IN-700.....16
IN-710C.....17
IN10.....21
LC02BK.....26
LC02C/Y/M.....26
LC04BK.....26
LC04C/Y/M.....26
LC11-BK.....16
LC21BK.....26
LC21C/Y/M.....26

Canon®

BC-01.....21
BC-02.....21
BC-05.....22
BC-20.....19
BC-23.....19
BC-30/BC-30e.....18
BC-31/BC-31e.....18
BCI-10.....20
BCI-11.....20
BCI-21.....20
BCI-24.....20
BCI-3Bk/BCI-3eBk.....18
BCI-3C/BCI-3eC.....18
BCI-3M/BCI-3eM.....18
BCI-3PC/3PM.....18
BCI-3Y/BCI-3eY.....18
BCI-5Bk.....18
BCI-5C/BCI-5M/BCI-5Y.....18
BCI-60.....27
BCI-61.....27
BCI-6Bk.....18
BCI-6C/BCI-6M/BCI-6Y.....18
BCI-6PC/BCI-6PM.....18
BCI-8Bk.....18
BCI-8C/BCI-8M/BCI-8Y.....18
BD-33e.....27

BJI-201Bk(HC).....18
BJI-201C/BJI-201M/BJI-201Y.....18
BK-2.....21
BK-3.....21

Compaq®

180844-001.....17
180845-001.....16
180846-001.....17
180847-001.....16
180848-001.....17
203428-001.....16
337709-001.....16
337710-001.....17
337711-001.....17
337714-001.....16
337715-001.....17
LC11-CL.....17

DEC®

LJ50X-AC.....20

Epson®

S020034.....27
S020036.....27
S020047.....24
S020049.....24
S020062.....27
S020089.....23
S020093.....23
S020097.....24
S020108.....23
S020118.....27
S020122 (Y).....27
S020126 (M).....27
S020130 (C).....27
S020138.....24
S020143.....27
S020147.....27
S020187.....23
S020189.....23
S020191.....23
S020193.....25
T001/T001011.....25
T003.....23
T005.....23
T007*/T007201*.....23
T008*/T008201*.....25
T009*/T009201*.....25
T013.....23
T014/T014201.....23
T015*.....23
T016*/T016201*.....25
T017*/T017201*.....23
T018*/T018201*.....23
T019.....23
T020.....23
T026*.....23
T027*/T027201*.....25
T028*.....23
T029*.....23
T036.....27
T037.....27
T040*/T040120*.....25

Resetting Ink levels in HP printers

Hewlett-Packard: 15•17•23•41•45•78

Most printers only remember the last two cartridges (of each color) used in the printer. If you have two extra cartridges (these can be old and non-functional), simply install them in the printer, one after the other, and then re-install the refilled cartridge for 100% ink levels. If extra cartridges are not available, most printers can be reset to 100% ink levels with the following procedure:



↑
Tape over left contacts first.

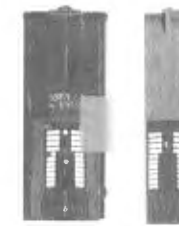

↑
Then tape the right contacts.

1. Pull the cartridge(s) out of the printer and face them as shown at left (one or both cartridges may be reset at the same time with this procedure).
2. Place a piece of tape so that it just covers the top four contacts on the left side of the contact area, as shown.
3. Re-install the cartridges with the tape in place.
4. Close the printer and wait approximately five seconds.
5. Open the printer and wait for the printer carriage to present the cartridges. This may take some time, and the printer lights may flash indicating an error. This is normal.
6. Remove the cartridges and move the tape to the other side as shown, below left.
7. Re-install the cartridges once more, with the tape in place.
8. Close the printer and wait approximately five seconds.
9. Open the printer and wait for the printer carriage to present the cartridges. This may take some time, and the printer lights may flash indicating an error. This is normal.
10. Remove the cartridges and remove all the tape. Be sure the contacts are clean.
11. Re-install the cartridges. Ink levels should now read 100%. If they do not, repeat the procedure, covering only the top three contacts. If ink levels still do not read 100%, repeat the procedure, covering only the top two contacts.

General Cartridge Priming

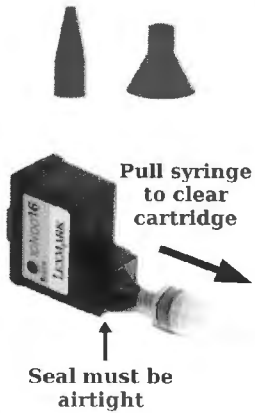

1. Use the priming tools provided in the refill kit. Begin by attaching the small or large suction tip to a clean syringe.
2. The large suction tip is for priming an entire print head. To use it, you must press the large end to the outlets on your print head, forming an airtight seal. Apply suction to the print head until ink or ink bubbles appear in the syringe. If you cannot establish an airtight seal, you may need to trim the priming tip to better fit the size of your print head.
3. If you are priming a color cartridge, visually inspect the color of the ink in the syringe. This may indicate which colors are flowing through the print head properly.
4. Wipe the print head with a damp paper towel and examine the nozzles (the tiny holes on the print head). Press the print head to a damp paper towel, and then to a dry one and examine the uniformity. Do the nozzles appear clear of debris? Do they seem to be uniformly releasing ink?
5. The small suction tip is for priming individual nozzles. It is used in much the same way as the larger tip, but it is designed to target specific nozzles that need to be primed.
6. Press the tip lightly over the clogged nozzles and draw the syringe. You should feel some resistance or see ink flow if you are making a good seal with the surface. If you see the wrong color of ink, then you may be missing the targeted nozzle. Adjust the position of the syringe and try again.
7. After you have finished, clean the head and contacts with a damp paper towel. Place the cartridge into your printer and run test/cleaning cycles as described in your printer manual.

Refill Tip: The small priming tip may also be used in conjunction with a rubber square to remove air from a cartridge so more ink can be injected. To do this, seal the print head and push the small tip into the refill hole. Extract air and bubbles of ink. Release pressure and fill with ink per specific cartridge instructions, then prime cartridge again.



T041*/T041020*	25	13619HC	17
T480/T480011	27	13620HC	16
T481/T481011	27	1380619	17
T482/T482011	27	1380620	16
T483/T483011	27	1381400	16
T484/ T484011	27	1382050	16
T485/T485011	27	1382060	17
Hewlett-Packard®			
51625 (25)	11	15M0120 (20)	17
51626 (26)	12	15M0125 (25)	17
51629 (29)	12	16C0055 (55)	16
51633 (33)	12	16C0065 (65)	17
51640 (40)	8	17G0050 (50)	16
51641 (41)	9	17G0060 (60)	17
51644C/51644M/51644Y	8	181.0032 (82)	14
51645 (45)	8	18L0042 (83)	15
51649 (49)	11	Misc	
51650C/51650M/51650Y	8	Cartridge Top Removal	32
C1816 (16)	11	Check and Correct Overfill	33
C1816A (16)	11	General Cartridge Priming	30
C1823 (23)	9	HP Cartridge Priming	29
C3844A (844)	9	Tri-color Cartridge Troubleshooting	28
C3845A (845)	9	Okidata®	
C4836	27	52109301	16
C4837	27	52109302	17
C4838 (11)	27	Olivetti®	
C4841	27	84433S	17
C4842	27	84433S (Black)	16
C4843	27	JP150-450	11
C4844 (10)	27	JP470	17
C5010AN (14)	13	JP470 (Black)	16
C5011AN (14)	13	JP790	17
C6578 (78)	9	JP790 (Black)	16
C6614 (20)	12	JP795	17
C6615 (15)	8	JP795 (Black)	16
C6625 (17)	9	JP883	17
C6628 (19)	12	JP883 (Black)	16
C6634 (34)	11	Panasonic®	
C6635 (35)	11	(various)	19
C6656 (56)	10	Sharp®	
C6657 (57)	10	AJ-C50B	16
C6658 (58)	10	AJ-C50C	17
C8727 (27)	10	Sony®	
C8728 (28)	10	IJC-BL	12
Lexmark®			
10N0016 (16)	14	IJC-CI	11
10N0026 (26)	15	Xerox®	
12A1970 (70)	16	8R12591	17
12A1975 (75)	16	8R7879	16
12A1980 (80)	17	8R7880	17
12A1985 (85)	17	8R7881	16
12A1990 (90)	17	8R7882	17
13400HC	16	8R7903	14
1361400	16	8R7904	15
1361760	17	Other Cartridges.....online at www.easyinkjetrefill.com	

* Ink is compatible with this cartridge, but cartridge may require a smartchip reset to print. See www.stratitec.com for details.

Recommended Tools



Hewlett Packard: 51645 (45)•51640 (40)•C6615 (15)
 •51644C/51644M/51644Y•51650C/51650M/51650Y
Apple: M5658•M5659 (Letters at end of part number may vary.)



Snap cartridge into cartridge refill clip



Ensure that syringe tip is secure



Inject ink slowly



Step 7: Tip upright and withdraw air to balance pressure

1. Read pages 4-5 for important general information that will greatly improve your results.
 2. Assemble the cartridge refill clip by fitting the rubber tip into the base of the refill clip, as shown (top left).
 3. Place the ink cartridge in the cartridge refill clip by placing the print head against the flat surface of the rubber tip and pressing the cartridge firmly into the clip until it snaps into place.
 4. Make sure that the print head is aligned with the filling hole in the rubber tip and that it fits flush against the base of the clip. If necessary, adjust the cartridge by laying it on a flat, hard surface and pressing down firmly, or by reinserting the cartridge.
- Note:** If this is the first refill of the cartridge, attach the syringe as shown at left, and use it to remove and discard any ink remaining in the cartridge. Mixing the original ink and the refill ink may reduce print quality.
5. Fill the large syringe with the appropriate color of ink and then carefully remove the needle.
 6. Attach the syringe to the rubber tube coming from the end of the tool. Make sure that the syringe is securely attached before injecting ink into the cartridge. Syringe styles may vary.
 7. After the ink has been forced into the cartridge, you must balance the pressure in the cartridge by extracting any remaining air. Rotate the cartridge clip until the print head and syringe are upright, then slowly withdraw the plunger until 3ml of ink is drawn back into the syringe.
 8. Once cartridge is refilled, remove it from the refill clip and clean the print head and contacts with a damp paper towel.
 9. Confirm that no ink is dripping from the print head. If the print head is leaking, repeat step 7.
 10. Re-install the cartridge and run cleaning cycles. Please read the section on "Resetting Ink Levels" on page 31.

Note: Refill ink cartridges promptly. If necessary, refilled cartridges may be stored in a sealed plastic bag.

Troubleshooting: If you followed the instructions carefully but need additional help, please review pages 34-35.

HP Cartridge Priming

Sometimes, when the cartridge has run dry, one or more colors will not print, even after refilling. To fix this, prime the cartridge with the following steps.



Clip cartridge in place



Check that the head is centered on the rubber pad

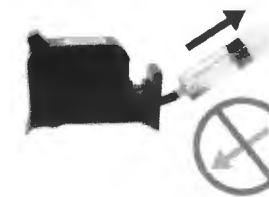

Never push ink back into a color cartridge



Ensure that the seal is tight

Note: syringe tip style may vary. Push rubber tip onto syringe as far as possible.

1. Insert the cartridge into the HP Clip tool. Attach a clean syringe to the rubber tube coming from the end of the tool. Make sure that the syringe is threaded tightly before proceeding.
2. Once you are sure that the seal is tight, draw from the cartridge until ink begins to flow into the syringe. (Never push ink back into a color cartridge)
3. After you have finished, take the cartridge out of the refill clip tool and clean the head, contacts, and clip tool with a damp paper towel.
4. Place the cartridge into your printer and run test/cleaning cycles as described in your printer manual.
5. If printouts are still streaky, use the large and/or small priming tip as described on page 30.
6. If colors are muddy or incorrect, please read the tri-color cartridge information on page 28.

HP Printer Maintenance Codes

Make/Model Series	Task Performed	Sequence Code	Sequence Description (Hold down the Power button and..)
HP / 9XX / 8XX	Light Clean	20 Tap	Tap Cancel twice
HP / 9XX / 8XX	Intermediate	21 Tap	Tap Cancel twice, then Resume once
HP / 9XX / 8XX	Prime	22 Tap	Tap Cancel twice, then Resume twice
HP / 9XX	Self Test	84 Tap	Tap Cancel 8 times, then Resume 8 times
HP / 8XX	Self Test	4 Tap	Tap Resume 4 times
HP / 6XX / e20	Pen Clean	7 Tap	Tap Resume 7 times

For more information visit: hpinkjet.sourceforge.net/pencleaning.php
 Note: This web page is not affiliated with Stratitec, Inc.

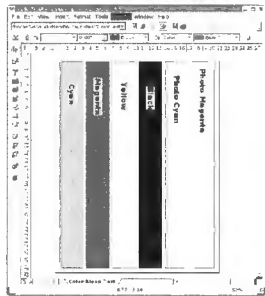

Figure 1: Example test page created in OpenOffice.org's Draw program. You will find a link to download this test document at the following address: www.stratitec.com/inkrefill/support/

If you don't have OpenOffice.org, visit www.openoffice.org to download the free application and install it. You will need this program to open the test page.

You may generate your own test page using any paint or draw program available on your system.

Tri-color Cartridge Troubleshooting:

Unsatisfactory print results or incorrect colors using color HP or Lexmark cartridges

1. Ink contamination will cause the printer to produce off-color output.
2. Contamination usually occurs when one or more colors have been overfilled, and can occur even if overfilling was not obvious. The overfilled color forms a small ink drop on the print head. The sponges containing the other colors wick the overfilled color up into their chambers. This causes the overfilled color to combine with and contaminate other colors.
3. In some cases, contamination can be caused by failure to sufficiently wash the needle and syringe or by accidentally injecting the wrong color. The procedure below may not resolve color contamination due to these errors. If these are the cause of your color contamination, please follow the Cartridge Priming Procedures on page 29 to purge your cartridge, then refill the cartridge again, using the appropriate instructions.
4. To resolve ink contamination caused by overfilling, download the color test page from www.stratitec.com/inkrefill/support/. This test page uses the color management capabilities of a free software package called OpenOffice.org. If you do not have OpenOffice.org installed, visit www.openoffice.org for a free download of the latest version. OpenOffice.org is compatible with virtually all modern operating systems.
5. Print the test image repeatedly until the colors print properly. The number of prints required depends upon the degree of contamination.

Note: The OpenOffice.org Draw application is used for this color page because it allows "pure" colors to be printed. You can create a similar test page in any available drawing or graphics program, but your color purity may vary.



Hewlett-Packard: C3844A (844)•C3845A (845)
51641 (41)•C1823 (23)•C6578 (78)•C6625 (17)

1. Read pages 4-5 for important general information that will greatly improve your results.
2. Locate the filling hole plugs on the top of the cartridge (position may vary). Push the plugs into the cartridge with the screw tool. Leave the plugs inside the cartridge. If your cartridge does not have plugs, or if you cannot push them in, drill holes where shown with the included 3mm drill bit.

Note: Before refilling, always verify the ink colors by inserting a toothpick into each hole and checking the color.

3. Select a color and fill a syringe with ink. Insert the needle into the correct refill hole, working it past the plug, until the tip is halfway into the foam sponge, then position the cartridge horizontally, as shown below.
4. **Slowly** inject 3-10ml of ink. Injecting ink too quickly may trap air inside the cartridge. As you add ink, watch the print head closely. If ink begins to come out of the print head or around the filling hole, stop filling, then use the syringe to extract about 1ml of ink.
5. Leave the cartridge in the horizontal position as shown below. Repeat the previous steps to fill each color in the cartridge.
6. Verify ink flow by pressing the print head against a damp paper towel. Each color should leave a solid line on the towel. If not, follow the instructions on page 29 to prime the cartridge.
7. **IMPORTANT:** This cartridge is easy to overfill. Check for overfilling by following the instructions on page 33.
8. Re-install the cartridge and run cleaning cycles. Please read the section on "Resetting Ink Levels" on page 31. If print results are unsatisfactory or colors are incorrect, please read "Tri-Color Cartridge Troubleshooting" on page 28.

Note: For best results, refill cartridges before they are empty.

Troubleshooting: If you followed the instructions carefully but need additional help, please review pages 34-35.

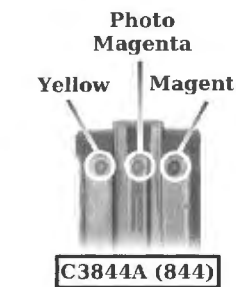
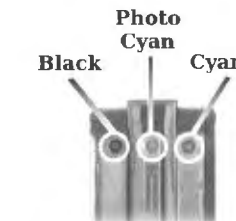
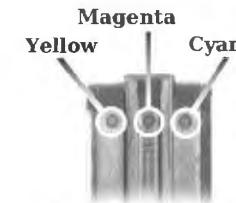

Important: The fill holes must stay open. Do NOT plug or tape over the fill holes after filling.

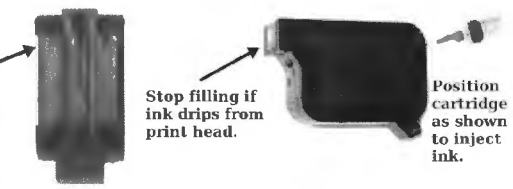

Recommended Tools



Hewlett-Packard: C8727 (27)•C8728 (28)•C6656 (56)•C6657 (57)
•C6658 (58)



1. Read pages 4-5 for important general information that will greatly improve your results.
2. To access filling holes, remove the sticker from the cartridge top. If refilling a color cartridge, select a color and fill a syringe with ink. Tape over unused filling holes to prevent ink from contaminating the other ink colors.
3. Carefully insert the needle into the correct filling hole until the tip is halfway into the foam sponge.
4. Position the cartridge horizontally as shown (above left). **Slowly** inject 3-5ml of color ink or 10-20ml of black ink. Injecting ink too quickly may trap air inside the cartridge. As you add ink, watch the print head closely. If ink begins to come out of the print head or around the filling hole, stop filling, then use the syringe to extract about 0.5ml of ink.
5. Refill each color by repeating the above process, making sure to tape over the unused refill holes.
6. Verify ink flow by pressing the print head against a damp paper towel. Each color should leave a solid line on the towel. If not, follow the instructions on page 30 to prime the cartridge.
7. **IMPORTANT:** This cartridge is easy to overfill. Check for overfilling by following the instructions on page 33.
8. Once cartridge is refilled, install it and print a few test pages. If print results are unsatisfactory or colors are incorrect, please read "Tri-Color Cartridge Troubleshooting" on page 28.

Troubleshooting: If you followed the instructions carefully but need additional help, please review pages 34-35.

Black



C6656 (56)
C8727 (27)

Magenta



Yellow Cyan

C8728 (28)
C6657 (57)

Photo Magenta



Black Photo Cyan

C6658 (58)

More Instructions Available at www.easyinkjetrefill.com



Hewlett Packard:

C4841•C4842•C4843•C4844 (10)
C4836•C4837•C4838 (11)



Canon:

BCI-60•BCI-61•BD-33e

Epson:

S020122 (Y)•S020130 (C)•S020126 (M)•S020062•S020118
S020034•S020036•S020143•S020147
T480/T480011•T481/T481011•T482/T482011•T483/T483011
T484/T484011•T485/T485011•T036•T037

Other/New:

Many others

Recommended Tools



Brother:
LC02BK•LC02C/Y/M•LC04BK•LC04C/Y/M•LC21BK•LC21C/Y/M



Release clip with screw driver



Refill hole
Vent hole



Enlarge refill hole with screw tool and inject ink.

1. Read pages 4-5 for important general information that will greatly improve your results.
2. Tightly seal the ink outlet on the bottom of the cartridge with tape.
3. Place the cartridge on a flat, ink-resistant surface or on paper towels or absorbent cloth in case of spills or leakage. Use a small screw driver to pry the lid from the cartridge (as shown at left). The lid is easy to remove once the screw driver has pulled back the clip.
4. Study the two lower photos carefully and note that there are two holes under the seal. Use the screw tool to make a hole in the foil covering the refill hole (as shown, bottom left) large enough for the needle to pass freely.
5. Carefully insert the needle through the refill hole and into the cartridge as far as possible, then **slowly** inject 6-8ml of ink. As you add ink, watch the print head closely. If ink begins to come out of the print head or around the filling hole, stop filling, then use the syringe to extract about 0.5ml of ink.
6. Carefully wipe the area around the refill hole until it is dry, then apply an adhesive tape dot (included) or strong adhesive tape to form an airtight seal.
7. Remove the tape covering the outlet on the bottom of the cartridge.
8. Allow the cartridge to sit in a metal or stainless steel sink or pan for 10-20 minutes. The cartridge should not leak. If ink seeps or leaks from the cartridge, check the seal on the refill hole and make sure it is airtight.
9. When you have verified that the cartridge is not leaking, re-install the cartridge, run the cleaning cycles, and print test pages.

Troubleshooting: If you have followed the instructions carefully but need additional help, please review pages 34-35.

Recommended Tools

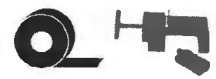

Hewlett-Packard: 51625 (25)•51649 (49)•C6634 (34)•C6635 (35)
•C1816 (16)•C1816A (16) **Apple:** M5694 **Sony:** IJC-C1
Olivetti: JP150-450
[6-8ml per color]

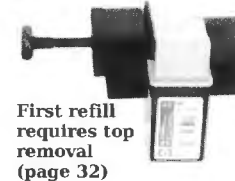

First refill requires top removal (page 32)



Detached top looks like this

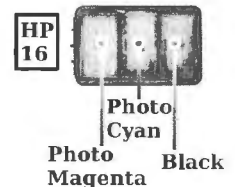
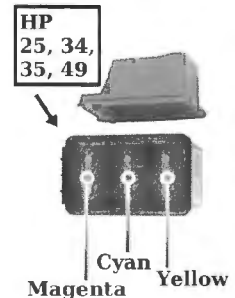

1. Read pages 4-5 for important general information that will greatly improve your results.
2. If this is the first refill, the cartridge top must be removed. Please read the instructions on page 32 for instructions.
3. Once the top has been removed, place the cartridge on paper towels or or absorbent cloth in case of spills or leakage, and position it horizontally. Select a color and fill a syringe with ink (see photos with color identification, below left). Tape over unused filling holes to prevent ink from contaminating the other ink colors.
4. Carefully insert the needle into the correct filling hole until the tip is halfway into the foam sponge.
5. **Slowly** inject 3-8ml ink. Injecting ink too quickly may trap air inside the cartridge. As you add ink, watch the print head closely. If ink begins to come out of the print head or around the filling hole, stop filling, then use the syringe to extract about 1ml of ink.
6. Leave the cartridge the horizontal position as shown below. Refill each color by repeating the above process, making sure to tape over the unused refill holes.
7. Verify ink flow by pressing the print head against a damp paper towel. Each color should leave a solid line on the towel. If not, follow the instructions on page 30 to prime the cartridge.
8. **IMPORTANT:** This cartridge is easy to overfill. Check for overfilling by following the instructions on page 33.
9. Once the cartridge is refilled, tape the cartridge cover securely in place, re-install the cartridge, run the cleaning cycles, and print test pages.

Note: For best results, refill cartridges before they are empty. If print results are unsatisfactory or colors are incorrect, please read "Tri-Color Cartridge Troubleshooting" on page 28.

Troubleshooting: If you followed the instructions carefully but need additional help, please review pages 34-35.

Recommended Tools

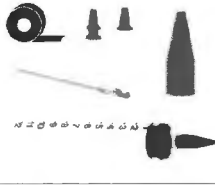

Hewlett Packard: 51626 (26)•51629 (29)•51633 (33)•C6614 (20)
•C6628 (19) **Apple:** M5693 **Sony:** IJC-BI (Suffix may vary)

1. Read pages 4-5 for important general information that will greatly improve your results.
2. Cover the "ballast hole" in the center of the arrow on the cartridge lid with tape to preserve current pressure before filling (see photo).
3. Unplug the refill hole on the top of the cartridge (see note, below) and inject 15-20ml of ink.

Note: Some cartridges do not have a fill hole. Use a 3mm drill bit to make a hole in the position shown. Older cartridges may have a refill hole on the top that is sealed by a ball bearing. Push the ball bearing into the cartridge, taking care not to damage the print head while doing so.

Vent Maze



Ballast Hole

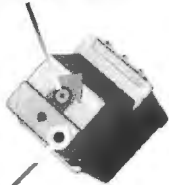

Fill Hole



Align tip carefully

4. Once the cartridge is refilled, seal the refill hole with a rubber plug. Do not use tape. Be sure the seal is airtight, or the cartridge will leak.
5. The pressure in the cartridge must be equalized. Place the cartridge in an upright position in a small pan or in a sink, as equalizing the cartridge causes ink to drain from the vent maze.
6. Place a small rubber priming tip (page 3) on a clean, empty syringe and draw 4ml of air into the syringe. Remove the tape from the ballast hole and carefully align the opening of the rubber tip over the ballast hole, creating an airtight seal. Inject air into the ballast hole, then hold the syringe place for 20 seconds, maintaining an airtight seal. Several ml of ink should flow out through the vent maze as the cartridge pressure equalizes.
7. Clean the cartridge thoroughly and look closely to see if ink continues to seep from the print head or vent maze. If ink continues to seep, verify that the refill hole is sealed properly, then repeat steps 6 - 8. The process should be repeated until the cartridge no longer seeps, indicating that the pressure is equalized.
8. Verify ink flow by pressing the print head against a damp paper towel. The print head should leave a solid line of ink on the towel. If not, follow the instructions on page 30 to prime the cartridge.
9. Although the cartridge does not appear to leak, verify this by waiting approximately 10 minutes before checking the cartridge again. If the cartridge is not leaking, re-install the cartridge, run the cleaning cycles, and print test pages.

Troubleshooting: If you followed the instructions carefully but need additional help, please review pages 34-35.

Recommended Tools



Epson:
T001/T001011•T008*/T008201*•T009*/T009201*•T016*/T016201*
•T027*/T027201*•T040*/T040120*•T041*/T041020*•S020193

Seal outlets on the base of cartridge



*Micro-droplet Counter Chip

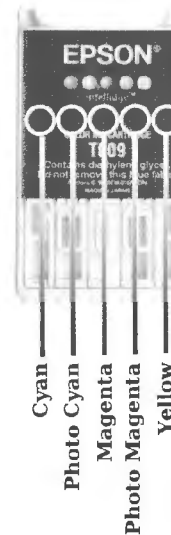

Note: Cartridges marked with a "*" may have a chip that counts the number of micro-droplets printed and is set to turn off when a pre-determined number of droplets are printed, although the cartridge may not be empty. To refill and use this cartridge, the chip must be reset. There are a number of ways to reset the chip. For instructions, please visit www.stratitec.com.

1. Read pages 4-5 for important general information that will greatly improve your results.
2. Seal the ink outlet(s) at the base of the cartridge with clear tape.
3. Use the needle or the screw tool to puncture the cartridge label where the label is indented, indicating refill hole location.
4. Carefully insert the needle into the refill hole until the tip is halfway into the foam sponge, then **slowly** inject 4-10ml of ink into the refill hole, gently tapping the cartridge after each ml is injected to allow air bubbles to escape. Injecting ink too quickly may trap air inside the cartridge. As you add ink, watch the print head closely. If ink begins to come out of the print head or around the filling hole, stop filling, then use the syringe to extract about 0.5ml of ink.
5. Refill each color by repeating the above process, making sure to tape over the unused refill holes to prevent contamination.
6. Seal the refill holes with strong adhesive tape. Leave the clear tape on the ink outlet(s) to ensure a proper seal when the cartridge is reinstalled. The tape will be punctured by the print head carriage when the cartridge is re-installed.
7. Follow the chip resetting instructions and re-install the cartridge.

Troubleshooting: If you have followed the instructions carefully but need additional help, please review pages 34-35.

Recommended Tools



Epson: S020138•S020047•S020049•S020097

Seal ink outlets



S020138



Cyan
Yellow
Black
Magenta

Troubleshooting: If you have followed the instructions carefully but need additional help, please review pages 34-35.

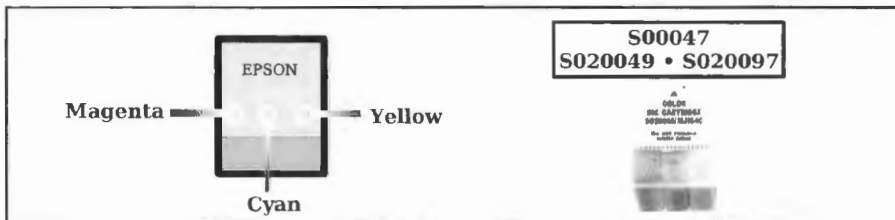

1. Read pages 4-5 for important general information that will greatly improve your results.
 2. Seal the ink outlet(s) at the base of the cartridge with clear tape.
 3. Use the needle or the screw tool to puncture the cartridge label where the label is indented, indicating refill hole location.
- Note:** Before refilling, always verify the ink colors by inserting a toothpick into each hole and checking the color.
4. Carefully insert the needle into the refill hole until the tip is halfway into the foam sponge, then **slowly** inject 4-10ml of ink, gently tapping the cartridge after each ml is injected to allow air bubbles to escape. Injecting ink too quickly may trap air inside the cartridge. As you add ink, watch the print head closely. If ink begins to come out of the print head or around the filling hole, stop filling, then use the syringe to extract about 0.5ml of ink.
 5. Refill each color by repeating the above process, making sure to tape over the unused refill holes.
 6. Seal the refill holes with strong adhesive tape. Leave the clear tape on the ink outlet(s) to ensure a proper seal when the cartridge is reinstalled. The tape will be punctured by the print head carriage when the cartridge is re-installed.
 7. Re-install the cartridge and print test pages. If print results are unsatisfactory or colors are incorrect, please read "Tri-Color Cartridge Troubleshooting" on page 28.

IMPORTANT: It usually takes 4-24 hours for ink to flow to the print head properly once the cartridge is re-installed. For best results, refill cartridges before they are empty. Empty ink cartridges should be refilled promptly, as cartridges that are old or dry may not refill successfully. If necessary, refilled cartridges may be stored in a sealed plastic bag.

Recommended Tools

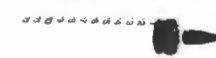

Hewlett-Packard: C5010AN (14)•C5011AN (14)



1. Read pages 4-5 for important general information that will greatly improve your results.
2. Place the cartridge on a flat, ink-resistant surface with the bottom facing up as shown.
3. This cartridge is refilled by forcing ink through the ink outlets. It is important not to dent, mar, or damage the ink outlet, or the cartridge will be unusable.
4. Fill the syringe with the desired ink color, then carefully remove the needle and attach the small rubber priming tip (page 3).
5. Press the priming tip gently against the ink outlet on the cartridge and slowly inject ink, up to 6ml for color and up to 23ml for black. If the sponge is dry, it may absorb the ink slowly. Stop filling when the sponge is full and stops absorbing ink quickly.
6. Carefully turn the cartridge to the upright position, using a paper towel or absorbent cloth to absorb any ink dripping from the ink outlet. Hold cartridge upright until ink no longer drips from the ink outlet. Installing the cartridge while ink is still dripping and/or leaking out of the cartridge may damage the printer.
7. Re-install the cartridge, run the cleaning cycles, and print test pages. If print results are unsatisfactory or colors are incorrect, please read "Tri-Color Cartridge Troubleshooting" on page 28.
8. Most printers requiring the HP 14 cartridge have an ink-level counter that must be disabled in order to use refilled cartridges. Instructions for disabling the ink counter are available in your printer manual or the technical support center.

Note: For best results, refill cartridges before they are empty.

Troubleshooting: If you followed the instructions carefully but need additional help, please review pages 34-35.

Recommended Tools



Lexmark: 18L0032 (82)•10N0016 (16) **Xerox:** 8R7903

Enlarge the hole on the top of the cartridge



Insert half the length of the needle into the refill hole



1. Read pages 4-5 for important general information that will greatly improve your results.
2. Enlarge the small hole on the top of the cartridge with a 3mm drill bit or screw tool.
3. Fill the large syringe with ink and carefully insert the needle into the refill hole until the tip is halfway into the foam sponge.
4. **Slowly** inject 10-20ml of ink for the 16, or 15-25ml of ink for the 82. As you add ink, watch the refill hole closely. If ink begins to overflow around the refill hole, stop filling, and use the syringe to extract 1-2ml of ink.
5. Verify ink flow by pressing the print head against a damp paper towel. The print head should leave a solid line of ink on the towel. If not, follow the instructions on page 30 to prime the cartridge.
6. **IMPORTANT:** This cartridge is easy to overfill. Check for overfilling by following the instructions on page 33.
7. Re-install the cartridge, run the cleaning cycles, and print test pages. If print results are unsatisfactory, the cartridge may be overfilled. If you injected more than 15ml of ink, try removing an additional 2-3ml of ink and try again.

Note: For best results, refill cartridges before they are empty.

Troubleshooting: If you followed the instructions carefully but need additional help, please review pages 34-35.

Recommended Tools



Epson:

T018*/T018201*•T029*•S020089•S020093•S020108•T007*/T007201*•T015*•T017*/T017201*•T026*•T028*•S020191•T005•T020•T014/T014201•S020187•S020189•T003•T013•T019•(and others)

Note: Cartridges marked with a "*" may have a chip that counts the number of micro-droplets printed and is set to turn off when a pre-determined number of droplets are printed, although the cartridge may not be empty. To refill and use this cartridge, the chip must be reset. There are a number of ways to reset the chip. For instructions, please visit www.stratitec.com.



Seal the ink outlet hole on base of cartridge with tape



*Micro-droplet Counter Chip

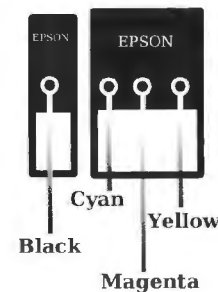

1. Read pages 4-5 for important general information that will greatly improve your results.
2. Seal the ink outlet(s) at the base of the cartridge with clear tape.
3. Use the needle or the screw tool to puncture the cartridge label where the label is indented, indicating refill hole location.

Note: Before refilling, always verify the ink colors by inserting a toothpick into each hole and checking the color.

4. Carefully insert the needle into the refill hole until the tip is halfway into the foam sponge, then **slowly** inject 4-10ml of ink into the refill hole, gently tapping the cartridge after each ml is injected to allow air bubbles to escape. Injecting ink too quickly may trap air inside the cartridge. As you add ink, watch the print head closely. If ink begins to come out of the print head or around the filling hole, stop filling, then use the syringe to extract about 0.5ml of ink.
5. Refill each color by repeating the above process, making sure to tape over the unused refill holes to prevent contamination.
6. Seal the refill holes with strong adhesive tape. Leave the clear tape on the ink outlet(s) to ensure a proper seal when the cartridge is reinstalled. The tape will be punctured by the print head carriage.
7. Follow the chip resetting instructions and re-install the cartridge.



* Marked cartridges contain a Micro Droplet Counter Chip. Please review chip resetting instructions at www.easyinkjetrefill.com for further information.

Troubleshooting: If you have followed the instructions carefully but need additional help, please review pages 34-35.



Canon: BC-05 Apple: M4609



1. Read pages 4-5 for important general information that will greatly improve your results.
2. These cartridges have plugs on the top of the cartridge that must be removed (see image, left). Press the included screw tool into each plug and turn clockwise until the tool is secured in the plug and you are able to pull the plug out. If you are unable to remove the plugs, simply use the screw tool to enlarge the holes so that ink can be injected.
3. **Slowly** inject 3-5ml of the appropriate color of ink into each refill hole.
4. Use strong adhesive tape or the included small low-profile rubber plugs to seal the refill holes. If the seal is not airtight, the cartridge will leak.
5. Verify ink flow by pressing the print head against a damp paper towel. The print head should leave a solid line of each color of ink on the towel. If not, follow the instructions on page 30 to prime the cartridge. Check for ink flow.
6. **IMPORTANT:** This cartridge is easy to overfill. Check for overfilling by following the instructions on page 33.
7. Re-install the cartridge, run the cleaning cycles, and print test pages. If print results are unsatisfactory or colors are incorrect, please read "Tri-Color Cartridge Troubleshooting" on page 28.

Note: For best results, refill cartridges before they are empty. Empty ink cartridges should be refilled promptly, as cartridges that are old or dry may not refill successfully. If necessary, refilled cartridges may be stored in a sealed plastic bag.

Troubleshooting: If you have followed the instructions carefully but need additional help, please review pages 34-35.



Lexmark: 10N0026 (26) • 18L0042 (83) **Xerox:** 8R7904



Remove cartridge top with pliers or drill though top to reach each ink chamber (page 32)



Ink Chambers

1. Read pages 4-5 for important general information that will greatly improve your results.
2. Carefully remove the top cover of the cartridge using channel-lock pliers or a small screwdriver. You may want to use the included 3mm drill bit to make a hole above each ink chamber instead of removing the top. Use care to prevent damage to the sensors located on the back of the cartridge.
3. Once the top has been removed, place the cartridge on paper towels or or absorbent cloth in case of spills or leakage, and position it horizontally. Select a color and fill a syringe with ink (see photos with color identification, below). Tape over unused filling holes to prevent ink from contaminating the other ink colors.
4. Carefully insert the needle into the correct filling hole until the tip is halfway into the foam sponge.
5. **Slowly** inject 2-7ml ink. Injecting ink too quickly may trap air inside the cartridge. As you add ink, watch the print head closely. If ink begins to come out of the print head or around the filling hole, stop filling, then use the syringe to extract about 1ml of ink.
6. Refill each color by repeating the above process, making sure to tape over the unused refill holes to prevent contamination.
7. Verify ink flow by pressing the print head against a damp paper towel. The print head should leave a solid line of each color of ink on the towel. If not, follow the instructions on page 30 to prime the cartridge.
8. **IMPORTANT:** This cartridge is easy to overfill. Check for overfilling by following the instructions on page 33.
9. Once the cartridge is refilled, tape the cartridge cover securely in place, re-install the cartridge, run the cleaning cycles, and print test pages. If print results are unsatisfactory or colors are incorrect, please read "Tri-Color Cartridge Troubleshooting" on page 28.

Troubleshooting: If you have followed the instructions carefully but need additional help, please review pages 34-35.

10N0026 (26) • A920

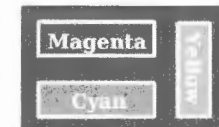

18L0042 (83) • J740



8R7904

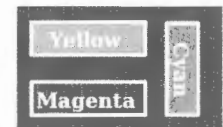



Lexmark:
 1361400•1380620•1381400•1382050•13400HC•13620HC•17G00
 50 (50)•16G0055 (55)•12A1970 (70)•12A1975 (75)
Compaq: 180845-001•337709-001•180847-001•337714-001
 •203428-001 **Brother:** IN-700•LC11-BK
Xerox: 8R7881•8R7879 **Okidata:** 52109301
Sharp: AJ-C50B **Olivetti :** JP470•JP790•JP795•JP883•84433S



Canon: BC-01•BC-02•BX-2•BX-3
Apple: M8041•M8049•M8052 **Brother:** IN10

Enlarge refill hole



1. Read pages 4-5 for important general information that will greatly improve your results.
2. Enlarge the small hole on the top of the cartridge with a 3mm drill bit or the included screw tool.
3. Fill the large syringe with black ink and carefully insert the needle into the refill hole until the tip is halfway into the foam sponge.
4. **Slowly** inject 10-20ml of ink. As you add ink, watch the refill hole closely. If ink begins to overflow around the refill hole, stop filling, and use the syringe to extract 1-2ml of ink.
5. Verify ink flow by pressing the print head against a damp paper towel. The print head should leave a solid line of ink on the towel. If not, follow the instructions on page 30 to prime the cartridge.
6. **IMPORTANT:** This cartridge is easy to overfill. Check for overfilling by following the instructions on page 33.
7. Re-install the cartridge, run the cleaning cycles, and print test pages. If the prints are not satisfactory, the cartridge may still be overfilled. If you injected more than 15ml of ink, try removing an additional 2-3ml of ink and try again.



WARNING: Cartridge is easily overfilled (page 33)

Note: Do not attempt to print with this cartridge when it is empty as this could damage the print head. For best results, refill cartridges before they are empty.

Troubleshooting: If you have followed the instructions carefully but need additional help, please review pages 34-35.



Drill filling hole here, 3/16" from edge of cartridge.



DO NOT puncture this vent.

1. Read pages 4-5 for important general information that will greatly improve your results.
2. Although these cartridges contain an original filling hole/vent, do not use it to refill the cartridge. Use the included 3mm drill bit to drill a refill hole at the top of the cartridge (about 3/16" from the edge, as shown at left). Be sure that the refill hole is clean and smooth, as the small rubber plug must create an airtight seal once the cartridge is refilled.
3. **Slowly** inject 15-20ml of black ink into the newly-drilled refill hole.
4. Seal the filling hole with one of the included small low-profile plugs. If the seal is not airtight, the cartridge will leak. If the plug does not seal properly, or if the cartridge continues to leak, use strong tape to complete the seal.
5. Verify ink flow by pressing the print head against a damp paper towel. The print head should leave a solid line of each color of ink on the towel. If not, follow the instructions on page 30 to prime the cartridge.
6. **IMPORTANT:** This cartridge is easy to overfill. Check for overfilling by following the instructions on page 33.

Note: For best results, refill cartridges before they are empty. Empty ink cartridges should be refilled promptly, as cartridges that are old or dry may not refill successfully. If necessary, refilled cartridges may be stored in a sealed plastic bag.

Troubleshooting: If you have followed the instructions carefully but need additional help, please review pages 34-35.



Canon: BCI-21•BCI-24•BCI-10•BCI-11 **DEC:** LJ50X-AC
Apple: M3330•M3329•M3908•M3909•M3910•M3912•M3911

1. Read pages 4-5 for important general information that will greatly improve your results.
2. To reduce the risk of ink contamination, we recommend removal of the cartridge top on color cartridges. Use pliers or channel-lock pliers to break the top off of the color cartridge.
3. Place the cartridge with the ink outlet(s) facing up (as shown at left) on a flat, ink-resistant surface or on paper towels or absorbent cloth in case of spills or leakage. Fill a syringe with the desired ink color, then carefully remove the needle and attach the small rubber priming tip (page 3).
4. Press the priming tip gently against the ink outlet on the cartridge and slowly inject 2-5ml for color ink and 4-12ml for black ink. If the sponge is full and stops absorbing ink slowly. Stop filling when the sponge is full and stops absorbing ink quickly or if ink leaks from the print head.
5. Carefully turn the cartridge to the upright position, using a paper towel or absorbent cloth to absorb any ink dripping from the ink outlet. Hold cartridge upright until ink no longer drips from the ink outlet. Installing the cartridge while ink is still dripping and/or running out of the cartridge may damage the printer. NEVER install a leaking cartridge in your printer.
6. Once cartridge is refilled, secure the cartridge cover using tape. Re-install the cartridge, run cleaning cycles and test pages. Most Canon printers will automatically reset ink levels.

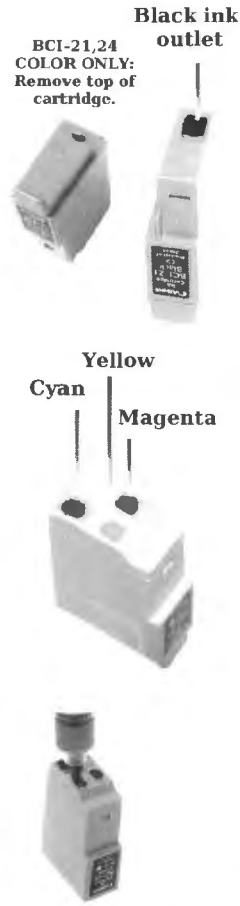

Press priming tip gently against ink outlet and inject ink

Note: For best results, refill your cartridge regularly. In some cases, the sponge may not absorb ink immediately. After refilling, allow 1-2 hours (12 hours for very dry sponges) for the sponge to absorb the ink.

Refill Tip: Generic cartridges often contain more absorbent sponge material and may offer better results, with longer time between refills.

Troubleshooting: If you have followed the instructions carefully but need additional help, please review pages 34-35.



Lexmark: 1361760•1380619•1382060•13619HC•15M0120 (20)
 •15M0125 (25)•16G0065 (65)•17G0060 (60)•12A1980 (80)
 •12A1985 (85)•12A1990 (90)
Compaq: 337715-001•337710-001•337711-001•180846-001•180848-001•180844-001 **Brother:** IN-710C •LC11-CL
Xerox: 8R12591•8R7880•8R7882 **Okidata:** 52109302
Sharp: AJ-C50C **Olivetti :** JP470•JP790•JP795•JP883•84433S



1. Read pages 4-5 for important general information that will greatly improve your results.
2. If this is the first refill, the cartridge top must be removed. Please read the instructions on page 32 for instructions.
3. Once the top has been removed, place the cartridge on paper towels or absorbent cloth in case of spills or leakage, and position it horizontally. Select a color and fill a syringe with ink (see photos with color identification, below). Tape over unused filling holes to prevent ink from contaminating the other ink colors.
4. Carefully insert the needle into the correct filling hole until the tip is halfway into the foam sponge.
5. **Slowly** inject 3-8ml ink. Injecting ink too quickly may trap air inside the cartridge. As you add ink, watch the print head closely. If ink begins to come out of the print head or around the filling hole, stop filling, then use the syringe to extract about 1ml of ink.
6. Leave the cartridge the horizontal position as shown below. Refill each color by repeating the above process, making sure to tape over the unused refill holes.
7. Verify ink flow by pressing the print head against a damp paper towel. The print head should leave a solid line of each color of ink on the towel. If not, follow the instructions on page 30 to prime the cartridge.
8. **IMPORTANT:** This cartridge is easy to overfill. Check for overfilling by following the instructions on page 33.
9. Once cartridge is refilled, secure the cartridge cover using tape. Re-install the cartridge, run cleaning cycles and test pages. If print results are unsatisfactory or colors are incorrect, please read "Tri-Color Cartridge Troubleshooting" on page 28.

WARNING: Do not attempt to print with this cartridge when it is empty as this could damage the print head. For best results, refill cartridges before they are empty.

Troubleshooting: If you have followed the instructions carefully but need additional help, please review pages 34-35.

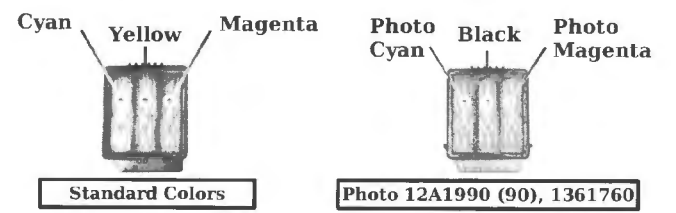

Recommended Tools



Canon: BC-30/BC-30e•BC-31/BC-31e•BCI-3Bk/BCI-3eBk•BCI-3C/BCI-3eC•BCI-3M/BCI-3eM•BCI-3Y/BCI-3eY•BCI-3PC/3PM•BCI-5Bk•BCI-5C/BCI-5M/BCI-5Y•BCI-6Bk•BCI-6C/BCI-6M/BCI-6Y•BCI-6PC/BCI-6PM•BCI-8Bk•BCI-8C/BCI-8M/BCI-8Y•BJI-201Bk(HC)•BJI-201C/BJI-201M/BJI-201Y
Apple: M1949•M1950•M1951•M1952•M3822•M3852

Plastic Ball Bearing

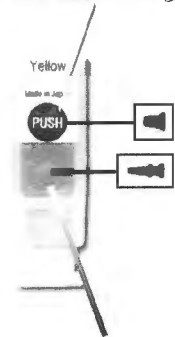

Drill refill hole here (immediately below plastic ball bearing) using 3mm bit.



Use a rubber sealing pad to cover the outlet while filling. This will help prevent leaks.

1. Read pages 4-5 for important general information that will greatly improve your results.
2. Cover the outlet hole with tape or with one of the included rubber sealing pads, maintaining pressure against the sealing pad to prevent leaks during refilling.
3. Drill a 3mm refill hole where indicated (image, left) with the included drill bit. Be sure that the refill hole is clean and smooth, as the small rubber plug must create an airtight seal once the cartridge is refilled.

Note: You may avoid drilling a refill hole if you are able to remove the plastic ball bearing using the screw tool. The ball bearing is located under the label where the word "push" is printed. If you are successful, you must use a large plug to reseal the hole, as the small plug will not be large enough to make an adequate seal.

4. Inject the appropriate color of ink into the ink reservoir until it is full.
5. Seal the refill hole with a small rubber plug. If the seal is not airtight, the cartridge will leak. If you did not use a 3mm drill bit, if the plug does not seal properly, or if the cartridge continues to leak, use hot glue instead of a plug to seal the refill hole. Do NOT use tape.
6. Let the cartridge sit until it is no longer dripping ink. Re-install the cartridge, run the cleaning cycles, and print test pages. NEVER install a leaking cartridge in your printer.

Note: For best results, refill cartridges before they are empty.

Troubleshooting: If you have followed the instructions carefully but need additional help, please review pages 34-35.

Recommended Tools



Canon: BC-20•BC-23 **Apple:** M3240 **Panasonic:** (various)

Remove plug and refill through hole



1. Read pages 4-5 for important general information that will greatly improve your results.
2. These cartridges have a plug on the top of the cartridge that must be removed (see image, left). Press the included screw tool into the plug and turn clockwise until the tool is secured in the plug and you are able to pull the plug out.
3. Carefully insert the needle into the refill hole until the tip is halfway into the foam sponge. This ensures that the ink is injected near the bottom of the sponge so the air above the ink can escape.
4. **Slowly** inject 20-30ml of ink.
5. Seal the refill hole with a large rubber plug.
6. Verify ink flow by pressing the print head against a damp paper towel. The print head should leave a solid line of ink on the towel. If not, follow the instructions on page 30 to prime the cartridge.
7. **IMPORTANT:** This cartridge is easy to overfill. Check for overfilling by following the instructions on page 33.
8. Re-install the cartridge, run the cleaning cycles, and print test pages.

Note: For best results, refill cartridges before they are empty. Empty ink cartridges should be refilled promptly, as cartridges that are old or dry may not refill successfully. If necessary, refilled cartridges may be stored in a sealed plastic bag.

Troubleshooting: If you have followed the instructions carefully but need additional help, please review pages 34-35.