



U.S. Department of
Transportation
Office of the Secretary
of Transportation

S.C.R.T.D. LIBRARY ✓

Specification Guide for Small Transit Vehicles

February 1984



TL
232
+563

Prepared for
Indiana Department
of Transportation

**SPECIFICATION GUIDE
FOR SMALL TRANSIT VEHICLES**

STATE OF INDIANA
Robert D. Orr, Governor

February 1984

Indiana Department of Transportation
Division of Public Transportation
Suite 300, Harrison Building
143 West Market Street
Indianapolis, Indiana 46204
(317) 232-1470

This publication does not constitute a standard, specification, or regulation. The opinions, findings, and conclusions expressed in this publication are those of the Division of Public Transportation and not necessarily those of the United States Department of Transportation. The preparation of this publication has been financed in part through a grant from the United States Department of Transportation under the provisions of Section 18 of the UMT Act of 1964 as amended.

06218

TI
232
-863

TABLE OF CONTENTS

	Page
INTRODUCTION	1
VEHICLE SELECTION	
Determining Needs	1
Types of Vehicles	3
HOW TO WRITE SPECIFICATIONS	6
STANDARD VAN SPECIFICATION GUIDE	10
MODIFIED VAN SPECIFICATION GUIDE	17
BODY ON CHASSIS TRANSIT VEHICLE SPECIFICATION GUIDE	29
SMALL TRANSIT BUSES	43
APPENDICES	
Vehicle Manufacturers	47
Example Technical Specification	51

LIST OF FIGURES

Figure

1. VEHICLE TYPES	4
2. EXTERIOR VAN DIMENSIONS	12
3. VAN SEATING LAYOUTS	12
4. MODIFIED VAN SEATING LAYOUTS	19
5. BODY ON CHASSIS CONSTRUCTION	30
6. BODY ON CHASSIS SEATING LAYOUTS	32
7. DETAILED INFORMATION SHEET FOR SMALL HEAVY DUTY TRANSIT BUS	45

LIST OF TABLES

Table

1. SELECTION OF VEHICLE SIZE	1
2. VEHICLE DIMENSIONS	3
3. SMALL HEAVY DUTY TRANSIT BUSES	44

INTRODUCTION

Preparing technical specifications for vehicles can be a difficult and confusing task for the transit operator. There are many factors that influence what should be specified, such as how the vehicle will be used, how big it should be, how economical it should be to operate, what special equipment is needed, and how much the buyer can afford to pay. The combination of these considerations can result in transit operations of similar size and service specifying a vehicle as simple as a standard passenger van, or as complex and costly as a heavy duty, fully accessible small transit bus. This guide seeks to identify the above-mentioned factors and to show how they can be managed to form the basis for a transit vehicle that will meet the specific needs of each transit operation. After explaining the process for selecting a particular type of transit vehicle, the guide presents factors to consider when developing the technical specifications.

VEHICLE SELECTION

Determining Needs

The first step in the specification phase of the procurement process is choosing the type of vehicle to be specified. The vehicle type is based on the needs that are inherent in the transit service to be provided. Vehicle size in terms of passenger capacity is linked to projected ridership levels and characteristics. Table 1 suggests size ranges to be considered for various types of services.

TABLE 1

<u>Demand-Responsive Operating Patterns</u>	<u>Vehicle Size</u>
1. "Pure Demand" -- same day door-to-door service within a small service area.	8-12 passenger
2. "Advance Reservation" -- Planned trip service. Usually scheduled 24 hours in advance of trip.	8-12 passenger or larger depending on trip length, terrain, and rider demographics.
<u>Fixed Route Service Patterns</u>	
1. "Fixed Schedule" -- vehicle follows a prescribed path with defined pickup points.	16-25 passenger or larger depending on trip length and demand.
2. "Route Deviation" -- vehicle leaves fixed route to pickup or drop off passengers.	12-16 passenger, 16-25 passenger depending on terrain.
<u>Special Service Transportation</u>	
1. "Group Service" -- single point to point service.	Size determined by number of passengers.
2. "Agency Client" -- frequent human service trips to and from agency locations.	12-16 passenger, 16-19 passenger depending on terrain and demand.
3. "Subscription Service" -- normally work trip service. Also includes standing orders.	8-12 passenger, 12-16 passenger depending on trip length and demand.

The terrain or operating environment may dictate a certain vehicle size in terms of exterior dimensions and wheelbase. For example, travel over the narrow, winding streets of an older, densely developed town may preclude the use of full-sized buses; and travel involving the use of driveways, as in specialized services, would necessitate the utilization of small, maneuverable vehicles such as vans. Entrance and interior dimensions will be determined by the needs of prospective passengers. Examples would be low steps for elderly and mobility-limited passengers, and wide aisles to accommodate peak hour "crush" loads. Likewise, a standard van may be adequate for town-to-town trips of long distances and infrequent boarding and alighting. A list of these operating need factors is helpful in organizing the decision to choose a particular vehicle type:

1. Passenger capacity. Careful attention should be given to passenger capacity. The vehicles used in the system should be adequate to carry the maximum number of people at any particular time. In other words, if the highest passenger loading occurs during the early morning and late afternoon, vehicles should be selected that can serve the number of people who ride at those times.
2. Weight capacity. The vehicles should be adequate to carry safely the weight of the total number of passengers to be carried in addition to the driver and any accessories added to the vehicle such as wheelchair lifts, fare boxes, and auxiliary air-conditioning systems.
3. Operating environment. A third factor that should be considered is the operating environment. The environment will influence the type of power train, need for air conditioning, and the turning radius required for the vehicle. For example, if the area has many hills, a heavy-duty engine and transmission would be required. A small city with narrow unimproved streets, or the need to use driveways, could also impose restrictions on vehicle size.
4. Vehicle maintenance needs. Maintenance must be considered in choosing the type of vehicle because different types of vehicles require different types of maintenance capabilities. For example, a van or small bus could be serviced under contract with a local garage, while a regular transit bus or large diesel-powered school bus may require the hiring of specially trained mechanics.
5. Type of service, passenger comfort, and special equipment needs. Passenger and driver needs and comfort levels should also be considered. For example, a standard van will suffice for ambulatory passengers on short shuttle trips, but a raised-roof modified van with a wheelchair lift would be the minimum acceptable for handicapped passengers who are boarding and alighting frequently. Step heights, door aisle openings, aisle widths, headroom, seat spacing and layout, wheelchair accessibility, and safety features are all important components of the overall vehicle package.
6. Fuel type and economy needs. The need to minimize fuel costs or conform with existing fuel and maintenance capabilities will also help determine the type of vehicle selected. However, with the advent of small diesel engines and liquid propane gas, small vehicles are no longer limited to the traditional gasoline powerplants.
7. Budget limitations. Another important consideration is the need to stay within a capital budget. While demand may be best served by a fully accessible diesel coach with a price tag of over \$100,000, economic reality may often dictate a body-on-chassis or school-bus type at less than half this cost. The key here is to identify how much is affordable, and specify the best vehicle available in that price range. To do this, the specification writer must have current and accurate information on the types of vehicles available in the market place. However, buying less vehicle than is

affordable is not advisable. Many small transit operators have discovered that replacing a \$40,000 vehicle every 4 or 5 years is not as economical as purchasing a \$90,000 vehicle that will last 10 years or more.

Careful consideration of the above factors is crucial in selecting the most suitable vehicle for a given type and level of transit service. Many transit operators have regretted not making a careful choice when they find they have either more vehicle or less vehicle than they need. Unfortunately, the buyer cannot "design" the ideal vehicle through technical specifications. Rather, he can select the most appropriate vehicle type available and then proceed to tailor it to his needs by specifying the various options, equipment, and modifications offered by vehicle manufacturers.

Types of Vehicles¹

To simplify the discussion of small transit vehicles available, this report will group them into four categories. This grouping is based upon the construction method, the source of the vehicle (i.e., how and where the vehicle is assembled), and the seating capacity. Although seating capacity follows a general pattern (i.e., small buses seat more than body on chassis, which seat more than modified vans, which seat more than standard vans), there is some overlap among the categories. Table 2 contains typical dimensions of the vehicle types.

TABLE 2
Dimensions for Vans, Modified Vans, Body on Chassis, and Small Buses (1980 Vehicles)

<u>Dimensions</u>	<u>Vans</u>	<u>Modified Vans</u>	<u>Body on Chassis</u>	<u>Small Buses</u>
Overall (in inches)				
Length	178-227	220-227	233-320	312-384
Width	80	80-94.5	80-96	96
Height	80-84	101-115*	93.5-117	99-114
Interior (in inches)				
Width	69-71	69-82	79-90	90-92
Headroom	52-54	64-74	63-78	76-78
GVW (pounds)	6,050-8,550	9,000	10,250-18,000	18,250-22,000
Wheelbase (inches)	110-138	127-138	125-180	168-252
Seating Capacity	9-15	9-16	12-25	20-31

*Higher value generally indicates the addition of air conditioning mounted on the roof.

¹This section was adapted from Small Transit Vehicles: State-of-the-Art Overview, August 1981. Technology Sharing Program, U.S. D.O.T.

Standard Van. Standard vans have a typical seating capacity of from 9 to 15 passengers. Standard vans are available from automobile manufacturers and are part of their standard production line.

Vans offer several advantages. They are readily available for buying or leasing. Maintenance service and parts are relatively easy to obtain. The initial capital cost is lower than that of other small transit vehicles, and they also offer greater maneuverability than do the larger vehicles.

**FIGURE 1
VEHICLE TYPES**



Typical Standard Van



Typical Modified Van



**Typical Body on Chassis Bus
(Van cutaway type)**



**Typical Body on Chassis Bus
(Truck chassis type)**



Typical Small Heavy Duty Transit Bus

The disadvantage of the van is that it is not designed for use in transit service, and therefore is not durable as a transit vehicle. The expected life of a van in transit service is three years, depending on a number of factors (such as the number of miles driven annually). In addition, entry into a van is difficult for some passengers because of the high first step and the low roof. The low roof also inhibits movement within the van, particularly to and from seats in the rear of the vehicle. If a lift or ramp is stored in the vehicle, it often protrudes into the van, further limiting seating space and maneuvering room. In order to clear the roof upon entry and exit, both the wheelchair occupant using the lift and any attendant must bend over a significant amount.

Modified van. The seating capacity of modified vans is approximately 9 to 16 passengers. A modified van is a standard van which has undergone some structural changes, usually made to increase its size, particularly its height. This is often accomplished by raising the roof (adding a bubble top). Other body changes include a widened door, and reinforced and insulated walls and roof. Chassis modifications can include an extended or widened wheelbase, heavy-duty brakes, and an improved suspension. Modifications to increase the safety and comfort of passengers include handholds for support, protective padding on hard surfaces, lower-rise steps at the entrance, roof ventilation for warm weather climates, and well-lighted interiors.

Modifications are not usually made by the original manufacturer. A company acquires the van and modifies it according to its agreement with the buyer. A modified van offers greater accessibility, less restricted interior movement, and more comfort than does a standard van.

However, care must be taken when raising the roof so that the structural integrity of the van is maintained. Some transit operators claim that a raised roof makes the vehicle less stable (especially on open, windy roads), and that leaks often develop at the attachment line. Others say that the modifications add weight to the vehicle and reduce fuel mileage.

Body on Chassis. A body on chassis small bus seats from 12 to 25 passengers and is typically composed of a light truck chassis underneath a special body. A supplier of a body on chassis will purchase a chassis produced by a company such as Chevrolet, Dodge, Ford, GMC, or International Harvester, and then manufacture the body. The body part is typically constructed around a steel frame and then attached to the chassis. This construction is similar to that of school buses.

Body on chassis vehicles offer certain advantages over vans. For example, they tend to be more durable than vans, having an expected life of five to seven years, depending on a number of factors. Another advantage is that some body on chassis have dual rear wheels, making them more stable than vans and safer in accidents. They also offer more interior space, which is often necessary for storing lift equipment and for wheelchair stations. Some body on chassis have transit-type folding doors and low steps for ease of entry. Another advantage is the larger fuel tank capacities of body on chassis, which can be especially helpful when fueling stops are infrequent.

However, body on chassis are not built on a durable transit chassis. Some operators comment that body on chassis have stiff suspensions which produce a bumpy ride. The process of adding a body to a chassis can result in special problems, such as the body being insecurely attached to the chassis, inaccessibility of chassis components for repair and inspection, damage of electrical components during body assembly, etc.

Small bus. A small bus seats from 20 to 31 passengers and has both a body and a chassis which are designed specifically for transit service. One supplier manufactures the entire bus. Many of the components of a small bus are the same as those in standard transit vehicles (e.g., the engine, transmission, and axles). All of the small buses surveyed have diesel engines.

One of the major advantages of the small bus is its durability; for example, one of the small buses reviewed is expected to last from 10 to 15 years. The small bus offers the greatest amount of interior vehicle space, but is less maneuverable than the smaller vehicles. It also has a much higher

purchase price. Another disadvantage is that the small buses which exist now have not been in operation for more than a few years; thus, little data is available on their long term performance.

Other vehicles. It should be pointed out that there are other vehicles which are currently in service and available for purchase, and others yet which are still under development. These are discussed only briefly in this report, because adequate information is available elsewhere.

1. Standard School Buses

Standard school buses, which seat from 22 to 44 adult passengers, are a viable option; large fleets of these vehicles exist in many communities, including rural areas. This suggests that maintenance is available. By using an existing fleet, large financial investments for vehicles can be avoided while local interest in transit is tested. Leasing school buses is generally the cheapest method of obtaining vehicles.

However, there are disadvantages. Adults, especially elderly and handicapped people (who would probably be the prime users of such vehicles), are not comfortable in school buses, which are designed for children from 4 to 18 years of age. This is because of the high entrance steps, the relatively little space between the seats and the aisle, and the stiffness of the seats and suspension, all of which make for an uncomfortable and bumpy ride. Also, since school buses are not designed for regular transit use, such use may decrease the life of the buses. School buses have large turning radii and are not as maneuverable as smaller vehicles. If a system wants to use only vehicles currently belonging to a school fleet, the number of vehicles available during peak travel times is limited. It is also important to note that there are government regulations regarding the use of school buses for passengers other than pupils.

2. Station Wagons

Station wagons seat from 4 to 10 passengers. They can be readily bought or leased, and parts and service are also readily available. The capital investment is lower than that for the larger passenger-carrying vehicles, and resale is relatively easy (a factor not to be overlooked, as project needs may change over time). Case studies have found that automobiles and station wagons are used principally in rural areas in which volunteer drivers are part of a project, or as backup vehicles. Station wagons provide a smooth ride and are highly maneuverable. They are not, however, durable in stop-and-go transit service, nor do they allow passengers much movement within the vehicle.

HOW TO WRITE SPECIFICATIONS

Federal procurement regulations define "specification" as:

A clear and accurate description of the technical requirements for a material, product, or service, including the procedure by which it will be determined that the requirements have been met.

It is the grantee's responsibility to prepare specifications that best reflect the authority's procurement needs. This should be done carefully, however, since the specification, or statement of work as it is sometimes called, will have a direct bearing on the type of contract awarded, its terms and conditions, the contract price, and evaluation criteria. The grantee must state exactly what the requirements are, and not leave specifications open to multiple interpretations. If bidders cannot tell what is required of them, they may submit bids that are too high or too low, or may include many unnecessary contingencies.

There are two basic types of specifications that can be described in your Invitation For Bid (IFB): design or product specifications and performance specifications.

A design or product, specification is one containing the data necessary to produce an item (this normally would include details, size, dimensions, etc.).

A performance specification expresses requirements in the form of output, function, or operation of an item and equipment, and leaves the details of design, fabrication, formulation, or internal workings to the producer's option. Most specifications have both design and performance characteristics. When a specification is referred to as a performance specification, it indicates that the requirements in the specification are predominately performance.

Specifications must be made in a manner that will promote competition. They must clearly define:

- The actual minimum procurement needs;
- The manner in which the grantee will contract for the needs; and
- The basis upon which offers to contract will be evaluated.

A good specification is sufficiently definite and clear to permit the preparation of bids or proposals on a common basis, so as to obtain the benefit of full and free competition. In order to enable all eligible contractors to compete for an award, the description of the required items or services should be easily understood by any organization involved in that particular field, and not written to conform to the specifications of one particular firm or organization. The information provided in the specification should be thorough enough to enable these potential contractors to submit realistic and accurate responses in the form of formal bids and proposals.

All specifications should be written in plain, precise language. The purpose of a specification is to convey to the contractor exactly what is required in the procurement. The specification or statement of work represents the essence of the contract, so it must accurately reflect the desires of the grantee while expressing them in a manner that leaves little room for misunderstanding.

So, a good specification avoids the use of vague, ambiguous terms. Adhering to this rule will help to avoid situations where a contractor interprets the terms of a contract one way, when the grantee meant something else. If your specifications are not precise, and a contractor delivers a product or performs a service that does, in fact, conform to a reasonable interpretation of your specification (even if it's not what you intended), that contractor will likely be judged in compliance if the dispute is submitted to arbitration or settled in a court of law.

Your specification should use appropriate technical terms and words of the trade. If a dispute arises and is brought before a court, the court will interpret specifications by the meaning they have in common usage.

It's best to leave nothing in a specification that would allow multiple interpretations. In a competitive business environment, contractors often employ or provide the least expensive method or end product. Contractors should not be condemned for this approach, as it represents fundamental competitive business practice. Therefore, *it is the responsibility of the purchaser (grantee) to communicate in the specification exactly what is to be provided.*

Emphasizing these points, the simplest words and phrases should be used to convey the intended meaning, and sentences should be as short and concise as possible. Consider the following points:

- Use the active rather than passive voice. For example, "The contractor shall establish a schedule," rather than "A schedule shall be established."
- Use short and concise sentences.

- Use familiar words in preference to the unfamiliar.
- Eliminate unnecessary words.
- Use words consistently. The same words or phrases should be used throughout the specification to express the same meaning. When a reader sees a variation in a word or phrase, there is an inclination to look for a new meaning. Ambiguity or contradiction might result.
- Avoid words that have double meanings; for instance, “including” can mean both “consisting solely of” or “including but not limited to.”

The specification or statement of work is subject to the rules of contract law, and to the rules for drafting and interpreting contracts, so mandatory language should be used properly. Whenever expressing a provision that is binding, use the word “shall”. “Will” may be used to express a declaration of purpose, or where the future tense is required. When it is intended to require the contractor to do something, use the emphatic form of the verb, namely, “shall.”

A good specification is one that establishes actual minimum, necessary requirements, and not what may be desirable or ideal. The specification must, of course, reflect what you need to purchase. However, although you might desire a particular firm to manufacture a certain item or you know a company offers a special service, if it is not required that the particular firm provide your necessary item or service – and if specifying it unduly restricts competition and prohibits other firms from competing – you should not require it in your specification.

You may be familiar with the frequency with which prospective contractors initiate protest actions if they believe that a specification requirement prohibited them from competing for an award. The point is, when not called for, don’t restrict the competition.

There are instances, however, when specifying a particular item is called for. The mere fact that only one potential bidder may be able to supply an item or service does not necessarily make the specification unduly restrictive. You are, after all, responsible for purchasing the proper goods or services, so if it’s the case that only one item will, in fact, meet your minimum requirements, justify this specification and document your decision carefully and thoroughly.

While discussing the guidelines for naming particular items or goods in a specification, we should address the practice of mentioning *brand names*. If, for example, in preparing a specification for the purchase of an item you want to identify the *characteristics* of a product that you know meets your requirements, you can name that particular brand. But you must also allow other suppliers the opportunity to offer a product that is equal to, or superior to, that item. Therefore, you may use a “*brand name or equal*” description.

A specification which contains a brand name or equal purchase description must identify those salient physical, functional, or other characteristics of the referenced product that are essential to the grantee’s needs. In fact, for any brand name product mentioned, the specification should also include complete generic identification of the item, the applicable model, make, or catalog number for that item, and the address of the company if the company is not well known.

Contractors who then offer products that differ from the referenced brand name product are to be considered for the award where the grantee determines that the product is equal in all material respects. A bid should not be rejected because of minor differences in design, construction, or features which do not affect the suitability of the products for their intended use.

So, a brand name may be used only when a more detailed description cannot be made – *not* when only a particular brand will meet your authority’s need.

The preceding discussion addresses several key points that apply to the preparation of contract specification and statements of work. A good specification:

- Is concise and complete and leaves no doubt as to what quality and quantity of an item, or what kind of service, is required.
- Doesn't unduly restrict competition.
- Must include quality assurance provisions to make sure that the contractor delivers what was specified.
- Apprises the contractor of his obligations.
- Is written clearly and avoids ambiguities.
- Establishes actual minimum requirements, not what is desired.
- Strikes the proper mix of allowing the contractor to be innovative in his approach while not allowing such leeway that he becomes involved in activities that are not directed toward the critical objective.

STANDARD VAN SPECIFICATION GUIDE

The best sources for information on van specifications are the brochures available from the auto and truck dealers who sell vans. Much of the information in the following van specification guide is from current brochures on the Ford Clubwagon, Chevrolet Sportvan, and Plymouth Voyager lines. GMC produces vans very similar to the Chevy line, and Dodge sells vans similar to the Plymouth line. Other manufacturers have produced passenger vans in the past, and new models may become available in the future. Van brochures describe the vehicles in general and give technical specifications, dimensions, capacities, and lists of available options.

Since vans are to be purchased under a competitive bidding process, options should not be considered in light of their cost as they would be ordered on an individual purchase-order basis. In other words, extra-cost options should not be avoided merely of their listed retail prices. The bid price often takes additional or optional items into consideration, but does not necessarily include adding the retail list price each time an option is specified. Discussion with dealers is advisable to determine the effect of optional equipment on the bid price of a vehicle.

The following Specification Guide presents dimensions and specification alternatives to be considered when preparing technical specifications for standard vans. These are the basic items to include; there may be more detailed specifications necessary for bidding a particular vehicle.

STANDARD VAN BODY SPECIFICATIONS

Dimensions

1. Wheelbase
 - A. Standard vans: 110" – 125"
 - B. Large vans: 128" – 138"
2. Passenger compartment length: Measured from engine cover or back of driver's seat to rear door. Sometimes measured from dashboard back. This measurement would be more useful if it was shown more consistently in vehicle literature.
3. Overall height: Measured from ground to top of roof.
 - A. Standard vans: 80" – 83"
 - B. Large vans: 81" – 84"
4. Body width: Measured from extreme outside surfaces, usually bumpers.
 - A. Standard vans: 80"
 - B. Large vans: 80"
5. Step heights: 12" plus or minus 2"
6. Step tread depth: Should be 7" minimum.

Seating

Seating plan may be selected from manufacturer's seating layouts, or specified for non-standard seating arrangements. Figure 3 shows typical seating configurations.

**FIGURE 2
EXTERIOR VAN DIMENSIONS**

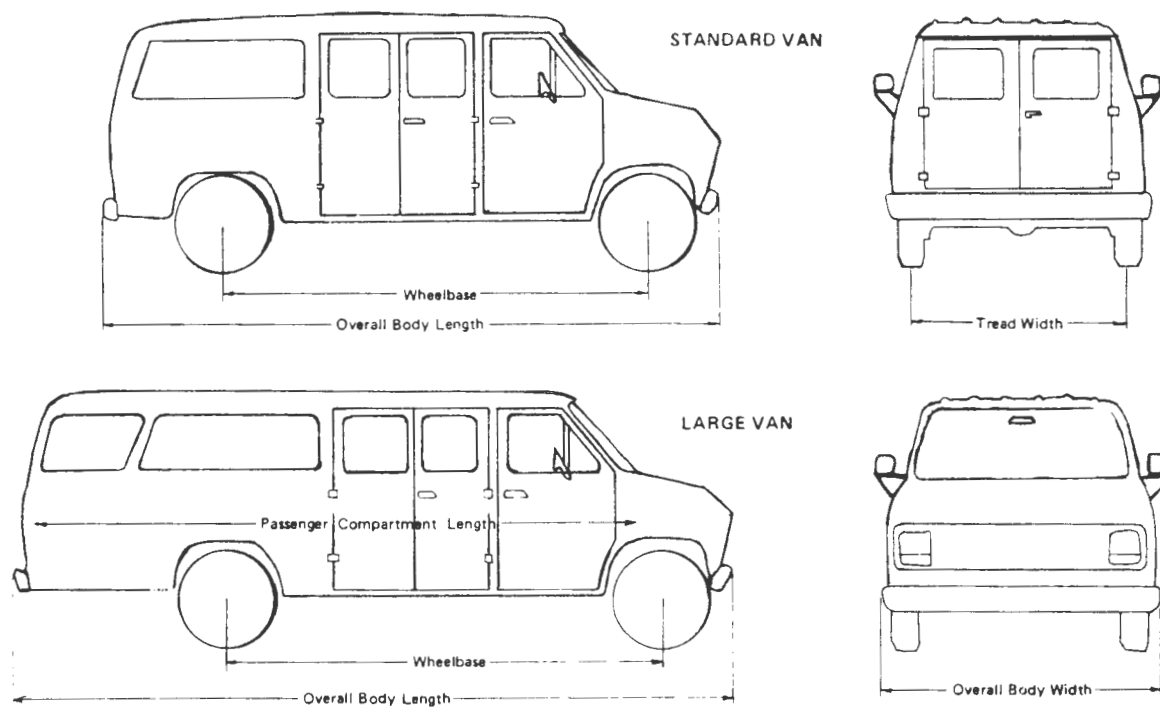

**FIGURE 3
VAN SEATING LAYOUTS**

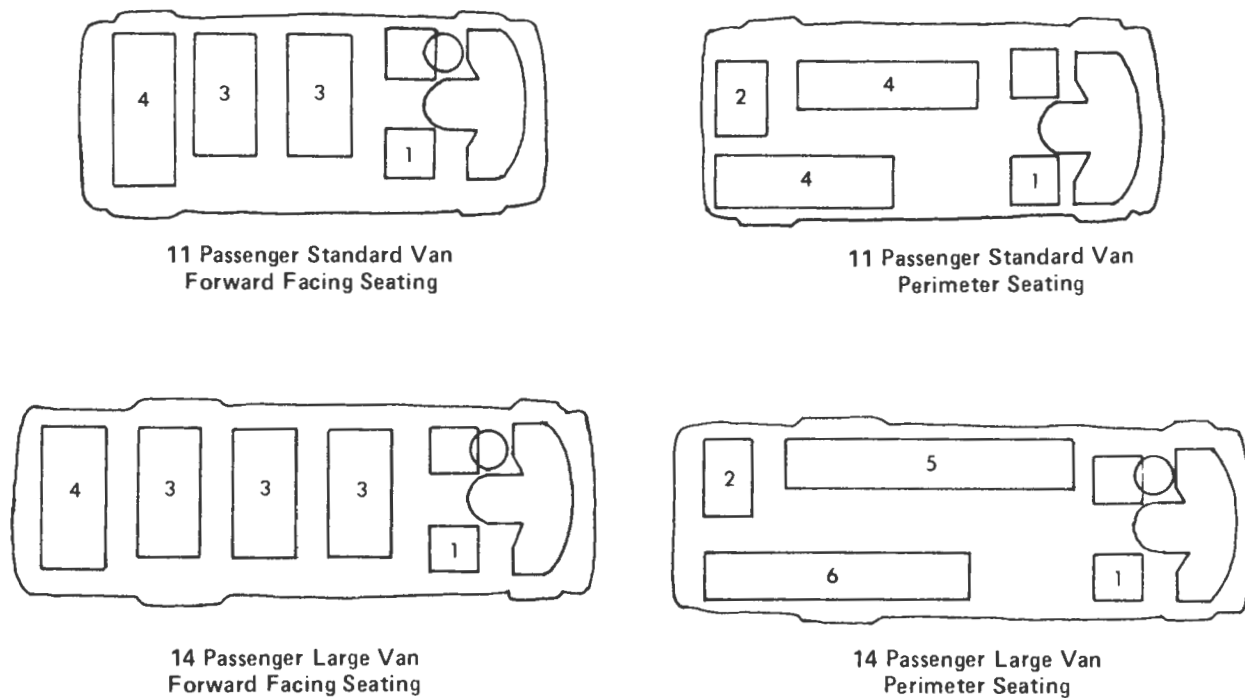

1. Forward facing: Suitable for long trips and general use.
2. Perimeter: Suitable for short trips, stop-and-go service.
3. Seat belts: Should be provided at each passenger position. Combined lap and shoulder belts to be provided for driver's seat and right front passenger seat.

Windows and Mirrors

1. Windows: All around, openable where possible (minimum of 4 side, 2 rear, and roll-down windows for driver and right front passenger).
2. Mirrors: Low-mount outside rear view on both sides.

Doors

1. Side entry
 - A. Double-opening (preferable)
 - B. Sliding (may be difficult for elderly to operate).

Running board or additional passenger step is desirable for passenger boarding and alighting.

2. Rear
 - A. Double-opening (preferable)
 - B. Single-opening (not as structurally sound as double-opening).

Interior Materials

1. Floor covering
 - A. Carpet or standard rubber covering.
 - B. Transit floor covering (rubber over plywood) – desirable for heavy service.
2. Side panels
3. Headliner
4. Insulation packages : Standard or optional insulation in sides, roof, and floor.

Heating and Air Conditioning

1. Integral (dash outlet): Should specify heaviest duty available.
2. Optional rear heat and air units: Desirable for maximum heating and cooling.
3. Air conditioned vans: Should be specified with tinted windows, heavy duty engine cooling, and maximum insulation package available.

Paint and Rustproofing

1. Exterior colors
 - A. Single color available from van manufacturer.
 - B. Two-tone: Available as extra-cost option. May be desirable, especially if color-coordinated logo is to be painted on van (will not necessarily increase bid price).
2. Logo: Logo or trade name of transit operator should be painted on sides, front, and rear of vehicle, along with phone number or other information supplied by buyer.
3. Rustproofing: Several brands and processes of rustproofing are available to be specified.

STANDARD VAN CHASSIS SPECIFICATIONS

Wheelbase

(see Body Specifications)

Gross Vehicle Weight (GVW) Rating

GVW number represents weight of vehicle plus maximum load capacity. Specification should show minimum.

1. Standard vans: 4,900 lbs. – 8,750 lbs.
Typical GVW: 6,400 lbs. minimum
2. Large vans: 6,150 – 9,100 lbs.
Typical GVW: 7,500 lbs. minimum

Engine

1. V-8 gasoline: 302 Cubic Inch Displacement (5.0 liters) – 460 CID (liters).

Typical Standard Van: 300-320 CID
Typical Large Van: 320-360 CID
2. 6-cylinder gasoline: Adequate for smallest (6-9 passenger) vans.
3. Diesel: Becoming more common. Larger, less powerful, and more expensive than gas V-8's; but also more fuel efficient and last longer. Displacements: 379 CID (6.2 L) – 420 CID (7.5 L).

Transmission

1. Heaviest duty automatic transmission available from manufacturer.
2. Optional 4-speed or overdrive: May be desirable where van will be operated continuously at highway cruising speed, to promote fuel economy.

Cooling System

1. Optional extra engine cooling package: Especially for vans equipped with air conditioning.
2. Optional extra engine oil and transmission cooling packages: May also be desirable for vans which will undergo heavy service.

Brakes

1. Heavy-duty, power-assisted.
2. Front disc: Standard on some models, is a desirable feature.

Suspension

1. Suspension characteristics and specifications: Must match vehicle GVW.
2. Optional equipment: Heavy-duty shocks, front stabilizer bar, heavy-duty springs, etc. May improve ride and handling; some items are standard on vans with high GVW's.

Tires

1. Size: Must be matched with GVW.
2. Radials: Standard on some models.
3. Optional all-season radials: Eliminate need for snow-tire change over.
4. Optional oversize: For special conditions.
5. Spare tire: Should be provided on matching rim, mounted on outside of rear door to conserve passenger space inside.

Steering

1. Power assist: Standard on most models.
2. Tilt option: Desirable option to accommodate different drivers.

Electrical System

1. Battery: Maximum amp hour available from manufacturer.
2. Optional heavy-duty alternator (min. 60 amp).
3. Ammeter and oil pressure gauges: Optional on some models, may be specified if buyer deems necessary.

Fuel Tank

1. Standard sizes: 18-22 gallons.
2. Optional auxiliary or large capacity: 30-40 gallons.

STANDARD VAN EQUIPMENT SPECIFICATIONS

(See Specification Guide for modified vans for information on equipment such as wheelchair lifts.)

Jack

For tire changing: Should be mounted in an accessible location so as not to interfere with passenger seating.

Emergency Equipment

Vans should be specified with the following minimum items for safety:

1. 12 unit first-aid kit.
2. 5-lb. ABC fire extinguisher.
3. Triangular reflector kit (or road flares).

All items should be mounted so they are easily accessible to the driver.

Speed Control

Optional automatic speed (cruise) control: May be desirable for highway-type service. Not necessary for in-town service.

Windshield wipers

1. Standard on all models: Two-speed electric.
2. Optional: Intermittant.

Radio

1. Manufacturer's AM-FM-CB radio and antenna: May be specified if transit operator is not using two-way radio system.
2. Two-way radio: To be specified separately from van and added after van is delivered. If transit operator is not currently using two-way system, base station and antenna will also be necessary.

MODIFIED VAN SPECIFICATION GUIDE

Modified vans are standard passenger vehicles that have had structural modifications or equipment added to improve their performance as transit vehicles. There are several basic modifications to standard vans that, either singly or in combination with each other, enable the vehicle to accommodate different types of passengers or provide added comfort and utility to regular passengers:

1. Wheelchair lift and tie-downs
2. Wheelchair ramp and tie-downs
3. Extended roof (high-top)
4. Extended side doors
5. Extended front passenger door and stepwell
6. Bus-type door opener
7. Transit-type flooring
8. Non-standard seating arrangements
9. Grab rails and stanchions
10. Extra lighting
11. Fare box
12. Destination sign

A partially modified van may have only a high top, or may have only a wheelchair lift and tie-down. A fully modified van typically has a high top, wheelchair lift, extended doors, transit flooring, stanchions, and other transit-type items. Usually, a fully modified van serves the needs of elderly and handicapped passengers much better than a van with just a lift. Through the competitive bidding process, most transit operators pay only a little more for a fully modified van than it would cost to purchase a standard van and then add one or two modifications.

The best sources for information on specifications are companies that specialize in building and selling completed modified vans. Specific equipment suppliers or after-market modifiers may also be helpful, but cannot provide comprehensive information on a ready-for-use vehicle.

The following Specification Guide presents dimensions, size ranges, and specification alternatives to be considered when preparing technical specifications for modified vans. These are the basic items to include; there may be more detailed specifications necessary for bidding a particular vehicle.

MODIFIED VAN BODY SPECIFICATIONS

Dimensions

1. Wheelbase
 - A. Standard vans: 110" – 125"
 - B. Large vans: 128" – 138"
2. Passenger compartment length – measured from engine cover or back of driver's seat to rear door.
3. Overall height – measured from ground to top of roof.
 - A. Standard vans: 80" -- 83"
 - B. Large vans: 81" – 84"

(Overall height will be affected by high-top modification, if any.)

4. Body width – measured from extreme outside surfaces, usually bumpers.
 - A. Standard vans: 80"
 - B. Large vans: 80"
5. Step heights: (see passenger door and stepwell section)
6. Step tread depths: (see passenger door and stepwell section)

Seating

1. Seating layout: Will depend on type of modification to be made to van i.e., high top only, wheelchair lift, front stepwell, etc. Several alternative seating arrangements may be specified. (Refer to Figure 4.) Seating specifications (dimensions, upholstery) may be developed for either van manufacturer's seats to be altered or van modifier's own seating. Frequently used wheelchair positions should be equipped with a jump seat (folds out of the way, but sacrifices one passenger position), and infrequently used wheelchair positions should be equipped with a quick-disconnect bench seat, which does not subtract from passenger seating. The quick disconnect bench seat must be removed from the vehicle in order to accommodate a wheelchair passenger.

The floor plans in Figure 4 represent the most common alternatives for modified van seating arrangements. Specifications for individual vehicles may vary and should reflect the needs of the service to be provided. Seating layouts for standard vans (Figure 3) may be used if the vehicle is to use the standard van doors, i.e., no wheelchair lift or front stepwell.

2. Seat belts: Should be provided at each passenger position. Combined lap and shoulder belts to be provided for drivers seat and right front passenger seat (if included).

Windows and Mirrors

1. Windows: All around, openable where possible (minimum of 4 sides, 2 rear, and roll-down windows for driver and right front passenger).
2. Mirrors: Low-mount outside rear view on both sides.

Doors

1. Extended front passenger door and stepwell: Standard van front passenger door shall be raised into roof so as to provide minimum clear entry height of 72". Stepwell shall be extended at front passenger door so that ground-to-step height is no more than 11" + 1" and step tread is minimum 7". Each additional step to floor of van shall not exceed 9" in height and shall have minimum tread depth of 7". All steps are to be covered with anti-skid, ribbed molded rubber tread.
2. Grab rails and stanchions: Should be provided at least one side of stepwell/entry area for use of boarding passengers. Vertical stanchions with rubber or other non-slip covering are to be provided in either side of entry area (see Figure 4G).
3. Door opener: Front door to be operated by mechanical, school-bus type opener from driver's seat.

FIGURE 4
MODIFIED VAN SEATING LAYOUTS

4A. 13-passenger van with front stepwell.

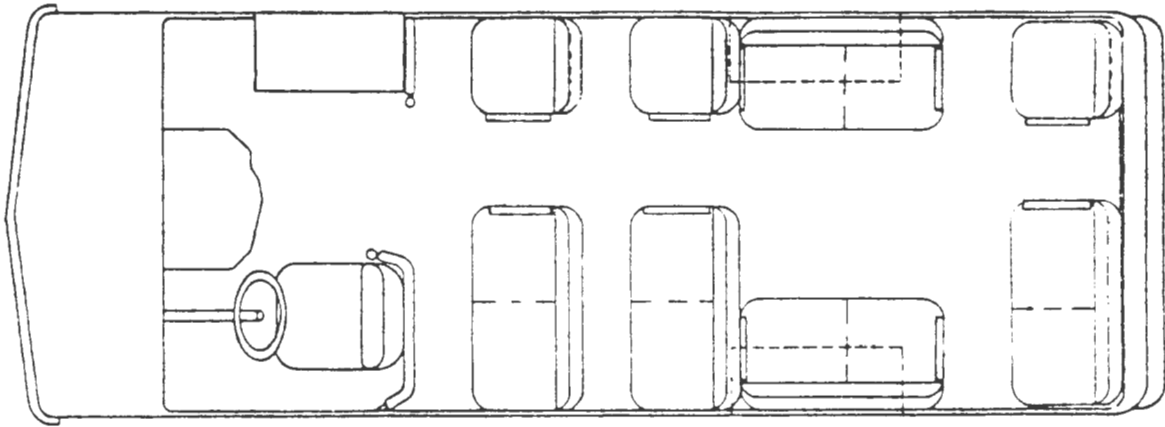

4B. 13-passenger van with front stepwell and perimeter seating.

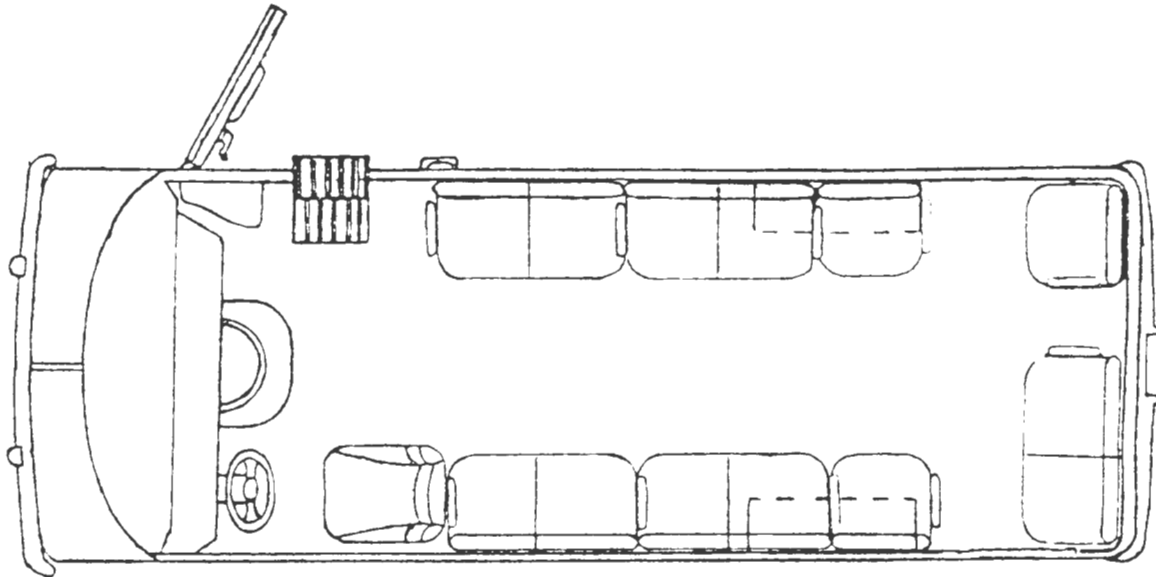

4C. 11-passenger van with stepwell, wheelchair lift, and one tie-down.

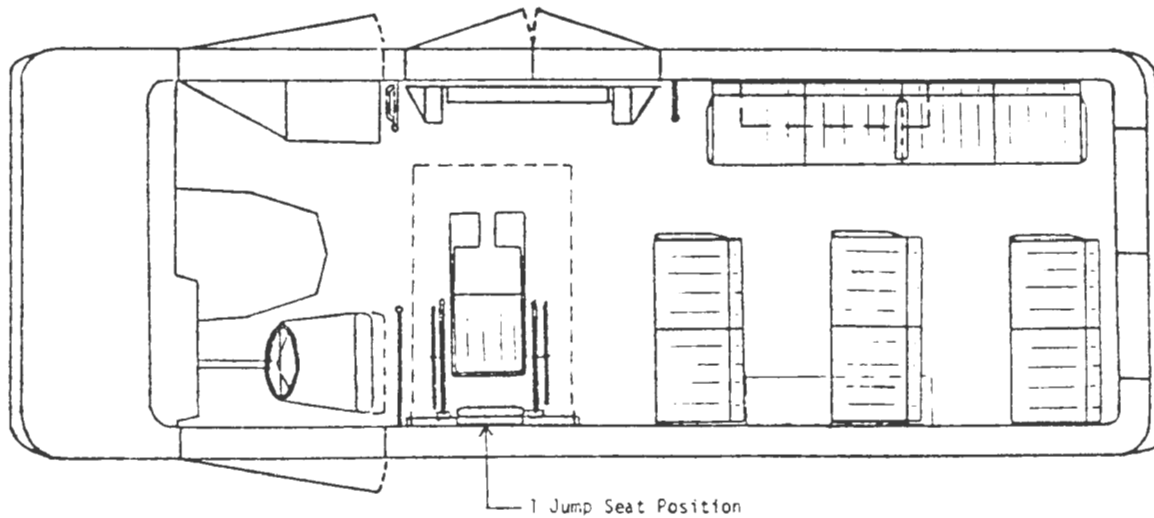
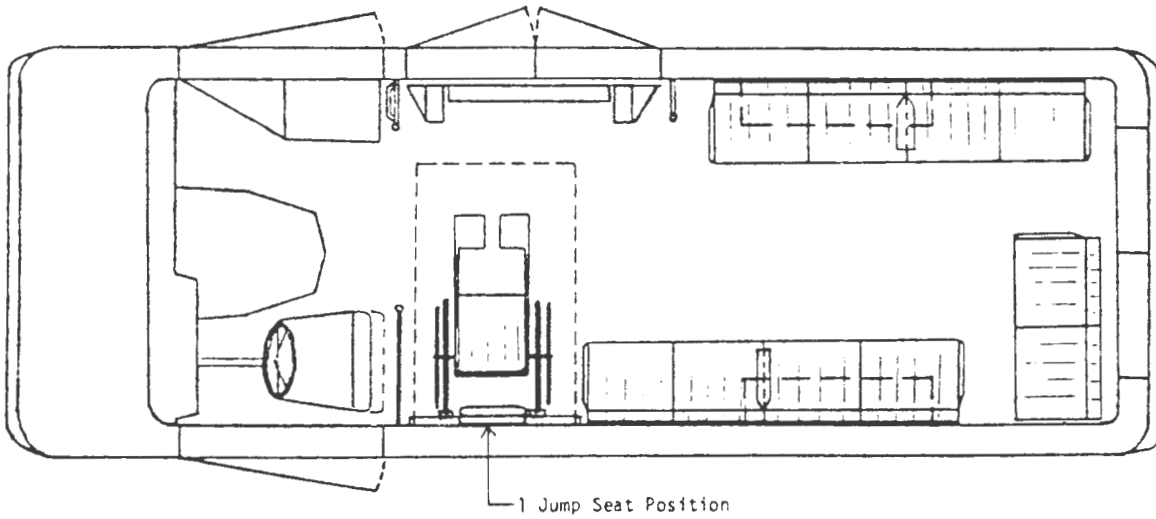
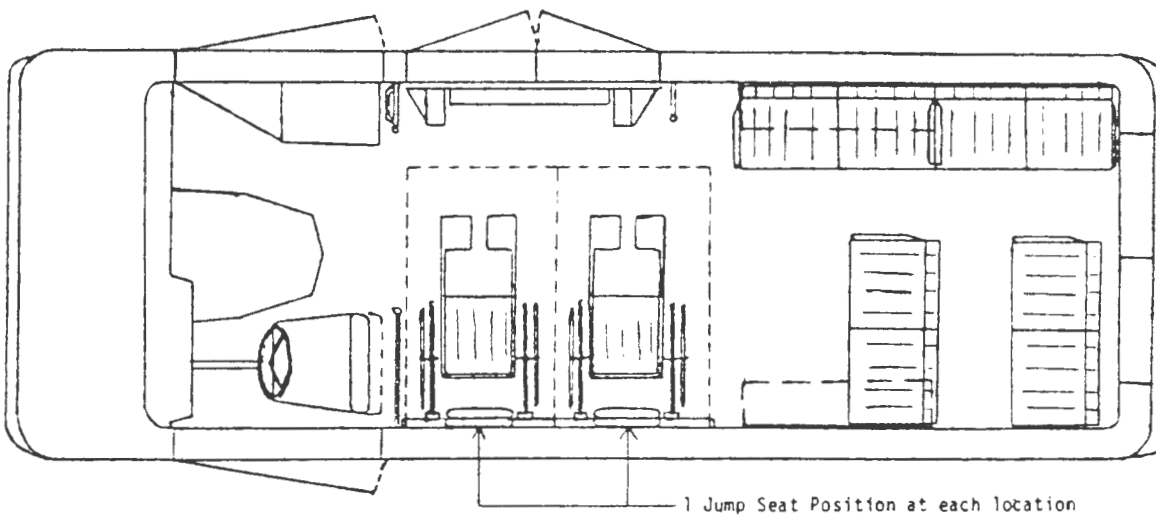

FIGURE 4 (continued)

4D. 11-passenger van with stepwell, lift, tie-down, and perimeter seating.



4E. 10-passenger van with stepwell, lift, and 2 tie-downs.



4F. 10-passenger van with stepwell, lift, 2 tie-downs, and perimeter seating.

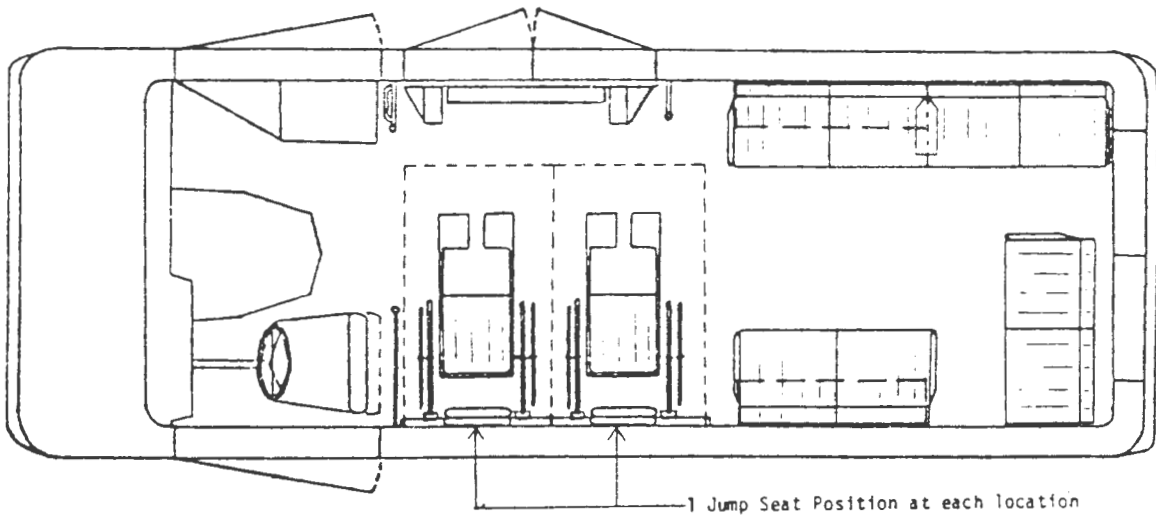
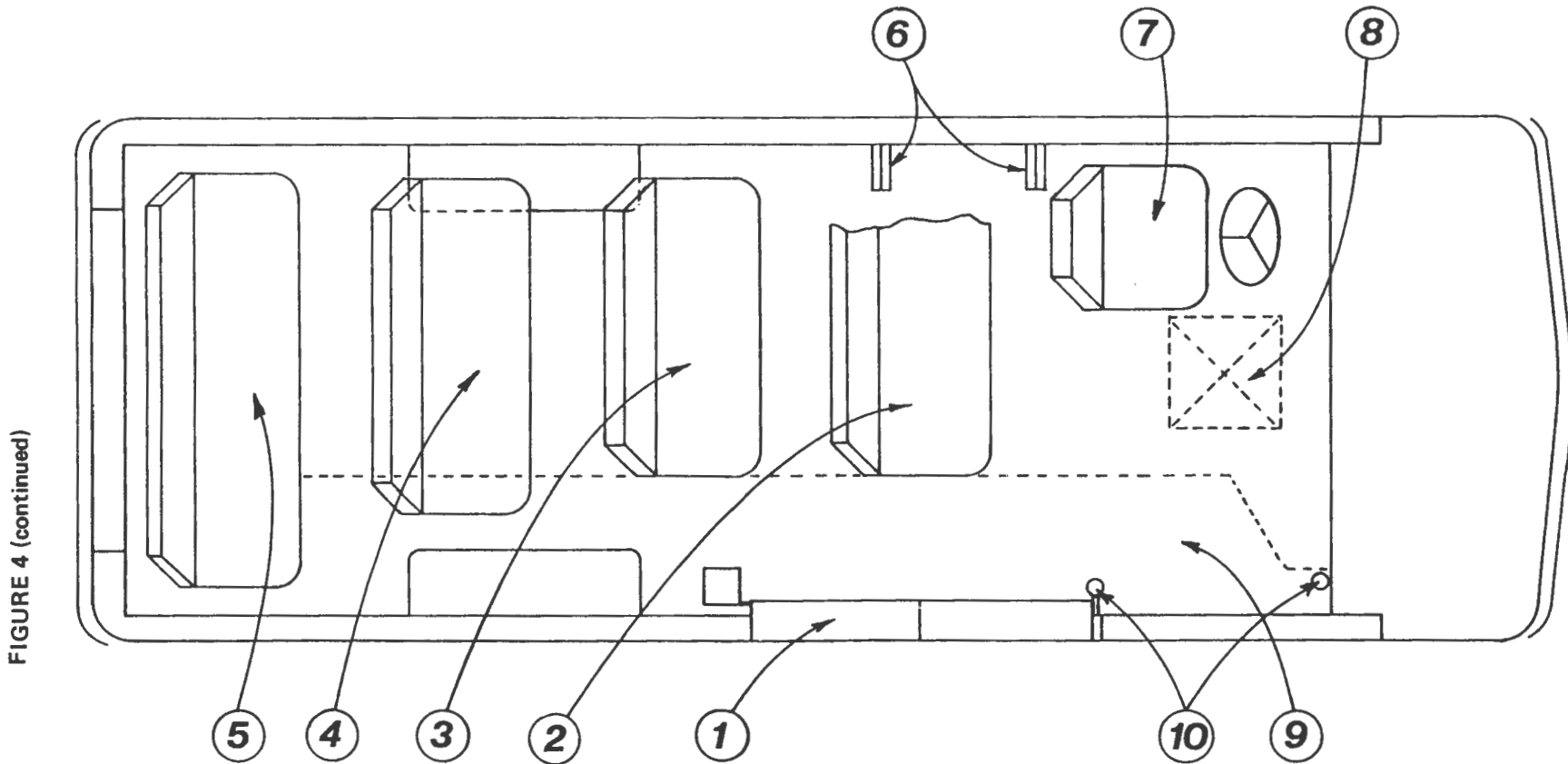

FIGURE 4G. 11-PASSENGER MODIFIED, LIFT-EQUIPPED VAN
SEATING AND EQUIPMENT LAYOUT



KEY

1. Lift & side doors
2. 2-Passenger quick - disconnect bench seat (Min. 40" Wide, Max. 42" Wide)
3. 2-Passenger bench seat (Min. 40" Wide, Max. 42" Wide)
4. 3-Passenger bench seat (Min. 51" Wide, Max. 53" Wide)
5. 4-Passenger bench seat (Min. 68" Wide)
6. Wheelchair locking devices
7. Driver's seat
8. Placement area for vertical stanchion & farebox
9. Aisle area
10. Vertical stanchions and horizontal grabrail between aft stanchion and doorpost (Locations approximate)

SCALE: 1/2" = 1'

4. Rear Door: Double opening type. Signage and instructions for use of rear doors in case of emergency should be clearly legible. (Single-opening door not recommended for transit application.)
5. Wheelchair lift access doors: Should be double opening type with outside fasteners or hold-open feature. Door width should allow operation of lift and shall provide minimum height of 56" – 57".
6. Locks: All doors should be equipped with button-operated locks.

Roof

1. Body structure: Should be of sufficient strength to support entire weight of fully loaded vehicle on its top or side if overturned (roll cage-type roof construction).
2. Full-headroom raised roof: Should provide minimum 72" headroom (floor-to-roof height).
3. Other raised roofs: Available in various heights from van modifiers.
4. Roof finish: Should blend smoothly with van body and shall be thoroughly affixed and sealed to prevent water leaks.

Floor

Floor should be covered with plywood (3/8" or 1/2" min.) and top-covered with commercial grade transit-type rubber flooring, the aisle areas being of anti-skid, ribbed design. However, ribbing should not interfere with wheelchair movement between lift and wheelchair positions.

Interior

All interior panels, materials, and treatments should be flame retardant and treated to be easily cleaned.

1. Colors: Should harmonize with exterior vehicle colors.
2. Padding: All surfaces and items of hardware, including wheelchair lift, in passenger compartment having sharp edges, angles, or corners that could cause injury should be padded with a heavy-duty, vinyl-covered energy-absorbing material.
3. Headliner: Full-length headliner should be provided in both driver and passenger compartments. Complete side panels also should be provided.
4. Insulation: Heavy-duty insulation of a fire-and mildew-resistant type should be provided throughout roof, sidewalls, and doors for heat efficiency and noise suppression, and be thoroughly sealed to prevent drafts.
5. Lighting: Should be provided at interior roof and/or side wall locations to provide interior illumination in following areas:
 - A. Driver's station
 - B. Front passenger door and stepwell

- C. Wheelchair lift access door
- D. Main passenger compartment

Paint and Rustproofing

1. Exterior Colors: Should be selected by buyer from vehicle manufacturer's standard available paint schemes. All body sheet metal modifications should be painted to match original color of van.
 - A. Single color available from van manufacturer: Standard.
 - B. Two-tone: Available as extra-cost option. May be desirable, especially if color-coordinated logo is to be painted on van. (will not necessarily increase bid price.)
2. Logo: Logo or trade name of transit operator should be painted on sides, front, and rear of vehicle, along with phone number or other information supplied by buyer.
3. Rustproofing: Several brands and processes of rustproofing are available to be specified.

Heating and Air Conditioning

1. Integral (dash outlet): Heaviest duty available from chassis manufacturer.
2. Optional rear heat and air units: Necessary for maximum heating and cooling, especially in the expanded space of modified vans.
3. Air conditioned vans: Should be specified with tinted windows, heavy-duty engine cooling, and maximum insulation package.

MODIFIED VAN CHASSIS SPECIFICATIONS

Wheelbase

(see Body Specifications)

Gross Vehicle Weight (GVW) Rating

Number representing weight of vehicle plus maximum load capacity. Specifications should identify minimum GVW.

1. Standard vans with full modifications: 4,900 lbs. – 8,750 lbs.
Typical GVW: 7,500 lbs. minimum
2. Large vans with full modifications: 6,150 – 9,100 lbs.
Typical GVW: 8,500 lbs. minimum

Engine

1. V-8 engine: 302 Cubic Inch Displacement (5.0 liters) – 460 CID.
Typical standard van: 300-320 CID.
Typical large van: 320-360 CID (or larger depending on equipment, terrain, etc.)
2. 6-cylinder gasoline: Adequate for smallest (6-9 passenger) vans, although may not be adequate for van modified with greater weight.
3. Diesel: Becoming more common. Larger, less powerful, and more expensive than gas V-8's; but also more fuel efficient and last longer. Displacements: 379 CID (6.2L) – 420 CID (7.5L).

Transmission

1. Heaviest duty automatic transmission available from manufacturer should be specified.
2. Optional 4-speed or overdrive: May be desirable where van will be operated continuously at highway cruising speed, to promote fuel economy.

Cooling System

1. Optional extra engine cooling package: Especially useful for vans equipped with air conditioning and power equipment such as wheelchair lifts.
2. Optional extra engine oil and transmission cooling packages: May also be desirable for vans which will undergo heavy service.

Brakes

1. Heavy-duty, power-assisted: Standard.
2. Front disc: Standard on some models, is a desirable feature.

Suspension

1. Suspension characteristics and specifications must match vehicle GVW.
2. Optional equipment: Heavy-duty shocks, front stabilizer bar, heavy-duty springs, etc. May improve ride and handling; some items are standard on vans with high GVW's.

Tires

1. Size: Must be matched with GVW.
2. Radials: Standard on some models.
3. Optional all-season radials: Eliminate snow tire change over.

4. Optional oversized tires: For special conditions.
5. Spare tire: Should be provided on matching rim, mounted on outside of rear door to conserve passenger space inside.

Steering

1. Power assist: Standard on most models.
2. Tilt option: Desirable to accommodate different drivers.

Electrical System

1. Battery: Maximum amp hour available from manufacturer should be specified.
2. Heavy-duty alternator (min. 90-100 amp): Especially useful for vans with power equipment such as wheelchair lifts.
3. Ammeter and oil pressure gauges: Optional on some models, may be specified if buyer deems necessary.

Fuel Tank

1. Standard sizes: 18-22 gallons.
2. Optional auxiliary or large capacity: 30-40 gallons.

MODIFIED VAN EQUIPMENT SPECIFICATIONS

Door Opener

For vans with extended front door and stepwell – mechanical school bus-type door opener, operable from driver's seat.

Grabrails and Stanchions

For vans with extended front door and stepwell – grabrails and stanchions should be positioned for use by boarding passengers. Also, one stanchion near driver may be used for mounting fare box.

Farebox

Size and type should be specified according to amount and types of tender to be handled. Non-registering type (does not count fares) is adequate for most van services.

1. Capacity – \$100 – \$300
2. Capability – Mixed coins, paper currency, tokens.

Destination Sign

Can be mounted in front surface of extended top. Desirable for fixed-route or similar services with need for visible route name or number.

1. Fixed card-type signs.
2. Roller-type curtain sign – hand or electrically operated.

Wheelchair Ramp

Usually specified for vehicles expecting only infrequent carrying of wheelchair passengers. Ramp is typically located in rear of van. Ramps require the wheelchair passenger to be physically pushed up the ramp and into vehicle – not practical for many paratransit operations.

Wheelchair Lift

Lift is usually located in extended side doors of a high-top modified van.

1. Mechanism type
 - A. Electro-hydraulic: Operates by means of electrically-driven hydraulic cylinders.
 - B. Electro-mechanical: Operates by means of gears or chain drives.
2. Capacity: 600 to 900 lbs.
3. Operating modes
 - A. Fully automatic: Powered raise and fold.
 - B. Semi-automatic: Power raise, manual fold (counter-balanced).
4. Weight: 150 to 340 lbs.
5. Platform type
 - A. Vertical fold-down: Supported on both sides of platform, folds to store in upright position.
 - B. Vertical fold-down in two hinged sections: One section folds back on the other to allow for usable entry space in side doors.
 - C. Swing-away: Platform pivots from one corner. Since passenger enters platform parallel to vehicle, van must have sliding-type side door. Platform not as stable as vertical fold-down type. Also, platform takes up space on floor of van when stored, unlike vertical fold-down type. Not recommended for transit applications.
6. Platform dimensions: Platform should be large enough to accommodate the variety of wheelchairs to be carried, including extra clearance at sides to allow for maneuvering on and off of platform. Standard wheelchair is 24" wide. Oversized wheelchairs are up to 28" – 30" wide.

7. Controls: Most lift controls require continuous pressure on the buttons or switches, which helps to insure that the lift is operated safely.
 - A. Controls located on inside of side doors, with extension cord to allow use of controls by attendant or passenger on lift.
 - B. Controls located on lift.
 - C. Other locations: As required by the buyer.
8. Back-up operating system: To operate lift manually in case of power failure.
9. Other features to consider:
 - A. Lift cycle times.
 - B. Power requirements.
 - C. Platform safety barrier type and operation.

Wheelchair Securement Devices (Tie-downs)

Usually located along driver's side wall, to allow for wheelchair facing toward opposite side wall. Other locations should be specified according to number of positions needed and overall seating layout desired.

1. Pin-type manual system: pins lock through each wheel, with restraint belt for occupant.
2. Belt-type manual system: belts anchor wheels, with restraint belt for occupant.
3. Automatic system: locks wheels automatically when backed into, with restraint belt for occupant.

Passenger Counter

Tally counter with keys for different rider categories to be counted (Adult, Senior, Youth, Transfer, Token/Ticket, etc.). Typical counter has 3-5 keys. Should be mounted for ease of use by driver. Counters are necessary when trips are not pre-scheduled or recorded otherwise.

Jack

For tire changing: Should be mounted in an accessible location so as not to interfere with passenger seating.

Emergency Equipment

Vans should be specified with the following minimum items for safety:

1. 12 unit first-aid kit.
2. 5-lb. ABC fire extinguisher.

3. Triangular reflector kit (or road flares).

All items should be mounted easily accessible to driver.

Speed Control

Optional automatic speed (cruise) control: May be desirable for highway-type service. Not necessary for in-town service.

Windshield Wipers

1. Standard on all models: Two-speed electric.
2. Optional: Intermittant.

Radio

1. Manufacturer's AM-FM-CB radio and antenna: May be specified if transit operator is not using two-way radio system.
2. Two-way radio: Can be specified separately from van and added after van is delivered. If transit operator is not currently using two-way system, base station and antenna will also be necessary. Some vendors may be able to include two-way radio in overall vehicle package bid.

BODY ON CHASSIS TRANSIT VEHICLE SPECIFICATION GUIDE

Body on chassis vehicles are produced in two basic ways. The first method involves building a bus body on the rear of a commercial van cutaway chassis (see Figure 5). In the second method, a complete bus body is built on a truck or motor home chassis. This method is also used to manufacture standard school buses, and some of the models are produced in both school bus and transit or para-transit versions, with the chief differences between them being paint and equipment. As mentioned earlier, standard school buses are not within the scope of this guide.

Both the van cutaway type and truck chassis type body on chassis buses are available in various sizes, ranging from 17 feet long to 30 feet long. Many transit experts feel, however, that the very long body on chassis models (those over 23' in body length) are not suitable for heavy duty, continuous transit applications, and should be passed over in favor of small, heavy duty transit buses when selecting a vehicle of over 22 or 23 passenger capacity. For this reason, the following Body on Chassis Specification Guide focuses on vehicles in the 17' – 23' range. Some manufacturers also produce body on chassis models with less than full standing head room (72") which are also not suitable for most transit applications. The guide considers only full headroom models.

Body on chassis vehicle manufacturers are the best source of information on these vehicles. The manufacturers can supply prospective buyers with brochures and general specifications on their products, and may also be able to furnish detailed specifications on bodies, chassis, and equipment. Chassis and equipment manufacturers, such as auto/truck manufacturers and wheelchair lift manufacturers, can also supply information if it is not readily available from the bus builder. Body on chassis manufacturers often work through regional distributors who may do the actual bidding and can provide technical data to the buyer.

Many variations in wheelbase, GVW, engines, body configuration, seating layout, and other characteristics of body on chassis buses are offered by each manufacturer. For this reason, very careful consideration of needs and budget is important when preparing specifications for such a vehicle.

The following Specification Guide presents dimensions, size ranges, and specification alternatives to consider when preparing technical specifications for body on chassis buses. These are the basic items to include; there may be more detailed specifications necessary for bidding a particular vehicle.

BODY ON CHASSIS BODY SPECIFICATIONS

Dimensions

1. Wheelbase: 110", 125", 138", 146", 158"
2. Overall height, measured from ground to top of roof: 104" – 117" (including a/c unit)
3. Body width: 84" – 96"
4. Interior width: 78" – 91"
5. Body length (bumper to bumper): 17' – 23'
6. Interior height (headroom): 72" – 80"
7. Step heights: (See passenger door and stepwell section)
8. Step tread depths: (See passenger door and stepwell section)

FIGURE 5
BODY ON CHASSIS CONSTRUCTION
(Van Cutaway Type)

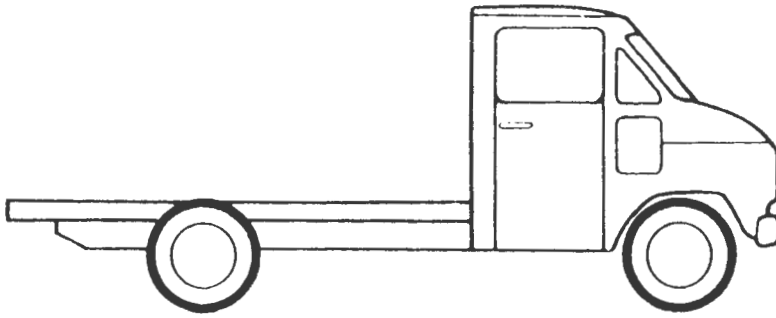

1 Chassis is purchased by the body builder.

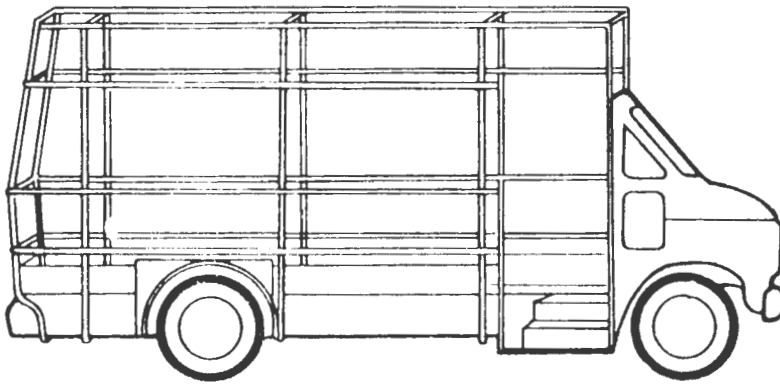

2 A framework is built for the body.

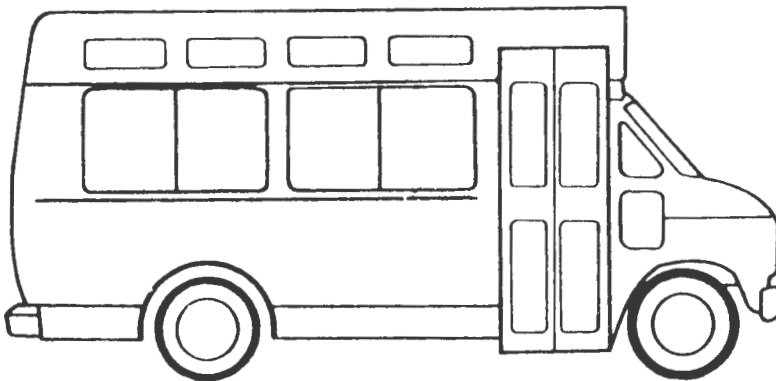

3 The body is finished and the vehicle is complete.

Seating

1. Seating layout: There is an endless variety of possible seating layouts in body on chassis buses. Forward facing seating, perimeter seating, and combinations of both, along with wheelchair positions are common in these vehicles. Figure 6 displays a few typical configurations. Wheelchair positions are usually specified with jumpseats which fold out of the way when the position is being used by a wheelchair. Number of seats and wheelchair positions (if any) required should be clearly identified in specification. Dimensions and seating materials or colors should also be specified.
2. Seat belts: Optional. Most transit operations do not use seat belts in this type of vehicle. Driver's seat should be provided with lap and shoulder belts.

Windows and Mirrors

1. Windows: Windows should be transit-type, openable safety glass windows, and should provide for positive locking from the inside. Tinted glass is desirable, and essential for air-conditioned vehicles.
2. Mirrors
 - A. Outside rear-view: Low mount flat mirrors – one per side.
 - B. Outside convex mirrors: In addition to flat mirrors.
 - C. Inside rear-view mirror: Should afford driver view of all passengers.

Doors

1. Passenger Door and Stepwell
 - A. Extended van right front passenger door: On van cutaway-type buses. This type of door may be offered as standard, with bus-type door optional. Door should be raised into roof so as to provide minimum clear entry height of 72". Stepwell should be extended at front passenger door so that ground to step height is no more than 12", plus or minus 1", and step tread depth is minimum 7". Each additional step to floor of bus should not exceed 9", and should have minimum tread depth of 7". All steps should be covered with anti-skid, ribbed molded rubber tread.
 - B. Bus-type door: Door should be located on right side of vehicle behind right front wheel. Door should be double folding-split type with flexible rubber cushion at least 1½" on center meeting edge, and at bottom of doors for seal to stepwell. Clear entry height should be minimum of 72" (top of first step to door header). Ground to first step should not exceed 12" plus or minus 1" in height, with each additional vertical step 9" maximum. All tread depths should be a minimum of 9". Door should be a minimum of 24" in clear opening width.
 - C. Door opener: Should be easily operable from driver's position.
 - 1.) Manual: Heavy-duty school bus type manual opener. Should not intrude into entry area and should be securely affixed to structural members of body to ensure rigidity.
 - 2.) Power-operated.

FIGURE 6

BODY ON CHASSIS SEATING LAYOUTS

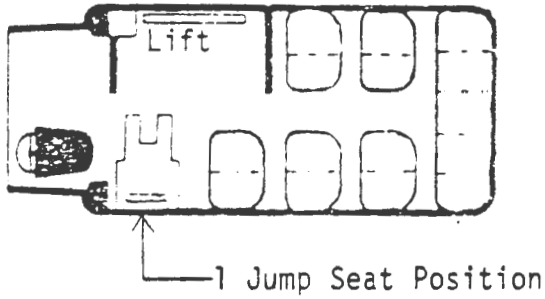

16 Passengers with one tie-down

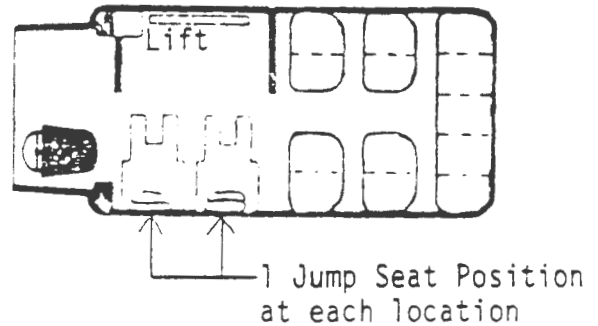

15 Passengers with two tie-downs

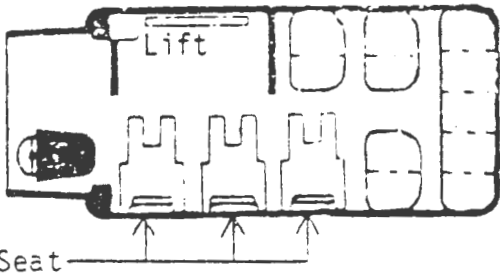

14 Passengers with three tie-downs

OR

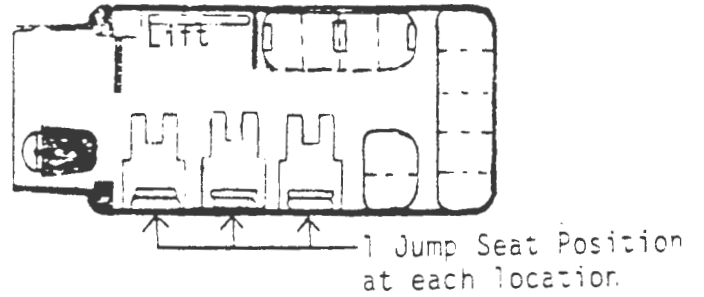

14 Passengers with three tie-downs

1 Jump Seat Position at each location

1 Jump Seat Position at each location.

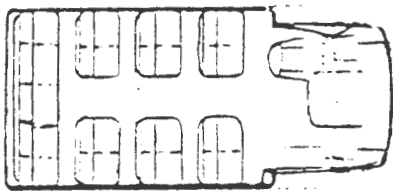

17 Passengers, no lift

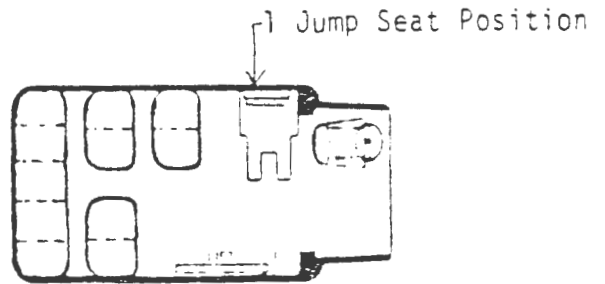

12 Passengers with one tie-down

1 Jump Seat Position at each location

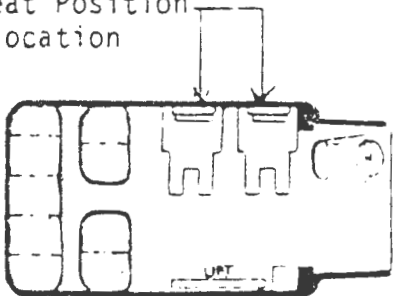

11 Passengers with two tie-downs

2 Jump Seat Positions

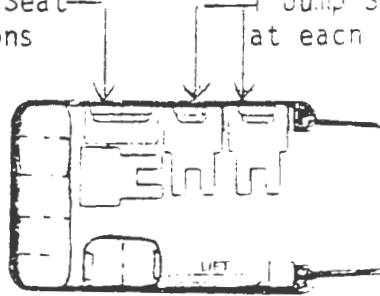

10 Passengers with three tie-downs

FIGURE 6 (continued)

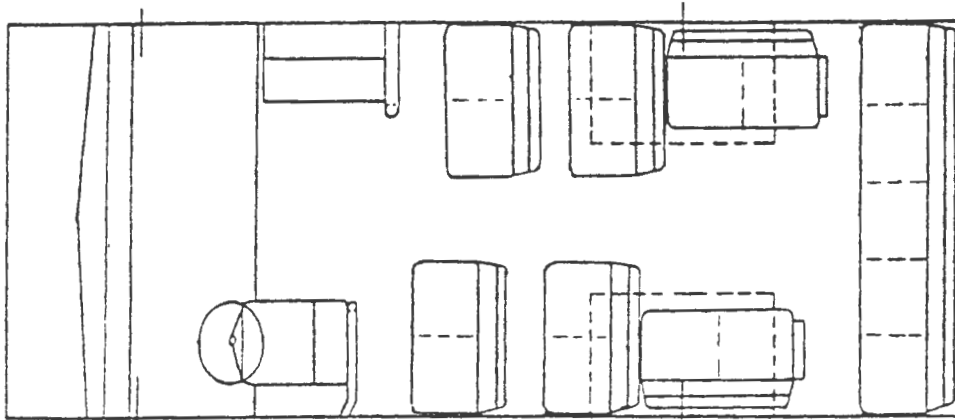

17 Passengers, no lift

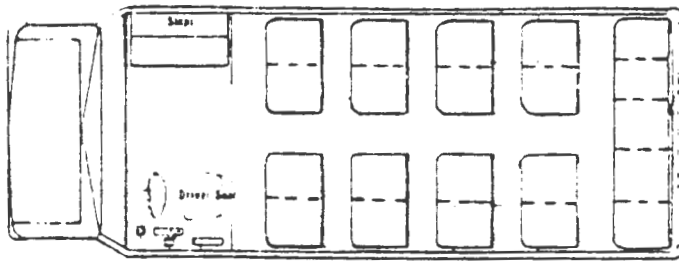

21 Passengers, no lift

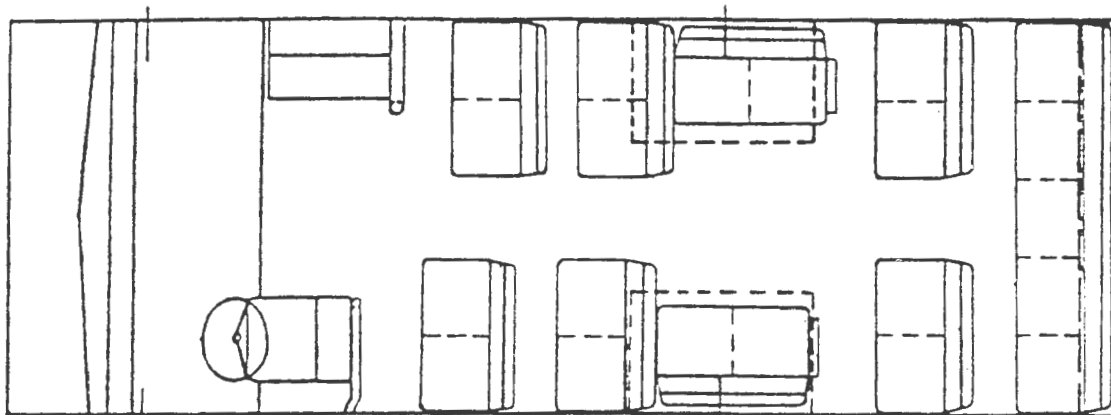

21 Passengers, no lift

2. Rear door: Optional, for use as emergency exit. If rear door is not provided, alternate emergency exits should be specified, such as windows, roof hatches, etc. If rear door is provided, it should be clearly marked as to its operation in case of emergency.
3. Wheelchair lift access doors: Should be double opening-type with outside fasteners or hold-open feature. Door width should allow operation of lift and should provide minimum clear opening height of 60" – 62".
4. Locks: All doors except bus-type entry door should be of locking design, openable from the inside.

Body Structure

1. Construction: Several methods and materials of construction are employed by manufacturers. Buyers should become aware of the types used by various manufacturers before specifying certain construction types or materials.
2. Roof Structure: Should be of sufficient strength to support entire weight of fully loaded vehicle on its top or side if overturned (able to meet Federal Motor Vehicle Safety Standard (FMVSS) for roll over protection).

Interior

All interior panels, materials, and treatments should be flame retardant and treated to be easily cleaned.

1. Colors: Should harmonize with exterior vehicle colors.
2. Padding: All surfaces and items of hardware, including wheelchair lift, in passenger compartment having sharp edges, angles, or corners that could cause injury should be padded with a heavy-duty, vinyl-covered energy absorbing material.
3. Insulation: Heavy-duty insulation of a fire-and mildew-resistant type should be provided throughout roof, sidewalls, and doors for heat efficiency and noise suppression, and be thoroughly sealed to prevent drafts.
4. Grabrails and Stanchions: A floor-to-ceiling stanchion should be provided in close proximity to the driver with provisions for attaching the farebox. A guard rail can be provided in back of the operator, extending from the vertical stanchion to the left side of the coach 30" plus or minus 2" above the floor and a padded modesty panel from guard rail to the floor (exception, not provided in lift vehicle). This stanchion should not impair driver's seat adjustment.

Left and right side entrance grab rails should be positioned so passengers entering vehicle will not use door opening device for support when boarding the bus. Padded vinyl clad, heavy-duty modesty panel should be provided to the left of the entrance door with a floor-to-ceiling stanchion provided at aisle. The guard rail should be 30" plus or minus 2" above the floor, (in case of lift vehicles, provide floor-to-ceiling guard rail and modesty panel to rear of lift).

Two full length transit-type ceiling grab rails should be provided and securely attached to roof section. The guard rails and all stanchions should be a minimum of one inch inside diameter steel covered and glued with heavy, pre-molded, energy-absorbing padding except ceiling grab rails which should be stainless steel. All grab rails and stanchions should be positioned so as not to interfere with wheelchair movement. All stanchion mountings should have reinforcement plates welded to structure behind panels of sufficient strength to withstand passenger force.

5. Lighting: Should be provided at roof and/or side wall locations to provide interior illumination sufficient for reading in the following areas:
 - A. Driver's station
 - B. Front passenger door and stepwell
 - C. Wheelchair lift access doors — should also illuminate lift platform for night operation.
 - D. Main passenger compartment.

Buyer should determine appropriate types and locations of lighting controls when preparing specification.

Floor

Floor should be covered with ½" minimum exterior grade plywood with sealed edges. Stepwell, entrance area, and center aisle floor area should be overlaid with ribbed, commercial rubber flooring. Floor in seating area should be smooth commercial grade rubber flooring. Step treads should be ribbed rubber flooring with a band of bright contrasting color running width of step on outside edge.

Paint and Rustproofing

1. Exterior colors: Should be selected by buyer from vehicle manufacturer's available paint schemes. Type of paint should be specified by buyer.
2. Logo: Logo or trade name of transit operator should be painted on sides, front, and rear (if feasible) of vehicle, along with phone number or other information supplied by buyer.
3. Rustproofing: Several brands and processes of rustproofing are available to be specified. The bus should be thoroughly rustproofed to resist corrosion from atmospheric conditions and road salt.

Heating and Air Conditioning

1. Heating: Integral (dash outlet) heater and rear auxiliary heater should have capacity to maintain minimum 60° F at knee level throughout interior of bus when outside temperature is 0° F and bus is traveling in stop and go operation. Stepwell should include heat duct or sufficient heat to prevent ice buildup. Bus can be specified to have floor level fresh air vents next to driver's feet and ahead of passenger door for air circulation. Defroster should be capable of keeping windshield and driver's side window clear during inclement weather conditions.
2. Air Conditioning: Optional. Buses specified with air conditioning should require manufacturer's heaviest duty integral (dash outlet) unit and heavy-duty auxiliary rear unit for cooling passenger compartment. Cooling capacity in terms of BTU's should be determined by buyer in specification. Buses specified with air conditioning should also have tinted windows, maximum insulation package available, and additional heavy-duty engine cooling capability.

BODY ON CHASSIS, CHASSIS SPECIFICATIONS

Wheelbase

(see Body Specifications)

Gross Vehicle Weight GVW Rating

Number representing weight of vehicle plus maximum load capacity. Specifications should identify minimum GVW. Body on chassis GVW's range from 9,500 lbs. to 12,500 lbs.

Engine

1. V-8 gasoline engine: 350, 351, 360, 454, 460 CID available.
2. Diesel: Sizes range from 6.2 L (379 CID) to 8.2 L (500 CID) six and eight cylinder.

Engine cover should insulate interior of vehicle from heat and noise with 1" minimum non-absorbent (oil or water) insulation.

Transmission

Should be heavy-duty, three speed automatic, and cooled by an external transmission oil cooler with capacity to match GVW of vehicle.

Cooling System

Heaviest-duty, extra cooling capacity radiator, water pump, pulley, and clutch type fan with coolant recovery system available from chassis manufacturer should be specified. Cooling system should be winterized for negative 25° F.

Brakes

Heaviest-duty available power-assisted dual hydraulic system should be specified. Front disc and rear drum or disc all around should be required. Disc and drum size, along with lining or pad area should be specified minimum to match GVW. Parking brake should also be required.

Suspension

1. Axles: Should have weight ratings compatible with GVW rating.
2. Springs: Should match GVW.
3. Optional air ride: Available on some models.
4. Shock absorbers: Heaviest duty available from chassis manufacturer.
5. Front stabilizer bar: Heaviest duty should be specified.

Wheels and Tires

1. Wheels: 16½" wheels are standard on most van cutaway models. Larger wheels can be specified on truck chassis models. All but the lightest GVW buses should be equipped with dual rear wheels.

2. Tires: Tire size must match vehicle GVW. Steel belted radial tires are standard on some models.
3. Spare tire: Same size and type tire as on vehicle should be provided on matching rim, stored in an accessible location not interfering with passenger compartment.

Steering

Heavy duty power assisted with tilt steering wheel should be specified.

Electrical System

1. Battery: Buyer should determine whether standard or maintenance-free battery is required. Many transit operators do not recommend the maintenance-free type.
 - A. Single battery
 - B. Dual batteries

Batteries should be mounted in an easily accessible and secure location. Capacity of each battery should be 60 amp minimum.

2. Alternator: Minimum capacity in amps should be specified (100 – 120 amps typical), and should be installed and equipped to accommodate the equipment specified with the vehicle. Alternator output should exceed the vehicle's electrical draw when all systems are functioning simultaneously.
3. Wiring: All wiring should be coded, and the builder should furnish a complete wiring diagram, marked to show the code used. All wiring added to chassis fuse block should be securely fastened to prevent wires from being kicked loose by driver. All wiring should be grounded to body frame structure to capacity of each system, and, to chassis for complete system. Wiring construction methods and materials should be specified by buyer.

Fuel Tank

Buyer should specify minimum fuel tank capacity. 40 gallon minimum is typical.

Bumpers and Towing Hooks

1. Front and rear bumpers
 - A. Manufacturer's standard – chrome or painted.
 - B. Energy absorbing bumpers – desirable for vehicles to be used in heavy traffic.
2. Towing hooks: Should be mounted to chassis frame and adequately braced, two in front and two in rear of bus. Should be of sufficient strength to tow 1½ times the GVW rating of the bus. Hooks should be installed so that bus can be safely towed and lifted without damage to bus body, frame, and bumpers.

BODY ON CHASSIS EQUIPMENT SPECIFICATIONS

Farebox

Size and type should be specified according to amount and types of tender to be handled. Two interchangeable, lockable vaults, keyed alike with a double set of keys for each lock, should be provided. Vault and farebox exteriors should be marked with key identification.

1. Capacity: \$100 – \$300
2. Capability: Mixed coins, paper currency, tokens, etc.

Destination Sign

Should be specified for fixed route or other types of service requiring route identification.

1. Fixed card-type sign.
2. Roller curtain sign: hand crank or electrically powered operation.

Gauges

Bus should be equipped with the following needle-type gauges:

1. Ammeter
2. Oil pressure gauge
3. Water temperature gauge
4. Fuel gauge
5. Air operated and vacuum-assisted accessories should have pressure gauges easily read by driver.

Wheelchair Ramp

Usually specified for vehicles expecting only infrequent carrying of wheelchair passengers. Ramps require the wheelchair passenger to be physically pushed up the ramp and into vehicle – not practical for many paratransit operations.

Wheelchair Lift

Lift is usually located in extended side doors of bus.

1. Mechanism type
 - A. Electro-hydraulic: Operates by means of electrically-driven hydraulic cylinders.
 - B. Electro-mechanical: Operates by means of gears or chain drives.

2. Capacity: 600 to 900 lbs.
3. Operating modes
 - A. Fully automatic: Powered raise and fold.
 - B. Semi-automatic: Power raise, manual fold (counter-balanced).
4. Weight: 150 to 340 lbs.
5. Platform type
 - A. Vertical fold-down: Supported on both sides of platform, folds to store in upright position.
 - B. Vertical fold-down in two hinged sections: One section folds back on the other to allow for usable entry space in side doors.
 - C. Swing-away: Platform pivots from one corner. Since passenger enters platform parallel to vehicle, van must have sliding-type side door. Platform not as stable as vertical fold-down type. Also, platform takes up space on floor of van when stored, unlike vertical fold-down type. Not recommended for transit applications.
6. Platform dimensions: Platform should be large enough to accommodate the variety of wheelchairs to be carried, including extra clearance at sides to allow for maneuvering on and off of platform. Standard wheelchair is 24" wide. Oversized wheelchairs are up to 28" – 30" wide.
7. Controls: Most lift controls require continuous pressure on the buttons or switches, which helps to insure that the lift is operated safely.
 - A. Controls located on inside of side doors, with extension cord to allow use of controls by attendant or passenger on lift.
 - B. Controls located on lift.
 - C. Other locations: As required by the buyer.
8. Back-up operating system: To operate lift manually in case of power failure.
9. Other features to consider:
 - A. Lift cycle times.
 - B. Power requirements.
 - C. Platform safety barrier type and operation.

Wheelchair Securement Devices (Tie-downs)

Usually located along driver's side wall, to allow for wheelchair facing toward opposite side wall. Other locations should be specified according to number of positions needed and overall seating layout desired.

1. Pin-type manual system: pins lock through each wheel, with restraint belt for occupant.
2. Belt-type manual system: belts anchor wheels, with restraint belt for occupant.
3. Automatic system: locks wheels automatically when backed into, with restraint belt for occupant.

Passenger Counter

Tally counter with keys for different rider categories to be counted (Adult, Senior, Youth, Transfer, Token/Ticket, etc.). Typical counter has 3-5 keys. Should be mounted for ease of use by driver. Counters are necessary when trips are not pre-scheduled or recorded otherwise.

Jack

For tire changing: Should be mounted in an accessible location inside bus so as not to interfere with passenger seating. (Jack is to be used to raise vehicle for switching outside rear dual wheel to front in case of flat tire, or to raise for installing spare tire, if stored on vehicle.)

Emergency Equipment

Bus should be specified with the following minimum items for safety:

1. 12 unit first-aid kit.
2. 5-lb. ABC fire extinguisher.
3. Triangular reflector kit (or road flares).

All items should be mounted easily accessible to driver.

Windshield Wipers

1. Standard on all models: Two-speed electric.
2. Optional: Intermittant.

Radio

1. Manufacturer's AM-FM-CB radio and antenna: May be specified if transit operator is not using two-way radio system.
2. Two-way radio: Can be specified separately from bus and added after bus is delivered. If transit operator is not currently using two-way system, base station and antenna will also be necessary. Some vendors may be able to include two-way radio in overall vehicle package bid.

Sun Visor

Swivel-mounted sun visor should be provided on driver's side of windshield.

Horn

Dual electric horn should be specified.

Safety Buzzers

1. If buyer deems necessary, safety buzzer that is readily audible outside the vehicle when transmission is in reverse can be specified.
2. Interior warning buzzer to activate when rear door (if any) is open.

SMALL BUSES

Small, heavy duty transit buses differ from vans and body on chassis vehicles in that each model is designed as a single unit for transit use. Because of this, there is not the standardization of chassis and components as in the other types. While large buses (35' and above) have been produced for a sufficient time and in large quantities to provide good information on maintenance and performance, most of the smaller models are new and performance information is not available. The small buses vary greatly as to their configurations – some are forward control (front engine, rear wheel drive), some are rear engined, and some are front wheel drive with a low floor.

Because of the variety in design and components, this section of the report will not provide a component-by-component guide to writing technical specifications. Instead, a listing of available vehicles and their major characteristics is presented (Table 3).

The best sources for information on small heavy duty buses are usually the manufacturers themselves, dealers or distributors (if any), and other transit properties which have recently purchased similar equipment. The U.S. DOT and some State Departments of Transportation also are involved in purchasing or developing specifications for vehicles. The Division of Public Transportation maintains a file of both manufacturer's literature and specifications, and bid specifications from transit properties and other states.

There are many technical details to consider when preparing specifications for a heavy duty transit bus. Most small transit operators do not have the staff capability to develop detailed technical specifications for small heavy duty buses, and subsequently to give defensible engineering reasons when accepting or rejecting requests for exceptions on vehicle bids (refer to the Division of Public Transportation's *Capital Procurement Guide for Vehicles and Equipment* for guidance on this process). Therefore, it is suggested that the buyer thoroughly research the bus market before preparing specifications, and that the buyer should seek assistance in preparing and reviewing the specifications from sources knowledgeable on the subject. Figure 7 shows some of the major characteristics to consider when developing specifications. This form is an example of a request for detailed information from bidders that would be part of a vehicle procurement bid package.

TABLE 3 SMALL HEAVY DUTY BUSES

Manufacturer	Model	Seating Capacity	GVW (lbs.)	Empty Weight (lbs.)	Engine Type/ Location	Displacement/ Horsepower	ADV. MPG	LOA (ft.)	Suspension Type	Brake Type	Est. Oper. Life Miles	Price \$	AC \$	Lift \$
Blue Bird Body Co.	City Bird CBPP2605	25	36,400	20,040	Diesel/rear	318 CID/ 225 HP	5.3-6.2	26	Air	Air	12-15 yrs.	100,000	10,000	12,000
	City Bird CBPP2904	31	36,400	22,000	Diesel/rear	426 CID/ 225 HP	5.3-6.2	30	Air	Air	12-15 yrs.	110,000	10,000	12,000
Bus Industries of America/ Ontario Bus Industries	Orion II (Prototype)	18 26	15,350 18,500	N/A	Diesel/front (FWD)	105 HP 8.2L (500 CID)/ 130 HP	N/A	22 26	Air	Air	N/A	75,000-80,000	N/A	Ramp incl. (low floor)
	Orion 30' 01.502	31	28,400	19,250	Diesel/rear	318 CID/ 223 HP	5.9	30	Air	Air	15-18 yrs. 1.5 mil. mi.	105,000	10,000	11,500
Carpenter Body Works	CBW 300	2 dr.-29 1 dr.-33	34,500	19,500	Diesel/rear	318 CID/ 225 HP	N/A	30	Air	Air	N/A	105,000	N/A	N/A
Chance Coach, Inc.	RT-50	25	22,000	14,500 (15,400 w/lift)	Diesel/front	636 CID/ 175 HP	7	26	Air	Air	750,000	110,000	Incl.	10,000
Gillig Corporation	Phantom 30'	33	21,500	N/A	Diesel/rear	552 CID/ 263 HP	4-5	30	Air	Air	1 million	110,000-125,000	5,000	12,000
Neoplan USA Corp.	AN426 Lit'l Bus	24-27	21,000	13,860	Diesel/rear	8.2L (500 CID) /165 HP	5-10	26	Air	Air	500,000	80,000-90,000	Incl.	Option Avail.
Skillcraft Industries, Inc.	Transmaster	23 27	22,500 23,500	16,500 17,500	Diesel/rear	8.2L (500 CID) /205 HP	7	28 30	Leaf Spring (Air Option.)	Air Air	500,000	80,000-90,000	7,000	1,500 (Ramp-low floor)
Specialty Vehicle Manufacturing Corp.	Series 2500	25-30	21,000-24,000	N/A	Gas or diesel/ front	Diesel: 8.2 L (500 CID)	N/A	25-28	Leaf Spring (Air Option.)	Hydraulic (Air Option.)	N/A	48,000-65,000	Incl.	Option Avail.
Steyr-Daimler-Puch AG	Steyr City Bus SC6-F65	15	9,700	5,800	Diesel/front (FWD)	2.4 L/72 HP	15	20	Coil Spring front Air rear	Hydraulic: disc front drum rear	12-15 yrs. @ 36,000 miles/yr.	78,000	7,500	Ramp Incl. (low floor)
Thomas Built Buses, Inc.	Transit-Liner 31'	27	N/A	21,000	Diesel/rear	N/A	N/A	31	Leaf Spring	Air	N/A	N/A	N/A	N/A

Abbreviations: GVW – Gross Vehicle Weight rating
 ADV. MPG – Advertised fuel economy in miles per gallon
 LOA – Body length overall
 FWD – Front Wheel Drive

FIGURE 7

DETAILED INFORMATION SHEET FOR SMALL HEAVY DUTY TRANSIT BUS

Chassis Make/Model _____ Body Make/Model _____ Year _____

Engine: Number of Cylinders _____

Displacement (C.I.D.) _____

Torque, Net (Ft. Lbs.) _____

Horsepower, Net _____

Wheelbase (In.) _____

Transmission, Make/Model _____

Clutch Diameter _____

Drive Axle, Make/Model _____

Rear Spring Capacity (Lbs. at Each Pad) _____

Auxiliary Spring Capacity (Lbs. at Each Pad) _____

Rear Axle Gear Ratio _____

Front Axle Capacity (Lbs.) _____

Front Spring Capacity (Lbs. at Each Pad) _____

Brake Lining Area (Sq. In.) _____

Cooling System Capacity (Qts.) _____

Alternator Capacity (Amps) _____

Battery Rating (Cranking Amps at 0° F) _____

Tires: Size _____ Load Range _____

Warranty: Chassis _____

Body _____

Lift _____

By _____

Company _____

Address _____

City _____ State _____ Zip Code _____

Phone No.: (_____) _____

APPENDIX A

MANUFACTURERS OF SMALL TRANSIT VEHICLES

Standard Vans

Chevrolet Motor Division, General Motors Corporation
Dodge Trucks Division, Chrysler Corporation
Ford Division, Ford Motor Company
GMC Truck and Coach Division, General Motors Corporation
Plymouth Division, Chrysler Corporation
Volkswagen of America

Modified Vans

Ahnafield Automotive
3200 West Washington Street
Indianapolis, Indiana 46222
ATTN: Bruce Ahnafield
(317) 636-8061

Castleton Coach, Inc.
8481 Bash, P.O. Box 50248
Indianapolis, Indiana 46250
ATTN: Buck Retmier
(317) 849-3304

R.J. Mobility Systems
715 South 5th Avenue
Maywood, Illinois 60153
(312) 344-2705

Aim Sales & Service, Inc.
2839 Merchant's Drive
Indianapolis, Indiana 46222
ATTN: Tom Brouse
(317) 923-2256

Gresham Driving Aids, Inc.
P.O. Box 405
30800 Wixom Road
Wixom, Michigan 48096
(313) 624-1533

Turtle Top, Inc.
118 West Lafayette Street
Goshen, Indiana 46526
ATTN: Richard D. Cripe
(219) 533-4116

Braun Corporation
1014 South Monticello
Winamac, Indiana 46996
ATTN: Michael R. Bruno
(219) 946-6157

National Coach Corporation
130 West Victoria
Gardena, California 90248
(213) 538-3122

Body on Chassis Buses

Blue Bird Body Company
P.O. Box 937
Fort Valley, Georgia 31030
(912) 825-2021

Models produced: Micro-Bird (van cutaway)
 Mini-Bird (truck chassis)

American Transportation Corporation
Highway 65, South
Conway, Arkansas 72032
(501) 327-7761

Models produced: Ward VMS
 Ward VCS Vanguard

Carpenter Body Works, Inc.
West Main Street
Mitchell, Indiana 47446
ATTN: Dick O'Neil
(812) 849-3131
Models produced: Cadet (truck chassis)

Champion Home Builders Company
Commercial Vehicle Division
P.O. Box 96
331 Graham Road
Imlay City, Michigan 48444
(313) 724-6474
Models produced: Medium Duty Bus (van cutaway)

Coach & Equipment Manufacturing Corporation
P.O. Box 36
Penn Yan, New York 14527
(315) 536-2321
Models produced: Fortivan (van cutaway)
Fortibus (truck chassis)

Collins Industries, Inc.
P.O. Box 58
Hutchinson, Kansas 67501
ATTN: Gary Goetsch
(316) 663-4411
Models produced: Omni/Bus (van cutaway)

Coons Manufacturing, Inc.
P.O. Box 489
Oswego, Kansas 67356
(316) 795-2191
Models produced: Diamond People Mover
(van cutaway)

El Dorado, Inc.
P.O. Box 266
Minneapolis, Kansas 67467
(913) 392-2171
Models produced: Falcon (van cutaway)

Flxette Transportation
P.O. Box 410
Evergreen, Alabama 36401
(205) 578-1820 or (800) 992-6445
Models produced: Series 10 (truck chassis)
Series 20 (truck chassis)

HCI
2516 West Pennway
Kansas City, Missouri
(816) 471-0305
Models produced: Alumibus (truck chassis)

National Coach Corporation
130 West Victoria
Gardena, California 90248
(213) 538-3122
Models produced: Escort (van cutaway)
Escort II (van cutaway)

Specialty Vehicle Manufacturing Corporation
12450 Lakeland
Santa Fe Springs, California 90670
(213) 946-6881
Models produced: C-20 (van cutaway)

Superior Bus Manufacturing, Ltd.
Morris, Manitoba, Canada ROGIKO
(204) 746-2333
Models produced: Pioneer (truck chassis)

Thomas Built Buses, Inc.
1408 Courtesy Road
High Point, North Carolina 27261
(919) 889-4871
Models produced: Minotour (van cutaway)
Mighty Mite (truck chassis)

Turtle Top, Inc.
118 West Lafayette Street
Goshen, Indiana 46526
(219) 533-4116
Models produced: Terra Transit T IV-E
(van cutaway)

Wayne Corporation
P.O. Box 1447
Industries Road
Richmond, Indiana 47374
(317) 962-7511

Models produced: Chaperone (van cutaway)
Transette (van cutaway)

Wide One Corporation
3051 East LaPalma Avenue
Anaheim, California 92806
(714) 630-7933

Models produced: Wide One

Small Heavy Duty Buses

Blue Bird Body Company
P.O. Box 937
Fort Valley, Georgia 31030
ATTN: Steve Mann
(912) 825-2021

Models produced: City Bird 26' and 30'
transit bus

Bus Industries of America
Oneida County Airport Industrial Park
Oriskany, New York 13424
ATTN: Gord Nevison
(315) 768-8101

Models produced: Orion 30' transit bus
Orion II 22' and 26'' low
floor, front wheel drive
transit bus (prototype)

Carpenter Body Works, Inc.
West Main Street
Mitchell, Indiana 47446

(812) 849-3131

Models produced: CBW 300 transit bus

Chance Coach, Inc.
P.O. Box 12328
Wichita, Kansas 67277
(316) 942-7411

Models produced: RT-50 transit bus

Gillig Corporation
P.O. Box 3008
Hayward, California 94540
(415) 785-1500

Models produced: Phantom 30' transit bus

Neoplan USA Corporation
627 South Broadway, Suite B
Boulder, Colorado 80303
(303) 499-4040

Models produced: Lit'l Bus 26' transit bus

Skillcraft Industries, Inc.
355 Center Court
Venice, Florida 33595
(813) 488-1501

Models produced: Transmaster 28' and 30'
transit buses

Specialty Vehicle Manufacturing Corporation
12450 Lakeland
Santa Fe Springs, California 90670
(213) 946-6881

Models produced: Series 2500 transit buses

Steyr-Daimler-Puch AG
Werke Wien
2 Haidquerstrasse 3
1111 Vienna, Austria
(0222) 74 16 11

Models produced: Steyr City Bus

Thomas Built Buses, Inc.
1408 Courtesy Road
High Point, North Carolina 27261
(919) 889-4871

Models produced: Transit Liner 31'
transit bus

APPENDIX B

EXAMPLE SPECIFICATIONS FOR AN 11-PASSENGER MODIFIED VAN

The purpose of these specifications is to provide for a passenger van seating 11 passengers and including a raised roof and doors, wheelchair lift, and other modifications suitable for use in public transit and elderly and handicapped persons. The vehicle shall be the latest current model maxi-van under production at the time the bid is submitted, and shall conform to all applicable Federal Motor Vehicle Safety Standards. The successful bidder shall title and deliver the vehicle to the location specified herein. Any deviation from these specifications shall be approved by the Union County Council on Aging and Aged, Inc., acting as agent for the Union County Board of Commissioners. The vehicle shall be equipped as normally supplied by the manufacturer, and shall satisfy the following requirements:

I. BODY SPECIFICATIONS

A. Dimensions

72'' minimum interior floor-to-roof height. Minimum overall body length shall be 220'' (15 passenger maxi-van). Maximum body width shall be 83''.

B. Body Structure

Body shall be of sufficient strength to support entire weight of fully loaded vehicle on its top or side, if overturned.

C. Passenger Door and Stepwell

Standard van front passenger door shall be extended into raised roof as is practicable (minimum clear entry height of 72''). Stepwell shall be extended at front passenger door so that ground-to-step height is no more than 11'' + 1'' and step tread is minimum 8''. This step shall be a minimum of 18'' in width. Each additional step to floor of van shall not exceed 9'' in height and shall have minimum tread depth of 8''. All interior steps are to be covered with anti-skid ribbed moulded rubber tread. Grab rails are to be provided at least one side of the stepwell/entry area for use of boarding passengers. Vertical stanchions with rubber or other non-slip covering are to be provided in either side of entry area, as shown in Figure 1. Front door shall be operated by mechanical, school-bus type opener from driver's seat.

D. Floor

Floor shall be covered with ½'' minimum plywood and shall be top-covered with commercial rubber flooring, the aisle areas being of anti-skid, ribbed design. However, ribbing shall not interfere with wheelchair movement between lift and wheelchair position.

E. Interior

All interior panels, materials, and treatments shall be flame retardant and treated to be easily cleaned. Colors of all coverings and panels shall harmonize with exterior vehicle colors. All surfaces and items of hardware, including wheelchair lift in passenger compartment having sharp edges, angles, or corners that could cause injury shall be padded with a heavy-duty, vinyl-covered energy absorbing material. Full length headliner shall be provided in both driver and passenger compartments. Heavy-duty insulation of a fire- and mildew-resistant type shall be provided throughout roof and sidewalls for heat efficiency and noise repression, and be thoroughly sealed to avoid drafts.

F. Windows and Mirrors

Tinted safety glass windows with openable feature where possible (minimum one openable per side) are to be provided all around the vehicle, including in wheelchair access doors. Left and right low-mounted bright outside rear-view mirrors not less than 6 inches by 9 inches, as well as rear-view mirror inside cab are required. Windshield shall have dark-tinted sun band along top. Dual 2-speed electric windshield wipers with manufacturer's dual windshield washers shall be furnished.

G. Seats and Wheelchair Position

Forward-facing passenger bench seats with armrests shall be arranged as in Figure 1. These seats include driver's seat, 4-passenger rear bench seat, 3-passenger bench seat, 2-passenger bench seat, and 2-passenger quick-disconnect bench seat at forward of passenger compartment. Seats shall be standard seating provided by chassis manufacturer, modified where necessary to conform with size specifications. Minimum and maximum widths per seat are identified in Figure 1. Retractable seat and shoulder belt shall be provided for driver's seat. Seat belts (not ratchet type) shall be provided for each passenger position per bench seat. Ashtrays shall not be provided in passenger compartment. Bidder shall furnish upholstery sample selection (or usable description) for seating with bid. All exposed seat backs shall be fully padded, or of energy absorbent material. All seat materials shall meet flammability requirements. One wheelchair securement position with positive locking devices shall be provided on driver's side at forward of passenger compartment, beneath quick-disconnect bench seat. The locking devices shall be adjustable to accommodate various wheelchair widths, and attach to both rear wheels of the chair. Restraint belts shall be provided which will completely encompass both the wheelchair and its occupant.

H. Farebox and Stanchion

One small (\$100.00 capacity), lever operated, non-registering farebox shall be provided. It shall be securely mounted or locked on a floor-to-ceiling, non-slip surfaced stanchion located within reach of the driver and easily accessible to passengers entering the van. Two interchangeable farebox vaults keyed alike with four keys shall be supplied with the farebox.

I. Doors

Rear door is to be double-opening type. All doors are to be equipped with button-operated locks. Signage and instructions for use of rear doors in case of emergency shall be clearly legible. Wheelchair lift access doors shall be of double-opening type and shall be located on curb side of van. Door width shall allow operation of lift and shall provide minimum height of 60" from van floor to top of door, being extended into raised roof as far as is practicable. Lift doors shall be designed or equipped so that they can be securely left in the open position.

J. Wheelchair Lift

The lift shall be of electro-hydraulic or electro-mechanical, semi-automatic type design. The design load (capacity) shall be a minimum of 750 pounds while in operation. Operation is to include power up, manual (counter balanced) fold with a manual safety override function in case of primary system malfunction or emergency. The lift shall require no independent power source and shall be compatible with the vehicle's existing (extra heavy duty) electrical power source. Crossbar, if provided shall be extended beyond height of doors so as to allow clear entry into van.

FIGURE 1. 11-PASSENGER MODIFIED, LIFT-EQUIPPED VAN SEATING AND EQUIPMENT LAYOUT

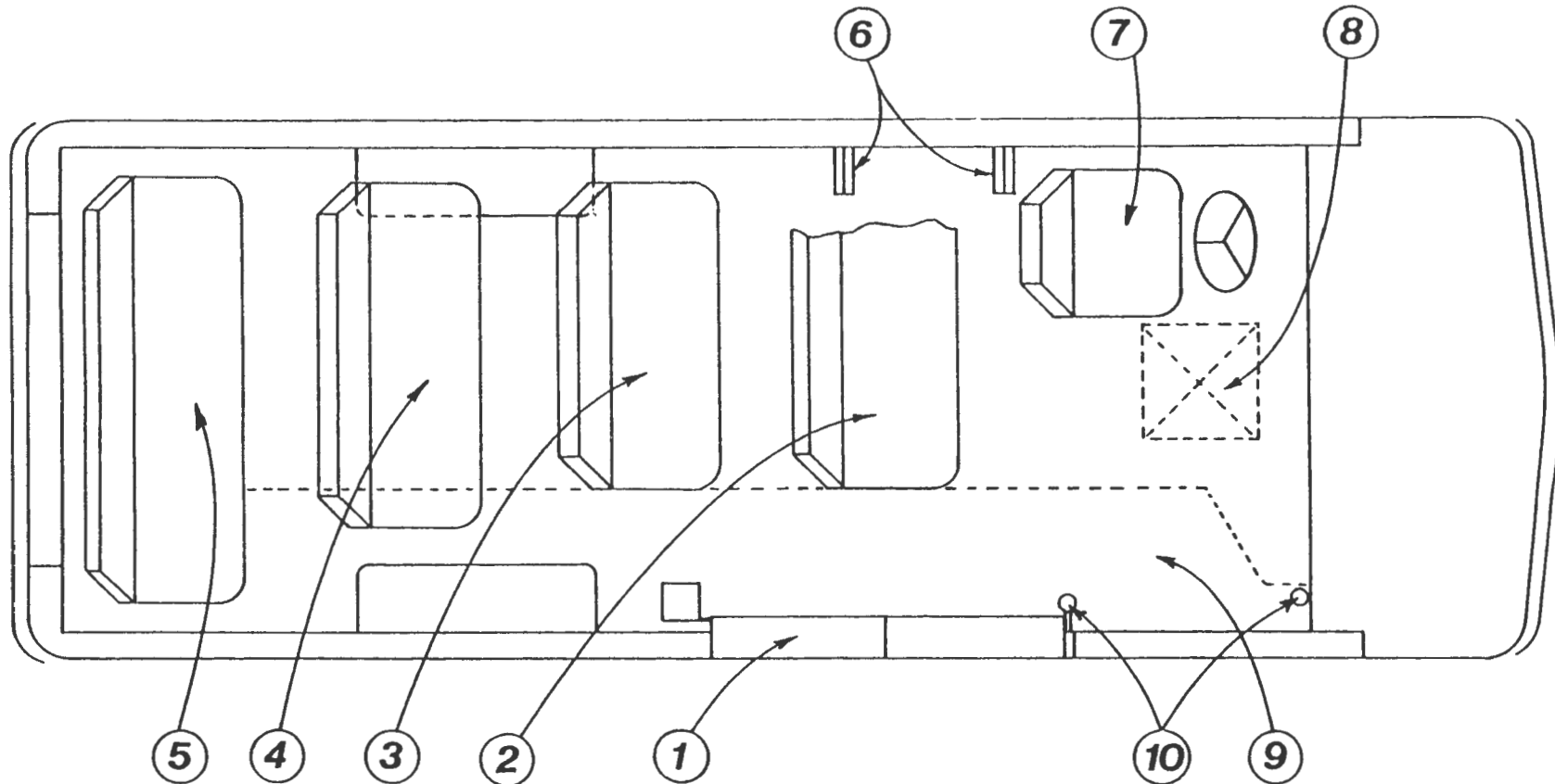

KEY

1. Lift & side doors
2. 2-Passenger quick - disconnect bench seat (Min. 40" Wide, Max. 42" Wide)
3. 2-Passenger bench seat (Min. 40" Wide, Max. 42" Wide)
4. 3-Passenger bench seat (Min. 51" Wide, Max. 53" Wide)
5. 4-Passenger bench seat (Min. 68" Wide)
6. Wheelchair locking devices
7. Driver's seat
8. Placement area for vertical stanchion & farebox
9. Aisle area
10. Vertical stanchions and horizontal grabrail between aft stanchion and doorpost (Locations approximate)

SCALE: 1/2" = 1'

Lift platform shall include locking safety wheel barrier that forms smooth entry ramp onto lift and latches automatically after wheelchair entry. Also to be provided are permanent vertical side plates at least two inches higher than the surface of the platform. Lift platform surface shall be of non-skid expanded metal mesh, or equivalent, to allow for vision through platform. Platform stowed in a vertical position shall be designed to prevent uncontrolled free fall to a horizontal position and to prevent noise from vibration and rattling during vehicle operation. The force necessary to fold and unfold the platform shall not exceed a level that would permit easy operation by persons of average strength. A self-locking, rattle-free mechanism shall be provided to secure the lift in the stored position. Usable platform width and length shall be a minimum of 30 and 43 inches, respectively.

A passenger/attendant handrail that can be easily reached and held during the entire lift cycle shall be provided. The handholds shall be no less than $\frac{3}{4}$ inch in width and shall provide at least $1\frac{1}{2}$ inches of knuckle clearance.

The lift controls shall prevent operation of the lift when the doors are closed, and shall require continuous force from the operator for functioning. A method for storing and securing the controls when not in use shall be provided. Controls shall be hand-held and operate from outboard end of lift platform when in use.

The bidder must certify and show evidence that the lift shall be designed, built, installed, and operated in accordance with all applicable safety codes and design standards. A demonstration may be required. Warranty provisions must be detailed, along with a listing of regional locations for warranty work and procedures for warranty work on the lift.

K. Heating and Air Conditioning

Van manufacturer's heaviest duty heating and air conditioning system shall be provided (dashboard outlets). Auxiliary heat and air units shall be required in the rear of the vehicle.

L. Paint and Rust Proofing

Exterior paint scheme shall be selected by UCCAA from vehicle manufacturer's standard available color schemes. Bidder shall supply selection in time to have color choice made by UCCAA before chassis is ordered. All body modifications shall be painted to match original color of van. "Union County Transit Service" logo shall be painted on both sides and rear of van, details of which are to be provided by UCCAA after bid is awarded. Vehicle shall be thoroughly rustproofed with a heavy duty, comprehensive corrosion inhibiting treatment, including all surfaces exposed to corrosion.

M. Radio

AM-FM-40 channel CB radio shall be provided, along with appropriate antennae, with CB antenna being removable or retractable for washing, if necessary.

N. Interior Lighting

Interior lighting shall be provided at interior roof and/or side wall locations to provide interior illumination at the front of the vehicle near the driver's station; near the access door for ambulatory passengers, and near the wheelchair lift access door. Four lights minimum are to be used.

II. CHASSIS SPECIFICATIONS

The following shall indicate MINIMUM requirements. All parts, accessories, equipment, and safety features considered standard by chassis manufacturer; whether specified herein or not, shall be considered as required.

A. Wheelbase

126 inches minimum.

B. Gross Vehicle Weight (GVW) Rating

8500 pounds minimum.

C. Engine

300 cubic inch displacement V-eight cylinder minimum.

D. Transmission

Three speed automatic, heavy-duty to meet needs of vehicle.

E. Cooling System

Heavy-duty radiator equipped with coolant recovery system. Engine temperature not to exceed 195^o F. To be equipped with permanent-type antifreeze rated to 28^o F below zero.

F. Oil Filter

Spin-on disposable type.

G. Brakes and Wheels

Heavy-duty hydraulic with power assist. Disc front. Single wheels front and rear.

H. Tires

All-season radial ply, tubeless tires with ply rating equal or greater than that necessary to meet minimum G.V.W.R. Spare tire of same type to be provided on matching rim and mounted on outside of rear door of van.

I. Shock Absorbers

Heavy-duty per tire type, front and rear.

J. Alternator

12 volt, minimum 100 amp capacity.

K. Battery

Maximum amp hour capacity battery as supplied by chassis manufacturer.

L. Ignition Switch

To include accessory position.

M. Wiring

All cable and wiring shall be manufacturer's standard and coded. Wiring diagram shall be furnished and marked to show code used. All added wiring shall be installed in a split open-type loom and have a separate fuse box or circuit breaker. Secondary ignition wires to be radio suppression resistant type, electronic, or equal.

N. Fuel Tank

Minimum 30 gallon capacity.

O. Steering Wheel

Tilt-type steering column shall be provided.

III. ADDITIONAL ITEMS TO BE PROVIDED

A. Jack for raising vehicle for tire changing is to be provided and mounted securely and in an accessible location.

B. Emergency Equipment

1. A 16-unit first aid kit shall be provided and mounted in an accessible location.
2. A 5# ABC fire extinguisher shall be provided and mounted in an accessible location.
3. A triangular reflector kit shall be provided and mounted in an accessible location.