

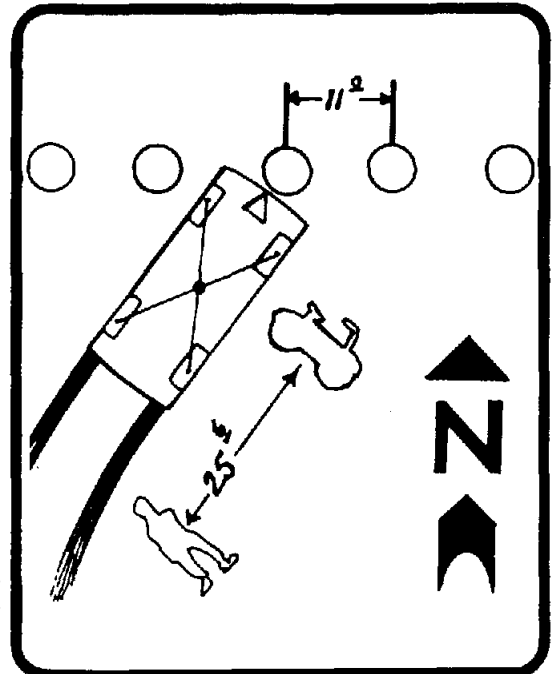

BUS ACCIDENT INVESTIGATION SEMINAR

TRANSPORTATION SAFETY INSTITUTE

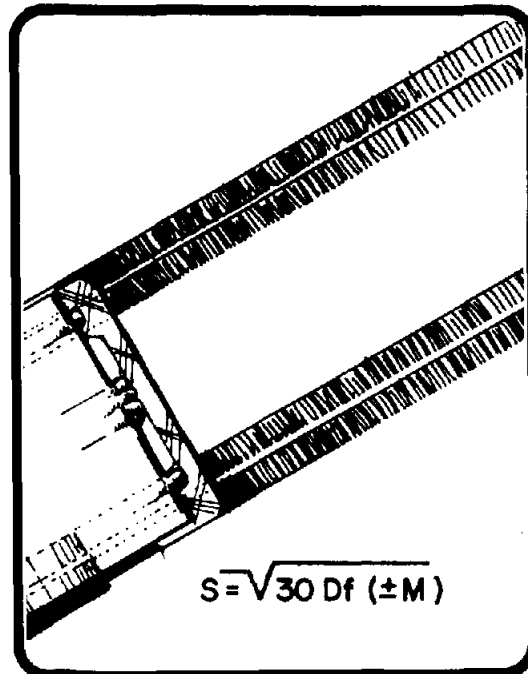
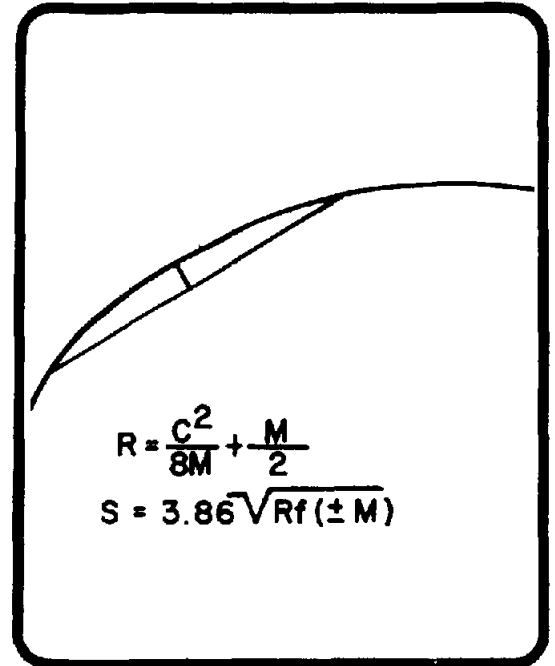
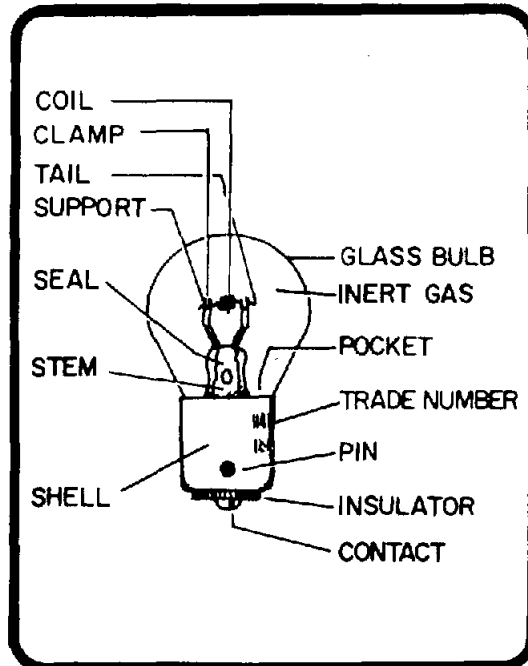

U.S. DEPARTMENT OF TRANSPORTATION

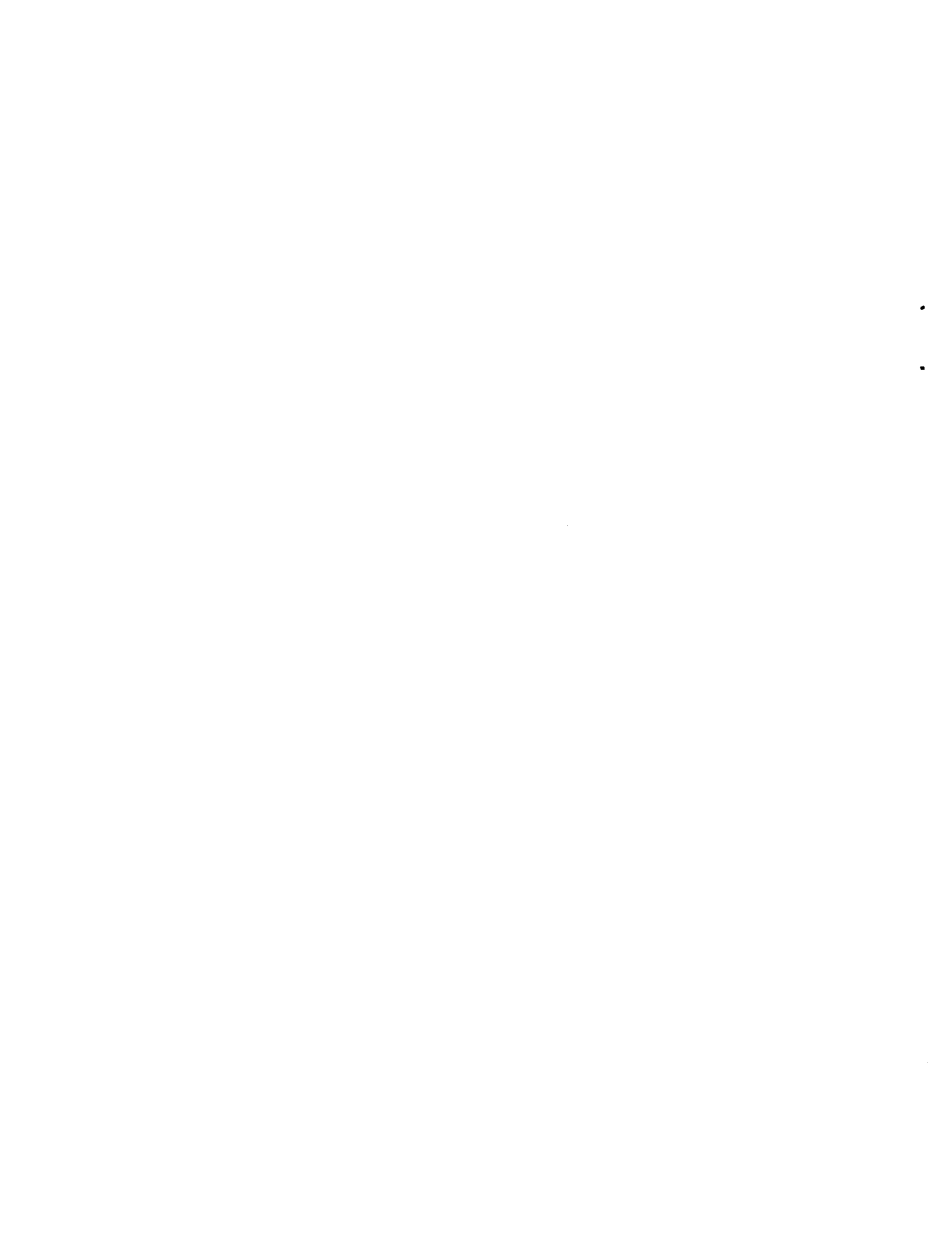

**U.S. DEPARTMENT OF TRANSPORTATION
TRANSPORTATION SAFETY INSTITUTE**

**MASS TRANSIT SAFETY AND SECURITY PROGRAM
BUS ACCIDENT INVESTIGATION
SEMINAR**

Printed: July 1989

Robert F. Lower
Program Manager

Sponsored by the
URBAN MASS TRANSPORTATION ADMINISTRATION
OFFICE OF SAFETY

MTA LIBRARY

HE
5614
B347

19963

NOV. 30 1995

AGENDA FOR THE SEMINAR

FIRST DAY

SECTION

0900-0950	WELCOME, INTRODUCTIONS, ORIENTATION	
1010-1100	NOTIFICATION PROCEDURES/INVESTIGATOR TOOLS...	A
1110-1200	FIELD SKETCHING	B
1200-1300	LUNCH	
1300-1350	ANALYSIS OF DAMAGE AND DEBRIS	C
1410-1500	IDENTIFICATION/INTERPRETATION OF TIRE MARKS...	D
1510-1700	SPEED ESTIMATES FROM TIRE MARKS	E

SECOND DAY

0800-0850	PHOTOGRAPHIC DOCUMENTATION-CASE REVIEWS	F
0910-1000	CONTRIBUTING FACTORS AND CASE EVALUATION	G
1010-1200	INTERVIEW TECHNIQUES	H
1200-1300	LUNCH	
1300-1350	LAMP EXAMINATION-OVERVIEW	I
1400-1450	HOMEWORK REVIEW & SPECIAL PROBLEMS IN ACCIDENT INVESTIGATION	J
1500-1550	MEDIA RELATIONS	K
1600-1630	SUMMARY, ISSUANCE OF CERTIFICATES	



**OBJECTIVE: TO DISCUSS THE IMPORTANCE OF NOTIFICATION PROCEDURES
AND THE TOOLS AND OTHER LOGISTICAL ITEMS NEEDED TO
PREPARE FOR AND CONDUCT THE INVESTIGATION.**

HAVE AN ACCIDENT INVESTIGATION POLICY

A. PUT IT IN WRITING.

B. MAKE IT THE RULE, NOT THE EXCEPTION.

C. TEST IT AND USE IT.

D. MAKE IT CLEAR WHO DOES WHAT AND WHEN THEY DO IT.

E. KEEP IT FLEXIBLE AND VIABLE.

MAKE THE NOTIFICATION PROCEDURES REALISTIC

A. GET AN ACCURATE ACCOUNT AS SOON AS POSSIBLE.

B. ALL EMPLOYEES SHOULD KNOW THE PROCEDURES.

C. HOW HIGH ON THE LIST DO WE GO ?

D. IS THERE A CONTINGENCY FOR EXCEPTIONS ?

E. DID WE COVER ALL THE BASES ?

LET'S RESPOND WITH THE INVESTIGATOR TOOLS.

WHAT ARE THE INVESTIGATOR TOOLS WE WILL NEED ?

WHAT EVIDENCE IS APPARENT ?

A. MARKS ON THE ROAD.

B. LOCATION OF VEHICLES, VICTIMS, DEBRIS.

C. DAMAGE TO VEHICLES, STRUCTURES.

D. INJURIES TO PERSONS.

E. GENERAL ENVIRONMENTAL CONDITIONS.

RELATIONSHIPS WITH OTHER AGENCIES

A. LAW ENFORCEMENT

B. FIRE DEPARTMENT

C. OTHER EMERGENCY SERVICES

D. STREET AND OTHER UTILITY DEPARTMENTS

E. FEDERAL AGENCIES

MEASUREMENTS-GENERAL INFORMATION

MEASURING DEVICES:

STANDARD STEEL TAPE - Error rate in feet per 100 feet varies from -.005 feet to +.010 feet with five pound pull to 15 pound pull respectively. It will easily kink or break if stepped on, run over, or twisted. It may also conduct electricity. Always wipe clean after use in damp or dirty conditions. If it is not enameled, wipe with an oily rag.

WIRE FABRIC OR METALLIC TAPE - Error rate in feet per 100 feet varies +.065 feet to +.165 feet with 5 pound pull to 15 pound pull respectively. It may twist if not pulled up tight. It should be wiped clean after use. Generally minimal conductor of electricity due to the type of fabric construction. It should be rewound after use by threading through two fingers to avoid and detect kinks.

GOOD QUALITY NEW FABRIC TAPE - Error rate in feet per 100 feet varies from -.23 feet to +.10 feet with 5 pound pull to 15 pound pull respectively. It may blow about if not held down or otherwise secured. Some stretch may occur. It should be wiped clean after use and threaded between two fingers while being rewound.

CHEAP OR OLD CLOTH TAPE - Error rate in feet per 100 feet varies from -.31 feet to +.08 feet with 5 pound pull to 10 pound pull respectively. It should be kept taut when possible and some stretching may occur. It should be wiped clean after use and threaded between two fingers when being rewound.

MEASURING WHEELS - These are generally used to supplement a tape. They function best on hard, flat, smooth, and dry surfaces. They are not recommended for other surfaces, ditches, fields, etc. The 2 foot single wheel can vary in error rate per 100 feet from +1.3 feet at 3 feet per second on dry pavement to -4.5 feet at 3 feet per second on dry gravel. The one foot double wheel may vary from -0.1 foot to -4.4 feet under the same conditions.

OPTICAL RANGE FINDER - These commonly have an error rate of + or - five feet per 100 feet.

STEPPING OFF OR PACING - This method may also vary in error rate from plus or minus 5 feet per 100 feet.

NOTE: The stated error rates are not absolute and should not be used to adjust actual measurements taken.

COMMON MEASURING ERRORS

1. Incorrectly adding measurements mentally.
2. Attempting to commit measurements to memory.
3. Forgetting number of tape lengths in long measurement.
4. Neglecting to reset measuring wheel before each measurement.
5. Not knowing or understanding where zero point begins on tape.
6. Reading wrong footmark.
7. Reading numbers upside down, i.e. a 9 for a 6.
8. Not writing numbers clearly.
9. Not listing to or from what point the measurements were made.
10. Not making enough measurements to accurately locate a spot.
11. Measuring from point of impact when point of impact cannot be found later.

12. Measuring yaw marks as skid marks.
13. Measuring skid marks that do not pertain to the accident being investigated.
14. Inaccurately measuring debris location, ie debris has been disturbed AFTER the accident and before measurements were taken.



















INTENTIONALLY LEFT BLANK















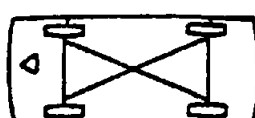



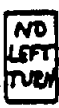

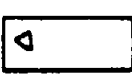

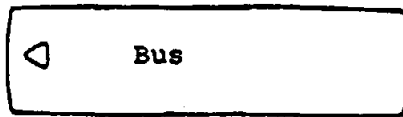
FIELD SKETCHING AND SYMBOLOGY

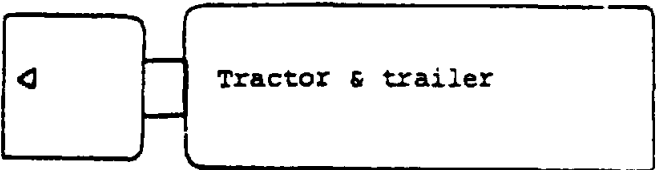
**OBJECTIVE: TO DISCUSS THE METHODS NORMALLY USED
TO MAKE FIELD SKETCHES AND THE SYMBOLS
USED ON THE SKETCHES.**

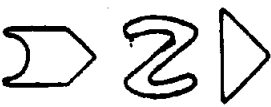
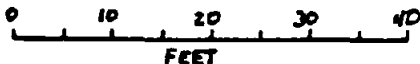
FIELD SKETCH IS A FREEHAND MAP OF THE SCENE SHOWING CERTAIN FEATURES OF THE ACCIDENT AND THE ROAD CONFIGURATION. IT IS USUALLY FOR THE PURPOSE OF RECORDING MEASUREMENTS AND IS ALWAYS DONE AT THE ACCIDENT SCENE.

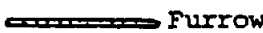
-  Pavement edge
-  Curb
-  Pavement crack
-  Marked lane line
-  Barrier line
-  Unmarked center
-  Mushroom buttons
-  Shoulder edge
-  Embankment
-  Guard rail
-  Fence
-  Property line
-  Sight line
-  Skidmark
-  Scuffmark
-  Scratch
-  Tire print
-  Railroad track
-  Abuttment, wall

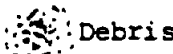
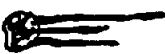
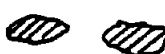
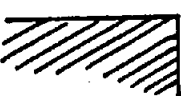
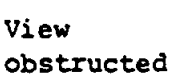
-  Street light
-  Utility pole
-  Drain inlet
-  Manhole
-  Auto on side
-  Vehicle overturned

-  stop
-   Signs
-   Traffic Signals
-   Automobiles
-  Bus
-  Truck
-  Tractor & trailer
-  Cycle
-  Body
-  Compass direction
-  Distance scale
0 10 20 30 40
FEET
-  + 0.03 Grade (+ means up)
-  Gouges
-  Furrow
-  Scrub
-  Debris
-  Puddle & runoff
-  Shrubs
-  Building
-  View obstructed
-  Trees

SYMBOLOLOGY

N →

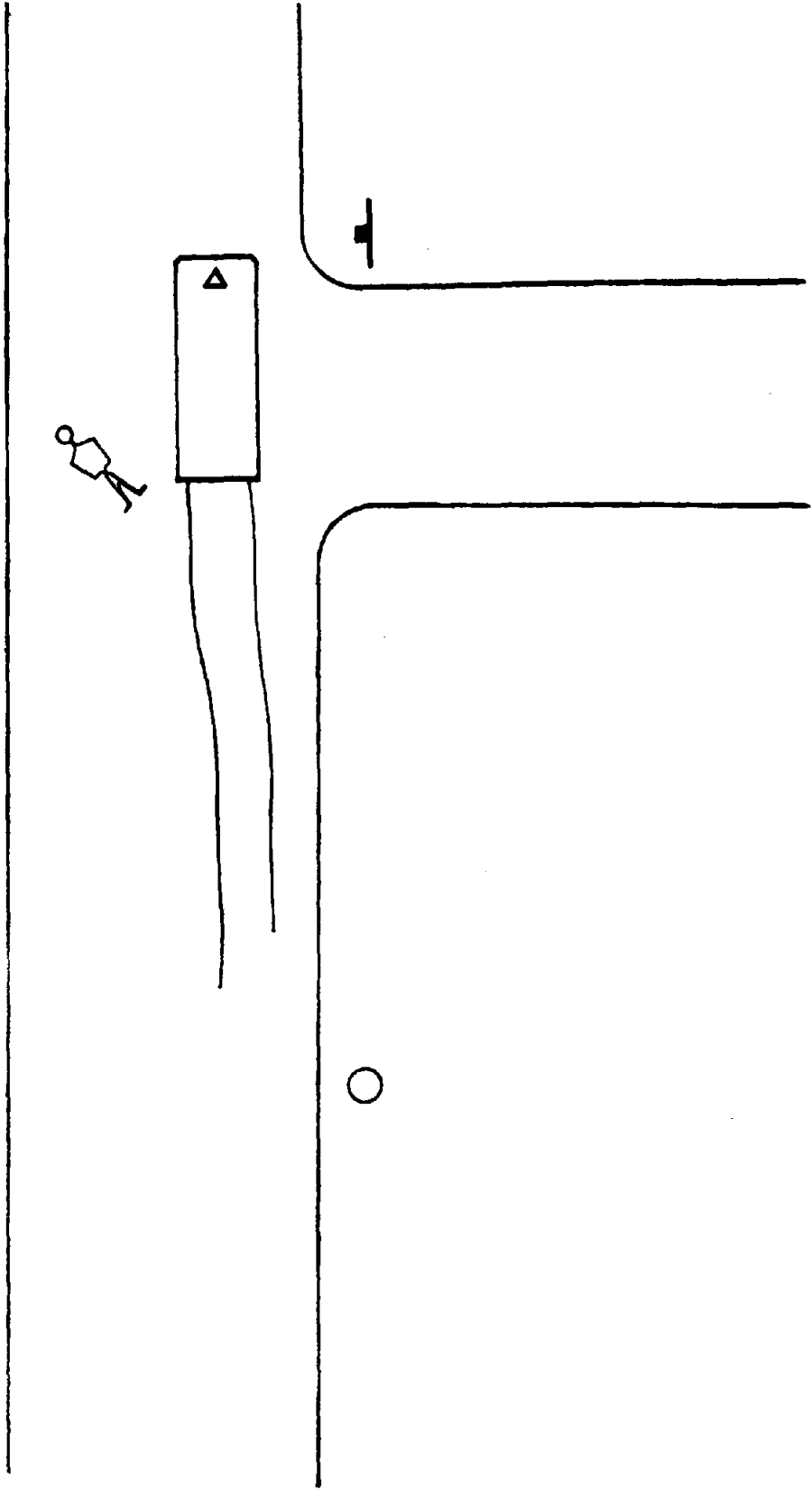

GRADE OR SUPERELEVATION = m

< - RUN - >

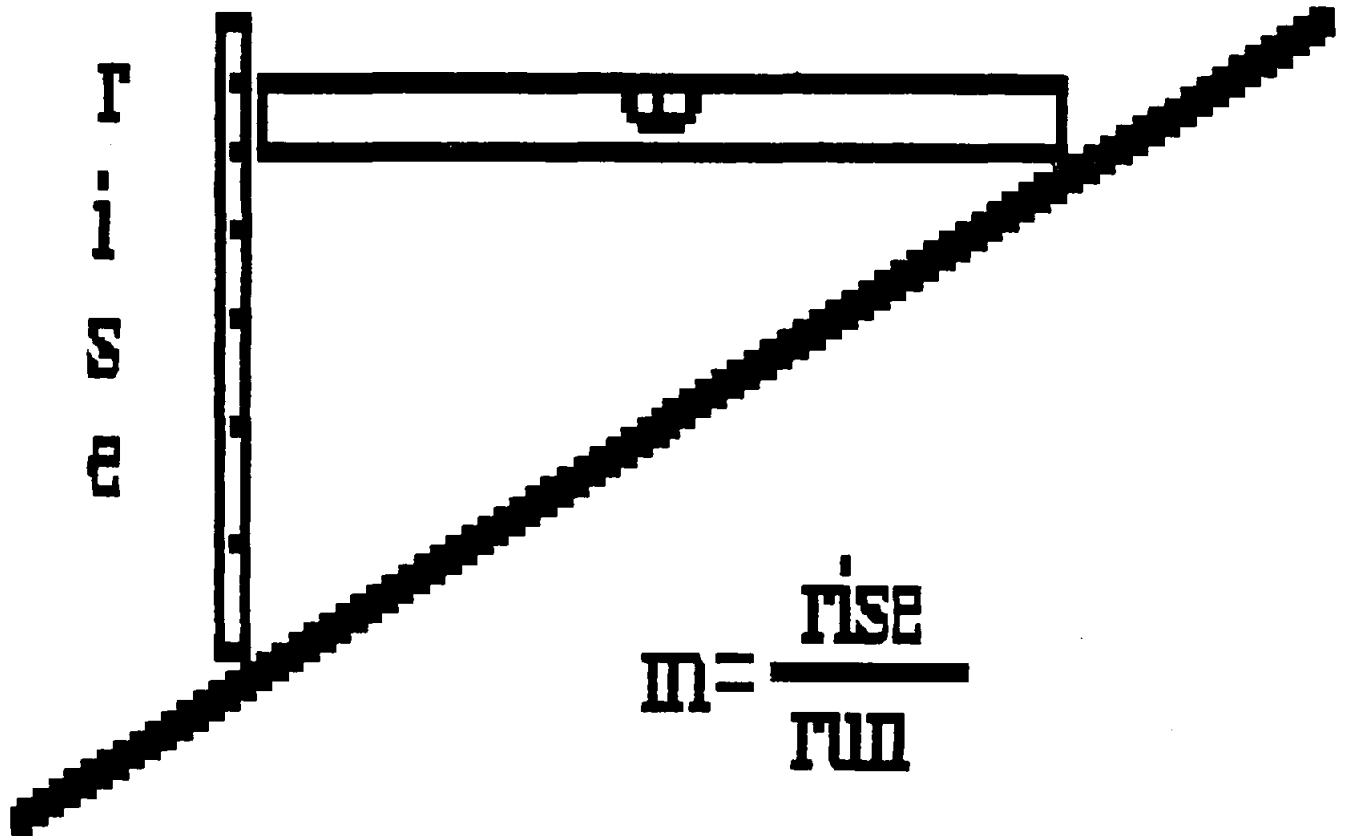

INTENTIONALLY LEFT BLANK



**EVIDENCE: THAT WHICH SHOWS OR ESTABLISHES TRUTH
OR FALSITY OF SOMETHING; PROOF.**

CHAIN OF CUSTODY OF EVIDENCE

- 1. MAINTAIN IT UNDER YOUR CONTROL.**
- 2. LEGAL INQUIRIES SHOULD BE HANDLED BY
YOUR LEGAL DEPARTMENT OR REPRESENTATIVE .**
- 3. MAINTAIN EVIDENCE INTEGRITY-NO ALTERATIONS
OR CHANGES.**
- 4. DO NOT ALLOW DRIVERS OR INVESTIGATORS TO
DEAL WITH OUTSIDE PARTIES WITHOUT COMPANY
PERMISSION.**

EVIDENCE

- 1. TRANSIENT: MARKS, DEBRIS, FLUIDS**
- 2. FIXED EVIDENCE: DAMAGE TO STRUCTURES
AND VEHICLES**

FORMS OF EVIDENCE

- 1. DAMAGE TO VEHICLES, STRUCTURES, OR OBJECTS.**
- 2. INJURIES TO PEOPLE OR ANIMALS.**
- 3. DEBRIS.**
- 4. MARKS ON THE ROAD.**

DEBRIS AS EVIDENCE

1. UNDERBODY

2. VEHICLE PARTS

3. FLUIDS

VEHICLE DAMAGE AS EVIDENCE

CONTACT DAMAGE: DAMAGE TO A VEHICLE CAUSED

BY A COLLISION WITH ANOTHER OBJECT

OR IN A ROLL OVER.

EXAMPLES: RUB OFF OF MATERIAL

METAL COLLAPSE OR PUNCTURE

IMPRINTS OR TRANSFERS

WINDSHIELD BREAKAGE IN A

SPIDER WEB PATTERN

INDUCED DAMAGE: DAMAGE CAUSED BY THE VEHICLE ITSELF

**AS A RESULT OF VEHICLE DISTORTION, TWISTING,
BENDING, OR STRESS RELIEF.**

EXAMPLES: DISTORTION OF CAR LINES

**METAL COLLAPSE AWAY FROM
CONTACT DAMAGE**

**WINDSHIELD BREAKAGE IN A STRIATED
OR CHECKERBOARD PATTERN**

INTENTIONALLY LEFT BLANK



D





**OBJECTIVE: TO DISCUSS THE VARIOUS TYPES OF ROAD MARKS
AT AN ACCIDENT SCENE AND THEIR APPLICABILITY.**

NORMAL

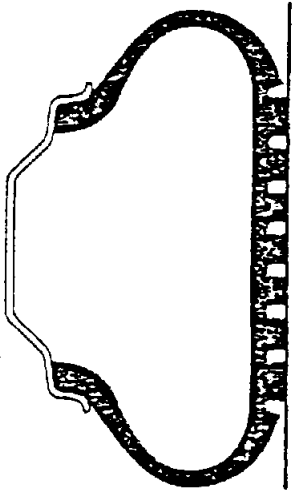

FRONT

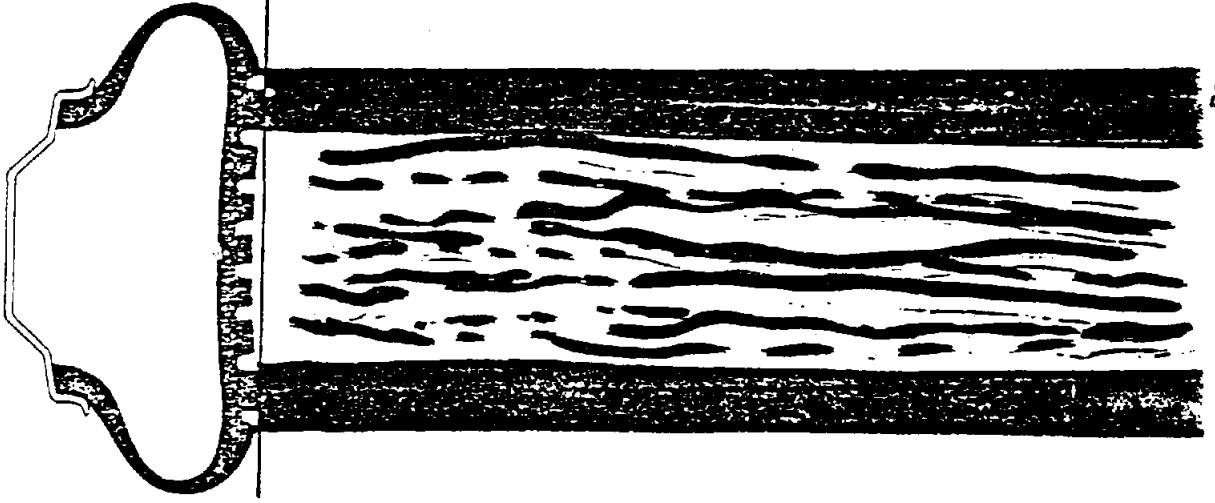

REAR



GAP SKID OR INTERMITTENT SKID MARKS

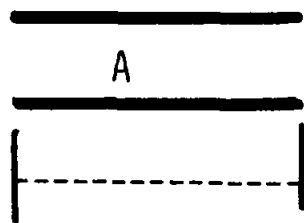

GAP

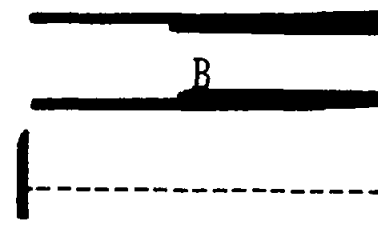

SKIP SKID

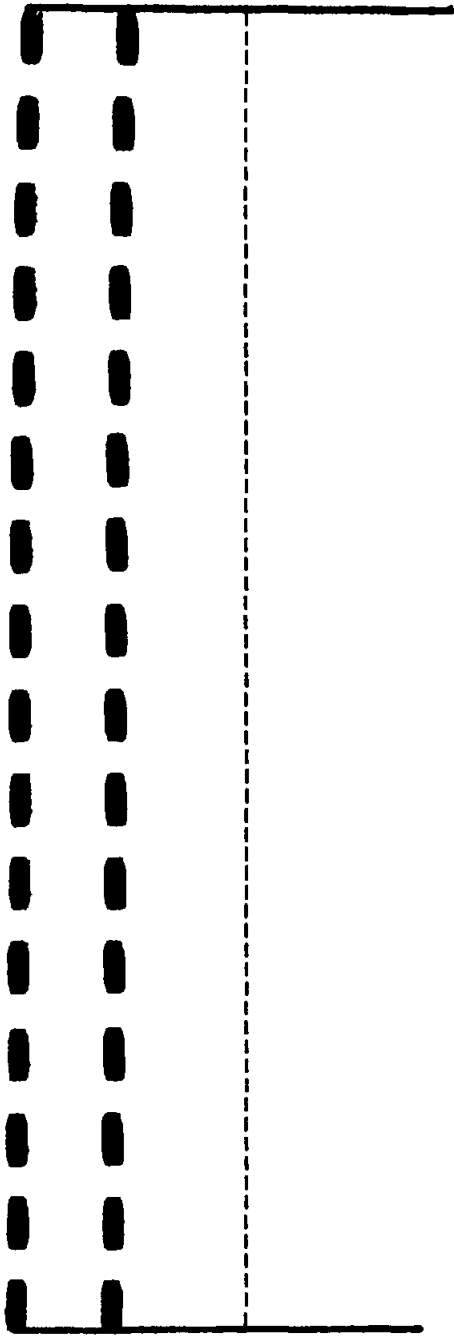

STRAIGHT SKID

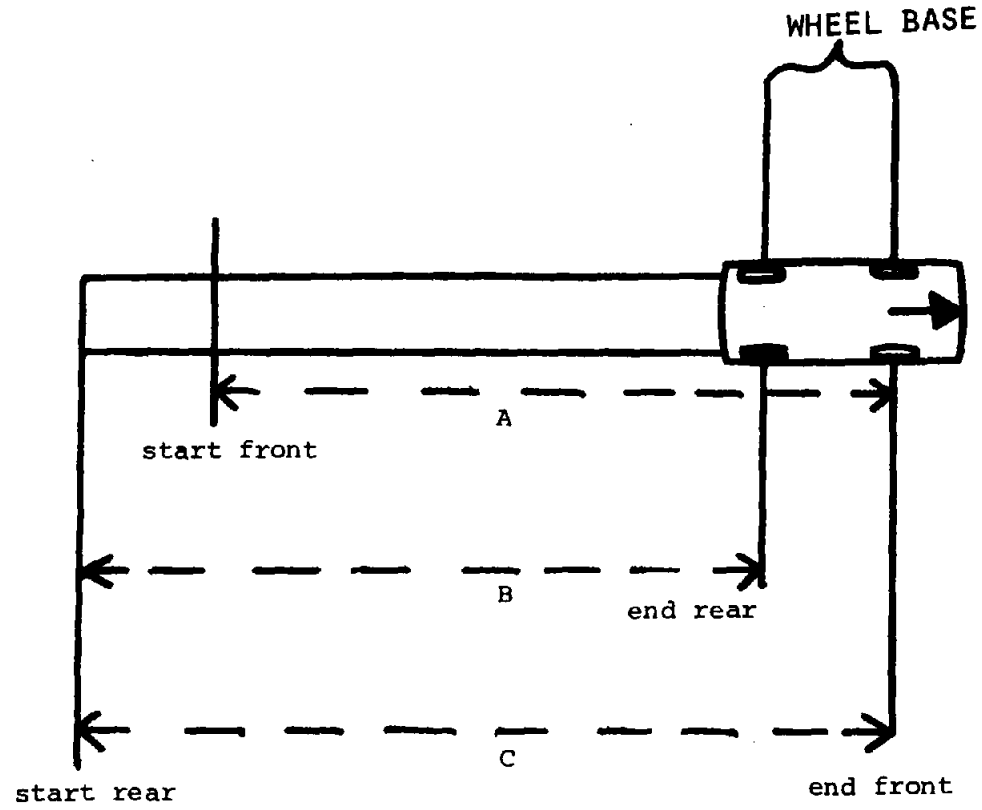

OFF SET SKID

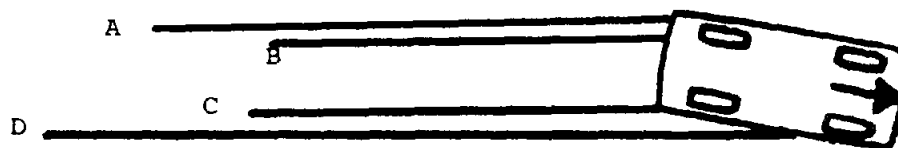

A = 55

C = 50

B = 47

D = 60

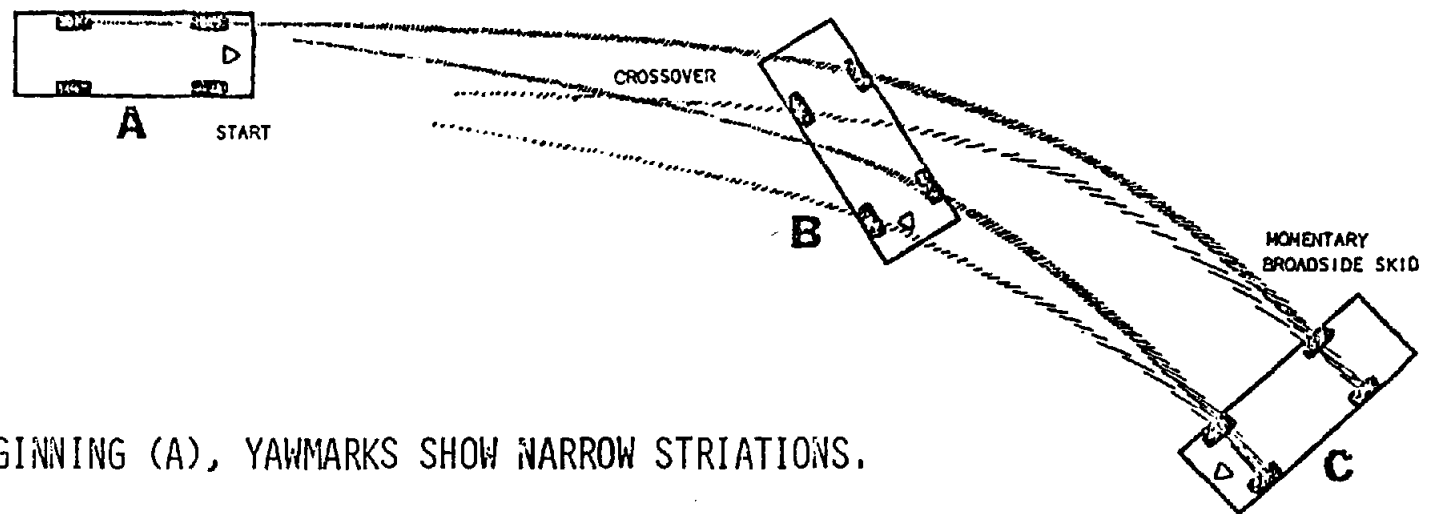

AT BEGINNING (A), YAWMARKS SHOW NARROW STRIATIONS.

AS CAR MOVES TO THE LEFT, BROADER MARKS ARE LEFT WITH DIAGONAL STRIATIONS (B).

AS VEHICLE IS BROADSIDE (C), YAWMARK IS AS WIDE AS TIRE AND STRIATIONS ARE PARALLEL TO THE MARK.

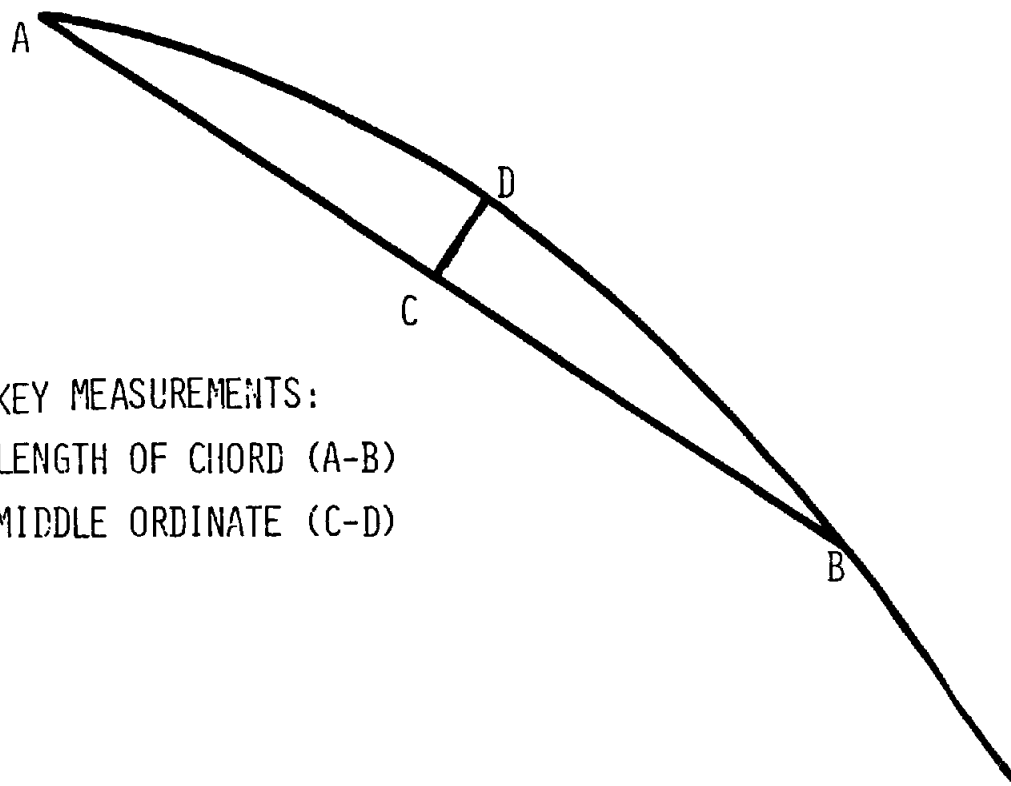

KEY MEASUREMENTS:

LENGTH OF CHORD (A-B)

MIDDLE ORDINATE (C-D)

FUNDAMENTALS OF TIRE CHARACTERISTICS & TERMINOLOGY
FOR THE BUS ACCIDENT INVESTIGATOR.

FIRST EDITION

October 1983

by

Robert F. Lower

U.S. DEPARTMENT OF TRANSPORTATION

TRANSPORTATION SAFETY INSTITUTE



TABLE OF CONTENTS

PURPOSE

CHAPTER ONE

iii

TIRE TYPES AND CONSTRUCTION

1

TUBE-TYPE AND TUBELESS

1

TREAD PATTERNS AND DESIGNS

1

RIB TYPE

3

CROSS LUG OR CROSS RIB

3

MUD & SNOW SPECIAL SERVICE TYPE

4

RECAPS, RETREADS, REGROOVEABLE

4

TIRE CONSTRUCTION

4

DIAGONAL BIAS

5

BELTED BIAS

5

RADIAL TYPE

5

CHAPTER TWO

ABNORMAL TIREWEAR

6

TIRE INFLATION

6

PROPER INFLATION

7

OVERINFLATION

7

UNDERINFLATION

7

OVERHEATING OF TIRES

8

MISALIGNMENT OF TIRES

9

CASTER

9

TOE-IN

10

TOE-OUT

10

CAMBER

10

ABNORMAL WEAR EXAMPLES

11

CHAPTER THREE

TIRE DAMAGE AND INSPECTION IN ACCIDENT INVESTIGATION	12
TIRE MOVEMENT ON THE WHEEL	12
TIRE POSITION	12
TIRE REMOVAL	13
MIXING TIRE TYPES	13
TIRE & WHEEL BREAK UPS	13
TIRE CUTS	14
BLOW-OUTS AND FLATS	14
TIRE BULGES & LUMPS	15

012

PURPOSE

THE PURPOSE OF THIS DOCUMENT IS TO DISSEMINATE GENERALLY ACCEPTED INFORMATION TO BUS ACCIDENT INVESTIGATORS CONCERNING TIRE TERMINOLOGY AND CHARACTERISTICS. THIS DOCUMENT IS NOT INTENDED TO MAKE AN "EXPERT" OUT OF EVERY INVESTIGATOR THAT READS IT. HOWEVER, IT DOES CONTAIN BASIC INFORMATION CONCERNING TIRES WHICH EVERY TRAFFIC ACCIDENT INVESTIGATOR SHOULD KNOW. NOT EVERY ACCIDENT INVOLVES OR REQUIRES DETAILED EXAMINATION OF VEHICLE TIRES. WHETHER OR NOT A TIRE (OR WHEEL) IS A CONTRIBUTING FACTOR TO AN ACCIDENT DEPENDS ON THE ABILITY OF THE INVESTIGATOR TO DEVELOP OR "CASH-IN" ON AVAILABLE CLUES. THESE CLUES CAN TAKE MANY FORMS SUCH AS MARKS ON THE ROAD, GENERAL CONDITION OF THE TIRES, STATEMENTS FROM DRIVERS OR WITNESSES, ETC.

NO DOCUMENT CAN COVER ALL THERE IS TO KNOW ABOUT TIRES. THIS DOCUMENT WILL ADDRESS IN GENERAL TERMS TIRES FOR SOME AUTOMOBILES AND HEAVIER VEHICLES, SUCH AS TRUCKS AND BUSES.

FOR ADDITIONAL INFORMATION, THE INVESTIGATOR MAY WISH TO PURSUE SPECIALIZED TRAINING IN TIRE FORENSICS AND OTHER RELATED ADVANCED TOPICS AVAILABLE FROM VARIOUS TRAINING INSTITUTIONS.

CHAPTER ONE

TIRE TYPES AND CONSTRUCTION

TUBE-TYPE and TUBELESS

Tires can come with or without tubes. Many people feel that there are distinct advantages to tubeless over tube-type construction. Some of these advantages are:

1. WEIGHT SAVINGS - Fewer component parts per assembly are required. The tube, flap, side ring, and lock ring are eliminated. This also leaves fewer parts subject to damage. Tubeless tires require only a one piece rim, which is considered safer and easier to mount.
2. FEWER ON-THE-ROAD DELAYS - Penetrating objects such as nails are usually held in place preventing air loss and permanent repair can be made later.
3. COOLER RUNNING - This is a result of eliminating the tube and flap.

TREAD PATTERNS AND DESIGNS

Most road use tires have a tread pattern of one type or another.

Some manufacturers' claims as to why one tread is better than another are not always scientifically supported.

Basically, most tires have grooves and other indented lines.

015

The grooves are designed primarily to channel water from under the tire to prevent hydroplaning. The little indented lines in the tread pattern are sometimes referred to as "sipes". These are generally designed to assist the grooves in keeping the tire as cool as possible.

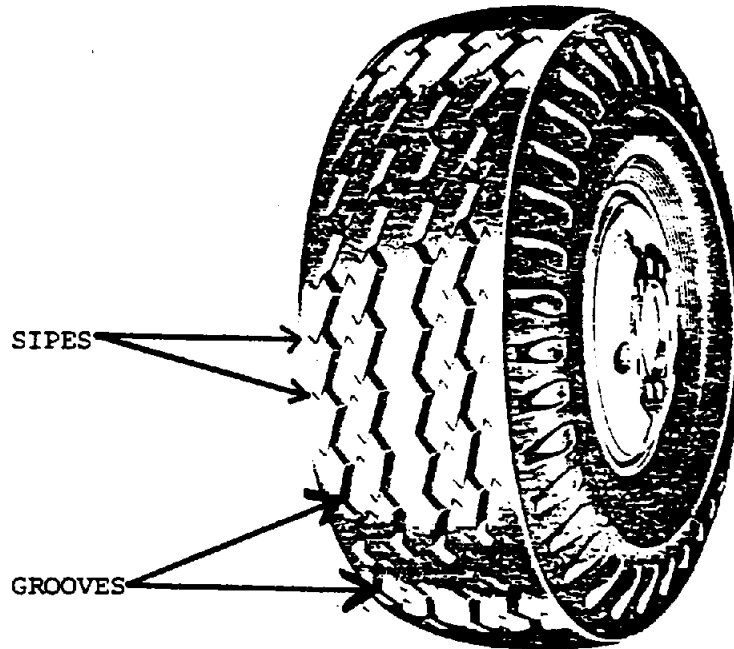

On the other hand, racing tires are usually wider, smoother, softer, and gummier than other tires. They should not be used for regular road use and, in some areas, such use constitutes a violation of law. Because of their construction, racing tires do not last as long as regular tires. They respond faster to operator input and are usually more difficult to control. If an investigator needs to find the drag factor for a vehicle equipped with racing tires, the test vehicle, test sled, or test tire should also be made up of racing tires. Racing tires may carry the notation on the tire "NOT FOR NORMAL ROAD USE" or "RACING TIRES."

Trucks and similar over-the-road vehicles have a choice of basically three different tread designs.

RIB TYPE

This is considered to be the most versatile type. It is considered safe for any legal highway speed and can be used on all wheel positions. It is generally recommended for front wheel use of line haul tractors and large straight trucks in long distance service. It is also used for free rolling trailer service. Its open groove tread design and traction slots provide good steering characteristics and skid resistance.

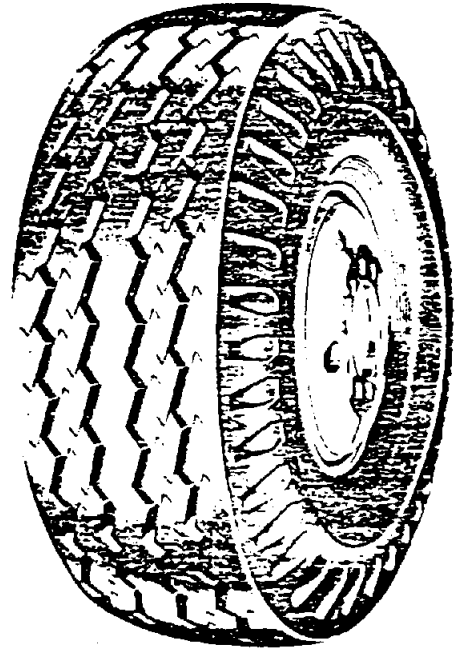

RIB TYPE

CROSSLUG OR CROSS RIB TYPE

This tire is designed for drive wheel service and is also suitable for many other over-the-road applications. The tread design provides maximum resistance to wear and greater traction in high torque service. On drive wheel positions, this tire normally delivers more mileage than the rib type. When tread design is sufficiently worn, the tire is many times moved to the trailer axles for run-out.

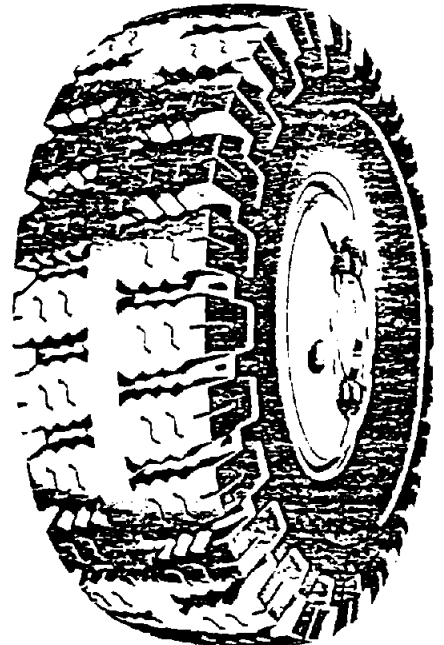

CROSS RIB TYPE

D17

MUD & SNOW SPECIAL SERVICE TYPE

These tires are designed for better traction on drive wheel positions for on-road and off-road service. They are intended for maximum traction in soft ground, mud, or snow at low speeds for short hauls. They should only be used for high speed or long distance highway operations in winter or cold climate conditions as they will overheat under most other conditions.

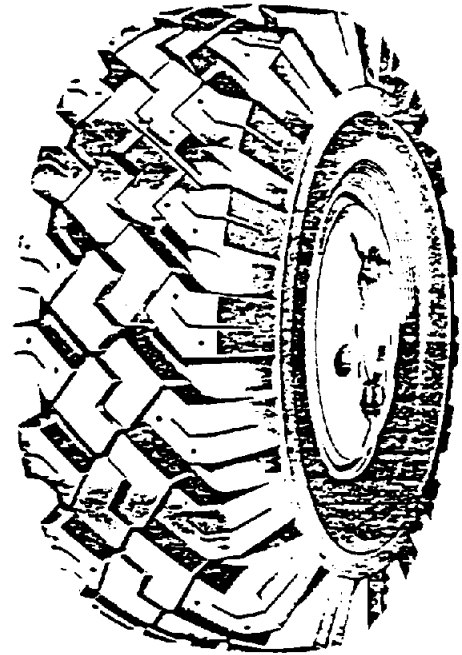

SPECIAL SERVICE
TYPE

RECAPS, RETREADS & REGROOVEABLE TYPE

These tires are also in use in many areas. Regrooving is generally accomplished mechanically. Recaps and retreads are still in use in some areas. Use of these on steering axles of vehicles engaged in interstate commerce may be illegal and is not recommended. Recaps are subject to casing breakup (CBU) which may be caused by underinflation, water inside the tire, and/or manufacturer faults.

TIRE CONSTRUCTION

Most tires manufactured today have many different designations but are usually constructed of materials such as polyester, fiberglass, aramid (a generic name for polymer fibers), steel, rayon, and nylon.

The principal tire constructions are:

DIAGONAL BIAS

This tire may have 2 or more body plies that cross at an angle of about 35 degrees to the center line of the tread. Alternate plies extend in the opposite direction.

**DIAGONAL
(BIAS)**

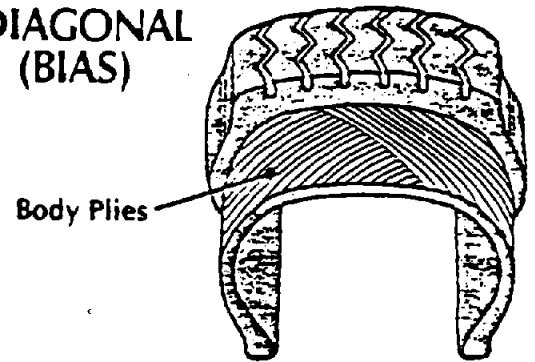

BELTED BIAS

This construction is similar to the diagonal bias tires except that this tire has two or more belts under the tread. Besides giving strength to the sidewall and greater stability to the tread, it reduces tread movement during contact with the road. This tends to improve tread life.

**BELTED
BIAS**

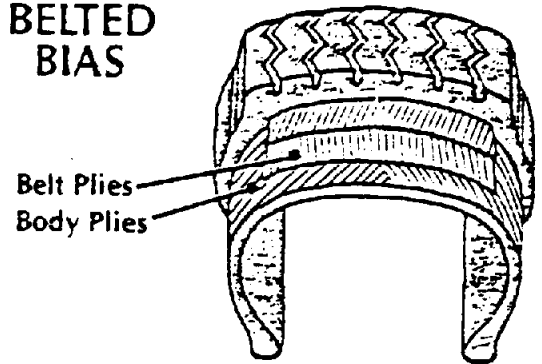

RADIAL TYPE

In a radial tire, the cords run almost perpendicular across the tire from bead to bead. They have belt plies that run under the tread circumferentially around the tire. These give rigidity to the tread and restrict tread movement during road contact.

RADIAL

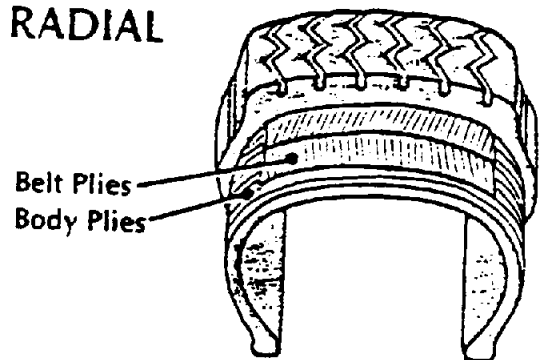

CHAPTER TWO

ABNORMAL TIRE WEAR

There are many causes for abnormal tire wear. Some are:

1. Failure to balance tire and rim assembly.
2. Improperly mounted rims, such as is caused by unequal or excessive tightening of lug nuts.
3. Mismatching of duals on trucks, buses, and other large vehicles.
4. Vehicle parts interfering with moving tires.
5. Faulty brakes.
6. Abusive driving practices such as fast cornering, "jackrabbit" starts, sudden stops, excessive brake use or "riding" the brake pedal, riding pavement edges, high speeds on rough roads, etc.
7. Bad or damaged wheel bearings.
8. Suspension problems.
9. Failure to properly rotate tires.

While all of the aforementioned problems are possible causes, the most common ones are improper inflation and misalignment.

TIRE INFLATION

Since tires are designed to carry certain loads at specified pressures, correct pressures must be maintained to avoid excessive wear. Proper inflation enables tires to support the load, which not only provides for safe vehicle operation but prolongs tire life as well.

010

The following are exaggerated views of tires in various stages of inflation:

PROPER INFLATION

This provides the correct profile for full contact with the road.

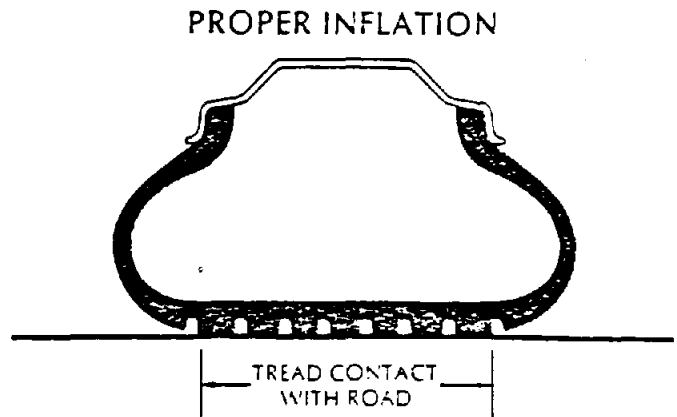

OVERINFLATION

This causes tires to run hard and makes them vulnerable to impact damage. It also causes irregular wear.

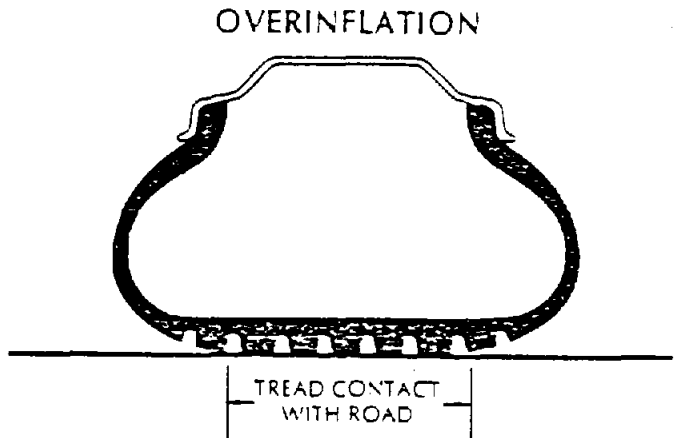

UNDERINFLATION

This causes abnormal flexing, which builds up excessive heat and increases the danger of failure. It also causes irregular wear.

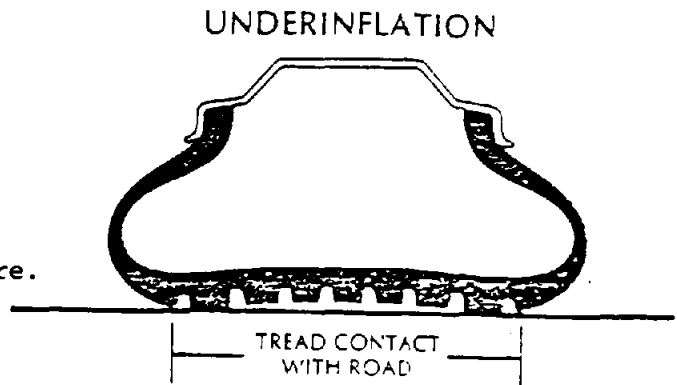

OVERHEATING OF TIRES

Tire temperatures can climb to dangerously high levels on a vehicle when it is driven at sustained high speed and overloaded or the tires are underinflated. High temperatures can affect both the cord fabrics and the tire rubber compounds. At temperatures above 250 degrees F, the cords weaken and the tire is more susceptible to blowout because the cord body is under excessive tension. Tire failure may not result during the first trip in which the tire became overheated. However, cord damage may have occurred and a failure may come during a subsequent run. Tire rubber compounds soften and weaken at about the same temperatures and the tread becomes more susceptible to damage from road hazards. Below is an example of the kind of tread damage that can occur from overheating.



Some tires may become so hot that the heat transmits to the tire's outside surface and when it reaches the combustion point, it bursts into flames. This generally occurs when one tire of a dual assembly is either flat or severely underinflated and the other becomes extremely overloaded. Either or both tires can ignite.

Small tires such as those found on boat trailers and recreational trailers are subject to failure from overheating due to flexing caused by underinflation.

Since radial ply tires have a characteristic bulge in the sidewall whether or not they are properly inflated, it is almost impossible to visually determine the degree of inflation. A reliable air gauge should be used to check inflation pressure on radial ply tires.

MISALIGNMENT OF TIRES

Misalignment can also cause irregular tire wear. In wheel alignments, CASTER refers to the backward tilt of the axle. Too little caster causes the wheel to weave or wander. Excessive caster causes the wheel to shimmy. Unequal caster causes the wheel to pull to one side. All of these caster problems result in excessive and uneven tire wear. More common alignment problems that can sometimes be perceived with the naked eye are TOE-IN, TOE-OUT, and CAMBER.

TOE-IN

The wheels on the same axle are closer together in the front than they are in the rear. When toe-in is excessive, the tire wear shows feathered edges on inside edge of the tread design.

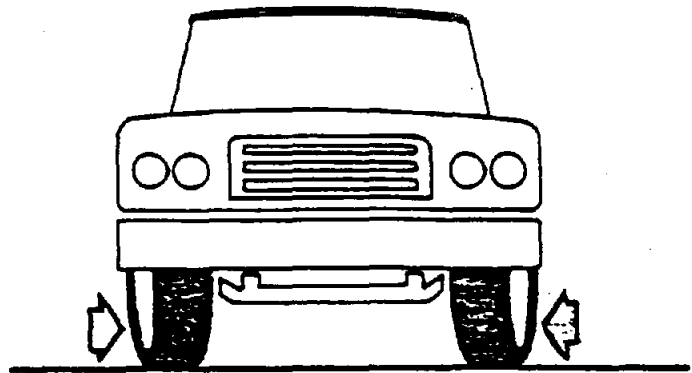

TOE-IN

TOE-OUT

The wheels on the same axle are closer together in the rear than they are in the front. Tire wear shows feathered edges on outside edge of the tread design.

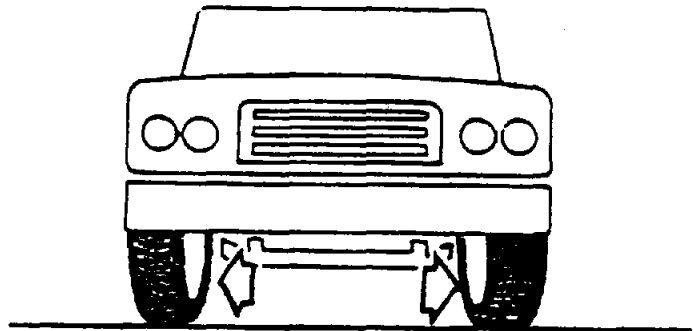

TOE-OUT

CAMBER

This designates the tilt of the wheel. Positive camber is when wheels are closer together at point of road contact.

Negative camber is when wheels are closer together at top. Too much of either causes one side to wear.

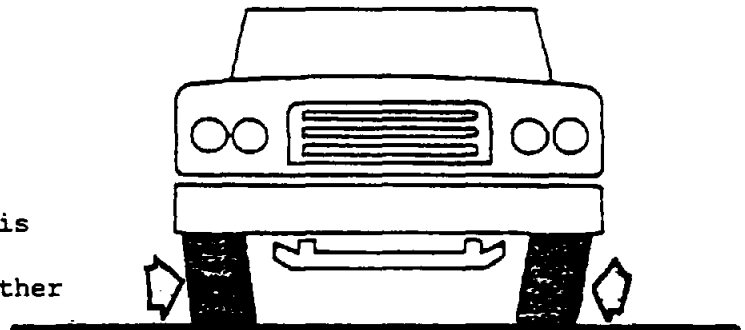

CASTER

224

These are examples of abnormal tire wear and uneven tread patterns caused by wrong inflation pressure, misalignment, improper balance, or suspension neglect or a combination of several.

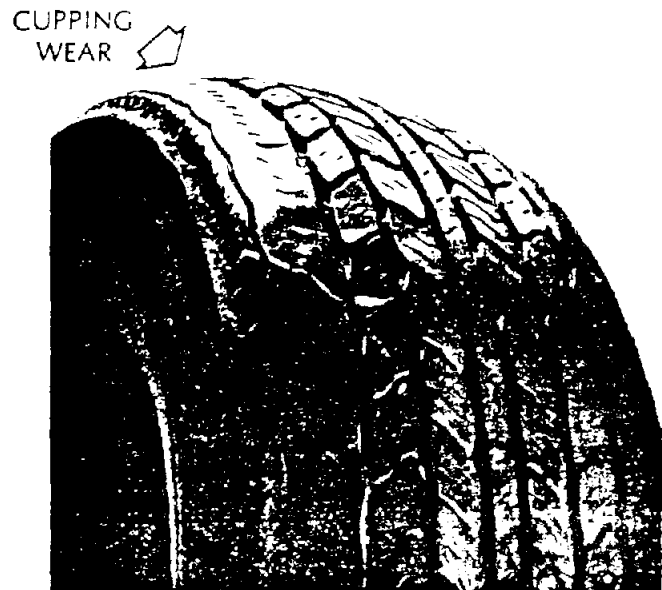
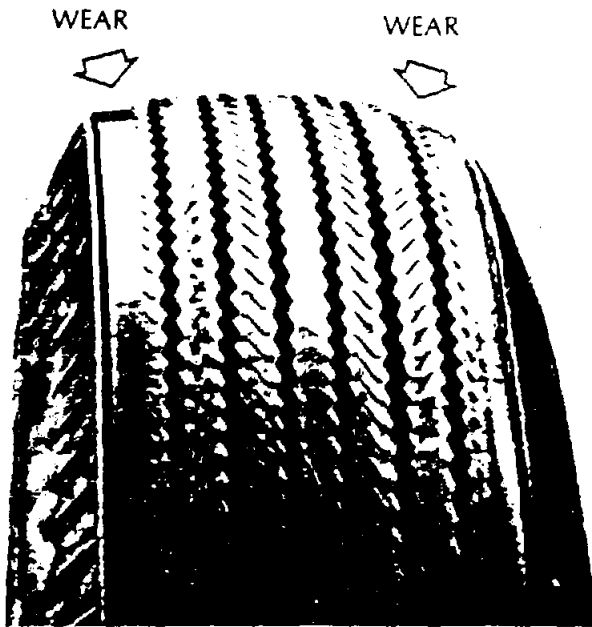
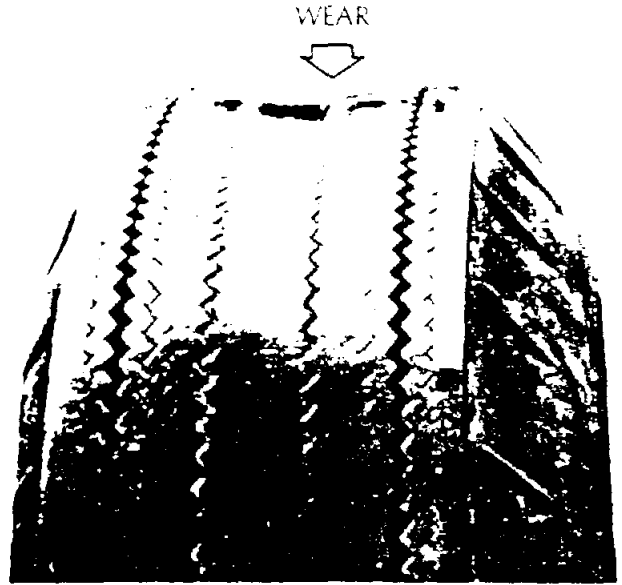

015

CHAPTER THREE

TIRE DAMAGE AND INSPECTION IN ACCIDENT INVESTIGATION

An accident investigator is often faced with the task of determining whether or not a tire or wheel contributed to an accident. It is sometimes very difficult to tell if a tire was damaged before, during, or after the accident. Many times, tires may show wear or damage but had nothing to do with the accident itself. For example, bald tires may be blamed for an accident where a car failed to stop in time. However, if the pavement was dry at the time of the collision and the tires remain inflated, the bald tire may have had better braking action than one with tread still on it. This is because the bald tire actually had more tire surface on the pavement during braking. On wet pavement, bald tires do not do as well because they have a tendency to hydroplane. Since racing tires are usually very smooth, they become extremely dangerous on wet pavement also.

TIRE MOVEMENT ON THE WHEEL

There have been occasions where a tire actually will move on a wheel. It may be necessary to check wheel weights to determine tire movements. Usual wheel weights (balance weights) will leave a mark on the tire. If there is evidence that the tire has moved around on the wheel, it is likely that the tire will be out of balance or susceptible to abnormal wear, difficult steering, and damage.

TIRE POSITION

If it is necessary to record data such as marks left on a tire as the result of a yaw or other evidence, it may be helpful to mark the position of the valve of the tire during the vehicle's final rest so that the relative position of the evidence can be shown later. Evidence

of a yaw mark (a mark caused by a tire that is rotating but sliding sideways at the same time indicating excessive speed on a curve) may be abrasions all the way around the tread shoulder or wall of the tire. Foreign materials such as grass or weeds may be caught between the tire and the rim in a yaw. Tubeless tires may actually lose enough air in a yaw to go flat. The sideways movement of the vehicle may cause a break in the tire bead, allowing the air to escape. It is important to note that there is little or no significant difference between radials and bias tires when making speed estimates from yaw marks.

TIRE REMOVAL

If a tire must be removed from a vehicle after an accident, the investigator should note the vehicle involved, which wheel, and the serial number of the tire. Some times, tires from the same batch may carry the same number, necessitating an inscription by the investigator on the tire as to which wheel it belonged.

MIXING TIRE TYPES

An investigator should also note the types of tires on an accident vehicle. It is inherently dangerous to mix radials and bias tires and tires of different sizes on the same axle because steering and driver control capabilities can be greatly reduced.

TIRE AND WHEEL BREAK UPS

If a tire and/or wheel has come apart in an accident, it may have been a contributing factor. An investigator should attempt to locate, mark, and label tire and wheel parts, if possible. In cases of retread or casing break ups, the pieces may be missing from the tire, but if found, can sometimes be matched up with the space in the tire .

TIRE CUTS

Accidental tire cuts are usually attributed to road debris or vehicle parts. If a tire has been accidentally cut and the tire continued in service, the cords will fray and show signs of wear. If the cords are sharply cut, clean, and free of dirt, then it is likely that the cut is very recent. Some cuts may require inspection of the inside of the tire. An "X" or "Y" shaped break on the inside usually indicates penetration by a sharp or pointed object. Intentional tire damage can be caused by either the driver as an alibi for having the accident or by a tire slasher or vandal. Drivers will many times slash the outside front tire as an alibi and claim a blow out. Quite frequently, the driver will attempt to slash the tire in the tread area. Vandals or slashers will usually cut the side wall and many times will attack more than one tire on a vehicle.

BLOW OUTS AND FLATS

It is not always possible to substantiate a driver's claim that a tire blew out and caused an accident. Generally, a tire that has blown out will have a fairly long slit in the tire accompanied by separation in the casing. The slit may appear smooth on the outside but jagged on the inside. Sometimes flat tire marks may be evident prior to the point of collision. This can be possible evidence that the tire failed before the accident. It is rare but possible that more than one tire can go flat at a time. A flat tire mark may appear on the pavement as an irregular, scalloped mark reflecting tread, sidewall, and possibly rim contact with the surface of the roadway. A flat tire can also occur when a plug has been used to previously repair a tire. Due to tire flexing, the plug may work its way inside the tire, allowing air to leak out. In these cases, the plug is usually found inside the tire.

TIRE BULGES AND LUMPS

Bulges and lumps can usually be detected with the naked eye if they are on the outside of the tire. To detect them elsewhere, it may be necessary to put the vehicle on a lift or physically feel the inside of the tire. If the lumps or bulges are soft when pressure is applied, there is probably a separation of tire and lining. If the tire is going to be deflated and removed, the lump or bulge should be outlined in chalk or some other marking material as it may not be apparent after deflation. If the bulge or lump has been on the tire for a while, excessive wear is usually evident in the area. Occasionally, a driver will admit to hearing a "thumping" noise or a squealing sound in a turn prior to the accident. These are possible indicators of a tire bulge or lump. Whether or not they are a causal factor in the accident depends on other information available to the investigator.



SKIDMARK-SPEED NOMOGRAPH

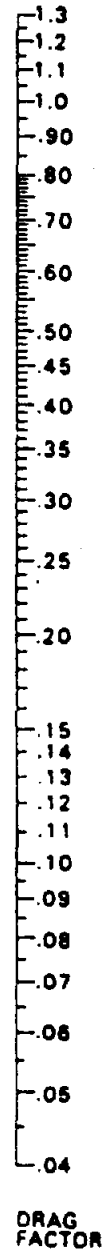
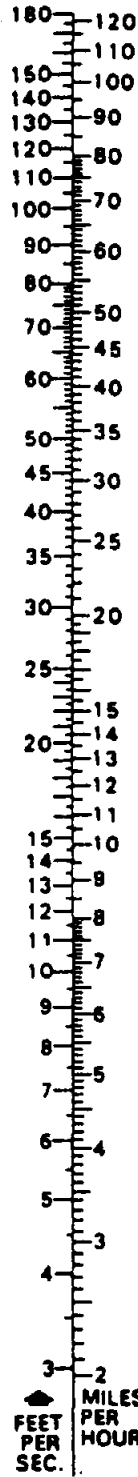
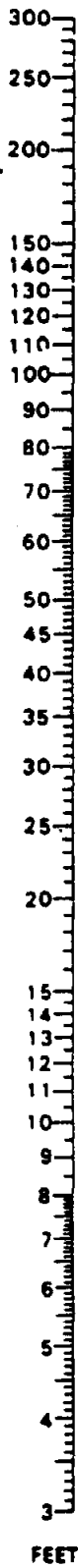

F1

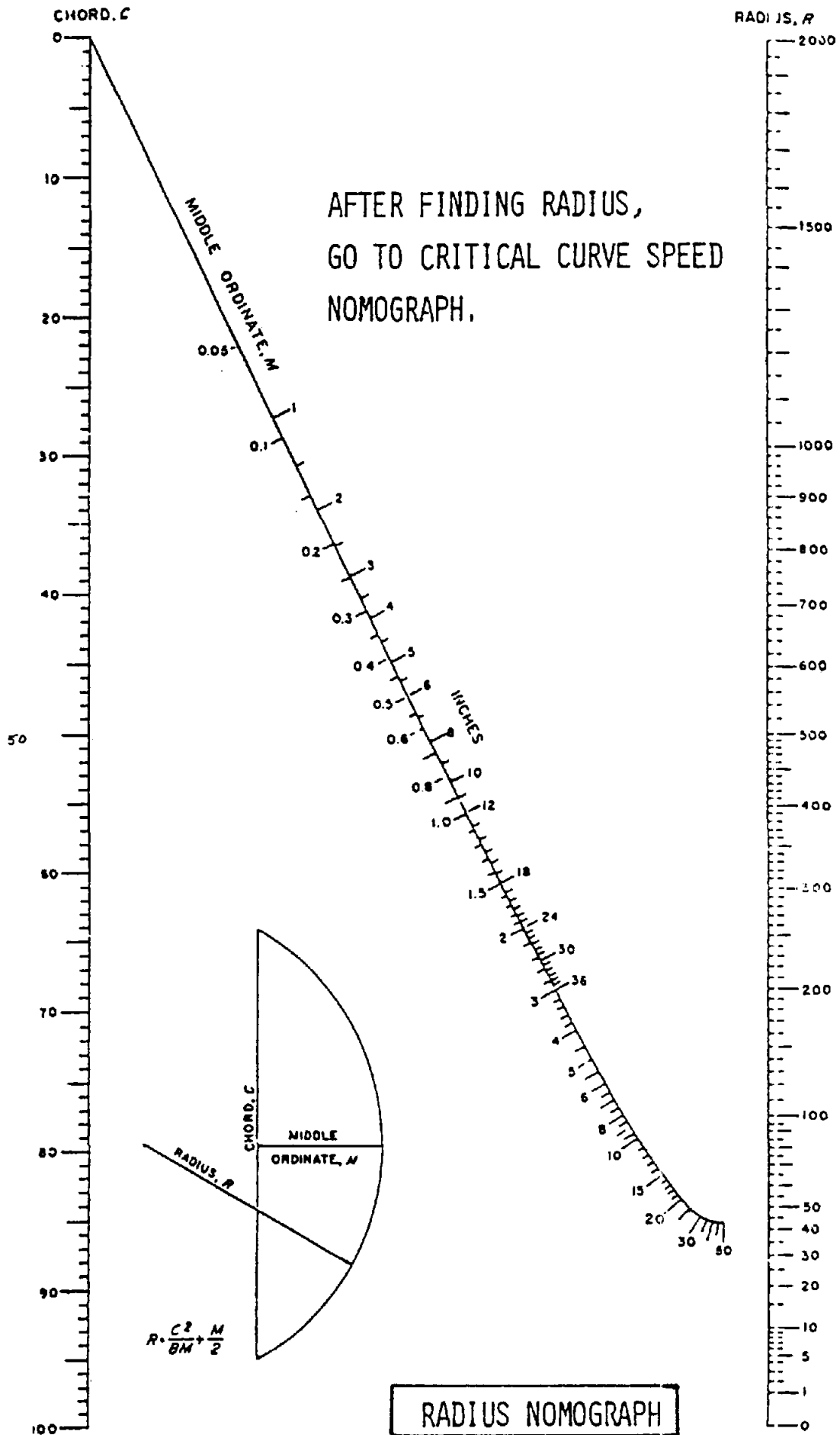

CRITICAL CURVE SPEED NOMOGRAPH

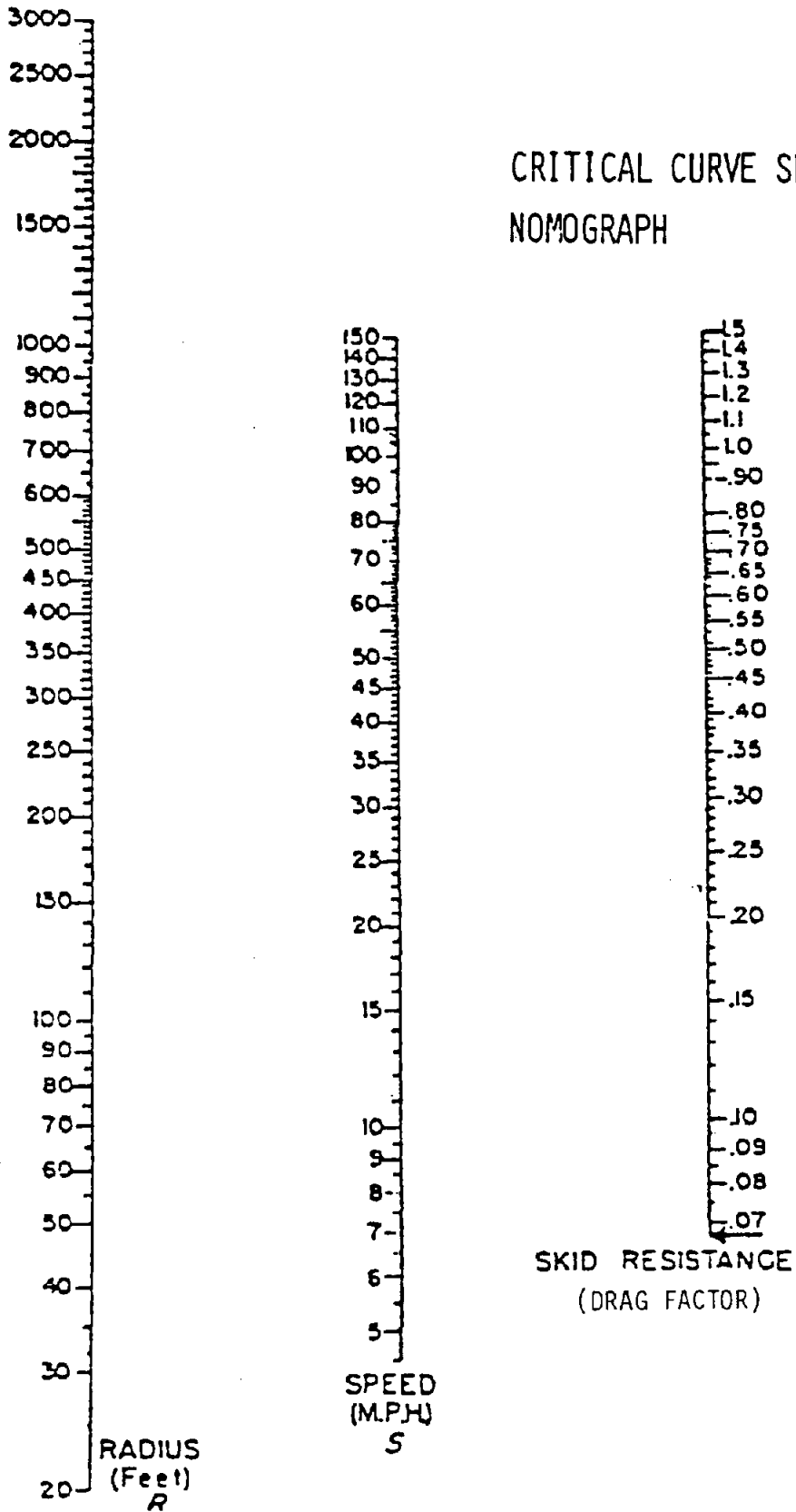

METHODS FOR DETERMINING DRAG FACTORS IN
ACCIDENT INVESTIGATION

by

ROBERT F. LOWER
TRANSPORTATION SAFETY INSTITUTE

First Printing, May 1984
Second Printing, August 1987

TABLE OF CONTENTS

GUIDLELINES AND RECOMMENDATIONS1
USE OF CHARTS3
SKID TESTS5
SKID DEVICES.....11
EXHIBIT 115
EXHIBIT 216
EXHIBIT 317
EXHIBIT 418

57

METHODS FOR ASCERTAINING DRAG FACTORS
IN ACCIDENT INVESTIGATIONS

THE PURPOSE OF THIS DOCUMENT IS TO SET FORTH CERTAIN GUIDELINES AND RECOMMENDATIONS TO ASSIST INVESTIGATORS IN FINDING DRAG FACTORS FOR USE IN SPEED DETERMINATIONS IN ACCIDENT INVESTIGATIONS.

IN MOTOR VEHICLES, THE RESISTANCE TO MOTION DUE TO SLIDING OR SKIDDING IS CAUSED BY FRICTION BETWEEN THE SLIDING TIRE AND THE ROAD SURFACE. THE RESULTING DRAG FACTOR IS SOMETIMES REFERRED TO AS THE CO-EFFICIENT OF FRICTION. THE DRAG FACTOR IS A NUMBER ASSIGNED AS A PERCENTAGE VALUE TO REPRESENT THE AMOUNT OF SLIPPERINESS OF THE TIRE TO THE ROAD SURFACE.

WHEN SKID MARKS ARE PRESENT AS THE RESULT OF TIRES SLIDING ON A SURFACE AND IT CAN BE DETERMINED WHICH TIRES LEFT WHICH MARKS, OR AT LEAST WHICH VEHICLE LEFT WHICH MARKS, AN INVESTIGATOR CAN DETERMINE THE MINIMUM SPEED OF THE VEHICLES AT THE BEGINNING OF THE MARKS IF HE OR SHE KNOWS THE LENGTH OF THE SKID MARKS AND THE DRAG FACTOR. THE LENGTH OF THE SKID MARKS CAN BE MEASURED WITH VARIOUS TYPES OF MEASURING DEVICES AND REQUIRES ONLY BASIC MEASURING SKILLS. FINDING THE DRAG FACTOR IS ANOTHER MATTER REQUIRING MUCH MORE ATTENTION TO DETAIL AND ANALYSIS.

THERE ARE BASICALLY THREE COMMON METHODS FOR FINDING DRAG FACTOR. THEY ARE: USE OF CHARTS, SKID TESTS, AND SKID DEVICES. WHEN SPEED ESTIMATES ARE USED IN COURT OR OTHER TYPES OF HEARINGS TO REACH CONCLUSIONS, THE AREA MOST COMMONLY DISPUTED IS THE METHOD USED BY THE INVESTIGATOR FOR DETERMINING DRAG FACTOR. ALL THREE METHODS ARE SUBJECT TO CHALLENGE AND THE INVESTIGATOR SHOULD BE PREPARED TO DEFEND THE POSITION TAKEN TO ARRIVE AT MINIMUM SPEED ESTIMATES.

IN THE FOLLOWING CHAPTERS, WE WILL DISCUSS EACH METHOD, ITS PARTICULAR ADVANTAGE, OR DISADVANTAGE, AND PROBLEMS USUALLY ENCOUNTERED, WHEN GIVING TESTIMONY ABOUT EACH METHOD.

CHAPTER ONE

USE OF CHARTS

CHARTS HAVE BEEN DEVELOPED FROM VARIOUS SOURCES OVER THE YEARS AND IT SHOULD BE POINTED OUT THAT CHARTS ARE DESIGNED TO GIVE "BALL PARK" FIGURES ONLY! IT IS RECOMMENDED THAT CHARTS BE USED ONLY FOR CLASSROOM OR HYPOTHETICAL SITUATIONS. THEIR USE IN REAL ACCIDENT INVESTIGATIONS CAN LEAD TO SERIOUS QUESTIONS AS TO AUTHENTICITY AND VERACITY OF SPEED ESTIMATES.

FOR EXAMPLE, CHARTS GENERALLY GIVE DRAG FACTORS BASED ON DRY OR WET PAVEMENT AND SPEEDS ABOVE OR BELOW 30 MPH. INVARIABLY, SOMEONE WILL ASK, "HOW WET IS WET?" ALSO, THE THEORY THAT DRAG FACTOR CHANGES ABOVE 30 MPH IS BEING QUESTIONED BY MANY SEASONED AND VETERAN TRAFFIC ACCIDENT INVESTIGATORS AND RECONSTRUCTIONISTS AND SOME TESTS HAVE BEEN QUOTED AS DISPUTING THE THEORY. IN ANY CASE WHERE WET PAVEMENT IS CONCERNED, THE USE OF SKID MARKS ON THE PAVEMENT AS A TEST FOR DRAG FACTOR WILL BE DISCUSSED LATER.

CHARTS GENERALLY SHOW CATEGORIES OF SURFACES SUCH AS NEW/SHARP, TRAVELLED, TRAFFIC POLISHED, OR EXCESS TAR. IMMEDIATELY THIS BRINGS SEVERAL ISSUES INTO FOCUS. HOW NEW IS NEW? HOW TRAVELLED IS TRAVELLED? HOW POLISHED IS POLISHED? ETC. FOR EXAMPLE, ONE CHART SHOWS NEW/SHARP ASPHALT AS HAVING A DRAG FACTOR ABOVE 30 MPH AS ANY

NUMBER FROM .65 TO 1.00. WITH A SKID DISTANCE OF 120 FEET AND USING THE FORMULA $S = \sqrt{30} DF$, THE MINIMUM ESTIMATED SPEED VARIES FROM 48 MPH TO 60 MPH! ADJUSTING THE DRAG FACTOR EVEN FURTHER FOR GRADE OR SUPER ELEVATION ONLY MAKES THE SPEED ESTIMATE MORE SUSPECT. TAKING ALL THIS INTO CONSIDERATION, CHARTS ARE NOT RECOMMENDED FOR REAL ACCIDENT INVESTIGATION. SOME COURTS HAVE HELD THAT CHARTS ARE SIMPLY NOT ACCURATE FOR LEGAL PURPOSES. ALSO, SOME INSTITUTIONS OF HIGHER LEARNING HAVE DISCONTINUED THE USE OF DRAG FACTOR CHARTS IN ACCIDENT INVESTIGATION TRAINING.

CHAPTER TWO

SKID TESTS

SKID TESTS ARE ANOTHER METHOD THAT HAVE BEEN USED FOR YEARS IN FINDING DRAG FACTOR. SKID TESTS ALSO HAVE SOME INHERENT PROBLEMS WHEN IT COMES TO FINDING DRAG FACTORS FOR SPEED ESTIMATES. DRAG FACTOR FROM SKID TESTS INVOLVES USING THE SPEEDOMETER OF THE TEST SKID VEHICLE TO DETERMINE SPEED FOR CONDUCTING THE TEST. WHEN THE SPEED OF THE VEHICLE IS DETERMINED AND THE DISTANCE OR LENGTH OF THE SKID MARKS IS MEASURED, THE NUMBERS ARE PUT INTO THE FOLLOWING FORMULA.

$$f = \frac{S^2}{30d}, \quad f = \text{DRAG FACTOR} \quad s = \text{SPEED} \quad d = \text{SKID MARK LENGTH OR SKID DISTANCE}$$

LET'S FIRST DISCUSS THE ISSUE OF SPEEDOMETER ACCURACY. SOME INVESTIGATORS HAVE USED RADAR TO CHECK ACCURACY. HOWEVER, RADAR IS GENERALLY FIXED AS PLUS OR MINUS ONE MILE PER HOUR. AS WE SHALL SOON FIND OUT, A ONE MILE PER HOUR ERROR IN THE SPEED CAN HAVE A PRONOUNCED EFFECT ON THE RESULTING DRAG FACTOR. ANOTHER METHOD OF CHECKING THE SPEEDOMETER IS TO RUN THE VEHICLE OVER A MEASURED MILE COURSE (SUCH AS ALONG AN INTERSTATE WITH MILE MARKERS) AT A CONSTANT SPEED AND RECORD THE NUMBER OF SECONDS IT TAKES THE VEHICLE TO TRAVERSE THE MILE. THE NUMBER OF SECONDS IS THEN DIVIDED INTO 3600 (THE NUMBER OF SECONDS IN AN HOUR). FOR EXAMPLE, IF THE TEST

SKID WAS DONE AT 35 MPH AND THE SPEEDOMETER CHECK SHOWED 100 SECONDS TO TRAVEL THE MEASURED MILE, THEN THE TEST WAS REALLY DONE AT 36 MPH, NOT 35. TO ARRIVE AT THE SPEED OF 36 MPH, WE DIVIDED 3600 BY 100 SECONDS AND THE RESULT WAS 36. A PLACE FOR POSSIBLE ERROR IN THE SPEEDOMETER CHECK IS THE METHOD OF DRIVING THE VEHICLE OVER THE MEASURED MILE. THE DRIVER SHOULD ACCELERATE TO ABOUT 2-3 MPH OVER THE TEST SPEED AND THEN LET THE TEST VEHICLE STABILIZE AT THE TEST SPEED PRIOR TO BEGINNING THE ONE MILE COURSE. THE SPEED MUST THEN BE HELD CONSTANT THROUGH THE ENTIRE MILE. CRUISE CONTROL SHOULD NOT BE USED FOR THE SPEEDOMETER TEST OR THE SKID TEST. ALSO, VEHICLES WITH SPEEDOMETER NEEDLES SHOULD BE USED RATHER THAN THOSE WITH LCD-TYPE DISPLAY.

AS PREVIOUSLY DISCUSSED, AN ERROR OF ONE MILE PER HOUR CAN AFFECT THE DRAG FACTOR. FOR EXAMPLE, IF A SKID DONE AT 35 MPH, LEFT 60 FEET OF SKID MARKS, THE DRAG FACTOR WOULD BE .68. IF THE SPEED WAS ACTUALLY 36 MPH, THE DRAG FACTOR CHANGES TO .72. IF THE SPEED WAS ACTUALLY 34 MPH, THE DRAG FACTOR CHANGES TO .64. THESE VARIABLES ARE ONLY FOR AN ERROR OF ONE MILE PER HOUR. IF THERE IS AN ERROR OF TWO MILES PER HOUR OR MORE, THE TEST BECOMES EVEN MORE QUESTIONABLE. FOR EXAMPLE, A SPEED OF 37 MPH WOULD PRODUCE A DRAG FACTOR OF .76.

ANOTHER AREA OF POSSIBLE ERROR IS THE MANNER IN WHICH THE TEST SKID IS ACTUALLY CONDUCTED. THE FORMULA WILL GIVE THE SPEED OF THE VEHICLE AT THE BEGINNING OF THE SKID. IF THE PERSON DRIVING THE TEST VEHICLE ALLOWS THE VEHICLE TO SLOW BEFORE BRAKING (THIS CAN OCCUR BY NOT IMMEDIATELY LOCKING THE BRAKES), THE LOSS OF SPEED BEFORE BRAKING

WILL PRODUCE A DRAG FACTOR THAT IS TOO HIGH. THIS DRAG FACTOR WILL THEN GIVE A HIGH SPEED ESTIMATE FOR THE ACCIDENT VEHICLE. REMEMBER, LOWEST MINIMUM ESTIMATED SPEED IS THE MOST DEFENSIBLE IN HEARINGS, COURT, OR ROUTINE ACCIDENT REPORTS.

ANOTHER PROBLEM IS THE DISTANCE THE TEST VEHICLE ACTUALLY SKIDDED. THE FORMULA REFERS TO THE MOVEMENT OF THE CENTER OF MASS OF THE VEHICLE. THERE ARE VARYING OPINIONS AS TO HOW TO MEASURE THE MARKS. ONE METHOD IS TO AVERAGE THE MARKS FROM TWO SKID TESTS AND THEN PUT THE AVERAGE DISTANCE INTO THE FORMULA. THIS GENERALLY CAUSES A HIGH DRAG FACTOR. ANOTHER METHOD IS TO CONDUCT A SERIES OF TESTS UNTIL THE LONGEST SKIDS FROM THE TESTS ARE WITHIN 10% OF EACH OTHER. THE LONGEST SKID DISTANCE IS THEN USED IN THE FORMULA AND USUALLY PRODUCES THE LOWEST POSSIBLE DRAG FACTOR, WHICH PRODUCES A LOWER MINIMUM ESTIMATED SPEED.

FOR EXAMPLE, THE FOLLOWING TEST SKIDS ARE DONE AT A SPEED OF 30 MPH WITH THESE RESULTS:

FIRST TEST

LF 40
 RF (41)
 LR 38
 RR 37

SECOND TEST

LF 35
 RF (35)
 LR 34
 RR 33

THIRD TEST

LF (40)
 RF 39
 LR 38
 RR 39

THE LONGEST SKID IN THE FIRST TEST (41) AND THE LONGEST SKID IN THE SECOND TEST (35) ARE NOT WITHIN 10%. THUS, THE NEED FOR THE THIRD TEST IS APPARENT. THE LONGEST SKID ON THE THIRD TEST WAS 40, WHICH IS WITHIN 10% OF THE LONGEST SKID IN THE FIRST TEST (41). SO, FOR DETERMINING THE DRAG FACTOR FROM THIS SERIES OF TESTS, 41 WOULD BE THE NUMBER INTRODUCED INTO THE FORMULA ALONG WITH 30 MPH AS THE SPEED. THE RESULTING DRAG FACTOR WOULD BE .73.

FOR STOPPING THE TEST VEHICLE, HEAVY AND IMMEDIATE BRAKING IS ESSENTIAL. ALL TIRES MUST LOCK TO USE RESULTS OF A SKID TEST FOR FINDING DRAG FACTOR. IF THE ACCIDENT VEHICLE IS IN CONDITION TO BE USED, IT WOULD BE THE BEST VEHICLE TO USE. OTHERWISE, A SIMILAR VEHICLE SHOULD BE USED. IF POSSIBLE, WEIGHT OF THE ACCIDENT VEHICLE AND THE TEST VEHICLE SHOULD BE CLOSE FOR APPEARANCE PURPOSES. WHILE IT IS TRUE THAT WEIGHT OF THE SKIDDING VEHICLE MAKES NO DIFFERENCE WHEN DETERMINING DRAG FACTOR, WEIGHT IS A FACTOR DURING THAT TIME WHEN WEIGHT SHIFT KEEPS THE FRONT WHEELS FROM LOCKING RIGHT AWAY. OF ALL POSSIBLE CONSIDERATIONS TO BE MADE, THE ROAD SURFACE SHOULD BE THE SAME AS WHERE THE ACCIDENT TOOK PLACE, PREFERABLY IN THE SAME DIRECTION OF TRAVEL AND CERTAINLY UNDER THE SAME CLIMATIC CONDITIONS. THE SKID TEST MAY BE CONDUCTED ON THE SAME ROAD SURFACE BUT IN A DIFFERENT LOCATION UNDER THE SAME CLIMATIC CONDITIONS. WHEN THIS IS DONE, IT MAY BE NECESSARY TO ADJUST THE DRAG FACTOR FOR DIFFERENCES IN GRADE BETWEEN THE TEST SITE AND THE ACCIDENT SITE. THIS

CAN POSE A PROBLEM FOR SOME INVESTIGATORS DUE TO THE "MENTAL" MATHEMATICS INVOLVED. IF THE GRADES ARE PROPERLY MEASURED AT THE ACCIDENT SITE AND THE TEST SITE, THE INVESTIGATOR CAN MAKE A SIMPLE SCALE TO ASSIST IN ARRIVING AT THE DRAG FACTOR FOR THE ACCIDENT SITE. FOR EXAMPLE, IF THE SKID TEST WAS PERFORMED ON THE ROAD SURFACE WITH AN UP-GRADE OF 5% AND THE ACCIDENT HAPPENED ON THE SURFACE WITH A DOWNGRADE OF 2%, THE SCALE COULD BE USED AS FOLLOWS: SHOW THE TEST ON THE SCALE AT THE PLUS 5% LEVEL AND SIMPLY COUNT DOWN TO THE MINUS 2% LEVEL. SO, IF THE TEST DRAG FACTOR WAS .78 AT THE PLUS 5 ON THE SCALE, THE DRAG FACTOR AT THE ACCIDENT SITE WOULD BE .71. SEE EXHIBIT 1. THIS SCALE CAN BE MADE AS LARGE AS NECESSARY AND USED VERY EASILY AS LONG AS THE INVESTIGATOR NOTES THE PLACES ON THE SCALE FOR THE TEST AND THE ACCIDENT. THEN, THE INVESTIGATOR NEED ONLY COUNT UP OR DOWN THE SCALE AS APPROPRIATE.

THERE MAY BE SOME CONTROVERSY WHEN THE ACCIDENT VEHICLE LEAVES SKID MARKS ON WET SURFACES. IN SOME CASES, DRIVERS WILL LATER CLAIM THAT THE CAR WAS HYDROPLANING. THIS SEEMS UNLIKELY SINCE THE CAR TIRES LEFT SKID MARKS ON THE ROAD! IF A TEST SKID IS ALSO DONE ON THE WET SURFACE AND ALSO LEAVES SKID MARKS, THE CONTROVERSY MAY GET BACK TO WHETHER OR NOT THE ACCIDENT SURFACE WAS WETTER THAN THE TEST SURFACE AND VICE VERSA. IN REALITY, IT PROBABLY MAKES NO DIFFERENCE BUT THE WINNER IN SUCH AN ARGUMENT IS THE ONE WHO SOUNDS THE MOST CONVINCING!

SKIDDING A VEHICLE AT THE ACCIDENT SCENE CAN SOMETIMES TELL THE INVESTIGATOR THAT THE ACCIDENT VEHICLE WAS EXCEEDING THE SPEED LIMIT. FOR EXAMPLE, IF IT IS POSSIBLE TO SKID A VEHICLE AT THE ACCIDENT SCENE AND CONDUCT THE SKID AT THE SPEED LIMIT AND IF THE ACCIDENT VEHICLE LEFT LONGER SKID MARKS THAN THE TEST VEHICLE AND ALL TIRES WERE SKIDDING ON BOTH VEHICLES, THEN IT IS FAIRLY SAFE TO SAY THAT THE ACCIDENT VEHICLE WAS AT LEAST GOING FASTER THAN THE SPEED LIMIT AT THE BEGINNING OF THE SKID.

CHAPTER THREE

SKID DEVICES

ANOTHER METHOD OF DETERMINING DRAG FACTOR IS THE USE OF A SKID DEVICE OR SKID "SLED." THERE ARE MANY VARIATIONS OF THE SAME DEVICE BUT THE SIMPLEST CAN BE EASILY MADE WITHOUT SPENDING A LOT OF MONEY. DIRECTIONS FOR CONSTRUCTING A SKID SLED WILL FOLLOW.

SKID SLEDS WORK ON THE BASIC PRINCIPLE OF PHYSICS THAT STATES THAT THE DRAG FACTOR IS EQUAL TO THE FORCE IN POUNDS IT TAKES TO DRAG AN OBJECT ACROSS A SURFACE DIVIDED BY THE WEIGHT IN POUNDS OF THE OBJECT. THIS FORMULA IS ALSO EXPRESSED AS $f = \frac{F}{W}$. THIS FORMULA WILL WORK WITH ANY OBJECT INCLUDING METAL, AND HUMANS (IF YOU CAN FIND A VOLUNTEER WILLING TO BE DRAGGED!). FOR EXAMPLE, IF AN OBJECT WEIGHED 6000 POUNDS (LIKE A CAR WITH THE WHEELS LOCKED) AND IT TOOK 4000 POUNDS TO DRAG IT ACROSS THE SURFACE, THE DRAG FACTOR WOULD BE 4000 DIVIDED BY 6000 OR .66. IF CONDUCTED PROPERLY, THE TEST IS VERY ACCURATE. IT CAN ALSO BE PERFORMED USING A TIRE, SINCE THAT IS THE DRAG FACTOR WE ARE CONCERNED WITH MOST OF THE TIME.

YOU WILL NEED TO OBTAIN A USED AUTOMOBILE TIRE WITH GOOD TREAD LEFT ON IT. THE TYPE OF TIRE REALLY MAKES NO DIFFERENCE AS LONG AS IT IS A NORMAL ROAD-USE TIRE. THE TREAD IS MORE FOR APPEARANCES THAN ANYTHING ELSE. HOWEVER, DO NOT USE A BALD TIRE AS IT WILL GIVE A HIGHER DRAG FACTOR ON DRY PAVEMENT THAN ONE WITH GOOD TREAD LEFT ON IT. YOU WILL NEED TO CUT THE TIRE AS SHOWN IN EXHIBIT TWO. REMEMBER, THE

LARGER YOU MAKE THE TIRE, THE MORE IT IS GOING TO WEIGH AND THE TIRE WILL TRAVEL WITH YOU TO AN ACCIDENT SCENE. YOU MAY FIND A HACK SAW AND BOLT CUTTERS HANDY WHEN CUTTING THE TIRE. PLACE THE CUT TIRE ON A LEVEL SURFACE. ONCE THE TIRE HAS BEEN CUT, YOU MUST NOW FIND THE CENTER OF MASS OF THE TIRE. FILL THE CUT TIRE WITH WATER AND MARK THE WATER LEVEL. NEXT, POUR THE WATER INTO A CONTAINER AND MEASURE THE TOTAL VOLUME OF WATER. DO NOT SPILL ANY OF THE WATER IN THE PROCESS. POUR ONE HALF THE VOLUME OF WATER BACK INTO THE CUT TIRE. MARK THIS WATER LEVEL ON THE SIDE OF THE TIRE. THIS WILL NOW BE THE APPROXIMATE CENTER OF MASS WHEN THE SLED IS FINISHED. DRILL A HOLE IN THE CENTER OF THE TREAD IN LINE WITH THE MARK SHOWING THE CENTER OF MASS. INSTALL AN EYE-BOLT THROUGH THE HOLE AND SNUGGLY HOLD IT IN PLACE WITH A BOLT, NUT, AND WASHER. SEE EXHIBIT 3. ONCE COMPLETED, THE BOLT WILL BE HELD IN PLACE WITH CEMENT. NEXT, DRILL TWO HOLES IN THE SIDE OF THE TIRE, ONE AT EACH END, AND INSERT TWO BOLTS INTO THE HOLES. SECURE THE BOLTS WITH NUTS AND WASHERS SO THAT THE TIRE IS HELD IN ITS ORIGINAL APPROXIMATE SHAPE OR NORMAL SHAPE. SEE EXHIBIT 4. THIS IS NECESSARY SO THAT THE SIDES DON'T EXPAND WHEN CONCRETE IS Poured INTO THE TIRE. NOW, ATTACH A WIRE TO THE FRONT CROSS BOLT AND BRING IT OVER THE FRONT OF THE TIRE TO CONNECT TO THE EYE-BOLT. WITH THE TIRE SITTING ON A LEVEL SURFACE, ADJUST THE WIRE SO THAT THE EYE-BOLT IS PARALLEL TO THE BOTTOM OF THE TIRE. NOW, FILL THE TIRE WITH CONCRETE TO THE ORIGINAL LEVEL AND SUSPEND THE TIRE

BETWEEN TWO BLOCKS OF WOOD SO THAT THE BOTTOM IS NOT TOUCHING ANYTHING. IF THE EYE-BOLT MOVES WHILE THE CONCRETE IS SETTING UP, ADJUST THE WIRE SO THAT THE EYEBOLT REMAINS LEVEL WITH THE BOTTOM OF THE TIRE AND PARALLEL WITH THE SURFACE. NOW, TO USE THE SLED, ALL YOU NEED IS A SPRING-TYPE SCALE TO WEIGH THE SLED AND MEASURE THE POUNDS OF PULL REQUIRED TO MOVE IT ACROSS THE SURFACE.

THE TIRE SHOULD BE WEIGHED BEFORE EACH USE. IT IS NOT UNCOMMON FOR THE SLED TO PICK UP SOME WEIGHT FROM ABSORPTION OF MOISTURE. THE SPRING SCALE DOES NOT HAVE TO BE CERTIFIED AS LONG AS THE SAME SCALE IS USED TO WEIGH THE TIRE AS IS USED TO DRAG THE TIRE ACROSS THE SURFACE. TO MEASURE THE DRAG FACTOR OF A SURFACE, PULL THE TIRE ALONG THE SURFACE AND NOTE THE POUNDS OF PULL REQUIRED TO MOVE THE TIRE. DO NOT COUNT THE POUNDS REQUIRED TO START THE TIRE MOVING. NOTE THE NUMBER OF POUNDS AFTER THE TIRE IS MOVING ACROSS THE SURFACE AND IS MOVING AT A FAIRLY CONSTANT RATE. THE SCALE SHOULD BE KEPT LEVEL WITH THE ROADWAY AS MUCH AS POSSIBLE SINCE PULLING AT AN ANGLE COULD INCREASE THE WEIGHT OF THE SLED AND GIVE AN INACCURATE READING. ONCE YOU KNOW HOW MUCH THE TIRE WEIGHS AND HOW MANY POUNDS IT TOOK TO DRAG IT, YOU CAN FIND THE DRAG FACTOR OF THE SURFACE FOR A TIRE. FOR EXAMPLE, IF THE TIRE WEIGHED 44 POUNDS AND IT TOOK 26 POUNDS OF PULL TO MOVE IT, THEN YOU WOULD DIVIDE 26 BY 44 AND THE DRAG FACTOR WOULD BE .59.

$$f = \frac{F}{W} \quad \text{OR} \quad f = \frac{26}{44} \quad \text{OR} \quad f = .59$$

SINCE THE DRAG SLED CAN BE USED AT THE ACCIDENT SCENE, THERE IS NO NEED TO MAKE ANY ADJUSTMENTS FOR GRADE IN SKIDS OR SUPERELEVATION IN YAWS. HOWEVER, BE SURE TO CONDUCT THE TEST NEXT TO THE MARKS ON THE ROAD IN THE SAME DIRECTION OF TRAVEL AS THE ACCIDENT VEHICLE. USE OF THE SLED FOR GRAVEL OR GRASS SURFACES IS NOT RECOMMENDED. ONE AREA OF CRITICISM THAT MAY ARISE IN THE TEST IS THE FACT THAT A SKIDDING VEHICLE GENERATES CONSIDERATE HEAT ON THE TIRES AND THE DRAG SLED DOES NOT. THIS HAS LITTLE OR NO EFFECT ON THE TEST. IN FACT, HOTTER TIRES ACTUALLY HAVE SLIGHTLY MORE FRICTION AS DEMONSTRATED BY DRAG RACERS WHO SPIN THEIR TIRES JUST PRIOR TO THE RACE SO THAT THEY ARE STICKY. THIS ALSO CAUSES CONSIDERABLE TIRE WEAR AND EVENTUAL DISINTEGRATION. THAT IS WHY MANY RACING TIRES ARE NOT APPROVED FOR ROAD USE. SINCE THE DRAG TIRE DOES NOT BUILD UP CONSIDERABLE HEAT, THE TEST WILL ACTUALLY GIVE A LOWER DRAG FACTOR THAN THE ACTUAL ACCIDENT VEHICLE AND WILL RESULT IN A MORE CONSERVATIVE SPEED ESTIMATE. REMEMBER, THE LOWEST MINIMUM ESTIMATED SPEED IS THE MOST DEFENSIBLE TO USE. THE DRAG SLED TEST IS PROBABLY LESS SUBJECT TO ERROR THAN MOST, IF NOT ALL, OTHER METHODS CURRENTLY BEING USED.

EXHIBIT 1

FOR THIS TEST, READ THE CHART
FROM TOP TO BOTTOM-----

IF TEST AT	+ 5	WAS	.78
	+ 4	IS	.77
	+ 3	IS	.76
	+ 2	IS	.75
	+ 1	IS	.74
LEVEL	0	IS	.73
	- 1	IS	.72
	- 2	IS	.71 WHERE ACCIDENT HAPPENED.
	- 3		
	- 4		
	- 5		

EXHIBIT 2

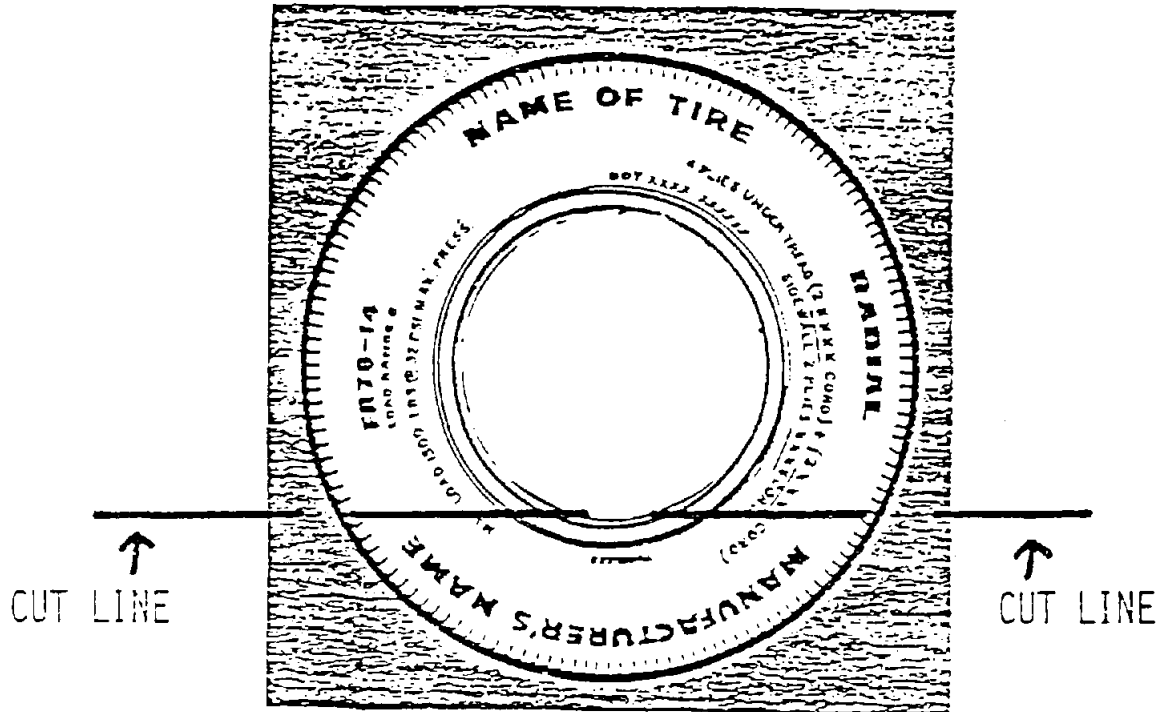

EXHIBIT 3

EYEBOLT GOES
AT APPROXIMATE
CENTER OF MASS

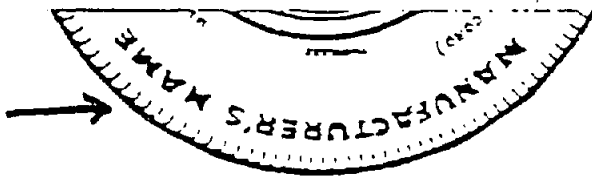
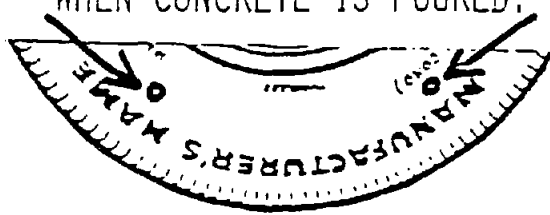

EXHIBIT 4

PUT BOLTS THROUGH HERE TO
KEEP TIRE FROM EXPANDING
WHEN CONCRETE IS Poured.







PHOTOGRAPHIC DOCUMENTATION OVERVIEW AND CASE REVIEWS

**OBJECTIVE: TO DISCUSS AND REVIEW THE NEED FOR
PHOTOGRAPHS IN ACCIDENT INVESTIGATION
AND THE TECHNIQUES FOR TAKING PHOTOGRAPHS;
TO REVIEW PHOTOGRAPHS FROM ACTUAL CASES.**

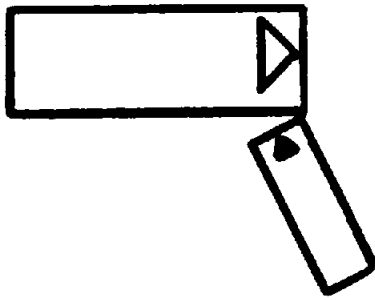

MOST COMMON PHOTOGRAPHIC PROBLEMS

1. CAMERA EQUIPMENT AND APPROPRIATE FILM
2. SCENE OUT OF FOCUS, TOO CLOSE, TOO FAR AWAY
3. HIGH-LIGHTING OF PHOTOGRAPHS
4. "BLOOD & GUTS" PHOTOGRAPHS
5. LACK OF VEHICLE AND SCENE IDENTIFICATION

MEDIUM SPEED OR FILMS FOR MOST VERSATILITY

Films in this group have medium speed and medium fine grain, a combination that makes them suitable for a great range of photography.

Standardize on a film in this category. Learn its characteristics thoroughly and you'll be able to handle almost any lighting condition, indoors or out, except in extremely poor available light.

Examples of medium speed and versatile films include Kodak Plus-X, ASA 125, Kodak Verichrome Pan, ASA 125, Ansco All-Weather Film, ASA 125, and Agfa Isopan IF, ASA-100.

HIGH SPEED FILMS OR FILMS FOR THE MOST SPEED

This category might be divided into two groups, "fast" and "super fast" films.

Many fast films, thanks to relatively recent developments in film making technology, have the advantage of small, tight grain patterns which make them useful for a wide range of general photography in addition to the more obvious low light and available light situations.

These often are a good choice for available light where a medium speed film requires too slow a shutter speed or too wide an aperture.

Although grain normally is not objectionable in news photography because presses cannot reproduce all detail in the finished print, grain may be objectionable in commercial prints or even in those the photographer keeps for his own enjoyment.

Also, since grain is not a major factor to the news photographer, extra speed of the high speed films often will enable him to get the picture poor lighting might have otherwise ruled out.

Examples of high speed films are Kodak Tri-X, ASA 400, Ansco Super Hy-Pan, ASA 500.

An example of the super high speed group might include Kodak Royal-X, ASA 1250.

Although there is also a great variety of color films for various purposes, at this stage most photographers will be concerned only with two major types: color transparency (Slides) and color negative (Prints).

Since the majority of color photography is in daylight or with strobe or blue flashbulbs inside, the choice has been simplified. One film color designation, "DAYLIGHT TYPE", will be suitable for either slides or prints. The photographer should be aware, however, that other light sources produce a different color or hue than normal daylight and may cause a strange color cast.

The following are examples of color transparency daylight type films: Kodak Kodacolor-X, ASA 80, and Agfacolor CN 17, ASA 40.

PHOTOGRAPHS

PHOTOS, ESPECIALLY COLOR PHOTOS, ARE AN EXCELLENT WAY TO RECORD FACTS AND PRESERVE EVIDENCE FOR THE FUTURE. THEY MIGHT ALSO RECORD THINGS YOU OVERLOOKED AT THE ACCIDENT SCENE.

PHOTOS OF THE ACCIDENT SCENE SHOULD BE TAKEN AS SOON AS POSSIBLE TO
1) RECORD THE POSITIONS OF THE VEHICLES BEFORE THEY ARE MOVED; 2) RECORD SUCH THINGS AS BROKEN GLASS, OIL STAINS AND HUBCAPS AND OTHER VEHICLE PARTS BEFORE THEY ARE REMOVED OR OBLITERATED; 3) RECORD SKID MARKS; AND
4) SHOW TRAFFIC CONTROL SIGNS AND DEVICES, AREA SPEED LIMIT AND OTHER WARNING SIGNS.

HERE ARE SOME SUGGESTIONS FOR PHOTOGRAPHING THE ACCIDENT SCENE:

TAKE SEVERAL PHOTOS OF THE ACCIDENT SCENE: 1) IN EACH DIRECTION AWAY FROM THE POINT OF IMPACT; 2) FROM EACH APPROACH TO THE POINT OF IMPACT, SHOWING THE VIEW EACH DRIVER HAD OF THE KEY POINT OF THE ACCIDENT, AS WELL AS ROAD ALIGNMENT; 3) A CLOSEUP OF THE SCENE, SHOWING THE POINT OF IMPACT; AND
4) AN OVERALL VIEW OF THE SCENE.

TAKE ENOUGH PICTURES OF EACH VEHICLE TO SHOW THE EXTENT OF THE DAMAGE. TAKE ADDITIONAL SHOTS TO ESTABLISH THE ANGLE OF COLLISION AND THE MOVEMENT OF EACH WHILE IN CONTACT.

PHOTOGRAPH DEBRIS, SKID MARKS AND ANY OTHER PHYSICAL EVIDENCE OF VEHICLE MOVEMENT BOTH BEFORE AND AFTER IMPACT.

PHOTOGRAPH ANY BROKEN VEHICLE PARTS. TRY TO ESTABLISH WHETHER THE ACCIDENT CAUSED THE DAMAGE TO THOSE PARTS OR IF THEY WERE ALREADY DAMAGED WHEN THE ACCIDENT HAPPENED.

TAKE AS MANY OTHER PHOTOS AS YOU NEED TO PRESERVE SUCH DATA AS ROAD DEFECTS, OBSTRUCTIONS, FOLIAGE THAT BLOCKS THE VIEW, OR ANY OTHER PHYSICAL CONDITIONS THAT MAY HAVE BEEN A FACTOR IN THE ACCIDENT.

IDENTIFY EACH PHOTO BY TIME AND DATE TAKEN, DIRECTION IN WHICH TAKEN, AND THE POINT FROM WHICH IT WAS TAKEN.

FILMS

TO HELP CHOOSE THE RIGHT FILMS FOR DIFFERENT PURPOSES, BLACK AND WHITE FILMS ARE LISTED IN THREE MAJOR GROUPS AS FOLLOWS;

"SLOW" OR FILMS FOR MOST SHARPNESS. THESE ARE SLOW TO MEDIUM-SPEED FILMS WITH ULTRA-FINE GRAIN.

"MEDIUM SPEED" OR FILMS FOR MOST VERSATILITY. THESE ARE MEDIUM-SPEED FILMS WITH MEDIUM-FINE GRAIN.

"FAST" OR FILMS FOR MOST SPEED. THESE ARE DIVIDED INTO TWO GROUPS: STANDARD FAST FILMS WITH MEDIUM-COARSE GRAIN AND SUPER-FAST FILMS WITH VERY COARSE GRAIN.

OF NECESSITY, THIS GROUPING IS ARBITRARY. IN SOME CASES, A FILM MIGHT WITH JUSTIFICATION BE LISTED IN MORE THAN ONE CATEGORY. FOR EXAMPLE, SOME OF THE HIGH-SPEED FILMS ARE VERY VERSATILE AND SOME OF THE FASTER "MOST SHARPNESS" FILMS CAN BE USED FOR JUST ABOUT ANY KIND OF SHOOTING EXCEPT PHOTOGRAPHY BY VERY DIM AVAILABLE LIGHT. SOME OF THE "MOST VERSATILE" FILMS CAN RIVAL MANY "MOST SHARPNESS" FILMS IN FINE GRAIN AND SHARP DETAIL.

THE FINAL CHOICE OF FILMS FOR DIFFERENT PURPOSES SHOULD DEPEND ON YOUR OWN NEEDS AND WORKING METHODS.

"SLOW" OR FILMS FOR MOST SHARPNESS

THESE ARE ULTRA-FINE-GRAIN FILMS OF SLOW TO MEDIUM SPEED. THEY ARE SOMETIMES CALLED "THIN EMULSION" FILMS BECAUSE THEY ARE COATED WITH A VERY THIN LAYER OF EMULSION WHICH INCREASES THE SHARPNESS WITH WHICH THEY CAN RECORD AN IMAGE.

A FILM FROM THIS GROUP MIGHT BE CHOSEN IF A CRISP, EXTRA SHARP IMAGE OF A SUBJECT CONTAINING FINE DETAIL IS WANTED. THIS WOULD BE ESPECIALLY SO IF SHOOTING WITH 35mm FILM IF THE NEGATIVE WILL BE ENLARGED CONSIDERABLY.

MANY LANDSCAPE, ARCHITECTURAL, INDUSTRIAL, PORTRAIT, STILL-LIFE, AND FASHION SUBJECTS MIGHT BEST BE HANDLED WITH A "SLOW" FILM.

"SLOW" FILMS ARE DESIGNED FOR USE IN FAIRLY BRIGHT LIGHT SUCH AS DAYLIGHT OUTSIDE OR FLASH OR FLOODS INSIDE.

AN EXAMPLE OF A "SLOW" FILM WITH ULTRA FINE GRAIN IS KODAK PANATOMIC-X WHICH IS RATED AT ASA 40.

(ASA IS THE AMERICAN STANDARDS ASSOCIATION DESIGNATION OF THE SPEED OF ALL FILMS. IT IS A RELATIVE NUMBER WHICH MEANS AN ASA OF 100 IS TWICE AS "FAST" AS ASA 50 BUT ONLY HALF THE SPEED OF ASA 200 FILM.)



G



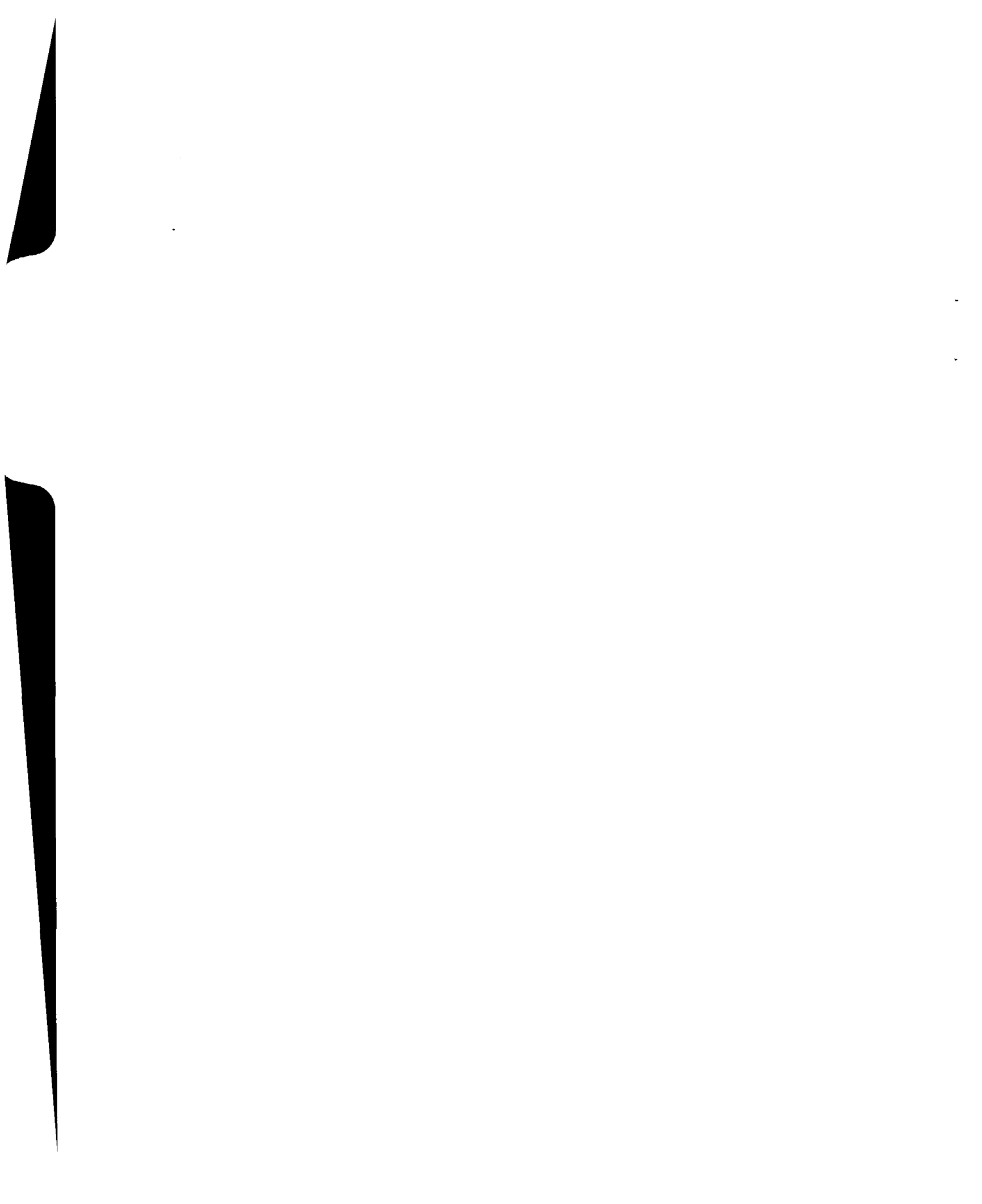

81

CONTRIBUTING FACTORS AND CASE REVIEW

OBJECTIVE: TO FAMILIARIZE THE STUDENTS WITH SOME OF THE MANY CONTRIBUTING FACTORS TO AN ACCIDENT AND REVIEW AN ACTUAL ACCIDENT AND ITS OWN CONTRIBUTING FACTORS.

CONTRIBUTING FACTORS

EACH FACTOR MUST BE EVALUATED AS IT PASSED THROUGH

THE ACCIDENT SEQUENCE : - BEFORE

- DURING

- AFTER

CONTRIBUTING FACTORS

THREE ELEMENTS OF CONSIDERATION :

- PEOPLE (HUMAN FACTORS)
- VEHICLE (MECHANICAL FACTORS)
- ENVIRONMENT (ROAD, WEATHER, LIGHTING, ETC.)

CONTRIBUTING FACTORS

ROAD ENVIRONMENT

- ROADSIDE OBSTACLES :
- TREES
 - UTILITY POLES
 - ROCKS
 - SIGN SUPPORTS
 - LIGHT SUPPORTS
 - NARROW BRIDGES

CONTRIBUTING FACTORS

ROAD ENVIRONMENT

PAVEMENT SURFACE: -POT HOLES

-LOW SHOULDERS

-SURFACE TEXTURE

CONTRIBUTING FACTORS

ROAD ENVIRONMENT

- ROADWAY GEOMETRY: - CURVES
- SUPER ELEVATION
 - LANE WIDTH
 - SHOULDERS
 - GUARD RAILS
 - CURBS
 - GRADES

CONTRIBUTING FACTORS

ROAD ENVIRONMENT

- SIGNAGE: - ADVANCE WARNING
- CONFUSING MESSAGES
 - VISIBILITY
 - UNIFORMITY

CONTRIBUTING FACTORS

ROAD ENVIRONMENT

LIGHTING : - GLARE

- UNIFORMITY

- TRANSITION

- CONFUSION (NUMBERS)

CONTRIBUTING FACTORS

ROAD ENVIRONMENT

RAILROAD CROSSING : - SIGHT DISTANCE

- WARNING DEVICES

- CROSSING PROCEDURES

- ENCROACHING TRAFFIC

CONTRIBUTING FACTORS

ROAD ENVIRONMENT

- CONSTRUCTION ZONES :
- ADVANCE WARNING
 - EQUIPMENT
 - SIGNAGE
 - BARRICADES
 - BARRIERS
 - VISIBILITY (DUST, ETC.)

CONTRIBUTING FACTORS

ENVIRONMENT

- RAIN
- SNOW
- TEMPERATURE
- ICE
- SLEET/HAIL
- LIGHTNING/THUNDER
- WIND
- HUMIDITY
- GLARE
- DARKNESS (TO INCLUDE SUNRISE AND SUNSET)

CONTRIBUTING FACTORS

MECHANICAL SYSTEMS

- TIRES : - BLOWOUT (BEFORE, DURING, AFTER)
- TREAD WEAR/CUTS/ABUSE
 - CORD DAMAGE BY RIM
 - UNMATCHED TIRES AND SIZES
 - INFLATION PRESSURE

CONTRIBUTING FACTORS

MECHANICAL SYSTEMS

- LAMPS : - ON OR OFF
- SHORTS OR FAULTY CIRCUITS
 - CLEANLINESS
 - SWITCH POSITION
 - FILAMENT STATUS
 - CORRECT BULB

CONTRIBUTING FACTORS

MECHANICAL SYSTEMS

- FLUIDS : - OIL AND GASOLINE AND DIESEL
- TRANSMISSION AND OTHER HYDRAULIC
 - RADIATOR
 - CONTAMINATION
 - CORRECT FLUID

CONTRIBUTING FACTORS

MECHANICAL SYSTEMS

BRAKES : - TYPE

- ADJUSTMENTS (SLACK, ETC.)

- WEAR

- OVERLOADING

- OIL

- AIR LEAKS

CONTRIBUTING FACTORS

MECHANICAL SYSTEMS

- POWER : - DRIVE TRAIN
- ENGINE CONDITION
 - CLUTCHES
 - STEERING BOX
 - FUEL FILTERS/INJECTORS

CONTRIBUTING FACTORS

MECHANICAL SYSTEMS

- CHASSIS/BODY :
- SUSPENSION/BELLOWS/SPRINGS/LIFTS
 - FRAME
 - ENERGY ABSORPTION BUMPERS
 - OCCUPANT SAFETY SYSTEMS
 - STRUCTURAL FAILURES

CONTRIBUTING FACTORS

HUMAN FACTORS

- DRIVER IMPAIRMENT : - ALCOHOL
- DRUGS (LEGAL AND ILLEGAL)
 - CARBON MONOXIDE
 - FATIGUE
 - SUDDEN DISABLEMENT

CONTRIBUTING FACTORS

HUMAN FACTORS

- PHYSICAL FACTORS/LIMITATIONS:
- VISION
 - HEARING
 - AGING (REACTION TIME)
 - STRESS (ALL SOURCES)
 - HANDICAPS/DISABILITIES

CONTRIBUTING FACTORS

HUMAN FACTORS

- ATTITUDES AND MOTIVATION :
- IGNORANCE (LACK OF AWARENESS)
 - FORGETFULNESS
 - INATTENTION (DISTRACTION)
 - HORSEPLAY (CARELESSNESS/NEGLIGENCE)

CONTRIBUTING FACTORS

HUMAN FACTORS

- NATURAL ABILITIES:
- APTITUDE (LEARNING CAPABILITY)
 - PSYCHOLOGICAL INFLUENCES
 - COORDINATION (BALANCE, RESPONSE)
 - EMOTION (ANGER, AGGRESSION, FEAR, ETC.)

CONTRIBUTING FACTORS

HUMAN FACTORS

- LEARNED CAPABILITIES :
- DRIVER TRAINING
 - DRIVER QUALIFICATIONS
 - KNOWLEDGE OF TRAVEL ROUTE
 - PROPER DRIVING HABITS
 - CONTROL, SKILL , MANEUVERS



INTERVIEW TECHNIQUES

OBJECTIVE: TO DISCUSS THE FUNDAMENTALS OF INTERVIEWING TECHNIQUES AND
THOSE THINGS THAT AFFECT WHAT A WITNESS PERCEIVES.

BAD HABITS OF LISTENING

- + FAKING ATTENTION
- + YIELDING EASILY TO DISTRACTIONS
- + REJECTING DIFFICULT LISTENING
- + PREMATURE REJECTION OF A SUBJECT AS UNINTERESTING
- + CRITICIZING DELIVERY AND PHYSICAL APPEARANCE
- + OPEN-MOUTH LISTENING

SUGGESTIONS FOR GOOD LISTENING

- + LISTEN NONEVALUATIVELY
- + LISTEN BETWEEN THE LINES
- + ANTICIPATE THE SPEAKER'S NEXT POINT
- + MAKE MENTAL SUMMARIES

MAJOR ELEMENTS OF WITNESS PHASE OF BUS ACCIDENT INVESTIGATION

1. LOCATE WITNESS AND PLAN THE INTERVIEW
2. INITIATE THE INTERVIEW AND ESTABLISH RAPPORT
3. ESTABLISH WITNESS CREDIBILITY
4. DOCUMENT WITNESS OBSERVATIONS AND COMMENTS BY ORAL STATEMENT AND/OR WRITTEN STATEMENT.
5. CONCLUDE INTERVIEW AND EVALUATE WITNESS.
6. ANALYZE OBSERVATIONS AND COMPARE WITH OTHER WITNESS INTERVIEWS.
7. REPORT RESULTS

LOCATING WITNESSES

1. USE OF COURTESY CARDS
2. REPORTS FROM POLICE OR EMERGENCY SUPPORT AGENCIES THAT RESPONDED
3. NEWS MEDIA REPORTS
4. HOSPITAL OR OTHER MEDICAL RECORDS
5. COMPANY ACCIDENT REPORTS
6. RESULT OF WITNESS INTERVIEW

WHO ARE THE WITNESSES OR PERSONS REQUIRING INTERVIEW ?

1. THE OPERATOR
2. VICTIMS, PASSENGERS, EYEWITNESSES
3. LOCAL LAW ENFORCEMENT AGENCIES
4. EMERGENCY AND AMBULANCE CREWS
5. NEWS MEDIA REPORTERS
6. RESIDENTS OR BUSINESSES NEAR THE ACCIDENT SCENE
7. TECHNICAL SPECIALISTS, I.E. DOCTORS, PATHOLOGISTS, CHEMISTS,
METALLURGISTS, ENGINEERS, MANUFACTURERS
8. CALL-INS, WALK-INS

INTERVIEW ARRANGEMENTS

1. CONTACT BY TELEPHONE, IF NOT AT THE SCENE
2. INTRODUCE YOURSELF, STATE YOUR BUSINESS, MISSION, OBJECTIVE, AND THE COMPANY YOU REPRESENT.
3. MAKE CONTACT AS SOON AS POSSIBLE AFTER THE ACCIDENT
4. USE POSITIVE APPROACH
5. SELECT LOCATION THAT IS CONDUCIVE TO GOOD INTERVIEW
6. AVOID GROUP INTERVIEWS
7. AVOID INTERVIEWING POTENTIAL HOSTILE WITNESSES ON "HOME GROUND", SEEK NEUTRAL LOCATION.

AIDS TO EFFECTIVE INTERVIEWING

1. COURTESY AND PATIENCE, ALWAYS!
 - A. WITNESS MAY HAVE DIFFICULTY REMEMBERING CERTAIN DETAILS.
 - B. SOME WITNESS OBSERVATIONS MAY HAVE PERIODIC VOIDS
 - C. IF WITNESS IS UNSURE OF DETAILS, RECORD DETAILS AS SUCH
 - D. DON'T INSIST ON A DEFINITE "YES" OF "NO" ANSWER

40

AID TO EFFECTIVE INTERVIEWING

2. TAKE NOTES DURING INITIAL WITNESS NARRATION
 - A. OBTAIN CONSENT AND EXPLAIN PURPOSE OF NOTES
 - B. TRY TO BE UNOBTRUSIVE WITH NOTE TAKING
 - C. CEASE NOTE TAKING IF DISTRACTING OR WITNESS BECOMES ABSORBED IN THE PROCESS

AIDS TO EFFECTIVE INTERVIEWING

3. USING A RECORDING DEVICE

- A. DEPENDS ON INTERVIEWER PREFERENCE
- B. ALWAYS WITH PERMISSION OF WITNESS
- C. SIGNED STATEMENT IS MORE DESIRABLE
- D. TAPE MUST BE TRANSCRIBED AND EDITED BY THE WITNESS
- E. WITNESS MAY CONCENTRATE MORE ON MICROPHONE THAN ON OBSERVATIONS
- F. ENVIRONMENT MAY NOT BE CONDUCIVE TO RECORDING
- G. CHANGING TAPES MAY BE DISTRACTING
- H. POSSIBLE MALFUNCTIONS

AIDS TO EFFECTIVE INTERVIEWING

4. OBTAIN WRITTEN STATEMENT TO SUPPORT NARRATIVE WHENEVER POSSIBLE
 - A. ASSIST WITH MECHANICS OF WRITTEN STATEMENT, I.E. OUTLINE FIRST, IF NECESSARY. EXPLAIN CHRONOLOGICAL APPROACH
 - B. TO CLARIFY SOME STATEMENTS, ENCOURAGE WITNESS TO USE DRAWINGS OR SKETCHES.
 - C. ASSIST WITNESS IN ORGANIZING BUT DO NOT AID IN TECHNICAL TERMINOLOGY---USE OWN WORDS.
 - D. WITNESS MAY TEND TO OMIT INFORMATION FELT TO BE INSIGNIFICANT-- INTERVIEWER SHOULD BE COGNIZANT OF WHAT WITNESS MAY CONSIDER INSIGNIFICANT. (WHAT SEEMS INSIGNIFICANT NOW MAY TURN OUT TO BE IMPORTANT MISSING LINK LATER.)
 - E. GIVE COPY OF STATEMENT TO WITNESS, ASK WITNESS TO READ IT AGAIN IN A FEW DAYS FOR RECALL OF ADDITIONAL INFORMATION.

FACTORS AFFECTING WITNESS REPORTING

1. INTELLIGENCE DOES PLAY A ROLE IN REPORTING RELIABILITY
 - A. LESS INTELLIGENT WITNESSES HAVE PROBLEMS IN RECALL BECAUSE OF DISINTEREST.
 - B. LESS INTELLIGENT WITNESSES MAY HAVE PROBLEMS IN ORGANIZING THOUGHTS AND PRESENTING OBSERVATIONS IN COHERENT MANNER.
 - C. NO WITNESS SHOULD BE OVERLOOKED ON BASIS OF APPARENT LACK OF INTELLIGENCE OR BECAUSE OF AGE.

FACTORS AFFECTING WITNESS REPORTING

2. EMOTION AND EXCITEMENT MAY PRODUCE DECIDED DISTORTION OR EXAGGERATION
 - A. MORE PROMINENT IN VERBAL STATEMENT
 - B. ACCURACY DEPENDS ON MENTAL STATE AT TIME OF INTERVIEW AND COMPLEXITY OF THE SITUATION
 - C. EXAGGERATION MAY CREEP INTO TESTIMONY IF WITNESS HAS REPEATED OBSERVATIONS SEVERAL TIMES (FISH GETS LONGER AND HEAVIER WITH EACH TELLING OF THE STORY)
 - D. NEVER ACCEPT QUANTITATIVE STATEMENTS AT FACE VALUE, IE "ALL THE TIME", "90% OF THE TIME", REALLY SPEEDING ALONG!", ETC.

FACTORS AFFECTING WITNESS REPORTING

3. TRANSPOSITION IS COMMON WITNESS PROBLEM
 - A. MAY HAVE EVENTS OUT OF SEQUENCE
 - B. ASK ADDITIONAL QUESTIONS TO VERIFY SEQUENCE OF EVENTS.

FACTORS AFFECTING WITNESS REPORTING

4. WITNESSES TEND TO BE MORE ASTUTE AND PERCEPTIVE IN AREAS OF OBSERVATION IN WHICH THEY HAVE BEEN PERSONALLY INVOLVED
 - A. IF ACCIDENT WAS FRIGHTENING OR TRAUMATIC, WITNESS MAY HAVE TROUBLE REMEMBERING MOST VIVID DETAILS
 - B. NATURAL TENDENCY TO PUSH UNCOMFORTABLE DETAILS INTO SUBCONSCIOUS AS PROTECTION FROM UPSETTING MEMORIES AND UNPLEASANT EXPERIENCES
 - C. WITNESSES TEND TO REPORT ON MOST VIVID EVENTS. WHEN QUESTIONED IN DETAIL, WITNESSES MAY, TO SAVE FACE, ADD EXPLANATIONS OR DETAILS TO MAKE STATEMENTS MORE PLAUSIBLE.

NOTE: BE SURE TO DIFFERENTIATE BETWEEN PERCEPTION AND WHAT WITNESS TOOK FOR GRANTED.

FACTORS AFFECTING WITNESS REPORTING

5. LIKE INTELLIGENCE, WITNESS CREDIBILITY MUST BE DISCERNED
 - A. GENERAL Demeanor
 - B. PREJUDICES, RELIGIOUS BELIEFS, POLITICAL STATEMENTS
 - C. TENDENCY TO OVER OR UNDER EXAGGERATE
 - D. CONFLICTING STATEMENT, EASILY SWAYED UNDER SPECIFIC QUESTIONING.

NOTE: INTERVIEWER SHOULD NOT ATTEMPT TO INTERPRET ANSWERS BASED ON INTERVIEWER'S BELIEFS, OPINIONS, OR PREJUDICES.

FACTORS AFFECTING WITNESS REPORTING

6. ENVIRONMENTAL

- A. PRECIPITATION
- B. FOG
- C. DUST
- D. DARKNESS
- E. GLARE
- F. PROXIMITY
- G. NOISE
- H. OBSTRUCTIONS
- I. SPEED

FACTORS AFFECTING WITNESS REPORTING

7. PHYSIOLOGICAL

- A. STRESS
- B. VERTIGO
- C. DRUGS
- D. ALCOHOL
- E. EYESIGHT
- F. HEARING
- G. PHYSICAL CONDITION

FACTORS AFFECTING WITNESS REPORTING

8. PSYCHOLOGICAL
 - A. JUDGMENT
 - B. ATTITUDE
 - C. PREJUDICE
 - D. REVENGE
 - E. RATIONALIZATION
 - F. CONCEIT
 - G. INCRIMINATION
 - H. WITNESS PERSONALITY
 - I. INTERVIEWER PERSONALITY

INTENTIONALLY LEFT BLANK

FUNDAMENTALS OF
INTERVIEWING TECHNIQUES FOR
BUS ACCIDENT INVESTIGATIONS

FIRST EDITION
August 1982

by
Robert F. Lower

U.S. DEPARTMENT OF TRANSPORTATION
TRANSPORTATION SAFETY INSTITUTE

TABLE OF CONTENTS

PURPOSE	iii
LISTENING HABITS (POOR)	1
Faking Attention	1
Yielding Easily to Distractions	1
Rejecting Difficult Listening	2
Open-Mouth Listening	2
LISTENING HABITS (GOOD)	3
Nonevaluative Listening	3
Listening Between The Lines	3
Anticipating The Witnesses Next Point	4
PERSONS REQUIRING INTERVIEW AND WHERE TO FIND THEM	5
On-Scene Interviews	5
Off-Site Interviews	6
Courtesy Cards	6
Records of Emergency Support Services	6
News Media	6
Hospitals and Medical Institutions	6
Witness Referral	7
Walk-Ins and Call-Ins	7
Technical Specialists	7
ARRANGING THE INTERVIEW	9
On-Scene Interview	9
Off-Site Interview	9,10

H 2-3

CONDUCTING AN EFFECTIVE INTERVIEW	11
Courtesy and Patience	11
Asking Good Questions	12
Note Taking	13
Using A Recording Device	14
Written Statements	15,16
UNDERSTANDING FACTORS THAT AFFECT WITNESS REPORTING	17
Intelligence	17
Emotion, Excitement, Exaggeration	17
Transposition	18
Witness Perception Ability	18
Witness Credibility	19
Environmental Factors	19
Physiological Factors	20
Psychological Factors	21
SUMMARY	

H 24

PURPOSE

THE PURPOSE OF THIS DOCUMENT IS TO ENCOURAGE THE USE OF TRIED AND PROVEN INTERVIEWING TECHNIQUES BY THOSE PERSONS RESPONSIBLE FOR INVESTIGATING TRANSIT BUS ACCIDENTS. AS A RESULT OF INTERVIEWS CONDUCTED AFTER AN ACCIDENT, THE INVESTIGATOR MUST BE ABLE TO ANALYZE WITNESS STATEMENTS IN ORDER TO TRANSLATE WITNESS OBSERVATIONS INTO CAUSAL FACTORS, EVOLVE LOGIC AND ORDER FROM APPARENT CONFUSION, CORROBORATE FACTS BY COORDINATING INTERVIEW INFORMATION AND OTHER AREAS OF THE INVESTIGATION, AND EVALUATE WITNESS CREDIBILITY. THE ACCIDENT INVESTIGATOR MUST ALSO HAVE AN UNDERSTANDING OF THOSE FACTORS THAT AFFECT WITNESS REPORTING. GATHERING WITNESS EVIDENCE COMPRISES ABOUT 50 PERCENT OF THE WITNESS INVESTIGATION. THE REMAINING 50 PERCENT HINGES ON THE ABILITY OF THE INVESTIGATOR AS AN ANALYST TO APPLY HIS OR HER TECHNICAL KNOWLEDGE TO THE SOMETIMES SEEMINGLY UNRELATED OBSERVATIONS OF WITNESSES AND EMERGE WITH POSSIBLE CONTRIBUTING FACTORS. AS WE SHALL SEE, EVEN THE MOST SINCERE OF WITNESS STATEMENTS MAY NOT BE ACCEPTABLE AS RELIABLE WITHOUT OTHER CORROBORATING EVIDENCE.

CHAPTER ONE

LISTENING HABITS

Since interviewing is a communication technique, some mention should be made of listening habits of the interviewer and some of the listening pitfalls one faces when communicating with others. Let's start with some poor listening habits and what we can do about them.

FAKING ATTENTION - There are many reasons why a listener may fake attention to someone who is speaking. It may be the speaker's vocabulary, tone of voice, dress, or peculiar mannerisms. Faking attention can be overcome by tolerance and patience on the part of the interviewer. By faking attention, the interviewer may miss a vital detail of the accident itself and the speaker may not relate it a second time. Some of the least effective speakers may be able to relate the most accurate information. If a speaker feels the listener (the interviewer in this case) is faking attention, he or she may "turn off" or lose interest in the interview.

YIELDING EASILY TO DISTRACTIONS - This problem can be a pitfall for both the witness and the interviewer. If the interview is taking place at the scene, it should be conducted at a place with the least number of distractions. These distractions may be noise (this subject will be discussed later), movement of persons, vehicles, machinery, etc. in the vicinity of the interview location. Even a squeaky chair or unbalanced table can be distracting. For those interviews taking place at the

scene of the accident, there are many distractions ranging from noise to weather. The investigator should take these into account when conducting interviews at the scene of the accident and be prepared to restate questions when necessary. On-site interviews will be discussed in greater detail later.

REJECTING DIFFICULT LISTENING - As in faking attention, there are many reasons why we may reject or "tune out" someone because they are difficult to listen to or understand. Accents and use of ethnic jargon can many times cause the interviewer to reject what the witness is saying. Speech impediments and tones of voice may also be difficult to deal with in an interview. To avoid rejecting someone's remarks because they are difficult to listen to or uninteresting, the investigator should exercise a great deal of patience and withhold rejection so that it can be determined if the witness has anything to offer. The same should be taken into account for dealing with personal appearance. Remember, we are not interested in how a witness speaks or dresses or how often he or she takes a bath. We are interested in what a witness saw, heard, or claims to know about an accident.

OPEN-MOUTH LISTENING - As an interviewer, we should know when to just listen and not talk. It is almost impossible to listen to a witness if you are talking. Let the witness talk if he or she is willing. If it is necessary to clarify a point, it may be better to wait for the witness to finish talking and then go back to the area needing qualification or clarification. Some witnesses may hold back or lose interest if they are

constantly interrupted. Sometimes, a moment of silence will cause the witness to explain himself or herself in greater detail. If you feel that you have a problem in this area, don't worry. With a little practice and experience in interviewing techniques, it will become apparent to you when to listen and when to talk. While there is no hard and fast rule in this area, your own judgment is the best guide for selecting a course of action. Later on, we will address the subject of structuring an interview.

There are, of course, some good listening habits that can help us in conducting interviews. The major points are worth discussing or considering at this time.

429
NONEVALUATIVE LISTENING - In the initial stages of the interview, it is important to listen nonevaluatively. Passing early judgment or skipping seemingly routine questions may cause the investigator to pass over a point that may later prove helpful to the investigation. Also, an investigator may pass premature judgment on the cause of the accident and guide his or her questions toward what the investigator thought happened rather than what the witness actually believes occurred.

LISTENING BETWEEN THE LINES - Listening "between the lines" is a skill that takes time to develop. Many times, an investigator's technical background can assist in determining what the witness meant to say rather than what was actually said. Witnesses do not always put the most important things into words. Also, witnesses may talk their way around certain details that make them uncomfortable or cause them unpleasant memories. When interviewing bus operators, it is especially important to be able to

read between the lines. If an operator feels that he or she was at fault in an accident, the operator may attempt to talk around those points that may show guilt. It is important for the investigator to know which questions to ask to clarify a point when the investigator feels that he or she has correctly listened and read between the lines. Many parents develop the skill of reading between the lines when rearing their children. Time is a good teacher!

ANTICIPATING WITNESSES NEXT POINT - This is another skill that develops with experience. By anticipating the witness' next point, the investigator can phrase the next question so that the interview can be kept fairly organized and in sequence, i.e., what happened before, during, and after the accident. A word of caution is necessary at this point. The interviewer should be careful in anticipating the witness' next point so that the interview does not become over-controlled. The investigator may choose to consider what the witness is trying to say or what is the point of the statement the witness is trying to make and then decide what the next question ought to be.

4-30

CHAPTER TWO

PERSONS REQUIRING INTERVIEW AND WHERE TO LOCATE THEM

ON-SCENE INTERVIEWS - In locating persons requiring interview at the scene, it is important for the investigator to respond to the scene as soon as possible. If the operator is available at the scene, he or she should be interviewed out of hearing distance of other witnesses and persons. Depending on labor contract agreements, the operator may wish to have a third party present, such as a union representative. If the operator can be interviewed at the scene, his or her first impressions will probably be more accurate than testimony given at a later time. Initial interviews of passengers still at the scene can be valuable, whether or not they have filled out and turned in courtesy cards. Any accident involving the bus usually draws a sizable number of on-lookers and curiosity seekers. On occasion, the investigator may find someone in the crowd who was a witness to the accident. If the investigator has other personnel from the property at the scene available to assist, these personnel can be of assistance in locating witnesses in the crowd. Because of other pressing duties, such as evidence gathering and preservation, sketching, measuring, etc., the investigator may not be able to interview witnesses at the scene. In these cases, as in all cases, the investigator should make efforts to obtain names, addresses, and telephone numbers for contact at a later time. When obtaining the information, it is a good idea to avoid using the word "witness." People may be frightened by the prospect of a court appearance as a witness. Rather than asking someone if they were a witness, it may be better to ask them if they have any information that could assist in determining what or who caused the accident.

OFF-SITE INTERVIEWS - There are many sources that an investigator can draw from to locate possible witnesses after the accident and away from the scene. Information obtained from legible courtesy cards will assist in identifying passengers that may require interviews. Police reports and records of emergency support agencies that responded usually contain sufficient information to locate witnesses. Interviews of police, fire, or ambulance personnel can sometimes open up a whole new area of the investigation. For example, an ambulance crew may be able to relate statements made to them by persons involved in the accident, such as remarks about faulty equipment on their vehicle, traffic signals they didn't see or understand or that malfunctioned, and other statements about drinking or being distracted while driving, etc.

Most news media coverage of a bus accident is usually after the fact. However, some media helicopter crews may observe some useful details from the air that put the accident into a different perspective on video tape. Many times, these tapes are made available to accident investigators. If a video tape is used by a reporter at the scene, it may also reflect details of the accident previously undisclosed or reveal new witnesses.

Hospitals and other medical institutions may require court orders to obtain medical information. However, they generally will release names and sometimes addresses of persons admitted or treated and released. If there has been an accident involving many persons with injuries, release of some information may be delayed for several hours simply because of the confusion created by the accident and the numbers of persons, agencies, and vehicles involved.

Many times, information obtained from one witness will lead the investigator to another. In an interview, the investigator should determine if the witness was alone at the time of the accident and whether or not the witness recognized anyone else on the bus or at the scene. Even a remark such as "I saw the lady that lives across the street at the accident" may lead to a good eyewitness that may not otherwise come forward.

It may be necessary to interview technical specialists such as doctors, pathologists, chemists, metallurgists, engineers, manufacturers, etc. In an interview, such specialists may tend to use highly detailed and technical information. It may be best to ask them to explain their information in terms that a lay person can comprehend, at least for the preliminary phase of the investigation.

CHAPTER THREE
ARRANGING THE INTERVIEW

ON-SCENE INTERVIEWS - For conducting on-scene interviews of persons not employed by the bus company, it is suggested that witnesses be interviewed separately and away from each other, if possible. At the initial stages of the interview immediately following an accident, group interviews should be avoided. Generally, a group interview results in one or two persons doing the talking and the others concurring, even if they don't agree with what the two main speakers are relating.

It is important that the witness understands who you are, who you represent, and what it is you are trying to find out. Witnesses should be approached in a positive manner and the investigator should approach them with the attitude that they will be willing to talk; "You don't want to talk to me about this accident, do you?" will almost certainly elicit a negative response. "I'd like to talk to you about what happened here" will generally put the witness in a more cooperative state. Remember, you should make the person feel that his or her information is important and may be of great value in preventing similar accidents.

OFF-SITE INTERVIEW - Whenever possible, initial contact for an off-site interview should be made by telephone. The investigator should introduce himself or herself. State the mission or objective and who the investigator represents. Contact should be made as soon as possible after the accident. This is especially true in interviewing operators. If, later on, the investigator reveals the possibility of disciplinary action against the operator, it will probably be too late for an interview or written statement. If the

operator determines that he or she may have been at fault, the longer the waiting time before the interview, the greater the chance that the operator will be uncooperative. With other witnesses, it may be necessary to tell them how long the interview may last. The positive approach should be used and the investigator should assume that the witness will be willing to talk and approach the interview in that concept. If the witness is given an easy "out" or feels that the investigator doesn't really have his or her heart in the interview at the time of the arranging, there is a good possibility that the witness will decline to talk or will not be able to agree on a mutual time and place. The location of the interview should be a place that is conducive to a good interview. A place where the witness may feel at ease or there are relatively few distractions would be satisfactory. However, if the investigator suspects that the witness may be hostile (this hostile attitude can many times be discerned over the telephone), the interview should be set up for a neutral location rather than on the witness' home ground.

436

CHAPTER FOUR
CONDUCTING AN EFFECTIVE INTERVIEW

There are many aids to effective interviewing. We will discuss some of them in this section and how an investigator can put the aids to good use. By no means are the following aids the only ones available and there is a good possibility an investigator will not use them in every interview. With experience, each investigator will be able to pick and choose those aids and techniques that best fit the circumstances in a particular interview. The interview results will be more easily analyzed if the interview is loosely structured to find out what happened before, during, and after the accident. It may also be easier for the witness to impart information if the witness can be encouraged to use a chronological approach.

COURTESY AND PATIENCE - Courtesy in conducting the interview is important. If the investigator becomes rude, brusque, or abusive, the witness will probably sense it immediately and "turn off" or hold back. To get the interview off on the right track, it helps to put the witness at ease by establishing a good rapport, i.e., "What a nice home you have," or "What adorable children you have. How old are they?" or "I really like your beautiful sofa." If the investigator discerns an area of mutual interest with the witness, it may help to discuss it briefly before actually getting into the interview.

Patience goes hand in hand with courtesy. An interviewer may have to ask the same question more than once. A witness may have difficulty remembering certain details. Many witnesses' observations may have periodic voids. If a witness is unsure of details, the investigator should list the details as such. If a witness has problems remembering details and senses that the

investigator is becoming impatient or losing interest, the witness may very well terminate the interview or become so frustrated that recall of details can no longer be possible. Patience is also important when talking with operators. Remember, the operator's livelihood may be on the line and a great deal of patience and understanding will be necessary to obtain factual information.

ASKING GOOD QUESTIONS - Asking good questions stimulates the witnesses thinking processes. The manner in which the question is asked determines to a large extent the type of answer received. The perceived intelligence of the witness will have a pronounced effect on the type of questions asked. Intelligence and its effect on witness reporting will be discussed later. Most questions should be asked in such a way that requires the witness to give more than just a "yes" or "no" answer. The investigator should ask questions that will answer the who, what, why, when and where as they relate to the accident. The investigator should keep the questions objective, rather than subjective. Witnesses may interpret a subjective question incorrectly and the investigator may be giving details that the witness was not cognizant of or had not previously perceived. For example, if the investigator asks "Did you see the broken tail lights on the bus?", the witness may not have seen them but since it has been alluded to by the investigator, the witness may assume that there were broken tail lights on the bus. Therefore, the witness will answer the question the way he or she feels the investigator wants it answered. A more objective way to find out what the witness saw would be to ask "Did you see any broken glass or lights at the scene?" In asking questions, there is another trap that an investigator can fall into. If the investigator has already formed an opinion of what happened at the accident, he or she might phrase the questions in such a way that supports the preconceived cause rather than finding

824

439
out what the witness perceived. Remember, interviews are only part of an investigation and many witnesses' observations cannot be corroborated by other evidence. Tests have repeatedly shown that even trained and experienced observers will not totally agree on what they have seen after viewing the same incident or scene. Eyewitness' observations may vary strikingly when discussing details like color, location of evidence, weather conditions, or lighting conditions. Knowing how to ask good questions will resolve some areas of controversy; but, remember, let the witness report what was seen. Don't give him or her more information or details they didn't have before the interview. Also, it is important that the interview does not become an interrogation. Many times, there is a fine line between the two and the manner in which the questions are posed is the determining factor. If the witness feels that the interview has become an interrogation, he or she may withdraw or hold back certain details or even become defensive. Remember, when anxiety goes up, the brain has a tendency to shut off. As is said in court, don't lead the witness! A good technique is to summarize what the witness has said so that the interviewer knows he or she is receiving the message as intended by the witness.

NOTE TAKING - The purpose of taking notes during the initial witness narration is to briefly list details of the witness' observations and lend structure to the interview. Note taking also assists the investigator in maintaining a chronological approach; i.e., before, during, and after. It is a good idea and common courtesy to obtain the witness' consent to take notes and explain that the purpose of the notes is to accurately record details. The investigator should try to be as unobtrusive as possible in the note taking process. Be prepared to cease note taking if the witness becomes

absorbed or distracted in the process. If the witness does become distracted, jotting down an occasional key word as a reminder of a certain detail may help. Also, some witnesses may prefer to tell the entire story without interruption and key word note taking can assist the interviewer in going back in the story with the witness to clarify or extract information. If the witness objects to note taking, the investigator should be prepared to summarize the interviewing on paper as soon as the interview has terminated.

USING A RECORDING DEVICE - Whether or not to use a recording device in conducting an interview depends on the investigator's personal preference. If a recording device is going to be used, permission should first be obtained from the witness. A statement should be made on the tape by the interviewer as to the time, date, and location of the interview, name of the witness, the accident or case number, and that the witness is aware that the recording is being made. It is suggested that each investigator check with the company's legal advisor to determine what additional information or witness notifications are needed on the tape. There is a possibility that a witness will ask for a transcription of the tape before consenting to the interview. The recording quality of the tape recorder is also important because background noise can render some tapes unintelligible. The investigator should plan the recording so as to avoid the distraction of changing tapes during a critical part of the interview. If the tape recorder operates on alternating and direct current, the AC adaptor should be available in case of battery failure. Like some note taking, recording an interview can be distracting to the witness. It is not unusual for a witness to become engrossed with the microphone or recording process and

044

not concentrate on witness observations. One advantage of a tape recording is that it can be played back to the witness in case there is a disagreement between the investigator and the witness over an answer to a question. Generally, most tape recordings are not admissible in court as evidence. A transcript of a recording signed by the interviewer and the witness and notarized may be used in court in some circumstances.

WRITTEN STATEMENTS - Whenever possible, written statements should be solicited to support witnesses' narrative comments. Even if the witness refuses to sign the written statement, it can be useful in pulling the narrative remarks together. One of the techniques used to show that a witness has seen, but will not sign the statement, is to make an obvious error in spelling or numbers and encourage the witness to at least initial the change. If it can be ascertained that the witness will probably sign the statement, encourage him or her to write the statement in long hand first (possibly to be typed later). Some witnesses may experience difficulty in the mechanics of a written statement. The investigator can assist by explaining how to start with an outline and use the chronological approach; i.e., before, during, and after. To clarify some statements, it may be necessary to have the witness draw a sketch or rough diagram and have it signed or initialed. In some instances, it may be necessary to transport the witness to the scene of the accident to clarify specific points of conflict or uncertainty. It is important not to relate technical terms to the witness. Allow the witness to use his or her own words in the statement. For example, if the witness calls the fare box a "cash box," allow the statement to reflect "cash box." Some witnesses may tend to omit information they feel to be insignificant. If the interviewer suspects that the witness may have omitted something the witness felt was insignificant, the

investigator should attempt through additional questions to identify whether or not something is indeed insignificant. Something that seems insignificant initially may very well turn out to be the "missing link" later. An attestation should be at the bottom or end of the statement to verify its veracity and content. It is suggested that the witness be given a copy (not the original) of the statement for his or her records. Also, the opportunity should be available for the witness to contact the investigator if additional details or information become available or are recalled.

442

CHAPTER FIVE

UNDERSTANDING FACTORS THAT AFFECT WITNESS REPORTING

Since interviewing is really a communications technique, we need to consider some of the factors that affect a witness' response or reporting capability.

INTELLIGENCE - Intelligence does play a role in witness reporting. Less intelligent witnesses may have problems in recall of details due to lack of interest. Less intelligent witnesses may be unable to organize their thoughts and present their observations in a coherent manner. However, no witness should be overlooked because of an apparent lack of intelligence. The investigator should exercise patience and courtesy during the interview of less intelligent witnesses and be prepared to change his or her vocabulary to fit the situation. Small children should not be overlooked because of their age. Some small children are amazingly astute about some details. When interviewing children, it is recommended that a parent or guardian be present or close by.

EMOTION, EXCITEMENT AND EXAGGERATION - An investigator should be keenly aware of and prepared for any decided distortion or exaggeration caused by excitement or the emotional state of the witness. While distortion or exaggeration tend to be more prominent in verbal statements, they can also appear in written statements. How accurate a statement is depends on the mental state of the witness at the time of the interview and the complexity of the situation. Exaggeration is likely to creep into testimony if the witness has repeated the observations several times. For example, each time some fishermen tell a story, the fish gets longer and heavier!

The interviewer should be careful not to accept quantitative statements at face value. These types of statements are highly prone to exaggeration. For example, if a witness states that the bus exceeds the speed limit on a certain street "all the time," the investigator should try to get the remark clarified and determine how the witness made the judgment. Tests have shown that, generally, there is no significant variation in comparing the accuracy of adult female and adult male witnesses. However, some experienced investigators have found that females tend to be more astute and give accurate details in describing wearing apparel or physical characteristics, particularly when they pertain to other females.

TRANSPPOSITION - Transposition of facts and events is a common witness problem. A witness may very well have events out of sequence. The investigator should pay close attention to a witness' chronological approach and be prepared to ask additional questions to verify sequence of events and accuracy of details. If a witness insists there is no transposition on his or her part, then the investigator should record the events as such.

WITNESS PERCEPTION ABILITY - Witnesses tend to be more astute and perceptive in areas of observation in which they have been personally involved. However, if the accident was particularly frightening or traumatic, the witness may experience difficulty in remembering the most vivid details. In many cases, there is a tendency on the part of the witness to push details into the subconscious as protection from upsetting or unpleasant memories or experiences. It is not unusual for someone involved in a serious or dramatic accident to remember no details for those several days preceding and following the accident. If a witness is able to report on the most vivid details, the interviewer should be alert to differentiate between

what the witness truly perceived or merely took for granted. Some witnesses may, when questioned in detail, add details that are not true or add statements to make the story sound more plausible.

WITNESS CREDIBILITY - Like intelligence, witness credibility must be discerned. A witness' credibility can many times be assessed by the person's: general demeanor; tendency to over or under exaggerate; prejudicial, religious or political statements; or conflicting statements and being easily swayed under specific questioning. Also, it is important that the interviewer not allow his or her own prejudices to interpret the witness' responses.

ENVIRONMENTAL FACTORS - Witness reporting can be affected by many different environmental factors, both during the interview and at the time of the accident. Precipitation, fog, dust, or darkness may have restricted or limited the detail that the witness claims he or she saw. Glare has been identified as a causal factor in many transportation accidents. It should be determined whether or not there was glare at the time of the accident, either caused by lights, the sun, wet pavement, or snow. Proximity and obstructions at the scene may have made it impossible for the witness to see what he or she claims to have seen. Speed of the vehicles involved in the accident may have severely restricted what a witness could have seen. Another environmental factor to consider is noise. An entire chapter could be devoted solely to the problems associated with noise. Noise can affect witness reporting and perception at the scene or at a later interview. Excessively loud noise has been known to cause a rise in blood pressure and a quickening of heartbeats as well as spatial disorientation. Certain noises, while not being harmful, can be distracting and cause a witness to miss certain details of the accident or make it difficult to communicate

with the interviewer. Also some witnesses may hear the sound of a collision behind them and immediately turn around to look. Many witnesses have experienced this situation and felt that they actually saw the impact when, in reality, it was the noise of the impact that caused them to turn around or divert their attention. It is important that the interviewer understand and recognize this phenomena and direct specific questions to the witness that will determine what the witness really could have or have not seen.

PHYSIOLOGICAL FACTORS - An investigator/interviewer should be aware of the possible physiological factors that can affect a witness' reporting ability. Many of these factors apply to the operator as well as other witnesses. Coping with stress has become an important consideration in many bus operator training programs. An operator who can cope with stress, or at least recognize a stressful condition, is less likely to have a human error mishap or dispute with a passenger than an operator who cannot cope with or recognize stress. It may be appropriate for the interviewer to determine what sort of stress the operator or other witnesses may have been under prior to the accident. Under some circumstances, it may be necessary to find out if the witness has recently experienced any changes, good or bad, in his or her daily life style. Much has been said and written about the effects of drugs and alcohol on the human mind. An interviewer should be alert to the signs of drug and alcohol use/abuse and, if the signs are evident, be prepared to evaluate witness credibility accordingly. Of course, the accident investigator must always be prepared to determine if drugs or alcohol are a causal factor in an accident. This causal factor can many times be identified through interviews at the scene.

A witness' physical condition plays a significant role in reporting ability. However, poor eyesight or hearing disabilities should not necessarily rule a person out as a witness. Many persons with poor eyesight have a very keen sense of hearing and many people with a hearing disability may, through sheer sense of survival, be more alert and observant than persons with unimpaired hearing. The interviewer should be aware that a witness with impaired hearing may be difficult to interview. Also, many persons with poor vision or limited vision have complained that people have a tendency to shout at them rather than talk in a normal tone of voice. Remember, just because a witness may have poor vision, it does not necessarily mean that he or she is also hearing impaired!

447
PSYCHOLOGICAL FACTORS - Most psychological factors that affect witness reporting have been previously discussed under WITNESS PERCEPTION and WITNESS CREDIBILITY. The interviewer may not be able to eliminate any of the psychological factors but he or she should have an understanding of the factors and take them into consideration when conducting interviews. Again, some of these factors are attitude (of both witness and the interviewer), prejudices (of both), revenge, rationalization, conceit, incrimination, and personality (of both).

S U M M A R Y

USING THE TECHNIQUES AND RECOMMENDATIONS SET FORTH IN THIS DOCUMENT WILL NOT MAKE YOU AN EXPERT IN INTERVIEW TECHNIQUES. HOWEVER, THIS DOCUMENT WAS DESIGNED TO ENCOURAGE THE USE OF TRIED AND PROVEN PROCEDURES AND TECHNIQUES IN INTERVIEWING WITNESSES AND OTHER PERSONS ENCOUNTERED AS THE RESULT OF A TRANSIT BUS ACCIDENT. YOU WILL NOT USE ALL OF THE TECHNIQUES IN EVERY INTERVIEW AND SOME OF THE TECHNIQUES AND PRACTICES TAKE YEARS TO DEVELOP. THE IMPORTANT POINT IS TO UNDERSTAND THAT SOME OF THE TECHNIQUES DESCRIBED IN THIS DOCUMENT WILL, WHEN PROPERLY USED, MAKE YOU A BETTER INTERVIEWER AS TIME GOES BY. LIKE ANY OTHER SKILL, INTERVIEWING PERSONS HAS TO BE DONE ON A REGULAR BASIS TO KEEP THE INVESTIGATOR "UP TO SPEED." WHILE IT IS MENTIONED THAT CAUTION MUST BE USED IN ACCEPTING EVEN THE MOST SINCERE OF WITNESS OBSERVATIONS AS THE TRUTH, A GOOD INTERVIEW CAN ASSIST THE INVESTIGATOR IN DETERMINING IF THE OTHER TYPES OF EVIDENCE SUPPORT THE INTERVIEW RESULTS OR VICE VERSA. SOMETIMES, A GOOD INTERVIEW MAY TURN UP CLUES OR SUGGEST ADDITIONAL AREAS TO BE INVESTIGATED. FINALLY, REMEMBER THAT INTERVIEWING IS A COMMUNICATIONS SKILL AND PATIENCE AND COURTESY IN CONDUCTING INTERVIEWS CAN LEAD TO FRUITFUL AND USEFUL INFORMATION TO ASSIST THE INVESTIGATOR.

1 6/4 H



1





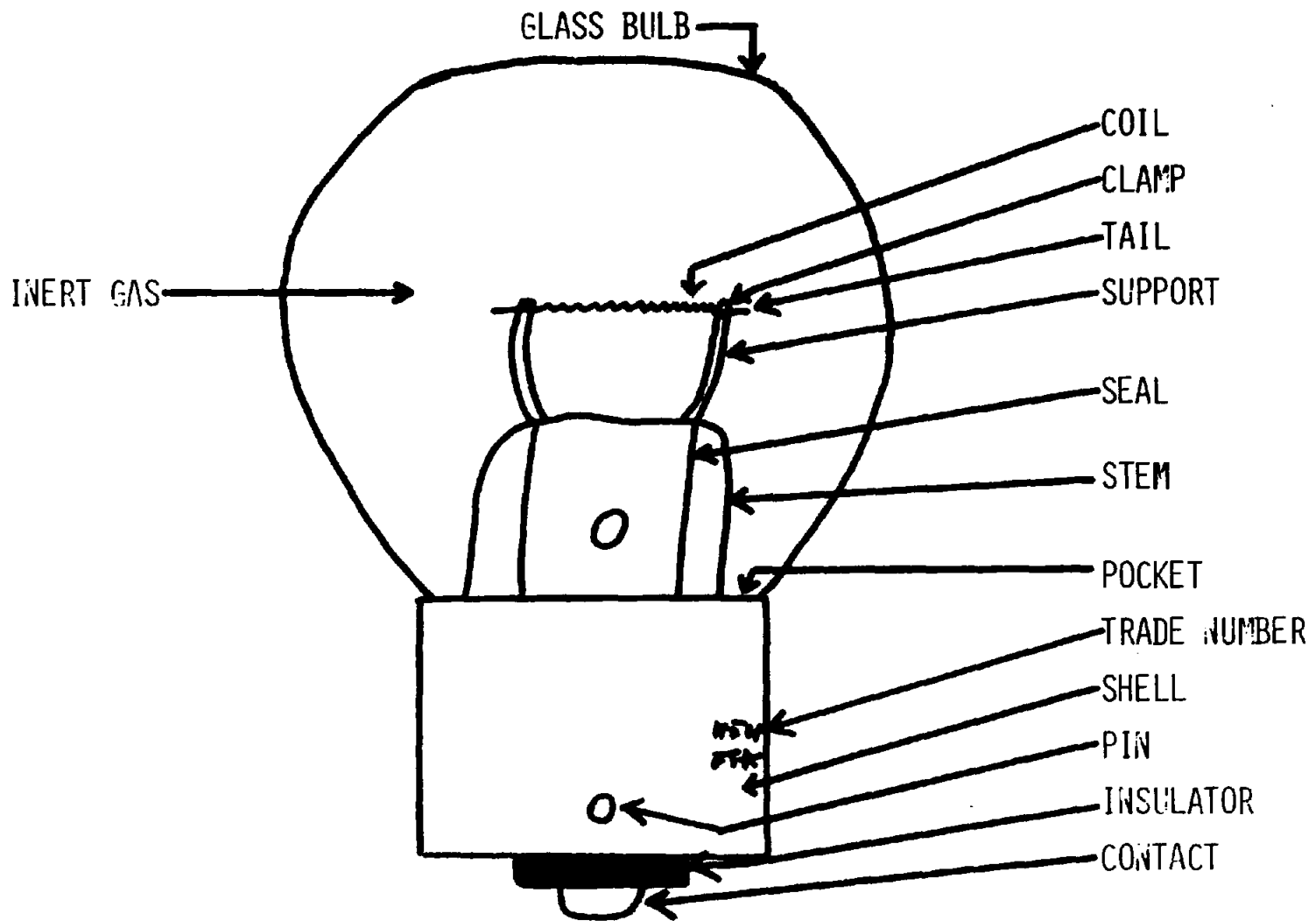

LAMP INSPECTION-OVERVIEW

**OBJECTIVE: TO IDENTIFY THOSE PROCEDURES NECESSARY
TO CONDUCT A LAMP INSPECTION DURING AN
ACCIDENT INVESTIGATION**









MEDIA RELATIONS

**OBJECTIVE: TO DISCUSS SOME OF THE RECOMMENDED
PROCEDURES FOR DEALING WITH THE NEWS
MEDIA IN AN EMERGENCY.**

1. BE PREPARED.
2. PROJECT A PROFESSIONAL IMAGE.
3. KEEP CONTROL OF THE SITUATION.
4. BACKGROUND IS IMPORTANT.
5. DON'T BE PATRONIZING.

INTENTIONALLY LEFT BLANK

121

•

•

6. STAY AWAY FROM HEARSAY INFORMATION.
7. DON'T SPECULATE ON WHAT HAPPENED.
8. DON'T ACCEPT OR ACKNOWLEDGE
RESPONSIBILITY FOR THE ACCIDENT.
9. EXPLAIN WHY YOU CANNOT COMMENT.
10. DON'T GO "OFF THE RECORD".

1

2

HE 5614 B347

19903

Mass Transit Safety and
Security Program

MTA LIBRARY