



U.S. Department
of Transportation
Federal Highway
Administration

High-Strength Bolts for Bridges

Office of Technology
Applications

Engineering Applications
Division

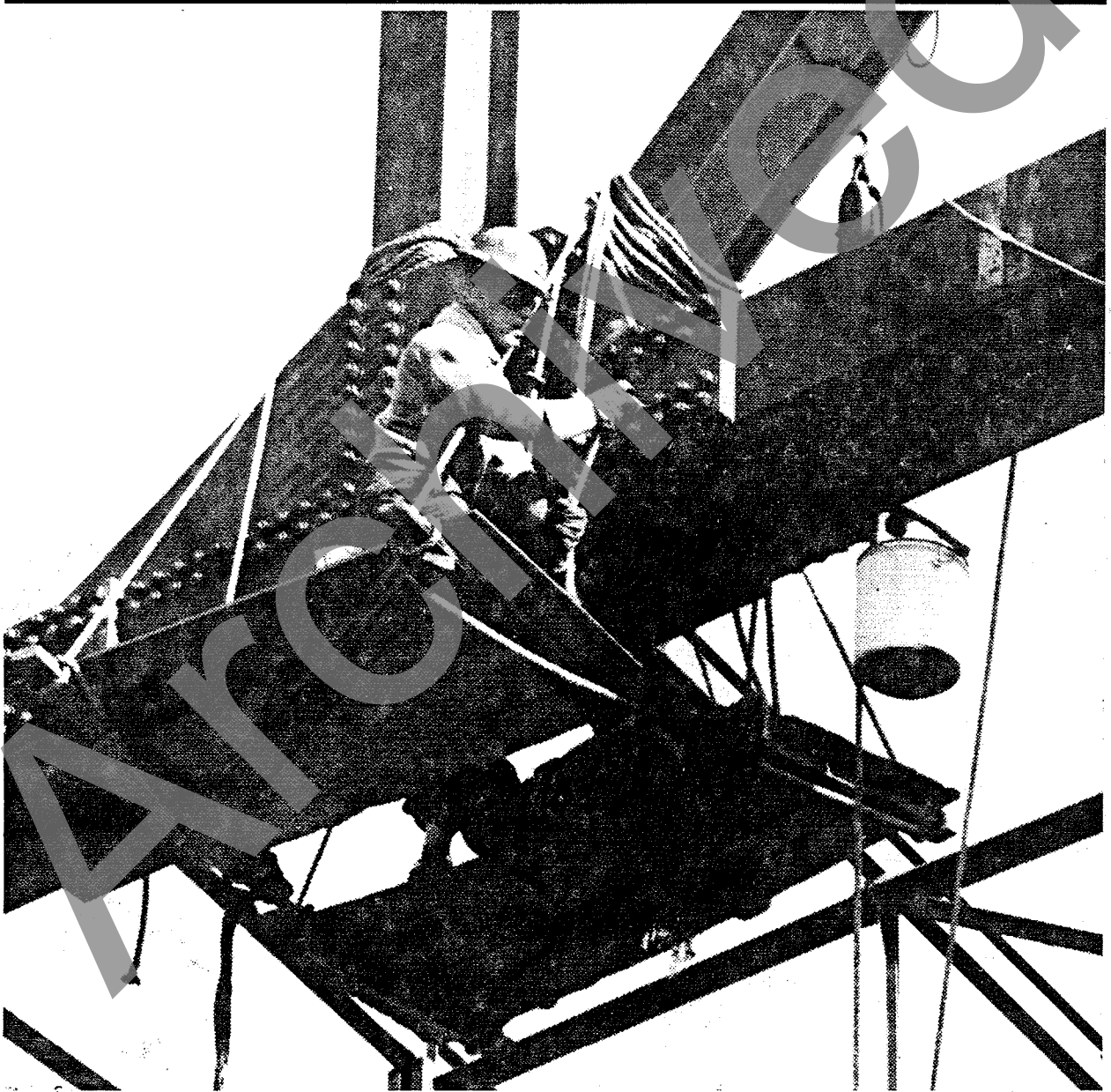

Demonstration Project No. 88

Report No. FHWA-SA-91-031

May 1991

Archived

Addendum

High Strength Bolts for Bridges

Report No. FHWA-SA-91-031

(date of Addendum: April 14, 1994)

This publication was prepared in accordance with the standards and specifications in effect in early 1991. These items include ASTM, ANSI and AASHTO specifications. Since that time, there have been several changes to these documents. This addendum incorporates a brief summary of the changes made to date when it affects slides or text.

ASTM fastener specifications are frequently updated, sometimes several times in one year. One is encouraged to secure updated copies of all applicable ASTM specifications.

ANSI B18.2.1-1981 and ANSI B18.2.2-1987 are current as of this Addendum.

AASHTO Standard Specifications for Highway Bridges are updated annually, with supplements being published each Spring. At the time of preparation of the Demonstration Project 88 slides and the text, AASHTO Division II placed the material on Steel Structures in Section 10. This section has subsequently been renumbered to Section 11. It should also be noted that a substantial percentage of the provisions of the FHWA Memorandum, November, 1989, have been or will soon be incorporated into the AASHTO Specifications.

Two versions of the Research Council on Structural Connections Specification for Structural Joints Using ASTM A325 or A490 Bolts currently exist. The 1985 version is for use in Allowable Stress Design, the 1988 for Load and Resistance Factor Design. Some installation and inspection procedures were revised with the publication of the 1988 version, and a thorough comparison should be made of the two specifications.

The following changes should be made to the slides and accompanying text:

- 2- 1 Fourth sentence: Change "The existing specifications do not" to "The previous specifications did not". New AASHTO provisions now call for rotational-capacity testing of both A325 and A490 bolts.
- 2-10 Check current ASTM specifications for overlapping provisions.

2-13

Matching Nuts

A325/M164

A563/M291

A194/M292

Type 1 & 2

C, C3, D, DH, DH3

2, 2H

Type 1 Galv.

DH

2H

3- 8

A325 Type 2 bolts were withdrawn from use in November, 1991.

3-10

A325 maximum hardness has been revised to 34 HRC, down from 35 HRC.

3-22

3-23

3-24

3-26

Alexander's model:

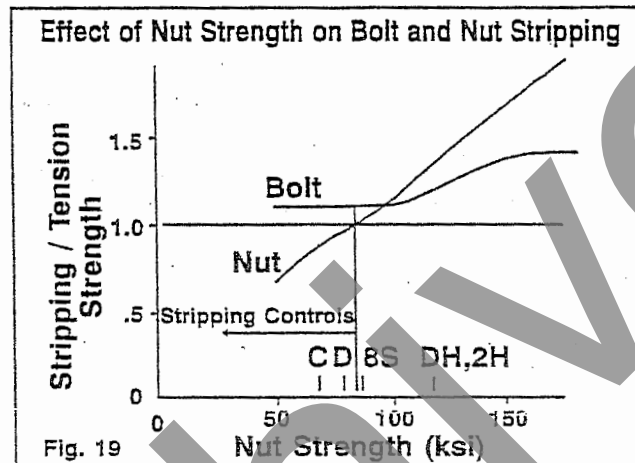

Fig. 19

3-30

Overtapping provisions have been substantially revised in A563. See current specifications. A563 provisions still do not meet FHWA requirements.

3-52

The top solid line is for "As Received and Lubricated Cases". The bottom solid line is for "Clean". The equation for the center dashed line is $T = 16.7 P D$.

3-53

AASHTO reference in Division II is now Article 11.5.6.

4-47

IFI-122 is provided as a separate handout, not included in the bound text.

4-58

A325 Type 2 bolts were withdrawn from use in November, 1991.

6-15

Change slide: "P = measured bolt tension (lbs.)". Also, delete the last sentence of the text.

- 6-20 Change slide: "P = "turn test tension" from Table D4.1g.
- 7- 2 AASHTO Bridge code is now 15th edition, with Interim
7- 4 Specifications issued annually.
- 7- 8 Change slide: "whichever is less" to "whichever is greater".
- 7-13 Delete from text: "slip-critical".
- 7-14 Change text: "Table 10.17A" to "Table 11.5A".
- 7-15 Change slide and text: "Table 10.17A" to "Table 11.5A".
- 7-18 Change slide: " f_y " TO " F_y ".
- 8- 1 "Alternate Design Bolts" and "Lock-Pin and Collar Fasteners" are also recognized by AASHTO.
- 8- 3 Change text: "Table 10.17A" to "Table 11.5A".
- 8- 6 Change slide and text: "Table 10.17B" to "Table 11.5B".
- 9- 5 For bridge applications, the typical gap is 0.005 inches.
- 10- 2 Change text: "Table 10.17A" to "Table 11.5A".
- 10- 8 Change slide and text: "Table 10.17B" to "Table 11.5B".
- 11- 1 Change text: "Table 10.17A" to "Table 11.5A", and change "Article 10.3.1.8.9" to "Article 11.3.2.6".
- 11- 2 Change slide and text: "10.3.1.8.9" to "11.3.2.6".
- 11- 3 Change text and slide: "Table 10.17A" to "Table 11.5A".
- 12- 6 Change text: "Article 10.3.1.8.9" to "Article 11.3.2.6".
- 12- 8 These provisions are drawn from the RCSC Bolt Specification. AASHTO provides for sampling 3 bolts, not five. Change text: "Table 10.17A" to "Table 11.5A". Change text: "Table 10.17B" to "Table 11.5B".
- 12-10 These provisions are drawn from the RCSC Bolt Specification. AASHTO provides for sampling 3 bolts and using the average of the three bolts.
- 12-11 The RCSC provisions cited in the text call for inspection wrench inspection only for "connections in question". AASHTO provisions require inspection wrench inspection of all high-strength bolted connections except those using alternate design fasteners or direct tension indicators.

The following changes and corrections should be made to the appendices that follow the slides and commentary in the publication:

Appendix A2, A3, A4 and A5

Change all references: "Table 10.17A" to "Table 11.5A"

Change all references: "Table 10.17B" to "Table 11.5B"

Appendix A1

In Procedure Section 3, change "snug tension" to "initial tension".

Appendix A2

Add the following sentence to Section 2.3: "Install sufficient spacers and/or washers so that at least three (3) but no more than five (5) full threads are exposed between the nut face and the underside of the bolt head."

Correct the values at the top of the second page for Table 10.17A.

Bolt Diam. (inches)	1/2	5/8	3/4	7/8	1	1-1/8	1-1/4	1-3/8	1-1/2
M164 (A325)	12	19	28	39	51	56	71	85	103
M253 (A490)	15	24	35	49	64	80	102	121	148

Appendix A6

Replaced in its entirety. See attachment.

Table Of Contents

	Figures
Session 1	
Introduction, Objectives and Problems Encountered	
Introduction	1-1 through 1-5
Objectives	1-6 through 1-8
Reported Problems for Fastener Assemblies	1-9 through 1-40
Session 2	
Theory and Behavior of Structural Bolts and Connections	
Bolt Theory and Behavior	2-1 through 2-34
Lubricants	2-35 through 2-41
Session 3	
FHWA Requirements for High-Strength Bolts:	
FHWA Supplemental Specifications	3-1 through 3-67
Session 4	
Manufacturing Processes	
Cold-Formed Fasteners	4-1 through 4-28
Hot Forged Fasteners	4-29 through 4-34
Quality Control	4-35 through 4-55
Product Marking	4-56 through 4-57
Fastener Types	4-58 through 4-59
Coated Fasteners	4-60 through 4-80
Session 5	
Receipt Inspection, Storage, Pretest, Review of MTD	
Receipt Inspection	5-1 through 5-7
Storage	5-8 through 5-9
Pretesting	5-10 through 5-11
Review of Test Data and Reports	5-12 through 5-26
Session 6	
Job-site Rotational-Capacity Testing	6-1 through 6-21
Session 7	
Installation — General	7-1 through 7-21
Session 8	
Turn-of-Nut Tightening	8-1 through 8-6

Session 9

Direct Tension Indicators

9-1 through 9-8

Session 10

Calibrated Wrench Tightening

10-1 through 10-9

Session 11

Alternate Design and Lock Pin and Collar Fasteners

 Alternate Design Fasteners

11-1 through 11-5

 Lock Pin and Collar Fasteners

11-6 through 11-9

Session 12

Re-Use and Inspection

 Re-use of Fasteners

12-1 through 12-4

 Inspection of Fastener Installation

12-5 through 12-15

Appendices

Appendix A

Installation Procedure Guides

Appendix B

Definitions and Fastener Behavior

Appendix C

FHWA Supplemental Specification

Appendix D

ASTM Specifications A194, A325, A490, A563, F436, F606, F959
ANSI Specifications B18.2.1, B18.2.2

Appendix E

AASHTO Standard Specifications for Highway Bridges -
Division II, Section 11

Appendix F

Specification for Structural Joints Using ASTM A325 or A490
Bolts (RCSC)

Session 1

Introduction, Objectives and Problems Encountered

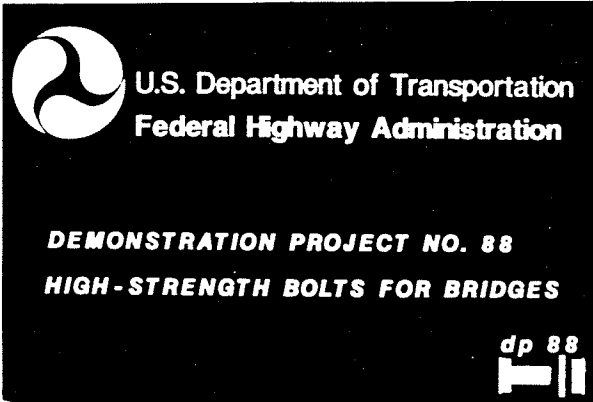

1 - 1

INTRODUCTION

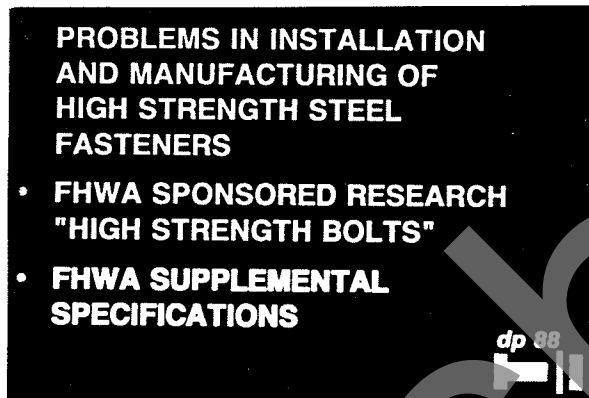

1 - 2

In the mid 1980's a number of problems developed during the installation of high-strength bolts in bridge structures. Because improperly manufactured and installed and poorly inspected fasteners can precipitate structural failures, FHWA sponsored a research project at the University of Texas to determine various problems concerning manufacturing and installation of high-strength bolts for bridges, and to make recommendations toward resolving them. Upon completion of this work, FHWA issued the "Supplemental Contract Specifications for projects with AASHTO M164 (A325) H. S. Bolts" in 1989 in order to provide uniform manufacturing and installation requirements. This specification was developed as a supplement to the AASHTO Materials Specifications.

FASTENERS

Discussion of fasteners will be limited to high-strength bolts, nuts and washers for bridges.



1-3



1-4

OTHER ALTERNATE FASTENERS

- A) TENSION CONTROL
BOLTS**
- B) HUCKBOLTS**



1-5

OBJECTIVES

**Disseminate Information And
Conduct Demonstrations To Assure
That Fasteners Will Be Specified,
Purchased, Manufactured, and
Installed In Accordance With
Appropriate Specifications**

1 - 6

OBJECTIVES

The objectives of this project are to disseminate relevant information and demonstrate various techniques and methods to assure that all bolts will be specified, purchased, manufactured and installed in accordance with the appropriate specification requirements. Special emphasis will be given toward explaining the rationale behind the new specifications and demonstrating appropriate tests and methods so they will be better understood.

APPLICABLE SPECIFICATIONS

**PRODUCTION SPECIFICATIONS
INSTALLATION SPECIFICATIONS**



1 - 7

APPLICABLE SPECIFICATIONS

**AASHTO MATERIALS
SPECIFICATIONS
ASTM SPECIFICATIONS
ANSI SPECIFICATIONS
AASHTO STANDARD
SPECIFICATIONS FOR
BRIDGES**



1 - 8

REPORTED PROBLEMS FOR
FASTENER ASSEMBLIES

**REPORTED PROBLEMS
FOR
FASTENER ASSEMBLIES**



1-9

**IMPROPER MARKINGS
BOLT HEAD
NUT HEAD**



1-10

**IMPROPER
CERTIFICATION**



1-11

REPORTED PROBLEMS FOR
FASTENER ASSEMBLIES (Cont'd.)

**PROBLEMS IN
SHIPPING
FASTENER COMPONENTS**



1 - 12

**INADEQUATE STORAGE
OF
ON-SITE FASTENERS**



1 - 13

**INADEQUATE
QA PROGRAM**



1 - 14

PROBLEMS

FASTENER FAILURE

- (I) STRIPPING
- (II) BOLT BREAKING BEFORE PRELOAD
- (III) BOLT BREAKING BEFORE REQUIRED TURNS



1 - 15

REPORTED PROBLEMS FOR FASTENER ASSEMBLIES (Cont'd.)

PROBLEMS

FASTENER FAILURE (CONT.)

- (IV) OVERTIGHTENING OF SHORT LENGTH BOLTS
- (V) NON-HARDENED NUTS



1 - 16

PROBLEMS

FASTENER FAILURE (CONT.)

- (VI) IMPROPER NUTS
- (VII) HARDNESS OUT OF SPECIFICATIONS
- (VIII) HYDROGEN EMBRITTLEMENT AFTER INSTALLATION



1 - 17

PROBLEMS

FASTENER FAILURE (CONT.)

- (IX) GALVANIZED A490
(M253) BOLTS
- (X) LONGITUDINAL CRACKS
- (XI) BURSTS IN BOLTS



1 - 18

REPORTED PROBLEMS FOR
FASTENER ASSEMBLIES (Cont'd.)

PROBLEMS

FASTENER FAILURE (CONT.)

- (XII) IMPROPER ZINC THICKNESS
- (XIII) MISINTERPRETATION OF NUT
OVERTAP REQUIREMENTS
- (IVX) NO LUBRICANT ON NUT
- (XV) BREAKING OF BOLT AT
HEAD SHANK
INTERFACE



1 - 19

PROBLEMS

FASTENER FAILURE (CONT.)

- (XVI) FAILURE TO SATISFY
ROTATIONAL-CAPACITY
TEST



1 - 20

OTHER PROBLEMS

- (XVII) BOLTS IN RUSTED OR DIRTY CONDITION
- (XVIII) IMPROPER SNUGGING
- (IXX) IMPROPER TIGHTENING OF THE BOLT
- (XX) NO CALIBRATION OF TORQUE WRENCHES



1 - 21

OTHER PROBLEMS

(CONT.)

- (XXI) POORLY WRITTEN SPECIFICATION PROVISIONS
- (XXII) INADEQUATE KNOWLEDGE OF APPLICABLE SPECIFICATIONS



1 - 22

SIGNIFICANT PROBLEMS

GALVANIZED FASTENERS

BLACK BOLTS

1 - 23

REPORTED PROBLEMS FOR FASTENER ASSEMBLIES (Cont'd.)

These issues and problems were significant enough to require research, implementation of recommendations, and development of FHWA Supplemental Specifications for High Strength Bolts and this demonstration project DP-88.

**FHWA Research - High-Strength Bolts for Bridges
Supplemental Specs
DP-88**

1 - 24

The FHWA sponsored research was in response to field problems with the installation of galvanized bolts in bridges. Both A325 and A490 bolts were included in the study to provide a comparison of the behavior of coated (galvanized) bolts with black bolts. This was done based on previous laboratory and field experience with installation problems of black bolts.

GALVANIZED FASTENERS

- Lubrication
- Thread Tolerance
- Nut Strength and Hardness
- R-C Test

1 - 25

When bridge owners began using galvanized fasteners to help solve painting problems, and with the advent and use of mechanically galvanized fasteners to provide uniform, smooth surfaces, several problems surfaced primarily during installation of these bolts.

Lubrication has always been required for galvanized nuts. When a nut is tightened, resistance is encountered and a portion of the expended energy is used to overcome the friction at the bolt/nut thread interface and the friction between the nut, washer, and gripped material. For example, in one set of tests, the difference in torque required for a lubricated assembly and an as-received bolt to reach 39 kips was dramatic. The as-received assembly required over 1400 ft-lbs while the lubricated assembly required less than 400 ft-lbs. It is just as important to lubricate the nut face as it is to lubricate the threads. This is accomplished by lubricating the entire nut. Lubrication has a significant effect on the bolt calibration curves. This will be discussed in detail later.

GALVANIZED FASTENERS

Lubrication

1 - 26

- ▶ **Nuts Not Lubricated**
- ▶ **Lubricant Washed Away**
- ▶ **Lubricant Not Effective**
- ▶ **Lubricant Not Visible**

1 - 27

Problems related to lubrication include:

- a - Lubricant may not have been applied
- b - Lubricant is washed away
- c - Lubricant may not have been effective
- d - Lubricant may not be visible.

The end result is that unless a fastener is effectively lubricated, the nut will gall and seize on the bolt and it will be impossible to install the fastener properly.

GALVANIZED FASTENERS

Thread Tolerance

1 - 28

Stripping in a fastener assembly is primarily a function of the shear area of the threads and the strength of the bolt and nut. The increase in the thread size of the bolt due to galvanizing does not increase its stripping strength. The only effect of soft zinc on the threads is the increase in friction on the threads by its tendency to gall.

Nuts are tapped oversize to account for the thickness of the zinc coating. Excessive overtapping causes lesser thread engagement, leading to thread stripping of the nut or bolt. Previous ASTM Specifications and AASHTO Materials Specifications were incorrect, which caused the problem.

GALVANIZED FASTENERS

Rotational-Capacity Test ASTM Requirement

1 - 29

The ASTM specifications, for a number of years, required a rotational-capacity test. The test was not well understood and was not always performed. Had the test been performed, both the lubrication issue and the oversize tapping issue would have been somewhat resolved.

GALVANIZED FASTENERS

Nut Strength and Hardness

1 - 30

The strength of the nut directly affects its stripping resistance. Both hardened and nonhardened nuts were allowed in previous specifications. Nonhardened nuts do not normally have the same strength as heat treated hardened nuts, and have resulted in stripping failures. Higher-strength heat treated nuts are required for A490 bolts. Galvanized A325 fasteners also require heat treated nuts to compensate for the loss of thread shear area from overtapping.

GALVANIZED FASTENERS

Bolt Strength and Hardness

1 - 31

Current ASTM and AASHTO Materials Specifications allow A325 (M164) bolt hardness up-to 35 Rc. Bolts with hardness values greater than 33 Rc have potential for delayed cracking in service or brittle failure under applied tension loading.

GALVANIZED FASTENERS

Mechanical vs. Hot Dipped

1 - 32

Uniformity of coating for mechanically galvanized fasteners allows a somewhat smaller overtap, with subsequent reduction of stripping problems.

BLACK BOLTS

THREAD FIT

1 - 33

Nuts manufactured oversize for galvanized assemblies have, at times, been improperly used on black bolts. The oversize caused stripping failures due to a poor thread fit.

BLACK BOLTS

Nonhardened Nuts (Soft Nuts)

1 - 34

Both ASTM and AASHTO Materials Specifications currently allow nonhardened nuts for black assemblies. Under the permissible range of hardness, according to these specifications, nonhardened nuts can be manufactured from hardness values as low as 78 HRB to RC38. Nonhardened (softer) nuts with hardness values less than 89 HRB have a potential for stripping failure. This type of failure has been observed. Recent research work at the University of Texas suggests the same.

INSTALLATION PRACTICES

SNUG TIGHT

1 - 35

The snug tight concept has not been well understood and/or not properly applied. Improper usage has resulted in inadequate bolt tension. This problem is complicated by issues concerning material thickness, number of plies, installation procedure, and not knowing when a joint is compacted.

INSPECTION PRACTICES

STORAGE

1 - 36

Fasteners with dry, dirty, and rusty thread surface conditions do not install properly and result in inadequate bolt tension. Such thread conditions cause torque measurements to vary significantly. Recognizing this problem, AASHTO had temporarily eliminated the calibrated wrench method from AASHTO Standard Specifications for installation of high-strength fasteners. Though currently permitted by the specifications, this method is not often used.



1 - 37

SHIPPING ISSUES

Production Lot VS. Shipping Lot and Production Lot Identification

1 - 38

The shipping lot method allows for intermingling different lots of nuts and bolts. For example, bolts of the same length and diameter for a specific purchase order are considered to be the same shipping lot even though they may be from different production lots or different manufacturers. Herein lies the problem: lack of uniformity of product can lead to possible non-uniform behavior of the fasteners and fastener assemblies.

INSPECTION ISSUES

Multiplicity of Installation Situations

1 - 39

Current AASHTO Standard Specifications for Highway Bridges allows installation of high-strength fasteners by several different methods; turn-of-nut, calibrated wrench, direct tension indicators, or alternate design fasteners. Upon completion of installation, the AASHTO specifications require inspection using a procedure which is a variation of the calibrated wrench installation method. By its nature, this inspection procedure is subject to the many inaccuracies and variabilities of the calibrated wrench installation method, and must be fully understood by the inspector, else fasteners may be erroneously judged acceptable. This inspection procedure will be discussed in depth later.

DUCTILITY AND PERFORMANCE

- ✓ **Type of Material**
- ✓ **Fastener Size**
- ✓ **Number of Threads in Grip**

1 - 40

Inadequate ductility can either prevent the fastener assemblies from achieving required tension in the bolt during installation or reduce their capability to absorb energy when load is applied. Various factors are known to influence ductility of an assembly. These include:

- (a) Type of Material (A325 vs. A490)*
- (b) Fastener size (length, diameter etc.)
- (c) Number of threads in the grip

*Comparable size of ASTM A490 (AASHTO M253) bolt assemblies have been observed to be less ductile than ASTM A325 (AASHTO M164) bolt assemblies.

Session 2

Theory and Behavior of Structural Bolts and Connections

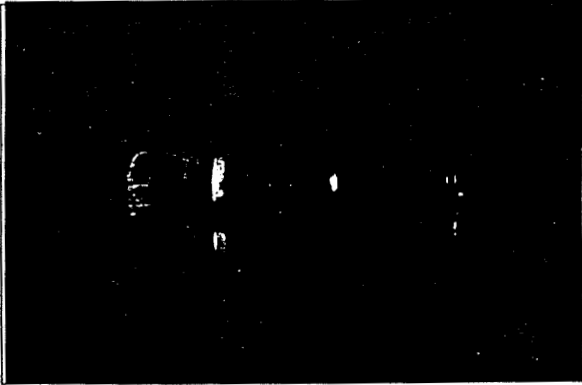

2 - 1

BOLT THEORY AND BEHAVIOR

The fastener assembly is governed by three different AASHTO or ASTM product specifications. Additional specifications spell out the geometry of each component as well as the thread dimensions. The behavior of the fastener is dependent upon a combination of strength and geometry variables. The existing specifications do not require the testing of the assembly to insure it will perform satisfactorily. This presentation discusses the significant variables associated with the behavior of the fastener assembly.

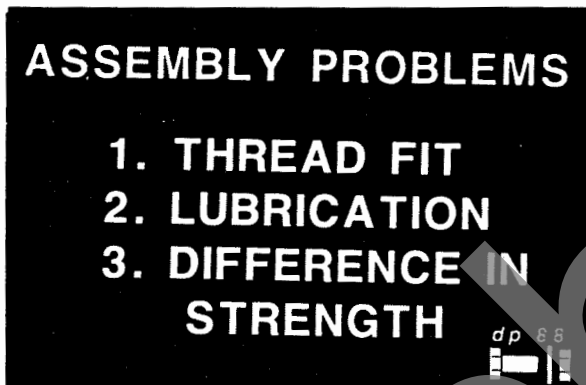

2 - 2

The interaction of these variables dominates the tightening performance of the structural fastener. Each of these will be discussed.

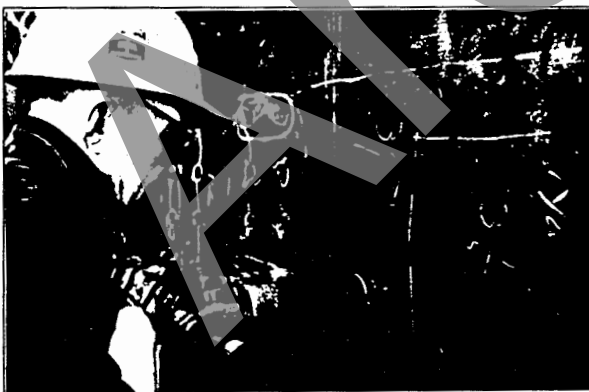

2 - 3

The goal of this course and the modifications to the AASHTO or ASTM specifications presented are to insure that upon installation, the fastener assembly will perform in a consistent manner. The fastener can be installed easily and reliably. The required installation tension can be attained using normal procedures.

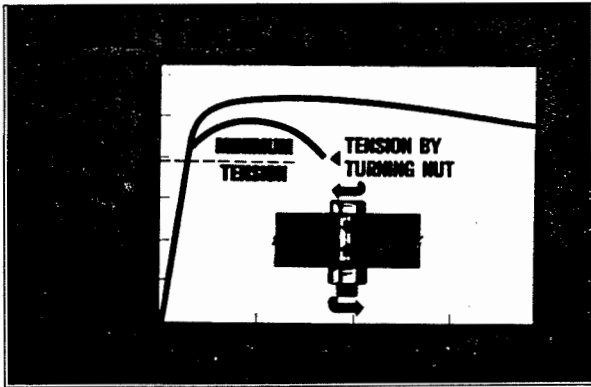

2-4

Tensioning a bolt by turning the nut introduces torsion as well as tension into the bolt. The torsion comes from the friction between the threads of the nut and bolt. The resulting combined state of stress produces a reduction in ductility and tensile strength of the bolt. Larger torsion caused by lack of lubrication of the threads can cause a drastic reduction in the tension that can be attained by tightening the nut.

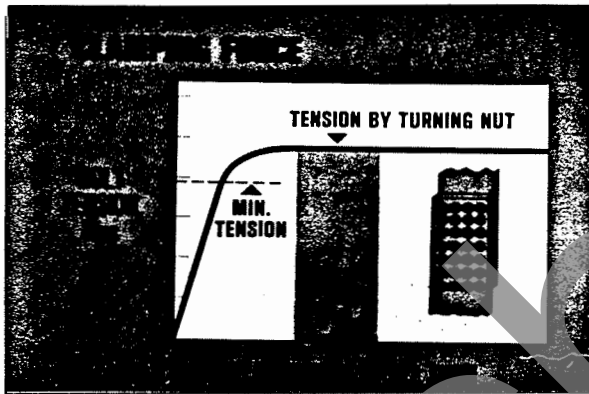

2-5

The desired performance of a fastener assembly is shown in Figure 2-5. A flat-ductile plateau in the turn versus tension behavior is desired. Slight overturning of the fastener will not cause a reduction in tension or lead to failure. Variations in the applied turns will not cause a significant variation in the bolt tension. The actual bolt tension will exceed the required pretension if the bolt is tightened into the inelastic region using the turn of the nut installation procedure.

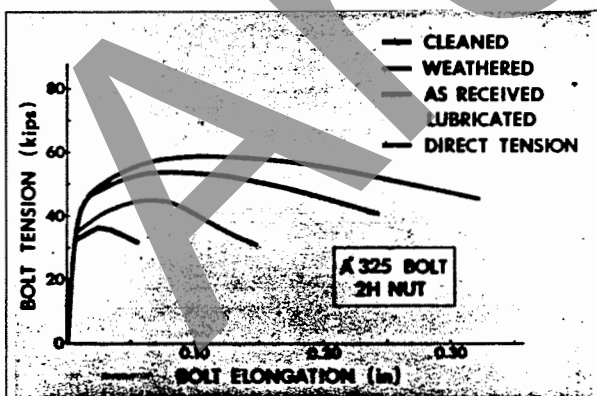

2-6

Figure 2-6 shows the behavior of the same fastener assembly tensioned by turning the nut with various conditions of the threads. The drastic reduction in the tension and ductility of the assemblies with weathered and cleaned thread conditions is caused by the higher torsion introduced into the bolt. Thread lubrication is an important variable.

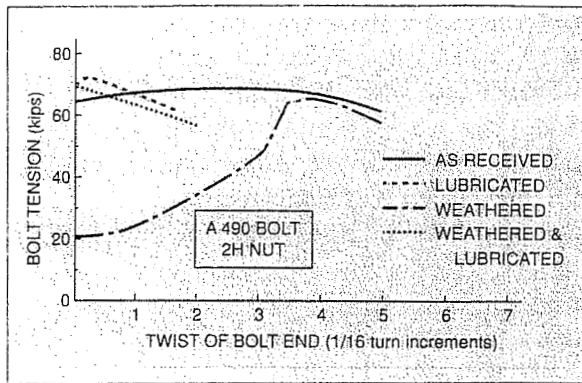

2-7

Figure 2-7 shows the rotation of the bolt at the nut end. The head of the bolt was prevented from twisting. The rotation of the bolt end indicates the magnitude of the torsional force in the bolt. Assemblies with poor thread lubrication introduce much higher twisting deformation and forces in the bolt.

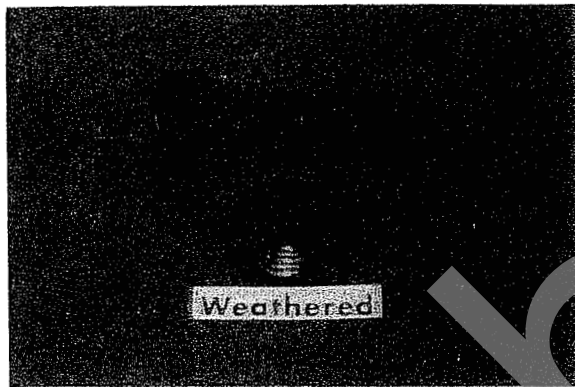

2-8

The weathered assemblies tested were in the condition shown in Figure 2-8. The water soluble oil was removed by dunking the nut and bolt individually into water. The slight rusting of the nut threads can be seen in the slide. Maintaining thread lubrication in the field is important and requires proper fastener storage at the job site.



2-9

Galvanized and coated fasteners require special consideration. Galvanizing increases the size of the threads which cause problems with the fit. Soft galvanizing also causes galling of the threads, increasing the twisting force introduced into the bolt.

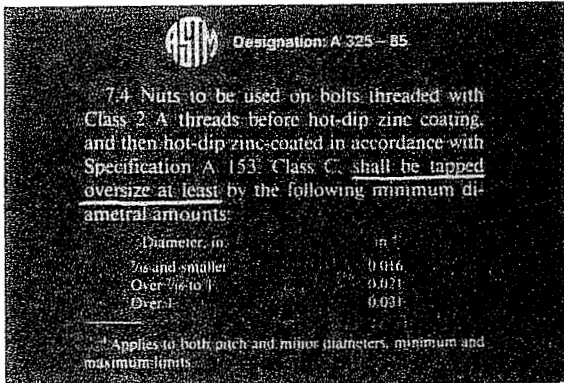

2 - 10

The present specification requires that the nut be overtapped by the minimums shown in Figure 2-10. These requirements ensure that the nut can fit the larger thread on the bolt. However, the specification can result in a nut with threads too large to develop the strength of the bolt, since it only specifies a minimum not a maximum. Research indicates that these minimums are closer to the maximum values that should be employed. The FHWA memorandum does not specify an overlap size. The manufacturer can use whatever is required to produce thread fit and strength.

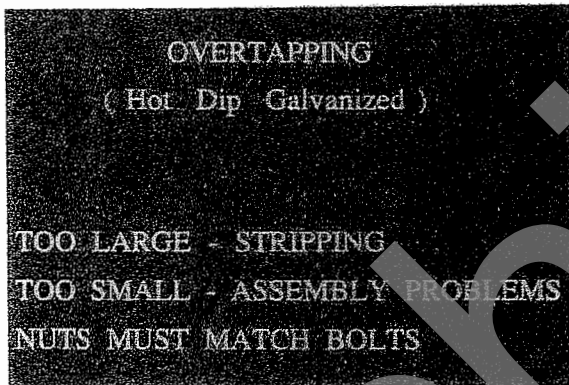

2 - 11

The amount of overtapping that can be allowed is dependent upon the strength of the nut and bolt. Thread stripping occurs when the strength of thread area engaged in the nut is not sufficient to develop the force generated in the bolt.

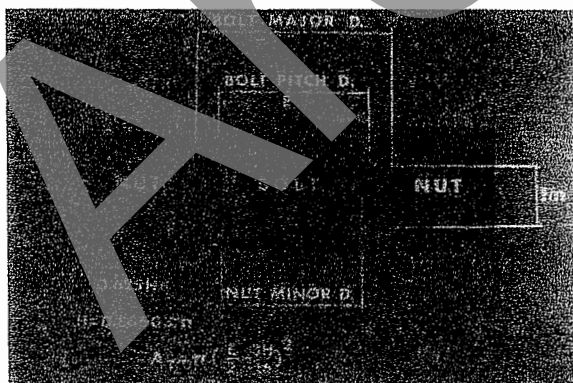

2 - 12

Stripping should not occur in a proper fastener assembly. The increase in the nut thread diameter caused by overtapping reduces the thread shear area.

A194/M292	A194/M292
2.2H	2.2H
2H	2H
2H	2H
2H	2H

2 - 13

High-strength heat treated nuts are required for galvanized fasteners. The high strength of the nuts compensate for the loss of thread cross section from overtapping.

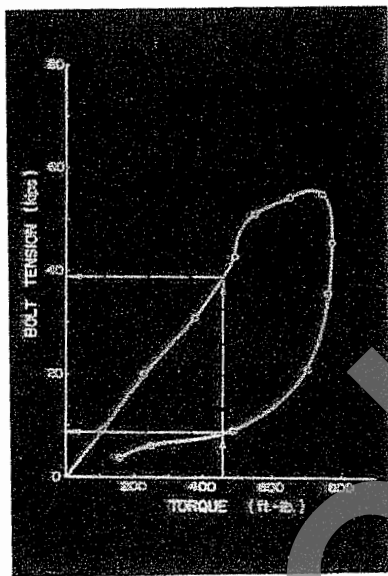

2 - 14

Stripping, which is a thread shear failure, causes the tension versus torque relationship shown in Figure 2-14. Measurement of the torque on a stripped fastener does not provide a reliable indication of tension. Also, the tension developed in the fastener may be much less than required.

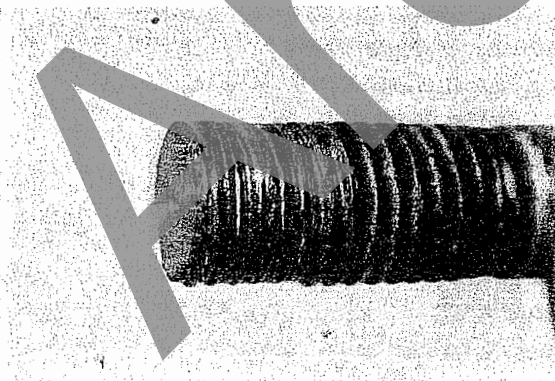

2 - 15

This is a bolt with stripped threads. A proper fastener assembly will fail by fracture through the threads of the bolt outside the nut.

LUBRICATION
 REQUIRED BUT OFTEN NOT DONE
 DYE - TO ALLOW VISUAL VERIFICATION

2 - 16

Lubrication is more critical on coated fasteners. The soft zinc on the treads can lead to galling and lock up of the threads. Lubrication prevents the occurrence of thread lock up and reduces the twisting force introduced into the bolt. Lubrication of the nut is required in the present specifications. Lubrication does not reduce stripping. Lubrication may actually increase the tendency to strip by allowing the threads to slide in the diametric direction.

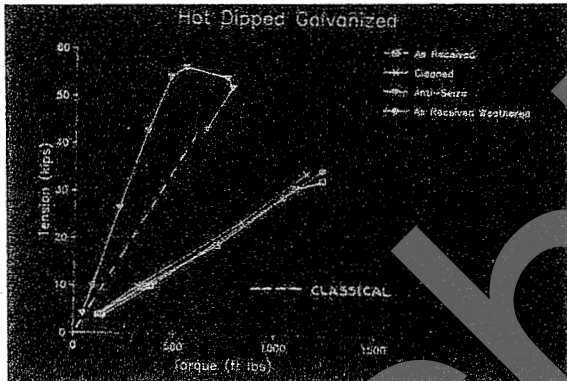

2 - 17

The importance of thread lubrication upon the tightening behavior of a galvanized bolt is shown in Figure 2-17. The as-received and cleaned assemblies produced identical results, indicating the bolts were not properly lubricated as required in the specifications. The as received bolts could not be installed to the required pretension using normal equipment. Lubrication of the nuts produced excellent results.

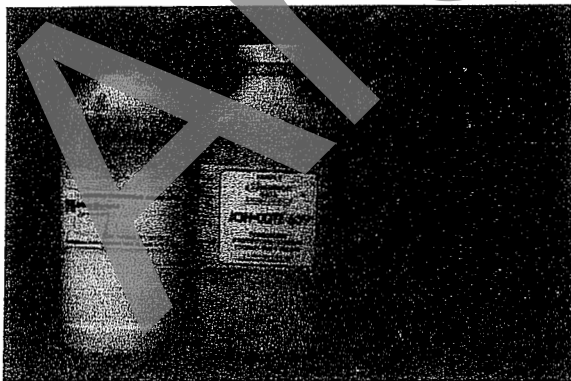

2 - 18

The commercial water soluble lubricants on the left are used by the manufacturer to lubricate the nuts. Stick waxes can be used in the field to relubricate the fastener assemblies if the water soluble lubricant has been washed away by water due to improper storage of the fasteners.

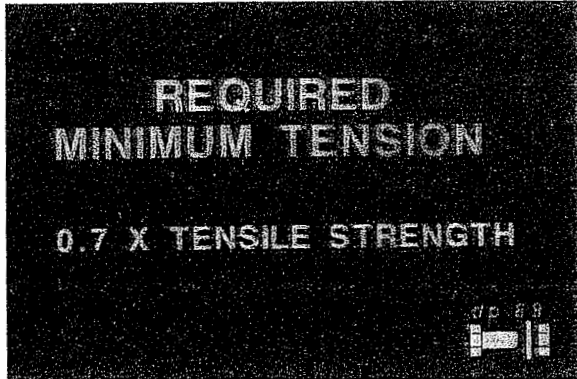

2 - 19

High-strength bolts used in bridge construction are required to be installed to an initial pretension equal to or greater than 0.7 times their tensile strength. Note that the requirement is bolt tension, not a particular torque value. Torque may be used only if the requirements for calibrated wrench installation are followed.

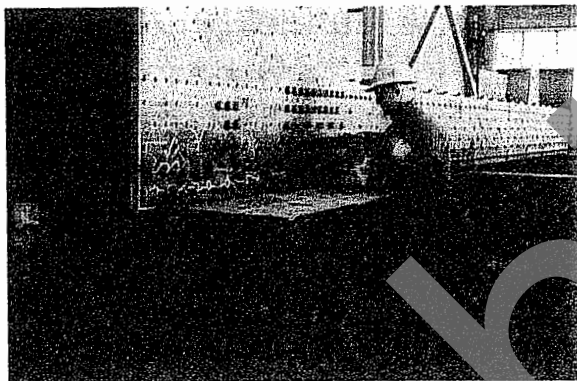

2 - 20

The purpose of the installation tension is not only to ensure that the bolt does not loosen, but also to insure the connection behaves consistent with the structural requirements.

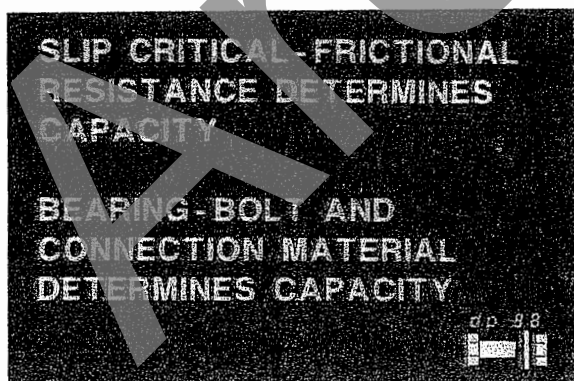

2 - 21

Two types of connection designs for shear are used in highway bridges. Slip critical connections are normally used for most connections. Bearing connections, connections which rely on bolt shear strength, are used in compression members or secondary members only. All connections, however, must satisfy the bolt shear strength requirements at maximum load.

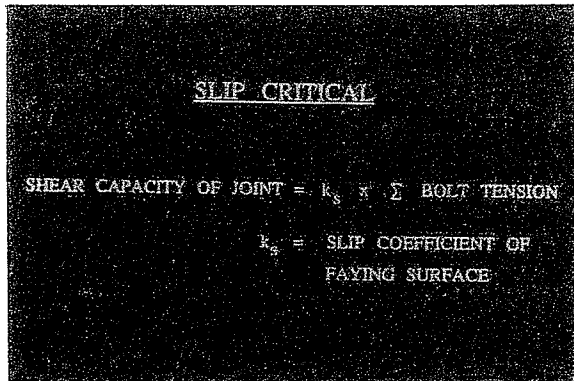

2 - 22

The installed bolt tension applies a clamping force to the plates in the connection. The plates will not slip relative to one another until the friction capacity is exceeded. The sum of the bolt tensions in the connection times the slip coefficient of the plate surfaces in contact (the faying surfaces), equals the slip load of the connection. Proper bolt tension is required for the connection to attain the design slip capacity.

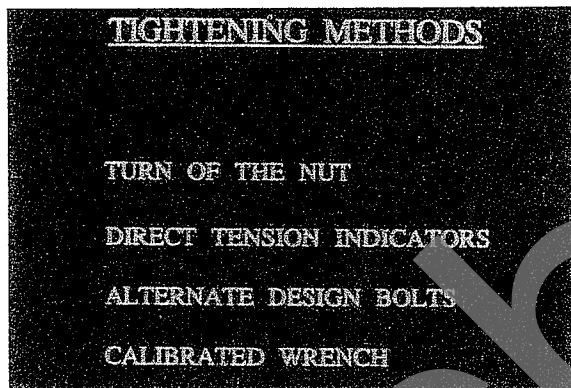

2 - 23

Four tightening methods are recognized in the specifications. The purpose of these methods is to insure that the bolts have the required installation tension. The changes in the nut and bolt specifications and the rotation capacity test are designed to insure that the fasteners are capable of being installed by any of these methods.

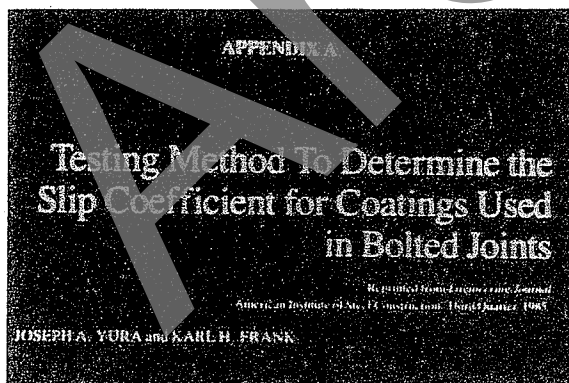

2 - 24

Paints or coatings used on the faying surface of a bolted connection are to be tested using the test method developed in a research study sponsored by the FHWA. The test method determines the slip coefficient of the coating and its creep behavior. The testing method was translated into a specification by the Research Council on Structural Connections. The tests are normally performed for the manufacturer by an independent laboratory. Some States have undertaken their own testing program.

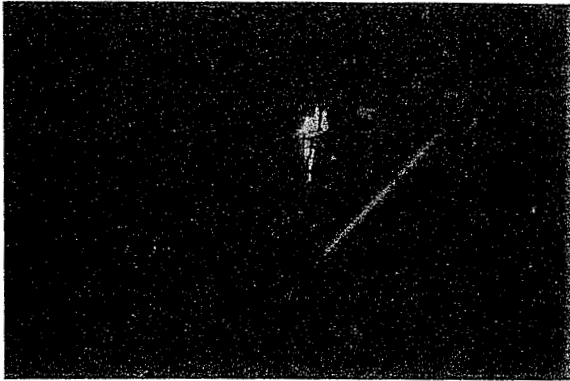

2 - 25

Small 4-inch square plates are used for the initial slip tests. They should be coated using the same procedures to be used on the job. They are to be coated to a thickness 2 mils greater than the average thickness to be used on the structure. The added thickness is to insure that a buildup of paint at a connection does not reduce the connection's slip capacity.

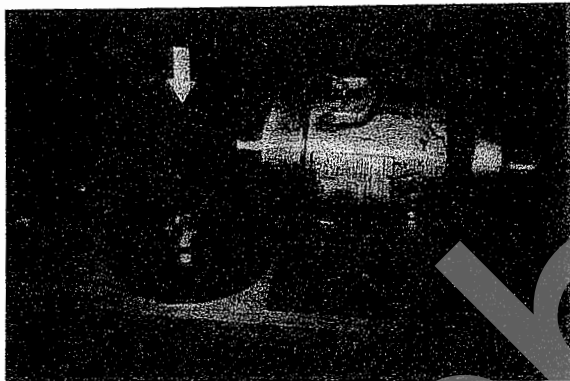

2 - 26

The slip specimen consists of three of the coated plates. The bolt tension is applied using a center hole ram with a 7/8-inch high-strength rod passing through it. The shear force is applied to the center plate by a compression test machine. The slip coefficient of the specimen is the slip load divided by twice the clamping force, since two slip planes are contained in the specimen.

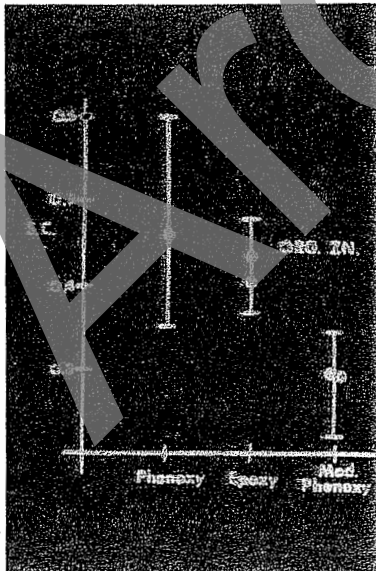

2 - 27

Paints with the same generic title do not have the same slip coefficient. All of these paints are organic zinc rich paints. Each had produced a different slip coefficient. The test method provides a simple means of insuring the paints applied have a slip coefficient compatible with the design requirements of the connection.



2 - 28

Some paints, particularly vinyl and organic zinc-rich paints, exhibit creep under sustained loading. The testing method requires a 1,000 hour creep test. The load applied to the specimen is dependent upon the results of the small slip coefficient specimens. After 1,000 hours the specimens are loaded to the minimum design load.

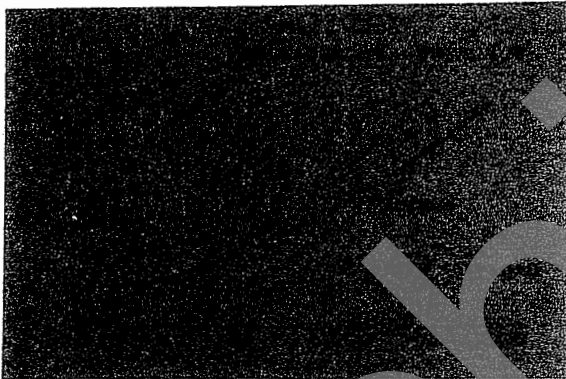

2 - 29

The results of creep tests of an inorganic zinc-rich paint with a vinyl top coat are shown in the slide. Thicker coatings have larger creep deformation than thinner coatings. Creep deformation also increases with an increase in the applied shear load. The thick coating slipped into bearing at 20% of the small specimen test slip load in less than 10 days.

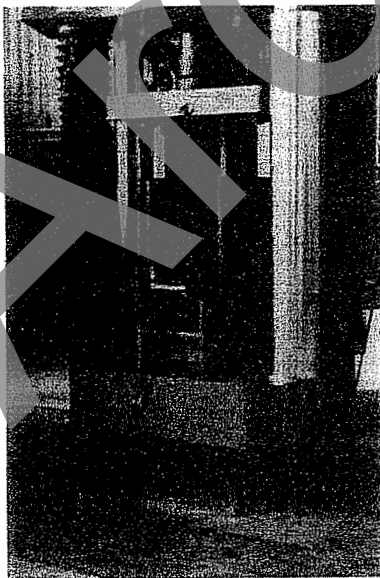

2 - 30

Large scale bolted connection tests were used to verify the accuracy of the results from the small specimens employed in the test method. The agreement was excellent. Painting of the faying surfaces reduces fabrication cost by eliminating masking. It also increases the coating life of the structure by eliminating corrosion at the uncoated crevices at the edges of the connection.

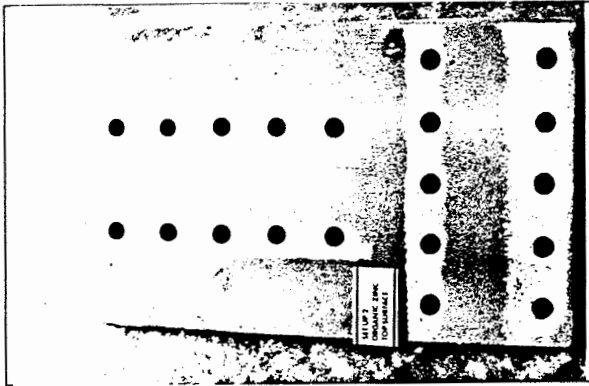

2 - 31

Shown in Figure 2-31 are the splice plates from one of the large tests after testing. Evidence of slip on the surface of the plates is only visible in the area directly under the bolt. This is due to the distribution of the bolt clamping forces between the plates. The slip coefficient of the plates remote from this contact area does not effect the slip load. Also, it is not necessary to have the outer edges of the plates in contact since only the area directly under the bolt participates in the slip resistance of the connection.

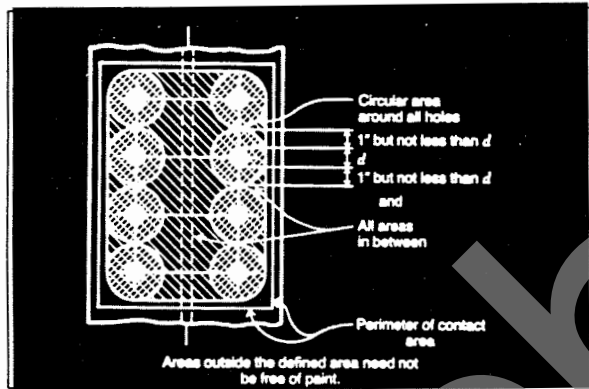

2 - 32

The specification commentary recognizes that only the area local to the bolt influences slip behavior. Figure 2-32 shown is from the commentary of the Research Council Specifications. The shaded areas are the portions of the faying surface which must have the required coating or lack of coating if a mill scale or blasted surface is specified. The portions of the faying surfaces outside of the shaded area will not influence the slip performance of the connection. This figure can also be used to indicate the areas of a connection which must be brought into contact during the snugging of the bolts. Often, due to curvature of a plate, it is not possible to bring the edges of the plate into contact. This is not a concern if the shaded areas of the plate are in contact.

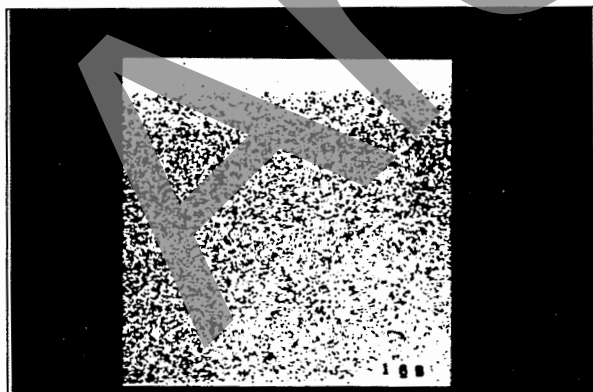

2 - 33

The shaded areas must be protected against overspray from coatings such as top coats, which are not desired on the faying surfaces. The small amount of overspray shown on this plate will cause the slip coefficient of the connection to be changed to the value of the oversprayed paint.

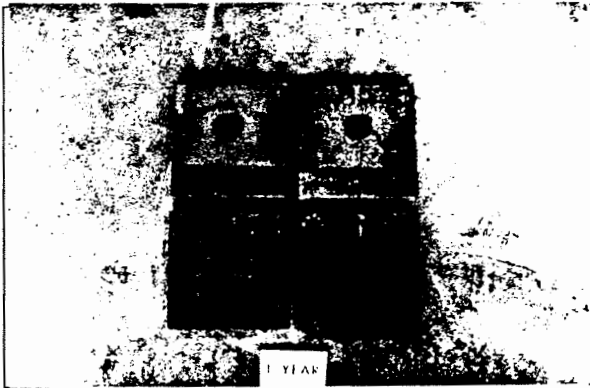

2 - 34

Weathering steels which were either blasted or had the mill scale left in place were tested after one year of exposure. Figure 2-34 shows the typical surface of the plates after exposure. The results showed that the rusting of the plates did not significantly reduce the slip coefficient of the plate surface. Tight rust does not have to be removed from unprotected surfaces. Loose scale or rust must be removed prior to making the connection. The removal should be done by blasting or hand brushing. Power wire brushing should not be used since it polishes the surfaces.

A 563

4.8 Hot-dip and mechanically deposited zinc-coated Grade DH nuts shall be provided with an additional lubricant which shall be clean and dry to the touch.

2 - 35

LUBRICANTS

ASTM A563 (AASHTO M291) specifications have mandated the use of lubricants on galvanized nuts for years.

Also Note D of Table 3 of these specifications allows the substitution of an A194 2H nut for a Grade DH nut when used on an A325 bolt, but nowhere in the specification does it state specifically that A194 2H zinc coated nuts are to be lubricated. The intent of this specification is, however, that if galvanized A194 2H nuts are substituted for galvanized Grade DH nuts that they shall be lubricated.

A 563-90

S1.1 Nuts shall be provided with an additional lubricant that shall be clean and dry to the touch.

2 - 36

This later supplemental section allows any grade of nut covered by A563 to receive a clean, dry to the touch lubricant, provided S1.1 is invoked.

B 695-90

STANDARD SPECIFICATION for Coatings of Zinc Mechanically Deposited on Iron and Steel

Lubrication references:

5.2.5.3

Note 2

2 - 37

The mechanical galvanizing specification has now been modified to include the following:

5.2.5.3 Lubrication of Grade DH nuts processed in accordance with this specification and used with Specification A325 high-strength bolts is a requirement of paragraph 6.5 of Specification A325 and paragraph 4.8 of Specification A563.

and

Note 2 - Although not included in Specification A194/A194M, this provision should apply to mechanically galvanized A194 2H nuts when supplied for use with Specification A325 bolts.

FHWA Supplemental Spec.

G4. Lubrication

1. Galvanized nuts shall be checked to verify that a visible lubricant is on the threads.

2 - 38

An inability to detect clean, dry to the touch lubricant coatings has led the FHWA to mandate the use of a "visible lubricant" so that its presence is obvious. This supplemental FHWA Specification was issued after a recent University of Texas report which indicated that fastener failures studied as part of their FHWA funded program were in part due to lubricants not having been applied. Coloring of the lubricant was a way to provide visibility and a reasonable assurance that a lubricant had in fact been applied.

A 563 Rev. (Proposed)

S2.1 The lubricant shall have a color that contrasts with the zinc coating so its presence is visually obvious at the job site.

2 - 39

ASTM has responded by providing a proposed supplemental section, S2.1, in which, when specified by the purchaser, mandates that the lubricant be "visually obvious" at the job site. These requirements have led to the inclusion of dyes and colorants to lubricant systems.

UV Detectable Lubricants

- ✓ **Predictability**
- ✓ **Verifiable**
- ✓ **Easy to use**
- ✓ **Easy to handle**
- ✓ **Clean and safe**

2 - 40

Ultraviolet detectable lubricant systems substitute UV tracers for dyes and colorants. They are detectable under a variety of UV lighting systems including portable and hand-held elements.

SUMMARY

Galvanized Nuts:

- **Visible lubricant**

Black Bolts:

- **Oily to touch when delivered and installed**

2 - 41

In summary, galvanized nuts shall be lubricated with a visible lubricant. The use of UV detectable lubricants has not been specifically addressed by the specifications.

Black bolts (and presumably nuts) shall be oily to the touch when delivered and installed.

Session 3
FHWA Requirements for High Strength Bolts

FHWA
SUPPLEMENTAL SPECIFICATIONS
July 1988

3 - 1

FHWA SUPPLEMENTAL SPECIFICATIONS

The FHWA first issued supplemental specifications to underscore various recommendations and to implement recommendations made in the FHWA-sponsored research report, *High-Strength Bolts for Bridges*.

FHWA
Modified
SUPPLEMENTAL SPECIFICATIONS
November 1989

3 - 2

The modified supplemental specifications issued by FHWA in November 1989 are in a ready-to-use specification format with needed clarification and can be incorporated in the contract if required. The modifications also reflect new research and input from the industry.

REPLACES FHWA
JULY 1988 MEMORANDUM
EXPANDS MEMORANDUM TO
A SPECIFICATION
REFLECTS NEW RESEARCH

dp 88

3 - 3

**AASHTO MATERIALS
SPECIFICATIONS**

ASTM SPECIFICATIONS

**AASHTO STANDARD
SPECIFICATIONS FOR
BRIDGES**

ANSI SPECIFICATIONS



3 - 4

CONVENTIONAL PRACTICES AND
CURRENT SPECIFICATIONS FOR
HIGH STRENGTH BOLTS

Generally, the States have been using “AASHTO Materials Specifications” and “AASHTO Standard Specifications for Bridges” and ANSI Specifications as applicable to high-strength bolts along with special provisions to a project.

Consideration is being given to revise fastener specifications in “AASHTO Materials Specifications” and “AASHTO Standard Specifications for Bridges, Division II.”

ASTM Subcommittee F16.02 is also considering revisions to current specifications for fasteners.

**SUPPLEMENTAL CONTRACT
SPECIFICATIONS FOR PROJECTS
WITH AASHTO M164 (A325)
HIGH STRENGTH BOLTS
(FHWA MEMORANDUM NOV. 1989)**



3 - 5

**SPECIFICATION FOR
STRUCTURAL JOINTS
USING ASTM A325 OR
A490 BOLTS - 1985
AND/OR 1988**



3 - 6

RCSC approved “Specification for Structural Joints using ASTM A325 or A490 Bolts” is a very good reference source which includes a very useful commentary.

HIGH - STRENGTH BOLTS

ASTM A325
(AASHTO M164)

ASTM A490
(AASHTO M253)



3-7

HIGH-STRENGTH BOLTS

Generally, A325 (M164) bolts are used in bridge work.

AASHTO allows A490 (M253) bolts also.

A325 (M164) BOLT TYPES

TYPE 1 MEDIUM-CARBON
1/2" TO 1 1/2"

TYPE 2 LOW-CARBON
MARTENSITE
1/2" TO 1"

TYPE 3 WEATHERING
1/2" TO 1 1/2"



3-8

A325 (M164) BOLT TYPES

A325 bolts are available as types 1, 2 and 3. Type 2 steel is no longer manufactured in U.S. ASTM is considering eliminating this type.

A325 (M164) BOLTS STRENGTH REQUIREMENTS

DIAMETER INCH	YIELD KSI	TENSILE KSI
1/2 - 1	92	120
1 1/8 - 1 1/2	81	105



3-9

A325 (M164) STRENGTH REQUIREMENTS

A325 (M164) fasteners require minimum tensile strength of 105 ksi for 1 1/8 to 1 1/2-in. diameter bolts and 120 ksi minimum strength for 1/2 to 1-inch diameter bolts.

A325 (M164) BOLTS HARDNESS REQUIREMENTS

DIAMETER (IN.)	MINIMUM	MAXIMUM
1/2" - 1"	24	35
1 1/8" - 1 1/2"	19	31

RECOMMENDED IN THE FHWA SUPPLEMENTAL SPECIFICATIONS - 33Rc



3 - 10

A325 (M164) HARDNESS REQUIREMENTS

ASTM and AASHTO Materials Specifications provide a range of hardness, but these specifications do not include upper bound of tensile strength for A325 (M164) bolts. Of course, the hardness can be converted to an equivalent tensile strength using conversion tables. (For example see conversion tables in ASTM A370).

max Hardness - 34 HRC

MATCHING NUTS

A325 (M164)	A 563 (M291)	A194 (M292)
TYPE 1 & 2 PLAIN	C, C3, D, DH & DH3	2, 2H
TYPE 1 & 2 GALV.	DH & DH3	2H
TYPE 3	C3, DH3	-



3 - 11

MATCHING NUTS

FOR A325 (M164) BOLTS

- Type 3 bolts may be used in lieu of type 1 or 2 uncoated bolts.
- Matching nuts for A325 (M164) bolts include nonheat-treated nuts 2, C, C3 and D in addition to heat-treated nuts 2H, DH and DH3.
- Only heat-treated nuts are galvanized.
- Overtapping and lubrication requirements for A194 (M292) grade 2H nuts are the same as those for A563(M291) nuts.

NUT HARDNESS REQUIREMENTS

PLAIN NUTS-A563(M291) & A194(M292)

GRADE	MIN.	MAX.
C&C3	B78	C38
D	B84	C38
2	B84	-
RECOM.	B89	C38



3 - 12

NUT HARDNESS REQUIREMENTS

FOR A325 (M164) BOLTS

These nonheat-treated nuts can have hardness as low as 78 HRB. (The FHWA recommends a minimum hardness of 89 HRB. This will be discussed later.)

Heat-treated nuts which are often preferred by bridge owners have higher hardness.

A 490 (M253) BOLTS

MATCHING NUTS

TYPE 1	ALLOY	DH, DH3, & 2H
TYPE 2	LOW-CARBON MARTENSITE	DH, DH3, & 2H
TYPE 3	WEATHERING	DH3



3 - 13

A490 (M253) BOLTS & MATCHING NUTS

- A490 (M253) bolts are available as types 1, 2 and 3.
- A490 (M253) bolts are not galvanized.
- Only heat-treated hardened nuts are permitted as matching nuts of A490 (M253) bolts.

A 490 (M253) BOLTS STRENGTH REQUIREMENTS

DIAMETER INCH	YIELD KSI	TENSILE KSI
1/2 - 1 1/2	130	MIN-150 MAX-170



3 - 14

A490 (M253) STRENGTH REQUIREMENTS

Specified strength of A490 (M253) bolts range from 150 ksi to 170 ksi.

NUT HARDNESS REQUIREMENTS FOR A490 (M253) BOLTS

HEAT-TREATED NUTS A563 (M291)
& A194 (M292)

GRADE	MINIMUM	MAXIMUM
DH & DH3	C24	C38
2H	C24	C38



3 - 15

NUT HARDNESS REQUIREMENTS FOR A490 (M253) BOLTS

Heat-treated hardened nuts with minimum hardness C24 are permitted.

Note: (C24 >> 89HRB)

SEVEN SECTIONS

- A. SCOPE
- B. SPECIFICATIONS
- C. MANUFACTURING
- D. TESTING
- E. DOCUMENTATION
- F. SHIPPING
- G. INSTALLTION



3 - 16

FHWA SUPPLEMENTAL SPECIFICATION (FHWA Memorandum Nov. 8, 1989)

"FHWA supplemental specifications for projects with AASHTO M164 (A325) high-strength bolts" contains seven sections.

FHWA MEMO AMENDS OR REVISES AASHTO M SPECIFICATIONS

(DOES NOT DUPLICATE)



3 - 17

The FHWA supplemental specifications amend or revise AASHTO Material Specifications, but do not replace them.

FHWA SUPPLEMENTAL SPECIFICATIONS

SCOPE



3 - 18

The supplemental specifications cover requirements for M164 (A325) bolts, matching nuts, and washers only. Similar requirements for other fasteners are under consideration.

FHWA SUPPLEMENTAL SPECIFICATIONS

AFFECTS THE FOLLOWING SPECIFICATIONS:

BOLT	M164 (A325)
NUT	M292 (A194) M291 (A563)
WASHER	M293 (F436) <i>dp 88</i>



3 - 19

SPECIFICATIONS

MANUFACTURING REQUIREMENTS

- ▶ Limits Bolt Hardness
- ▶ Increases Hardness Requirements for Nuts
- ▶ Limits Oversize Tapping
- ▶ Requires Visible Lubricant Galvanized Nuts
- ▶ Requires Marking

3 - 20

MANUFACTURING

MANUFACTURING

1. Limits Maximum Bolt Hardness

3 - 21

The FHWA supplemental specifications limit M164 (A325) bolt hardness of 1/2 inch to 1 inch dia. bolts to the maximum hardness of 33Rc. Because the maximum required hardness is 31Rc for bolts greater than 1 inch diameter, in the AASHTO Materials Specifications, no changes in the hardness requirements are proposed for larger-diameter bolts.

A325 (M164) BOLTS

HARDNESS 24Rc → 35Rc
 STRENGTH 119KSI → 156KSI

A490 (M253) BOLTS

STRENGTH 150KSI → 170KSI
 HARDNESS 33Rc → 38Rc

dp 88

3 - 22

INCONSISTENCY IN THE CURRENT REQUIREMENTS FOR STRENGTH AND HARDNESS OF BOLTS

ASTM and AASHTO Materials Specifications allow maximum hardness of 35Rc for A325 (M164) bolts. This is equivalent to a tensile strength of approximately 156 ksi. Because specifications allow galvanizing of A325 (M164) bolts, it is possible to allow galvanizing of A325 (M164) bolts which may have 35Rc hardness and approximately 156 ksi tensile strength.

A490 (M253)	A325 (M164)
150 ksi 33 R _c	156 ksi 35 R _c
Can Not Be Galvanized	Can Be Galvanized

3 - 23

However, the current practice is to prohibit galvanizing A490 bolts, which can have hardness as low as 33Rc and tensile strength as low as 150 ksi.

RECOMMENDED MAXIMUM HARDNESS A325 (M164) BOLTS

35 R_c
 ↓
 33 R_c

3 - 24

RECOMMENDED MAXIMUM HARDNESS FOR A325 (M164) BOLTS

The FHWA supplemental specifications limit A325 (M164) bolt hardness to 33Rc for bolts 1/2 inch to 1 inch diameter.

MANUFACTURING

2. Increases Hardness Requirements for Non-Heat Treated Nuts

3 - 25

NUTS

Minimum hardness of 89 HRB is required for non hardened nuts. (Heat-treated nuts have hardness > 89 HRB).

WHY MINIMUM HARDNESS OF 89 HRB?

3 - 26

WHY MINIMUM HARDNESS OF 89 HRB?

Alexander's model helps explain why 89 HRB minimum hardness must be required for nonheat-treated nuts if stripping of nuts must be controlled.

The curves have been plotted for A325 bolts of 7/8 inch diameter and 156 ksi tensile strength (equivalent to 35Rc hardness).

STRIPPING can be controlled using heat-treated nuts 2H, DH, DH3, or nonheat-treated nuts 2, C, C3 and D provided nonheat-treated nuts have strength > 87 ksi, i.e. hardness > 89 HRB.

3 - 27

The stripping strength represents stripping strength of the bolt or the stripping strength of the nut.

Tension strength is tension strength of the bolt.

For a stripping strength/tension strength ratio the failure will occur by nut stripping when the observed nut strength is 87 ksi or less.

87 ksi strength is equivalent to 89 HRB hardness (see conversion table in ASTM A370).

NON-HEAT TREATED NUTS (2, C, C3 and D)

If Hardness > 89 HRB -
NO Stripping

(Tension Failure Rather
Than Stripping Failure)

3 - 28

Thus, it can be concluded that non-heat-treated nuts with minimum hardness of 89 HRB would prevent stripping, and tension failure, rather than stripping failure, would result - and that is desirable.

MANUFACTURING

3. Limits Oversize Tapping

3 - 29

NUTS

It is suggested that the amount of overlap in the nut must be such that the nut will assemble freely on the bolt in coated condition and also meet the mechanical requirements of AASHTO M291 (A563) and the rotational-capacity test. The amount of overlap values in M291 (A563) Sec. 7.4 are considered maximum overlapping values.

ASTM A563 SECTION 7.4

7.4 Nuts to be used on bolts threaded with class 2A threads before hot-dip zinc coating, and then hot-dip zinc coated in accordance with specification A153 class C, shall be tapped oversize at least by the following minimum diametral amounts:

DIAMETER IN. IN.^A

7/16 Smaller	0.016
Over 7/16 to 1	0.021
Over 1	0.031

A: Applies to both pitch and minor diameters, minimum and maximum limits.

A563 (M291) SECTION 7.4	MIN. OVERTAPPING IF NUT IS TO BE GALV.
7/16 & SMALLER	0.016 IN.
OVER 7/16 TO 1	0.021 IN.
OVER 1	0.031 IN.
A325 (M164) SECTION 7.3	DIAMETRAL INCREASE IF BLACK BOLT IS HOT- DIP GALV. 

3 - 30

LARGE OVERTAPPING LEADS TO STRIPPING

3 - 31

Because large overtapping leads to stripping - the A563M (M291M) specification has been written to ensure that the overtapping requirement is for the maximum limit for overtapping.

RECOMMENDED BY FHWA MAXIMUM OVERTAPPING

DIAMETER (inches)	Inches
7/16 & Smaller	0.016
Over 7/16 to 1	0.021
Over 1	0.031

3 - 32

- FHWA supplemental specifications limit maximum overtapping for galvanized nuts.
- FHWA supplemental specifications (November 1989 memorandum) require a fastener assembly to pass the rotational-capacity test.

MANUFACTURING

4. Requires Visible Lubricant

3 - 33

FHWA supplemental specifications require visible lubricant for galvanized nuts and, dry and oily to the touch for black bolts.

MANUFACTURING

5. Requires Marking on Fasteners

FHWA supplemental specifications require that all bolts, nuts and washers be marked in accordance with appropriate AASHTO/ASTM specifications.

3 - 34

TESTING

TESTING

3 - 35

TESTING

- ☆ **Prior to Shipping**
- ☆ **Upon Arrival in the Field**

Testing of fasteners is required by the manufacturer or distributor prior to shipping. Also, tests are required in the field.

3 - 36

TESTING

Mechanical Tests for Fasteners

3 - 37

Mechanical tests are required for:

- Bolts
- Nuts
- Washers
- Assemblies

TESTING

BOLTS

1. PROOF LOAD TEST - AFTER GALV.
2. WEDGE TEST - AFTER GALV.
3. ZINC THICKNESS - MEASURED

dp 88



3 - 38

BOLTS

As specified in M164 (A325), minimum frequency of testing for proof load and wedge tests is required. For galvanized bolts, tests are required to be performed after galvanizing. For such bolts zinc coating thickness measurements on wrench flats or top of bolt heads is required.

TESTING

NUTS

1. PROOF LOAD - AFTER GALV.
2. ZINC THICKNESS - MEASURED

dp 88



3 - 39

NUTS

As specified in AASHTO M291 (A563), minimum frequency of proof load testing is required. For galvanized nuts, test are required to be performed after galvanizing. For such nuts, zinc coating thickness measurements on wrench flats is required.

TESTING

WASHERS

- 1. HARDNESS TEST -
AFTER GALV.**
- 2. ZINC THICKNESS -
MEASURED**



3 - 40

WASHERS

For galvanized washers hardness testing is required after galvanizing. For such washers, zinc coating thickness measurement is required.

TESTING

ASSEMBLIES

- 1. ROTATIONAL-CAPACITY TEST (Black
and Galvanized)**

3 - 41

ASSEMBLIES

Rotational-capacity testing is required on all black and galvanized (after galvanizing) assemblies by the manufacturer or distributor prior to shipping.

TESTING: Rotational-Capacity Test

- 1. By Manufacturer or Distributor**
- 2. Same Test Required In Field**
- 3. Each Combination Lot of Bolt,
Nut, and Washer**
- 4. Test In Skidmore, Not In Steel
Joint**

3 - 42



3 - 43

Washers are required as part of the test even though they may not be required as part of the installation procedure.

Each combination of production lots of bolts, nuts and washers (when required) is required to be tested as an assembly.

The bolts should show no evidence of stripping after the required turns are applied.

After subsequent loosening of the fastener with a wrench, the nut should be able to turn off by hand (i.e., nut should not bind with the threads of the bolt).

Each combination of production lots of bolts, nuts and washers is required to be assigned a rotational-capacity lot number.

Minimum frequency of testing is 2 per rotational-capacity lot (prior to shipping).

TESTING:
Rotational-Capacity Test

Each Production Lot Combination Is Required to Be Tested.

3 - 44

TESTING:
Rotational-Capacity Test

SKIDMORE-WILHELM CALIBRATOR or Equivalent Device Is Required

3 - 45

ROTATIONAL-CAPACITY TEST

During rotational-capacity testing, bolt tension is required to be measured using the Skidmore-Wilhelm Calibrator or an equivalent device.



3 - 46

ROTATIONAL-CAPACITY TEST

Steel joints are not permitted except with short bolts.

TESTING:
Rotational-Capacity Test
TWO TIMES INSTALLATION ROTATION
TENSION: $\geq 115\%$ of Installation Tension

3 - 47

ROTATIONAL-CAPACITY TEST

The minimum rotation from a snug tight condition (10% of the specified proof load) shall be:

240°	(2/3 turn)	L < 4D
360°	(1 turn)	4D < L < 8D
480°	(1 1/3 turn)	L > 8D

The tension reached at the above rotation shall be equal to or greater than 1.15 times installation tension.

Therefore, required turn test tension for a 7/8 inch diameter M164 (A325) bolt:

$$= 1.15 \times 39K \text{ (req'd. instal. tension)}$$

$$= 45 \text{ kips}$$

Values of minimum required turn test tension are included in the FHWA supplemental specifications.

After reaching the installation tension, the relationship between torque and tension shall be given by:

$$\text{Torque} \leq 0.25PD$$

Where:

Torque = measured torque (ft.-lbs)

P = measured tension (lbs)

D = bolt diameter (feet)

TESTING:
Rotational-Capacity Test
For Tension \geq Installation Tension
 $T \leq 0.25 PD$
Where:
T = Measured Torque (ft.-lbs)
P = Measured Tension (kips)
D = Bolt Diameter (ft)

3 - 48

TESTING:

SHORT BOLTS

Modified Rotational-Capacity Test

3 - 49

Short Bolts

Because short bolts would not fit in the conventional Skidmore-Wilhelm Calibrator, it is suggested that the measurement of maximum tension to achieve twice the required installation rotation be omitted. Instead, a value equal to turn test tension (1.15 x installation tension), may be used to compute the torque. The measured torque will be obtained by turning the nut to the minimum rotation (i.e., installation rotation) from the snug tight position in a steel joint.

TESTING

REPORTING

WITNESSING

3 - 50

Reporting

The results of all tests (including zinc coating thickness) must be recorded. Locations where tests are performed and date of tests are also recorded.

Witnessing

The tests need not be witnessed by an inspection agency, however, the manufacturer or distributor is required to certify that the results are accurate.

$$T \leq k P D$$

k = NUT FACTOR (DIMENSIONLESS)
P = BOLT TENSION (POUNDS)
D = BOLT DIAMETER (INCHES)



3 - 51

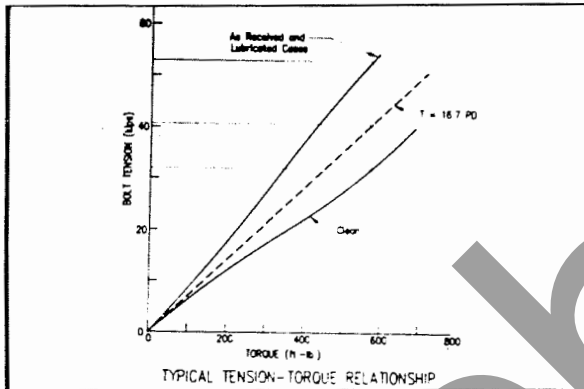

3 - 52

INSTALLATION

1. AASHTO Division II Requirements
2. Snug Tight Condition Achieved
3. Rotational-Capacity Test
(Washer Required)

3 - 53

INSTALLATION

Why are installation test procedures necessary at the job site?

Considering "as received" and clean bolts, it is obvious that there can be a large variation in bolt tension for a given torque. Significant torque variation from what was needed in the laboratory can occur during installation. (-38 to +39% for A325 black bolts and -32 to +3% for A490 bolts have been reported in the literature.)

Hence, calibration tests should be done in a manner that provides a reliable installation torque for a given lot of bolts.

In the field, bolts must be installed in accordance with AASHTO Div. II Art. 10.17.4. Upon verifying the visible lubricant, examining the surface condition of fasteners, and verifying the lot number, the snug tight condition is achieved and the rotational-capacity test is performed similar to the testing by the manufacturer (or supplier) as discussed earlier.

INSTALLATION TESTS

PURPOSE:

- ▶ To Ensure Proper Installation Tension
- ▶ To Ensure Quality of the Product Received at the Job Site

3 - 54

Purpose of Installation Tests

Installation procedure tests are required to ensure proper installation tension as bolts are installed, and also to ensure quality of the product received in the field.

INSTALLATION REQUIREMENTS

1. SKIDMORE - WILHELM CALIBRATOR OR EQUIVALENT DEVICE
2. CALIBRATED DTI (FOR SHORT BOLTS)
3. CALIBRATED WRENCH



3 - 55

Installation Test Requirements

- 1 - A Skidmore-Wilhelm Calibrator or an acceptance equivalent device.
- 2 - Calibrated direct tension indicating washers (for installation testing for short bolts).
- 3 - Calibration wrench (periodic testing at least once each working day - when calibrated wrenches are used).

DOCUMENTATION

1. MILL TEST REPORT (MTR)
2. MANUFACTURER CERTIFIED TEST REPORT (MCTR)
3. DISTRIBUTOR CERTIFIED TEST REPORT (DCTR)



3 - 56

DOCUMENTATION

MILL TEST REPORT

M T R

3 - 57

MANUFACTURER CERTIFIED TEST REPORT

M C T R

3 - 58

MCTR

IF ROTATIONAL-CAPACITY TEST IS PERFORMED BY THE MANUFACTURER, ADDITIONAL RELATED INFORMATION MUST BE INCLUDED ON THE MCTR

dp 88

3 - 59

Mill Test Report

A "Mill Test Report" (MTR) must include test results from tests performed on the steels used in the manufacture of fasteners (bolts, nut and washers).

The tests required in the MTR may be performed by the mill or an independent testing agency.

Mill test reports are required to show the name of the country where the material was melted and manufactured.

Manufacturer Certified Test Report(s)

A "Manufacturer Certified Test Report" (MCTR) must include test results for the items furnished (bolts, nut and washers as appropriate) and other relevant information required (e.g., where tests were performed and date of tests, etc.).

If the manufacturer performs the rotational-capacity test, the MCTR must include the following:

- 1 - The lot number of each item tested.
- 2 - The rotational-capacity lot number assigned.
- 3 - Test results of the rotational-capacity test.
- 4 - Location where tests are performed and date of test.
- 5 - The location where fastener assembly components were manufactured.
- 6 - The statement that items in the MCTR meet appropriate specifications.

M C T R

1. Lot Number of Each Item
2. Rotational-Capacity Lot Number Assigned
3. Test Results of Rotational-Capacity Test

3 - 60

MCTR

(CONT.)

4. LOCATION & DATE - TEST PERFORMED
5. LOCATION - FASTENER COMPONENT MANUFACTURED
6. STATEMENT OF CONFORMANCE

dp 88

3 - 61

Distributor Certified Test Report(s) DCTR

The distributor certified test report (DCTR) is required to include the MCTR noted above. If the rotational-capacity test is performed by the distributor (or an inspection agency representing the distributor), the results of the test and the following information are to be reported by the distributor:

- 1 - The rotational-capacity lot number assigned.
- 2 - Test results of rotational-capacity test.
- 3 - Location where tests are performed and date of test.
- 4 - The statement that the MCTR is in conformance with appropriate specifications.

DISTRIBUTOR CERTIFIED TEST REPORT

D C T R

3 - 62

DCTR

ADDITIONAL INFORMATION REQUIRED

1. ROTATIONAL-CAPACITY LOT NUMBER ASSIGNED
2. TEST RESULTS OF ROTATIONAL-CAPACITY TEST



3-63

DCTR

(CONT.)

3. LOCATION AND DATE-TEST PERFORMED
4. STATEMENT OF CONFORMANCE



3-64

SHIPPING

COMPONENTS FROM EACH ROTATIONAL-CAPACITY LOT ARE REQUIRED TO BE SHIPPED TOGETHER



3-65

SHIPPING

If there is only one production lot number for each size of nut and washer, they may be shipped in separate containers. Otherwise, components from each rotational-capacity lot are required to be shipped in the same container.

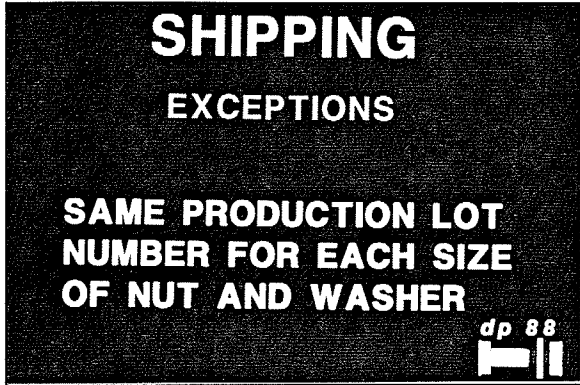

3 - 66

Each container is marked with rotational-capacity lot number and adequately identified.

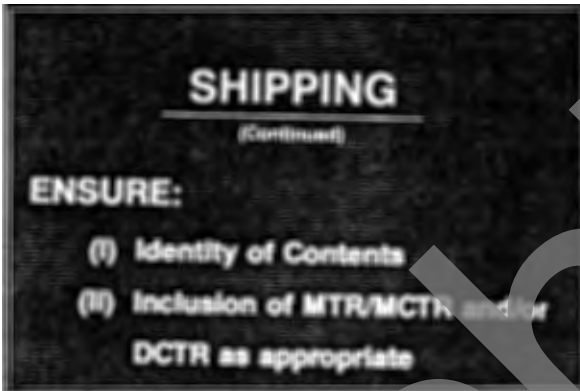

3 - 67

The MTR, MCTR or DCTR is supplied to the contractor or owner as required.

Archived

Session 4
Manufacturing Processes



4 - 1

COLD FORMED FASTENERS

Bolts are manufactured by either cold forming or hot forging methods. Most intermediate diameters ($\frac{5}{8}$ inch through $1\frac{1}{4}$ inch) are cold formed.

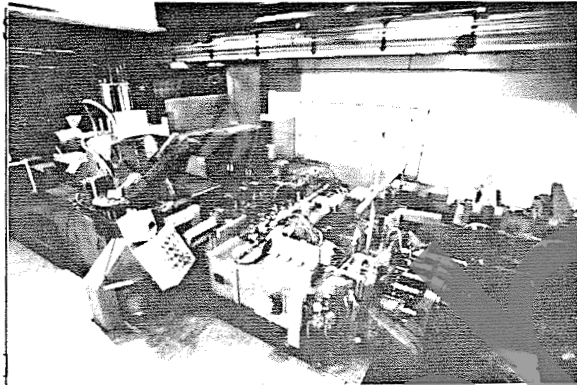

4 - 2

Cold formed bolts are manufactured in a bolt maker, which is a horizontal, multi-station, mechanical press.



4 - 3

Material for cold formed bolts is received from the steel mill in coils. Each coil has a tag attached identifying the mill heat number, material grade or type and chemistry. Depending upon the source, a mill heat would yield 100 coils weighing about 1 ton per coil. The material is hot-rolled and non-annealed.

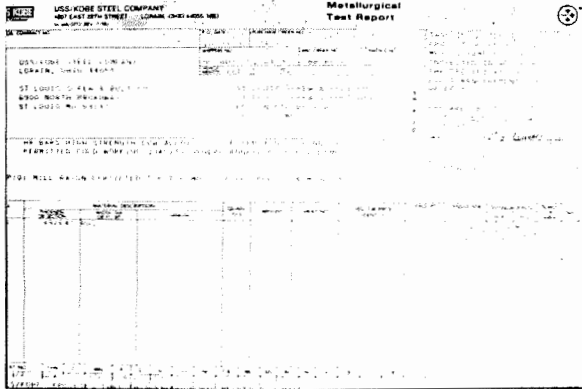

4 - 4

A mill test report (MTR) is furnished for each heat by the producing mill. This MTR must list the heat number and heat analysis. Additionally, for "Buy American" projects, the MTR will include a statement indicating that the material was melted and manufactured in the U.S.A.

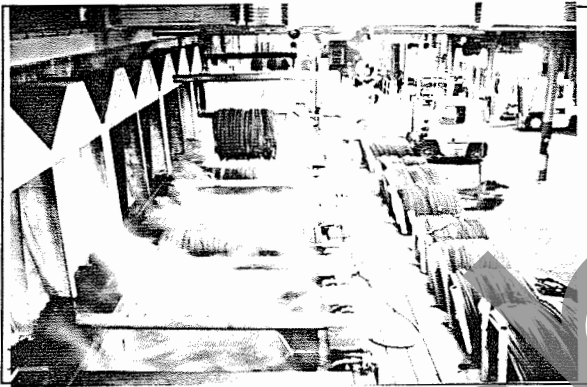

4 - 5

The first step in the manufacture of bolts is to clean the coils. In this operation, called "pickling", the coils are suspended in a sulfuric acid tank. They subsequently receive a water rinse and a heavy lime coating.



4 - 6

The lime neutralizes the effect of any remaining acid, protects the material from corrosion and acts as a base for lubrication added in a later operation.

Some manufacturers purchase the raw material already pickled and coated. Others abrasive blast the material to remove mill scale and dirt.



4 - 7

After pickling, additional identification may be used, including color coding and re-tagging.

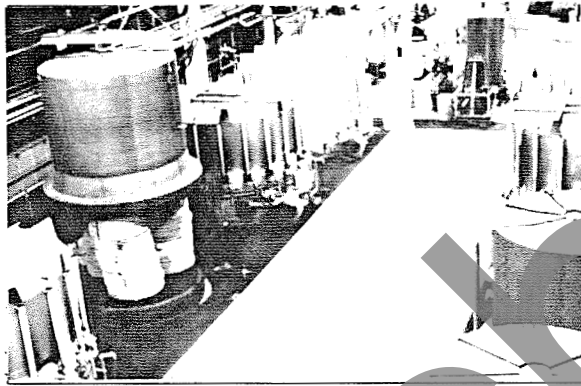

4 - 8

Coils are then annealed. Annealing is a form of heat treatment that softens the steel and increases its ductility and formability. The material is heated in a controlled atmosphere to approximately 1400°F and held for 24 to 48 hours.

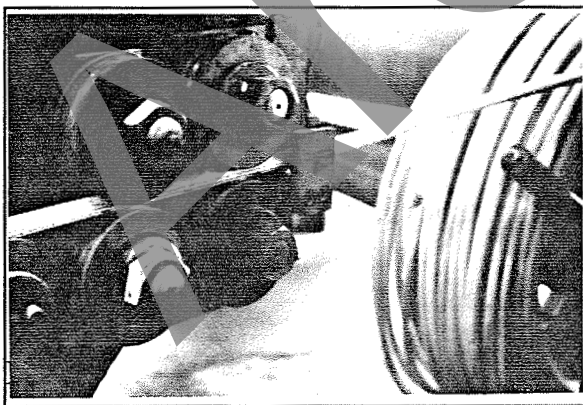

4 - 9

Raw material is then moved to the manufacturing area. Initially, the coil is fed into the wire drawer. The offset rollers straighten the wire and the carbide die reduces the diameter approximately .030 in. to the required shank diameter.

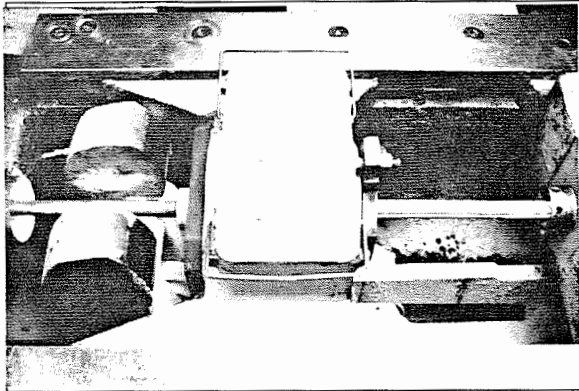

4 - 10

The material to the left of the die is .030 inch or about 1/32 inch smaller in diameter. Some manufacturers purchase material that has been drawn to the finished diameter.

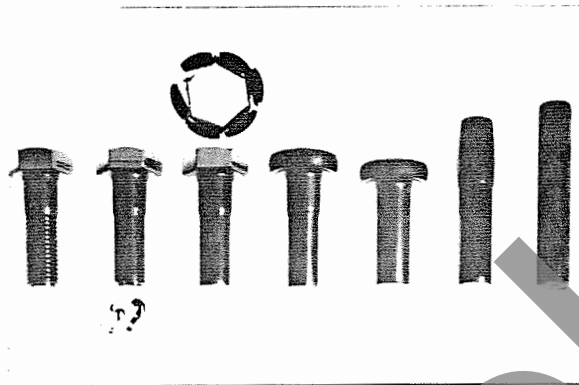

4 - 11

The material then feeds to the bolt maker. The manufacturing stages are:

- cut-off, upset, head, extrude, trim, point and roll thread.



4 - 12

The guts of the bolt maker are a series of hydraulic presses. The bolt moves from the far side of the press toward the near side on each stroke of the machine. We can see the various forming stages in the manufacturing operation.

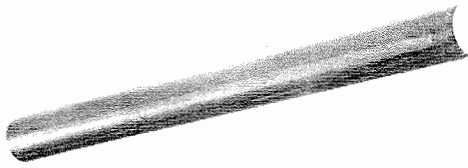

First, a blank of appropriate length is sheared from the coil. Blank length depends on bolt length and head size.

4 - 13

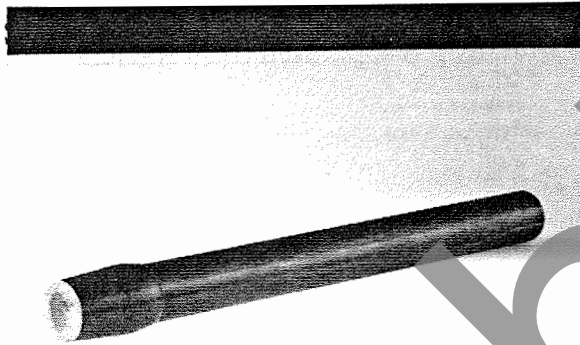

The first station then forms an upset or preform on one end of the blank in preparation for heading.

4 - 14



The second station forms a button from the upset. In this station the washer face, fillet radius, headmark, and head height are also formed. The actual sequence may vary between different manufacturers.

4 - 15

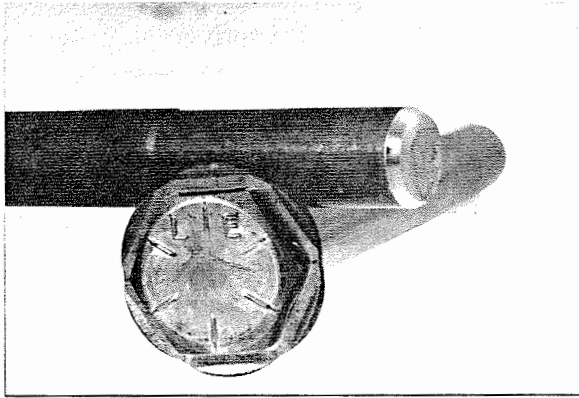

4 - 16

Next, the length of shank to be threaded is extruded to the thread pitch diameter (as shown on the upper bolt). The bolt then moves to the trimming station where a trimming die shears material from the circumference to form the hex shape (the bottom bolt).

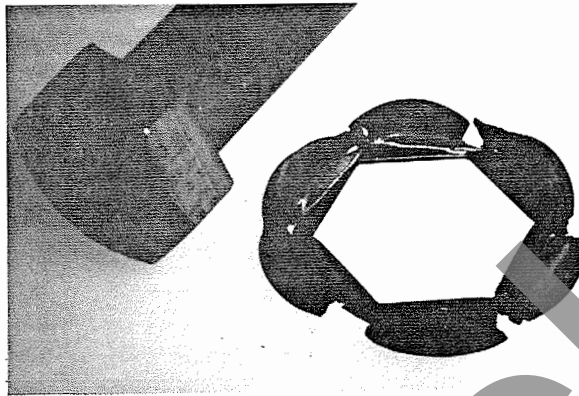

4 - 17

Here, the trim drop is separated from the hex head.

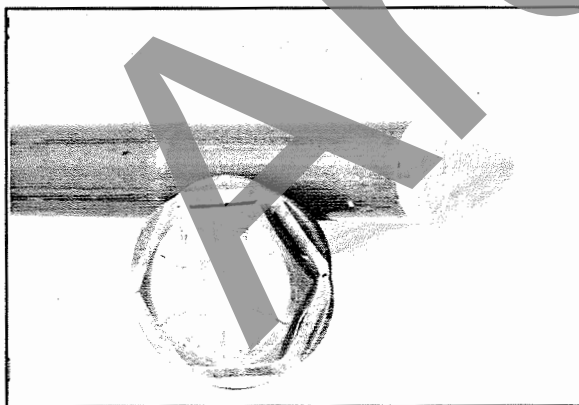

4 - 18

The end of the bolt is then chamfered by a set of rotating carbide cutting tools. Not all manufacturers chamfer or point the bolt.



4 - 19

The threads are then rolled by placing the bolt between two thread forming dies. One die moves relative to the other rotating the bolt approximately 3 1/2 turns while forming the threads.

The threaded bolts

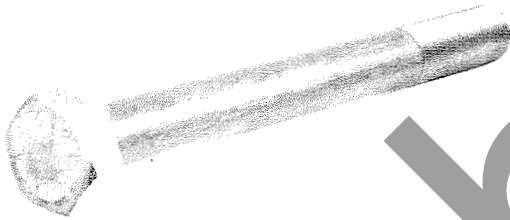

4 - 20



4 - 21

Once formed, the bolt must be hardened and tempered to produce the mechanical properties required by the standard. The bolts are fed into a controlled atmosphere furnace, heated to approximately 1600°F and held at that temperature for about 45 minutes. This operation alters the bolt microstructure. The material travels through the furnace on a continuous belt.

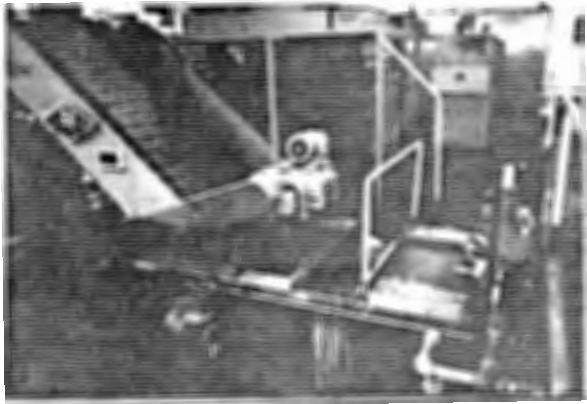

4 - 22

The bolts are then quenched in an oil or water solution. Quenching forces the bolt to cool rapidly, hardening the bolt and changing the microstructure.

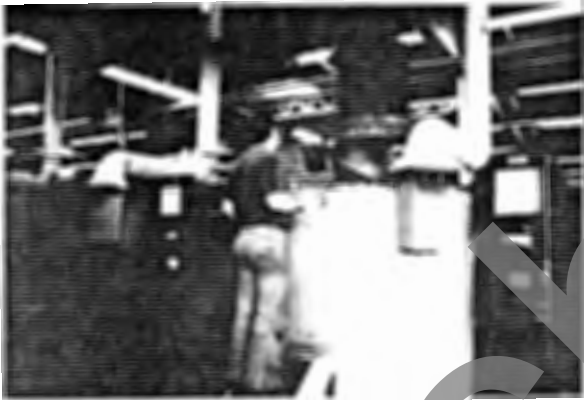

4 - 23

After quenching, the bolts are washed and loaded into the tempering furnace. They are heated to 800°F minimum and held for approximately 45 minutes. Tempering reduces hardness, increases bolt ductility and produces the strength level required by specification.

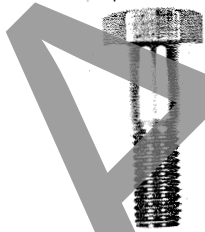

After tempering, the bolts are cooled to about 475°F. They are then drenched, usually in a water soluble oil solution to create the black heat treated finish found on non-coated fasteners. The FHWA Memorandum requires that the finish be "oily".

4 - 24



4 - 25

After testing, the bolts are ready for packaging. Some manufacturers package fasteners with the nut assembled to the bolt.

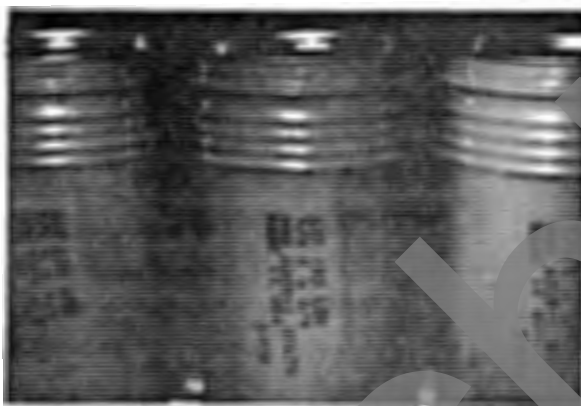

4 - 26

Shipping containers are marked with the necessary information. The container shown in Figure 4-26 does not have the Rotational-Capacity Lot No. shown and would not be acceptable for bridges.

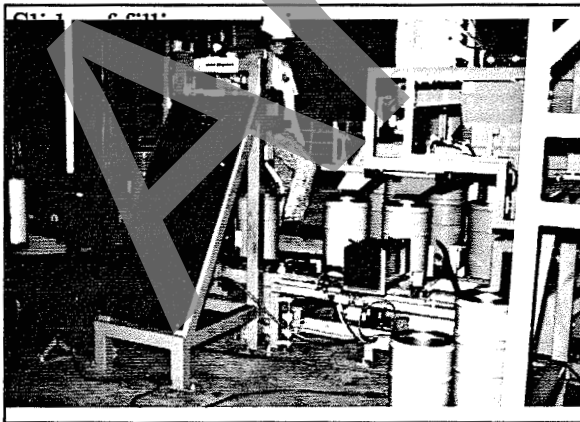

4-27

The containers are then filled.



4 - 28

... and the pails loaded on pallets for storage or shipment.



4 - 29

HOT FORGED FASTENERS

As noted earlier, bolts are either cold formed or hot forged. The previous discussion demonstrated the cold forming process.

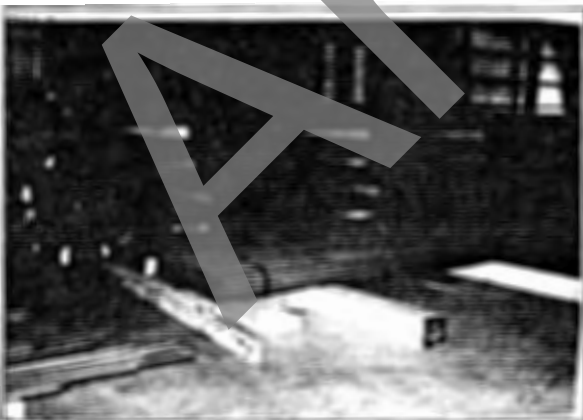

4 - 30

Larger diameter bolts, however, are often hot forged. Material for these bolts is purchased in straight bars to a finished diameter.



4 - 31

The bars are sheared to length and the ends heated to 2000°F for forging.



4 - 32

The heads are individually forged by the hot forge operator.

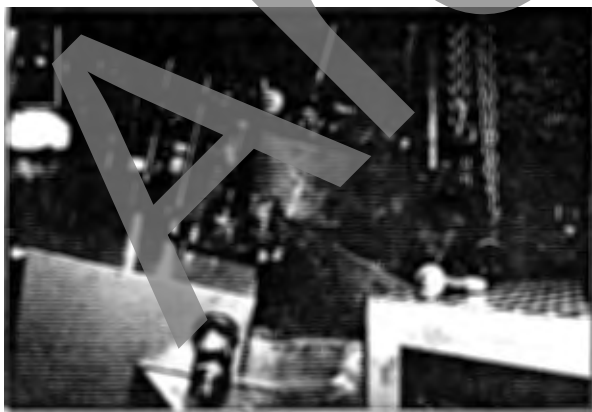

4 - 33

Threads are then either cut or rolled. Here the threads are rolled on a rotary type threading machine. The cylindrical inside forming die rotates with respect to the outside die while forming the threads.

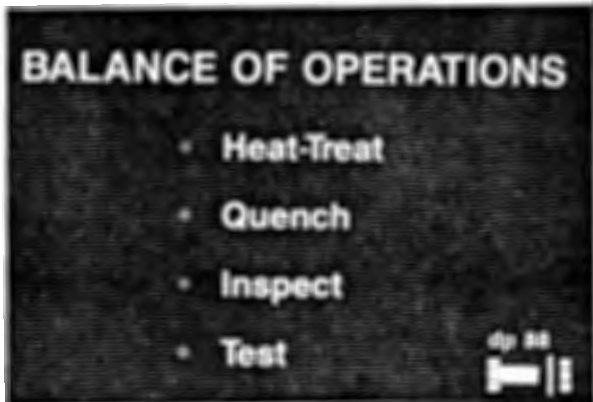

4 - 34

The remaining operations are similar to the cold forming operations, heat-treat, quench, inspect and test.



4 - 35

QUALITY CONTROL

Quality control is an essential function in all bolt manufacturing operations. Quality control consists of:

- Material traceability through various operations.
- In process testing to verify process control.
- Product testing and inspection to verify conformance to standards.
- Reporting results on the Manufacturers Certified Test Report (MCTR).



4 - 36

Traceability from the mill material through all operations to the bolts in the shipping container is required. The original Mill Test Report (tied to the heat number) and the Manufacturers Certified Test Report (tied to the production lot number) provide the record.

PRODUCTION LOT

- ④ MILL LOT
- ④ DIAMETER
- ④ LENGTH
- ④ HEAT TREATMENT LOT



A production lot number ties it all together. Unique lot numbers are assigned for each combination of mill lot, bolt diameter, bolt length and heat-treatment lot. A typical production lot could contain as many as 30,000 pieces.

4 - 37



In process control is applied at various stages of the production cycle. Periodically dimensions and tolerances are checked for conformance to standards.

The outside diameter is checked with a micrometer.

4 - 38

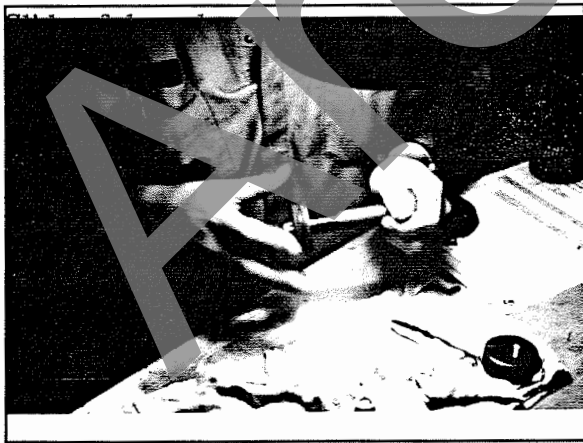

Bolt threads are checked with a ring gage.

4 - 39

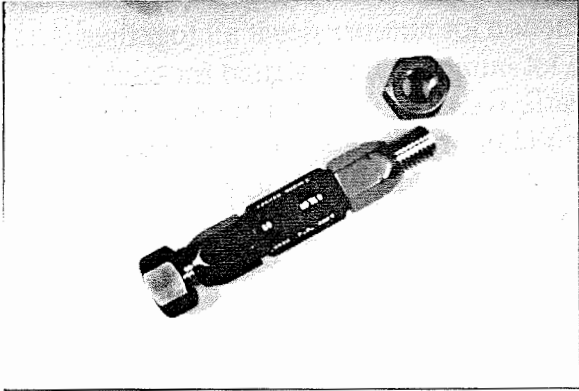

Nut threads are checked with a go/no-go gage.

4 - 40

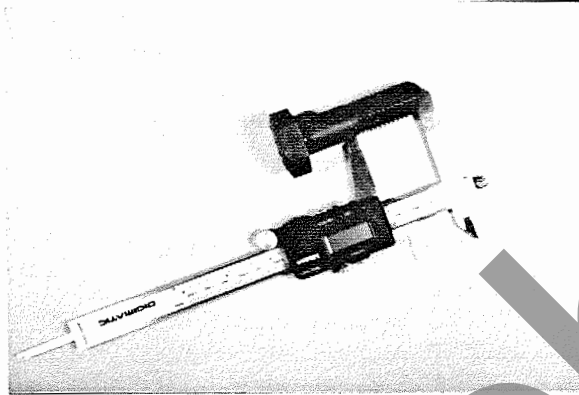

Thread lengths are checked.

4 - 41



In-process hardness tests are performed at regular intervals.

4 - 42

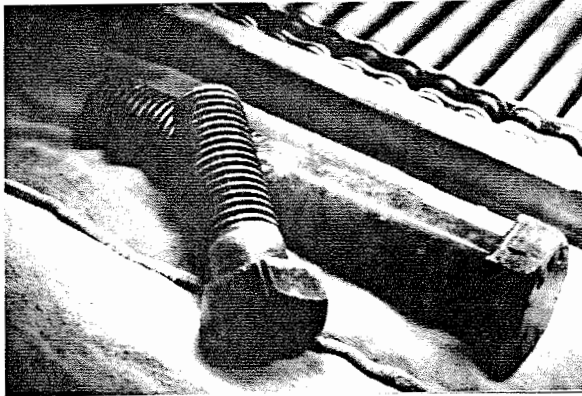

4 - 43

In-process magnetic particle inspection may be performed for discontinuities. For A490 bolts, magnetic particle inspection is required. The bolts are magnetized, covered with a special magnetic solution, and viewed under a black light. Defects such as cracks and seams will show up as a vivid yellow line.



4 - 44

Samples from each production lot are tested in accordance with appropriate ASTM, AASHTO or FHWA requirements. Results of all tests are recorded on the Manufacturers Certified Test Report (MCTR). Typical tests include hardness tests, wedge tensile tests, proof load tests and rotational capacity test.

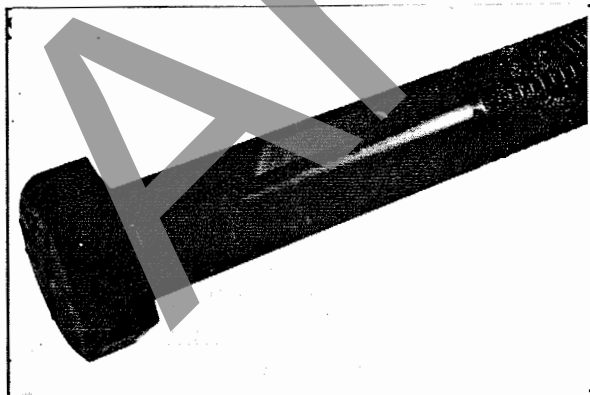

4 - 45

Typical hardness tests may be made on ends, wrench flats or unthreaded shanks.

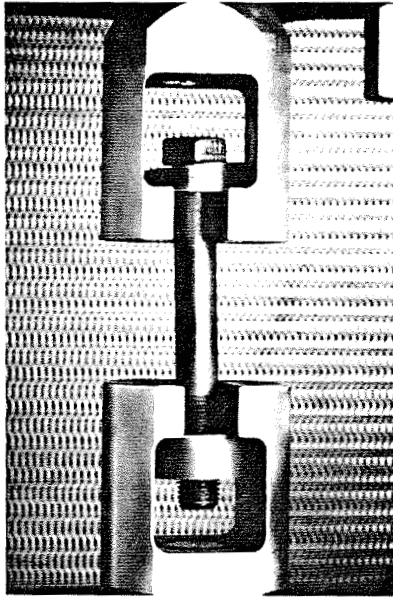

4 - 46

Wedge tension tests demonstrate bolt strength, ductility, and integrity of the head/shank junction. The tapered wedge adds significantly to the severity of the test.

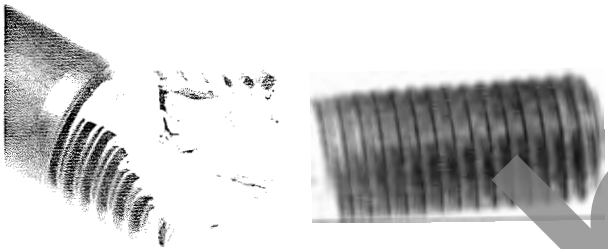

4 - 47

Wedge tension test failure must occur in the body or threaded section of the bolt. It may not occur at the head/shank junction, in spite of local bending due to the tapered wedge.

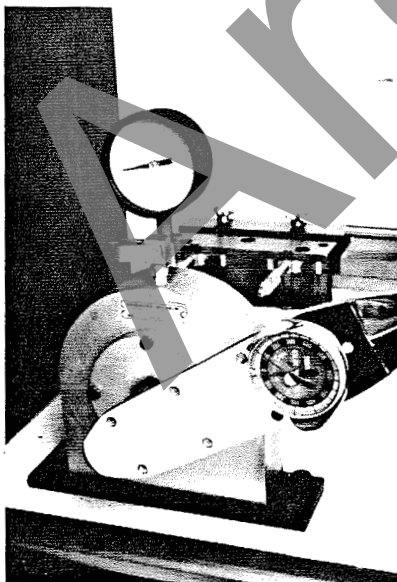

4 - 48

Rotational capacity tests demonstrate the presence and efficiency of lubricant, functional thread fit between the nut and bolt, and the assembly's capability to be preloaded.

A rotational capacity lot number is assigned to the bolt/nut combination after the rotational capacity test has been performed. Bolts and nuts that have been tested may then be shipped together in the same container. When nuts and washers are from singular production lots, they may be packaged separately, provided each R-C lot number is identified on the container.

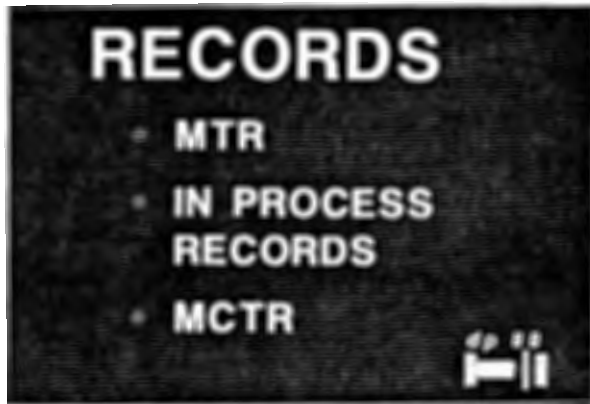

4 - 49

Results of all tests are recorded or reported on various forms:

- Mill Test Report (MTR)
- In Process Records or
- Manufacturers Certified Test Report (MCTR)

4 - 50

The Mill Test Report is furnished by the mill supplier. It contains records of mill heat number and chemical test results.

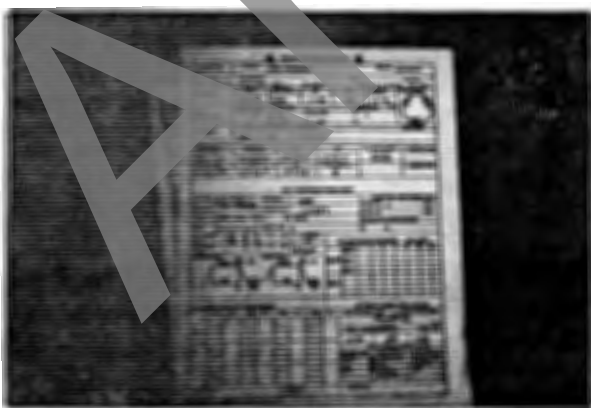

4 - 51

In-process records include the results of in process tests.



Continuous record of furnace temperature.

4 - 52

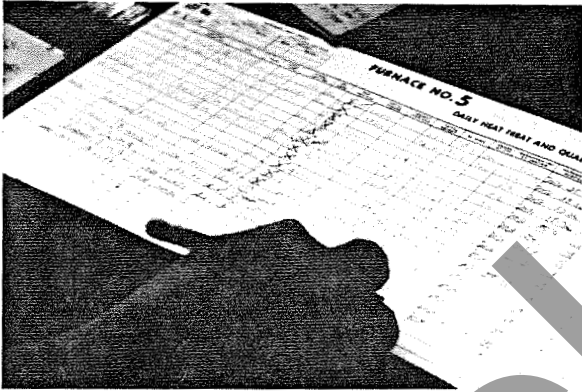

Test results and furnace loadings.

4 - 53



Heat Treatment Log.

4 - 54

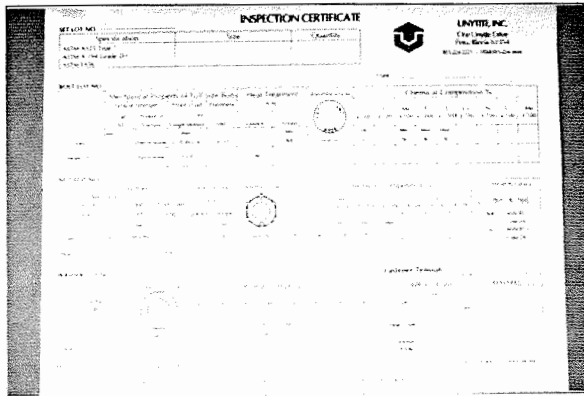

4 - 55

The Manufacturer Certified Test Report (MCTR) contains the balance of all information, including the results of all tests required by the pertinent specification. Documents (MTR & MCTR) are delivered to the customer with the shipping container or by mail, depending on customer requirements.

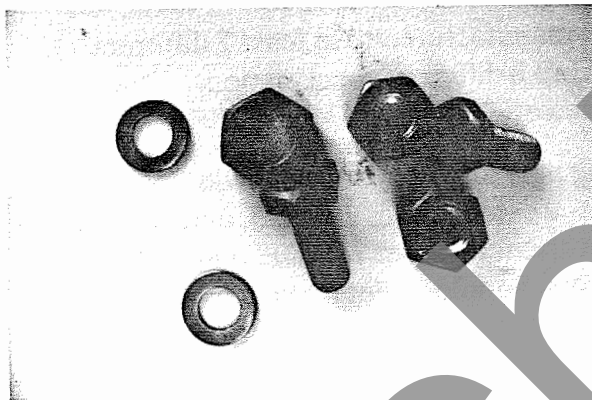

4 - 56

PRODUCT MARKING

The ASTM Specifications require that all parts of the fastener assembly be distinctively marked. The marking operation is an integral part of the forming or forging procedure. Marks may be either raised or depressed, depending on the product. If nuts are marked on the bearing face, the marks shall be depressed.

TYPE	A505		A490	
	BOLT	NUT	BOLT	NUT
1				
2				
3				

4 - 57

Certain markings are mandatory, while others are optional. The commentary to the RCSC Bolt Specification shows these in more detail. Marking with a symbol identifying the manufacturer is mandatory. The appendix contains a document, IFI-I22, that identifies the various manufacturers' symbols.

**A325 (M164)
BOLT TYPES**

TYPE 1 MEDIUM-CARBON
1/2" TO 1 1/2"

TYPE 2 LOW-CARBON
MARTENSITE
1/2" TO 1"

TYPE 3 WEATHERING
1/2" TO 1 1/2"

dp 88



4-58 - Type 2 - Withdrawn
from ASTM 11/92

MATCHING NUTS

A325 (M164)	A 563 (M291)	A194 (M292)
TYPE 1 & 2 PLAIN	C, C3, D, DH & DH3	2, 2H
TYPE 1 & 2 GALV.	DH & DH3	2H
TYPE 3	C3, DH3	-

dp 88



4-59

FASTENERS

- UNCOATED (BLACK)
- COATED

dp 88



4-60

FASTENER TYPES

The A325 specification allows for the manufacture of bolts from three different types of material. Type 2 material has been a problem and domestic manufacturers no longer use it. The 1991 ASTM specification will probably eliminate that grade. Type 1 bolts are those that are used in most typical installations. Type 3 bolts are corrosion resistant for use in unpainted A588 structures. They may, however, be used in lieu of type 1 bolts.

Nuts are manufactured to at least 7 different grades from 2 different specifications. The two specifications are A563 and A194.

Matching nuts for A325 bolts include non-heat-treated grades 2, C, C3, and D, plus heat-treated grades 2H, DH and DH3. The FHWA Supplemental Specification requires that grades 2, C, C3 and D meet special minimum hardness requirements when used for bridges.

Galvanized nuts must be heat-treated grades 2H, DH or DH3.

COATED FASTENERS

Additional processing, such as coating the bolts, may be performed by the manufacturer or the subcontractor. A325 fasteners may be either coated or uncoated (black). The purchaser must specify the type of fastener required. Normally, the coating used for coated fasteners is zinc.

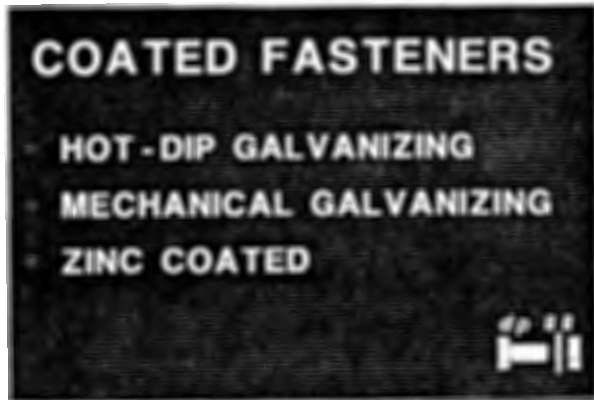

4 - 61

The A325 specification specifically refers to two processes for zinc coated fasteners, hot-dip and mechanically galvanized. Other methods of applying the zinc coatings are available.



4 - 62

The hot-dip galvanizing process comprises a four step procedure:

- Clean
- Immerse in molten zinc
- Spin to remove excess zinc
- Quench to harden the zinc



4 - 63

After cleaning in a pickling bath, the material is dipped in molten zinc. The temperature of the molten zinc is 850°F. Bolts typically remain in the molten zinc for 5 to 10 minutes, depending on the weight of material in the bucket.



4 - 64

Upon removal from the molten zinc, the material is spun in an enclosed kettle to remove excess zinc from the threads.

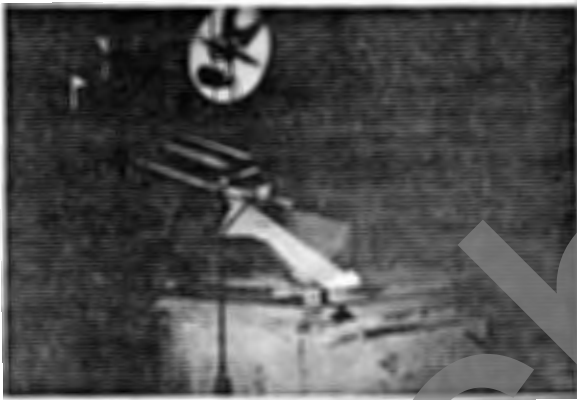

4 - 65

After spinning, the product is dumped into a water quench tank to complete the process.

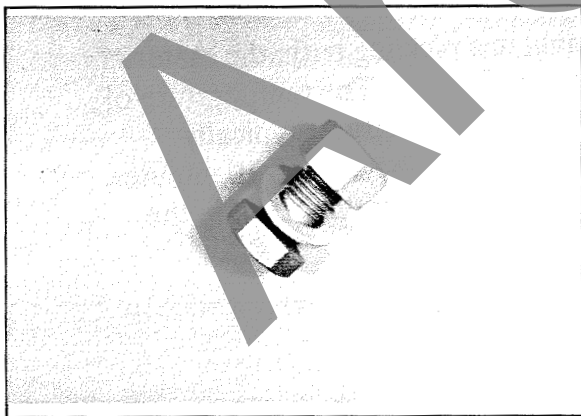

4 - 66

The process is now complete.



4 - 67

Another popular method of coating bolts is the mechanical galvanizing process. Mechanical galvanizing is a cold process where the coating is applied by an impacting process. Proprietary chemicals, glass impact media, and metal powders are rotated in an open barrel along with parts to be coated.



4 - 68

Process advantages include low hydrogen embrittlement possibilities, low energy usage, and simplified disposal of waste products.

MECHANICAL PLATING & GALVANIZING

- No hydrogen embrittlement
- Product reliability, no rejects
- Room temperature operation
- Safe working environment
- No cyanides or complexing chemicals
- Proven and approved by local, state, federal and international agencies.

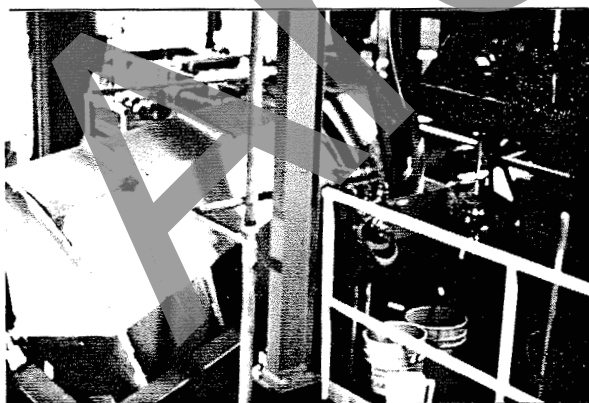

4 - 69

Most of the work takes place in this rubber-lined barrel. The process includes:

- Soil or scale removal
- Surface preparation
- Plating
- Separation and drying

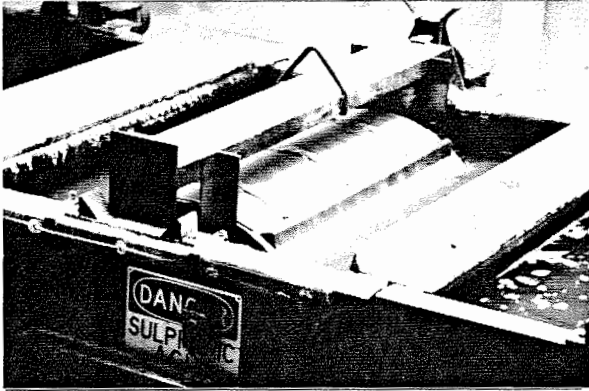

Parts are first cleaned in a sulfuric acid bath.
They are then loaded into the barrel.

4 - 70

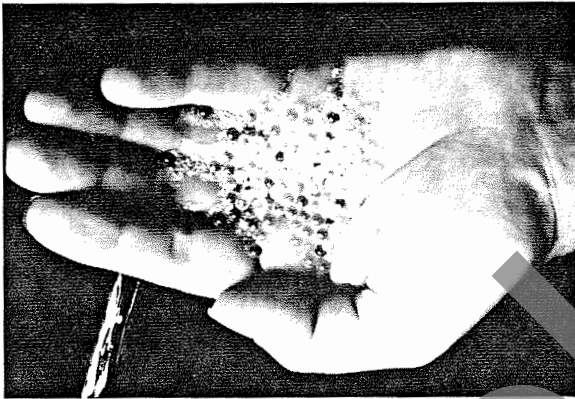

The impact medium of glass beads is added.

4 - 71

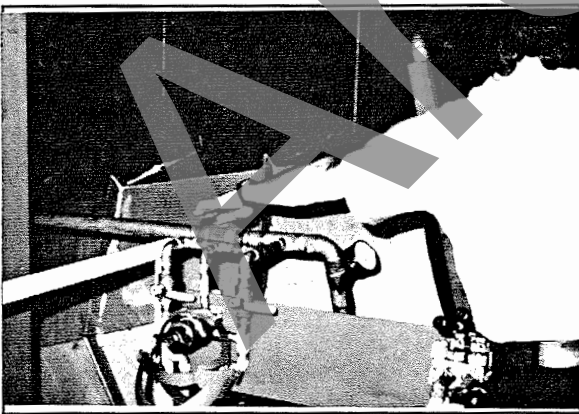

Tempered water is added.

4 - 72



4 - 73

Surface conditioners are then added to the rotating barrel where the cleaning and surface preparation take place.



4 - 74

The zinc powder is then added. The zinc particles are cold welded onto the parts by the many impingements of the small glass beads under pressure from the overlying parts.



4 - 75

The main component is the rubber lined rotating barrel with sizes ranging from 1 to 30 cubic feet. After plating, the mixture of parts and media are dumped into a hopper. The hopper then dumps the material on a vibrating screen or magnetic belt, allowing the media and plated bolts to separate. The bolts are then dried and the media, after some treatment, is reused.



4 - 76

This is the mechanically galvanized product.

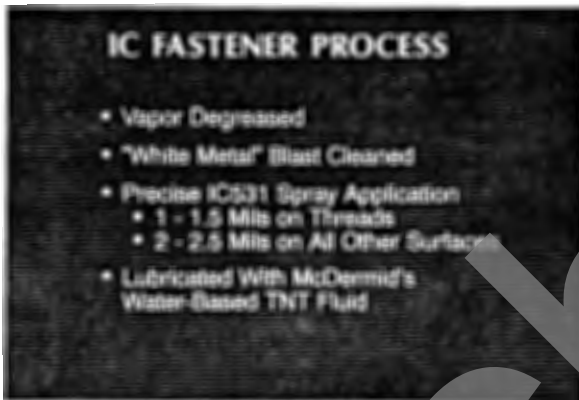

4 - 77

A third type of coated bolt is the spray coated fastener. In this procedure the fastener is cleaned, abrasive blasted, spray coated and lubricated.

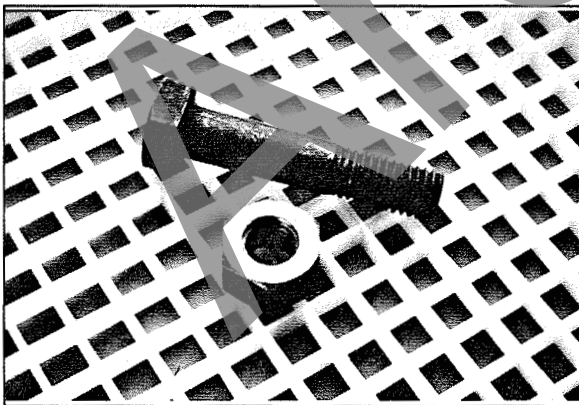

4 - 78

The product is degreased in a three-step process.

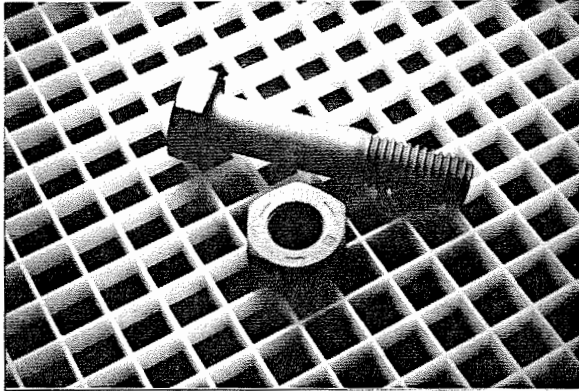

4 - 79

The fastener is then blasted to a “white metal” specification using a fine grit.

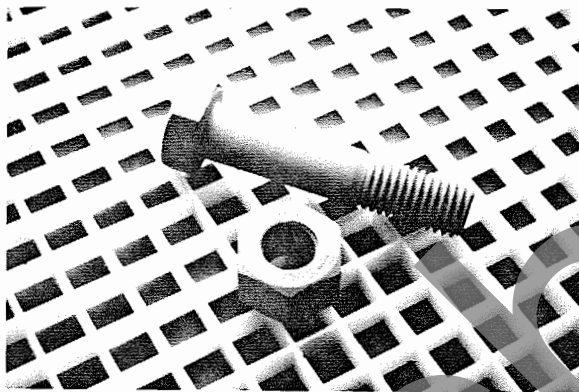

4 - 80

It is then coated with a high-ratio zinc silicate and lubricated.

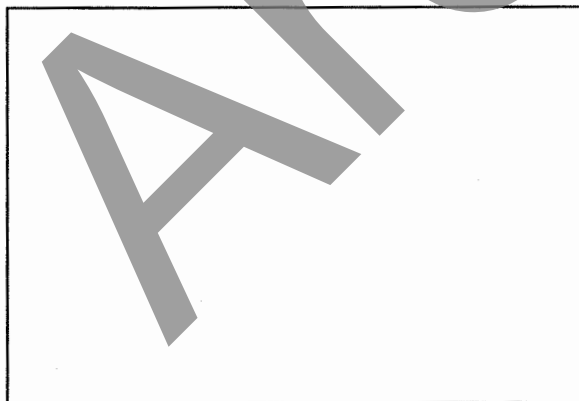

4 - 81

Obviously, there is much more that can be presented relative to fastener manufacturing processes. Twist-off bolts, nuts, washers and DTIs have not been addressed. The foregoing, however, should at least provide some insight into the number and complexity of the manufacturing operations involved as well as the quality controls required to produce a specification-conforming product.

Archived

Session 5

Receipt Inspection, Storage, Pretest, Review of MTD



5-1

RECEIPT INSPECTION

This session describes specification requirements and inspector responsibilities for job site operations. Material is also applicable to fabrication shop bolting operations.

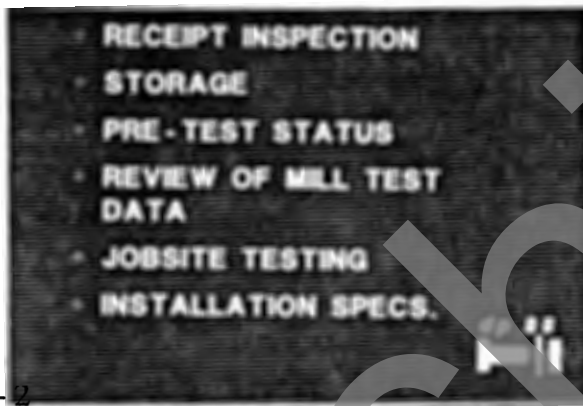

5-2

The areas shown in Slide 5-2 are to be discussed in this section of the course.

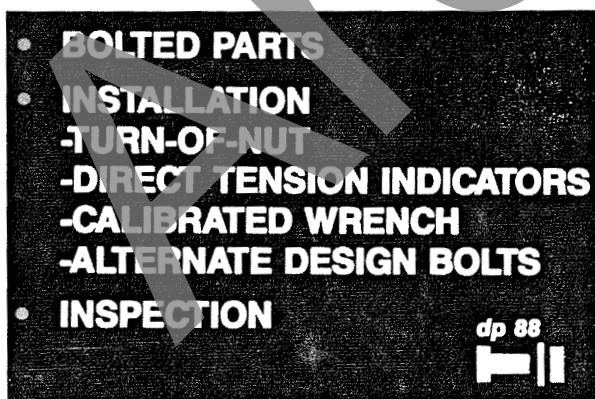

5-3

Additional topics are shown in Slide 5-3.

RECEIPT INSPECTION



5 - 4

When properly performed, receipt inspection can help to eliminate future installation problems.

CONTAINER INFORMATION

- MANUFACTURER IDENTIFICATION
- CONTENTS
- COMPONENT LOT NUMBERS
- ROTATIONAL - CAPACITY LOT NUMBERS



5 - 5

Inspect containers for the information shown in Slide 5-5. Record data for comparison to test reports.

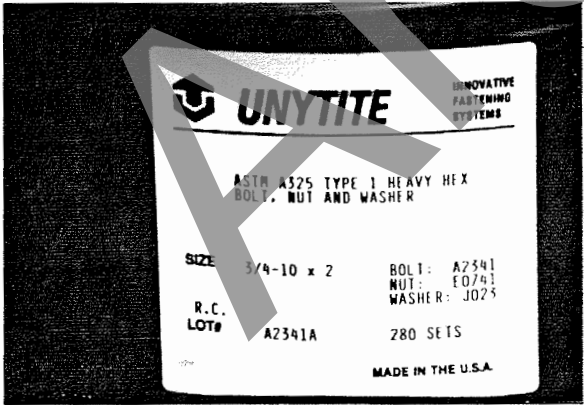

5 - 6

All previously mentioned data must be easily recognizable and permanently marked. Bolts, nuts and washers must be in the same shipping container, except where there is only one production lot number for each size of nut and washer. Watch for shipping damage and possible contamination.

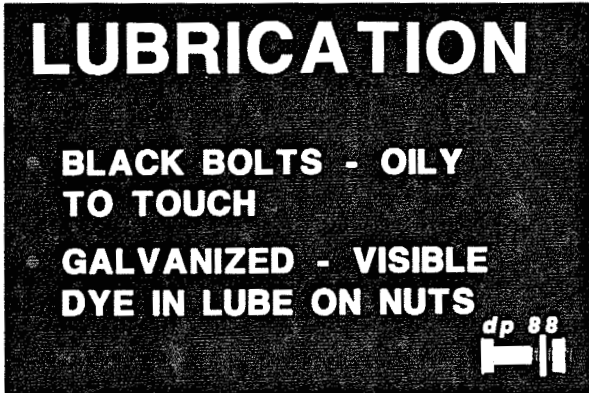

5-7

Black bolts must be oily to the touch. For galvanized fasteners, the nuts must be lubricated with a material that is clean and dry to the touch, and must contain a visible dye for easy identification.

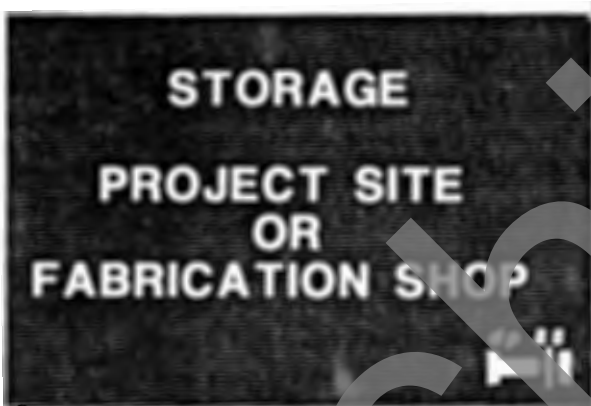

5-8

STORAGE

Fasteners must be protected from dirt and moisture at all times. Lubricant on black fasteners will hold dust. Cover to protect from rain, snow or dew. Plastic sheeting over containers and sealed to ground will cause fasteners to sweat. Provide adequate ventilation.



5-9

Keep away from grease or oil. Store all fasteners in original containers and return unused fasteners to maintain lot identification. Remove only enough fasteners for use on one work shift.

PRE - TEST STATUS

dp 88

5 - 10

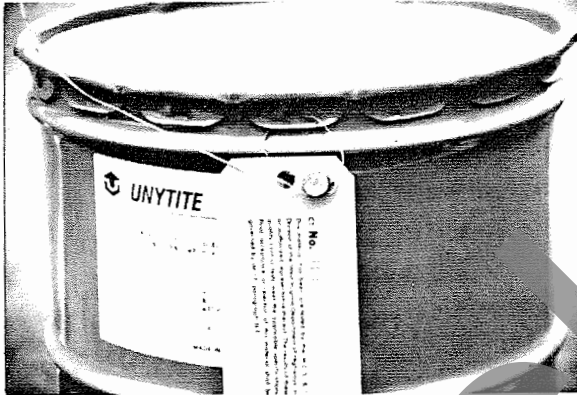

5 - 11

REVIEW OF TEST DATA

dp 88

5 - 12

PRE-TESTING

Many State DOTs have procedures which require tests to be conducted at the producer's plant and witnessed by a DOT inspector or consultant inspector. Others sample material at the plant and conduct tests in the DOT laboratory.

Where this is done, most DOTs identify containers with a tag or stamp to show project site inspectors that the fasteners have been approved for use. Inspectors on project site or in the fabrication shop must be aware of appropriate QA system used by DOT and verify materials are approved.

REVIEW OF TEST DATA

AND REPORTS

In many cases, fasteners are not inspected at their source, and the job site or fabrication shop inspector must review test data and decide if the fasteners are acceptable. This portion of the course will review the documents necessary for ensuring the quality of nuts, washers, and bolts.

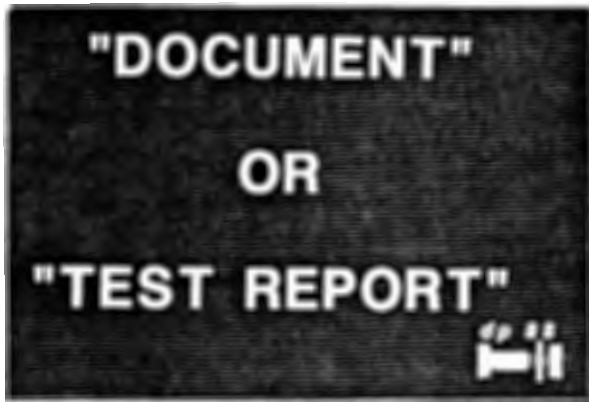

5 - 13

The results of all tests are to be recorded on the appropriate document. Selection of the format is up to the manufacturer and customer (DOT). The document must identify the location and the date of the test. Tests need not be witnessed by an inspection agency. The manufacturer or distributor that performs the tests shall certify that results are accurate.

- Mill Test Report (MTR)
- Manufacturer Certified Test Report (MCTR)
- Distributor Certified Test Report (DCTR)

5 - 14

FHWA Supplemental Contract Specs. make reference to three types of test reports.

We will discuss each in detail and outline their uses and test data requirements.



5 - 15

A mill test report is prepared by the steel manufacturer to document properties of mill steel used to manufacture bolts, nuts and washers. Material may be purchased by the fastener manufacturer to chemistry only to allow for proper heat treating of component. The MTR can be used to verify specification compliance for chemistry only, as all other tests are required on the finished product.

MTR CONTENT

- STEEL PRODUCER'S FORM
- HEAT NUMBER
- CHEMICAL ANALYSIS
- LOCATION - MELT & MADE
- LOCATION - TESTS CONDUCTED
- DATE OF TESTS



5 - 16

MTRs must be from the steel producer, on the test report, not copied onto the fastener manufacturer's test report. The MTR must document heat number, analysis, place where steel was melted and manufactured, location where the tests were performed and date of the tests. "Place where steel melted" may note "country only," but, city and state location are recommended. When Type 3 (weathering steel) components are specified, the MTR shall identify to which class (composition) the steel was manufactured. Explain.

MANUFACTURER CERTIFIED TEST REPORT (MCTR)

PREPARED BY BOLT, NUT OR WASHER MANUFACTURER TO DOCUMENT PHYSICAL TEST RESULTS PERFORMED ON FINISHED PRODUCT.



5 - 17

The Manufacturer Certified Test Report is prepared by the bolt, nut or washer manufacturer to document the results of physical tests performed by the manufacturer.

MCTR CONTENT

- MILL HEAT NUMBERS
- FASTENER MANUFACTURER LOT NUMBERS
- MULTIPLE TEST RESULTS DEPENDING UPON QUANTITY



5 - 18

The MCTR must document the heat number of the steel used to manufacture the product so that traceability is provided back to the MTR. The lot number assigned by the fastener manufacturer must be shown. AASHTO material specifications may require several physical tests of each component, depending upon quantity of each lot number. The MCTR must document all tests required.

BOLT TESTS

- PROOF LOAD - METHOD 1
- TENSILE TEST - WEDGE
- SHORT BOLTS - HARDNESS ONLY



5 - 19

Proof load (Length Measurement Method, ASTM F606 Method 1) tests are required. Method 2 (Yield Strength) or Method 3 (Uniform Hardness) are not acceptable. Wedge tensile tests are required on all bolts long enough for tensile tests. Hardness tests are required for all bolts, and are in lieu of tensile tests for bolts less than 3 diameters long.

BOLT TESTS

(CONT.)

TENSION TEST OVERRIDES
LOW HARDNESS RESULT



5 - 20

For bolts on which hardness and tension tests are performed, acceptance based on tensile requirements shall take precedence over low readings on hardness tests.

GALVANIZED BOLT TESTS

- ALL MECHANICAL TESTS AFTER GALV.
- GALV. THICKNESS TESTS BY BOLT MANUFACTURER
- ROTATIONAL-CAPACITY TESTS



5 - 21

When bolts are galvanized, all mechanical tests must be done after galvanizing. Coating thickness measurements must be made by the bolt manufacturer and reported on the MCTR. Rotational Capacity tests required by AASHTO M164 (ASTM A325) are to be conducted and reported by the bolt manufacturer. These tests are not to be superseded by R-C tests as described later in this course.

NUT TESTS

- PROOF LOAD - MANDATORY
- GALV. - TEST AFTER GALV. OVERTAP & LUBE
- GALV. THICKNESS TESTS BY MANUFACTURER



Proof load tests (ASTM F606 paragraph 4.2) are mandatory for all nut sizes and grades. If nuts are galvanized, tests must be conducted after galvanizing, overtapping, and lubricating. The coating thickness must be verified by the nut or bolt manufacturer and reported on the MCTR.

5 - 22

WASHER TESTS

- GALV. - HARDNESS AFTER GALV.
- GALV. - THICKNESS TESTS BY MANUFACTURER



If the washer is galvanized, hardness tests must be made after galvanizing. Coating thickness must be verified by the washer or bolt manufacturer and reported on the MCTR.

5 - 23

ROTATIONAL - CAPACITY TESTS

- COMPONENT LOT NUMBERS
- ROTATIONAL - CAPACITY LOT NO.
- TEST LOCATION & DATE
- COMPONENT MANUF. LOCATION
- CERTIFICATION STATEMENT



When R-C tests are conducted by the component manufacturer, test results must show on the MCTR. Lot numbers for each component and resulting R-C lot must be documented. The test frequency is two tests per R-C lot. The MCTR must document the location and date of the R-C tests as well as the location where the assembly components were manufactured. The MCTR must contain a certification statement that MCTRs for component materials conform with FHWA specifications and AASHTO specifications.

5 - 24

DISTRIBUTOR CERTIFIED TEST REPORT (DCTR)

CONCEPT DEVELOPED TO ALLOW A DISTRIBUTOR (WAREHOUSE) TO BUY BOLTS, NUTS & WASHERS AS INDIVIDUAL COMPONENTS AND SELL AS AN ASSEMBLY.



5 - 25

The Distributor Certified Test Report is prepared by the fastener distributor to document R-C tests and R-C lot numbers. All components must be lot identified on all containers. MCTRs and MTRs must be supplied for all components.

DCTR CONTENT

- FASTENER MANUFACTURER LOT NUMBERS
- DISTRIBUTOR ASSIGNED ROTATIONAL-CAPACITY LOT NUMBERS
- ROTATIONAL-CAPACITY TEST RESULTS
- LOCATION & DATE OF ROTATIONAL-CAPACITY TEST (S)
- CERTIFICATION STATEMENT

5 - 26

All component lot numbers must be documented, including the R-C lot. The test frequency is two assemblies per R-C lot. The DCTR must document location and date of test. The DCTR must contain a certification statement that the MCTRs for all component items conform with FHWA and appropriate AASHTO material specifications. If the distributor has components galvanized from stock, all physical tests must be re-conducted at proper frequency and reported on the DCTR. The coating thickness must be verified by the distributor.

Archived

Session 6

Jobsite Rotational-Capacity Testing



6-1

Now that the fasteners are on the job site or fabrication shop floor, have been inspected, and are stored properly with MTRs, MCTRs, and DCTRs reviewed and accepted, the contractor now wants to install them. What tests, if any, must be performed?

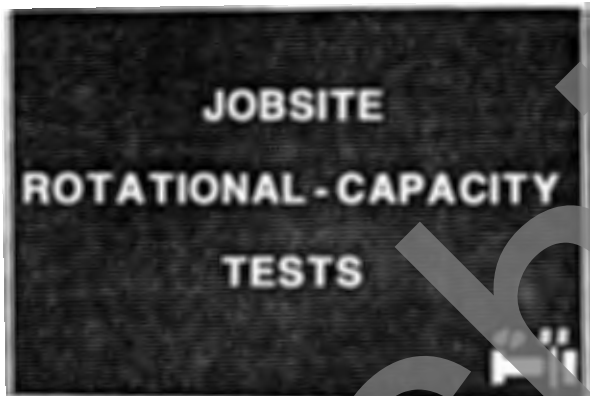

6-2

FHWA specifications require the R-C test to also be conducted on the project site or at the point where installation takes place. The test should be performed immediately prior to starting installation so that the test will judge the effects of shipment and storage on fastener lubrication. The tests are to be as per AASHTO M164 except as modified by FHWA specifications.

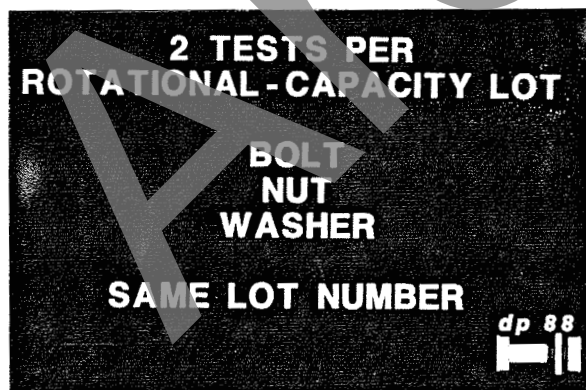

6-3

R-C tests must be performed at the rate of two tests per R-C lot as shown on shipping containers. The bolt, nut and washer must have the same R-C lot number and be packed in the same container (except in special cases where nuts and washers have only one production lot number for each size).

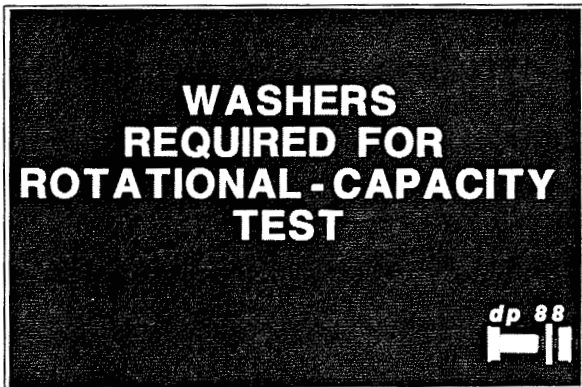

6 - 4

Washers are required for the R-C tests even though they may not be required for job-site installation. Where washers are not required for job-site installation, lot identification (both manufacturer and R-C) is not required. Washer coating should be the same as in the bolt and nut. All R-C tests are to be performed by the contractor/fabricator and should be witnessed by the DOT inspector.



6 - 5

Equipment required to conduct R-C test is as follows.

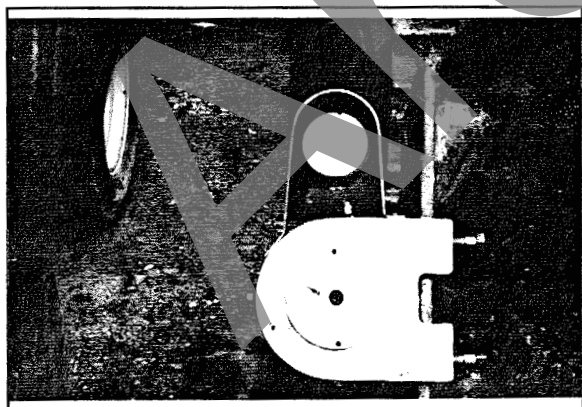

6 - 6

Skidmore-Wilhelm Bolt Tension Calibrator or equivalent tension measuring device. Calibration within the last year.

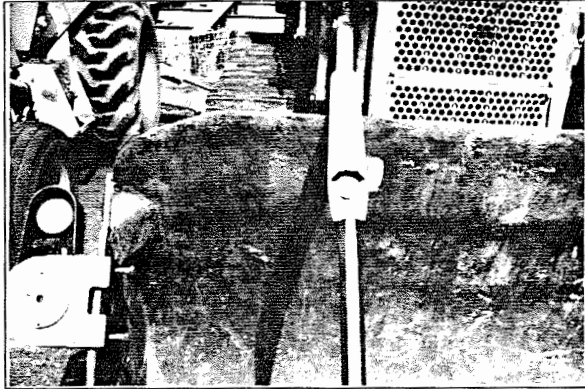

6-7

Standard torque wrench. Calibration within the last year. 1000 ft-lb capacity will cover most bridge situations. May require 2000 ft-lb. wrench for 1 1/4 inch-diameter bolts and larger or a torque multiplication device may be used.

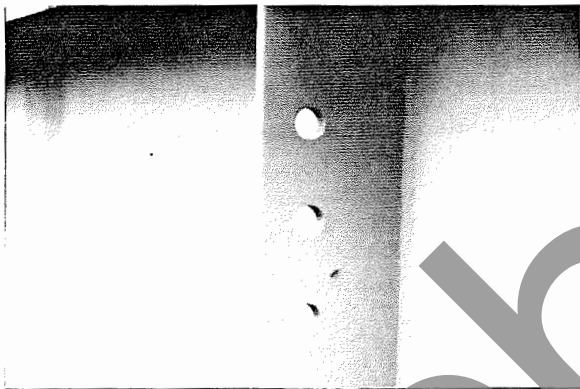

6-8

Suitable steel joint to conduct tests on short bolts. The plate thickness is governed by bolt length. Plate can be 1/2 inch to 1 inch and use shims to adjust for bolt length. The hole size in the plate is 1/16 inch over bolt diameter.

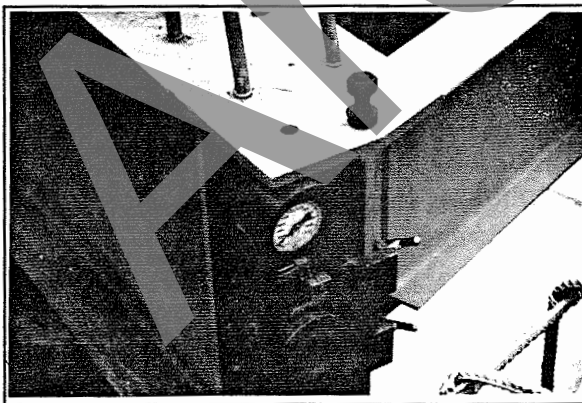

6-9

The bolt tension calibrator and steel joint must have rigid mounting as larger-diameter bolts generate extremely high torque numbers.

ROTATIONAL - CAPACITY TEST PROCEDURES

6 - 10

The R-C test is to be in accordance with AASHTO M164 paragraph 6.5 as modified by the FHWA specification.

Select two bolt, nut, and washer assemblies from each R-C lot as shown on shipping containers. Washers must be used on all R-C tests. The coating on washers must be same as on bolt and nut.

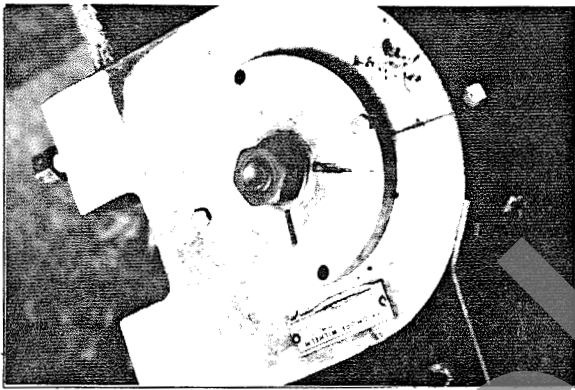

6 - 11

For bolts long enough to fit the bolt tension indicator, install bolt, nut, and washer with additional face plates and shims to position three to five threads in the steel plates. Install finger tight.

TABLE D4.1g

DIA. (IN.)	3/8	1	1 1/8
REQ. INSTALL. TENSION (KIPS)	38	51	58
TURN TEST TENSION (KIPS)	45	59	64

6 - 12

Tighten nut to 10% of specified minimum installation tension. This is a portion of Table D4.1g from the FHWA specification. Explain information. Required installation tension is equal to the proof load tension test requirement of AASHTO M164 (ASTM A325) and is 70% of the minimum specified tensile strength of the bolt.

TABLE D4.1f

ROTATION	BOLT LENGTH
240° (2/3 TURN)	≤ 4 DIA.
360° (1 TURN)	> 4 & ≤ 8 DIA.
480° (1 1/3 TURNS)	> 8 DIA.

dp 88

6 - 13

Mark the socket on the nut to reference the point on Skidmore-Wilhelm or shim plates, and rotate the nut as per this chart. Explain chart. Tighten the nut with an air wrench or torque wrench. These rotations are two times required AASHTO Bridge Code rotation for turn-of-nut installation and are not the same rotational requirements as shown in AASHTO M164.

TABLE D4.1g

DIA. (IN.)	7/8	1	1 1/8
REQ. INSTALL. TENSION (KIPS)	38	51	58
TURN TEST TENSION (KIPS)	45	58	65

dp 88

6 - 14

The minimum tension induced into the bolt at the specified rotation shall be equal to or greater than 1.15 times the minimum required installation tension. Table D4.1g has minimum values required and is called Turn Test Tension. Explain numbers.

T ≤ 0.25 PD

WHERE:
T = MAX. ALLOWABLE TORQUE
P = "TURN TEST TENSION" FROM TABLE D4.1g
D = BOLT DIAMETER (FT.)

dp 88

6 - 15

At any point after the required minimum installation tension has been exceeded, one reading of tension and torque shall be taken and recorded. The torque value shall not exceed value calculated from this formula. The readings should be taken as close as possible to the minimum installation tension:

P = Measured Bolt Tension

FAILURE

1. INABILITY TO ACHIEVE REQUIRED ROTATION
2. SHEAR FAILURE OF THREADS
3. TORSION FAILURE OF BOLT

dp 88

6 - 16

Upon completion of required rotation, the assembly must show no signs of failure.

Failure is defined as follows:

- Inability to assemble to the nut rotation specified in Table D4.1f or by an inability to remove the nut following the test,
- Shear failure of threads as determined by visual examination of bolt and nut threads following removal, and
- Torsional failure of the bolt.

Elongation of bolt, in the threads between the nut and bolt head, is to be expected at the required rotation and is not to be classified as a failure.



6 - 17

Bolts that are too short to be assembled in a Skidmore-Wilhelm may be tested in a steel joint. Plate thickness is adjusted by steel shims with proper hole size. Minimum turn test tension does not apply as we have no way to measure tension. The maximum torque requirement, using torque formula, is computed using value for P equal to the Turn Test Tension from Table D4.1g.

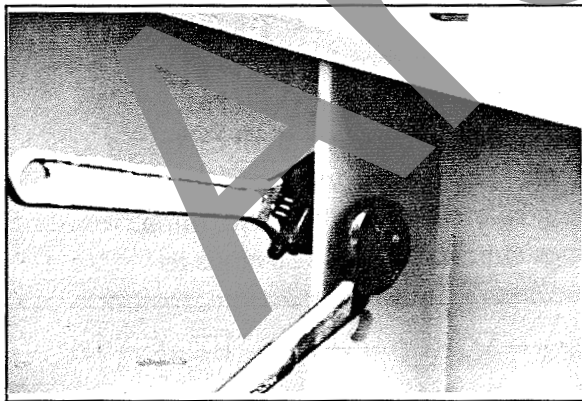

6 - 18

The test procedure essentially same as with the Bolt Tension Calibrator.

- 1 - Install bolt with appropriate shims to place three to five threads in steel plate.
- 2 - Install nut and washer. Prevent bolt head from turning at all times.
- 3 - Tighten nut snug tight using same effort (torque) required to reach 10% on R-C tests done in Skidmore.



6 - 19

- 4 - Mark socket to reference point on steel plate and turn nut to the minimum rotation required for turn-of-nut installation.
- 5 - Using a calibrated torque wrench, re-start the nut in tightening direction and record torque.

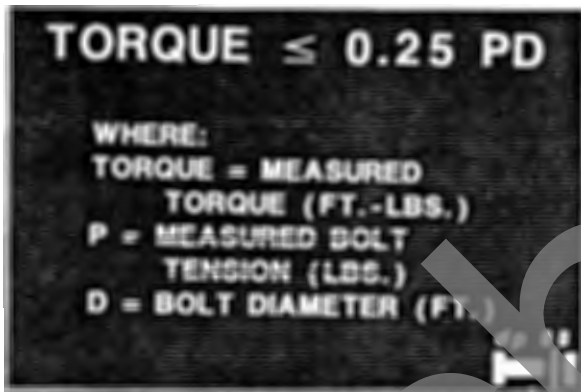

6 - 20

- 6 - Torque cannot exceed value calculated from this formula. P value used in this calculation is the "turn test tension" from table D4.1g of FHWA memo.

P = turn test tension

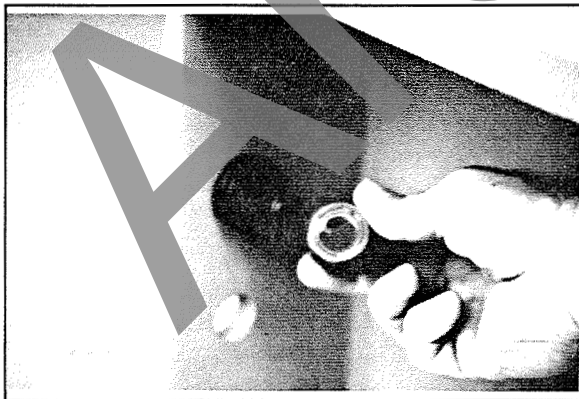

6 - 21

- 7 - Nut and bolt must be free from damage as described previously.
- 8 - Test both sets of samples, both must pass test.

Archived

Session 7
Installation—General



7-1

Specifications and procedures which cover high strength bolt installation are contained in the latest AASHTO Standard Specification for Highway Bridges.



7-2

Current edition is the 14th Edition dated 1989 with Interim Specifications - Bridges - 1990. All State DOTs should follow provisions of this specification for all work.

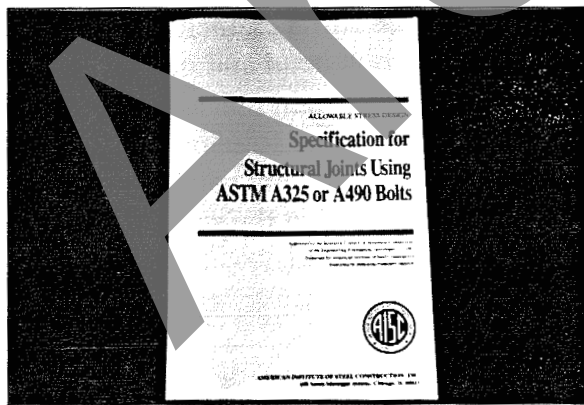

7-3

Current AASHTO specifications are very similar to the Research Council on Structural Connections (RCSC) Specification which is titled, "Specification for Structural Joints Using ASTM A325 or A490 Bolts" - 1985 edition.

AASHTO normally adopts RCSC specification requirements usually 2 to 3 years after RCSC publication.

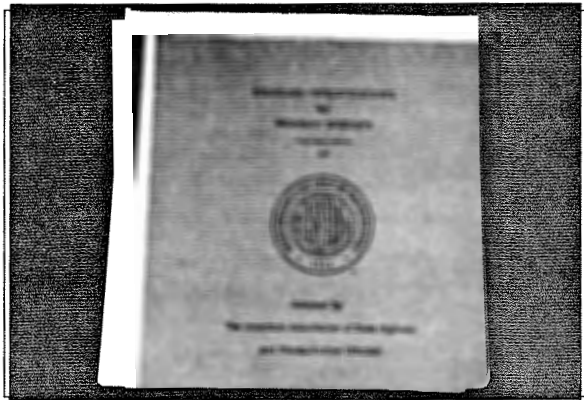

7-4

A recent FHWA memorandum will no doubt bring about several changes in AASHTO and ASTM material specifications, as well as RCSC and AASHTO installation specifications. The remainder of course material is based on AASHTO Bridge Code, 14th Edition, 1989, with Interim Specification 1990 as modified where appropriate by FHWA requirements.

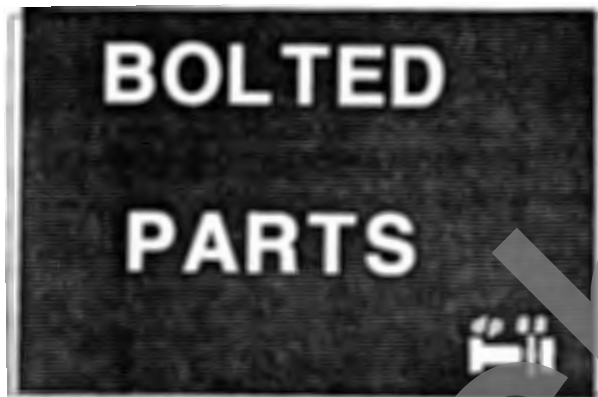

7-5

All material within the grip of the bolt shall be steel. There shall be no compressible material such as gaskets or insulation within the grip. Bolted steel parts shall fit solidly together after the bolts are tightened, and may be coated or noncoated. The slope of the surfaces of parts in contact with the bolt head or nut shall not exceed 1:20 with respect to a plane normal to the bolt axis.



7-6

When assembled, all joint surfaces, including surfaces adjacent to the bolt head and nut, shall be free of scale, except tight mill scale, and shall be free of dirt or other foreign material. Burrs that would prevent solid seating of the connected parts in the snug tight condition shall be removed.

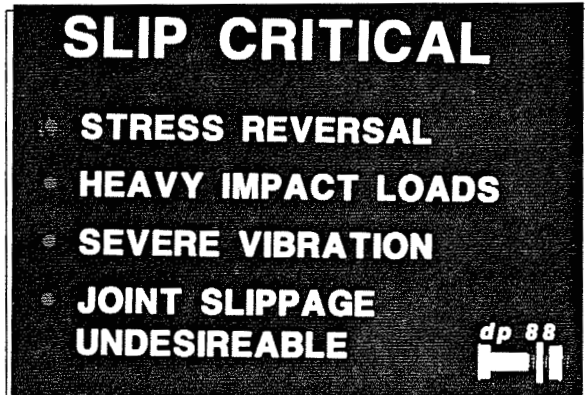

7-7

Paint is permitted on the faying surfaces unconditionally in connections except in slip-critical connections.

Slip-critical joints are defined as joints subject to stress reversal, heavy impact loads, and severe vibration where stress and strain due to joint slippage would be detrimental to the serviceability of the structure.

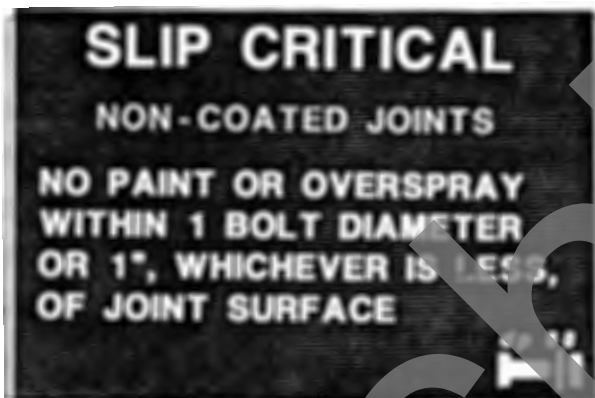

7-8

The faying surfaces of slip-critical connections shall meet the requirements of the following: In noncoated joints, paint, including any inadvertent overspray, shall be excluded from areas closer than one bolt diameter but not less than one inch from the edge of any hole and all areas within bolt pattern.

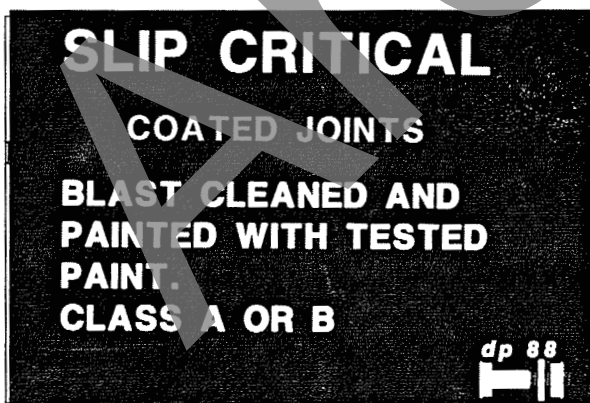

7-9

Joints specified to have painted faying surfaces shall be blast cleaned and coated with a paint which has been qualified as class A or B in accordance with the RCSC Specification for Structural Joints using ASTM A325 or A490 bolts. A lesser coefficient of friction may be approved by the Engineer. Coated joints shall not be assembled before the coating has cured for the minimum time used in qualification testing.



7 - 10

Faying surfaces specified to be galvanized shall be hot dip galvanized in accordance with ASTM Specification A123, and shall subsequently be roughened by means of hand wire brushing. Power wire brushing is not permitted.



7 - 11

The following requirements are general and are applicable to all high strength bolt installation methods.



7 - 12

Fasteners shall be protected from dirt and moisture at the job site. Only as many fasteners as are anticipated to be installed and tightened during a work shift shall be taken from protected storage. Fasteners not used shall be returned to protected storage at the end of the shift.

**PROTECT LUBRICATION
IF CLEANED AND
RE-LUBED ON JOB
ROTATIONAL-CAPACITY
TESTING IS REQUIRED**



7 - 13

Fasteners shall not be cleaned of lubricant that is present in as-delivered condition. Fasteners for slip critical connections which accumulate rust or dirt resulting from job site conditions shall be cleaned and relubricated prior to installation. Rotational capacity testing will be required after cleaning and lubrication.

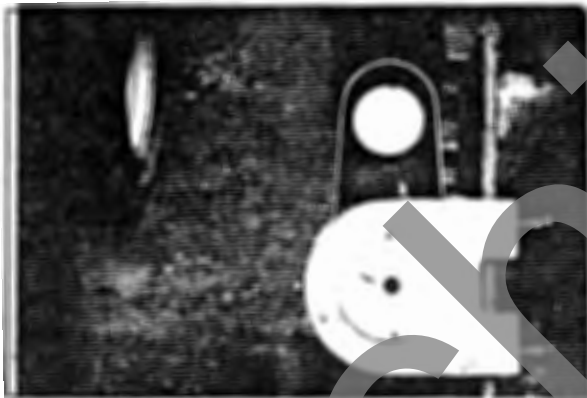

7 - 14

A tension measuring device shall be at all job sites where high strength bolts are being installed and tightened. The tension measuring device shall be used to confirm:

- The suitability to satisfy the requirements of Table 10.17A of the complete fastener assembly, including lubrication if required, to be used in the work,
- Calibration of the wrenches, if applicable, and
- The understanding and proper use by the bolting crew of the method to be used.

The accuracy of the tension measuring device shall be confirmed through calibration by an approved testing agency at least annually.

TABLE 10.17A - REQUIRED FASTENER TENSION (KIPS)*

SIZE	A325	A490
3/4	28	35
7/8	39	49
1	51	64

*APPROX. 70% OF MIN. BOLT TENSILE STRENGTH



7 - 15

Fasteners, including washers, when required, shall be tightened to at least the minimum tension specified by Table 10.17A by Turn-of-Nut, Calibrated Wrench, Alternate Design Bolt or Direct Tension Indicators.

Complete table is contained in Appendix.

**TIGHTEN BY TURNING
NUT OR
BOLT HEAD IN
APPROX. 10 SEC.**



7 - 16

Tightening may be done by turning the bolt while the nut is prevented from rotating when it is impractical to turn the nut. Impact wrenches, if used, shall be of adequate capacity and sufficiently supplied with air to perform the required tightening of each bolt in approximately 10 seconds.

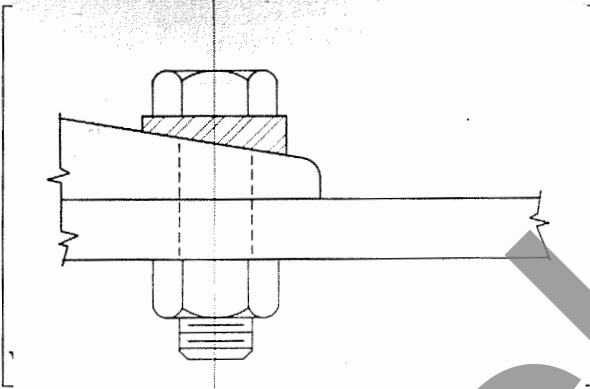

7 - 17

Where the outer face of the bolted parts has a slope greater than 1:20 with respect to a plane normal to the bolt axis, a hardened beveled washer shall be used to compensate for the lack of parallelism.

**UNDER TURNED ELEMENT
WHEN USING
CALIBRATED WRENCH
UNDER HEAD & NUT
WHEN USING A490
BOLTS IN STEEL LESS
THAN 40 KSI- f_y**



7 - 18

F_y

Hardened washers are not required for connections using AASHTO M164 (ASTM A325) and AASHTO M253 (ASTM A490) bolts except as follows: Hardened washers shall be used under the element turned in tightening when the tightening is to be performed by calibrated wrench method. Regardless of the tightening method, hardened washers shall be used under both the head and the nut when AASHTO M253 (ASTM A490) bolts are to be installed in material having a specified yield point less than 40 ksi.

**OVERSIZE OR SHORT
SLOTTED HOLE IN
OUTER PLY**

**WHEN OVER 1"
A490 BOLT, USE
5/16" WASHER UNDER
HEAD & NUT**



7-19

Where AASHTO M164 (ASTM A325) bolts of any diameter or AASHTO M253 (ASTM A490) bolts equal to or less than 1 inch in diameter are to be installed in an oversize or short slotted hole in an outer ply, a hardened washer conforming to ASTM F436 shall be used. When AASHTO M253 (ASTM A490) bolts over 1 inch in diameter are to be installed in an oversize or short slotted hole in an outer ply, hardened washers conforming to ASTM F436 except with $\frac{5}{16}$ inch minimum thickness shall be used under both the head and the nut in lieu of standard thickness hardened washers. Multiple hardened washers with combined thickness equal to or greater than $\frac{5}{16}$ inch do not satisfy this requirement.

**LONG SLOTTED HOLE
IN OUTER PLY USE
5/16" PLATE WASHER**

**WHEN OVER 1"
A490 USE 5/16"
WASHER**



7-20

Where AASHTO M164 (ASTM A325) bolts of any diameter or AASHTO M253 (ASTM A490) bolts equal to or less than 1 inch in diameter are to be installed in a long slotted hole in an outer ply, a plate washer or continuous bar of at least $\frac{5}{16}$ inch thickness with standard holes shall be provided. The washers or bars shall have a sufficient size to cover completely the slot after installation and shall be of structural grade material, but need not be hardened except as follows. When AASHTO M253 (ASTM A490) bolts over 1 inch in diameter are to be used in long slotted holes in external plies, a single hardened washer conforming to ASTM F436 but with $\frac{5}{16}$ inch minimum thickness shall be used in lieu of washers or bars of structural grade material. Multiple hardened washers with combined thickness equal to or greater than $\frac{5}{16}$ inch do not satisfy this requirement.

**ALTERNATE
DESIGN FASTENERS
MAY NOT
REQUIRE WASHERS**



Alternate design fasteners with a geometry which provides a bearing circle on the head or nut with a diameter equal to or greater than the diameter of hardened washers meeting the requirements ASTM F436 satisfy the requirements for washers.

7-21

Archived

Session 8

Turn-of-Nut Tightening

TIGHTENING METHODS

- TURN-OF-NUT
- DIRECT TENSION INDICATOR
- CALIBRATED WRENCH



8 - 1

Three tightening methods for conventional bolts, nuts, and washers are included in the AASHTO Bridge Code.

- Turn-of-Nut
- Direct Tension Indicator
- Calibrated Wrench

Detailed discussions of each follows.

TURN - OF - NUT

8 - 2

Turn-of-nut tightening makes use of the relationship between thread lead and induced tension in the bolt to provide the necessary clamping force. The procedure was developed in the late 1950s by Bethlehem Steel Corporation as an alternate procedure to the calibrated wrench method. When turn-of-nut tightening is used, hardened washers are not required except as was discussed earlier.

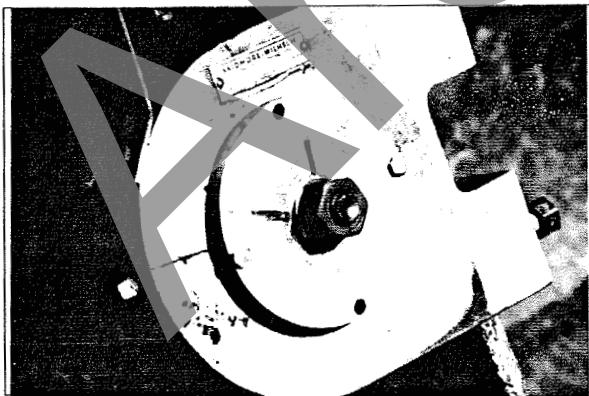

8 - 3

Prior to the start of fastener installation a representative sample of not less than three bolt and nut assemblies of each diameter, length and grade to be used in the work shall be checked in a device capable of indicating bolt tension.

The test shall demonstrate that the method for estimating the snug tight condition and controlling the turns from snug tight to be used by the bolting crew develops a tension not less than 5% greater than the tension required by Table 11.5 A. Test is called "Turn-of-nut Verification".

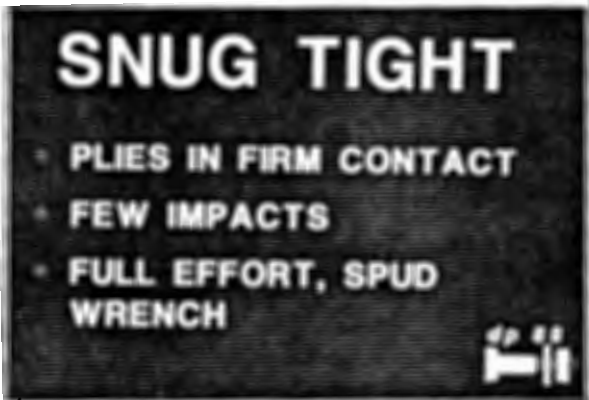

8-4

Bolts shall be installed in all holes of the connection and brought to a "snug tight" condition. Snug tight is defined as the tightness that exists when the plies of the joint are in firm contact. This may be attained by a few impacts of an impact wrench or the full effort of a man using an ordinary spud wrench.

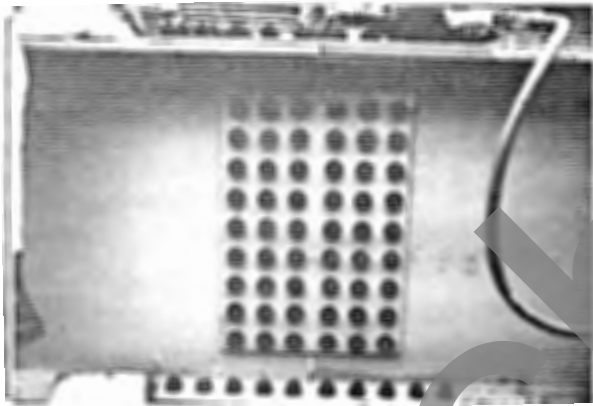

8-5

Snug tightening shall progress systematically from the most rigid part of the connection to the free edges, and then the bolts of the connection shall be retightened in a similar systematic manner as necessary until all bolts are simultaneously snug tight and the connection is fully compacted.

Explain proper tightening sequence from slide.

TABLE 10.17B-NUT ROTATION FROM SNUG	
LENGTH	BOTH FACES NORMAL
≤ 4 DIA.	1/3 TURN
> 4 ≤ 8 DIA.	1/2 TURN
> 8 ≥ 12 DIA.	2/3 TURN

dp 88

8-6

Following this initial operation, all bolts in the connection shall be tightened further by the applicable amount of rotation specified in Table 10.17B. During the tightening operation there shall be no rotation of the part not turned by the wrench. Tightening shall progress systematically from the most rigid part of the joint to its free edges.

Explain table.

See Appendix for complete table.

Session 9

Direct Tension Indicators

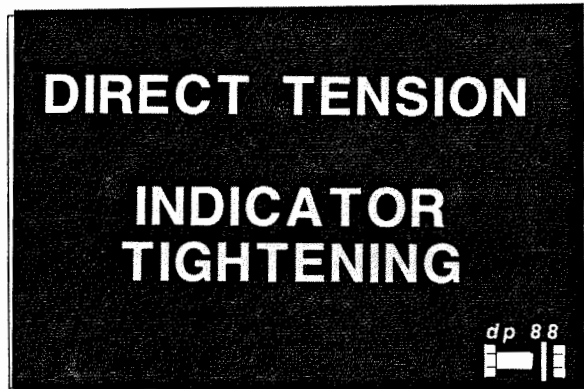

9 - 1

A direct tension indicator (DTI) is a device which indicates the bolt tension without relying on a torque-tension relationship. The most common type of DTI is a crushable washer. The behavior and use of washer-type DTI's will be discussed in this section.

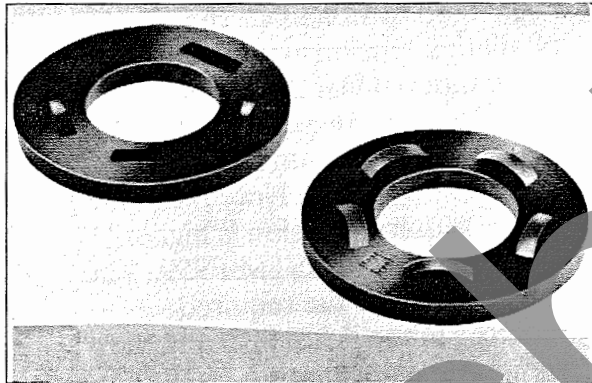

9 - 2

A typical DTI is shown in Figure 9-2. The washers are covered by ASTM Specification F959. They are to have the manufacturer's marking on them and the grade of bolt they are to be used with.

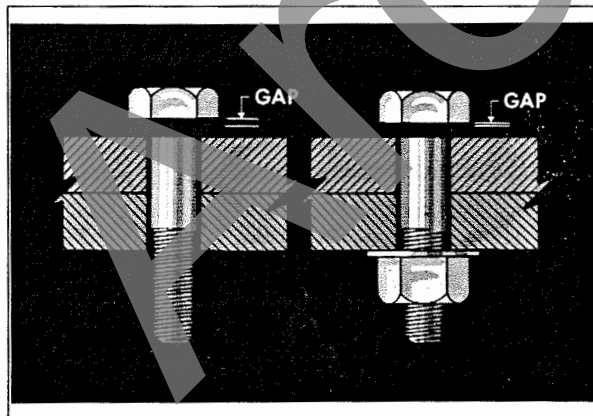

9 - 3

Figure 9-3 shows a typical installation of a DTI. As the nut is tightened, the protrusions on the washers are plastically deformed. The gap between the washer and bolt head is measured in the spaces between the protrusions. The gap is used to indicate the tension in the bolt.

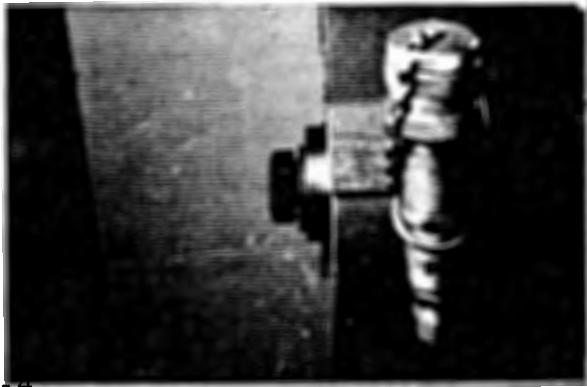

9-4

The performance of the DTIs should be checked in the field before the start of bolting. A tension measuring device is used along with a special adaptor at the bolt head. This adaptor replaces the normal piece used to prevent bolt head rotation.

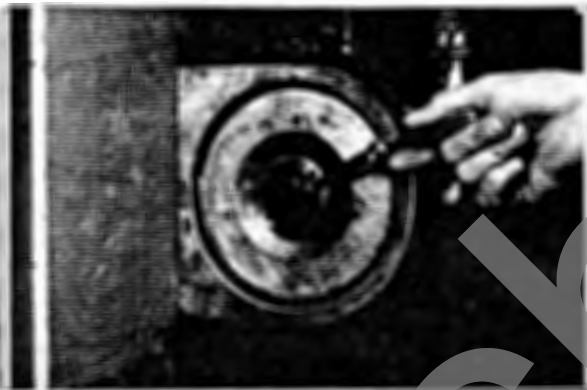

9-5

The bolt is tightened to 1.05 times the required installation tension and the gap is measured using tapered leaf thickness (feeler) gages. The average gap must equal or exceed 0.005 inches for plain DTIs and 0.005 inches for coated DTIs. Note the value of 1.05 times the required tension is higher than the minimum value in ASTM F959. The requirement of 1.05 times the required tension is required in the AASHTO and the Research Council Specifications.

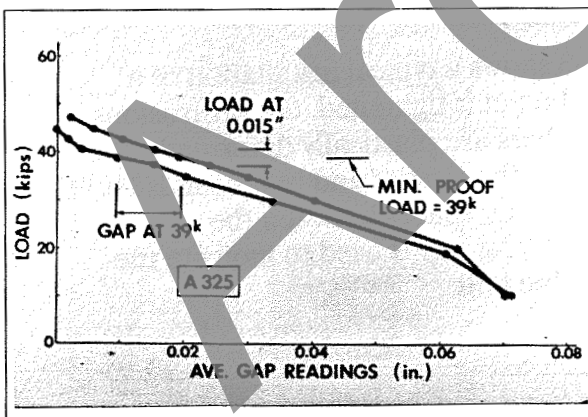

9-6

The graph in Figure 9-6 shows the typical performance of a DTI. As the bolt tension is increased, the gap decreases. Some variability exists in the gap-tension relationship. Three DTIs of each diameter must be tested and meet the requirements to account for this variability. In addition, the bolt tension is set at 1.05 times the required installation tension to further account for the variability of the measurement. Tightening beyond crushing of the protrusion should not be allowed. The bolt tension is unknown when crushing occurs. Failure of the bolt may occur.



9-7

Care should be exercised during testing and installation of DTIs to prevent turning of the bolt head against the DTI. The turning will gall the protrusion and reduce the gap. The result will be a small gap which gives a false indication of bolt tension. A two-person bolting crew is required with DTIs to insure that the head of the bolt does not turn and to monitor the gap during tightening.

Use of a DTI under the turned element requires the use of a hardened washer between the DTI and the element. The washer should not turn against the DTI. It is very difficult to insure that the washer does not rotate during installation. Consequently, use of DTIs under the turned element should be discouraged. If the DTI is to be used under the turned element in the work, the field check should be performed using this arrangement.

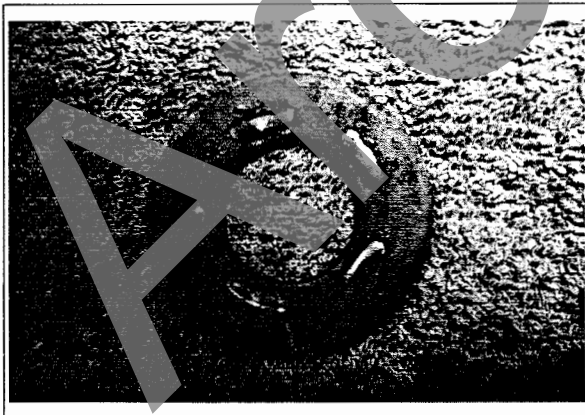

9-8

The deformation which occurs in the protrusions is plastic. Removal of the bolt tension does not cause the gap to increase. The DTI should not be crushed to the specified gap during snugging since snugging of adjacent bolts will reduce bolt tension but the DTI gap will not change. This will cause the DTI to give a false indication of bolt tension.

Turning of the nut during final tightening beyond crushing of the DTI can cause bolt failure. The tension required to crush the washer can exceed the bolt strength. Tightening beyond crushing should not be allowed.

Archived

Session 10

Calibrated Wrench Tightening

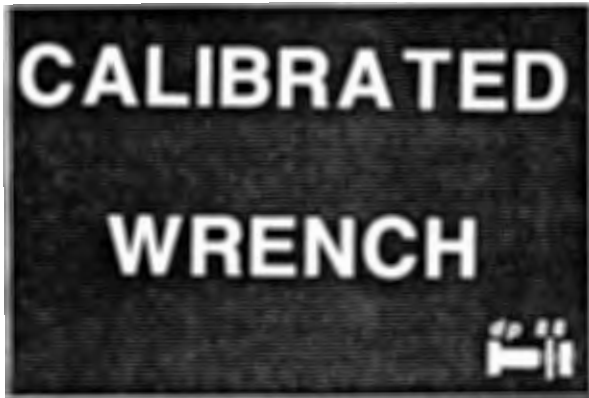

10 - 1

Calibrated wrench tightening relies on a certain torque load to induce proper tension in the bolt. The method was previously deleted from AASHTO Bridge Code and was only re-inserted in 1988 with strict controls on jobsite procedures. Numerous variables which are not related to tension affect torque. Specified installation procedures must be followed to assure proper fastener tension.

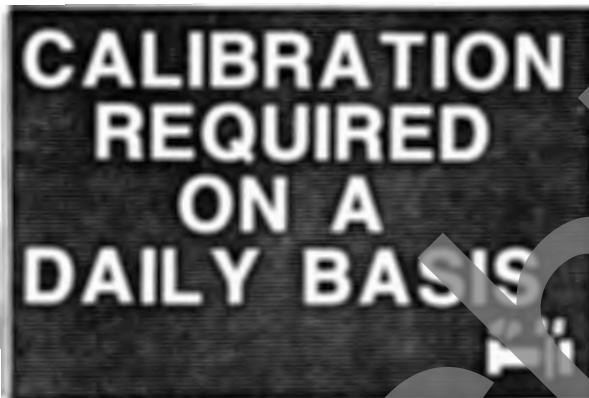

10 - 2

Calibrated wrench tightening may be used only when installation procedures are calibrated on a daily basis and when a hardened washer is used under the element turned in tightening. The AASHTO specification does not recognize standard torques determined from tables or from formulas which are assumed to relate torque to tension. When calibrated wrenches are used for installation, they shall be set to provide a tension not less than 5 percent in excess of the minimum tension specified in Table 11.5 A.

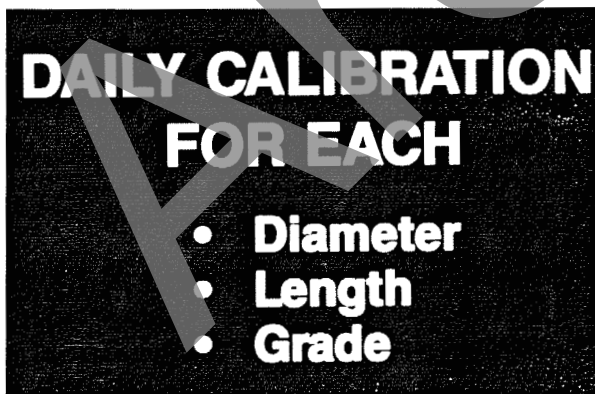

10 - 3

The installation procedures shall be calibrated at least once each working day for each bolt diameter, length and grade using fastener assemblies that are being installed in the work.

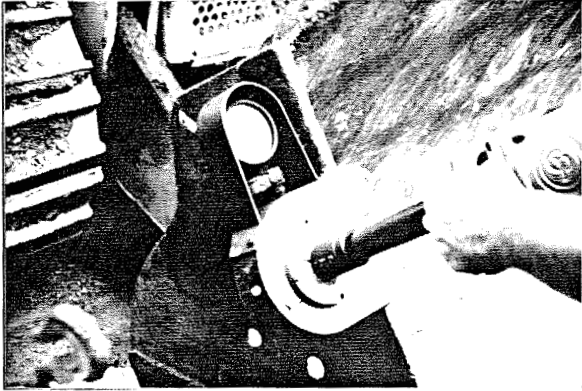

10 - 4

Calibration shall be accomplished in a device capable of indicating actual bolt tension by tightening three typical bolts of each diameter, length and grade from the bolts being installed and with a hardened washer from the washers being used in the work under the element turned in tightening.

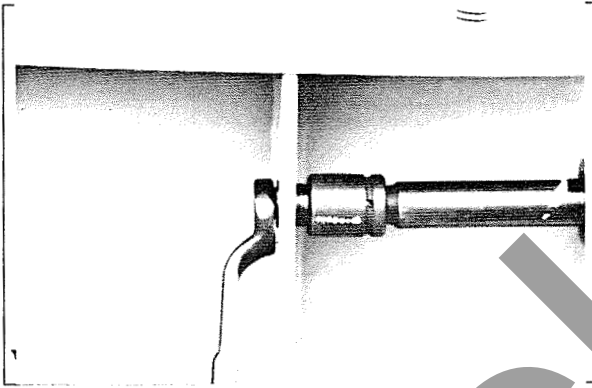

10 - 5

Bolts that are too short for the tension indicating device may be tested using direct tension indicators (DTIs). The DTI will give an indication of the tension load in short bolts and allow the establishment of the torque to tension ratio.



10 - 6

The DTIs must be "calibrated" in a tension indicating device to determine the applicable DTI clearance at a load 5% over the specified minimum bolt tension. For accurate calibration DTI must go under bolt head. When using Skidmore-Wilhelm equipment, the inserts must be modified to place the nut on the back side and allow tightening from the nut side. Once the DTIs are calibrated, they are used on the short bolts to set the installation wrenches at the required bolt tension. DTIs must be placed under bolt head.

**RE - CALIBRATE
WHEN ANY
CHANGE
IS NOTED IN
THREAD CONDITION**



10 - 7

Wrenches shall be recalibrated when significant difference is noted in the surface condition of the bolt threads, nuts or washers. Recalibration is also required when fasteners are installed which may have been cleaned and/or relubricated.

**NUT ROTATION
CAN NOT
EXCEED
TABLE 10.17B**



10 - 8

It shall be verified during actual installation in the assembled steelwork that the wrench adjustment selected by the calibration does not produce a nut or bolt head rotation from snug tight greater than that permitted in Table 10.17B. If manual torque wrenches are used, nuts shall be turned in the tightening direction when torque is measured.

TIGHTENING SEQUENCE

**WASHER UNDER TURNED
ELEMENT**

**SNUG TIGHT, ALL HOLES
CALIBRATED WRENCH**

"TOUCH-UP"



10 - 9

When calibrated wrenches are used to install and tension bolts in a connection, bolts shall be installed with hardened washers under the element turned in tightening bolts in all holes of the connection and brought to a snug tight condition. Following this initial tightening operation, the connection shall be tightened using the calibrated wrench. Tightening shall progress systematically from the most rigid part of the joint to its free edges. The wrench shall be returned to "touch up" previously tightened bolts which may have been relaxed as a result of the subsequent tightening of adjacent bolts until all bolts are tightened to the prescribed amount.

Archived

Session 11

Alternate Design and Lock Pin and Collar Fasteners

ALTERNATE DESIGN FASTENERS



11 - 1

ALTERNATE DESIGN FASTENERS

When fasteners which incorporate a design feature intended to indirectly indicate the bolt tension or to automatically provide the tension required by Table 11.5 A and which have been qualified under Article 10.3.1.8.9 are to be installed, a representative sample of not less than three bolts of each diameter, length and grade shall be checked at the job site in a device capable of indicating bolt tension.

AASHTO STANDARD SPECIFICATIONS FOR HIGHWAY BRIDGES DIVISION II

PARA. 10.3.1.8.9



11 - 2

11.3.26 - Other fasteners or fastener assemblies which meet the materials, manufacturing, and chemical composition requirements of AASHTO M164 (ASTM A325) or AASHTO M253 (ASTM A490), and which meet the mechanical property requirements of the same specification in full-size tests, and which have body diameter and bearing areas under the head and nut, or their equivalent, not less than those provided by a bolt and nut of the same nominal dimensions prescribed in the previous paragraph, may be used subject to the approval of the Engineer. Such alternate fasteners may differ in other dimensions from those of the specified bolts and nuts. Their installation procedure may differ from those specified and their inspection may differ from that to be discussed later. When a different installation procedure or inspection is used, it shall be detailed in a supplemental specification applying to the alternate fastener and that specification must be approved by the Engineer.

**TENSION 5%
GREATER
THAN TABLE 10.17A**



11 - 3

The test assembly shall include flat hardened washers, if required in the actual connection, arranged as in the actual connections to be tensioned. The calibration test shall demonstrate that each bolt develops a tension not less than 5 percent greater than the tension required by Table 10.17A. Manufacturer's installation procedure as required by Article 11.3.2.6 shall be followed for installation of bolts in the calibration device and in all connections.

**SNUG TIGHT
ALL PLYS IN
FIRM CONTACT**



11 - 4

When alternate design fasteners which are intended to control or indicate bolt tension of the fasteners are used, bolts shall be installed in all holes of the connection and initially tightened sufficiently to bring all plies of the joint into firm contact but without yielding or fracturing the control or indicator element of the fasteners.

**FINAL TIGHTEN
RIGID TO FREE EDGES
MINIMIZE RELAXATION
MORE THAN ONE CYCLE**



11 - 5

All fasteners shall then be further tightened, progressing systematically from the most rigid part of the connection to the free edges in a manner that will minimize relaxation of previously tightened fasteners. In some cases, proper tensioning of the bolts may require more than a single cycle of systematic partial tightening prior to final twistoff of the control or indicator element of individual fasteners.

LOCK PIN AND COLLAR FASTENERS

dp 88

11 - 6

LOCK PIN AND COLLAR FASTENERS

The installation of lock-pin and collar fasteners shall be by methods and procedures approved by the Engineer.

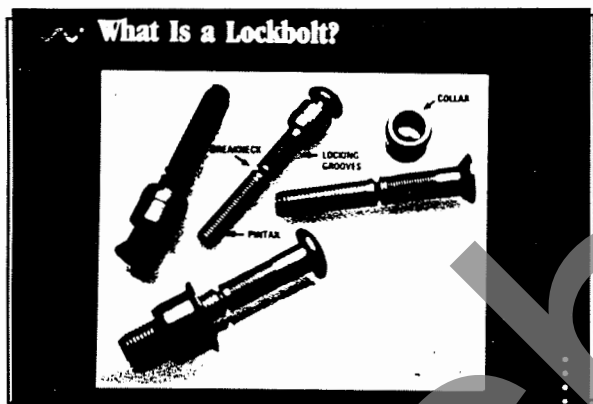

11 - 7

The lock pin and collar provides carbon steel strength grade A325 in nominal diameters from 1/2" to 1 1/8". Lockbolts have been used for 50 years in construction and transportation applications. These fasteners meet the ASTM specification for A325 bolts.

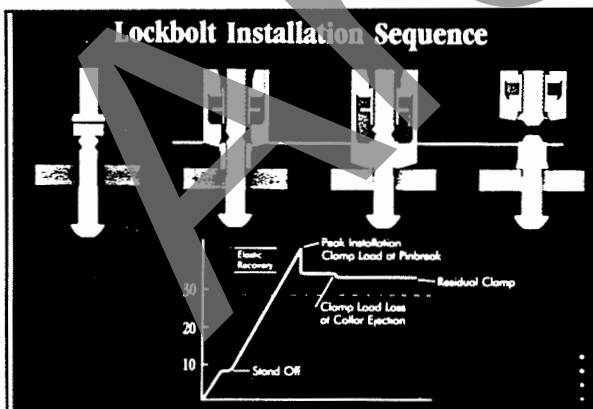

11 - 8

The locking collar is swaged into the locking grooves on the pin by the application of direct tension.

- The installation tool "holds" onto the pintail and applies a "push-pull" action on the collar and pin.
- When the tensile force applied exceeds the plastic limit of the collar, it begins to swage and progressively engages in the locking grooves on the pin.
- The swage action continues until the swaging anvil of the nose assembly contacts the work or collar flange.
- As the tool continues to apply direct tension force to the pin, it will fail in tension at the completion of the installation cycle in the breakneck groove.

Lockbolt vs Threaded Nut and Bolt



- Vibration Resistant
- Precise, Repeatable Clamp-Up
- Visual Inspection
- Nicked Grooves No Problem
- Axial Tensile Loading of Bolt Only

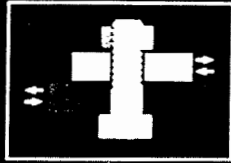

- Helical Threads Allow Nut Back-Off
- Subject to Under/Over Torquing
- Labor Intensive Torque Checks
- Thread Condition Critical
- Multiple Stressing of Bolt Thread Section (Torsion and Tension)

Many comparisons have been made between swage lock fasteners and threaded bolt/nut systems. There are significant differences in the forces applied and the action of their application to fastener components.

Clamp force is created by the application of direct tension to the pin and collar. The force needed for installation is controlled by the interaction of the tool and fastener.

Archived

Session 12

Re-Use and Inspection



12 - 1

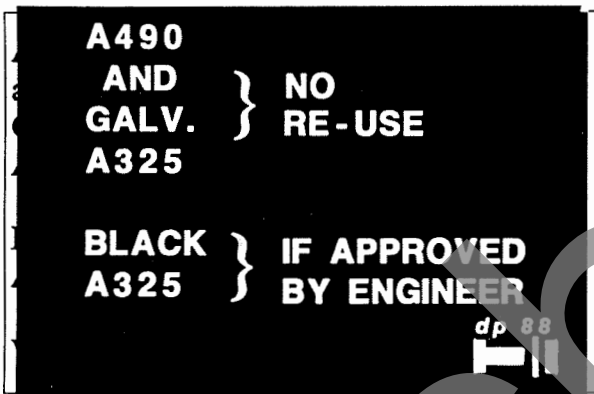

12 - 2



12 - 3

RE-USE OF FASTENERS

In some cases it may become necessary to remove previously tightened fasteners from the structure. The Engineer or inspector is usually requested to allow the re-use of the fasteners. The AASHTO Bridge Code states as follows:

AASHTO M253 (ASTM A490) bolts and galvanized AASHTO M164 (ASTM A325) bolts shall not be reused. Only black AASHTO M164 (ASTM A325) bolts may be reused if approved by the Engineer responsible. Touching up or retightening previously tightened bolts which may have been loosened by the tightening of adjacent bolts shall not be considered as reuse provided the snugging up continues from the initial position and does not require greater rotation, including the tolerance, than that required by Table 10.17B.

The following criteria should be used by the Engineer to evaluate whether or not AASHTO M164 (ASTM A325) fasteners can be reused:

- 1) There should be no excessive elongation of the bolt in the threaded area which would be present if the bolt had been overtightened. If the nut can be installed by hand for the full thread length, no overtightening is evident. Check every bolt with nut which was used during initial installation.

LUBRICATION

**R-C Test Each Lot
Lubricate & Re-Test**

12 - 4

2) Adequate lubrication must be present. All fasteners to be reused must be completely removed from the structure and grouped together to form lots according to the length of time they have been installed. R-C test each lot. Fasteners which fail test can be lubricated and re-tested. Re-use should be limited to one (1) time.

INSPECTION OF FASTENER INSTALLATION

dp 88

12 - 5

INSPECTION OF FASTENER INSTALLATION

The Engineer shall determine that the requirements of the following are met in the work. These requirements apply equally to fasteners which may be installed and tightened in the fabrication shop.

**PRE INSTALLATION
INSPECTION
WITNESS CALIBRATION
AND TESTING
MONITOR INSTALLATION**

dp 88



12 - 6

Before the installation of fasteners in the work, the Engineer shall check the marking, surface condition and storage of bolts, nuts and washers and the faying surfaces of joints for compliance with the requirements as previously discussed. He shall observe calibration and/or testing procedures required to confirm that the selected procedure is properly used and that, when so used with the fastener assemblies supplied, the tensions specified in Table 11.5A are provided. He shall monitor the installation of fasteners in the work to assure that the selected procedure, as demonstrated in the initial testing to provide the specified tension, is routinely properly applied.

**INSPECTION OF
COMPLETED JOINTS**

INSPECTION WRENCH

dp 88



12 - 7

In addition to the above, inspection of completed joints is required. The following inspection procedure shall be used unless a different procedure is specified in the contract documents. Either the Engineer or the Contractor in the presence of the Engineer, at the Engineer's option, shall use an inspection wrench which may be a torque wrench.



12 - 8

At least once each day, a representative sample of five bolts from the diameter, length and grade of the bolts used in the work shall be tightened in the tension measuring device by any convenient means to an initial condition equal to approximately 15 percent of the required fastener tension and then to the minimum tension specified in Table 10.17A. There shall be a washer under the part turned in tightening each bolt if washers are so used on the structure. Tightening beyond the initial condition must not produce greater nut rotation than 1½ times that permitted in Table 10.17B.

**TORQUE
NECESSARY
TO TURN
5 DEGREES**

dp 88



12 - 9

The inspecting wrench shall then be applied to the tightened bolts and the torque necessary to turn the nut or head 5 degrees (approximately 1" at 12" radius) in the tightening direction shall be determined. From a practical standpoint this is the torque necessary to just start rotation of the nut or bolt head. Turn from same side turned during installation.

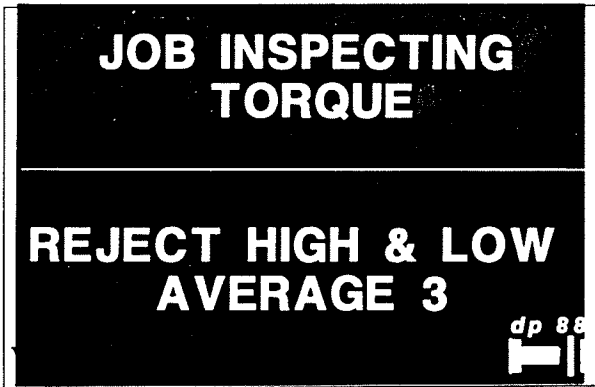

12 - 10

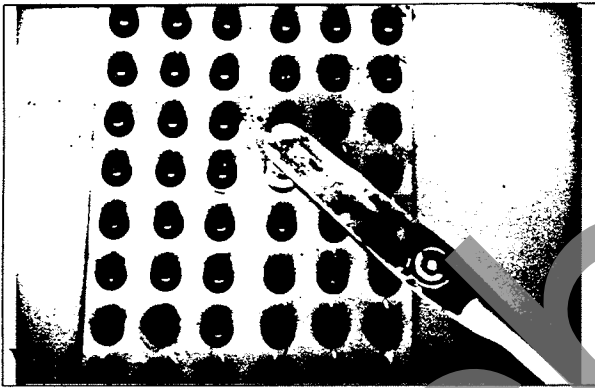

12 - 11



12 - 12

The job inspecting torque shall be taken as the average of three values thus determined after rejecting the high and low values.

Bolts represented by the sample in the foregoing paragraph which have been tightened in the structure shall be inspected by applying, in the tightening direction, the inspecting wrench and its job torque to 10% of the bolts, but not less than 2 bolts, selected at random in each connection in question. If no nut or bolt head is turned by the application of the job inspecting torque, the connection shall be accepted as properly tightened. If any nut or bolt is turned by the application of the job inspecting torque, all bolts in the connection shall be tested, and all bolts whose nut or head is turned by the job inspecting torque shall be tightened and reinspected. Alternatively, the fabricator or erector, at his option, may retighten all of the bolts in the connection and then resubmit the connection for the specified inspection.

The AASHTO Specification does not recognize standard torques determined from tables or from formulas which are assumed to relate torque to tension. Testing using such standard torques shall not be considered valid. Torque to Tension ratio is governed by many variables and must be determined on each project on a daily basis.

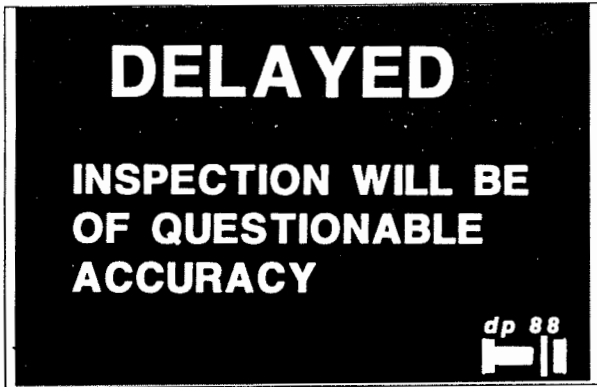

12 - 13

The procedure discussed is intended for inspection of bolted connections and verification of pretension at the time of tensioning the joint. If verification of bolt tension is required after a passage of a period of time and exposure of the completed joints, the procedures discussed will provide an indication of bolt tension which is of questionable accuracy. Procedures appropriate to the specific situation should be used for verification of bolt tension. This might involve use of the inspection procedure discussed or might require the development and use of alternate procedures.

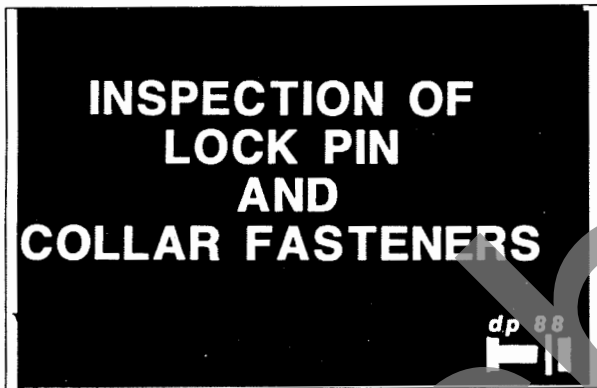

12 - 14

The procedures for inspecting and testing lock-pin and collar fasteners and their installation to assure that the required preload tension is provided shall be as approved by the Engineer.

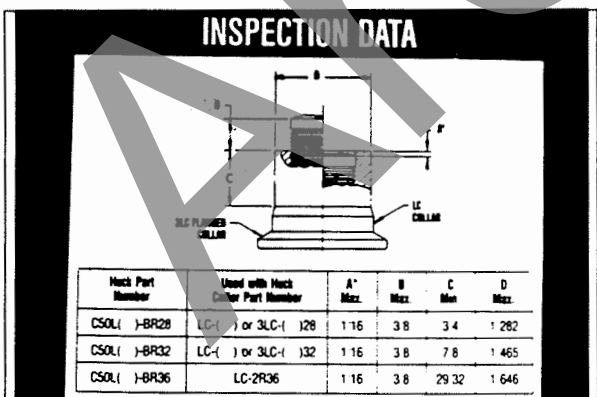

12 - 15

The installed fastener can be visually inspected for pin position, swage diameter, and length. The illustration shows those dimensions which can be visually inspected, checked with simple measuring instruments, or by simple go-no go gauges available.

Installed fastener values become a function of material and dimensional control at the manufacturing source and are independent of operator skill.

Archived

APPENDIX A1

PROCEDURE FOR PERFORMING ROTATIONAL CAPACITY TEST
LONG BOLTS IN TENSION CALIBRATOR

EQUIPMENT REQUIRED:

1. Calibrated bolt tension measuring device of size required for bolts to be tested. Mark off a vertical line and lines 1/3 of a turn, 120 degrees; and 2/3 of a turn, 240 degrees, from vertical in a clockwise direction on the face plate of the calibrator.
2. Calibrated torque wrench.
3. Spacers and/or washers with hole size no larger than 1/16 in. greater than bolt to be tested.
4. Steel section to mount bolt calibrator. Flange of girder or cross frame accessible from the ground is satisfactory.

PROCEDURE:

1. Install nut on bolt and measure stick out of bolt when 3 to 5 full threads of the bolt are located between the bearing face of the nut and the bolt head. Measure the bolt length, the distance from the end of the threaded shank to the underside of the bolt head.
2. Install the bolt into the tension calibrator and install the required number of shim plates and/or washer (one washer under the nut must always be used) to produce the thread stickout measured in Step 1.
3. Tighten bolt using a hand wrench to the snug tensions listed below -0 kips, +2 kips.

Bolt Dia. (in.)	1/2	5/8	3/4	7/8	1	1-1/8	1-1/4	1-3/8	1-1/2
Snug Tension (kips)	1	2	3	4	5	6	7	9	10

4. Match mark the nut to the vertical stripe on the face plate of the bolt calibrator.

Using the calibrated manual torque wrench, tighten the bolt to at least the tension listed below and record the torque required to reach the tension and the value of the bolt tension. Torque must be measured with the nut in motion.

Bolt Dia. (in.)	1/2	5/8	3/4	7/8	1	1-1/8	1-1/4	1-3/8	1-1/2
Tension (kips)	12	19	28	39	51	56	71	85	103

6. Further tighten the bolt to the rotation listed below. The rotation is measured from the initial marking in Step 4. Record the bolt tension. Assemblies which fail prior to this rotation either by stripping or fracture fail the test.

Bolt Length (measured in Step 1)	4 x bolt dia. or less	Greater than 4 but no more than 8 x bolt dia.	Greater than 8x bolt dia.
Required Rotation	2/3	1	1-1/3

7. The bolt tension measured in Step 6 after the required rotation must equal or exceed the values in the table shown below. Assemblies which do not meet this tension have failed the test.

Bolt Dia. (in.)	1/2	5/8	3/4	7/8	1	1-1/8	1-1/4	1-3/8	1-1/2
Tension (kips)	14	22	32	45	59	64	82	98	118

8. Loosen and remove nut, and examine the threads on the nut and bolt. No signs of thread shear failure, stripping, or torsional failure of the bolt should be evident. Assemblies which have evidence of stripping have failed the test.

Calculate and record the value of 0.25x the tension (pounds=kips x 1000) measured in Step 5 x the bolt diameter in feet. The torque measured and recorded in Step 5 must be equal to or less than this calculated value. Assemblies with torque values exceeding this calculated value failed the test.

PROCEDURE FOR PERFORMING ROTATIONAL CAPACITY TEST BOLTS TO SHORT TO FIT TENSION CALIBRATOR

EQUIPMENT REQUIRED:

1. Calibrated torque wrench and an spud wrench or equivalent.
2. Spacers and/or washers with hole size no larger than 1/16 in. greater than bolt to be tested.
3. Steel section with normal size hole to install bolt. Any available splice hole can be used with a plate thickness that will provide the number of threads under the nut required in Step 1 below. Mark off a vertical line and lines 1/3 of a turn, 120 degrees; 1/2 of a turn, 180 degrees; and 2/3 of a turn, 240 degrees, from vertical in a clockwise direction on the plate.

PROCEDURE:

1. Install nut on bolt and measure stick out of bolt when 3 to 5 full threads of the bolt are located between the bearing face of the nut and the bolt head. Measure the bolt length, the distance from the end of the threaded shank to the underside of the bolt head.
2. Install the bolt into the hole and install the required number of shim plates and/or washer (one washer under the nut must always be used) to produce the thread stickout measured in Step 1.
3. Snug the bolt using a hand wrench. The snug condition should be the normal effort applied to a 12 inch long wrench. The applied torque should not exceed 20% of the torque determined in Step 5.
4. Match mark the nut to the vertical stripe on the plate.
5. Tighten the bolt by turning the nut using the torque wrench to the rotation listed below. A second wrench must be used to prevent rotation of the bolt head during tightening. Record the torque required to reach this rotation. Torque must be measured with the nut in motion.

Bolt Length (measured in Step 1)	4 x bolt dia. or less
Required Rotation	1/3

The measured torque should not exceed the values listed below. Assemblies which exceed the listed torques have failed the test.

Bolt Dia. (in.)	1/2	5/8	3/4	7/8	1	1-1/8	1-1/4	1-3/8	1-1/2
Torque (ft-lbs)	150	290	500	820	1230	1500	2140	2810	3690

6. Tighten the bolt further to the rotation required below. The rotation is measured from the initial marking in Step 4. Assemblies which fail prior to this rotation either by stripping or fracture fail the test.

Bolt Length (measured in Step 1)	4 x bolt dia. or less
Required Rotation	2/3

7. Loosen and remove nut, and examine thread on the nut and bolt. No signs of thread shear failure, stripping, or torsional failure of the bolt should be evident. Assemblies which have evidence of stripping have failed the test.

Appendix A2
Procedure for Installation and Tightening of High-Strength Fasteners
Turn-of-Nut Method

1.0 **BOLTED PARTS AND GENERAL PROVISIONS**

- 1.1 Material within the bolt grip will be steel with no compressible material.
- 1.2 Slope of surface shall not exceed 1:20. Correct with hardened beveled washers.
- 1.3 All surfaces free of loose scale, dirt or other foreign material.
- 1.4 Uncoated joints shall have no paint, including overspray, in the connection area.
- 1.5 Painted joints shall be blast cleaned and coated with an approved paint. Joints shall not be assembled until paint has cured for the minimum time used in paint qualification testing.
- 1.6 Galvanized joints shall be roughened by hand wire brushing prior to assembly.
- 1.7 All fastener components shall be properly lubricated and protected from contamination, dirt and moisture.
- 1.8 Hardened washers may be required for standard holes or special washers may be required for oversize or slotted holes. See specifications.
- 1.9 Tightening may be done by turning the bolt while the nut is prevented from rotating when it is impractical to turn the nut. Impact wrenches, if used, shall be of adequate capacity and sufficiently supplied with air to perform the required tightening of each bolt in approximately 10 seconds.

2.0 **TURN-OF-NUT VERIFICATION TESTING**

- 2.1 Equipment required - Calibrated bolt tension measuring device. Spacers and/or washers with proper hole size. Rigid mounting for bolt tension calibrator. Air impact wrenches to install fasteners in the structure.
- 2.2 Select at least 3 bolt, nut and washer (when required) assemblies of each diameter, length and grade to be used in the work.
- 2.3 Install and tighten each assembly in the bolt tension measuring device using the snug tightening procedure which will be used to snug tight the fasteners in the work. Snug tight is defined as the tightness that exists when the plies of the joint are in firm contact. This may be obtained by a few impacts of an impact wrench or the full effort of a man using an ordinary spud wrench. Assure the proposed "snug tightening" procedure does not produce more than 50% of required fastener tension as specified by Table 11.5A below. If so, revise snug tightening procedure.

TABLE 11.5A - REQUIRED FASTENER TENSION (Kips)

Bolt Dia. (in)	1/2	5/8	3/4	7/8	1	1 1/8	1 1/4	1 3/8	1 1/2
M164 (A325)	12	19	28	39	51	56	71	85	103
M253 (A490)	15	24	35	49	64	80	102	121	148

2.4 Following snug tightening, mark nut or drive socket to a reference point on bolt tension calibrator and further tighten to the rotation shown below.

Bolt Length	4 x bolt dia. or less	Greater Than 4 but no more than 8x bolt dia.	Greater than 8 x bolt dia.
Required Rotation	1/3	1/2	2/3

2.5 At this rotation, the minimum bolt tension shall be as follows:

Bolt Dia. (in)	1/2	5/8	3/4	7/8	1	1 1/8	1 1/4	1 3/8	1 1/2
M164 (A325)	13	20	29	41	54	59	75	89	108
M253 (A490)	16	25	37	51	67	84	107	127	155

3.0 **SNUG TIGHTENING PROCEDURE**

3.1 Bolts shall be installed in all holes of the connection and brought up to a "snug tight" condition.

3.2 Snug tight is defined as the tightness that exists when the plies of the joint are in firm contact. Adequate tightness may be obtained by a few impacts of an impact wrench or the full effort of a man using an ordinary spud wrench. The snug tightening procedure used in the work shall be the same snug tightening procedure used when conducting the TURN-OF-NUT VERIFICATION TEST in paragraph 2.3.

3.3 Snug tightening shall progress systematically from the most rigid part of the connection to the free edges. Start the pattern near the end of each member

being spliced at the center of the pattern and work toward all edges of the splice plate.

3.4 Following this initial snug tightening, all bolts in the joint shall be again systematically tightened as necessary using a similar pattern until all bolts are simultaneously snug tight and the connection is fully compacted.

4.0 FINAL TURN-OF-NUT TIGHTENING

4.1 Following this snug tightening operation, all bolts in the connection shall be tightened by the applicable amount of rotation as specified in Table 11.5 B below.

TABLE 11.5B--NUT ROTATION FROM SNUG TIGHT

Bolt Length	Both Faces Normal	One Face Normal -- One Face Sloped Not More Than 1:20	Both Faces sloped Not More Than 1:20
4 x dia. or less	1/3 turn	1/2 turn	2/3 turn
Greater than 4 but no more than 8 x bolt dia.	1/2 turn	2/3 turn	5/6 turn
Greater than 8 x bolt dia. not exceeding 12x	2/3 turn	5/6 turn	1 turn

4.2 During the tightening operation there shall be no rotation of the part not turned by the wrench.

4.3 Tightening shall progress systematically from the most rigid part of the joint to its free edges. Start the pattern near the end of each member being spliced at the center of the pattern and work toward all edges of the splice plate.

5.0 COMMENTARY

5.1 **Tension Calibrating Devices:** At the present time, there is no known economical means for determining the tension in a bolt that has previously been installed in a connection. The actual tension in a bolt installed in a tension calibrator (hydraulic tension indicating device) is directly indicated by the dial of the device, provided the device is properly calibrated. Such a device is an economical and valuable tool that should be readily available whenever high-strength bolts are to be tensioned to the specified pretension. Although each element of a fastener assembly may conform to the minimum requirements of their separate material specifications, their compatibility in an assembly or the need for lubrication can only be assured by testing of the assembly. Hence, such devices are important for confirming the complete fastened assembly as it will be used with the method or tightening to assure the suitability of bolts and nuts,

including lubrication, and the adequacy of impact wrenches and/or air pressure, to provide the specified bolt tension.

Testing before start of installation of fasteners in the work will identify potential sources of problems including, but not necessarily limited to, the need for lubrication to prevent failure of bolts by combined high torque with tension, under strength assemblies due to improper marking or heat treatment or quality control of fasteners, excessive overtapping of hot-dip galvanized nuts, improper use of selected installation method by the bolting crews and/or improper or unreliable inspection techniques by inspectors. Such devices are essential to the confirmation testing of fasteners different from AASHTO M164 (ASTM A325) or AASHTO M253 (ASTM A490) bolts, when approved by the Engineer of Record, and direct tension indicators.

They are also essential to the specified procedure for the calibrated wrench method of installation, as well as for confirmation demonstration of proper use of any method by the bolting crews. They are essential for the specified procedure for arbitration inspection. They are the only known economically available tool for field use for determining realistic torque to tension relationships for given fastener assemblies.

Hydraulic tension calibrating devices capable of indicating bolt tension undergo a slight deformation under load. Hence the nut rotation corresponding to a given tension reading may be somewhat larger than it would be if the same bolt were tightened against a solid steel abutment.

Stated differently, the reading of the calibrating device tends to under estimate the tension which a given rotation of the turned element would induce in a bolt in an actual joint. This should be borne in mind when using such devices to establish a tension-rotation relationship.

- 5.2 **Connections and Snug Tight:** Four methods for joint assembly and tightening are provided for connections. Regardless of the method used, and before beginning work, tests should be administered using a tension calibrator to ensure that the specified pretension will be achieved.

With any of the four described tensioning methods, it is important to install bolts in all holes of the connection and bring them to an intermediate level of tension generally corresponding to snug tight in order to compact the joint. If however, individual bolts are installed and tightened in a single continuous operation, bolts which are tightened first will be subsequently relaxed by the tightening of the adjacent bolts. The total of the forces in all bolts will be reduced which will reduce the slip load. Even after being fully tightened, some thick parts with uneven surfaces may not be in contact over the entire faying surface. This is not detrimental to the performance of the joint. As long as the specified bolt tension is present in all bolts of the completed connection, the clamping force equal to the total of the tensions in all bolts will be transferred at the locations that are in contact and be fully effective in resisting slip through friction.

With all methods, tightening should begin at the most rigidly fixed or stiffest point and progress toward the free edges, both in the initial snugging up and in the final tightening.

- 5.3 **Turn-of-Nut-Tightening:** Consistency and reliability using turn-of-the-nut method is dependent upon assuring that the joint is well compacted and all bolts are uniformly tight as a snug tight condition prior to application of the final required partial turn. Under-tightened bolts will result if this procedure is not followed. Reliability is also dependent upon assuring that the turn applied is relative between the bolt and nut. Thus, the element not turned in tightening should be prevented from rotating while the required degree of turn is applied to the turned element. Reliability and inspectability of the method may be improved by having the outer face of the nut match-marked to the protruding

end of the bolt after the joint has been snug tightened but prior to final tightening. Such marks may be applied by the wrench operator using a crayon or dab of paint. Such marks in their relatively displaced position after tightening will afford the inspector a means for noting the rotation that was applied.

Problems with turn-of-nut tightening have been encountered with hot-dip galvanized bolts. In some cases, the problems have been attributed to especially effective lubricant applied by the manufacturer to assure that bolts from stock will meet the material specification requirements without the need for relubricating and retesting. Job site tests in the tension-indicating device demonstrated that the lubricant reduced the coefficient of friction between the bolt and nut to the degree that "the full effort of a man using an ordinary spud wrench" to snug tighten the joint actually induced the full required tension. Also, because the nuts could be turned by application of lower torque than normally expected with non-galvanized bolts, they were erroneously judged improperly tightened by the inspector. Research confirms that lubricated high-strength bolts may require only one-half as much torque to induce the specified tension. In other cases of problems with hot-dip galvanized bolts, the absence of lubrication or lack of proper overtapping caused seizing of the nut and bolt threads which resulted in twist failure of the bolt at low or no tension. For such situations, use of a tension indicating device and the fasteners being installed may be helpful in establishing either the need for lubrication or alternate criteria for snug tight at about one-half the tension required by Table 10.17A.

Because reliability of the method is independent of the presence or absence of washers, washers are not required except for oversize and slotted holes in the outer ply. In the absence of washers, testing after the fact using a torque wrench method is highly unreliable. That is, the turn-of-nut method of installation, properly applied, is more reliable and consistent than the testing method. The best method for inspection of the method is for the inspector to observe the required job site confirmation testing of the fasteners and the method to be used followed by monitoring of the work in progress to assure that the method is routinely properly applied.

Archived

Appendix A3
Procedure for Installation and Tightening of High-Strength Fasteners
Calibrated Wrench Method

1.0 **BOLTED PARTS AND GENERAL PROVISIONS**

- 1.1 Material within the bolt grip will be steel with no compressible material.
- 1.2 Slope of surface shall not exceed 1:20. Correct with hardened beveled washers.
- 1.3 All surfaces free of loose scale, dirt or other foreign material.
- 1.4 Uncoated joints shall have no paint, including overspray, in the connection area.
- 1.5 Painted joints shall be blast cleaned and coated with an approved paint. Joints shall not be assembled until paint has cured for the minimum time used in paint qualification testing.
- 1.6 Galvanized joints shall be roughened by hand wire brushing prior to assembly.
- 1.7 All fastener components shall be properly lubricated and protected from contamination, dirt and moisture.
- 1.8 Hardened washers are required under the turned element on all fasteners. Special washers may be required for oversized or slotted holes. See specifications.
- 1.9 Tightening may be done by turning the bolt while the nut is prevented from rotating when it is impractical to turn the nut. Impact wrenches, if used, shall be of adequate capacity and sufficiently supplied with air to perform the required tightening of each bolt in approximately 10 seconds.

2.0 **WRENCH CALIBRATION**

- 2.1 Equipment required:
- 2.1.1 Calibrated bolt tension measuring device.
- 2.1.2 Spacers and/or washers with proper hole size to adjust bolt length in tension measuring device.
- 2.1.3 Rigid mounting for bolt tension calibrator.
- 2.1.4 Wrenches, either adjustable impact or manual torque, to be used to install fasteners in the structure.
- 2.1.5 Appropriate supply of properly sized, uncoated, lot identified Direct Tension Indicating washers (DTIs) which meet the requirements of ASTM F-959. See paragraph 2.4.
- 2.1.6 Suitable tapered tip flat feeler gauges Range 0.005 inches to 0.030 inches in 0.001 inch increments.

- 2.1.7 Rigidly mounted steel plate with round hole 1/16 inch over nominal size of bolts to be installed in structure. Can utilize holes in structural steel members to be erected.
- 2.1.8 Adequate supply of hex head HS bolts, nuts and washers to calibrate DTIs. See paragraph 2.4.1.
- 2.2 Frequency of Calibration: Each installation wrench shall be calibrated at least once each working day for each bolt diameter, length and grade using fastener assemblies that are being installed in the work. Wrenches shall be recalibrated when significant difference is noted in the surface condition or level of lubrication of the bolt threads, nuts or washers.
- 2.3 Calibration Procedure: Long bolts shall be of sufficient length so that when installed in the tension measuring device, with a hardened washer under the turned element, at least three (3) full threads are exposed between the nut face and the underside of the bolt head when the end of the bolt is at least flush with the outside face of the nut.
- 2.3.1 Select three (3) bolt, nut and washer assemblies from each diameter, length and grade for which each individual installation wrench is to be calibrated.
- 2.3.2 Install each bolt, nut and washer assembly into the tension measuring device and install sufficient spacers and/or washers so that at least three (3), but no more than five (5) full threads, are exposed between the nut face and the underside of the bolt head. The element (nut or bolt head) turned during calibration must be the same as to be turned in the work. A hardened washer must be in place under the turned element.
- 2.3.3 Tighten each assembly using the snug tightening procedure which will be used to snug tight the fasteners in the work. Snug tight is defined as the tightness that exists when the plies of the joint are in firm contact. This may be obtained by a few impacts of an impact wrench or the full effort of a man using an ordinary spud wrench. Assure the proposed snug tightening procedure does not produce more than 50% of required fastener tension as specified by Table 11.5A below. If so, revise snug tightening procedure.

TABLE 11.5A - REQUIRED FASTENER TENSION (Kips)

Bolt Dia. (in)	1/2	5/8	3/4	7/8	1	1 1/8	1 1/4	1 3/8	1 1/2
M164 (A325)	12	19	28	39	51	56	71	85	103
M253 (A490)	15	24	35	49	64	80	102	121	148

- 2.3.4 When the calibrated installation wrench is to be an adjustable impact wrench, each of the three (3) assemblies shall be tightened further and the wrench adjusted or set to cut-out at not less than the minimum tension as shown below. Wrench setting for final installation tightening shall be the average of the three (3) tests.

Bolt Dia. (in)	1/2	5/8	3/4	7/8	1	1 1/8	1 1/4	1 3/8	1 1/2
M164 (A325)	13	20	29	41	54	59	75	89	108
M253 (A490)	16	25	37	51	67	84	107	127	155

2.3.5 When the calibrated installation wrench is to be a manual torque wrench, each of the three (3) assemblies shall be tightened further and the torque noted which was required to induce the bolt tension as specified in paragraph 2.3.4 above. Torque shall be measured with the turned element in motion. The minimum torque used for final installation tightening shall be the average of the three (3) tests.

2.4 Calibration Procedure - Short Bolts - Short bolts are defined as those lengths which are too short to meet the criteria for long bolts as described in paragraph 2.3.

2.4.1 DTI Calibration - Wrenches to be used to install short bolts may be calibrated using DTIs. However, DTIs must first be calibrated as follows:

2.4.1.1 Select three (3) DTIs of each diameter from the same lot as identified on shipping container.

2.4.1.2 Using appropriate length bolt, nut and flat washer of same diameter as DTI, install DTI under bolt head against face plate of tension calibrator. Protrusions on DTI must bear on head of bolt.

2.4.1.3 Install appropriate adapter in back of tension calibrator to allow flat washer and nut to be installed. Use shims or flat washers to position three (3) to five (5) full threads between face of nut and underside of bolt head.

2.4.1.4 Tighten nut while holding bolt head with a suitable wrench to induce the bolt tension as shown below:

Bolt Dia. (in)	1/2	5/8	3/4	7/8	1	1 1/8	1 1/4	1 3/8	1 1/2
M164 (A325)	13	20	29	41	54	59	75	89	108
M253 (A490)	16	25	37	51	67	84	107	127	155

2.4.1.5 Using the feeler gauges, measure and record the opening between the DTI face and the underside of the bolt head at each location between the protrusions. The number of protrusions will vary from four (4) to eight (8) depending upon the nominal size of the DTI. Average the measurements for each DTI.

- 2.4.1.6 Average the results from the three (3) DTIs. The resulting number becomes the DTI calibration to be used to calibrate wrenches for installation of short bolts of the same diameter as the DTI.
- 2.4.2 Select three (3) bolt, nut and washer assemblies from each diameter, length and grade for which each individual installation wrench is to be calibrated. Also select a DTI from the calibrated lot for each bolt assembly.
- 2.4.3 Install each bolt nut and washer assembly into the proper steel plate (See 2.1.7) with the DTI under the bolt head and using sufficient spacers and/or washers so that at least three (3) but not more than five (5) full threads are exposed between the nut face and the underside of the bolt head.
- 2.4.4 With a wrench holding the bolt head, tighten each assembly by turning the nut to obtain a snug tight condition. Snug tight is defined as the tightness that exists when the plies of the joint are in firm contact. This may be obtained by a few impacts of an impact wrench or the full effort of a man using an ordinary spud wrench. See paragraph 2.3.3.
- 2.4.5 When the calibrated installation wrench is to be an adjustable impact wrench, each of the three (3) assemblies shall be tightened further until the average clearance under the DTI is equal to the value obtained during DTI calibration. See paragraph 2.4.1.6. The wrench shall be adjusted or set to cut-out at not less than the DTI calibration clearance.
- 2.4.6 When the calibrated installation wrench is to be a manual torque wrench, each of the three (3) assemblies shall be tightened further, with the torque wrench, until the average clearance under the DTI is equal to the value obtained during DTI calibration. See paragraph 2.4.1.6. The torque required to produce this DTI clearance shall be recorded. Torque shall be measured with the nut in motion. The minimum torque used for final installation tightening shall be the average of the three (3) tests.
- 2.4.7 DTIs used to calibrate wrenches must be utilized in the same position on the fastener assembly as when they were calibrated on the bolt tension calibrator. Case discussed in paragraph 2.4 is DTI under bolt head, turn nut to tighten. This DTI calibration procedure could also be used to calibrate wrenches where the DTI was under the nut and the bolt head was turned. Wrenches can not be calibrated nor can DTIs be calibrated when the DTI is placed under the turned element.

3.0 SNUG TIGHTENING PROCEDURE

- 3.1 Bolts shall be installed in all holes of the connection with a hardened washer under the turned element and brought up to a snug tight condition.
- 3.2 Snug tight is defined as the tightness that exists when the plies of the joint are in firm contact. This may be obtained by a few impacts of an impact wrench or the full effort of a man using an ordinary spud wrench. The snug tightening procedure used in the work shall be the same snug tightening procedure used when conducting the WRENCH CALIBRATION in paragraph 2.3.3 and 2.4.4.
- 3.3 Snug tightening shall progress systematically from the most rigid part of the connection to the free edges. Start the pattern near the end of each member being spliced at the center of the pattern and work toward all edges of the splice plate.
- 3.4 Following this initial snug tightening, all bolts in the joint shall again be systematically tightened as necessary using a similar pattern until all bolts are simultaneously snug tight and the connection is fully compacted.

4.0 FINAL CALIBRATED WRENCH TIGHTENING

- 4.1 Following the snug tightening operation, all bolts in the connection shall be fully tightened by the calibrated wrench, either air impact or manual torque which has been calibrated in accordance with paragraph 2.0.
- 4.2 Tightening shall progress systematically from the most rigid part of the joint to its free edges. The calibrated wrench shall be returned to "touch-up" previously tightened fasteners which may have been relaxed as a result of subsequent tightening of adjacent bolts until all fasteners are tightened to the prescribed amount.
- 4.3 Impact wrenches shall be operated until the wrench cuts-out at the setting established by calibration in paragraph 2.3.4 or 2.4.5. Manual torque wrenches shall be used to tighten the fasteners to the torque determined by calibration in paragraph 2.3.5 or 2.4.6. Torque is always measured with the turned element in motion.
- 4.4 It shall be verified during actual installation in the assembled steelwork that the wrench adjustment selected by the calibration does not produce a nut or bolt head rotation from snug tight greater than that permitted in the following table
115B.

TABLE 115 B - NUT ROTATION FROM SNUG TIGHT

Bolt Length	Both Faces Normal	One Face Normal -- One Face Sloped Not More Than 1:20	Both Faces sloped Not More Than 1:20
4 x dia. or less	1/3 turn	1/2 turn	2/3 turn
Greater than 4 but no more than 8 x bolt dia.	1/2 turn	2/3 turn	5/6 turn
Greater than 8 x bolt dia. not exceeding 12x	2/3 turn	5/6 turn	1 turn

5.0 COMMENTARY

- 5.1 Tension Calibrating Devices: At the present time, there is no known economical means for determining the tension in a bolt that has previously been installed in a connection. The actual tension in a bolt installed in a tension calibrator (hydraulic tension indicating device) is directly indicated by the dial of the device, provided the device is properly calibrated. Such a device is an economical and valuable tool that should be readily available whenever high-strength bolts are to be tensioned to the specified pretension. Although each element of a fastener assembly may conform to the minimum requirements of their separate material specifications, their compatibility in an assembly or the need for lubrication can only be assured by testing of the assembly. Hence, such devices are important for confirming the complete fastened assembly as it will

be used with the method of tightening to assure the suitability of bolts and nuts, including lubrication, and the adequacy of impact wrenches and/or air pressure, to provide the specified bolt tension.

Testing before start of installation of fasteners in the work will identify potential sources of problems including, but not necessarily limited to, the need for lubrication to prevent failure of bolts by combined high torque with tension, under strength assemblies due to improper marking or heat treatment or quality control of fasteners, excessive overtapping of hot-dip galvanized nuts, improper use of selected installation method by the bolting crews and/or improper or unreliable inspection technique by the inspectors. Such devices are essential to the confirmation testing of fasteners different from AASHTO M164 (ASTM A325) or AASHTO M253 (ASTM A490) bolts, when approved by the Engineer of Record, and direct tension indicators. They are also essential to the specified procedure for the calibrated wrench method of installation, as well as for confirmation demonstration of proper use of any method by the bolting crews. They are essential for the specified procedure for arbitration inspection. They are the only known economically available tool for field use for determining realistic torque to tension relationships for given fastener assemblies.

Hydraulic tension calibrating devices capable of indicating bolt tension undergo a slight deformation under load. Hence the nut rotation corresponding to a given tension reading may be somewhat larger than it would be if the same bolt were tightened against a solid steel abutment.

Stated differently, the reading of the calibrating device tends to under estimate the tension which a given rotation of the turned element would induce in a bolt in an actual joint. This should be borne in mind when using such devices to establish a tension-rotation relationship.

- 5.2 Connections and Snug Tight: Four methods for joint assembly and tightening are provided for connections. Regardless of the method used, the tension calibrator should be demonstrated prior to the commencement of work using the fasteners that the crews will use to provide the specified pretension.

With any of the four described tensioning methods, it is important to install bolts in all holes of the connection and bring them to an intermediate level of tension generally corresponding to snug tight in order to compact the joint. If however, individual bolts are installed and tightened in a single continuous operation, bolts which are tightened first will be subsequently relaxed by the tightening of the adjacent bolts. The total of the forces in all bolts will be reduced which will reduce the slip load. Even after being fully tightened, some thick parts with uneven surfaces may not be in contact over the entire faying surface. This is not detrimental to the performance of the joint. As long as the specified bolt tension is present in all bolts of the completed connection, the clamping force equal to the total of the tensions in all bolts will be transferred at the locations that are in contact and be fully effective in resisting slip through friction.

With all methods, tightening should begin at the most rigidly fixed or stiffest point and progress toward the free edges, both in the initial snugging up and in the final tightening.

- 5.3 Calibrated Wrench Method: Research has demonstrated that scatter in induced tension is to be expected when torque is used as an indirect indicator of tension. Numerous variables, which are not related to tension, effect torque. For example, the finish and tolerance on bolt threads and on the nut threads; the fact that the bolt and nut may not be produced by the same manufacturer; the degree of lubrication; the job site conditions contributing to dust and dirt or corrosion on the threads; the friction that exists to varying degrees between the turned element and the supporting surface; the variability of the air pressure on the torque wrenches due to length of air lines or number of wrenches operating from the same source; the condition and lubrication of the wrench which may

change within a work shift and other factors all bear upon the effectiveness of the calibrated torque wrench to induce tension.

The calibrated wrench method is the least reliable of all methods of installation and many costly controversies have occurred. It is suspected that short cut procedures and failure to conscientiously follow the specification requirements were probably involved in many instances in the calibrated wrench method of installation. It is recognized, however, that if the calibrated wrench method is implemented without short cuts there will be a ninety percent assurance that the tensions specified in Table 10.17A will be equaled or exceeded.

To provide greater assurance of proper tensioning the specification has been modified to require better control. Wrenches must be calibrated daily for each diameter and grade of bolt. Hardened washers must be used. Fasteners must be protected from dirt and moisture at the job site. To further achieve reliable results, attention should be given to the control, insofar as it is practical, of those controllable factors which contribute to variability. For example, bolts and nuts should be purchased from reliable manufacturers with a record of good quality control to minimize the variability of the fit. Bolts and nuts should be adequately and uniformly lubricated.

Archived

Archived

Appendix A4
Procedure for Installation and Tightening of High-Strength Fasteners
Alternate Design Fasteners

1.0 **BOLTED PARTS AND GENERAL PROVISIONS**

- 1.1 Material within the bolt grip will be steel with no compressible material.
- 1.2 Slope of surface shall not exceed 1:20. Correct with hardened beveled washers.
- 1.3 All surfaces free of loose scale, dirt or other foreign material.
- 1.4 Uncoated joints shall have no paint, including overspray, in the connection area.
- 1.5 Painted joints shall be blast cleaned and coated with an approved paint. Joints shall not be assembled until paint has cured for the minimum time used in paint qualification testing.
- 1.6 Galvanized joints shall be roughened by hand wire brushing prior to assembly.
- 1.7 All fastener components shall be properly lubricated and protected from contamination, dirt and moisture.
- 1.8 Hardened washers may be required under the turned element when specified by the fastener manufacturer. Special washers may be required for oversized or slotted holes. See specifications.

2.0 **TENSION VERIFICATION TESTING**

- 2.1 Equipment required:
 - 2.1.1 Calibrated bolt tension measuring device.
 - 2.1.2 Spacers and/or washers with proper hole size to adjust bolt length in tension measuring device.
 - 2.1.3 Rigid mounting for bolt tension calibrator.
 - 2.1.4 Wrenches to install fasteners in the structure.
 - 2.1.5 Appropriate supply of properly sized, uncoated, lot identified Direct Tension Indicating washers (DTIs) which meet the requirements of ASTM F-959. See paragraph 2.4.
 - 2.1.6 Suitable tapered tip flat feeler gauges Range 0.005 inches to 0.030 inches in 0.001 inch increments.
 - 2.1.7 Rigidly mounted steel plate with round hole 1/16 inch over nominal size of bolts to be installed in structure. Can utilize holes in structural steel members to be erected.
 - 2.1.8 Adequate supply of hex head HS bolts, nuts and washers to calibrate DTIs. See paragraph 2.4.1.2.

- 2.2 Testing Frequency: As a minimum, three (3) fastener assemblies shall be checked from each fastener length, diameter and grade. The testing should be done immediately prior to start of installation of the fasteners in the work. Fasteners should be retested when any significant difference is noted in the surface condition or level of lubrication of the fastener threads, nuts or washers.
- 2.3 Testing Procedure: Long bolts are defined as bolts of sufficient length so that when installed in the tension measuring device, with a hardened washer (when required), at least three (3) full threads are exposed between the nut face and the underside of the bolt head when the end of the bolt is at least flush with the outside face of the nut.
- 2.3.1 Select three (3) fastener assemblies from each diameter, length and grade.
- 2.3.2 Install each fastener assembly into the tension measuring device and install sufficient spacers and/or washers so that at least three (3) but no more than five (5) full threads are exposed between the nut face and the underside of the bolt head. The fastener manufacturer's installation procedure shall be followed for installation of bolts in the calibration device and in all connections.
- 2.3.3 Tighten each assembly using the snug tightening procedure which will be used to snug tight the fasteners in the work. Snug tight is defined as the tightness that exists when the plies of the joint are in firm contact. This may be obtained by a few impacts of an impact wrench or the full effort of a man using an ordinary spud wrench. Assure the proposed snug tightening procedure does not produce more than 50% of required fastener tension as specified by Table 11.5A below. If so, revise snug tightening procedure.

TABLE 11.5A - REQUIRED FASTENER TENSION (Kips)

Bolt Dia. (in)	1/2	5/8	3/4	7/8	1	1 1/8	1 1/4	1 3/8	1 1/2
M164 (A325)	12	19	28	39	51	56	71	85	103
M253 (A490)	15	24	35	49	64	80	102	121	148

- 2.3.4 Following the fastener manufacturer's procedure, further tighten each of the three (3) assemblies until the final twist-off of the control or indicator element. Each assembly must indicate a minimum tension as shown below.

Bolt Dia. (in)	1/2	5/8	3/4	7/8	1	1 1/8	1 1/4	1 3/8	1 1/2
M164 (A325)	13	20	29	41	54	59	75	89	108
M253 (A490)	16	25	37	51	67	84	107	127	155

- 2.4 Testing Procedure: Short bolts are defined as those lengths which are too short to meet the criteria for long bolts as described in paragraph 2.3.
- 2.4.1 DTI Calibration : Proper fastener tension for short bolts may be verified using DTIs. However, DTIs must first be calibrated as follows:
- 2.4.1.1 Select three (3) DTIs of each diameter from the same lot as identified on shipping container.
- 2.4.1.2 Using appropriate length conventional hex head bolt, nut and flat washer of same diameter as DTI, install DTI under bolt head against face plate of tension calibrator. Protrusions on DTI must bear on head of bolt.
- 2.4.1.3 Install appropriate adapter in back of tension calibrator to allow flat washer and nut to be installed. Use shims or flat washers to position three (3) to five (5) full threads between face of nut and underside of bolt head.
- 2.4.1.4 Tighten nut while holding bolt head with a suitable wrench to induce the bolt tension as shown below:

Bolt Dia. (in)	1/2	5/8	3/4	7/8	1	1 1/8	1 1/4	1 3/8	1 1/2
M164 (A325)	13	20	29	41	54	59	75	89	108
M253 (A490)	16	25	37	51	67	84	107	127	155

- 2.4.1.5 Using the feeler gauges, measure and record the opening between the DTI face and the underside of the bolt head at each location between the protrusions. The number of protrusions will vary from four (4) to eight (8) depending upon the nominal size of the DTI. Average the measurements for each DTI.
- 2.4.1.6 Average the results from the three (3) DTIs. The resulting number becomes the DTI calibration to be used to verify proper tension in the short bolts.
- 2.4.2 Select three (3) fastener assemblies from each diameter, length and grade of short bolts. Also select a DTI from the calibrated lot for each fastener assembly.
- 2.4.3 Install each fastener assembly into the proper steel plate (See 2.1.7) with the DTI under the bolt head and using sufficient spacers and/or washers so that at least three (3) but not more than five (5) full threads are exposed between the nut face and the underside of the bolt head.
- 2.4.4 Tighten each assembly to obtain a snug tight condition. Snug tight is defined as the tightness that exists when the plies of the joint are in firm contact. This may be obtained by a few impacts of an impact wrench or the full effort of a man using or ordinary spud wrench. See paragraph 2.3.3.
- 2.4.5 Using equipment and procedures recommended by the fastener manufacturer, each of the three (3) assemblies shall be tightened further until the final twist-off of the control or indicator element.
- 2.4.6 Using the feeler gauges, measure and record the opening between the DTI face and the underside of the bolt head at each location between the protrusions. The number of protrusions will vary from four (4) to eight (8) depending upon the nominal size of the DTI. Average the measurements for each DTI.

2.4.7 Average the results from the three (3) DTIs for each diameter, length and grade. This average clearance must be equal to or less than the DTI clearance determined in paragraph 2.4.1.6.

3.0 SNUG TIGHTENING PROCEDURE

3.1 Fasteners shall be installed in all holes of the connection and brought up to a snug tight condition. Washers are required if they were used in the Tension Verification Testing.

3.2 Snug tight is defined as the tightness that exists when the plies of the joint are in firm contact. This may be obtained by a few impacts of an impact wrench or the full effort of a man using an ordinary spud wrench. The snug tightening procedure used in the work shall be the same snug tightening procedure used when conducting the Tension Verification Testing in paragraph 2.3.3 and 2.4.4.

3.3 Snug tightening shall progress systematically from the most rigid part of the connection to the free edges. Start the pattern near the end of each member being spliced at the center of the pattern and work toward all edges of the splice plate.

3.4 Following this initial snug tightening, all bolts in the joint shall be again systematically tightened as necessary using a similar pattern until all bolts are simultaneously snug tight and the connection is fully compacted.

4.0 FINAL TIGHTENING

4.1 Following the snug tightening operation, all fasteners shall be further tightened until the final twist-off of the control or indicator element. All tightening shall be done using equipment and procedures recommended by the fastener manufacturer.

4.2 Tightening shall progress systematically from the most rigid part of the connection to the free edges in a manner that will minimize relaxation of previously tightened fasteners. In some cases, proper tensioning of the bolts may require more than a single cycle of systematic partial tightening prior to final twist-off of the control or indicator element of individual fasteners.

5.0 COMMENTARY

5.1 **Tension Calibrating Devices:** At the present time, there is no known economical means for determining the tension in a bolt that has previously been installed in a connection. The actual tension in a bolt installed in a tension calibrator (hydraulic tension indicating device) is directly indicated by the dial of the device, provided the device is properly calibrated. Such a device is an economical and valuable tool that should be readily available whenever high-strength bolts are to be tensioned to the specified pretension. Although each element of a fastener assembly may conform to the minimum requirements of their separate material specifications, their compatibility in an assembly or the need for lubrication can only be assured by testing of the assembly. Hence, such devices are important for confirming the complete fastened assembly as it will be used with the method of tightening to assure the suitability of bolts and nuts, including lubrication, and the adequacy of impact wrenches and/or air pressure, to provide the specified bolt tension.

Testing before start of installation of fasteners in the work will identify potential sources of problems including, but not necessarily limited to, the need for lubrication to prevent failure of bolts by combined high torque with tension, under strength assemblies due to improper marking or heat treatment or quality control of fasteners, excessive overtapping of hot-dip galvanized nuts, improper use of selected installation method by the bolting crews and/or improper or unreliable inspection techniques by inspectors. Such devices are essential to the confirmation testing of fasteners different from AASHTO M164 (ASTM A325)

or AASHTO M253 (ASTM A490) bolts, when approved by the Engineer of Record, and direct tension indicators. They are also essential to the specified procedure for the calibrated wrench method of installation, as well as for confirmation demonstration of proper use of any method by the bolting crews. They are essential for the specified procedure for arbitration inspection. They are the only known economically available tool for field use for determining realistic torque to tension relationships for given fastener assemblies.

Hydraulic tension calibrating devices capable of indicating bolt tension undergo a slight deformation under load. Hence, the nut rotation corresponding to a given tension reading may be somewhat larger than it would be if the same bolt were tightened against a solid steel abutment.

Stated differently, the reading of the calibrating device tends to underestimate the tension which a given rotation of the turned element would induce in a bolt in an actual joint. This should be borne in mind when using such devices to establish a tension-rotation relationship.

- 5.2 **Connections and Snug Tight:** Four methods for joint assembly and tightening are provided for connections. Regardless of the method used, and before beginning work, test should be administered using a tension calibrator to ensure that specified pretension will be achieved.

With any of the four described tensioning methods, it is important to install bolts in all holes of the connection and bring them to an intermediate level of tension generally corresponding to snug tight in order to compact the joint. If however, individual bolts are installed and tightened in a single continuous operation, bolts which are tightened first will be subsequently relaxed by the tightening of the adjacent bolts. The total of the forces in all bolts will be reduced which will reduce the slip load. Even after being fully tightened, some thick parts with uneven surfaces may not be in contact over the entire faying surface. This is not detrimental to the performance of the joint. As long as the specified bolt tension is present in all bolts of the completed connection, the clamping force equal to the total of the tensions in all bolts will be transferred at the locations that are in contact and be fully effective in resisting slip through friction.

With all methods, tightening should begin at the most rigidly fixed or stiffest point and progress toward the free edges, both in the initial snugging up and in the final tightening.

- 5.3 **Installation of Alternate Design Fasteners:** When high-strength bolts with mechanical properties equivalent to AASHTO M164 (ASTM A325) or AASHTO M253 (ASTM A490) but with different geometry which is intended to provide automatic control of installed bolt tension are used, the provision of this article shall apply. The bolts currently being used of this general type involve a splined end extending beyond the threaded portion of the bolt which is gripped by a specially designed wrench chuck which provides a means for turning the nut relative to the bolt. While such bolts are subject to many of the variables affecting torque mentioned in the calibrated wrench procedure, they are produced and shipped by the manufacturers as a nut-bolt assembly under good quality control which apparently minimizes some of the negative aspects of the torque controlled process.

While these alternate design fasteners have been demonstrated to consistently provide tension in the fastener meeting the requirements of Table 10.17A, in controlled tests in tension indicating devices, it must be recognized that the fastener may be misused and provide results as unreliable as those with other methods. They must be used in the as delivered clean lubricated condition. The requirements of this Specification as well as the installation requirements of the manufacturer's specification must be adhered to.

As with other methods, a representative sample of the bolts to be used should be tested to assure that they do, in fact, when used in accordance with manufacturer's instructions, provide tension as specified in Table 10.17A. In the actual joints, bolts must be installed in all holes of a connection and all fasteners tightened to an intermediate level of tension adequate to pull all material into contact. Only after this has been accomplished should the fasteners be fully tensioned in a systematic manner and the splined end sheared off. The sheared off splined end merely signifies that at some time the bolt has been subjected to a torque adequate to cause the shearing. If the fasteners are installed and tensioned in a single continuous operation, they will give a misleading indication to the inspector that the bolts are properly tightened. Therefore, the only way to inspect these fasteners with assurance is to observe the job-site testing of the fasteners and installation procedure and then monitor the work while in progress to assure that the specified procedure is routinely followed.

Archived

Appendix A5

Procedure for Inspection of High-Strength Fasteners Installation

1.0 PRE-INSTALLATION INSPECTION

- 1.1 The Engineer shall check the marking, surface condition and storage of bolts, nuts and washers and the faying surfaces of joints for compliance with the specification requirements.
- 1.2 When faying surfaces of slip critical joints are specified to be painted, the Engineer will assure that only tested and qualified coatings are applied to the members. When the painting is being done at the location where the joints are to be assembled, the Engineer will assure the coating has cured for the minimum time used in qualification testing before assembly.
- 1.3 The Engineer must verify that all bolt tension calibrators and torque wrenches have been calibrated within the last year and test certificates are available.
- 1.4 The Engineer shall witness all Rotational Capacity (R-C) tests performed at the fastener installation site to assure the tests are properly conducted, at the required frequency and test results are in compliance with the specifications.
- 1.5 The Engineer shall witness all wrench calibration, turn-of-nut verification testing, tension verification testing and direct tension indicator (DTI) calibration required by the specification requirements to assure the tests are properly conducted at the required frequency.
- 1.6 The Engineer will assure that each member of the bolting crew(s) is familiar with the procedural requirements for the tightening method selected by the contractor. Each bolting crew member must also fully understand the procedure for snug tightening the joint and fasteners, and should have demonstrated this knowledge by tightening a fastener in a bolt tension calibrator.

2.0 INSPECTION DURING INSTALLATION

- 2.1 The Engineer must constantly monitor the surface condition of fasteners in order to prevent accumulation of dirt or rust and to detect any change in the level of lubrication.
- 2.2 Allow only as many fasteners as are anticipated to be installed and tightened during a work shift to be removed from protective storage. Fasteners not used shall be returned to protected storage at the end of the shift.
- 2.3 At any time during the erection process when the Engineer suspects there may have been a change in the level of lubrication of the fasteners he should immediately require the Rotational Capacity (R-C) test to be re-conducted as well as all calibration and verification testing listed in Paragraph. 1.5.
- 2.4 The Engineer shall monitor the installation of the fasteners in the work to assure that the selected installation method, as demonstrated in the initial testing to provide the specified tension, is routinely properly applied. This monitoring shall also include verification that all plies of connected material have been drawn together and the procedure for snug tightening has been followed.

3.0 INSPECTION OF COMPLETED INSTALLATION (ARBITRATION INSPECTION)

In addition to the requirements of paragraph. 1.0 and 2.0, inspection of completed joints is required. The following inspection procedure shall be used unless a different procedure is specified in the contract documents.

- 3.1 Equipment required:
 - 3.1.1 Calibrated bolt tension measuring device.
 - 3.1.2 Spacers and/or washers with proper hole size to adjust bolt length in tension measuring device.
 - 3.1.3 Rigid mounting for bolt tension calibrator.
 - 3.1.4 Calibrated torque wrench, either dial type or other design which can be adjusted to give an indication of actual torque.
 - 3.1.5 Appropriate supply of properly sized, uncoated, lot identified Direct Tension Indicating washers (DTIs), which meet the requirements of ASTM F-959. See paragraph 3.5.3.1.
 - 3.1.6 Suitable tapered tip flat feeler gauges, range 0.005 inches to 0.030 inches in 0.001 inch increments.
 - 3.1.7 Rigidly mounted steel plate with round hole 1/16 inch over nominal size of bolts installed in structure. Can utilize holes in structural steel members.
 - 3.1.8 Adequate supply of hex head HS bolts, nuts and washers to calibrate DTIs. See paragraph 3.5.3.1
- 3.2 Inspection Responsibility - Either the Engineer or the Contractor, in the presence of the Engineer, at the Engineer's option, shall perform the inspection of completed joints using an inspection wrench (torque wrench).
- 3.3 The governing specifications for installation of high strength fasteners, or this inspection procedure do not recognize standard torques determined from tables or from formulas which are assumed to relate torque to tension in the fastener. Testing and inspection using such standard torques shall not be considered valid.
- 3.4 Frequency of Inspection - Each connection in question in the structure shall be inspected by applying, in the tightening direction, the inspecting wrench and it's job inspection torque to 10 percent of the fasteners, but not less than 2 fasteners selected at random.
- 3.5 Determination of Job Inspection Torque
 - 3.5.1 The job inspection torque shall be determined at least daily for each diameter, length and grade for which inspection will be conducted on that day.
 - 3.5.2 Job Inspection Torque: Long bolts are defined as bolts of sufficient length so that when installed in the tension measuring device, at least three (3) full threads are exposed between the nut face and the underside of the bolt head when the end of the bolt is at least flush with the outside face of the nut.
 - 3.5.2.1 Select five (5) bolts, nuts and washers, if washers were used under the turned element during installation in the structure, from each diameter, length and grade for which each individual inspection wrench is to be calibrated. The samples selected must be representative of the fasteners used in the work and should be from the same manufacturer's lot if at all possible. When the fasteners to be inspected with the inspection wrench have been installed in the structure for any significant length of time and have been exposed to the elements, the samples to be used to calibrate the inspection wrench should be selected from the fasteners in the work.
 - 3.5.2.2 Install each bolt, nut and washer (when required) assembly into the tension measuring device and install sufficient spacers and/or washers so that at least three (3) but no more than five (5) full threads are exposed between the nut face and the underside of the bolt head. The element (nut or bolt head) turned during calibration must be the same that was turned during installation of the

fasteners in the structure. Separate determinations of job inspection torque must be made if both methods were used in the work.

3.5.2.3 Tighten each assembly by any convenient means to an initial condition equal to approximately the following: (kips)

Bolt Dia. (in)	1/2	5/8	3/4	7/8	1	1 1/8	1 1/4	1 3/8	1 1/2
M164 (A325)	2	3	4	6	8	8	11	13	15
M253 (A490)	2	4	5	7	10	12	15	18	22

3.5.2.4 Then tighten each assembly by any convenient means to the following tension: (kips)

TABLE 11.5A - REQUIRED FASTENER TENSION (Kips)

Bolt Dia. (in)	1/2	5/8	3/4	7/8	1	1 1/8	1 1/4	1 3/8	1 1/2
M164 (A325)	12	19	28	39	51	56	71	85	103
M253 (A490)	15	24	35	49	64	80	102	121	148

3.5.2.5 Tightening beyond the initial condition must not produce greater rotation of the turned element than that shown below:

BOLT LENGTH (Inches)	ROTATION
4 x dia. or less	1/2 turn
Greater than 4 but no more than 8 x bolt dia.	3/4 turn
Greater than 8 x bolt dia. not exceeding 12 x	1 turn

M164 (A325)	12	19	28	39	51	56	71	85	103
M253 (A490)	15	24	35	49	64	80	102	121	148

- 3.5.3.1.7 Using the feeler gauges, measure and record the opening between the DTI face and the underside of the bolt head at each location between the protrusions. The number of protrusions will vary from four (4) to eight (8) depending upon the nominal size of the DTI. Average the measurements for each DTI. Record the average value.
- 3.5.3.1.8 Repeat steps in paragraph 3.5.3.1.2 thru 3.5.3.1.7 for the other two (2) DTIs. Average the three (3) values obtained for each DTI in step 3.5.3.1.5. This opening becomes the DTI calibration to be used to establish the "initial condition tension" as used in paragraph 3.5.2.3.
- 3.5.3.1.9 Average the three (3) values obtained for each DTI in step 3.5.3.1.7. This opening becomes the DTI calibration to be used to establish the bolt tension as used in paragraph 3.5.2.4.
- 3.5.3.2 Select five (5) bolts, nuts and washers, if washers were used under the turned element during installation in the structure, from each diameter, length and grade for which each individual inspection wrench is to be calibrated. The samples selected must be representative of the fasteners used in the work and should be from the same manufacturer's lot if at all possible. When the fasteners to be inspected with the inspection wrench have been installed in the structure for any significant length of time and have been exposed to the elements, the samples to be used to calibrate the inspection wrench should be selected from the fasteners in the work.
- 3.5.3.3 Install each bolt, nut and washer (when required) assembly into the proper steel plate (see paragraph 3.1.7) with the DTI under the bolt head and using sufficient spacers and/or washers so that at least three (3) but not more than five (5) full threads are exposed between the nut face and the underside of the bolt head.
- 3.5.3.4 With a wrench holding the bolt head, tighten each assembly by any convenient means until the DTI clearance is approximately equal to the clearance determined in paragraph 3.5.3.1.8, initial condition tension. Then further tighten the assembly until the DTI clearance is equal to the clearance determined in paragraph 3.5.3.1.9, minimum bolt tension.
- 3.5.3.5 Tightening beyond the initial condition must not produce greater rotation of the turned element than that shown below:

BOLT LENGTH (Inches)	ROTATION
4 X dia. or less	1/2 turn
Greater than 4 but no more than 8 x bolt dia.	3/4 turn

Greater than 8 x bolt dia. not exceeding 12 x	1 turn
---	--------

3.5.3.6 The inspection wrench shall then be applied to each of the five (5) tightened bolts and the torque necessary to turn the nut or bolt head 5 degrees (approximately 1 inch in a 12-inch radius) in the tightening direction shall be determined. From a practical standpoint this is the torque necessary to just start rotation of the turned element. Record all five (5) torque determinations.

3.5.3.7 The job inspection torque shall be taken as the average of the three (3) remaining values after rejecting the high and low values.

3.6 Fasteners represented by the samples referenced in paragraph 3.5.2.1 and 3.5.3.2 which have been tightened in the structure shall be inspected by applying, in the tightening direction, the inspecting wrench and its job inspection torque to 10 percent of the fasteners, but not less than 2 fasteners, selected at random in each connection in question.

3.7 If no nut or bolt head is turned by the application of the job inspection torque, the connection shall be accepted as properly tightened.

3.8 If any nut or bolt is turned by the application of the job inspection torque, all fasteners in the connection shall be tested, and all fasteners whose nut or head is turned by the job inspection torque shall be tightened and reinspected. Alternatively, the fabricator or erector, at his option, may retighten all of the fasteners in the connection and then resubmit the connection for the specified inspection.

4.0 **DELAYED VERIFICATION INSPECTION**

4.1 The inspection procedures specified in paragraph 3.0 are intended for inspection of bolted connections and verification of pretension at the time of tensioning the joint.

4.2 If verification of fastener tension is required after a passage of a period of time and exposure of the completed joints, the procedures of paragraph 3.0 will provide an indication of fastener tension which is of questionable accuracy.

4.3 Procedures appropriate to the specific situation should be used for verification of bolt tension. This might involve use of the inspection procedure contained in paragraph 3.0, or might require the development and use of alternate procedures.

5.0 **COMMENTARY**

5.1 **Tension Calibrating Devices:** At the present time, there is no known economical means for determining the tension in a bolt that has previously been installed in a connection. The actual tension in a bolt installed in a tension calibrator (hydraulic tension indicating device) is directly indicated by the dial of the device, provided the device is properly calibrated. Such a device is an economical and valuable tool that should be readily available whenever high-strength bolts are to be tensioned to the specified pretension. Although each element of a fastener assembly may conform to the minimum requirements of their separate material specifications, their compatibility in an assembly or the need for lubrication can only be assured by testing of the assembly. Hence, such devices are important for confirming the complete fastened assembly as it will be used with the method of tightening to assure the suitability of bolts and nuts,

including lubrication, and the adequacy of impact wrenches and/or air pressure, to provide the specified bolt tension.

Testing before start of installation of fasteners in the work will identify potential sources of problems including, but not necessarily limited to, the need for lubrication to prevent failure of bolts by combined high torque with tension, under strength assemblies due to improper marking or heat treatment or quality control of fasteners, excessive overtapping of hot-dip galvanized nuts, improper use of selected installation method by the bolting crews and/or improper or unreliable inspection technique by the inspectors. Such devices are essential to the confirmation testing of fasteners different from AASHTO M164 (ASTM A325) or AASHTO M253 (ASTM A490) bolts, when approved by the Engineer of Record, and direct tension indicators. They are also essential to the specified procedure for the calibrated wrench method of installation, as well as for confirmation demonstration of proper use of any method by the bolting crews. They are essential for the specified procedure for arbitration inspection. They are the only known economically available tool for field use for determining realistic torque to tension relationships for given fastener assemblies.

Hydraulic tension calibrating devices capable of indicating bolt tension undergo a slight deformation under load. Hence the nut rotation corresponding to a given tension reading may be somewhat larger than it would be if the same bolt were tightened against a solid steel abutment.

Stated differently, the reading of the calibrating device tends to under estimate the tension which a given rotation of the turned element would induce in a bolt in an actual joint. This should be borne in mind when using such devices to establish a tension-rotation relationship.

5.2

Inspection: It is apparent from the commentary on installation procedures that the inspection procedures giving the best assurance that bolts are properly installed and tensioned is provided by inspector observation of the calibration testing of the fasteners using the selected installation procedure followed by monitoring of the work in progress. This will assure that the procedure which was demonstrated to provide the specified tension is routinely adhered to. When such a program is followed, no further evidence of proper bolt tension should be required.

If testing for bolt tension using torque wrenches is conducted subsequent to the time the work of installation and tightening of bolts is performed, the test procedure is subject to all of the uncertainties of torque controlled calibrated wrench installation. Additionally, the absence of many of the controls necessary to minimize variability of the torque to tension relationship, which are unnecessary for the other methods of bolt installation. These are: use of hardened washers, careful attention to lubrication and the uncertainty of the effect of passage of time and exposure in the installed condition. These all reduce the reliability of the arbitration inspection results. The fact that in many cases it may have to be based upon a job test torque (determined using bolts only assumed to be representative of the bolts in the actual joint being tested or using bolts removed from completed joints) makes the test procedure less reliable than a properly implemented installation procedure it is used to verify. Verification inspection using ultrasonic extensometers is very accurate, but costly and time consuming, and requires that each tested bolt must be loosened to zero tension for calibration. Therefore extensometers should be used for inspection only in the most critical cases.

Archived

APPENDIX A6
PROCEDURE FOR VERIFICATION AND INSTALLATION OF HIGH
STRENGTH BOLTS WITH DIRECT TENSION INDICATORS (DTI's)
 (Part of Report No. FHWA-SA-91-031 May 1991, revised April 1992)

I. Verification of DTI Performance

Verification of DTI performance is required prior to installation of bolts in the work. In bridge work the manufacturers are typically specifying smaller gaps in the spaces between the protrusions on the washer than normally used in other construction and the gap specified for testing in the product specification ASTM F959. The basic principle used in this verification test is to make sure that there is a DTI gap at 1.05 times the required bolt installation tension greater than what is to be used as a job installation inspection requirement. The verification test method involves determining the maximum number of spaces at which a 0.005 in. tapered feeler gage is refused, does not fit into the space, at a load equal to 1.05 times the required bolt installation tension. This maximum number of spaces is one less than the job installation inspection requirement. The installation inspection requirement is often referred to as the project gap. In addition, as part of the verification test, the DTI's shall be further compressed to a level such that the inspection feeler gage is refused at all spaces between the protrusions of the washer and a visible gap still remaining in at least one space. The bolt load at this smallest gap should not cause excessive permanent inelastic deformation of the fastener. The degree of inelastic deformation is judged by removing the fastener from the test apparatus and turning the nut by hand the full length of the threads on the bolt after the test. If the nut can be turned the full thread length, the DTI smallest gap load requirement is satisfied. Alternatively the bolt load at this smallest gap should not exceed 95% of the load recorded in step 6 of the rotational capacity test for long bolts. The installation verification test shall be performed three times for each fastener rotational capacity lot on the job with the corresponding diameter of DTI to be used. If the same RC lot is to be installed with the DTI in two different positions with respect to the turned element, three tests are required for each position of the DTI. Bolts from RC lots too short to fit in the tension measuring device shall be tested by tightening in a steel plate to the minimum gap in step 6 and checked in accordance with step 7, except that the 95% alternative cannot be used. The DTI used with the short bolts should be checked in accordance with steps 1 through 5 using a longer bolt in the tension measuring device.

Equipment Required:

1. Calibrated bolt tension measuring device with a special flat insert in place of normal bolt head holding insert. Special insert required to allow access to measure DTI gap.
2. Tapered leaf thickness (feeler) gage 0.005 inch. Same gage as to be used to inspect the bolts after installation.
3. Bolts, nuts, and standard washers to be used in the work with the DTI's.
4. Impact and manual wrench to tighten bolts. Equipment should be the same as to be used in the work.

Verification Test Procedure: (Test three sets for each RC lot and position of DTI)

1. Install bolt, nut, DTI and standard washer (if used) into bolt tension measuring device. Assembly should match that to be used in the work.
2. Use another wrench on the bolt head to prevent rotation of the head against the DTI if the DTI is to be used under the unturned element.
3. Tighten bolt to tensions listed below (1.05 times the required pretension of the bolt). Use another wrench on the bolt head to prevent rotation of the head against the DTI if the DTI is to be used under the unturned element. If an impact wrench is used, tighten to a load slightly below the required load and use a manual wrench to attain the required tension. The load indicating needle of the bolt calibrator cannot be read accurately when an impact wrench is used.

Bolt Dia. (in.)	Bolt Tension (kips)								
	1/2	5/8	3/4	7/8	1	1-1/8	1-1/4	1-3/8	1-1/2
M164 (A325)	13	20	29	41	54	59	75	89	108
M253 (A490)	na	na	37	51	67	84	107	127	na

4. Determine and record the number of spaces between the protrusion on the DTI that a 0.005 in. thickness gage is refused. The total number of spaces in the various sizes and grade of DTI's is shown below.

Number of Spaces									
Bolt Dia. (in.)	1/2	5/8	3/4	7/8	1	1-1/8	1-1/4	1-3/8	1-1/2
M164 (A325)	4	4	5	5	6	6	7	7	8
M253 (A490)	na	na	6	6	7	7	8	8	na

5. The number of spaces which the 0.005 in. gage is refused should not exceed the number given in the table below. If the number of spaces exceeds the number in the table, the DTI fails the verification test.

Verification Criteria*					
Number of spaces in washer	4	5	6	7	8
Maximum number of spaces gage is refused	1	2	2	3	3

*If the test is a coated DTI under the turned element, the maximum number of spaces the gage is refused is the number of spaces on the washer minus one.

6. The bolt should be further tightened to the smallest gap to be allowed in the work. Normally, this smallest gap condition is achieved when the gaps at all the spaces are less than 0.005 in. (or a gap size as approved by the engineer) and not all gaps completely closed. When such a condition is achieved the 0.005 in. gage is refused at all spaces but a visible gap exists in at least one space. Note the load in the bolt at this smallest gap. The bolts in this installation verification test and in the actual installation should not be tightened to a no visible gap condition, i.e. a condition when all the gaps are completely closed. The load in the bolt becomes indeterminant when no gap exists. It is possible to cause bolt failure by tightening beyond complete crushing of the washer.
7. Remove the bolt from the calibrator and turn the nut on the threads of the bolt by hand. The nut should be able to be turned on the complete length of the threads, excluding the thread runout. Alternatively, if the nut is unable to go the full thread length, but the load at the minimum DTI gap (measured in step 6 above) is less than 95% of the maximum load achieved in step 6 Appendix 1 of the rotational capacity test, the assembly, including the DTI, is deemed to have passed this test. If the nut cannot be run the full thread length, and if the load at the smallest gap condition is greater than 95% of the maximum strength of the bolts from the rotational-capacity test, the load required for the smallest gap in step 6 is too large. If approved by the engineer, the test could be repeated with a larger minimum gap, for example one space that will accept a 0.005 in. feeler gage, or the DTI's could be replaced.

Short Bolts:

Bolts from RC lots too short to fit in the tension measuring device shall be tested by tightening to the minimum gap in step 6 and checked in accordance with step 7. The 95% alternative cannot be used since short bolts are not tested in the tension measuring device for rotational capacity. The DTI used with the short bolt should be checked in accordance with steps 1 through 5 using a longer bolt in the tension measuring device.

II. Installation:

- The use of a DTI under the unturned bolt head requires that the element bearing against the DTI not turn. Two men are required: One to operate the wrench, and the other to prevent turning of the element with the DTI and to monitor the gap. If the DTI is used under the turned element, an additional hardened washer must be used between the turning element and the protrusion on the DTI.
- Snug the connection to compact the joint. The DTI should be inspected after snugging and the gaps checked. If the number of spaces in which the 0.005 in. gage is refused exceeds the value in the table shown above in step 5 of the verification test, the bolt must be removed and another DTI installed. The bolt should be resnugged.
- Tighten the bolts systematically to the inspection gap. The number of spaces in which the 0.005 in. gage is refused should be equal or greater than the number shown in the table below. Tightening beyond the smallest gap established above in steps 6 and 7 is not allowed. Bolts which have a DTI with a smaller gap or no gap shall be replaced and the bolts tightened with a new DTI.

Inspection Criteria*					
Number of spaces in washer	4	5	6	7	8
Minimum number of spaces gage is refused	2	3	3	4	4

*The gage shall be refused in all spaces when a coated DTI is used under the turned element.

APPENDIX B

Definitions and Fastener Behavior

STRUCTURAL STEEL BOLTS

BOLT DESIGNATION AND TYPES



B - 1

STRUCTURAL STEEL BOLTS

M164 (A325) Bolts:

High-Strength Bolt for Structural Steel Joints.

These are heat-treated, quenched, and tempered high-strength bolts made from medium-carbon steel.

DESIGNATION

ASTM	AASHTO
A325	M164
A490	M253



B - 2

M253 (A490) Bolts:

Heat-Treated Steel Structural Bolts, 150 ksi Minimum Tensile Strength.

(These are quenched and tempered high-strength bolts made from alloy steel.)

BOLT TYPES

A325 (M164)

TYPE 1 1/2" TO 1 1/2" INCL.

TYPE 2 1/2" TO 1" INCL.

TYPE 3 1/2" TO 1 1/2" INCL.



B - 3

BOLT TYPES

Type 1 - Medium-Carbon Steel

Type 2 - Low-Carbon Martensite Steel (no longer manufactured in U.S. ASTM is considering eliminating this type).

Type 3 - Atmospheric Corrosion Resistant Weathering Characteristic Steel.

Note: AASHTO does not allow less than 5/8-inch diameter bolts.

BOLT TYPES
A490 (M253)

TYPE 1	1/2" TO 1 1/2" INCL.
TYPE 2	1/2" TO 1" INCL.
TYPE 3	1/2" TO 1 1/2" INCL.

dp 88

B-4

A490 (M253) BOLTS

Type 1 - Alloy Steel.

Type 2 - Low-Carbon Martensite Steel (no longer manufactured in U.S., ASTM is considering eliminating this type).

Type 3 - Atmospheric Corrosion Resistant Weathering Steel.

BOLT TYPES

BLACK BOLTS
GALVANIZED

A) MECHANICALLY GALVANIZED
B) HOT-DIP GALVANIZED

A490 (M253) BOLTS ARE NOT GALVANIZED

dp 88

B-5

OTHER

- Specifications do not include electroplated fasteners for bridges.
- Only two types of coated fasteners, hot-dip galvanized and mechanically galvanized fasteners, are included in the specifications for bridge application.
- New coatings are being evaluated.

STRUCTURAL NUTS DESIGNATION

ASTM	AASHTO
A194	M292
A563	M291

dp 88

B-6

Structural Nuts and Nut Designation

A194 (M292) Nuts:

Carbon and Alloy Steel Nuts for Bolts for High-Pressure and High-Temperature Service.

A653 (M291) Nuts:

Carbon and Alloy Steel Nuts.

MATCHING BOLTS & NUTS

A325 BOLT	A563 NUT, PLAIN
TYPE 1 & 2	GRADES C, C3, D,
PLAIN	DH & DH3
(UNCOATED)	OR
	A194 NUT, PLAIN
	GRADES 2 & 2H
	dp 88



B-7

MATCHING BOLTS & NUTS
(CONT.)

A325 BOLT	A563 NUT, PLAIN
TYPE 1 & 2	GRADES DH & DH3
GALVANIZED	OR
	A194 NUT, GALV.
	GRADE 2H
A325 BOLT	A563 NUT, PLAIN
TYPE 3	GRADES C3
PLAIN	& DH3
	dp 88



B-8

MATCHING BOLTS & NUTS
(CONT.)

A490 BOLT	A563 NUT, PLAIN
TYPE 1 & 2	GRADES DH & DH3
PLAIN	OR
	A194 NUT, PLAIN
	GRADE 2H
A490 BOLT	A563 NUT, PLAIN
TYPE 3	GRADE DH3
PLAIN	dp 88



B-9

BOLT AND NUT SUITABILITY

A325 (M164) Bolt Assembly

- Type 3 bolts may be used in lieu of type 1 or type 2 uncoated bolts.
- Both nonheat-treated and heat-treated matching nuts are permitted with A325 (M164) bolts.
- Grades 2H, DH and DH3 are heat-treated grades of nuts.
- Only heat-treated nuts are galvanized.
- Overtapping and lubrication requirements for A194 (M292) grade 2H nuts are the same as those for A563 (M291) nuts.

A490 (M253) BOLT ASSEMBLY

- A490 (M253) bolts are not galvanized.
- Only heat-treated nuts are permitted for A490 (M253) bolts.

**WASHER
DESIGNATION**

F 436	M293
F 959	

dp 88



B - 10

WASHER DESIGNATION AND TYPES
STEEL WASHERS

F436 (M293)

- Hardened Steel Washers
- Washers up to and including 1 1/2 inch are through hardened.

F959

- Compressible-Washer-Type Direct Tension Indicators for Use with Structural Fasteners.

WASHER TYPES

F436 (M293)
CIRCULAR WASHERS
BEVELED WASHERS
CLIPPED WASHERS

F959
TYPE 325
TYPE 490

dp 88



B - 11

F436 (M293)

These washers are manufactured from plain carbon steel or steel having atmospheric corrosion resistance and weathering characteristics.

F959

Type 325 - DTI washer for use with A325 (M164) bolts.

Type 490 - DTI washer for use with A490 (M253) bolts.

WASHERS

F436 (M293) OR F959

1. PLAIN
2. GALVANIZED
 - A. HOT-DIP GALVANIZED
 - B. MECHANICALLY GALVANIZED

*NOTE: DTIs ARE NOT HOT-DIP GALVANIZED.

dp 88



B - 12

OTHER

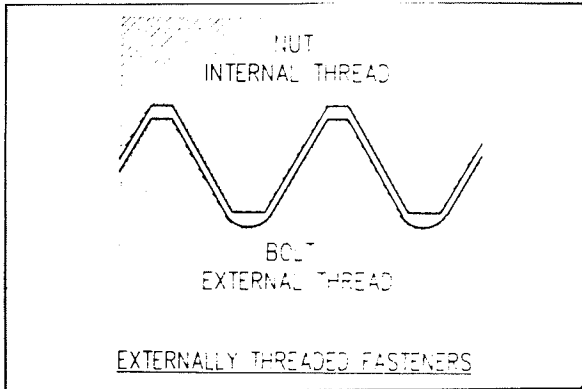

B - 13

SCREW THREAD

Screw thread is defined as a ridge of uniform section in the form of a helix on the external or internal cylindrical surface.

NOTE: ASTM A325 (M164) and A490 (M253) bolts are manufactured to dimensions specified in ANSI B18.2.1 for Heavy Hex Structural Bolts.

THREAD PROFILE

- The crest, root and flanks make up the profile of the thread. The thread profile establishes the material boundary.
- The crests are located at the top, the roots are at the bottom, and the flanks join them.
- Incomplete threads occur at the runout where threads merge into unthreaded shank or tapped holes.

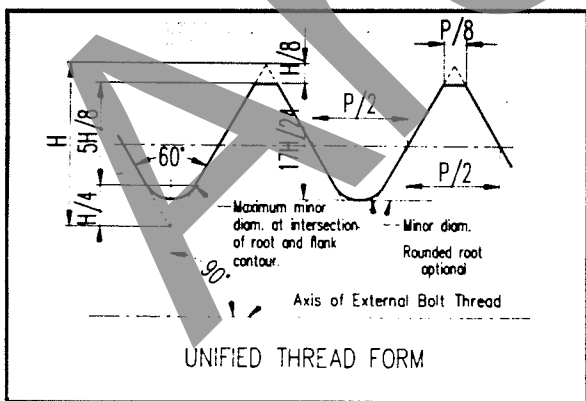

B - 14

DIAMETER (Threaded Part)

For External Threads:

- The major diameter is the diameter at the thread crest.
- The minor diameter is the diameter at the thread root.

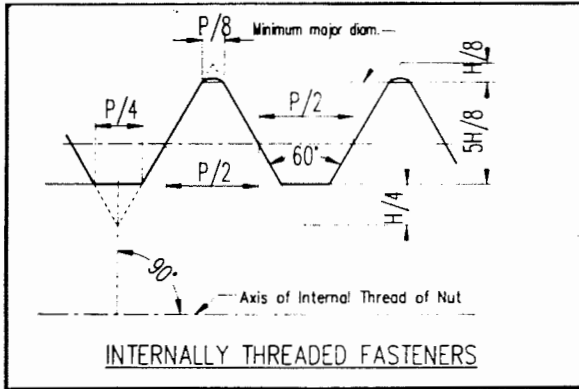

B - 15

DIAMETER THREADED PART (Cont'd.)

For Internal Threads:

- The diameter at the root is the major diameter.
- The diameter at the crest is the minor diameter.

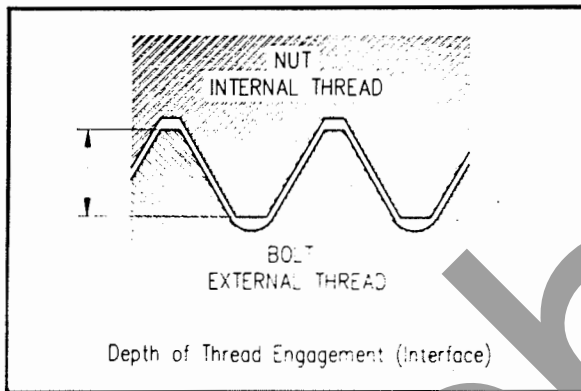

B - 16

THREAD ENGAGEMENT

Half of the difference between minor diameter of the nut and the major diameter of the bolt thread determines the amount of overlap or the depth of thread engagement.

LENGTH OF THREAD ENGAGEMENT

In assembled fasteners, it is the axial distance through which the full threads of the external and internal fasteners are in contact.

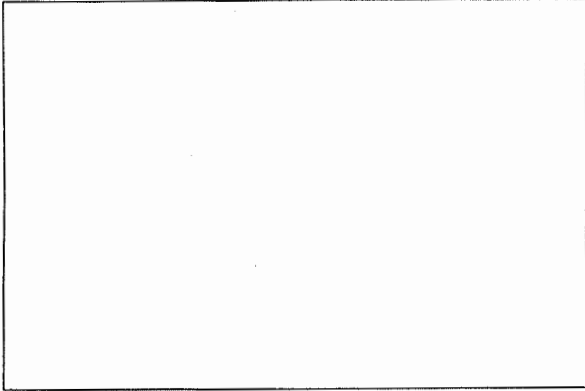

PRELOAD

The initial clamping force and/or the tension in the fastener are usually called preload. (The tensile stress introduced to the fastener during the tightening process results in a tension force within the fastener, which in turn creates the clamping force on the joint.)

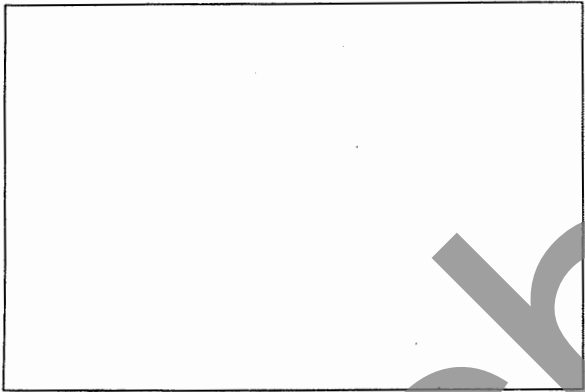

PROOF LOAD (for bolts)

Proof load is defined as the minimum specified tensile force a bolt must withstand without resulting in any measurable permanent set.

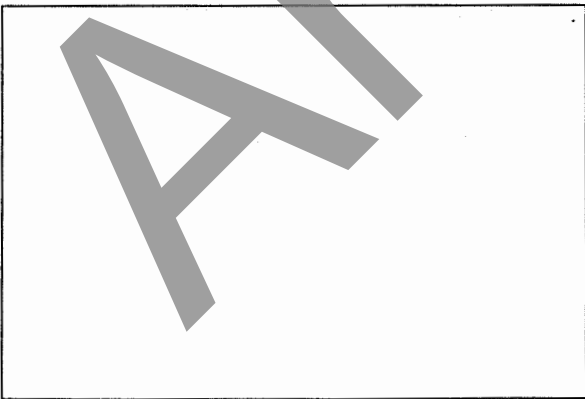

STRESS AREA (standard threads)

Stress area is a cross-sectional area based on the mean value of the pitch and minor diameters of the threads.

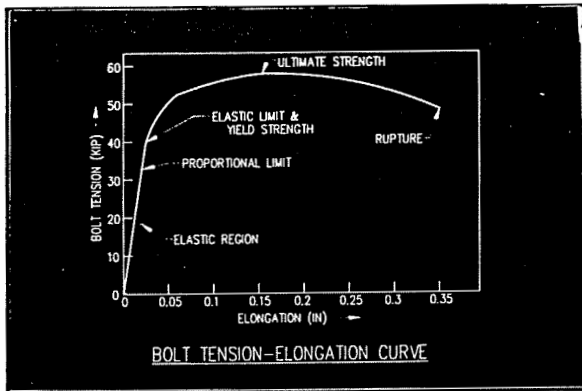

B - 17

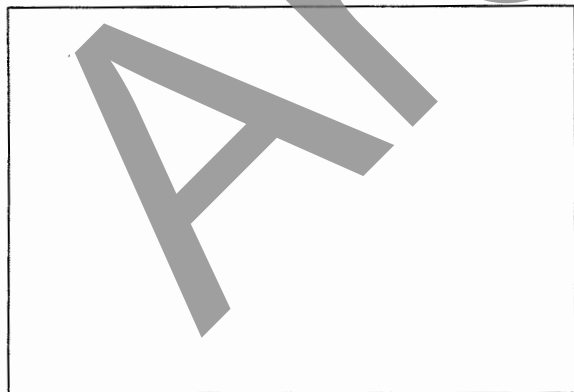
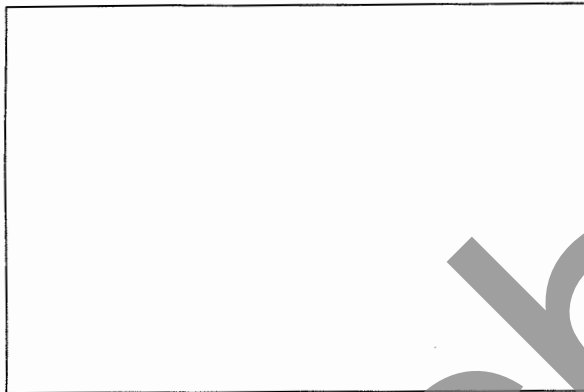

FROM LOAD vs. ELONGATION CURVES

The elastic curve shows:

- **Elastic Region:** The initial straight line portion of the load vs. elongation curve.
- **Proportional Limit:** Upper end of the elastic region.
- **Elastic Limit:** Loading the fastener to this point will cause a particular amount of permanent deformation - usually chosen as .2 or 0.5 percent of the initial length. (Tension loads beyond this point will produce some permanent deformation).
- **Yield Strength:** Is the tension applied load at which a fastener experiences a specific amount of permanent deformation.
- **Ductility:** Is the ability of the material to deform before it fractures.

The energy absorbed during the process of stretching is proportional to the area under the stress strain curve and is indicative of the ductility of the material.

The common characteristics of ductility are determined by measuring change in length and reduction in area of a machined specimen. But this is not practical in the case of threaded fasteners.

If the maximum hardness is not exceeded and if the wedge tensile test shows the required tensile strength--the ductility should be satisfactory.

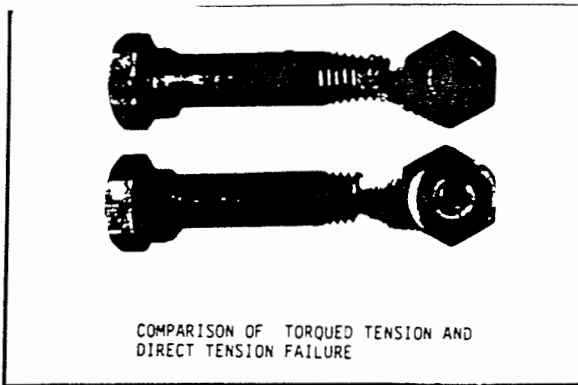

B - 18

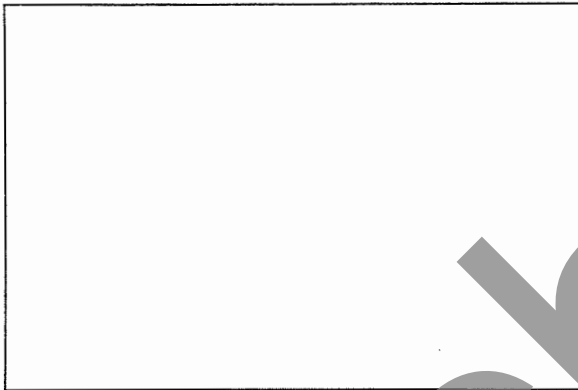

LOTS

A) PRODUCTION LOT
B) SHIPPING LOT
C) ROTATIONAL - CAPACITY LOT

dp 88

B - 19

Ratio of:

$$\frac{\text{Specified Minimum Yield Strength}}{\text{Minimum Tensile Strength}}$$

is considered a reasonable indicator of ductility.

As this ratio goes down (↓) the ductility increases (↑).

Note: Mechanical properties of bolts indicated on a load elongation curve depend on whether the bolt was subject to:

- direct tension
- or
- torqued tension

Torque and friction induce three-dimensional stress effect in the bolt resulting in different behavior than the one represented by direct tension vs. elongation curve.

LOTS

Production Lot

- The production lot for any particular fastener (e.g., bolt, nut or washer) shall consist of fasteners processed essentially together through various manufacturing operations to shipping containers. A production lot will consist of fasteners of the same size and common characteristics (e.g., grade, finish, etc.), and produced from the same mill heat of steel.

B9

**SHIPPING LOT TEST
METHOD IS NOT
PERMITTED**



B - 20

Shipping Lot

Shipping lot is defined as that quantity of fasteners of the same nominal size and the nominal length, as applicable, to fill the requirements of a single purchase order.

THE SHIPPING LOT TEST METHOD IS NOT PERMITTED BECAUSE THE FASTENER MAY OR MAY NOT HAVE BEEN MADE USING THE SAME PROCESS OR THE SAME MILL HEAT OF STEEL

Rotational-Capacity Lot

Rotational-capacity lot is defined as that quantity of fasteners from production lots of bolts, nuts and washers from which, when a certain specified number of fastener specimens are tested together as an assembly for rotational-capacity tests, they meet the test requirements.

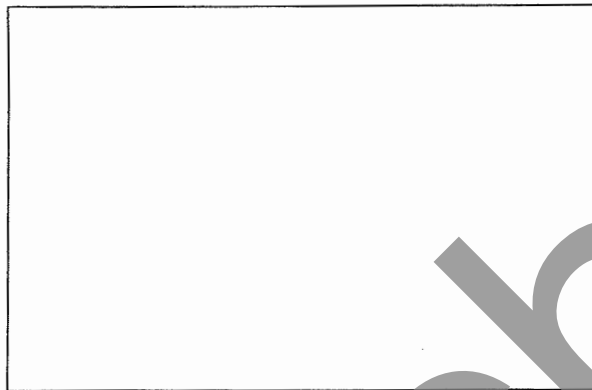

**SAMPLING
PRODUCTION LOTS**
FREQUENCY OF TESTING
REQUIRED TESTS
(i) SPECIFIED IN AASHTO
MATERIALS SPECIFICATIONS
(ii) SPECIFIED IN SUPPLEMENTAL
SPECIFICATIONS
(FHWA MEMO - 11/89) dp 88

B - 21

SAMPLING PRODUCTION LOTS

Prior to shipping fasteners production lots must be sampled by the manufacturer. Frequency of testing and test requirements vary depending on the type of fastener, i.e., whether it is a bolt, nut or washer. Refer to ASTM or AASHTO material specifications as appropriate. There are additional supplemental specifications for fasteners (FHWA Memorandum of November 1989) which will be discussed later.

REQUIRED TESTS

HARDNESS TESTS
TENSILE STRENGTH TESTS
PROOF LOAD TESTS
TESTS TO ENSURE COATING THICKNESS



B - 22

The following illustrates the requirements from the AASHTO Materials Specifications and FHWA Supplemental Specifications:

EXAMPLE: M164 BOLTS

	Frequency of Testing
Number of Pieces in Production Lot	Number of Specimens
800 and less	1
801 to 8000	2
8001 to 35000	3
35001 to 150000	8
150001 and over	13

CURRENTLY REQUIRED TESTS/ PRODUCTION LOTS

As appropriate and depending on the type of fasteners (bolts, nuts or washers) the following tests are required:

- Hardness tests
- Tensile strength tests
- Proof load tests (ASTM F606 Method 1)
- Tests to ensure coating thickness

FREQUENCY OF TESTING FOR ROTATIONAL CAPACITY

Rotational-capacity testing must be performed by the manufacturer or distributor, as appropriate, on two fastener assemblies per combination of production lots.

NUT FACTOR

Nut factor is the slope of the line representing torque-tension relationship.

$$T \leq kPD$$

k = NUT FACTOR (DIMENSIONLESS)
P = BOLT TENSION (POUNDS)
D = BOLT DIAMETER (FEET)



B - 23

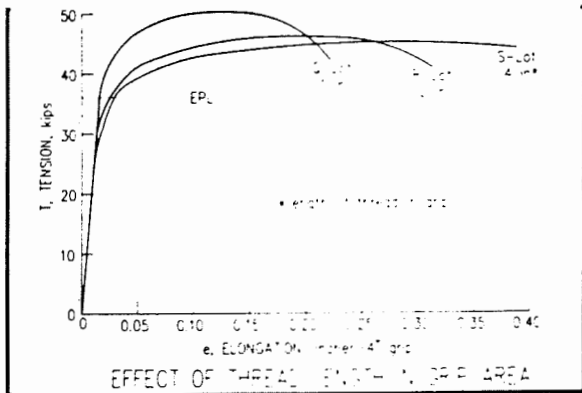

B - 24

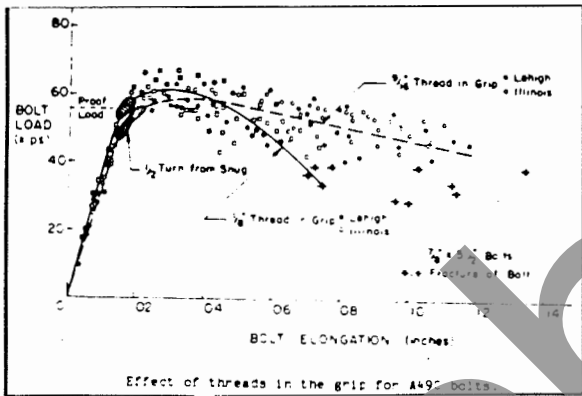

B - 25

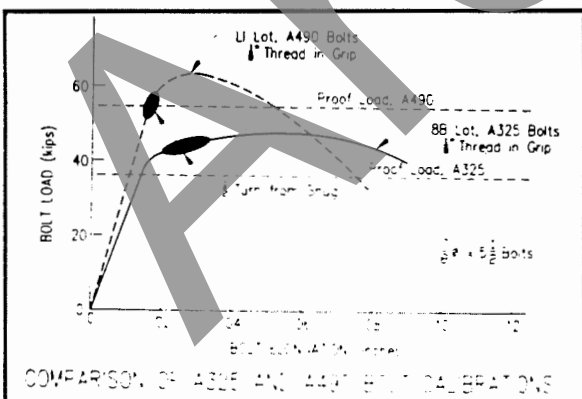

B - 26

DUCTILITY OF BOLT ASSEMBLY
VS.
NUMBER OF THREADS IN THE GRIP

Considering bolts of the same type

- The ductility increases (↑) as the number of threads are increased (↑) in the grip.
- The maximum strength reduces (↓) as the number of threads are increased (↑) in the grip.

NOTE: A325 fasteners don't seem to be sensitive to the values of maximum tensile strength with respect to thread length in grip.

SENSITIVITY OF A490 (M253) BOLTS
TO THREAD LENGTH IN GRIP

Lehigh University study shows that A490 (M253) bolts are relatively more sensitive to the number of threads in the grip, when compared with A325 (M164) bolts.

VARIATION IN MAXIMUM STRENGTH
OF A490 (M253) BOLTS AND A325
(M164) BOLTS FOR THE SAME
THREAD LENGTH IN THE GRIP

- With A490 (M253) bolts, the decrease in tension after the maximum tension is reached is much more rapid than the unloading experienced in a comparable A325 (M164) bolt assembly.
- A490 (M253) bolts have reduced ductility compared to a comparable size A325 (M164) bolt having the same length of thread in the grip.

**AS THE NUMBER OF THREADS
IN GRIP ARE REDUCED (↓),
THE REQUIRED NUMBER OF
TURNS FOR FAILURE OF
THE ASSEMBLY DECREASES (↓).**



B - 27

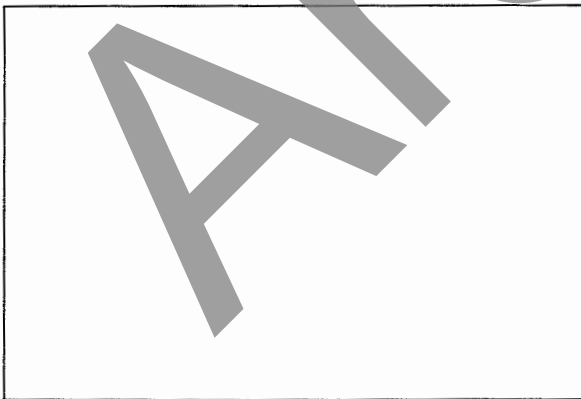
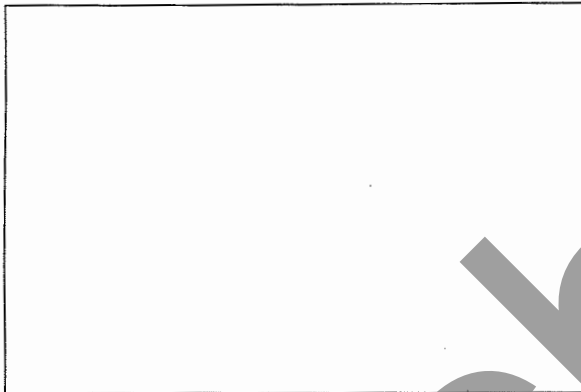

OBSERVATION

We saw that:

- As the number of threads in the grip are reduced, the assembly becomes less ductile.
- As the number of threads in the grip are reduced, the number of turns to failure are reduced.

Thus:

As ductility reduces (↓) required number of turns to failure reduce.

The standard heavy hexagonal structural bolts with short threaded lengths normally provide between $\frac{3}{8}$ " and $\frac{5}{8}$ " of thread within the grip. This would translate to about 2 turns to failure for A325 (M164) bolts.

SIGNIFICANCE OF NUT FACTOR

Variation in values of nut factor was noted because of wide variations in the thread interface conditions of the fasteners in the field.

Variation in nut factor can cause significant change in bolt tension for a given torque. The example illustrates the following:

- If the thread surface condition is changed from lubricated to clean condition, the force in the bolt would change from 53 kips to 33 kips for the same torque to 600 ft. pounds.
- Similarly, torque required to achieve the same bolt tension would depend on the thread surface condition.
- While bolts with different thread surface conditions require different values of torque, calibration test on fasteners of the same surface condition should provide a reliable installation torque.

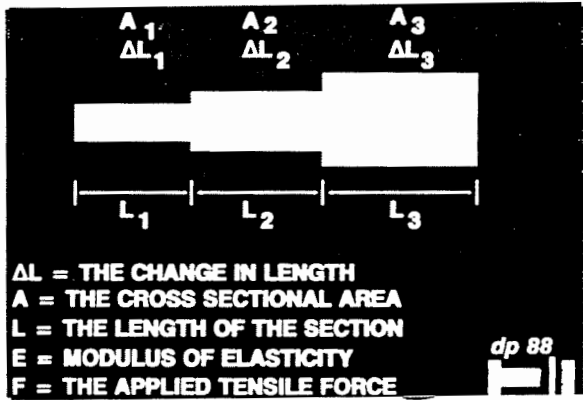

B - 28

SHORT BOLTS/LONG BOLTS and BOLT STIFFNESS

In order to understand stress distribution within a bolt and to determine preload and clamping force, the stiffness of bolt should be determined -- i.e., the force required to deform the bolt by a unit length.

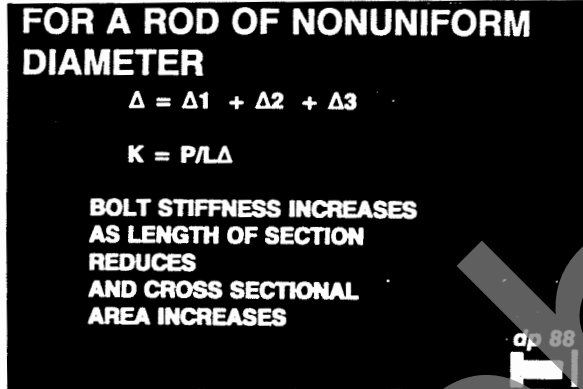

B - 29

FOR A ROD OF NONUNIFORM DIAMETER

$$\frac{1}{k} = \frac{1}{k_1} + \frac{1}{k_2} + \frac{1}{k_3} \quad Eq. (1)$$

$$\frac{1}{k} = \frac{L_1}{A_1 E} + \frac{L_2}{L_2 E} + \frac{L_3}{L_3 E} \quad Eq. (2)$$

Thus, the stiffness depends on the ratio of length and area of cross section of individual sections.

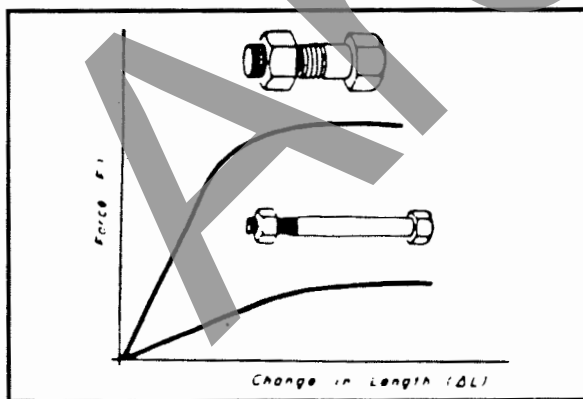

B - 30

BEHAVIOR OF SHORT AND LONG BOLT

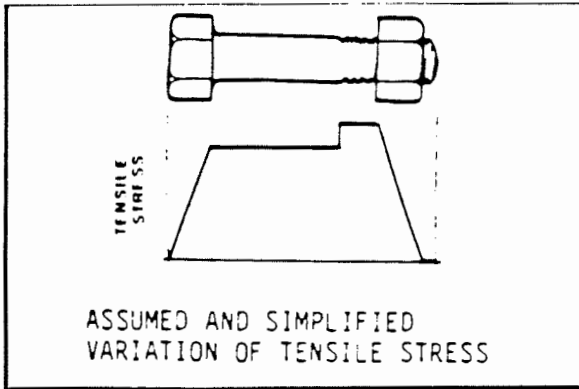

B - 31

SIMPLIFIED STRESS DISTRIBUTION IN A BOLT SUBJECT TO TENSION

The stress distribution pattern in a bolt subject to tension suggests the following critical locations of high stress intensity:

- Fillet where bolt head joins shank.
- Thread run-out point where the thread meets the shank.
- The first thread to engage the nut.

A MORE ACCURATE PLOT OF STRESS DISTRIBUTION IN A BOLT SUBJECT TO TENSION

Actual stress distribution along lines parallel to the axis of the bolt suggests that the stress concentration at the fillet and nut-bolt engagement point can be two to four times the average stress in the body of the long thin bolts (grip length/bolt dia. > 4:1) (Short bolts show no uniform stress variation in the body).

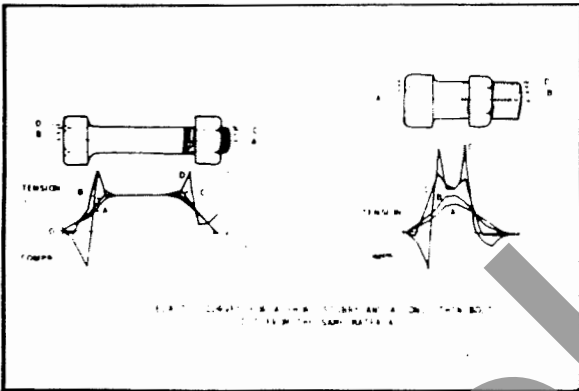

B - 32

PEAK STRESSES DISTRIBUTION IN NUT/OR BOLT THREADS

- The first three threads generally carry most load.
- Peak values of stresses in nut or bolt threads are not reduced by adding more threads (e.g., using a longer nut).

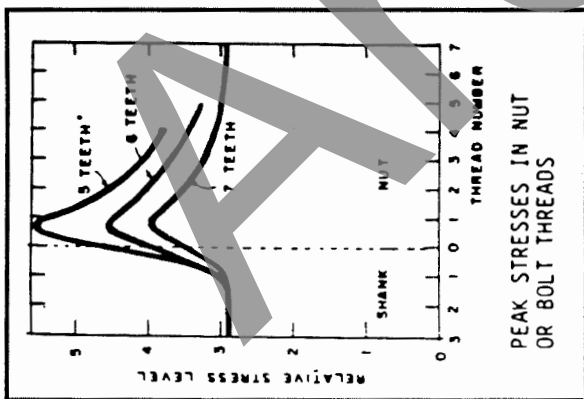

B - 33

Archived

November 1989

**SUPPLEMENTAL CONTRACT SPECIFICATIONS FOR
PROJECTS WITH AASHTO M164 (ASTM A325)
HIGH-STRENGTH BOLTS**

A. Scope

- A1. All AASHTO M164 (ASTM A325) high-strength bolts, nuts and washers shall be furnished in accordance with the appropriate AASHTO Materials Specifications as amended and revised herein.

Additional requirements for field or shop installation of AASHTO M164 (ASTM A325) high-strength bolts are also included. These additional requirements supplement AASHTO Division II, Section 10.

B. Specifications

- B1. All bolts shall meet the requirements of AASHTO M164 (ASTM A325) and these revisions.
- B2. All nuts shall meet the requirements of AASHTO M292 (ASTM A194) as applicable or AASHTO M291 (ASTM A563) and these revisions.
- B3. All washers shall meet the requirements of AASHTO M293 (ASTM F436) and these revisions.

C. Manufacturing

C1. Bolts

- 1. Hardness for bolt diameters 1/2 inch to 1 inch inclusive shall be as noted below:

Bolt Size, In.	Hardness Number			
	Brinell		Rockwell C	
	Min.	Max.	Min.	Max.
1/2 to 1 inch	248	311	24	33

C2. Nuts

- 1. Nuts to be galvanized (hot dip or mechanically galvanized) shall be heat treated grade 2H, DH, or DH3.

2. Plain (ungalvanized) nuts shall be grades 2, C, D or C3 with a minimum Rockwell hardness of 89 HRB (or Brinell hardness 180 HB), or heat treated grades 2H, DH, or DH3. (The hardness requirements for grades 2, C, D and C3 exceed the current AASHTO/ASTM requirements.)
 3. Nuts that are to be galvanized shall be tapped oversize the minimum amount required for proper assembly. The amount of overtap in the nut shall be such that the nut will assemble freely on the bolt in the coated condition and shall meet the mechanical requirements of AASHTO M291 (ASTM A563) and the rotational-capacity test herein (the overtapping requirements of AASHTO M291 [ASTM A563] paragraph 7.4 shall be considered maximum values instead of minimum, as currently shown).
 4. Galvanized nuts shall be lubricated with a lubricant containing a dye of any color that contrasts with the color of the galvanizing..
- C3. Marking - All bolts, nuts, and washers shall be marked in accordance with the appropriate AASHTO/ASTM Specifications.

D. Testing

D1. Bolts

1. Proof load tests (ASTM F606 Method 1) are required. Minimum frequency of tests shall be as specified in AASHTO M164 (ASTM A325) paragraph 9.2.4.
2. Wedge tests on full size bolts (ASTM F606 paragraph 3.5) are required. If bolts are to be galvanized, tests shall be performed after galvanizing. Minimum frequency of tests shall be as specified in AASHTO M164 (ASTM A325) paragraph 9.2.4.
3. If galvanized bolts are supplied, the thickness of the zinc coating shall be measured. Measurements shall be taken on the wrench flats or top of bolt head.

D2. Nuts

1. Proof load tests (ASTM F606 paragraph 4.2) are required. Minimum frequency of tests shall be as specified in AASHTO M291 (ASTM A563) paragraph 9.3 or AASHTO M292 (ASTM A194) paragraph 7.1.2.1. If nuts are to be galvanized, tests shall be performed after galvanizing, overtapping and lubricating.
2. If galvanized nuts are supplied, the thickness of the zinc coating shall be measured. Measurements shall be taken on the wrench flats.

D3. Washers

1. If galvanized washers are supplied, hardness testing shall be performed after galvanizing. (Coating shall be removed prior to taking hardness measurements).
2. If galvanized washers are supplied, the thickness of the zinc coating shall be measured.

D4. Assemblies

1. Rotational-capacity tests are required and shall be performed on all black or galvanized (after galvanizing) bolt, nut and washer assemblies by the manufacturer or distributor prior to shipping. Washers are required as part of the test even though they may not be required as part of the installation procedure.

The following shall apply:

- a. Except as modified herein, the rotational-capacity test shall be performed in accordance with the requirements of AASHTO M164 (ASTM A325).
- b. Each combination of bolt production lot, nut lot and washer lot shall be tested as an assembly. Where washers are not required by the installation procedures, they need not be included in the lot identification.
- c. A rotational-capacity lot number shall be assigned to each combination of lots tested.
- d. The minimum frequency of testing shall be two assemblies per rotational-capacity lot.
- e. The bolt, nut and washer assembly shall be assembled in a Skidmore-Wilhelm Calibrator or an acceptable equivalent device (note - this requirement supersedes the current AASHTO M164 (ASTM A325) requirement that the test be performed in a steel joint). For short bolts which are too short to be assembled in the Skidmore-Wilhelm Calibrator, See Section D4.li.
- f. The minimum rotation, from a snug tight condition (10% of the specified proof load), shall be:

240° (2/3 turn)	for bolt lengths	< 4 diameters
360° (1 turn)	for bolt lengths	> 4 diameters and < 8 diameters
480° (1 1/3 turn)	for bolt lengths	> 8 diameters

(Note: that these values differ from the AASHTO M164 Table 8/ ASTM A325 Table 6 Specifications).

- g. The tension reached at the above rotation shall be equal to or greater than 1.15 times the required installation tension. The installation tension and the tension for the turn test are shown below:

Diameter (In.)	1/2	5/8	3/4	7/8	1	1 1/8	1 1/4	1 3/8	1 1/2
Req. Installation Tension (kips)	12	19	28	39	51	56	71	85	103
Turn Test Tension (kips)	14	22	32	45	59	64	82	98	118

- h. After the required installation tension listed above has been exceeded, one reading of tension and torque shall be taken and recorded. The torque value shall conform to the following:

$$\text{Torque} \leq 0.25 PD$$

Where

Torque = measured torque (foot-pounds)
P = measured bolt tension (pounds)
D = bolt diameter (feet).

- i. Bolts that are too short to test in a Skidmore-Wilhelm Calibrator may be tested in a steel joint. The tension requirement of Section D4.1g need not apply. The maximum torque requirement of Section D4.1h shall be computed using a value of P equal to the turn test tension shown in the table in Section D4.1g.

D5. Reporting

1. The results of all tests (including zinc coating thickness) required herein and in the appropriate AASHTO specifications shall be recorded on the appropriate document.
2. Location where tests are performed and date of tests shall be reported on the appropriate document.

D6. Witnessing

1. The tests need not be witnessed by an inspection agency; however, the manufacturer or distributor that performs the tests shall certify that the results recorded are accurate.

E. Documentation

E1. Mill Test Report(s) (MTR)

1. MTR shall be furnished for all mill steel used in the manufacture of the bolts, nuts, or washers.

2. MTR shall indicate the place where the material was melted and manufactured.

E2. Manufacturer Certified Test Report(s) (MCTR)

1. The manufacturer of the bolts, nuts and washers shall furnish test reports (MCTR) for the item furnished.
2. Each MCTR shall show the relevant information required in accordance with Section D5.
3. The manufacturer performing the rotational-capacity test shall include on the MCTR:
 - a. The lot number of each of the items tested.
 - b. The rotational-capacity lot number as required in Section D4.1c.
 - c. The results of the tests required in Section D4.
 - d. The pertinent information required in Section D5.2.
 - e. A statement that MCTR for the items are in conformance to this specification and the appropriate AASHTO specifications.
 - f. The location where the bolt assembly components were manufactured.

E3. Distributor Certified Test Report(s)(DCTR)

1. The DCTR shall include MCTR above for the various bolt assembly components.
2. The rotational-capacity test may be performed by a distributor (in lieu of a manufacturer) and reported on the DCTR.
3. The DCTR shall show the results of the tests required in Section D4.
4. The DCTR shall also show the pertinent information required in Section D5.2.
5. The DCTR shall show the rotational-capacity lot number as required in Section D4.1c.
6. The DCTR shall certify that the MCTR are in conformance to this specification and the appropriate AASHTO specifications.

F. Shipping

- F1. Bolts, nuts and washers (where required) from each rotational-capacity lot shall be shipped in the same container. If there is only one production lot number for each size of nut and washer, the nuts and washers may be shipped in separate containers. Each container shall be permanently marked with the rotational-capacity lot number such that identification will be possible at any stage prior to installation.
- F2. The appropriate MTR, MCTR or DCTR shall be supplied to the contractor or owner as required by the Contract Documents.

G. Installation

The following requirements for installation apply in addition to the specifications in AASHTO Division II, Section 10 when high-strength bolts are installed in the field or shop.

- G1. Bolts shall be installed in accordance with AASHTO Division II Article 10.17.4. During installation, regardless of the tightening method used, particular care should be exercised so that the snug tight condition as defined in Article 10.17.4 is achieved.
- G2. The rotational-capacity test described in Section D4 above shall be performed on each rotational-capacity lot prior to the start of bolt installation. Hardened steel washers are required as part of the test although they may not be required in the actual installation procedures.
- G3. A Skidmore-Wilhelm Calibrator or an acceptable equivalent tension measuring device shall be required at each job site during erection. Periodic testing (at least once each working day when the calibrated wrench method is used) shall be performed to assure compliance with the installation test procedures required in AASHTO Division II, Article 10.17.4.1 for Turn-of-Nut Tightening, Calibrated Wrench Tightening, Installation of Alternate Design Bolts and Direct Tension Indicator Tightening. Bolts that are too short for the Skidmore-Wilhelm Calibrator may be tested using direct tension indicators (DTIs). The DTIs must be calibrated in the Skidmore-Wilhelm Calibrator using longer bolts.
- G4. Lubrication
 1. Galvanized nuts shall be checked to verify that a visible lubricant is on the threads.
 2. Black bolts shall be "oily" to the touch when delivered and installed.

3. Weathered or rusted bolts or nuts not satisfying the requirements of G2 or G3 above shall be cleaned and relubricated prior to installation. Recleaned or relubricated bolt, nut and washer assemblies shall be retested in accordance with G2 above prior to installation.
- G5. Bolt, nut and washer (when required) combinations as installed shall be from the same rotational-capacity lot.

Archived

Archived