



U. S. Department
of Transportation
**Federal Railroad
Administration**

Safety of High Speed Guided Ground Transportation Systems

Office of Research
and Development
Washington, D.C. 20590

Broadband Magnetic Fields: Their Possible Role in EMF-Associated Bioeffects



DOT/FRA/ORD-93/29
DOT-VNTSC-FRA-93-17

Final Report
August 1993

This document is available to the
public through the National Technical
Information Service, Springfield, VA 22161

NOTICE

This document is disseminated under the sponsorship of the Department of Transportation in the interest of information exchange. The United States Government assumes no liability for its contents or use thereof.

NOTICE

The United States Government does not endorse products or manufacturers. Trade of manufacturers' names appear herein solely because they are considered essential to the object of this report.

NOTICE

This document is a contractor report performed for the Federal Railroad Administration, and is not being distributed as an EPA document. The report is solely the work of the contractor and has not been subject to technical or policy reviews within the Agency. The views and conclusions contained in this report are those of the contractor and do not necessarily reflect those of the U.S. Environmental Protection Agency.

REPORT DOCUMENTATION PAGEForm Approved
OMB No. 0704-0188

Public reporting burden for this collection of information is estimated to average 1 hour per response, including the time for reviewing instructions, searching existing data sources, gathering and maintaining the data needed, and completing and reviewing the collection of information. Send comments regarding this burden estimate or any other aspect of this collection of information, including suggestions for reducing this burden, to Washington Headquarters Services, Directorate for Information Operations and Reports, 1215 Jefferson Davis Highway, Suite 1204, Arlington, VA 22202-4302, and to the Office of Management and Budget, Paperwork Reduction Project (0704-0188), Washington, DC 20503.

1. AGENCY USE ONLY (Leave blank)

2. REPORT DATE
August 19933. REPORT TYPE AND DATES COVERED
Final Report
January 1993 - June 19934. TITLE AND SUBTITLE
Safety of High Speed Guided Ground Transportation Systems
Broadband Magnetic Fields: Their Possible Role in EMF-
Associated Bioeffects5. FUNDING NUMBERS
R3010/RR3936. AUTHOR(S)
Don Goellner, Dr. Barry Wilson, Dr. Russel Reiter, Dr. Arthur
Pilla, Norbert Hankin, Lynne Gillette, Barbara Hostage7. PERFORMING ORGANIZATION NAME(S) AND ADDRESS(ES)
U.S. Environmental Protection Agency*
Office of Air and Radiation
Washington, DC 204608. PERFORMING ORGANIZATION
REPORT NUMBER
DOT-VNTSC-FRA-93-179. SPONSORING/MONITORING AGENCY NAME(S) AND ADDRESS(ES)
U.S. Department of Transportation
Federal Railroad Administration
Office of Research and Development
Washington, DC 2059010. SPONSORING/MONITORING
AGENCY REPORT NUMBER
DOT/FRA/ORD-93/29

11. SUPPLEMENTARY NOTES

*Under contract to: U.S. Department of Transportation
Research and Special Programs Administration
John A. Volpe National Transportation Systems Center
Cambridge, MA 02142

12a. DISTRIBUTION/AVAILABILITY STATEMENT

This document is available to the public through the National
Technical Information Service, Springfield, VA 22161

12b. DISTRIBUTION CODE

13. ABSTRACT (Maximum 200 words)

This report reviews electric and magnetic field (EMF) exposures from electrical transportation systems, including electrically powered rail and magnetic levitation (maglev). Material also covered includes research concerning biological effects of EMF exposure, with special emphasis on broad spectrum or broadband magnetic fields. A primary objective of this report was to consider, based on present knowledge, the potential for adverse health effects from maglev-associated EMF. Because maglev technology is known to generate magnetic fields at a variety of frequencies, this document addresses the broadband EMF frequency characteristics (including pulses, intermittent fields, and other transient phenomena).

One objective of this review was to consider whether, based on present knowledge, exposure to maglev-associated magnetic fields would warrant any special consideration related to possible adverse health effects. There may be unique combinations of ac and dc fields associated with maglev operation, but there is no evidence that such combinations have any special properties in terms of their potential EMF biological effects. From currently available occupational epidemiologic data for electrical transport workers, available clinical and laboratory data on EMF biological effects, and available information on maglev-generated magnetic fields, we conclude that maglev is not likely to represent greater risk, if any, than that from electrical transport systems already in use.

14. SUBJECT TERMS

Electric and Magnetic fields (EMF), Exposures, Electrical Transportation Systems, Maglev,
Potential Adverse Health Effects, Broadband EMF Frequency Characteristics, EMF Biological
Effects, Occupational Epidemiologic Data

15. NUMBER OF PAGES
220

16. PRICE CODE

17. SECURITY CLASSIFICATION
OF REPORT
Unclassified18. SECURITY CLASSIFICATION
OF THIS PAGE
Unclassified19. SECURITY CLASSIFICATION
OF ABSTRACT
Unclassified

20. LIMITATION OF ABSTRACT

**SYSTÈME INTERNATIONAL (SI) UNIT DEFINITIONS AND
CONVERSIONS USED IN THIS REPORT**

DISTANCE (ENGLISH-TO-SI CONVERSION):

1 inch (in)	= 2.54 centimeters (cm)	= 0.025 meters (m)
1 foot (ft)	= 30.5 centimeters (cm)	= 0.305 meters (m)
1 yard (yd)	= 91.4 centimeters (cm)	= 0.914 meters (m)
1 mile (mi)	= 1.61 kilometers (km)	= 1,610 meters (m)

ELECTRICAL QUANTITIES:

Electric Fields

1 volt/meter (V/m)	= 0.01 volts/centimeter (V/cm)
1 kilovolt/meter (kV/m)	= 1000 volts/meter (V/m)
1 kilovolt/meter (kV/m)	= 10 volts/centimeter (V/cm)

Magnetic Flux Densities (English-to-SI Conversion)

10,000 gauss (G)	= 1 tesla (T)
10 milligauss (mG)	= 1 microtesla (μ T)
1 milligauss (mG)	= .1 microtesla (μ T)
0.01 milligauss (mG)	= 1 nanotesla (nT)

Electromagnetic Frequency Bands

1 cycle per second	= 1 hertz (Hz)
1,000 cycles per second	= 1 kilohertz (kHz)

Ultra Low Frequency (ULF) Band	= 0 Hz to 3 Hz
Extreme Low Frequency (ELF) Band	= 3 Hz to 3 kHz
Very Low Frequency (VLF) Band	= 3 kHz to 30 kHz
Low Frequency (LF) Band	= 30 kHz to 300 kHz

PREFACE

This document was prepared for the U.S. Environmental Protection Agency (EPA), Office of Radiation and Indoor Air (ORIA), Radiation Studies Division (RSD), under an interagency agreement with the Department of Transportation (DOT) Research and Special Programs Administration (RSPA), John A. Volpe National Transportation Systems Center (Volpe Center), on behalf of the Federal Railroad Administration (FRA).

These agencies are interested in characteristics of magnetic fields associated with electrically powered and magnetically levitated high-speed transportation systems, because results from epidemiologic studies suggest a link between surrogates for exposure to power frequency electromagnetic fields and increased risk for certain cancers and other adverse health effects.

This report is a review of the biological effects of electric and magnetic fields (EMF), with emphasis on laboratory animal and human exposure to EMF fields that have components over a range of frequencies. Of special interest are magnetic fields that contain a range of frequency components, including those with pulsed or intermittent characteristics. These diverse kinds of fields include those that have been referred to in the literature as transient or broad spectrum, and will be designated here as broadband EMF, although many do not meet the strict definition of a broadband signal.

EMF bioeffects literature is growing at an accelerating rate, owing primarily to the research stimulated by results from epidemiologic studies of EMF exposure's possible effects on health. In order to make this document as timely as possible, non-peer-reviewed literature is cited when relevant, including materials from journals that may not be peer-refereed, abstracts, and government reports. Cited literature that may not have been peer-reviewed will be designated as such (e.g., abstracts and government reports) in the references section.

A premise of this review is that weak EMF is detectable by many biological systems. Biological effects from weak electric and magnetic fields have been reported, and many have been replicated in laboratories. Whether such biological effects can lead to health effects in humans remains to be determined. It is clear that broad spectrum EMF, including those found in many occupational settings, can induce signals in biological tissue that are above the thermal noise threshold in biological systems. However, this may not be an absolute requirement for detectability. Numerous reports of responses to weak magnetic fields that occur widely in nature, as well as with laboratory animals and in clinical settings with humans, constitute strong evidence that biological effects can be observed with exposure to weak fields.

The purpose of this document is to review the literature with special emphasis on biological effects observed from exposure to non-sinusoidal and broad spectrum EMF. Magnetically levitated (maglev) vehicles and other electrically powered transport systems are sources of such fields, as is much of the electrical equipment that constitutes the end-use of 50-60 Hz power. It is important to determine what implications, if any, can be drawn from the literature with regard to potential health effects from exposure to these fields.

The technical monitor for this report was Dr. Aviva Brecher of the Volpe Center who manages the FRA's Research Program. Guidance and program support was provided by Robert Dorer, the High Speed Guided Ground Transportation (HSGGT) Safety Program Manager at the Volpe Center. At the FRA, Arne Bang served as sponsor and is the Manager of Special Programs.

TABLE OF CONTENTS

<u>Section</u>	<u>Page</u>
1. EXECUTIVE SUMMARY	1-1
2. BACKGROUND	2-1
2.1 Synopsis	2-1
2.2 Introduction	2-1
2.3 General Description of EMF	2-2
2.4 EMF Exposures From Household Appliances and Power Lines	2-7
2.5 Comparisons of Magnetic Fields Associated With Electric Transport to Existing Exposure Guidelines	2-9
2.6 Overview of Biological Effects from EMF Exposure	2-11
2.7 EMF Epidemiologic Studies Overview	2-16
3. MAGNETIC FIELD CHARACTERISTICS OF THE TRANSPRAPHIC MAGLEV VEHICLE AND ELECTRIC RAIL TRANSPORT SYSTEMS	3-1
3.1 Synopsis	3-1
3.2 Introduction	3-1
3.3 Transrapid TR-07 Maglev Magnetic Field Characteristics	3-3
3.4 Electrically Powered Rail Transport Systems	3-6
3.5 The Massachusetts Bay Transit Authority and the Washington, D.C., Metro (Subway) Systems	3-8
3.6 Surface Rail Systems	3-9
3.7 Electric Trolleys and Trolley Buses	3-11
3.8 Comparisons of Magnetic Fields Associated with Transrapid Maglev with Fields from Other Electric-Powered Systems	3-11
3.9 Health-Effects-Related Studies Involving Electric Rail Transport and Maglev Magnetic Fields	3-13
3.10 Conclusions	3-14
4. BROADBAND EMF AND PROPOSED MECHANISMS FOR THEIR DETECTION BY BIOLOGICAL SYSTEMS	4-1
4.1 Synopsis	4-1
4.2 Introduction	4-1
4.3 Induced Electrical Fields and Currents: Knowledge Gained From Clinical Appliances	4-2
4.4 The Problem of Signal to Noise Ratio (Detectability)	4-4
4.4.1 Cell Array Model	4-5
4.4.2 Signal to Noise Calculations Under Biologically Relevant Assumptions	4-8
4.5 Proposed Models for Interaction of EMF with Biological Systems	4-11
4.5.1 The Electrochemical Information Transfer Model	4-11
4.5.2 Extensions of the Electrochemical Information Transfer Model	4-13

TABLE OF CONTENTS (Cont'd)

<u>Section</u>	<u>Page</u>
4.6 Direct Magnetic Field Interaction Mechanisms	4-13
4.6.1 Ion Cyclotron Resonance	4-13
4.6.2 The Quantum Theories	4-15
4.6.3 Coherence	4-15
4.6.4 Magnetite	4-16
4.6.5 Free Radical Mechanisms	4-16
4.7 Summary	4-18
5. BIOLOGICAL REPOSSES TO EMF	5-1
5.1 Synopsis	5-1
5.2 Sensing of EMF in Nature	5-1
5.3 Therapeutically Related Studies on EMF Field Effects	5-2
5.3.1 Non-Union Bone Fracture Repair	5-2
5.3.2 Cellular Studies	5-4
5.3.3 In Vivo Studies	5-6
5.4 EMF Effects on Biological Systems: Toxicology and Mechanisms-Oriented Studies	5-8
5.4.1 In-Vitro Studies	5-8
5.4.2 In-Vitro Studies Using Simulated Maglev Magnetic Field Exposure	5-13
5.4.3 In-Vivo Studies	5-13
5.4.4 Effects on Neuroendocrine Function	5-14
5.4.5 Studies on Neuroendocrine Effects of Simulated Maglev Fields	5-25
5.4.6 Other CNS Effects of EMF Exposure	5-25
5.4.7 In-Vivo Cancer Studies	5-26
5.4.8 Effects on Behavior	5-28
5.5 Summary	5-29
6. THE NEUROENDOCRINE HYPOTHESIS: A PLAUSIBLE MECHANISM FOR EMF-ASSOCIATED HEALTH EFFECTS	6-1
6.1 Synopsis	6-1
6.2 Introduction	6-1
6.3 The Neuroendocrine Immune Axis	6-2
6.4 EMF Effects on Circadian Rhythms	6-3
6.5 Neuroendocrine Effects of EMF Exposure	6-4
6.6 The Neuroendocrine Hypothesis	6-5
6.6.1 Pineal Function and Cancer Risk	6-7
6.7 Discussion and Conclusions	6-10

TABLE OF CONTENTS (Cont'd)

<u>Section</u>	<u>Page</u>
7. EPIDEMIOLOGIC STUDIES CONCERNING EMF EXPOSURES	7-1
7.1 Synopsis	7-1
7.2 Introduction	7-1
7.3 Evidence Supporting Causal Associations in Epidemiologic Studies	7-2
7.4 Overview of Cancers Linked to EMF Exposure	7-3
7.4.1 Carcinogenesis: The Process of Cancer	7-3
7.4.2 Cancers Linked to EMF Exposure	7-6
7.4.2.1 Leukemia	7-7
7.4.2.2 Neuroblastoma	7-7
7.4.2.3 Brain and Central Nervous System Cancers	7-8
7.4.2.4 Breast Cancer	7-8
7.4.2.5 Melanoma	7-9
7.4.2.6 Lymphomas	7-9
7.4.2.7 Prostatic Cancer	7-9
7.5 Epidemiologic Studies Linking EMF and Cancer	7-10
7.5.1 Use of Surrogates for EMF	7-10
7.5.2 Residential Studies	7-11
7.5.3 Occupational Studies	7-13
7.5.3.1 Occupational Studies on Central Nervous System Cancer	7-17
7.5.3.2 Occupational Studies on Malignant Melanoma	7-18
7.5.3.3 Occupational Studies on Male Breast Cancer	7-18
7.5.3.4 Occupational Studies on Lymphomas	7-19
7.6 Mood Disorders and Circadian Function Linked to EMF Exposure	7-20
7.6.1 Overview	7-20
7.6.2 Epidemiologic Studies considering Mood and Affect	7-22
7.7 Epidemiologic Studies Considering Electric Blanket Use	7-22
7.8 Studies on Video Display Terminal Use	7-24
7.9 Epidemiologic Studies Related to Electric Transport Workers	7-24
7.10 Conclusions	7-27
7.11 Summary	7-29
8. MAGLEV MAGNETIC FIELDS AND EMF-ASSOCIATED BIOLOGICAL EFFECTS	8-1
8.1 Synopsis	8-1
8.2 Introduction	8-1
8.3 Specificity in Response to EMF Exposure	8-1
8.4 Magnetic and Electromagnetic Effect Mechanisms	8-3
8.5 Proposed Dose Metrics for Environmental Magnetic Fields	8-4
8.6 Magnetic Field Parameters and Dose in Induced Field Models	8-5
8.7 Magnetic Field Parameters Determining Dose in the Direct Magnetic Effect Models	8-6
8.8 Expert Opinion on What May Constitute Dose	8-7

TABLE OF CONTENTS (Cont'd)

<u>Section</u>	<u>Page</u>
8.9 Electrically-Powered Transport System Magnetic Fields and Biological Effects Studies	8-8
8.10 Report Summary and Conclusions	8-9
9. REFERENCES	9-1
9.1 References for Section 2	9-1
9.2 References for Section 3	9-4
9.3 References for Section 4	9-5
9.4 References for Section 5	9-11
9.5 References for Section 6	9-26
9.6 References for Section 7	9-30
9.7 References for Section 8	9-38
APPENDIX A PINEAL GLAND FUNCTION AND MELATONIN: PHYSIOLOGICAL EFFECTS OF MELATONIN AND CONSEQUENCES OF PINEAL DYSFUNCTION	A-1
A.1 Introduction	A-1
A.2 Melatonin Synthesis	A-3
A.3 Physiological Effects of Melatonin	A-9
A.4 Physiological Consequences of Pineal Gland Dysfunction	A-9
A.4.1 Reproduction and Development	A-9
A.4.2 Depression	A-12
A.4.3 Cancer	A-14
A.4.4 Immune System Effects	A-17
A.4.5 Aging Effects	A-18
A.5 Summary	A-20
A.6 References for Appendix A	A-20

LIST OF FIGURES

<u>Figure</u>		<u>Page</u>
2-1	ELECTROMAGNETIC SPECTRUM SHOWING SELECTED BANDS	2-2
2-2	SEVERAL INCIDENT MAGNETIC FIELD WAVEFORMS	2-5
2-3	MAGNETIC FIELD SOURCES IN THE 1-200 Hz FREQUENCY RANGE ...	2-7
2-4	NORMALIZED RESPONSE CURVES AS A FUNCTION OF FREQUENCY	2-14
2-5	MAGNETIC FIELD FLUX DENSITIES	2-15
3-1	MAGNETIC FIELD ON THE TR-07 VEHICLE	3-4
3-2	PRESENTATION OF FLUX DENSITY AND TIME DATA IN TR-07	3-5
3-3	TIME-VARYING MAGNETIC FIELD LEVELS ON THE NEC AND NJCL	3-10
4-1	ELECTRIC FIELD WAVEFORMS FROM THERAPEUTIC & ENVIROMENTAL DEVICES	4-3
4-2	FIRST ORDER LINEAR ELECRCIC MODEL FOR A CELL ARRAY IN GAP JUNCTION CONTACT	4-7
4-3	FREQUENCY DEPENDENCE OF SPATIAL AMPLIFICATION FOR VARIOUS CELL ARRAY LENGTHS	4-7
4-4	FREQUENCY DEPENDENCE OF SNR ON ARRAY LENGTH	4-9
4-5	FREQUENCY DEPENDENCE OF THE SPECTRAL RATIO OF THE INDUCED TRANSMEMBRANE VOLTAGE ON ARRAY LENGTH	4-10
4-6	EFFECT OF MAGNETIC FIELD ON THE ENERGY OF TRIPLET STATES	4-17
5-1	SCHEMATIC OF THE INTERACTION BETWEEN REGULATORY AND CODING REGIONS AND THE ACTION OF REGULATORY PROTENS AND RNA POLYMERASE IN THE TRANSCRIPTION PROCESS	5-11
5-2	POSSIBLE SHORT AND LONGER TERM CONSEQUENCES OF NEUROTRANSMITTER BINDING	5-12

LIST OF FIGURES (Cont'd)

<u>Figure</u>	<u>Page</u>
5-3 METABOLIC PATHWAYS FOR SYNTHESIS OF NEUROTRANSMITTERS AND METABOLITES FROM TYROSINE AND TRYPTOPHAN	5-15
5-4 RATIOS OF MELATONIN AND 5MTOL TO INTERNAL STANDARDS IN PINEAL GLANDS OF RATS	5-16
5-5 PINEAL MELATONIN AND NAT LEVELS IN RATS	5-18
5-6 NIGHTLY URINARY EXCRETION OF THE CHIEF MELATONIN METABOLITE	5-20
5-7 CHANGES IN PINEAL NAT ACTIVITY AND MELATONIN CONTENT IN RATS	5-23
5-8 NAT ACTIVITY AS MEASURED IN RESPONSE TO SIX DIFFERENT MAGNETIC FIELD EXPOSURES	5-24
6-1 POSSIBLE CONSEQUENCES OF EMF DETECTION BY THE PINEAL GLAND	6-6
6-2 FINDINGS THAT LED TO THE BREAST CANCER HYPOTHESIS BY STEVENS	6-9
7-1 MODEL FOR CANCER	7-4
7-2 TUMOR OUTCOMES AND EXPECTED OUTCOMES IN ANIMAL EXPERIMENTS	7-5
7-3 CELLULAR CHANGES THAT OCCUR IN THE CARCINOGENETIC PROCESS	7-6
8-1 RESULTS FROM A POLL OF EXPERT OPINION AS TO THE RELEVANCE OF MAGNETIC FIELD DOSE METRICS TO CLASSES OF BIOLOGICAL EFFECTS	8-8
A-1 MEDIAL VIEW OF A HALF OF THE HUMAN BRAIN	A-2
A-2 ANATOMICAL CONNECTIONS BETWEEN THE EYES AND THE PINEAL GLAND OF MAMMALS	A-4

LIST OF FIGURES (Cont'd)

A-3	SYNTHESIS OF MELATONIN AND OTHER TRYPTOPHAN-DERIVED COMPOUNDS	A-5
A-4	NIGHT RISE IN SERUM MELATONIN LEVELS	A-7
A-5	LEVELS OF THE CHIEF MELATONIN METABOLITE	A-7
A-6	CONCOMITANT SERUM AND SALIVARY MELATONIN LEVELS	A-8
A-7	NIGHTTIME LEVELS OF BLOOD MELATONIN	A-11
A-8	PINEAL GLAND IN ELDERLY MEN EXHIBITS SHORTER DURATION OF ELEVATED MELATONIN	A-13
A-9	POSSIBLE CONSEQUENCES OF EMF DETECTION BY THE PINEAL GLAND	A-15

LIST OF TABLES

<u>Section</u>	<u>Page</u>
2-1 STATE REGULATIONS AND POLICIES FOR TRANSMISSION LINE RIGHTS OF WAY (RoW)	2-10
2-2 OCCUPATIONAL EXPOSURES TO EXTREMELY LOW MAGNETIC FIELDS (mG)	2-12
3-1 DEVIATION OF MAGNETIC FIELD FLUX DENSITY BY ERM DESIGNATED FREQUENCY BAND	3-6
3-2 COMPARISON OF STANDARD AND AVERAGE DEVIATIONS OF THE MEASURED PASSENGER COMPARTMENT MAGNETIC FIELD	3-12
5-1 CELLULAR EFFECTS OF EMF	5-5
5-2 EFFECT OF MAGNETIC FIELD EXPOSURE ON MAMMARY TUMOR LATENCY	5-27
7-1 RELATIVE RISKS FOR CHILDHOOD LEUKEMIA	7-13
7-2 EPIDEMIOLOGIC STUDIES BY OCCUPATION/MAGNETIC FIELD	7-15
7-3 EPIDEMIOLOGIC STUDIES ON USE OF ELECTRIC BLANKETS	7-24
7-4 EPIDEMIOLOGIC STUDIES OF WORKERS IN THE ELECTRICALLY- POWERED RAIL TRANSPORT SECTOR	7-25
8-1 EXAMPLES OF STUDIES CONSISTENT WITH EACH OF SEVEN SELECTED DOSE METRICS	8-5

1. EXECUTIVE SUMMARY

Introduction of magnetically levitated (maglev) trains into the U.S. transportation sector is being planned at a time when uncertainty exists regarding the possibility of adverse health effects from exposure to extremely low frequency (ELF) and broadband electric and magnetic fields (EMF). To assess the state of knowledge about anticipated EMF exposures from electrically operated transportation systems, including electrically powered rail and maglev, laboratory and clinical studies concerning biological effects of EMF exposure, with special emphasis on broad spectrum or broadband magnetic fields, were reviewed.

Epidemiologic studies, including several on electrical transport workers, are briefly discussed. The observed association between magnetic field exposure and increased cancer risk in the occupational epidemiologic studies is based mainly on surrogate measures for magnetic field exposure, such as job title. Exposure data from actual measurements, where available, is of interest in attempting to determine which characteristics of the magnetic fields, if any, might constitute dose as related to reported biological effects. Whether such biological effects may lead to adverse health effects remains to be determined.

A primary objective of this report was to consider, based on present knowledge, the potential for adverse health effects from maglev-associated EMF. In this regard, it is important to distinguish between biological effects, such as changes in heart rate, and adverse health effects, such as increased risk of leukemia. There is ample evidence for biological effects of weak magnetic field exposure in mammalian species. Evidence for adverse (pathological effects), on the other hand, derives primarily from epidemiologic studies and is inconclusive.

Because maglev technology is known to generate magnetic fields at a variety of frequencies, this document addresses the broadband frequency characteristics of such fields and their possible importance in the biological effects observed from EMF exposure. Magnetic fields exhibiting high time-rates-of-change, including pulses and other transient phenomena, may be classified as broad spectrum or broadband because of their higher frequency components. Likewise, intermittent field exposure is included in the broadband definition because of low frequency components, including those of less than 1 Hz. Since the time-rate-of-change for a given signal waveform increases with increasing signal intensity or flux density strength, high field strength is a factor that contributes to the broadband nature of time-varying fields. The term "broadband" is not used here in its strictest sense as it relates to all magnetic fields discussed. Rather, the term is employed in this report to distinguish the complex magnetic fields that are at issue from those that are purely sinusoidal at power frequencies (50-60 Hz).

In this review, we have attempted to relate the types of magnetic fields measured in maglev and other technologies to the proposed mechanisms for biological effect of exposure to EMF as determined in various laboratory studies. Induced current models, those that assume physiologic effect arises from electric fields induced in tissue by time-varying magnetic fields, provide the best explanation for a number of therapeutic effects in humans as determined by clinical experience. These models have been the basis for design and successful application of a number of clinical devices. The various direct magnetic effect models, including magnetic resonance models, do not explain EMF effects in humans (as observed in clinical studies) as well as the induced current models do.

Based on in-vivo and in-vitro laboratory and clinical studies, there is now a growing recognition that the cell membrane is the most likely site of interaction in determining biological effects from EMF exposure. Important endpoints for transduction of the signal appear to be in organized biological structures that are electrically connected to facilitate cell-to-cell communication. It is in consideration of these larger, more complex biological structures that the evidence and theoretical underpinnings for a biological response to EMF become strongest.

Mathematical descriptions of anticipated changes resulting from magnetic-field-induced perturbations in such extended aggregates of cells in electrical contact are provided. Weak environmental signals are often in a frequency and intensity range that allow sufficient signal-to-noise ratios to be obtained by cell arrays of physiologically relevant size. This leads to the conclusion that, in organized tissue, biological effects are indeed possible from exposure to remarkably weak EMF. Regarding in-vitro studies, effects have been reported from several laboratories from exposure to 60 Hz fields with flux densities in the 1 uT range. For in-vivo studies, there is clear evidence of both static and time-varying magnetic field effects in the 1-100 uT range. Magnetic fields of these flux densities have been associated with both maglev and conventional electrically powered rail transport technologies.

There is growing recognition that the pineal gland and its principal hormone, melatonin, play an important role in communication among the neurological, endocrine, and immune systems. Several reviews of the EMF health effects issue, including the recent Oak Ridge Associated Universities (ORAU) report, recognize the biological effects of EMF exposure involving pineal gland function. Thus, changes in pineal gland function resulting from EMF exposure and the associated alterations in concentrations of the hormone melatonin are discussed relative to the induced current model. Alterations in either the amplitude or phase of the melatonin circadian rhythm have been linked, through animal or human studies, with each of the broad areas of interest arising from EMF epidemiologic studies. These include cancer, reproduction, and mood disorders. EMF effects on neuroendocrine function are discussed as an example of how an observed biological effect (e.g., reduction in pineal melatonin synthesis) may be related to a health effect (e.g., increased breast cancer risk in males) as suggested by the epidemiologic studies.

Under some conditions, weak anthropogenic EMF have been shown to affect significant physiological processes in both cellular and animal systems. This is especially evident in the case of rapidly changing magnetic fields that induce stronger currents in the body than do fields with slower rates of change. Possible longer term consequences of these fields and their physiological effects are mentioned and discussed. We conclude that, although a causal link between exposure to EMF and increased health risk has not been established for humans, cellular and animal studies offer evidence that such links are at least plausible.

An eventual determination of whether EMF exposure affects human health will require that more be learned about the longer term effects of the observed physiologic changes in animals, and better exposure assessment will be required from epidemiologic studies. It is not unreasonable to suspect that magnetic fields that can affect important physiological processes may have both beneficial and adverse effects on health.

Data from measurements of magnetic field flux density and associated frequency characteristics in conjunction with epidemiologic studies are insufficient to make any clear determination of which field characteristics may constitute dose with regard to adverse health effects.

One objective of this review was to consider whether, based on present knowledge, exposure to maglev-associated magnetic fields would warrant any special consideration related to possible adverse health effects. Based on data on magnetic fields generated by Transrapid maglev as well as by a number of electrically powered rail transport systems currently in use, there appear to be no significant characteristics of the maglev field, in terms of flux density, or frequency components that are not found among the magnetic fields generated by rail transport technologies in current use. There may be unique combinations of ac and dc fields associated with maglev operation, but there is no evidence that such combinations have any special properties in terms of their potential biological effects.

Recent laboratory data from experiments to determine possible cellular and neuroendocrine effects of a synthetic maglev magnetic field showed no effects on several in-vitro cellular systems tested. At increased amplitude, a pulsed dc field, used as a positive control, was effective in altering pineal gland function. Slight alterations in pineal enzyme activity were also observed from exposure to a high amplitude (7 x measured amplitude) synthetic maglev field.

Nonetheless, from currently available occupational epidemiologic data for electrical transport workers, available clinical and laboratory data on EMF biological effects, and available information on maglev-generated magnetic fields, we conclude that maglev is not likely to represent greater risk, if any, than that from electrical transport systems already in use.

2. BACKGROUND

2.1 SYNOPSIS

Attributes of the electromagnetic spectrum are described in terms of the quantum energy and other characteristics of the various frequency ranges and their associated wavelengths. Properties of EMF at extremely low frequencies are discussed. Background on induction of electric fields in conducting tissue by changing magnetic fields and the interaction of magnetic fields with magnetic moments is also provided. Magnetic fields encountered in residential and occupational settings are discussed in terms of their flux density, frequency, and corresponding induced currents. Limitations on magnetic field exposures as recommended by government agencies, scientific bodies, or as legislated in several states are presented.

Epidemiologic studies relevant to maglev magnetic fields are introduced, and the lack of a scientific consensus regarding the possibility of adverse health effects is discussed. This chapter provides a brief overview of the biological effects attributed to weak EMF and the scientific issues involved.

2.2 INTRODUCTION

Growth in generation and use of electrical power over the last century has resulted in dramatic increases in human exposure to EMF from almost every segment of the electromagnetic spectrum. Time-varying EMF is ubiquitous in the human habitat of the United States and many other industrialized countries. In modern commercial environments, as well as in urban and rural residential settings, exposure to these fields is essentially unavoidable.

Introduction of maglev trains into the U.S. transportation sector is being planned at a time when much uncertainty exists regarding possible adverse health effects from exposure to time-varying EMF. Electrically powered mass transportation has existed for nearly a century. The EMF associated with maglev technology, however, may have characteristics different from those associated with older electrically powered rail technologies.

Recognizing the known characteristics of maglev-associated magnetic fields, we have emphasized EMF exposure parameters other than the customarily considered time-weighted average field strength. Specifically, we have considered the broadband frequency characteristics of these fields including possible effects of intermittent exposure, transients or pulses capable of inducing electric currents in biological tissue in the 1-100 mV/cm range, as well as other temporal aspects of magnetic field exposure. As a background to the main technical areas pertinent to this review, we discuss generally the properties of EMF and reported biological effects from EMF exposure.

2.3 GENERAL DESCRIPTION OF EMF

Energy associated with electromagnetic waves is proportional to frequency according to the equation $E=h\nu$ and is thus inversely proportional to wavelength (see Figure 2-1). At frequencies above approximately 10^{16} Hz (with wavelengths in the 10^{-10} m range), electromagnetic radiation has sufficient energy to cause ionization by scattering electrons. At these quantum energies, electromagnetic radiation (e.g., x-rays and gamma rays) can easily break chemical bonds giving rise to highly reactive free radical species, as well as causing direct damage to genetic material in cells. In this frequency range, particle characteristics of the fields are most apparent. The term radiation is appropriately used at these frequencies, and the effects of these fields can best be thought of as arising from the interaction of high-energy photons with matter. Ionizing radiation's effects on biological tissue have been extensively studied and are relatively well understood. Acute leukemia is the cancer most closely associated with exposure to ionizing radiation, although risks for several other types of cancer, most notably cancer of the lung, may be greatly enhanced by ionizing radiation, even at low doses.

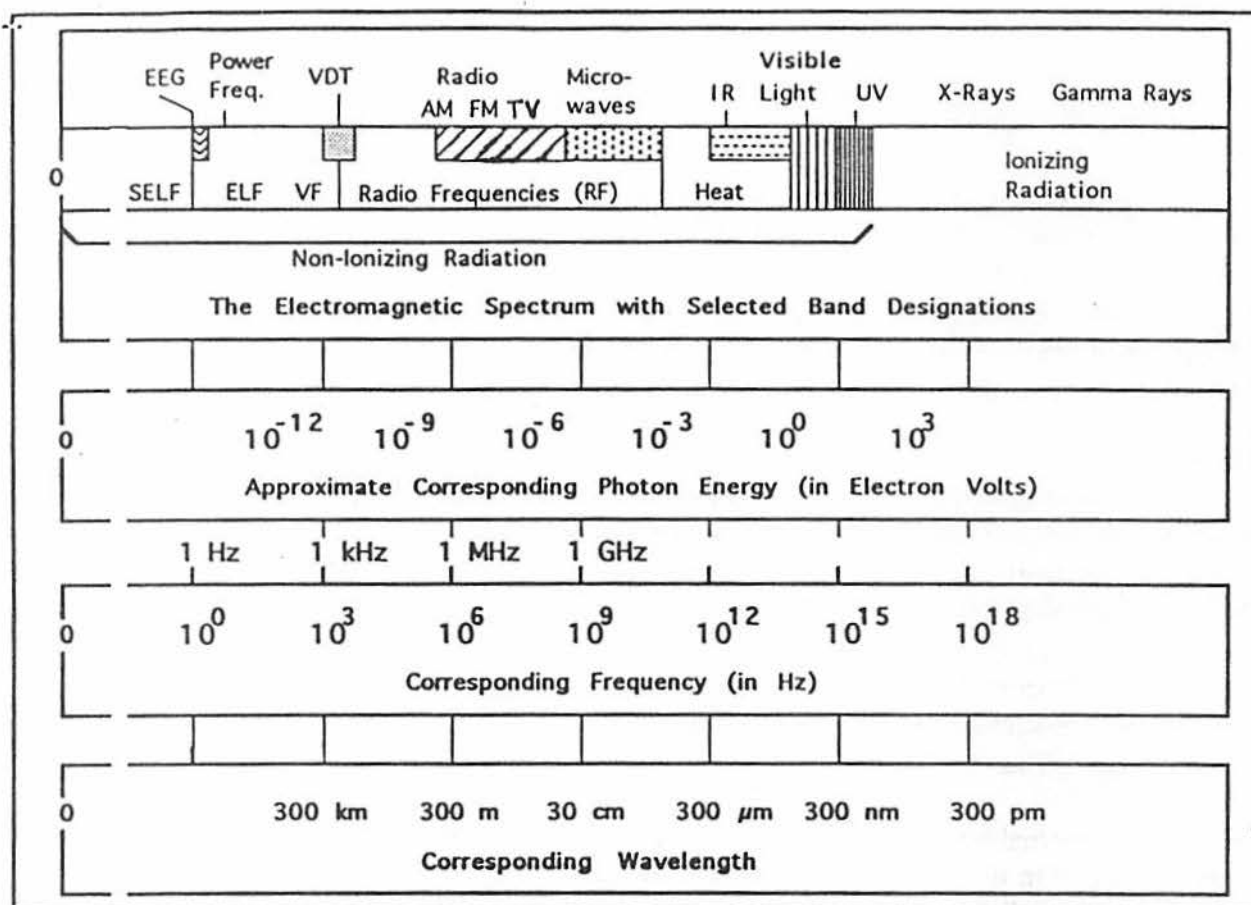

Figure 2-1. The electromagnetic spectrum showing selected bands for assigned commercial uses, as well as frequency ranges for electroencephalogram (EEG) activity and VDT emissions. Approximate corresponding energies, wavelengths, and frequencies are also depicted.

Although chemical changes may be demonstrated in response to impinging light in the ultraviolet (UV) ranges, these fields are rapidly attenuated with depth of penetration in biological tissue. Overexposure to UV light does have a well-known association with skin cancer, especially in fair-skinned individuals.

At lower frequencies, in visible and infra-red ranges, electromagnetic radiation can be sensed as light and heat, each of which can have profound effects on biological systems. Particle characteristics of EMF can be demonstrated at these lower energies by phenomena such as the photoelectric effect, wherein photons interact with electrons on a discrete basis that is detectable by resulting electric currents. However, electromagnetic radiation in the visible, ultraviolet, and lower frequency ranges is best conceptualized as consisting of waves. Wave-like properties such as diffraction patterns are readily demonstrated for EM waves in this frequency range.

In the microwave frequency regime (3×10^8 to approximately 3×10^{11} Hz), irradiation of biological tissue with sufficient flux density can cause heating, although the microwaves are not sensed directly as heat. EMF exposures at these frequencies are best understood in terms of the thermal effects of these fields on tissue. At lower radio frequencies, tissue heating can still occur given sufficient flux density. The ability of radio frequency (RF) fields to cause heating increases with frequency. At wavelengths close to the dimensions of body structures, local resonances can occur, and local heating may be substantially increased leading to "hot spots." There are also non-thermal biological effects from EMF exposure in the RF range. Most notable among these are the effects of pulsed RF fields on the electroencephalogram (Adey, 1992).

In the ELF region of the electromagnetic spectrum (now designated as 3 - 3000 Hz), wavelengths are long, on the order of several thousand kilometers, fields are essentially non-radiative, and the EMF components are largely decoupled. For the purposes of this review, ELF will be used to designate the range between 0 and 3000 Hz.

In a vacuum or in air, electric field lines of force extend radially in all directions from an electric charge or charged object. A conducting object, such as a human or rodent body, placed in the electric field causes substantial distortion. Electric field penetration of the body, however, is slight because impinging field lines cause charge within the conducting body to re-orient so as to counter the external field almost completely. In time-varying electric fields, small internal body currents are induced. However, due to the attenuation of the field at the surface of the body, internal fields and their associated induced currents are small compared to the imposed external field.

Surface or internal body currents, resulting from the presence of an external electric field, flow primarily in the same direction as the overall field gradient (e.g., from higher to lower potential). A well-documented effect of high strength ac electric fields on the body is that of hair vibration (piloerection) which allows perception of the electric field (Tenforde, 1991).

Like electric fields, magnetic fields are vector quantities having both magnitude and direction. Magnetic fields may be described in terms of their field strength (H), or their flux density (B). In a vacuum (and for all practical purposes in air), the two quantities are related by the equation $B = \mu_0 H$, where μ_0 is the permeability of free space and is equal to $4 \pi \times 10^{-7}$.

As is customary for ELF and static fields, we will use the magnetic field flux density (B) to quantify the magnetic field in this report. The magnetic flux density is expressed in terms of Tesla (T) or Gauss (G). Although the Tesla is now the preferred unit in the scientific literature, the Gauss remains the more commonly used term (1 Tesla = 10,000 Gauss). This document uses both terms. In addition, because of the common usage in the literature, the terms "field strength" or "intensity" may be used to denote flux density (B).

In contrast to electric fields, magnetic fields do not induce a surface charge. Magnetic fields penetrate the body with little or no attenuation because the permeability of biological tissue is essentially the same as that of air. Changing magnetic fields induce electric (E) fields in conducting bodies according to Faraday's Law:

$$\oint \mathbf{E} \cdot d\mathbf{l} = - dB/dt$$

This simply states that the electromotive force induced by a magnetic field is proportional to the rate at which the magnetic field is changing. In other words,

$$\text{Electromotive Force} = - dB/dt$$

where:

Electromotive Force is in volts, B is the magnetic field flux density in Tesla, and t is time in seconds.

Electromotive force or induced field voltage is thus proportional to the time-rate-of-change of the field (dB/dt) and is therefore, for a given frequency, proportional to the amplitude of B. Induced current in a nearby conducting body is proportional to the electromotive force (or induced electric field) and is also directly proportional to the radius of the induced current path. It is inversely proportional to the resistance of the conducting body. Currents induced by magnetic fields circulate in the conductor in a plane at right angles (orthogonal) to the impinging field lines. Figure 2-2 depicts, for example, waveforms for several common magnetic fields generated in the laboratory and the waveforms for the currents induced by these fields. Thus, the waveforms in the right-hand panels are the first derivatives of those of the left-hand panels.

In determining induced currents from magnetic fields, the size of the test subject and frequency of the field are parameters that must be considered along with field intensity. Induced electric currents discussed here are a consequence of Faraday's Law. For an excellent review of ELF EMF field interactions with biological tissue, including many facets outside the scope of this discussion, see Tenforde, 1991.

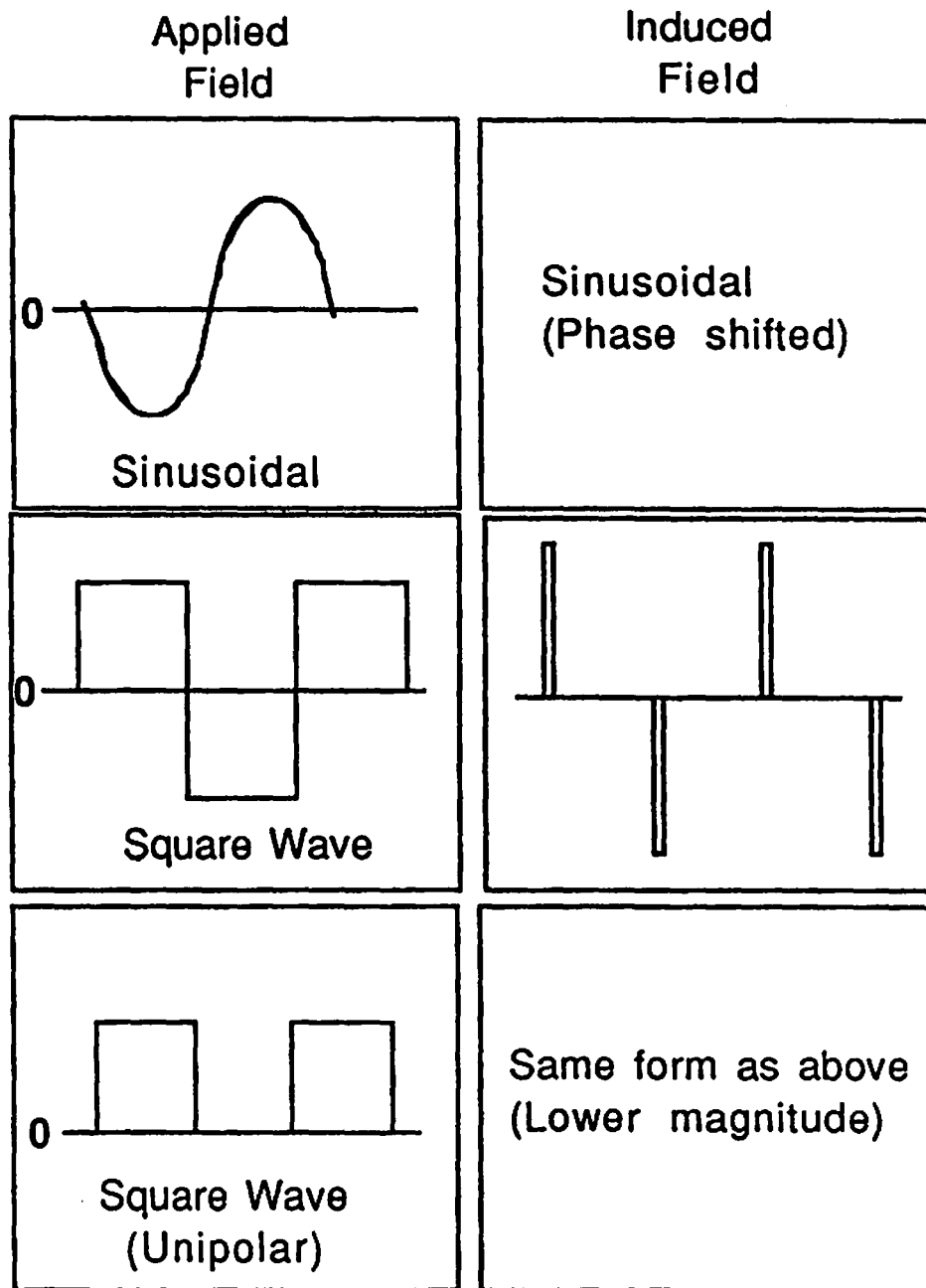

Figure 2-2. Depictions of several incident magnetic field waveforms and their corresponding induced field waveforms. No attempt is made to show relative amplitude of the induced currents. Waveforms in the right-hand panels are, to a first approximation, the first time derivative of the signals in the left-hand panels. The bipolar dc pulse waveform has been shown effective in modulation of rat pineal indoleamine metabolism in several laboratories. (Lerchl, *ital.*, 1991)

Another important class of magnetic field interactions arises as a consequence of the Lorentz force. Magnetic fields exert a torque on charges moving with respect to the field. This Lorentz force is given by the equation

$$\mathbf{F} = q \mathbf{v} \times \mathbf{B}$$

where:

- F** is the force on the test charge,
- q** is the charge,
- v** is the velocity of the charge in the magnetic field,
- B** is the magnetic field flux density.

Note that the resultant force is the vector cross-product of **v** and **B** and is thus at right angles to the field and the direction of motion of the charge. As a consequence, the motion of charged particles in a magnetic field tends to describe a circle. The Lorentz force is an important consideration in mechanisms assuming that biological effects arise directly from influence of the field on ion motion.

Energy deposition into biological tissue from ELF EMF at typical human exposure levels is extremely low and is exceeded by the thermal energy already present at ambient temperature. Primarily because ELF EMF are of such low quantum energy, some scientists reject the possibility that these fields could have biological effects within certain constraints (Adair, 1991). Many of these objections are based on oversimplifications of complex biological systems and do not consider cell shape, conductive properties, and intracellular organization, and thus are not relevant. Objections to meaningful EMF interactions with biological systems are often maintained despite the demonstrated ability of several species of animals to detect and use information from both the electric and magnetic components of these low-energy fields (Tenforde, 1989), and the clinical use of these fields.

The earth's geomagnetic field is on the order of 50 μT (0.5 G). It is primarily a non-time-varying (dc) field, with the angle of incidence to the earth's surface increasing with latitude. Near the poles, the magnetic field lines of force are almost perpendicular to the earth's surface; at the equator, they are nearly parallel. Anthropogenic ELF magnetic fields are primarily time-varying at electric power generating frequencies of 50 or 60 Hz and harmonics of those frequencies. Magnetic field strength depends on proximity to current-carrying electrical conductors, such as power lines and home appliances. Typical magnetic fields measured in residential settings range from 0.1 to 3 μT (1 to 30 mG) at 60 Hz (Kaune et al., 1987).

ELF electric fields in the environment arise primarily from energized electrical conductors. Residential ELF electric fields generally range from approximately 1 to 1000 V/m, the higher range being associated with such appliances as electric blankets. Typical field measurements in a residential "family room" range from approximately 20 to 40 V/m (Kaune et al., 1987).

2.4 EMF EXPOSURES FROM HOUSEHOLD APPLIANCES AND POWER LINES

When evaluating possible consequences of the additional EMF exposure resulting from new technologies, it is instructive to compare new exposures to those encountered on an everyday basis. Exposures arise from external power lines, internal residential and industrial wiring, including grounding currents, and electrical devices including home appliances and industrial equipment. Comparisons of magnetic field exposures from representative sources within these categories are shown in Figure 2-3.

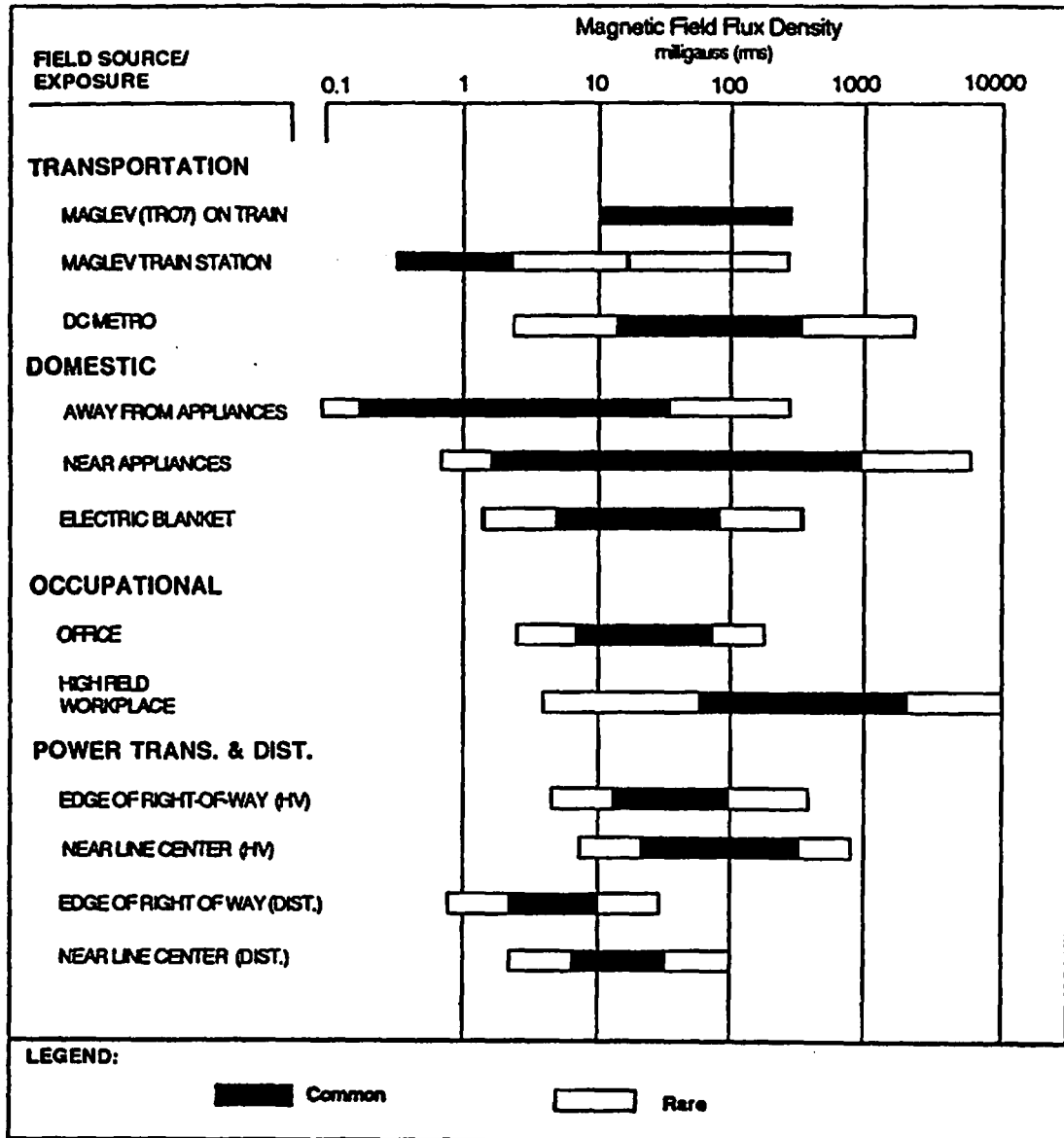

Figure 2-3. Magnetic field sources in the 1-200 Hz frequency range encountered in several sectors are compared in terms of their overall range and most commonly encountered levels. (Adapted from mader and peralta, 1992, and ERM, 1992)

Gauger (1985) has carried out detailed measurements of magnetic fields associated with one or more models of some 25 household appliances. Mader and Peralta (1992) developed a model that allows assessment of whole body exposure, as well as exposure to the extremities or head, from magnetic fields generated by home appliances. Magnetic fields encountered near these appliances varied over some four orders of magnitude and were highly dependent on proximity to the device while in operation. As well as determining the effect of duty cycle on total exposure, Mader and Peralta (1992) have quantified the important distinction between whole body exposure and exposure to extremities. They point out that many electrical devices are best considered as point source dipole magnets with fields that fall off rapidly. Therefore, whole body exposure is likely to be substantially less than that for extremities close to the source. This point is relevant to many of the fields measured in the maglev vehicle TR-07.

Mader and Peralta have also considered temporal and spatial factors in assessing the relative contribution of household appliances to total EMF exposure. When exposure is determined using the product of field intensity and time, household appliances such as electric blankets can contribute significantly to daily EMF exposure. When evaluating the electric transport and maglev exposure data, it is important to consider the significance of spatial gradients.

Several motor-driven appliances were found to produce magnetic fields, at close proximity, that far exceeded ambient field levels in homes when these appliances were not operating. Electric can openers and hand-held electric drills are examples of devices found to create fields well in excess of 1000 mG within the surrounding space often occupied by the user (Gauger, 1985; Mader and Peralta, 1992). Other appliances associated with relatively high magnetic fields included electric ranges, and in particular, electric hair dryers and electric shavers. The latter are of interest because they routinely represent a broadband ELF magnetic field exposure to the head of up to 10,000 mG. Of possible concern with regard to motor-generated magnetic fields are not only their relatively high strength, but also the spikes or transients produced by solid state speed controllers and commutator arcing. Reported electric razor use for more than 2.5 minutes per day has been associated with increased leukemia risk in adult males (Lovely et al., 1992). Laboratory measurements on motor-driven personal appliances by Wilson et al (1993) showed that local exposures to the body from these devices could exceed 4,500 mG, with rates of change exceeding 1000 T/sec. Motor-driven electric hair dryers were one of two household appliances that showed a statistically significant correlation with increased leukemia incidence in a recently published epidemiologic study (London et al., 1991).

Florig and Holberg (1990) have characterized in detail EMF associated with electric blanket use. Magnetic fields produced by electric blankets manufactured before 1990 were determined to be in the range of approximately 30 to 300 mG at or very near the blanket surface. Later calculations (Mader and Peralta, 1992) have found that actual whole-body exposures to electric blankets are somewhat lower owing to the rapid fall-off of the fields with distance. Wilson and colleagues (1992) have recently reported that the average magnetic field flux density at a distance of 10 cm from the surface for an aggregate of electric blankets was approximately 7.5 mG. Nonetheless, the latter exposure is of interest because of its duration (approximately 8 hours per day) as much as its intensity and will be discussed in Chapter 6.

Household exposures that arise from appliances with electric motors tend to be broad in their frequency spectra. That is, exposure includes frequencies in the ELF and higher frequency ranges that arise due to harmonic distortion from reactive loads and solid-state switches. Exposure to these sources involves a substantial contribution from frequencies other than 60 Hz. In some instances higher frequency components can extend into the 100 kHz range and beyond (Wilson et al., 1993).

Figure 2-3 compares magnetic field ranges encountered in several industrial and residential sectors. In this figure, commonly measured flux densities associated with each source are distinguished from those that are rarely observed. Total exposure from any of these sources is a function of the source magnetic field flux density and time spent in the field. Proximity is especially important for appliances and other devices that have dipole point source characteristics (Mader and Peralta, 1992).

2.5 COMPARISONS OF MAGNETIC FIELDS ASSOCIATED WITH ELECTRIC TRANSPORT TO EXISTING EXPOSURE GUIDELINES

Although there are no U.S. government standards pertaining to non-occupational exposures for ELF and static magnetic fields, the World Health Organization (WHO) and certain agencies in other countries have published guidelines for limiting such exposures to workers or to the general public. Overall, these guidelines appear to be based on the assumption that induced currents constitute dose and are oriented to limiting this aspect of exposure to time-varying magnetic fields.

The German Industrial Standard (Deutsche Industrie Norm, or DIN), designated as the Association of German Electrical Engineers (VDE) 0848, is a guideline for electrically powered rail transportation magnetic fields. Proposed by the German Electro-Technical Commission, part 4 of the standard sets limits for exposure to ac magnetic fields in the ELF (formally 3 Hz to 3 kHz) and VLF (3 kHz to 30 kHz) ranges. Because they are oriented to limiting induced electric fields, the standards are frequency dependent. Limitations are set forth in terms of both rms and peak field flux density, and for both intermittent and continuous exposures. The standards provide guidance for determining total exposure by summing contributions from different frequency components. According to this standard, the maximum allowable whole body exposure at 50 Hz corresponds to approximately 50 G.

The American Conference of Governmental Industrial Hygienists (ACGIH) has recommended a considerably higher limit for whole body exposure. For occupational exposures, ACGIH recommends that exposures to 60 Hz magnetic fields should not exceed 100 G. This threshold limit value or "TLV" is a concept taken from chemical toxicology. It is sometimes cited as guidance for exposure of magnetic resonance imaging technicians. The limit value is so high that it applies to very few potential occupational exposures (such exposures, however, are found in aluminum smelting reduction cell rooms). There are unlikely to be non-occupational exposures that normally entail flux densities of this nature over a sufficient area to comprise a whole-body exposure.

Some states have passed legislation limiting EMF at power line right-of-way boundaries. Table 2-1 lists these, by state, as currently enacted or pending. These guidelines are the most restrictive of those reviewed here. However, they apply specifically to exposures along rights-of-way. In many cases magnetic field flux densities specified represent a "no greater than present values" approach.

Table 2-1. State regulations and policies for transmission line rights of way (RoW)

STATE	FIELD LIMIT
¹ California	Schools 100 feet from edge of RoW for 100-110 kV lines Schools 150 feet from edge of RoW for 220-230 kV lines Schools 250 feet from edge of RoW for 345 kV lines
² Florida	10 kV/m maximum for 500 kV lines at edge of RoW 2 kV/m maximum for 500 kV lines at edge of RoW 8 kV/m maximum for 230 kV and smaller lines in RoW 2 kV/m maximum for 230 kV and smaller lines at edge of RoW 200 mG for 500 kV lines at edge of RoW 250 mG for double circuit 500 kV lines at edge of RoW 150 mG for 230 kV and Smaller lines at edge of RoW
² Montana	1 kV/m at edge of RoW in residential area
² Minnesota	8 kV/m maximum in RoW
² New Jersey	3 kV/m at edge of RoW
² New York	1.6 kV/m at edge of RoW
² North Dakota	9 kV/m maximum in RoW
² Oregon	9 kV/m maximum for 500 kV lines in RoW

Sources:

- 1 California Department of Education, (1989): California School Site Selection and Approval Guide, p 4. School Facilities Planning Division, P.O. Box 944272, Sacramento, CA 94244.
- 2 Power-Frequency Electric and Magnetic Fields Exposure, Effects, Research, and Regulation. Prepared by I. Nair, MG Morgan, HK Florig, of the Department of Engineering and Public Policy, Carnegie Mellon University, for the Energy and Materials Program of the US Congressional Office of Technology Assessment (Washington, DC 20510-8025), 1989

Nair I, Morgan MG, Florig HK (1989): Power-Frequency Electric and Magnetic Fields Exposure, Effects, Research, and Regulation. Carnegie Mellon University, for the Energy and Materials Program of the US congressional Office o technology Assessment. (Washington, DC 20510-8025), 1989.

The International Radiation Protection Association (IRPA) has proposed an interim standard for limiting human exposure to magnetic fields. As developed by the Non-Ionizing Radiation Committee of IRPA, the interim standard calls for a maximum exposure on a continuous basis (24-hr day) of 1 Gauss at power frequencies. Short term exposure of up to a few hours per day is limited to 10 Gauss.

Information is now available on occupational exposures to magnetic fields. In evaluating the potential contribution of electrical transport to total EMF exposure, it is of interest to compare data regarding exposures associated with other occupations to those of motormen and passengers that operate or use electric transport systems. Table 2-2 lists exposures for various electrical occupations. Although electric train drivers would be included in this listing, no data for them was provided in Bowman, 1988.

2.6 OVERVIEW OF BIOLOGICAL EFFECTS FROM EMF EXPOSURE

At the outset of this overview, we note the lack of consensus in the scientific community as to the extent, or existence, of possible adverse health effects from, or physiological response to, EMF exposure. In the following discussion, the difference between adverse health effects (or pathological effects) and biological (or physiological) effects is important. Biological or physiological effects are responses in biological cells, whole animals, or humans that can be measured as a result of EMF exposure, but whose existence does not necessarily lead to an adverse health outcome. Pathological or adverse health effects are those that lead to disease or disorders that shorten life span or substantially reduce the quality of life. An example of a pathological effect would be an increase in risk for a disease such as cancer that was directly attributable to EMF exposure or to which EMF exposure was a demonstrated contributing factor.

As stated previously, EMF in the ELF and RF ranges do not have sufficient energy to disrupt chemical bonds and therefore cannot cause any direct chemical changes to desoxy ribo nucleic acid (DNA). This inability to cause direct chemical damage has led many to conclude that these fields can have no effect on cancer risk. This view is based on the premise that cancer arises only from expression of a chemical change or mutation within the genetic material of the cell (genome). Others maintain that EMF effects on nervous system function are not possible because the amount of energy deposited by EMF exposure in the ELF range is below the levels of the thermal energy already present, and therefore ELF fields cannot be detected by the organism (Adair, 1991).

Table 2-2. Occupational exposures to extremely low magnetic fields (mG)

Job Class	Environments	Number of Sites	Geo. Mean	Range (mG)
Electricians	Industrial Power Supply	1	103.1	-----
Power Line Workers	Underground and Overhead Lines	3	57.4	38-91
		2	42.5	32-57
	Home Hookups	14	1.1	0.04-12
Welders and Flame Cutters	TIG/AC	4	41.3	24-90
	TIG/DC	4	6.5	4-16
Power Station Operators	Transmission Station	3	38.6	16-72
	Distribution Substation	3	28.6	7-54
	Generating Station	12	6.0	0.1-118
	Control Rooms	8	2.1	1-4
Electronics Assemblers	Sputtering	2	24.3	14-43
	Soldering	2	1.3	1.3-1.6
	Microelectronics	3	0.03	0.01-0.06
Projectionists	Xenon Arc	7	14.4	1-45
Fork-Lift Operators	Battery Powered	9	11.7	0.9-1250*
Electronics Engineers and Technicians	Laser Lab	9	10.6	2-202
	Calibration Lab	4	0.6	0.6-0.7
	Office	1	0.2	----
Radio and TV Repairers	Repair Shops	11	6.3	1-26
Radio Operators	Dispatchers	3	0.3	0.2-0.4
Secretaries	VDT	6	3.1	0.8-29
	Other	3	1.1	0.2-4
"Electrical Workers" combined		105	5.0	0.1-1250

*Peak measured during acceleration

Source:

Bowman JD, Garabrant DH, Sobel E, Peters JM (1988): Exposures to Extremely Low Frequency (ELF) Electromagnetic Fields in Occupations with Elevated Leukemia Rates. Appl. Ind. Hyg. 3:189-194.

The basis of the argument that weak magnetic fields cannot have biological or physiological effects (as distinguished from adverse health or pathological effects) is that the energy represented by the fields is not only insufficient to break chemical bonds, but indeed should not be detectable against the background of thermal and electric noise present in living tissue at ambient temperatures. Sensing of weak magnetic fields is, nonetheless, well documented in the animal kingdom. There is much evidence that some animal species are capable of

in the animal kingdom. There is much evidence that some animal species are capable of detecting low-strength EMF and responding to them. Elasmobranch fish have specialized electric field sensing organs, and certain migratory birds can detect and use the geo-magnetic field for navigation. Kirschvink (1992) has discussed these observations in light of recent findings suggesting that magnetite, a magnetic mineral found in magnetotactic bacteria, may be more widely distributed in the animal kingdom than previously thought. For reviews of magnetic field sensing for homing and navigation in animals, see Kalmijn and Blakemore (1978) and Kirschvink et al. (1985).

Given sufficient field strength, there is no question that low-energy magnetic fields can have biological effects. For example, the perception of colorless light flashes (phosphenes) can be induced in humans by exposure of the head to magnetic fields with flux densities on the order of 100 G (10 mT) at low frequencies (approximately 10 to 100 Hz) with the lowest threshold around 20 Hz. Dependence of this visual effect on EMF frequency is evident from Figure 2-4. At still higher field strengths, an exposed human may experience involuntary muscle contractions.

These effects arise from currents induced by the time-varying magnetic field. Thus, the debate over the possible effects of magnetic field exposure does not concern whether effects exist but, rather, at what field strengths and frequencies these effects can be reproducibly detected. Figure 2-5 illustrates approximate relationships between imposed magnetic field flux density, induced electric field, and induced currents for a human-sized object. Flux densities or induced current for biological effects over which there is no controversy (visual phosphenes and electrically induced convulsions) are indicated in this figure. Field strengths at which other effects have been reported are shown, along with the approximately corresponding magnetic flux densities represented by a number of magnetic field sources.

Animal studies have been carried out to address the areas of interest identified by results from epidemiologic studies. These studies have focused attention on possible increased risk for cancer, miscarriage, and depression (Walborg, 1991). Well-done, large population studies in rodents have shown no effects of EMF exposure on reproductive outcome (Rommereim et al., 1988 and 1990). Animal studies offer some evidence that EMF exposure may affect short-term memory (Lovely et al., 1990), and laboratory studies with humans furnish limited evidence that is consistent with effects on central nervous system (CNS) function (Bell et al., 1991). A few recent studies have suggested that EMF exposure may enhance the development of cancer in animals that have been treated with chemical carcinogens (Beniashvili et al., 1991). These data will be discussed in Chapter 5.

Groh (1993) conducted studies to determine possible effects of a synthetic maglev magnetic field signal on pineal function in rats and on a number of cellular systems. These studies are discussed in Chapters 5 and 6.

Threshold Field
and Current
Density

(Normalized to
unity at 20 Hz)

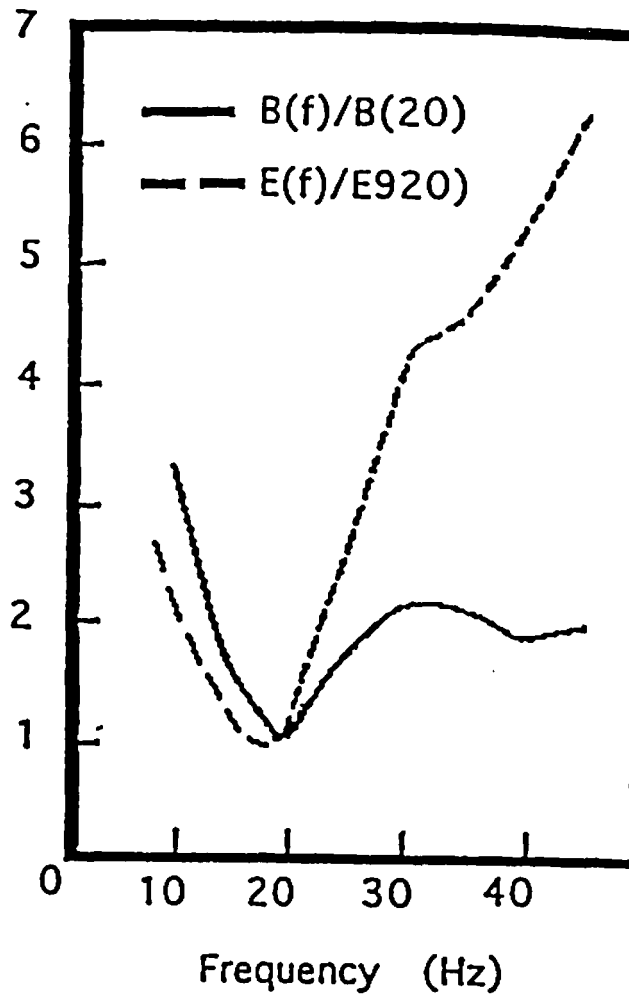

Figure 2-4. Magnetophosphene phenomena in humans are frequency dependent with highest sensitivity reported to be at approximately 20 Hz. This graph depicts normalized response curves as a function of frequency. As can be seen, electric fields show a frequency dependence similar to that of the magnetic fields. This supports the conclusion that these sensations arise from electrical currents induced in the eye by the magnetic field. (Adapted from Tenforde, 1991)

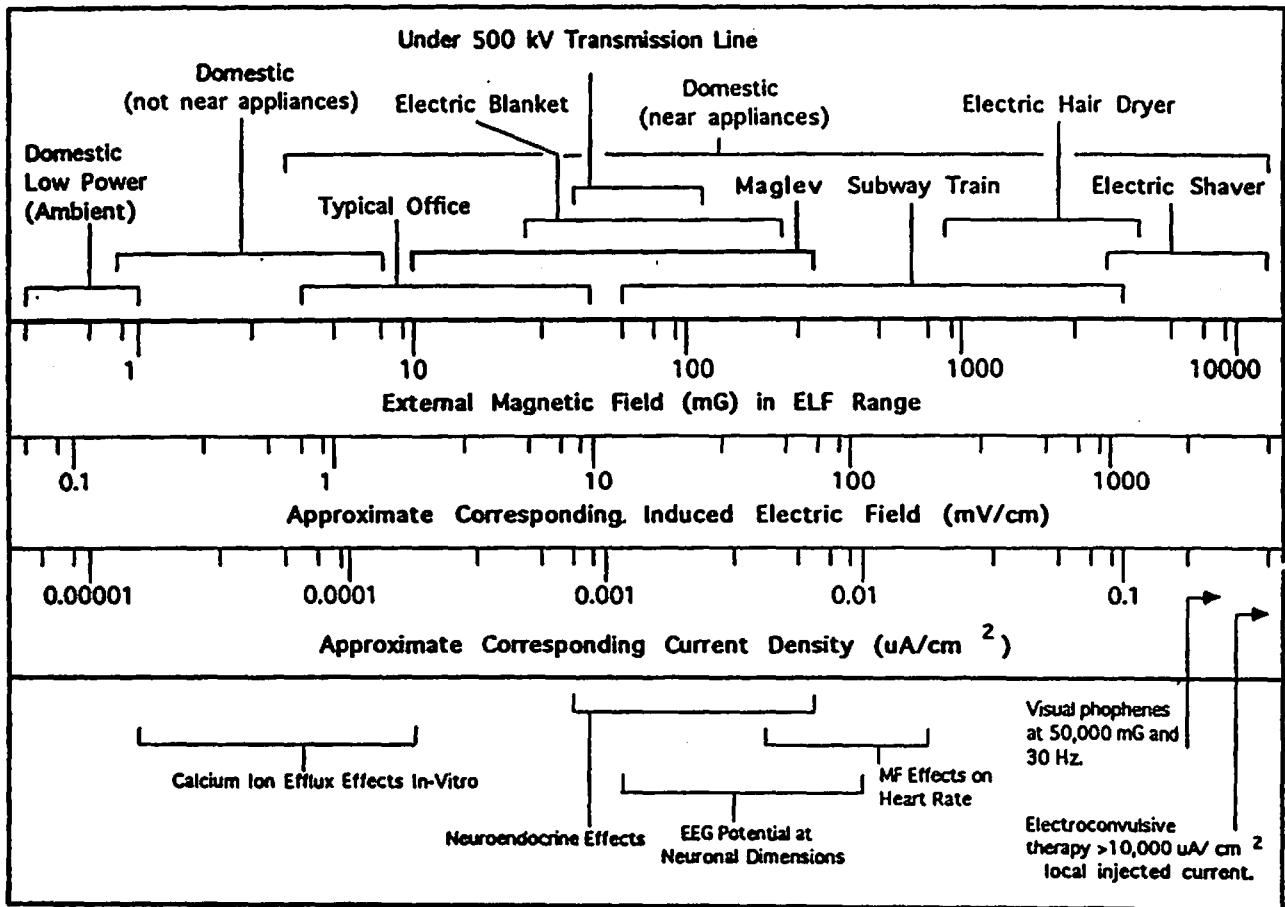

Figure 2-5. Magnetic field flux densities associated with selected sources are shown on a scale with their approximate corresponding induced currents as calculated for a human model (oblate spheroid). Also shown for reference are the corresponding levels for several biological effects observed in the laboratory or clinic. This illustration does not imply that all of the listed biological effects occur in humans exposed to 60 Hz fields. Many of these effects are dependent on frequency and other characteristics of the field and have been observed only in laboratory animals.

As determined by laboratory studies on whole animals, many biological effects of EMF appear to be mediated by the nervous system, as are the phosphenes. These nervous system responses may be manifest by subsequent changes in neuroendocrine function (Wilson and Anderson, 1990). Effects may arise from injected or induced currents (Figure 2-5). Lack of consensus on the issue relates to flux densities and time-rates-of-change characteristics of the magnetic fields and not whether the fields are intrinsically capable of producing biological effects.

On the cellular level, there is growing evidence that the cell membrane is the site of action for the fields. It appears that signal transduction occurs at the cell membrane, and that many of the effects observed in studies with cultured cells may be a consequence of changes in membrane bound ion channels or receptors (Adey, 1988). At the subcellular level, researchers are interested in EMF effects on gene regulation. Although there are no reliable reports of direct chemical damage to DNA from magnetic field exposure, several laboratories have reported alterations in the gene transcription (for example, Goodman et al., 1992). EMF-induced changes in the regulation of genes, while not constituting a mutation or heritable change, could play a role in the expression of oncogenes and thereby affect cancer risk.

2.7 EMF EPIDEMIOLOGIC STUDIES OVERVIEW

Research into possible biological and health effects from exposure to EMF has been stimulated by a number of epidemiologic studies showing an association between surrogates for EMF exposure and increased risk for certain cancers, miscarriage, and emotional depression. Surrogates used in these studies include proximity to high current power lines external to the home and job title. In the latter occupational studies, workers with job descriptions that entail greater exposure to magnetic fields are often compared to workers in occupations with less exposure. These studies are discussed in some detail in Chapter 7.

Several epidemiologic studies that included or dealt specifically with electric railway workers have been carried out. Of the studies involving railroad workers reviewed in Chapter 7, three (Nakagawa, et al. 1992, Tynes et al. 1993, and Baroncelli et al., 1986) showed no association with cancer risk. One of the studies (Tynes and Anderson, 1990) showed an association with a very rare cancer (male breast cancer) and one (Balli-Antunes et al. 1990) showed a weak association between work on electrical railways and risk of leukemia and lymphoma combined.

3. MAGNETIC FIELD CHARACTERISTICS OF THE TRANSPRAPID MAGLEV VEHICLE AND ELECTRIC RAIL TRANSPORT SYSTEMS

3.1 SYNOPSIS

The magnetic field, flux density, and frequency associated with maglev vehicle technologies are briefly described and contrasted with those of currently operational electric rail transport systems. Contemporary designs for maglev vehicles may be categorized as either superconducting or non-superconducting. The Transrapid (TR-07) system is a non-superconducting electromagnetic system (EMS), which adjusts magnet currents on a continuous basis to maintain levitation and speed as required. Magnetic fields from non-superconducting systems are likely to be of lower flux density than those from superconducting designs. Hence, stray fields from these systems to which humans may be exposed are likely to be lower than those from the superconductivity design.

Characteristic flux densities of the magnetic fields generated by the Transrapid maglev vehicle system are briefly summarized. These are compared to the flux densities from similar measurements of magnetic fields associated with several currently used electrically powered rail transport technologies, including subway, high-speed surface rail, and conventional heavy surface rail systems. These technologies are compared in terms of magnetic field flux density and frequency components in the range between 0 Hz and approximately 2.5 kHz. Data on temporal characteristics of the field are also presented and discussed.

Maglev magnetic fields may exhibit a greater variance in frequency components during operation than do those from electric rail transport technologies. However, it is concluded that Transrapid maglev fields are not substantially different from other technologies in terms of flux density or frequency content. There may, however, be temporal aspects of dc and ac magnetic fields or specific combinations of ac and dc fields associated with maglev TR-07 that are not found in any of the technologies considered in this section. Nonetheless, passenger and crew exposures, in terms of frequency or flux density, are not likely to differ significantly between maglev and other existing technologies.

3.2 INTRODUCTION

Maglev vehicle transportation is currently being evaluated as a possible future component of the U.S. ground transportation system. This technology offers advantages in speed and comfort for surface transportation and is being considered as a means of reducing congestion in heavy traffic corridors.

Maglev vehicles operate along a guideway instead of on rails. During operation, the vehicle does not touch the guideway, but is suspended above it by means of either repulsive or attractive magnetic forces. Intense magnetic fields are created between the guideway and the train during levitation and operation. In EMS technologies, these range in frequency from dc, used for lifting the train off the guideway, to propulsion and guidance frequencies in the hundreds of Hz range. In electrodynamic systems (EDS), the current provided to the

magnets is relatively constant, and hence is anticipated to vary in frequency during operation less than in EMS technologies such as Transrapid. EDS is a repulsive system, whereas EMS is attractive. Tolerances required for EMS in terms of vehicle to guideway distance are much more restrictive, and dynamic control is required.

Superconducting maglev designs have also been proposed, and such a system is being developed in Japan. Superconducting systems are likely to have magnetic fields that are greater in magnitude than non-superconducting systems. Nakagawa et al. (1992) have described measurements of dc fields in the 1-200 G range, and measurements of ac fields in the 0.1 to 10G range, associated with superconducting maglev. Maglev-generated stray fields to which humans may be exposed constitute a potentially important environmental aspect of the technology, given recent interest in possible adverse health effects from EMF.

Magnetic fields associated with maglev vehicle operation at the Emsland Transrapid maglev Demonstration Facility in the Federal Republic of Germany, as well as those associated with several conventional electrical powered rail systems, were recently characterized in a series of field studies by Electric Research and Management (ERM 1992a,b; 1993 a,b,c). In evaluating the possible significance of magnetic fields with regard to potential biological effects generated by maglev, it is useful to consider the characteristics of magnetic fields generated by electrically powered conventional and high-speed rail systems.

A series of studies to characterize magnetic fields generated by electrically powered rail transportation systems was recently completed for the U.S. Department of Transportation. Included in these studies to date, along with the Transrapid vehicle TR-07 (ERM 1992a), have been the French high-speed rail train (TGV-A) (ERM 1992b); Washington, D.C., Metro (1993a), and Massachusetts Bay Transit Authority (MBTA) (subway) trains (ERM, 1993b); and Amtrak surface rail trains that operate along the Northeast Corridor (NEC) and New Jersey Transit trains that operate along the north New Jersey coast line (ERM, 1993c). These systems are representative of the major types of electric mass transport technologies currently in operation, including both older (e.g., MTBA) and newer (Washington, D.C., Metro) subway systems, high-speed surface rail (e.g., TGV), and conventional surface rail, including 25 Hz and 60 Hz electric, as well as non-electric (diesel-powered) line segments.

Data discussed in this chapter are primarily from measurements made by ERM. Most were obtained using the "multiwave" (also designated as the wave-capture) system, which is transportable and capable of sensing and recording static and time-varying magnetic field flux density and corresponding frequency data over the range from 0 Hz to approximately 2.5 kHz at a high sampling rate. Data thus acquired can later be displayed as three-dimensional graphs with axes representing, for example, flux density, frequency, and elapsed time.

Other equipment used in these characterization studies include the three-axis EMDEX II meter. As the authors of these reports point out, the frequency response range of the EMDEX is centered around 60 Hz and is narrower than that of the multiwave system. Thus,

EMDEX readings can be expected to be lower than comparable multiwave readings in environments where a wider range of magnetic field frequency components is present. These differences in response and the resulting variation in the average measured fields are illustrated in Section 3-8, which compares magnetic fields associated with surface rail technologies as determined using multiwave, EMDEX, and DAT (digital audio tape) technology measuring systems.

In reporting data from these studies, ERM has designated six bands covering the frequency range from 0 Hz to approximately 2.5 kHz. These are of differing bandwidth and are useful for a qualitative comparison of the relative frequency characteristics for magnetic fields generated by the various transport systems. The designators "low frequency," "high frequency," and "all frequency" as used by ERM are defined below and should be used for these data only. These should not be confused with official IEEE bandwidth designations.

The bands are:

Static	(0 Hz)
Low Frequency	(5-45 Hz)
Power Frequency	(50-60 Hz)
Power Harmonic Frequencies	(65-300 Hz)
High Frequency	(305-2560 Hz)
All Frequencies	(5-2560 Hz)

It is the position of ERM, based on the large data set collected to date, that measurements within the bandwidth between 0 Hz and 2560 Hz adequately characterize the magnetic fields from electrically powered transport systems, because the amplitude of frequency components above approximately 2.5 kHz from these systems is minimal. Magnetic field flux densities in the various bandwidths will be used in this section as a means of comparing the maglev magnetic fields to those of electric transport systems currently in use.

3.3 TRANSRAPID TR-07 MAGLEV MAGNETIC FIELD CHARACTERISTICS

Time-varying magnetic fields measured on the TR-07 during operation were primarily in the "low frequency" (5-45 Hz) range. Other ELF components varied to some extent depending on speed and operation status (i.e., acceleration, steady speed, or deceleration). Figure 3-1 (from ERM 1992a) illustrates flux density of the field as a function of acceleration and deceleration.

As is illustrated by Figure 3-1 and the representative data on the frequency, flux density, and time axes shown in Figure 3-2, magnetic fields generated by the maglev system are complex in terms of their frequency components and temporal characteristics during the acceleration, cruise, deceleration cycle. Fields measured in the passenger compartments were often the result of fields from multiple sources, including the levitation and drive components of the system, and thus their spatial distributions could not be easily predicted. Flux density and spectral characteristics varied depending on vehicle operating parameters and varied during acceleration and deceleration.

File: TVERIN.MAT

upspeed

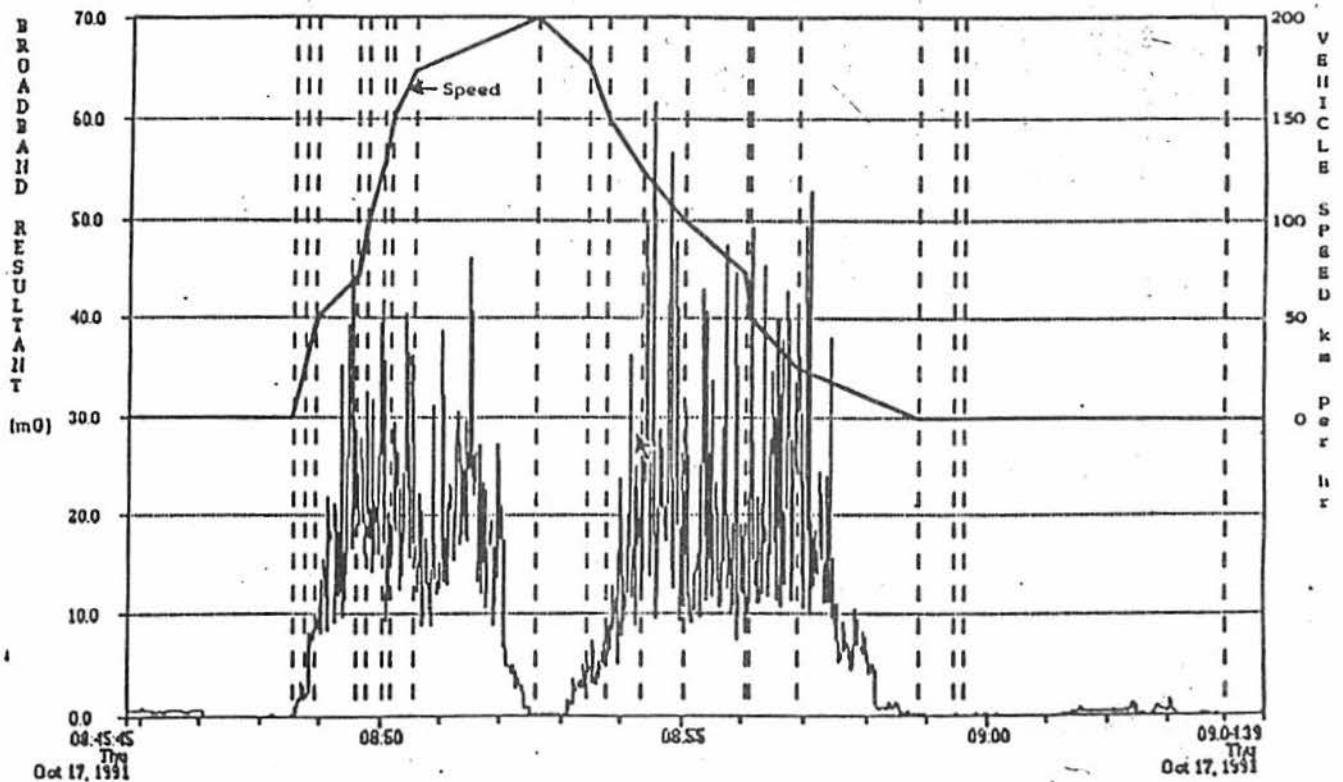

Figure 3-1. Magnetic field on the TR-07 vehicle as measured with the EMDEX meter worn at waist level. Solid line indicates concurrent vehicle speed (scale on right of figure). (From ERM, 1992a)

Signals at the excitation frequency were prominent in the spectra from TR-07 with a fairly constant contribution in the 2-15 Hz range. Excitation frequency varied with speed and was typically 164 Hz in the measurements considered here. The energized line on the guideway appeared to be the primary source of magnetic fields in the passenger compartment. Thus, flux densities in the passenger compartments of the train were inversely proportional to the height above the floor. Table 3-1 (adapted from ERM, 1992a) shows magnetic fields measured in the TR-07 vehicle as a function of frequency bandwidth, and height above the floor in the passenger compartment and in the rear engineer's cabin.

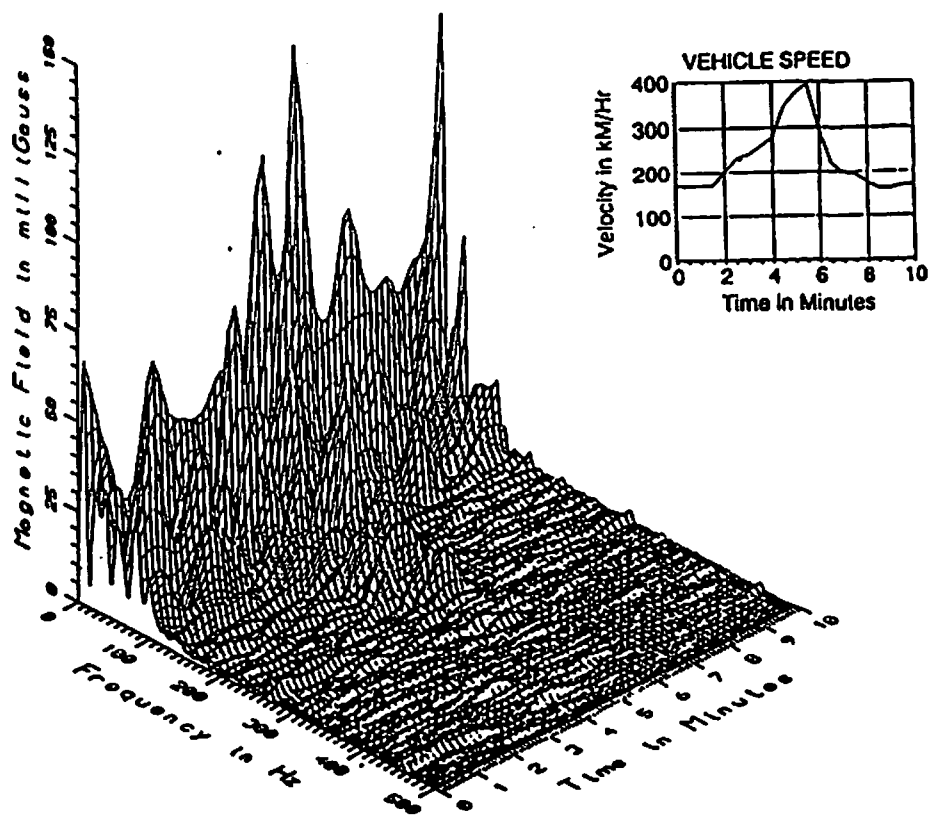

Figure 3-2. Three-dimensional presentation of flux density and elapsed time data from magnetic field measurements in the passenger compartment of transrapid TR-07 maglev vehicle. (From ERM, 1992a)

Table 3-1. Average and standard deviation of the magnetic field flux density (in milligauss, mG) by ERM designated frequency band, as measured in the rear engineer's compartment and passenger compartment of the TR-07 maglev vehicle at the indicated height above the floor. Data for the passenger car is from a composite data table for all passenger car measurements. (From ERM, 1992a)

	Height Above Floor (cm)	Rear Engineer's Compartment	Position	Passenger's Compartment
<u>FREQ. BAND¹</u>		<u>AVG/SD (mG)</u>		<u>AVG/SD (mG)</u>
Static	13 112	986/76 791/94	Seated Head Level	746/117
5-45 Hz Low Freq.	13 112	76/38 37/14	Seat Level	63/34
50-60 Hz Power Freq.	13 112	16/7 12/7	Seat Level	8.6/4.8
65-300 Hz Pwr Harm.	13 112	55/16 45/8	Seat Level	17.4/5.5
305-2560 Hz High Freq.	13 112	4/2 4/2	Seat Level	1.1/0.53
5-2560 Hz All Freq.	13 112	97/38 60/15	Seat Level	66.8/33

1 Bandwidth designations shown here were made by ERM for the reporting of these data only and are not generally recognized designations for bands in their frequency range.

3.4 ELECTRICALLY POWERED RAIL TRANSPORT SYSTEMS

Regardless of their specific design, electrically powered rail systems have a number of design and operating principles in common. Power is supplied to the drive or traction motors on these systems by means of a third rail, which is electrified, or by an electrified overhead cable (or cables). Suspended overhead cables are referred to as catenaries. The catenary or third rail is energized through a series of small transformers or substations. These, in turn, are connected with the main power grid by larger substations. If the rail system operates on dc or at a frequency different from that of the main power grid (e.g., 25 Hz instead of 60 Hz in the United States), then rectification and/or phase shifting equipment is required at the interconnection between the railroad power system and the main power grid. Each set of transformers or substation energizes a limited length of the catenary or third rail. Return currents flow back to the substation or transformer along one or both of the track rails.

Conventional rail systems may operate on either ac or dc power. Some trains have the capability to use both, allowing them to operate on track segments with either type of power. Although some ac systems operate at line frequency (i.e., 60 Hz in the United States and 50 Hz in most other countries), ac power for traction motors is commonly supplied at frequencies less than 60 Hz. In the United States, 25 Hz is used, and in Europe 16.7 Hz is often used.

Measurements taken by ERM using specially designed equipment provide information on flux density, frequency, and temporal characteristics of the fields generated by these systems at a variety of locations and under a variety of conditions. Both ac and dc fields, as well as the associated harmonics, transient behavior, and other characteristics such as rectification ripple, were determined in these studies.

In characterizing the fields from these systems, the investigators considered these potential sources of magnetic fields:

- 1) track to third rail or track-to-catenary power circuits;
- 2) traction motors on the locomotives or drive cars;
- 3) traction power control equipment (e.g. switches, resistors, solid state controllers and reactors) and their associated wiring beneath the cars;
- 4) heating, lighting, and other accessory power equipment; and
- 5) external sources of magnetic fields such as other trains or nearby transmission lines.

Because the engines and coaches used in all of these systems are constructed of conducting materials, they effectively shield against external electric fields. Electric fields measured in the interior areas of all of the trains and vehicles considered here were of negligible magnitude and did not exceed approximately 1 V/m.

The magnetic field measurements that have been made on these systems clearly reveal that the catenary, for those systems that employ this type of feed line, is an important source of magnetic fields in the coaches. In such systems, magnetic field flux density commonly increases with height above the floor. Subway systems commonly employ a third rail to supply electric power and usually have traction motors in each car. In these systems, magnetic field flux density is usually inversely proportional to height above the floor. Equipment that controls and powers these motors gives rise to most of the magnetic fields measured in the passenger areas. In surface heavy rail coaches, the "hotel" power cables that normally run under the floor and supply power for lighting and heat can also be a magnetic field source.

Exposure to magnetic fields generated by electric rail systems may also occur along waysides, areas that are in proximity to the tracks and are often fenced, or on station platforms. Along the waysides, magnetic field flux density drops off very rapidly with distance from the catenary or third rail. In the ERM reports on magnetic fields from electric transport systems, measurements were made in these areas as well as in control facilities, such as dispatch areas. Magnetic field flux densities measured along track waysides are dependent on whether a train is operating along that track/catenary segment. When there is no train operating on a given segment, the magnetic fields due to current in the

catenary/return rail circuit are low, and ambient fields along the wayside under this situation are often determined primarily by sources other than the train drive circuits.

3.5 THE MASSACHUSETTS BAY TRANSIT AUTHORITY AND THE WASHINGTON, D.C., METRO (SUBWAY) SYSTEMS

Rail lines comprising the MBTA subway system were built and came into service at different times and represent, to some extent, differing technologies. Among these are lines with differing EMF characteristics, some of which may be unique. The system operates on dc, and has traction motors in each car. In MBTA passenger cars, the main source of the magnetic field is the power control equipment located beneath the floor. It is also possible that current flowing between the third rail and the track return circuit contributes to the total field in the cars. Magnetic fields in the cars are primarily static with time-varying components resulting from fluctuation in the static field as well as from rectifier ripple.

At seat level, the static magnetic field in the MBTA passenger cars, overall, averaged 507 mG, and the maximum field measured at the seat level was 1446 mG. These fields were highest while the train was accelerating. Time-varying magnetic field flux densities for the MBTA cars averaged 5.7 mG, and the maximum time-varying field reported in these cars was 68 mG. Average fields here are defined as the average of all measurements taken at a given position. Data from measurements on an MBTA Red Line car are listed in tables in Section 3.8.

Along waysides and in system control areas, magnetic fields generated by the MBTA system are primarily static. For subway train drivers, the average seat height time-varying magnetic field was 4.8 mG, and the average static field was 699 mG. In dispatch areas, the main source of time-varying magnetic fields was power lines that supplied electricity to control equipment. Video display terminals also contributed to these fields. Dispatcher room fields ranged from an average low of 4.9 mG to an average high of 6.6 mG. Representative transients on the MBTA line were also detected and characterized. Transients events detected on the MBTA system during these measurements had time-rates-of-change of less than $1 \times 10^2 \text{G/sec}$.

Magnetic fields in passenger cars on the Washington, D.C., Metro System come primarily from traction power control equipment located under the floor of each car, as well as from the current flowing from the third rail, through the car drive equipment, and back along the track return. In the passenger cars, the fields are primarily static with time-varying components resulting from load changes and other fluctuations in current flow.

The 3000 series cars have a solid state motor speed controller (known as a "chopper") which operates at 273 Hz. In the power circuit with this chopper is a large inductance coil, termed a "reactor" or "filter." This coil is used to reduce high-frequency components from chopper operation that would otherwise reduce power quality in the circuit external to the car, by affecting the return current waveforms. A primary concern was that these signals may interfere with communications on the system. This reactor is located in the central area of the 3000 series cars underneath the floor. The magnetic field produced by this coil, is a

function of the amperage times the number of coil turns, can contribute substantially to the flux densities in these cars. For example, the maximum dc field reported in a series 3000 car was over 23 G (ERM, 1993a), as compared to approximately 4.5 G for other types of (resistor-controlled) cars. The maximum ac field for the series 3000 car was 2.9 G, as compared to 0.65 G for other series cars.

On the Washington Metro System, the train motorman would probably have lower magnetic field exposure than the passengers. Static magnetic fields at seat level in the driver's compartment averaged 761 mG, and the maximum flux density encountered was 3148 mG. The corresponding ac magnetic field flux densities were 11 mG and 24 mG, respectively.

Exposures to passengers on the platform were also determined in this study. Maximum static magnetic fields at mid-torso height (110 cm) above the platform were strongly dependent on car type. On outdoor platforms, while series 3000 cars were operating, the maximum magnetic field at torso height was 1218 mG near the platform floor. These fields peaked at 3270 mG for a short time as the 3000 series cars passed by the measuring equipment.

3.6 SURFACE RAIL SYSTEMS

Magnetic field measurements were made on the Amtrak and Metro NEC and on the New Jersey Transit and North Jersey Coast Line Rail Systems. Magnetic fields in the passenger areas of the electrically driven trains operated by Amtrak along the NEC and in New Jersey were due to currents flowing in the catenary and the track circuit. Data were collected from sections of the lines operated at 60 Hz and 25 Hz as well as on non-electrified (diesel-powered) sections of these lines (ERM, 1993c).

On sections of the systems operated at 25 Hz, these fields were comprised primarily of the fundamental frequency which falls into the band designated as "low frequency" (5-45 Hz) by ERM. Flux densities averaged 134 mG on sections of the line operated at 25 Hz. On the sections operated at 60 Hz, flux densities inside cars averaged 52 mG; on the New Jersey Coast Line (Long Branch), they averaged 19 mG. Maximum magnetic fields encountered on these three electrified systems were 628 mG, 305 mG, and 61 mG, respectively.

Along the non-electrified track segments, the magnetic fields arose mainly from the "hotel" power lines that run underneath the floors of the cars. Average minimum fields on these segments were 6 mG, and the average maximum fields were 13 mG. Figure 3-3 (from ERM, 1993c) compares the magnetic fields associated with the three means of powering trains running on the Amtrak system in the NEC. This graph illustrates the variation in magnetic field flux density values that arises from use of different instruments for measurement.

Comparison of Average AC Magnetic Field For the Four Technologies

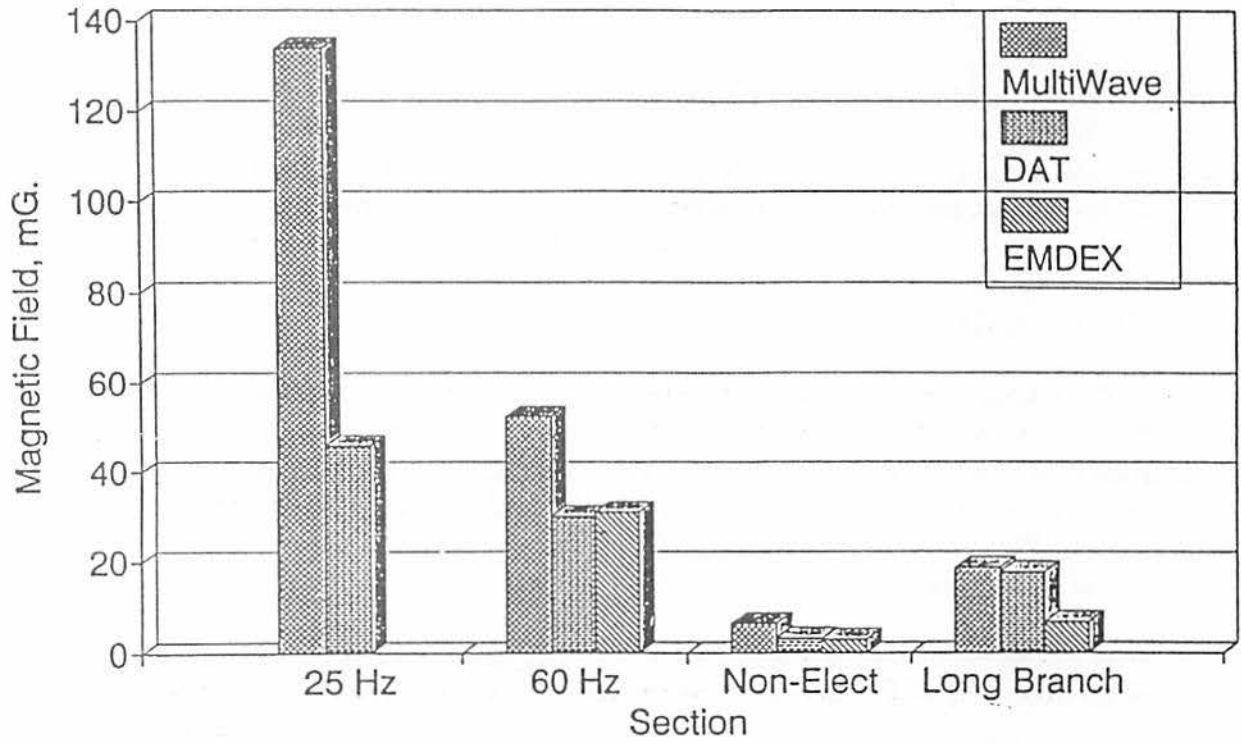

Figure 3-3. Comparison of average time-varying magnetic field levels in coaches operating on various segments of the NEC and the Northern Jersey Coast Line as determined by different measuring devices. (From 1993c)

The French TGV is a high-speed, electric-powered train that runs on conventional tracks and is powered by a push-pull locomotive arrangement which can operate either on ac or dc power. A 1500 volt electrical cable runs underneath the passenger cars to connect the two locomotives during operation. Both ac and dc hotel power cables also run under the passenger coaches.

During dc operation, the static magnetic fields in the passenger coaches averaged 1826 mG over all samples and sensor locations, and the maximum flux density encountered was 6131 mG. Corresponding measurements while in ac operation were 31 and 165 mG, respectively. Magnetic fields in the engineer's cab of the locomotive averaged 1629 mG over all samples and all sensor locations. The maximum static magnetic field encountered was 5160 mG. Corresponding measures for the power frequency magnetic fields while traveling over 50 Hz sections of the line were 31 mG averaged and 367 mG maximum. On board the train or near the tracks along the 50 Hz sections, the magnetic fields are much the same as from electrical appliances in Europe, with the largest component at 50 Hz and significant energy in the odd harmonics.

3.7 ELECTRIC TROLLEYS AND TROLLEY BUSES

Electric trolleys are steel-wheeled vehicles that run along steel tracks laid in the street. Trolley buses (or electric buses) are rubber-tired vehicles that are powered from overhead electric cables. The latter always requires a second overhead cable because there is no steel track for return current flow.

Both of these types of vehicles are used for public transport in the Boston area. During the measurements on the subways in Boston, magnetic fields were measured on a number of these vehicles. Seat-level, time-varying magnetic fields in the trolleys and trolley buses averaged 2.5 mG over all sensor locations and all vehicles. The maximum time-varying field encountered was 26 mG. Corresponding static magnetic field flux densities were 312 mG and 775 mG, respectively.

3.8 COMPARISONS OF MAGNETIC FIELDS ASSOCIATED WITH TRANSPRAPHIC MAGLEV WITH FIELDS FROM OTHER ELECTRIC-POWERED SYSTEMS

Review of the available information on magnetic fields associated with various kinds of electric rail transport technologies indicates that there are not likely to be any significant potential human exposures uniquely associated with Transrapid maglev operation. In terms of flux density, the maglev fields are certainly not higher, either on a peak field or average field basis, than those from the other rail technologies considered in this report. While there are no unique exposures in terms of flux density or frequency as determined by the ERM bandwidth designations described earlier, the combination of dc fields and the range of frequencies encountered in the TR-07 is clearly not matched in any of the rail transport technologies considered here.

It is of interest to note that the maximum reported magnetic fields to which train crews may be exposed in Europe appear to be higher than those determined to date in the United States. The highest potential train crew exposure found reported in the literature to date is approximately 25 G at 50 Hz, at a distance of 0.5 m above the floor on certain model locomotives used on the British Rail System (Chadwick and Lowes, 1992). Authors who have considered magnetic field exposure on the Swiss National Railroad System have calculated that train crews in that country are exposed to 16.7 Hz field flux densities exceeding 10 G (Balli-Antunes et al, 1990). In a recent epidemiologic study of 529 railroad workers in Italy, Baroncelli and colleagues (1986) classed workers who were in fields of greater than 150 mG (50 Hz) for an average of more than 20 hr/week in the highest exposure category. Tynes et al. (1993) reported that exposures for Norwegian rail workers in the highest category of exposure ranged up to 8.8 G. (Electrified sections of the Norwegian rail system operate at 16.67 Hz.)

Magnetic field flux densities measured in the TR-07 vehicle as a function of frequency were listed previously in Table 3-1. Table 3-2 provides similar information for other systems for which data are available from measurements using the multiwave system. Conclusions in this chapter regarding the lack of substantially unique magnetic fields associated with maglev operation are based largely on comparisons by frequency and flux density, between Table 3-1 for the maglev and Table 3-2 for currently deployed electric rail transport technologies.

Table 3-2. Comparison of average and standard deviations of the measured passenger compartment magnetic fields, by flux density (mG) and bandwidth,¹ from the MBTA Red Line, Washington D.C. Metro, French TGV-A high speed rail, and Amtrak lines

	HEIGHT ABOVE FLOOR	MBTA RED LINE	WASH D.C. METRO	HIGH SPEED TGV / AC	AMTRAK NEC 25 Hz	AMTRAK NEC 60 Hz
<u>FREQ. BAND</u>	(CM)	AVG /SD	AVG/SD	AVG/SD	AVG/SD	AVG/SD
Static	10	569/170	> 23,000 ²	1558/331	568/462	735/34
	110	364/133		909/377	539/135	355/33
5-45 Hz Low Freq.	10	3.9/3.2	562/532	27/9.7	126/100	1.2/0.9
	110	1.7/1.5	34/25	25/11	113/101	0.6/0.4
50-60 Hz Power Freq.	10	0.7/0.5	70/57	26/16	10/9	59/59
	110	0.4/0.2	4.4/2.9	20/15	3.0/2.2	54/59
65-300 Hz Pwr Harm.	10	1.4/1.4	739/457	2.7/1.1	16/11	5.1/4.9
	110	0.5/0.3	44/27	2.1/1.0	12/10	5.2/4.7
305-2560 Hz High Freq.	10	0.7/0.6	231/121	1.6/0.6	2.8/1.75	1.4/1.3
	110	0.16/0.10	14/6.8	1.1/0.5	2.2/1.8	1.3/1.2
5-2560 Hz All Freq.	10	4.4/3.5	998/657	40/15	129/100	59/60
	110	1.9/1.5	60/32	34/13	113/102	55/59

1 Bandwidth designations shown here were designated by ERM for the reporting of these data only and are not generally recognized designations for bands in their frequency range.

2 At 10 cm above the floor, the dc magnetic field saturated the flux gate magnetometer sensor for some measurements.

In terms of frequency components or spectral density characteristics, the maglev fields are more variable and cover a wider frequency range than do the single fundamental frequency (e.g., 60-Hz) surface rail system such as Amtrak. Maglev-generated fields exhibited high spectral power density in the 15 Hz range. This 15 Hz component is close to the 16.6 Hz fundamental used in Switzerland, for example, and according to the bandwidth designation scheme used by Dietrich et al., falls into the same band as the 25 Hz fundamental used by Amtrak.

Temporal characteristics of the Transrapid maglev field as determined on a many second or minute time scale can be seen earlier in Figure 3-1. These reflect increased current flow in the system when accelerating or breaking. This pattern of current use is common to systems that operate over short track lengths between stops. In terms of exposures for train crews, patterns such as that shown in Figure 3-1 may be of interest in terms of the apparent enhancement of biological effect from intermittent as compared to continuous exposure. The relatively high static magnetic field flux densities (compared to the geomagnetic field) associated with some of these systems that operate on dc power make these exposures of possible interest relative to the various proposed resonance models for biophysical coupling of the fields to biological tissue.

3.9 HEALTH-EFFECTS-RELATED STUDIES INVOLVING ELECTRIC RAIL TRANSPORT AND MAGLEV MAGNETIC FIELDS

Several epidemiologic studies considering electric rail transport workers have been published. These are reviewed in Chapter 7 and include studies from Japan, Switzerland, Italy, and Norway. In the Swiss study, increased risks for leukemias and lymphomas were found (Balli-Antunes et al., 1990). In Norway, Tynes and Anderson (1990) reported increased breast cancer risk. In a subsequent nested case control study (Tynes et al., 1993), no difference was reported in leukemia or brain cancer risk for workers on electrified sections of the rail system as compared to workers on non-electrified (diesel-operated) sections. In the Japanese (Nakagawa et al., 1992) and Italian (Baroncelli et al., 1986) studies, no adverse health effects were observed in the electric rail transport worker populations studied.

Results from laboratory studies conducted specifically to determine biological effects from simulated maglev magnetic fields have also been reported (Groh, et al., 1992), and are reviewed in Chapter 4. These studies use simulated maglev fields for exposure and included exposures having up to 7 times the amplitude of the measured maglev fields. In cellular studies, no differences were observed between exposed and control cell preparations. In studies wherein rats were exposed to these fields, no significant alterations in pineal melatonin concentrations and NAT activity were observed for simulated maglev field exposures of less than 7x amplitude. Changes in NAT activity and pineal melatonin concentration were observed for a positive control square wave signal, and for the 7x amplitude simulated maglev magnetic field exposure. The difference in melatonin concentrations between exposed and control groups was not statistically significant.

3.10 CONCLUSIONS

Although the variation in frequency for Transrapid maglev-generated fields may be greater than for those associated with rail technologies, this variance is essentially confined to the frequency range below 2.5 kHz and is within the range of frequencies associated with current electrically powered rail transport systems. Available data on flux density, frequency, and temporal attributes of Transrapid maglev magnetic fields, and on magnetic fields associated with conventional electrically powered rail transport systems, indicate that the combination of dc fields and the range of frequencies encountered in the TR-07 is clearly not matched in any of the rail transport technologies considered here.

4. BROADBAND EMF AND PROPOSED MECHANISMS FOR THEIR DETECTION BY BIOLOGICAL SYSTEMS

4.1 SYNOPSIS

A variety of possible mechanisms have been proposed to explain how weak EMF may interact with biological systems. These include mechanisms (e.g., induced currents) for which consideration of noise inherent in biological systems is important, as well as several for which these considerations appear relatively unimportant (e.g., effects on free radical electron spin states). Certain of the proposed mechanisms are frequency dependent. These non-monotonic dose-response effects can arise both from resonance phenomena inherent in the mechanisms as well as from the response characteristics of the affected biological system.

Biological responses to magnetic fields may depend directly on the action of magnetic fields or on the electrical currents that time-varying magnetic fields induce in biological tissue. Both induced current and direct magnetic field effect models will be presented and discussed. Sources of fundamental electrical noise and biogenetic electric fields will be discussed as an introduction to the problem of detectability for weak external magnetic fields in tissue.

In view of the often observed dependence on magnetic field frequency in certain laboratory studies, it is important to consider possible implications of the broadband nature of EMF. EMF can be considered as broadband if they cannot be characterized by one frequency or a small set of frequencies. More quantitatively, a broadband signal is defined as any signal for which the ratio of its bandwidth to its mean frequency is larger than 0.5.

As a practical illustration of the induced current models, clinical application of pulsed magnetic fields to bone growth stimulation will be discussed. Theoretical underpinnings that have led to the design of successful clinical equipment for bone healing in humans are of demonstrated relevance to broadband magnetic field effects in humans. Other proposed mechanisms for magnetic field signal transduction will also be discussed. These include magnetic field effects on free radical state populations and possible implications of biogenic magnetite, as well as the resonance models and coherence. For more detail regarding the various proposed mechanisms reviewed in this chapter, see the collected papers in *Bioelectromagnetics*, Supplement 1 (1992).

4.2 INTRODUCTION

In the induced electric field models, the site of interaction for EMF signals is usually thought to be the cell membrane, at which a transmembrane voltage change could trigger a modulation of cell function. Many EMF interaction models involve modulation of ion binding rates as originally proposed by Pilla (1972), who developed membrane impedance models to predict optimal signal frequency for matching to the impedance. Extensions of this model involved Lorentz force considerations, which eventually led to the suggestion that the magnetic field was the predominant stimulus. There followed ion resonance and quantum theories which predicted combined ac and dc magnetic field effects.

In the induced current models, it is assumed that, for an EMF bioeffect to be possible, the electromagnetic signal must cause sufficient transmembrane voltage to be detectable above the various fundamental and background sources of the cell membrane or tissue aggregate noise as discussed later. Cell-cell communication via electrical contacts (gap junctions) between cells in tissues (Loewenstein 1981) can result in orders of magnitude more EMF sensitivity than isolated cells and/or tissues with no, or non-functional, gap junctions. The cell array model discussed in this section illustrates this by the following relationship between the transmembrane voltage, V_M , and the applied electric field, E :

$$\frac{V_M}{E} = -\lambda^{1/2} [\tanh(L\lambda^{1/2})] \quad (4.1)$$

which shows that V_M increases in an exponential fashion with the number of cells in effective electrical contact (L =cell array length, which is proportional to cell number). The frequency response of the system also depends upon L and the array impedance, λ .

The important characteristic of the EMF source in assessing electromagnetic dosimetry is the time-rate-of-change of the magnetic field, dB/dt . A simple working relationship to assess the induced electric field, $E(t)$, can be obtained for a target having cylindrical geometry as:

$$E(t) = -\frac{dB}{dt} \frac{r}{2} \quad (4.2)$$

which states that the amplitude of the electric field within the area of the target penetrated by the magnetic field is proportional to dB/dt and the radius of the target (i.e., to target position or size). Peak magnetic field (B) is determined by the pulse duration, τ , for a signal with constant dB/dt .

4.3 INDUCED ELECTRICAL FIELDS AND CURRENTS: KNOWLEDGE GAINED FROM CLINICAL APPLICATIONS

The characteristics of the time-varying electric field, $E(t)$, induced in conducting biological tissue (target) by a time-varying magnetic field $B(t)$ are directly related to the electrical characteristics of the source of the time-varying magnetic field. In most cases, this is a time varying current generating source. Thus, $E(t)$ is proportional to the rate of change of current, dI/dt , in a conductor. The evaluation of this quantity for a given driving voltage function results in a description of the shape of $E(t)$ in vacuum, air, and all non-magnetic homogeneous conducting media in which the resulting current flow is not high enough to produce significant back electromotive force (the case for body fluids) (Hayt, 1981).

Figure 4-1 shows the typical magnetic field function employed in therapeutic applications. The shape of the B vs t curve can be controlled in therapeutic devices to obtain the desired induced electric field waveform. The rationale behind the choice of these waveforms was the assumption that the induced electric field (and associated current flow) is the active physical

parameter. The magnetic field is not considered to have a direct biological effect. For this reason, the peak amplitude of the induced electric field is usually between 1 and 20 mV/cm. In addition, the frequency content is high (i.e., dB/dt is rapid, of the order of G/ μ sec).

The B vs t curve at extremely low frequencies has much lower rates of change and therefore induces electric fields of much lower amplitude. Figure 4-1 shows the typical range of values to be expected from power line sources. Somewhat higher amplitudes can be expected from switching or other sources, for which components have been measured to approximately 2000 Hz (Dietrich et al., 1992). The induced EMF amplitude is, in any case, significantly lower (10^{-6} to 10^{-2} mV/cm) than that for therapeutic devices.

Induced waveforms obtained by therapeutic or ELF sources represent the dynamics of the electric field signal applied to the cell/tissue complex. The distribution of current flow depends on the geometry of coil and tissue. The basic rule is that the voltage induced will act like that from a three-dimensional voltage source, defined by the distribution of magnetic flux within the tissue.

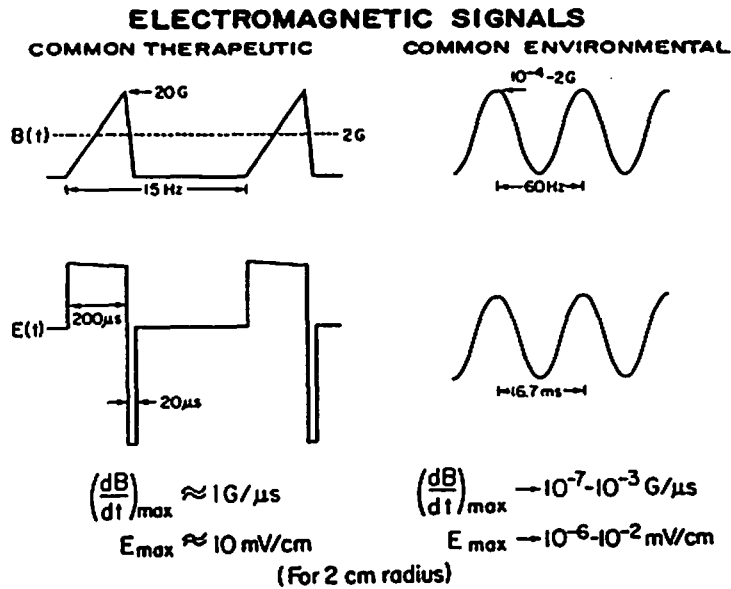

Figure 4-1. Typical induced electric field waveforms from therapeutic and environmental devices. Note that the peak amplitudes are significantly different for identical target geometry.

The question of whether the magnetic versus induced electric field is the primary physical stimulus in a number of model systems has been recently addressed by both in vitro and in vivo studies. A recent paper by Liburdy (1992) clearly demonstrates that the induced electric field is the active component for a 22 mT, 60 Hz magnetic field in an in-vitro model. This study showed that calcium transport in mitogen-stimulated thymic lymphocytes scaled with the induced electric field, not with the applied magnetic field. The basis of the experiment was control of the level of the induced field by the size of the current loop in specially constructed annular culture dishes.

As shown in eqn 4.2, electric field amplitude is dependent on the loop radius. The in vivo experiments consisted of exposure of fibular osteotomies in the rabbit to a clinically effective pulse burst EMF applied via an external coil or implanted electrodes (Pilla et al., 1992). The results showed that the biomechanical acceleration of bone repair depended only on the in situ electric field, and not on the magnetic component present in the external coil signal to couple inductively the electric field to the repair site.

4.4 THE PROBLEM OF SIGNAL TO NOISE RATIO (DETECTABILITY)

Whether weak environmental or therapeutic EMF can affect the behavior of living cells and tissues remains controversial. The biophysical community often maintains that basic physical principles cannot explain EMF bioeffects (Adair, 1991). Some clinicians, epidemiologists, and biological scientists, on the other hand, are thoroughly convinced that there are real bioeffects caused by specific weak EMF (Savitz et al., 1988; Blackman et al., 1985). The physical argument against the possibility of an EMF bioeffect is usually based on the ratio of transduced transmembrane voltage signal to the root mean square (RMS) thermal noise voltage.

As in other materials, biological cells and tissue are subject to random fluctuations in energy that constitute noise. In biological systems, estimations of signal-to-noise ratios for detection of externally induced electric fields must consider fundamental phenomena such as thermal noise, shot noise, and so called "1/f" noise as well as a variety of physical and biological "background" noise sources (Weaver and Astumian, 1992). Thermal, 1/f, and shot noise appear intrinsic to materials at temperatures above absolute zero and are considered fundamental.

Fluctuations in thermal energy are a fundamental property of materials. In resistive materials such as the cell membrane, an applied potential (transmembrane voltage) will exhibit noise due to these fluctuations in thermal energy. The magnitude of these random fluctuations together with other sources of noise constitutes a theoretical lower limit on the change in electrical potential at the cell membrane that can be detected as information by the cell. Estimates of these fields at the membranes of mammalian cells range from approximately 10⁻¹ V/m for broadband noise to approximately 10⁻³ V/m for narrow-band signals. If cells are capable of signal averaging by capacitive properties, for example, this lower value may apply to broader band signals.

Shot noise arises from discrete random events. It is best described by Poisson statistics and, like thermal noise described above, is fundamental and probably universal. In biological systems there are a myriad of discrete events which are subject to shot noise, including random collisions of ions in solution and the passage of ions and molecules through membrane channels.

Last among the types of noise thought to be fundamental and hence inescapable is "1/f" noise. These fluctuations increase with decreasing frequency (f), and upon examination, their amplitude as a function of frequency is found to be approximately proportional to $1/f$. According to Weaver and Astumian (1992), this type of noise probably dominates in biological systems when frequencies in the low kHz range and below are considered.

Other sources of energy fluctuations in biological systems can also interfere with the theoretical ability of cells to detect small changes in the electric field. On the microscopic level these include noise from discrete events such as opening and closing of membrane ion channels (Helman and Van Driessche, 1990), local changes in electrolyte composition, and local temperature variations. On a macro scale, streaming potentials associated with mechanical stress in bone, the electrocardiographic (EKG) and electro-encephalographic (EEG) potentials, and time-varying magnetic fields originating in the cerebral cortex (the magnetoencephalographic or MEG signals) are examples of internal electric field sources. While these macro-scale phenomena are not, on the whole, random in nature, they contribute to the general background of electromagnetic energy in cells and tissue.

In the space between cells, the current densities from biogenic sources are far greater than those induced by an external magnetic field of $1\mu\text{T}$, for example. However, this fact alone does not necessarily preclude detection of weak electric signals by cells or organized tissue. In order for an external signal to be detected against such a background, however, the signal must have some unique characteristic that would allow its distinction from biogenic electric fields and other noise. The signal to noise ratio (SNR), then, is usually calculated by assuming that the EMF target is a spherical cell of $10\mu\text{m}$ radius. These calculations often lead to $\text{SNR} \ll 1$ for low frequency environmental EMF in the mG amplitude range.

4.4.1 Cell Array Tissue Model

Organized tissue is developed and maintained by an ensemble of complex geometry cells which have coordinated activity (Caveney, 1985). The most prevalent cell shape in living systems is elliptical and flattened, with processes extending in at least two directions. For example, human fibroblasts can typically exceed $100\mu\text{m}$ when attached to a substrate (connective tissue). Thus, the grossly oversimplified spherical cell model cannot depict reality with any degree of accuracy. Most cells are anisotropic in shape and function and could be oriented to capture (detect) significantly more of the applied field than its corresponding isotropic shape (McLeod et al., 1987).

Gap junctions provide pathways for ionic and molecular intercellular communication (Sheridan et al., 1985). They are present in all tissues including bone (Doty, 1981). The role of cooperative organization in the EMF sensitivity of biological systems has been qualitatively considered (Adey, 1988). Gap junctions have been considered to provide ionic coupling and metabolic cooperation, without which disorders in growth control and tissue repair, as well as neoplastic transformations, could occur (Loewenstein, 1981). Functional modification of gap junctions by modulated microwave fields has been reported (Fletcher et al., 1986).

Weaver and Astumian (1990) have discussed the lower limit of cell sensitivity to external electric fields based on considerations of thermal noise. They postulate a maximal sensitivity of between 10^{-3} and 10^{-6} volt/cm only by allowing for time averaging and accounting for the spatial amplification produced by the cell/cell membrane geometry. An example of a time-averaging mechanism is provided by Tsong et al. (1988, 1989) and Westerhoff et al. (1989), although these studies employed fields on the order of 100 volt/cm. Membrane ATP-ases were employed in this work as transducers capable of absorbing energy from electric fields of defined frequency and using this to influence chemical reaction rates. The experimental results demonstrate stimulation effects of these electric fields on Rb^{+} uptake by electric fields which is ouabain inhibitable, directly implicating the Na/K ATPase.

Gap junctions increase the effective electrical "size" of cell arrays which changes EMF sensitivity, and therefore SNR. To calculate SNR for a cell array, a useful model is a distributed parameter linear electrical analog (transmission line) allowing the induced transmembrane voltage, V_M , to be evaluated as a function of frequency and position. This is similar to the electrophysiological models which have been proposed for current spread in electrotonically coupled tissues (Shiba, 1971) and the dc model proposed to account for tissue sensitivity to the weak electric currents commonly found in developing and regenerating tissues (Cooper, 1984).

A first order electrical model for a linear cell array in gap junction contact is shown in Figure 4-2.

The effect of frequency and array length, L , on the spatial amplification of the transmembrane voltage is shown in Figure 4-3. There is a substantial increase in $V_M(L, \omega)$ as L increases. The frequency response for a single cell ($L=10\mu\text{m}$) shows that V_M is maximum between 10^5 and 10^6 Hz. In contrast, for a 1 mm cell array (e.g., Dipteran salivary gland), V_M is about 10^2 higher than for a single cell, but only at frequencies below 100 Hz.

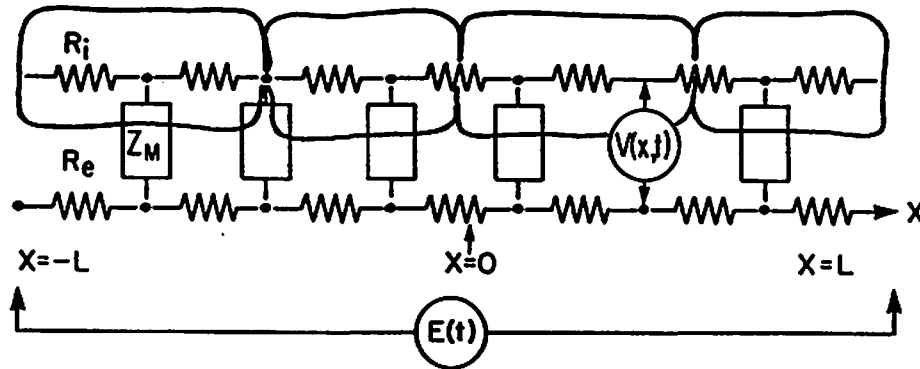

Figure 4-2. First order linear electric model for a cell array in gap junction contact. This distributed parameter system describes the propagation of the applied signal, $E(t)$, along the array. The induced transmembrane voltage, $V(x,t)$, is the quantity of interest. Its value at any position, x , and at any time, t , is determined by the extracellular, R_e , and intracellular, R_i , resistances and the particular membrane impedance, Z_M , per unit length.

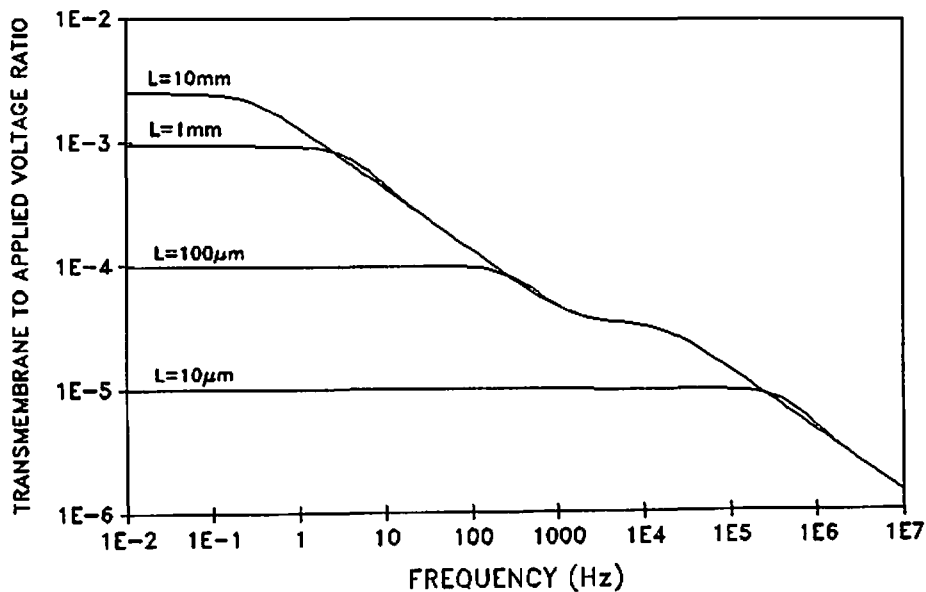

Figure 4-3. Frequency dependence of spatial amplification (V_M/EL) for various cell array lengths. There is a substantial increase in transmembrane voltage as L increases, but at lower frequencies, reflecting the increased propagation time for longer array lengths.

4.4.2 Signal to Noise Calculations Under Biologically Relevant Assumptions

Noise sources in biological membranes include thermal, flicker (1/f), shot and conductance fluctuations (Stevens, 1972). The latter three usually relate to ion transport, and their interpretation is model dependent. Thermal noise, present in all voltage-dependent membrane processes, is considered here for SNR calculations. The power spectral density, $S_n(\omega)$, of thermal noise is (DeFelice, 1981):

$$S_n(\omega) = 4kTR_e[Z(x, \omega)] \quad (4.3)$$

where $Z(x, \omega)$ is the impedance of the cell array (Figure 4-3 and R_e denotes its real part. From this, $Z(x, \omega)$ is obtained as:

$$Z(x, \omega) = \frac{(R_e + R_i)}{\gamma} \tanh(\gamma x) \quad (4.4)$$

This allows the contribution from R_e and R_i , which are electrically connected to the membrane, to be taken into account, in contrast with common practice (Adair, 1991; Weaver and Astumian, 1990).

The most common approach to the evaluation of SNR uses the RMS noise voltage. This is calculated by taking the square root of the integration of eqn 4.3 over all frequencies relevant to either the complete membrane response, or to the bandwidth of the detector pathway. SNR is given by:

$$SNR = \frac{|V_M(\omega)|}{RMS} \quad (4.5)$$

where $|V_M(\omega)|$ is the maximum amplitude of the transmembrane voltage at each sinusoidal frequency.

The frequency characteristics of SNR vs. L are shown in Figure 4-4 for the simple membrane model. As can be seen, the presence of gap junctions allows arrays to form which are of sufficient length to increase spatial amplification by several orders of magnitude.

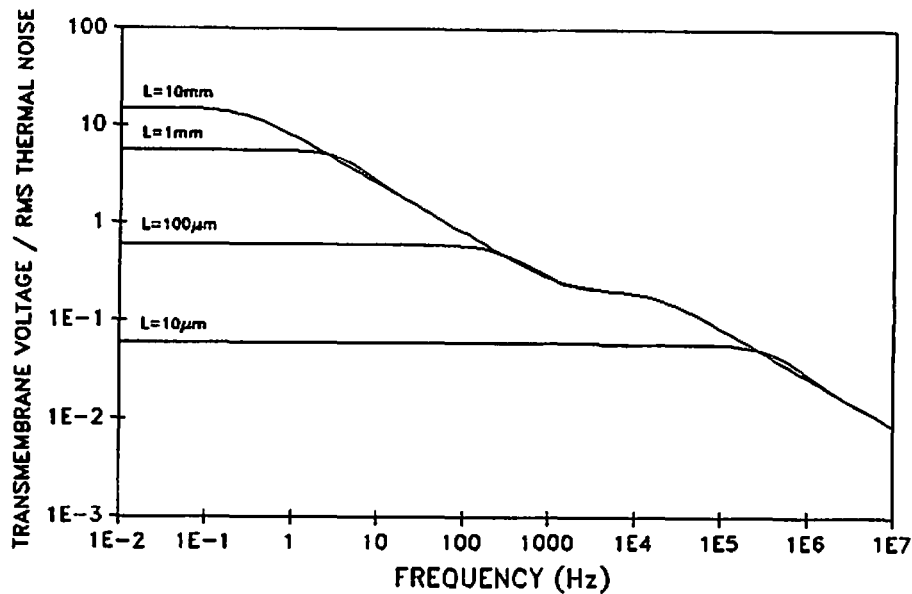

Figure 4-4. Frequency dependence of SNR on array length, L , to 10^7 Hz. Maximum SNR is achieved only at low frequencies and only becomes useful for large L .

While the preceding calculation of SNR is often utilized, the detail of the frequency response of both V_M and thermal noise is not taken into account. Thus, noise components in the high frequency range may be irrelevant if the responding pathway only has kinetics within a bandpass of 10^2 Hz. It is therefore of interest to examine the ratio of the frequency spectra of transmembrane voltage and thermal noise, $V_M(L, \omega) / [S_n(\omega)]^{1/2}$. This is shown in Figure 4-5 for a sinusoidal input of constant amplitude (1V/m) at each ω . The spectral ratio increases for larger L , but, again, only at low frequencies. In the highest frequency ranges, increasing L provides no advantage. At all frequencies (to 10^7 Hz), the spectral ratio is > 1 , even for a $10 \mu\text{m}$ cell. These results appear to show that, if the applied electric field was reduced from 1 V/m to 10^{-4} V/m (10^{-3} m V/cm), the cell membrane may still be able to detect a transient voltage change.

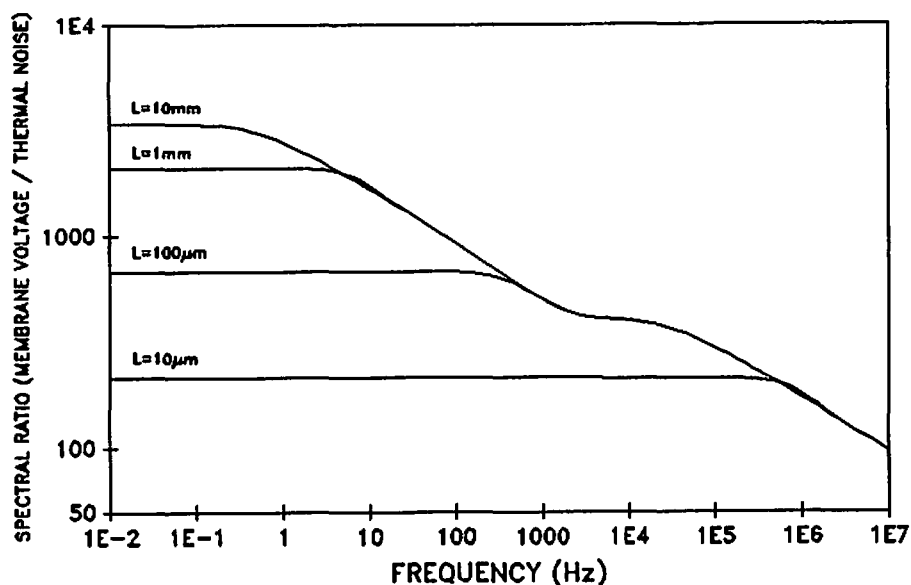

Figure 4-5. Frequency dependence of the spectral ratio of the induced transmembrane voltage and thermal noise voltage on array length. This reveals the frequency details which show that, at all frequencies (to 10^7 Hz), $V_M(L, \omega)/S_n^{1/2} > 1$, even for a $10 \mu\text{m}$ cell.

The results of this analysis indicate that significant spatial amplification occurs for cell arrays versus single cells; however, both the propagation time and the particular membrane impedance pathway can considerably lower the frequency at which bioeffective SNR is likely to be achieved. In addition, the frequency response of the cell array appears to indicate that maximal spatial amplification may occur only over a specific frequency range. This reinforces the suggestion that tuning the input, $E(\omega)$, to the bandpass of the detector could lead to dose efficient and selective EMF bioeffect.

This derivation suggests that spatial amplification of cells in gap junction contact versus that for isolated cells must be taken into account when assessing EMF sensitivity. While cell networks naturally occur in developing and repairing tissue, it is not clear that the formation of gap junctions between cells *in vitro* is sufficiently reproducible. This renders the problem of duplicating results *in vitro* exceedingly difficult but does not change the increased EMF sensitivity gap junctions may provide.

Clearly, weak environmental EMF signals are often within sufficiently low frequency ranges for adequate SNR to be obtained in cell arrays of physiologically relevant size. All of the above lead to the conclusion that bioeffects, particularly in organized tissue, are indeed possible from exposure to remarkably low levels of EMF.

4.5 PROPOSED MODELS FOR INTERACTION OF EMF WITH BIOLOGICAL SYSTEMS

The physical mechanism(s) of interaction of EMF on biological tissues as well as the biological transductive mechanism(s) are yet to be elucidated. An important question concerning these interactions remains: Is there a unifying mechanism that can explain the wide range of results and provide for predictive ability of electromagnetically induced biological effects?

This section will discuss the theories that have been proposed to account for modulation of the biological target by electric field only, combined electric and magnetic fields, and magnetic fields.

4.5.1 The Electrochemical Information Transfer Model

It was proposed in the early 1970s that EMF may affect ion adsorption/binding and therefore trigger a cascade of biological processes (Pilla 1972, 1974). This electrochemical information transfer hypothesis postulated that the cell membrane would be the site of interaction of low-level EMF by altering the rate of binding of, for example, calcium ion to enzyme and/or receptor sites. Consideration of voltage-dependent (electrochemical) interactions at the cell membrane provides a quantitative look at the cell's real time responses to the currents induced by EMF. Here it is important to note that the role of ions as transducers of information in the regulation of cell structure and function is widely accepted. Examples of ionic control mechanisms include: growth factor activation of Na-K ATPase in fibroblasts (Mendoza et al., 1980; Lopez-Rivas et al., 1982); nerve growth factor effects regulated by Na-K ATPase (Boonstra et al., 1981, 1982); Ca^{2+} regulation, via calmodulin, of the cell cycle (Chafoules et al., 1982; Whitfield et al., 1981); differential Ca^{2+} requirements of neoplastic versus non-neoplastic cells (Boynton et al., 1977; Hazelton and Tupper, 1979); and Ca^{2+} dependent adenylate cyclase activation in macrophages (Gearsa et al., 1979). This represents, therefore, a coupling mechanism for EMF that can be quantitatively analyzed. The interaction of ions at the electrically charged interfaces of a cell is an example of a potential or voltage dependent process. The following is a review of the basic electrochemical kinetics approach to quantitate these ionic and/or dipolar interactions.

The working concept of electrochemical information transfer *in vivo* uses the analogy between the electrified interfaces at the electrode/electrolyte and membrane/fluid junctions (Pilla, 1972, 1974). A change in the electrochemical microenvironment of the cell can cause the structure of its electrified surface regions to be modified, e.g., by changing the concentration of a specifically bound ion or dipole which may be accompanied by a modification in the conformation of molecular entities (such as enzymes) in the membrane structure. Basically, therefore, the regulatory interactions at a cell's surface are considered to have both voltage and kinetic functional relationships with the specific biochemical events to which these processes may be coupled.

Two distinct types of electrochemical interactions can occur at cell surfaces. The first involves all of the non-specific electrostatic interactions involving water dipoles and hydrated (or partially hydrated) ions. This structure is analogous to the electrode/electrolyte interface and can contribute, along with lipid and protein asymmetry (Bretscher, 1972; Zwaal et al., 1973; Tsai and Lenard, 1975), to the observed dielectric response of the lipid and lipoprotein membrane structures (Pilla and Margules, 1977; Pilla, 1980).

The second type of charge interaction considered at a cell surface involves potential dependent specific adsorption (or binding). Here an ion or organic dipole can effectively compete with water dipoles and hydrated ions for specific membrane sites. This type of interaction involves, for the aqueous phase, the steps of dehydration, displacement, and binding (Parsegian, 1975; Urry, 1978). If this is to engender a membrane function change, then the structure of the molecular entity within the membrane at which the binding occurs can undergo modification. For example, the allosteric nature of certain enzymes surely allows this to occur (Singer, 1971). In addition to enzyme activity, it is known that biochemical reactions on the cell surface involve charged reactants (Goldstein et al., 1964) and the surface potential (and therefore structure) is experienced by an ionic species involved in membrane transport (McLaughlin et al., 1970; McLaughlin, 1972).

A third type of interaction is specific adsorption coupled with membrane transport. Upon application of pulsating current, sufficient new charge can be injected to cause the divalent cation to enter the membrane phase. Once in this phase, it can either occupy an available site within the aqueous channel, thereby causing a modification in the interaction of the peripheral/integral protein complex, or it can be transported through the membrane to an available binding site at the peripheral protein/aqueous phase interface. In either case, the net result may be a change in the activity of the peripheral protein which, if it is in a regulatory pathway, can modulate cell function. This could be one of the key steps in the creation of a biochemical feedback loop which modifies its functional state.

The most straightforward method to quantitate the above approach, which also provides unambiguous parameters capable of being experimentally tested, is to generate the electrical impedance of each relevant electrochemical pathway. All variables in this study will be given in terms of the complex frequency plane of the Laplace transformation (Cheng, 1959). This frequency variable, s , has a real, σ , and an imaginary, $j\omega$, part which define the axes of the Laplace plane. The utilization of Laplace transformation allows a time domain function (such as a pulsating current) to be expressed in terms of its frequency content. Utilization of this transformation along the imaginary ($j\omega$) axis results in the familiar Fourier transformation by which the frequency spectrum of time domain signals is often expressed. Determination of the impedance, $Z(s)$, of a cellular system will ultimately require knowledge of the input pulsating current waveform and the pulsating voltage response of the membrane.

The physical passage of current into the membrane causes a change in the surface charge and may elicit transmembrane transport. The equivalent electrical circuit model permits a quantitative description of pulsating current flow into a cell membrane. It allows limits to be placed on tissue level current waveform parameters. For example, the time constants associated with the membrane processes are often known and measurable (Pilla and Margules, 1977; Pilla et al., 1985; Schwann, 1985). These values define the frequency

spectrum requirements of the waveform. Additional requirements are related to the fact that *in vivo* bone repair involves tissue (as opposed to isolated cell) response. This modifies the current waveform frequency spectrum requirements, as was shown in Section 4.3.

4.5.2 Extensions of the Electrochemical Information Transfer Model

Theoretical studies initiated in the late 1970s focused on the potential of EMF to alter binding rates of specific ions and ligands to receptor types, or to affect the ion or charged particles (ligands) motion in solution (Chiabrera et al., 1982). The implication of the latter would be to increase the kinetic availability of these ions in ionic-dependent processes, such as ion-selective channels, etc. Theoretical modeling of ligand binding to cells employed phytohemagglutinin (PHA) as the mitogenic ligand and lymphocytes as the target cell (Chiabrera et al., 1984). A microelectrophoretic effect was calculated which decreased the mean lifetime of ligand-receptor complexes. The net effect would be to reduce the mitogenic efficiency of the ligand, PHA (Chiabrera et al., 1985). Reduction of mitogenic stimulation of lymphocytes by PEMF (Conti et al., 1983) may be explained by this model.

These experimental studies, in conjunction with previous and subsequent work on PEMF influence on calcium efflux from brain tissue (Bawin and Adey, 1976; Blackman et al., 1982, 1985, 1988), demonstrated the appearance of windows in PEMF effects. These "windows" are combinations of amplitude and frequency within which there is an observed response, and once outside this range the response is nonexistent. Wei et al. (1990) describe succinctly a "window effect" in their report on transcriptional changes in HL60 cells. These results demonstrated up to a four-fold increase in transcripts of c-myc and histone H2B with the peak effect being at 45 Hz. This frequency response provides the first evidence for regulation at the nuclear level.

Three complementary theories that evolved from this "windows" concept provide a framework for mechanistic modeling. These theories are: (1) ion resonance theory, (2) Lorentz/Langevin theory, and (3) quantum parametric resonance theory. Further, these physical models are presently being tested in biochemical systems. Liboff (distinct from below, 1965, 1966) demonstrated effects of crossed electric and magnetic fields on Brownian motion of charged particles, although not in biological systems. Without reference to the above work, these three complementary theories all involve the combined effects of dc and ac magnetic fields in biological interaction mechanisms.

4.6 DIRECT MAGNETIC FIELD INTERACTION MECHANISMS

4.6.1 Ion Cyclotron Resonance

In a steady state magnetic field, charged particles of constant velocity describe a path of radius r as determined by application of the Lorentz force equation and Newton's second law of motion. In the cyclotron, an electric field is applied at a frequency which corresponds to the cyclotron frequency f (equation 4.6) of the ion. This will tend to increase the tangential

velocity of an ion in the magnetic field. The path radius r will also increase, as shown in equation 4.7.

$$f = qB/2\pi m \quad (4.6)$$

$$r = mv/qB \quad (4.7)$$

where q is the charge, B is the flux density of the stable magnetic field, m is the mass of the ion, and v is the velocity.

Such an electric field can be induced by an alternating magnetic field in the same direction as the steady state B field. As the ion cyclotron resonance model is applied to biological systems, the geomagnetic field provides the steady state B component and the man-made ac magnetic fields provide the electric field component. Note from equations 4.6 and 4.7 that it is the flux density of the static field and the frequency of the ac field that determine the mass to charge ratio for ions that can couple to and thus derive kinetic energy from the simultaneous presence of the two field components. Ion cyclotron frequencies for many biologically important ion fall in the range below 100 Hz at earth strength magnetic fields in the 50 μ T range.

The ion cyclotron resonance mechanism, as proposed by Liboff (1985) and advanced by Liboff et al. (1987a), described frequency specific combinations of dc and ac magnetic fields which were thought to couple directly to calcium-dependent processes, by increasing ion mobility near receptor and/or ion channel sites. Experimental verification of these models, although still in early stages, has provided encouraging data to support the notion of direct coupling to ion-dependent processes (Liboff and McLeod, 1988).

McLeod et al. (1987) reported that combinations of dc and ac magnetic fields calculated to couple to a resonant frequency for Ca^{2+} stimulated diatom motility while detuning to a resonant frequency for K^+ led to loss of this effect. These studies were extended to mitogenic stimulation of lymphocytes (which is calcium dependent), and it was again observed that tuning to calcium frequencies led to enhancement of mitogenic stimulation (Liboff et al., 1987b). Of particular interest in the latter study is that nifedipine (a dihydropyridine calcium channel blocker) inhibited the ac/dc effect, indicating a role for calcium channels. Lyle et al. (1991) and Reese et al. (1991) have recently reported qualitatively similar results in lymphocytes and diatoms, respectively.

The Lorentz force equation was used by Chiabrera and Bianco (1987) to relate individual influences of both ac and dc EMF to ligand receptor binding and motions of ions (or other charged molecules). This work was further expanded to include thermal noise effects on the ion binding kinetics with a Langevin-Lorentz model (Chiabrera et al., 1989; Kaufman et al., 1990). This stochastic analysis modeled the motion of the charged ligand as a random walk, i.e., Brownian motion with drift (Chiabrera et al., 1989). EMF signals designed with the Lorentz theory were used in an attempt to affect the calcium-dependent motility of paramecium, and resonance effects were again observed which correlated with combined ac/dc effects on calcium ion motion (Chiabrera et al., 1989).

All of these classical approaches have been seriously criticized on the grounds that ions do not move in a vacuum near a membrane binding site and that collisions would render the basic Lorentz force inoperative. In addition, Chiabrera et al. (1991) have shown that the inclusion of thermal noise in the model clearly shows that this mechanism, as currently proposed, cannot account for the observed biological responses that have been cited in its support.

4.6.2 The Quantum Theories

A fundamental problem with the Lorentz force approach relates to the large forces existing at most ion binding sites. Classical approaches may not be sufficient to predict the effect of external forces on the kinetics of these processes. This problem led Lednev (1991) to formulate a paramagnetic resonance quantum approach which modeled the calcium ion inside a calcium binding protein (i.e., calmodulin) as a charged harmonic oscillator. This spatial oscillator has a set of vibrational frequencies that depend upon the bond energy, charge, and mass of the bound ion. The presence of a static magnetic field splits the energy level of the bound ion into two sublevels with amplitudes corresponding to electromagnetic frequencies in the infrared band.

The difference between these two energy levels is the Larmor frequency. Application of a co-linear ac magnetic field modulates the two energy sublevels and, if the ac frequency is at or near the Larmor frequency, the probability of ion transitions between energy states can be sufficiently altered to affect binding kinetics. Experimental evidence for this effect utilized the calcium/calmodulin-dependent myosin light chain kinase reaction in a cell-free system (Shuvalova et al., 1991). However, more recent results on the same system indicate that only dc magnetic field changes are necessary to affect phosphorylation (Markov et al., 1992). More recently, Chiabrera et al. (1991) have extended the Lednev approach and suggested that combined ac/dc magnetic field effects could take place, but that excited state lifetime remains a theoretical difficulty with this model.

4.6.3 Coherence

Litovitz and colleagues (1991) have proposed that temporal coherence is an important parameter of weak magnetic fields and may be required for their detection by biological tissue. They suggest that the time-varying magnetic field must remain coherent (i.e., have a single frequency component) for at least 10 seconds in order to be detected by biological tissue. Data consistent with this view have been gathered using L929 and Daudi human cell lines. In these studies, 10 second exposure to a coherent 60Hz magnetic field at either $10\mu\text{T}$ or $100\mu\text{T}$ enhanced ornithine decarboxylase enzyme activity. The enhancement was not observed for continuous exposure periods of less than 10 seconds and was also blocked by application of noise to the signal (Mullins et al., 1993). Superimposition of electromagnetic noise also blocked the alteration of ODC activity in the developing chick embryo model (Litovitz et al., 1993).

It is of interest that coherence of the stimulus signal is important in demonstrating the phase-locking response wherein neurons can be stimulated to fire in synchrony with a very weak sinusoidal input signal that has a period near that of the natural firing rate of the cells (Barnes, 1992).

4.6.4 Magnetite

Magnetite is an inorganic iron compound (Fe_3O_4), normally crystalline in form, that is found in the tissue of a number of animal species. Evidence indicates that the compound is a biosynthetic product of ferrihydrite (Meldrum et al., 1992). Interaction of this magnetic material with the geomagnetic fields is known or believed to be important in adaptation strategies of several organisms, ranging from magnetotactic bacteria to certain migratory birds (Kirschvink et al., 1985). Observation of magnetite crystals in the human brain by Kirschvink and colleagues has raised the possibility that EMF-induced biological effects may be mediated by this material. The hypothesis that magnetite is involved in detection of magnetic fields impinging on the organism is attractive because it circumvents many of the theoretical objections raised to interactions of magnetic fields with otherwise non-magnetic (diamagnetic) biological tissue (Kirschvink and Kobayashi-Kirschvink, 1992). These authors have calculated that a $50 \mu\text{m}$ crystal of magnetite has sufficient magnetic moment to have energy equal to thermal energy (kT) at ambient temperatures when the applied field is in the 1 G range.

Depending on the length and shape of the crystals, it is possible for them to experience a torque in weak magnetic fields, in the same way that a compass needle aligns itself along the geomagnetic field lines of force. In higher animals, it is presumed that this motion may be detected within the cell or groups of cells and result in a signal, perhaps neurological, to which the animal may respond (Kirschvink, 1989). In certain species of fish and birds, increasing magnetite concentrations have been detected in areas of the nasal passages and snout in proximity to magnetic field responsive nerve fibers.

4.6.5 Free Radical Mechanisms

Free radicals are formed when a neutral molecule undergoes homolytic cleavage to form products that have unpaired electrons. According to the Pauli exclusion principle these cleavage products, upon formation, will have oppositely directed spin. Recombination of these free radicals can occur only if their respective spin directions remain opposite. Such products are said to have "singlet" characteristics. Their spin quantum numbers are $-1/2$ and $+1/2$, respectively. As these products diffuse, they may acquire parallel spin pairs (either $+1/2+1/2$ or $-1/2+-1/2$) and are then said to be in a triplet state because the total quantum number J can have three possible values ($L+1$, $L-1$, and L). Chemical reactions dependent on free radicals are known to be affected by magnetic fields.

Thus, several investigators have proposed that magnetic fields may interact with free radicals in tissue to slow their recombination rates (McLauchlan, 1992). Spins of unpaired electrons from the radicals interact with the magnetic field yielding additional energy states in a

process known as Zeeman splitting. Eliminating degeneracy of triplet states (i.e., splitting of triplet energy states) by the magnetic field reduces the population of potential recombination partners for a given state, and thus slows the rate at which free radicals recombine to form neutral (spin-paired) molecules (see Figure 4-6).

In and of themselves, magnetic field interactions with free radicals do not raise the theoretical objections based on thermodynamic considerations that have been cited against postulated effects on neutral molecules or alkali metal ions. Zeeman splitting of triplet spin states is a low-energy process that simply interferes with recombination and prolongs the life of the free radical, a life normally measured in nanoseconds to milliseconds. Except as they may influence the concentrations of free radical precursors in solution, magnetic fields do not influence the formation of free radicals, and therefore their net effect may be to increase slightly the concentrations of these species in biological tissue.

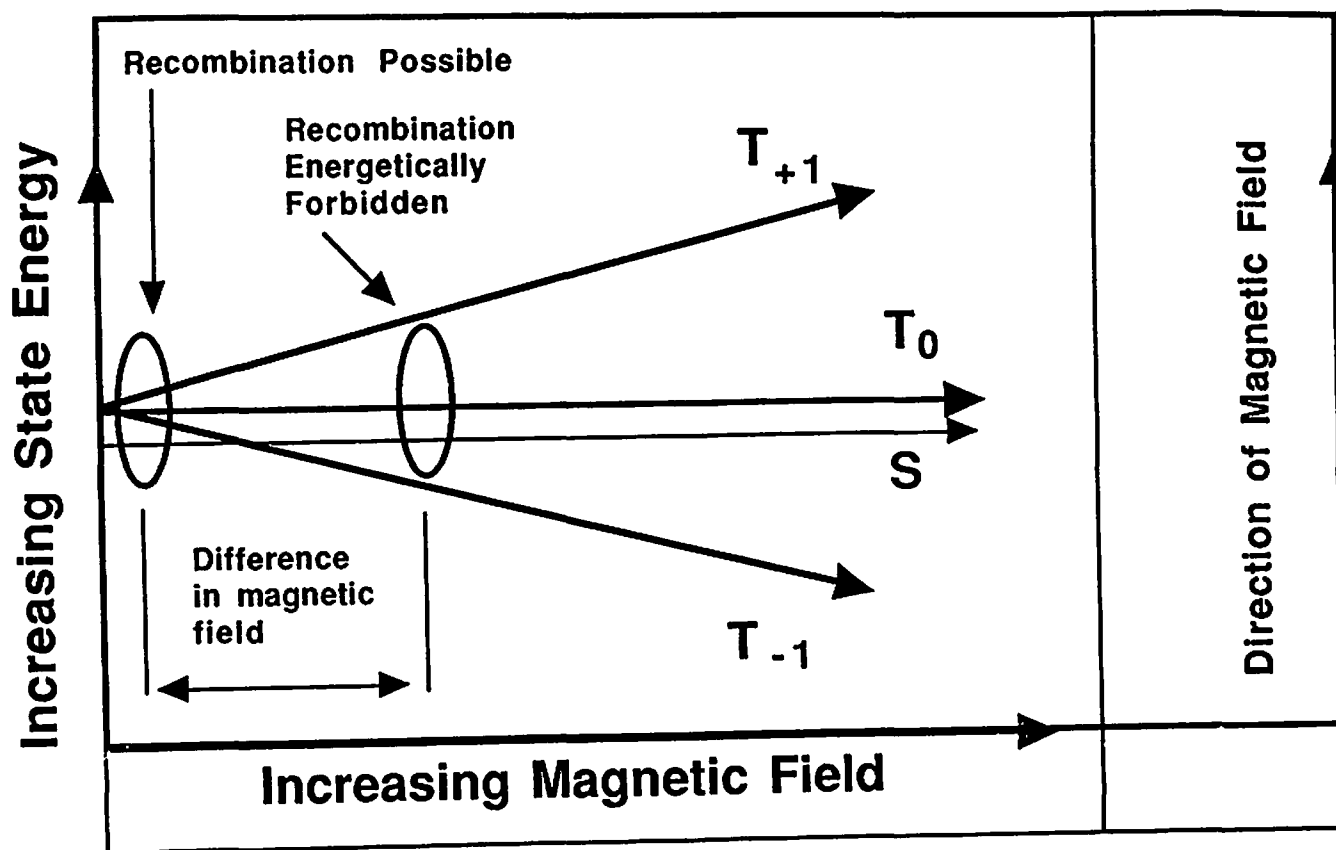

Figure 4-6. Effect of magnetic field on the energy of triplet states. In the triplet state, wherein spins are anti-parallel, the field has no effect. For parallel spin triplet states, the presence of the field reduces the number of potential reaction partners by separating these states in energy. (Adapted from McLauchlan, 1992)

Stevens et al. (1990) proposed that EMF exposure may affect cancer risk via free-radical dependent mechanisms. These authors noted that the presence of oxygen-free radicals in cells increases oxidative stress, and that EMF exposure may lead to increased free radical concentrations by interfering with calcium-dependent scavenging mechanisms. Free-radical species are reactive and are known to be important as chemical cancer promoters. Compounds that scavenge oxygen-free radicals such as vitamins E and C have been shown to be protective against cancers induced by dimethylbenzanthracene (DMBA) and methylcholanthrene. For a review of free radical and oxidative stress effects on cell growth and cancer in the context of EMF exposure, see Pascoe, 1990.

It has also been proposed that magnetic fields may interact with light to affect free radical reactions involved in skin cancer development in chemically initiated animals (McLean et al., 1992). This hypothesis is that magnetic field exposure would tend to increase free radical populations and thereby increase cancer risk. The hypothesis is currently being tested in mouse skin initiation promotion co-promotion study. Preliminary data from this study are consistent with increased free radical concentrations in animals exposed to light and a 60 Hz magnetic field as compared to light exposure only.

4.7 SUMMARY

A variety of mechanisms have been proposed to account for biological effects of EMF. It appears unlikely that any one mechanism will eventually be shown to account for the entire range of biological effects observed as a result of EMF exposure. Several of the proposed mechanisms for transduction of the EMF signal by biological systems have been discussed. It has been shown that the broadband nature of many anthropogenic magnetic fields is an important consideration with regard to the induced current models. With regard to the direct magnetic effect models, the field has been postulated to interact with a variety of magnetic moments in tissue. These include unpaired electron spins, magnetite, and divalent cations such as Ca^{++} . In resonance models, the presence of a dc magnetic field, such as the geomagnetic field, is important. Relatively strong dc magnetic fields associated with several of the transport septum discussed in this report make these models of possible interest.

Most magnetic fields from anthropogenic sources are not purely sinusoidal and contain more than one frequency. Total frequency content or power spectra have not yet been completely defined for most environmental signal sources. It is apparent that the detectable electromagnetic energy of these signals may extend to the 100,000 Hz range when switching transients are included.

In the induced current models, EMF dosimetry at the target site is determined by the time-rate-of-change of the magnetic field, dB/dt. Size and geometry of the exposed tissue determine the final value of the induced electric field. Thus, for a given dB/dt, induced E will be much smaller in the tip of a finger than in the rest of the arm or the thorax.

EMF sensitivity of the target depends upon cell-cell communication via gap junctions. According to this model, the induced transmembrane voltage to thermal noise ratio can be increased by several orders, but only at much lower frequencies than those for a single cell ($< 10^2$ Hz vs 10^5 Hz). Cell arrays of 1 mm could detect 10^{-4} mV/cm at sufficiently low frequencies. Long (> 1 cm) nerve axons could easily detect 10^{-7} mV/cm at even lower frequencies.

The physical mechanism of broadband EMF is generally accepted to be related to E dosimetry at the target site. This is in contrast to a dependence on the magnetic field for which dosimetry does not depend upon the geometry or size of the target, or on dB/dt. The target site for E is generally thought to be ion/ligand binding at the cell membrane. The induced E causes a change in transmembrane voltage, affecting potential dependent specific adsorption (binding) if the dielectric properties of the tissue target are satisfied by the frequency spectral density of the *in situ* E signal.

Only a few reports of direct magnetic field dependence have been published, and only for *in vitro* systems. Few *in vivo* results to date have been shown to depend upon the magnetic field. Those that appear consistent with a direct magnetic field interaction are primarily in the area of behavior.

Faint, illegible text, possibly bleed-through from the reverse side of the page.

Faint, illegible text at the bottom right of the page.

5. BIOLOGICAL RESPONSES TO EMF

5.1 SYNOPSIS

Biological responses to weak EMF are widespread in the animal kingdom. Sensing of these natural fields by biological organisms raises the question of what physiologic effects may follow from detection of anthropogenic EMF in laboratory animals and humans. Likewise, it is important to determine the consequences, if any, for human health that may be associated with biological effects observed in in-vitro systems where neurological sensing of the field is not at issue.

We discuss possible physiologic mechanisms for effects from EMF exposure in each of the possible health effects areas of interest raised in both residential and occupational epidemiologic studies. A prime candidate for such a mechanism is the effect of EMF exposure on the neuroendocrine system and, in particular, on melatonin synthesis and release by the pineal gland. Neurological consequences of EMF exposure that may precede the neuroendocrine effects are discussed, including changes in circulating neurotransmitter concentrations resulting from EMF exposure. Possible consequences of neuroendocrine changes on risk of cancer, miscarriage, mood, and melatonin's effects on physiology in general are discussed in Chapter 6.

EMF effects in in-vitro systems including changes in DNA transcription and translation and enzyme synthesis are briefly reviewed. Changes in regulation of gene expression are of great interest and appear consistent with the hypothesis that EMF effects at the cell membrane may have consequences for the regulation of protein synthesis in cells. We give specific examples of enzymes that are produced at greater rates as a consequence of EMF exposure, as well as enzymes that are either produced at a reduced rate or de-activated by field exposure.

Biological effects consistent with the hypothesis that calcium ion transport is altered at the site of the cell membrane by EMF exposure are discussed. Calcium ion transport changes may be a direct consequence of the magnetic fields or may be the result of changes in receptor and second messenger control of ion channels.

As an example of a well-documented beneficial biological effect of EMF exposure, we consider an extensive body of clinical data that demonstrates magnetic field effects on the biological process of bone growth as discussed in the previous chapter. These data also form a framework for understanding some of the field characteristics that are important in determining biological effect.

5.2 SENSING OF EMF IN NATURE

Sensing and utilization of magnetic and electric fields for navigation or prey detection are widespread in nature (Fessard 1974; Tenforde, 1989, 1991). Sensing of weak electric fields generated by normal muscle activity is a demonstrated means by which some sharks detect

prey, for example. Electric field detection has been observed only in aqueous environments. In the elasmobranchs, such as skates, sharks, and rays, electric field sense organs (ampullae of Lorenzini) have been identified and characterized in terms of their sensitivity to electric fields (Kalmijn, 1992).

Where electric sensing is found in freshwater fish, it has been demonstrated that the fish generate the field and use phase information to sense the presence of objects near them in the water. It has long been recognized that a number of avian (Wiltchko and Wiltchko, 1991) and marine species (including sea turtles) use earth's geomagnetic field for navigational purposes. There is evidence that certain terrestrial vertebrates including the rats have a magnetic sense (Olcese et al., 1988a, b). In the mole rat, this sense may be a primary means of navigation and homing.

In the case of magnetic fields, there appear to be two classes of sensing strategies. The first to evolve proceeded from incorporation of magnetite crystals into cellular structures. These crystals are ferromagnetic and tend to align with their long axis parallel to the resultant environmental magnetic field vector. Formed by cellular mechanisms from ferrihydrate into elongated chains, magnetite assemblages give rise to torques within cells as they align with the geomagnetic field (Tenforde, 1989). Magnetotactic bacterium and other magnetite-utilizing non-vertebrates have been studied in some detail, and magnetite biomineralization has been reported in human brain tissue (Kirschvink and Kobayashi-Kirschvink, 1992).

Among the vertebrates, sea turtles as well as some migratory birds are among the species that rely, at least in part, on the geomagnetic field for navigation. There is some evidence that other magnetic field sensing species, including several salmonids, synthesize elongated magnetite structures and use these in the detection of magnetic fields. Concentrations of these structures are found in areas of the head where nerve fibers that are sensitive to magnetic field stimulation originate.

A second type of magnetic field sensing has been attributed to nervous system structures not relying on magnetite. Many in the physics community dispute the idea that nervous tissue is capable of detecting earth-strength magnetic fields. Nonetheless, as will be discussed further, this hypothesis has been the basis for many successful experiments in animals. For example, Semm et al. (1980), Olcese (1990), and others have studied magnetic field detection in the rat. As discussed later, an important consequence of magnetic field detection in rodents can be the alteration of melatonin synthesis or release.

5.3 THERAPEUTICALLY RELATED STUDIES ON EMF FIELD EFFECTS

5.3.1 Non-Union Bone Fracture Repair

In the orthopedic field, it has been demonstrated that EMF accelerate and/or promote healing in both delayed and non-union bone fractures. The development of electromagnetic methods of treatment was based on the discovery of the electrical properties of bone tissue. The first

report of the piezoelectric properties of bone originated from Yasuda in Japan (1954) who measured an electric potential upon deformation of dry bone. Several groups subsequently reported the generation of electrical potentials in wet bone upon mechanical deformation (Bassett and Becker, 1962; Shamos et al., 1963; Friedenberg). These studies resulted in the hypothesis that strain-generated electric potentials may be a signal for regulation of cellular processes in bone (Bassett, 1968).

This experimental work led to the development of therapeutic devices which employed signals related to those measured in the strain-generated potential experiments. The first applications of these devices was in the treatment of bone fracture non-union (Bassett et al., 1977) and has been subsequently expanded to include fresh fractures as well. Devices are currently under basic and clinical investigation for the treatment of avascular necrosis (Aaron et al., 1989b; Steinberg et al., 1990) as well as osteoporosis (Tabrah et al., 1990).

Recalcitrant fracture repair (delayed and non-union of bone) has had the longest history in EMF clinical application. Both surgically invasive and non-invasive technologies have been developed. The first studies employed direct current stimulation. These devices use electrodes either surgically implanted directly adjacent to the fracture site (Patterson, 1984), or use one internal/one external electrode combination. Brighton (1981) reported the largest series of patients treated with direct current stimulation. Major problems encountered with dc stimulation are those associated with surgical intervention: infection, inflammation, and initial mobility impairment. The major advantage of this system is the minimal patient compliance requirement. However, the mechanism of dc stimulation may be distinctly different from that of the non-invasive technology due to associated electrolysis effects (Black, 1987) such as modification of oxygen tension (Baranowski et al., 1983; Black et al., 1984) and possible direct realignment and electrophoresis of cells and matrix components (Cooper, 1984; Onuma and Hui, 1988).

Dosimetry using the dc current electrode approach depends not only upon current density in the vicinity of the electrode, but also upon the faradaic electrochemical processes that change the chemical environment in the treatment site (Pilla, 1974a; Black, 1987). The biological response to dc currents from implanted electrodes is localized to the electrode vicinity and is always accompanied by some degree of tissue inflammation or even necrosis. This approach has been largely outdated by non-invasive techniques which are significantly more useful and effective for clinical applications.

Non-invasive devices are based on two different methods of electric current induction. The most widely employed system is that of electromagnetic induction using external coils (Bassett et al., 1977). This technology provides a pulsed asymmetric electric signal of low frequency and low energy (nonthermal) with current values of $\approx 5-50\mu\text{A}/\text{cm}^2$. More than 100,000 patients have been treated worldwide with application to all areas of fracture management. The first large series of patients exhibited a success rate of 80% in bone non-unions (Bassett et al., 1981) and has been followed recently by randomized, double blind clinical trials which confirm this success rate (Sharrard, 1990). In the past decade, over 30 clinical trials in the literature document the efficacy of PEMF as an alternative to invasive

surgical intervention (Bassett, 1989). As with surgical treatment, the success rate of EMF is determined by the location and severity of the fracture. For delayed unions of the tibia, success rate is essentially identical to that reported for the first bone graft (Brighton, 1991).

Based on this documented success over the past 20 years, new clinical applications for EMF include: avascular necrosis, osteoporosis, spinal fusion, and tendinitis. Double-blind clinical trials have also demonstrated therapeutic efficacy of EMF for treatment of spinal fusions (Mooney, 1990), tendinitis (Binder et al., 1984), femoral osteotomies (Borsalino et al., 1988), and venous ulcers (Iran et al., 1990).

Capacitively coupled devices have been developed more recently, and their clinical application is limited at present to non-union treatment (Brighton and Pollack, 1985). This device employs a low-energy 60 kHz sinusoidal signal, and the current induced in the tissue is on the same level as that of the inductively coupled device, on the order of $\approx 10\mu\text{A}/\text{cm}^2$. Clinical trials are currently under way in the treatment of avascular necrosis (Steinberg et al., 1990) and osteoporosis (Brighton, 1991).

5.3.2 Cellular Studies

Cellular studies on skeletal systems illustrate effects concordant with those described above for therapeutic applications. Numerous investigators have observed stimulation of collagen synthesis in fibroblasts. The results include observations of a frequency dependence of the induced electric field (Farndale and Murray, 1986; McLeod et al., 1987). Additional studies have demonstrated modulation of lysosomal enzyme activity, associated with an alteration of catabolic activity in response to electric fields (Murray et al., 1988). Chondrocytes exposed to electric fields exhibited increased proteoglycan biosynthesis and sensitivity to proteolytic digestion (Sah et al., 1989). These results are consistent with an earlier onset of matrix biosynthesis reported *in vivo*. The above *in vitro* results are additionally supported by many other studies linking electric field exposure to a stimulation of cellular events relevant to the repair processes observed both *in vivo* and clinically (see Table 5-1).

However, the response of cells to EMF is not limited to skeletally related tissues. A model system used by many investigators is human peripheral blood lymphocytes, with the major effect reported on mitogen (phytohemagglutinin, PHA; concanavalin A, ConA) stimulation of blastogenesis (Cadossi et al., 1985). Conti et al. (1983) reported inhibition of PHA-induced mitogenesis over the range of 1-200 Hz. ConA-induced mitogenesis was also inhibited, but only at 3 and 50 Hz. These authors explained the different results with the two mitogens as indicating that different lymphocyte subclasses would be sensitive to different EMF frequencies, in agreement with the original proposal (Pilla, 1974; Chiabrera et al., 1988) that calcium-mediated signal transduction would be the underlying mechanism.

Table 5-1. Cellular Effects of EMF

TARGET	EMF EFFECT	LITERATURE
Osteoblasts	IGF II Synthesis Increase	Fitzsimmons, 1989
Osteoblasts	Actin Polymer Changes	Korenstein, 1984
Osteoblasts	cAMP/DNA Synth. Increase	Korenstein, 1984
Osteoblasts	PTH Response Inhibition	Cain, 1987
Osteoblasts	PTH Response Inhibition	Luben, 1982
Osteoblasts	DNA Synthesis Increase	Ozawa, 1989
Chondroblast	Calcium Incorp. Increase	Norton, 1988
Chondrocytes	Cell Proliferation Increase	Brighton, 1989
Chondrocytes	DNA Synthesis Increase	Rodan, 1978
Chondrocytes	PTH Response Increase	Hiraki, 1987
Fibroblasts	Collagen Synth. Increase	Farndale, 1985
Fibroblasts	Collagen Synth. Effect	McLeod, 1987
Fibroblasts	Collagen Synth. Increase	Murray, 1985
Fibroblasts	PGE2 Response Hidden	Farndale, 1986
Human Fibroblasts	DNA Synthesis Increase	Liboff, 1984
Human Fibroblasts	Differentiation Increase	Rodemann, 1989
Synovial Fibroblasts	Lysosomal Enzyme Decrease	Murray, 1988
Endothelial Cells	Stimulation of Angiogenesis	Yen-Patton, 1988
PC12 Cells	Noradrenaline Release Increase	Dixey, 1982
U937 Cells	Surface Charge Alteration	Smith, 1991
CHO V79 Cells	DNA Synthesis Increase	Takahashi, 1987
HL 60 Cells	Myc/H2b RNA Increase	Goodman, 1990
Colon Carcinoma	Transferring Receptor Increase	Phillips, 1986a
Colon Carcinoma	Colony Formation Increase	Phillips, 1986
Teratocarcinoma	Differentiation Inhib.	Akamine, 1985
Human Lymphoma	ODC Increase	Byus, 1987
Human Lymphoma	Inhib. of Mitogen Stim.	Conti, 1983
Human Lymphoma	IL-2 Receptor Increase	Cossarizza, 1989
Human Lymphoma	Mitogen Stim. Increase	Cossarizza, 1989

Table 5-1. Cellular Effects of EMF (cont'd)

TARGET	EMF EFFECT	LITERATURE
Melanoma	Tyrosnase Increase	Jones, 1986
Melanoma	Protein Kinase Effects	Ryaby, 1988
Physarum	Surface Charge Increase	Marron, 1988
Salivary Glands	Protein Synthesis Change	Goodman, 1988
Salivary Glands	mRNA Synth. Increase	Goodman, 1983
Sensory Ganglia	Neurite Outgrowth Increase	Sisken, 1984
Skin	Protein Synth. Increase	De Loeker, 1989
Tendon	DNA Synthesis Increase	Cleary, 1988
Tibia	cAMP Metabolism Changes	Jones, 1984
Xenopus	Nerve Elongation Increase	McCaig, 1990

Experiments to confirm the role of calcium in EMF effects have been reported by Cadossi et al. (1989a, 1989b), Conti et al. (1985), and Liboff et al. (1987). These investigators used calcium channel blockers which modulated EMF sensitivity, confirming the role of calcium and indicating a potential membrane target site. Data correlating calcium-dependent processes with EMF sensitivity in other systems support these results: EMF stimulated calcium efflux and insulin release from isolated rabbit pancreatic islet cells was reported by Jolley et al. (1983); calcium efflux and insulin receptor is increased in fibroblasts (Bourguignon, 1989), and cytosolic free Ca^{2+} is increased after exposure to EMF in HL60 cells (Carson et al., 1990).

Induction of specific mRNA synthesis after PEMF exposure in both *Drosophila* and *Sciara* salivary glands (Goodman and Henderson, 1988, 1990) has been reported, as well as induction of oncogene expression in HL60 cells (Wei et al., 1990). Effects on induction of p53 and histone H3 mRNA have been reported by Cadossi et al. (1989b) in spleen tissue. B cell growth factor synthesis (Cadossi et al., 1989a) and induction of angiogenesis in endothelial cells are stimulated by exposure to EMF (Yen-Patton et al., 1988). EMF has been shown to modulate neurotransmitter release in PC12 cells (Dixey and Rein, 1982), and increase transferrin receptor number in colon carcinoma cells (Phillips et al., 1986a). This wide range of results conclusively demonstrates that EMF can affect cellular processes.

5.3.3 In-Vivo Studies

In vivo animal models have been successfully employed to assess the effects of EMF and provide information regarding both time and amplitude dosimetry allowing for maximal therapeutic effectiveness (Carter et al., 1989; Chakkalakal et al., 1990). Models were

designed to mimic clinical situations and provide information on biomechanical indices of bone repair. Furthermore, they address the cellular process(es) which are sensitive to the physical stimuli. In the normal bone fracture repair sequence, inflammation, cellular migration, differentiation of mesenchymal cell precursors, and proliferation of bone forming cells and subsequent mineralization of extracellular matrix are required for complete resolution of the fracture (McKibbin, 1978). Evidence for the effectiveness of electric fields in stimulating cellular differentiation has been supplied by a bone induction model system which mimics the normal bone formation process (Reddi, 1987). Electric fields can promote early mesenchymal cell differentiation to fibroblasts and chondrocytes active in the matrix biosynthetic phase of endochondral ossification (Aaron et al., 1989a). Using a cartilage growth plate in vivo system, other investigators have demonstrated proliferative effects of applied electric fields on chondrocytes (Iannacone et al., 1988).

These studies are complemented by earlier work which used EMF to stimulate proteoglycan synthesis in articular cartilage (Smith and Nagel, 1983). The effect on mesenchymal cell differentiation was applied to ingrowth into porous ceramic biomaterials, where it was reported that EMF stimulated bony ingrowth and mineralization (Shimizu et al., 1988). Finally, using mechanical evaluation as an indicator of strength and mineralization, it has recently been demonstrated that electrical stimulation can enhance the rate of fracture healing (Pilla et al., 1992).

Osteoporosis models have been employed to assess the therapeutic potential of applied electric fields in prevention or reversal of progressive bone loss. Bassett et al. (1979) reported on the usefulness of EMF in the prevention of osteoporosis (osteopenia). Brighton et al. (1985) illustrated the ability of capacitively coupled electric fields to inhibit bone loss in two osteoporosis models (denervation and castration). Rubin et al. (1989) and Skerry et al. (1991) reported on EMF use to prevent disuse bone loss in the functionally isolated turkey ulnae and dog fibula respectively. These studies appear to demonstrate the ability of induced electric fields to replace the normal mechanical input mechanism which regulates bone homeostasis.

Mechanical loading regulates bone homeostasis through the formation of stress generated or streaming potentials. These electrokinetic potentials, which exist both in bone and cartilage, are due to compressive fluid flow in a confined space or volume (Pollack, 1984; Grodzinsky, 1983). Loading also causes strain in the tissue and can be measured with gauges which measure uniaxial deformation (Rubin and Lanyon, 1984). Rubin and Lanyon (1987) developed the functionally isolated turkey ulna model to address the issue of strain magnitude and dosimetry of applied load. Based on the synthesis of results from these related studies, McLeod et al. (1990) have calculated the induced electric field levels due to mechanical loading and found them to be in the $\mu\text{V}/\text{cm}$ range, which is 2-3 orders of magnitude lower than that used in inductive and capacitive devices. Sinusoidal signals in this amplitude and frequency range (< 75 Hz) demonstrate cellular effects similar to those reported in Section 5.3.2 and require significantly less power, because of better tuning to the endogenous cellular response (McLeod and Rubin, 1990; McLeod et al., 1991).

In other clinical areas, electrical stimulation has been reported to promote the healing of soft tissue wounds in rats, rabbits, and pigs (Glassman et al., 1986; Dunn et al., 1988), stimulate the healing of tendons in rats (Nessler and Mass, 1987), and decrease cardiac tissue damage after experimental myocardial infarction in dogs (Albertini et al., 1991). EMF has been reported to stimulate peripheral nerve regeneration in both rat and cat models (Orgel et al., 1984; Siskin et al., 1989; Zienowicz et al., 1991). Direct current has also been applied successfully in both peripheral and central nervous regeneration (Borgens et al., 1987; Politis et al., 1988). These studies emphasize that basic cellular biochemical control processes are affected by applied electric fields, providing a basis for future clinical indications.

5.4 EMF EFFECTS ON BIOLOGICAL SYSTEMS: TOXICOLOGY AND MECHANISMS-ORIENTED STUDIES

5.4.1 In-Vitro Studies

Early research at the cellular level focused on events related to membrane-mediated signal transduction, especially those involving the Ca^{++} ion. Early interest in calcium was prompted by reports of altered calcium ion efflux from tissues (Bawin and Adey). In a series of reports, Blackman and colleagues (1985a, 1985b) have provided evidence that tissue can respond to ELF components of amplitude modulated RF signals and that the static magnetic fields (e.g., the geomagnetic field) may play a role in the alteration in calcium ion mobility.

The calcium ion work, although sometimes controversial, has nonetheless provided hypotheses on which many successful in-vitro and in-vivo experiments have been performed. While the precise role, or indeed the requirement, for the dc (or geomagnetic) field in these effects remains unclear, there is a great deal of evidence from various laboratories that is consistent with the view that relatively weak time-varying magnetic fields can affect the movement of calcium and certain other ions in biological tissue.

Carson and colleagues (Carson et al., 1990) used a fluorescent indicator to monitor possible changes intracellular calcium from exposure to magnetic fields, and observed a significant increase following exposure. In rat lymphocytes exposed to a combination of a static magnetic field ($23 \mu T$) and a 16 Hz sine wave field ($42 \mu T$), the influx of calcium in response to mitogen stimulation was inhibited relative to control cells. Exposure of the cells to either field alone resulted in no effect (Liburdy and Yost, 1992). On the other hand, exposure of rat lymphocytes to a 60 Hz magnetic field at 22 mT caused an increase in calcium uptake following stimulation with a mitogen (Liburdy et al, 1992). This increase in calcium uptake appeared directly proportional to the induced electric field (Liburdy, 1992). The importance of the electric field component was verified by demonstrating analogous effects on calcium uptake in response to directly injected currents.

These results support the view that alterations in intracellular calcium levels can occur as a result of exposure to time-varying magnetic fields in the ELF range, and that such response is due to the induced electric field and may be frequency specific. Overall, these data are

consistent with the view that magnetic fields can affect calcium channels or other cell surface receptors where binding is modulated or controlled by such channels.

These and other observations have led several investigators to hypothesize that changes in intracellular calcium during exposure to time varying magnetic fields may be responsible for certain of the neurological effects observed in second messenger signalling that are observed in-vitro as a consequence of EMF exposure. Alterations in both calcium and magnesium ion mobility as a consequence of magnetic field exposure have also been the hypothesis for series of successful behavioral experiments in the radial arm maze by Lovely et al. (1990) as discussed below.

Other observations indicate that the receptor-adenylate cyclase second messenger system may be a site of interaction of EMF. Early work by Rodan (1978) demonstrated that EMF could stimulate cAMP formation in cartilage and correlated this with effects on alkaline phosphatase activity. It was reported that pulsed EMF could inhibit the hormonally stimulated adenylate cyclase in osteoblast-like cells (Luben et al., 1982). Responses of the bone cell line MMB-1 to parathyroid hormone (PTH) in vitro were inhibited by a 72 Hz single pulse signal as well as a 15 Hz pulse train. The fields reduced the cellular production of cAMP in response to PTH and blocked the inhibitory effects of the hormone on collagen synthesis. A similar inhibitory effect of PEMF on PTH responses were reported in bone cell cultures by Cain et al. (1987).

Other investigators have described suppression of cAMP levels in fibroblast cultures after long-term stimulation with EMF (Farndale and Murray, 1986). Changes in cAMP levels as a function of the electrical field strength induced capacitively have been correlated with a change in DNA synthesis (Korenstein et al., 1984). Cell type specific changes in cAMP levels with demonstrated recovery phenomenon after PEMF removal have been described (Jones, 1984). These investigators all consider the adenylate cyclase system as a potential mediator of functional response to electromagnetic field stimulation.

The protein kinase C transductive pathway, as well as calcium signaling pathways, have also been implicated in electric field interactions (Adey, 1988; Phillips et al., in press). Finally, the stimulation of autocrine growth factor production has been postulated as both messenger and regulator in electric field stimulation (Fitzsimmons et al., 1989). Therefore, it seems that many signal transductive pathways may be sensitive to induced electric field interaction.

Physical stimulation of cell function usually requires the generation of a transmembrane transductive signal to further trigger the appropriate cellular response. These signals may involve production of second messenger mediators and/or activation of regulatory protein kinases. Ionic dependent processes are a major component of these transductive pathways. For example, cell proliferation is initiated by binding of growth factors to specific receptors on the cell surface. This binding requires specifications, both for proper receptor structure and for receptor-ligand interaction. The initiation and maintenance of the cell proliferative response also requires the activation of adenylate cyclase which leads to changes in cAMP levels. This second messenger has also been linked to calcium ion and ionic regulation. The second level of regulation in the transductive pathway involves activation of protein kinases.

These enzymes are responsible for phosphorylation of specific amino acids which control the functional state of a protein.

As stated elsewhere in this review, there is no evidence that EMF can directly damage DNA. These fields do not act as mutagens or initiators of the carcinogenic process. Theoretically, it is not possible for ELF EMF to effect chemical changes in DNA directly, and a number of authors have reported experimental data consistent with this view. Negative studies in this regard include those of Reese et al. (1988) who compared DNA single strand breaks in exposed and control Chinese hamster ovary cells, Cohen et al. (1986) who determined that there were no changes in chromosomal structures in exposed lymphocytes, and Frazier et al. (1990) who showed no differences in the ability of exposed and control cells to repair DNA damage caused by ionizing radiation.

There are epigenetic processes that can affect the development of neoplasms through events occurring at cell membranes (Trosko and Chang, 1987; Yamasaki, 1987, 1991). It has been hypothesized, for example, that EMF may serve to enhance the influence of chemical tumor promoters (Adey, 1990). Such actions would be manifest in cellular systems by such endpoints as increased proliferation and enhanced colony-forming ability. Phillips et al. (1986) showed that human colon cancer cell lines exhibited increased colony formation when exposed to EMF, and mitogen-induced proliferation of lymphocytes was enhanced by exposure to pulsed electromagnetic field (PEMF) (Cossarizza et al., 1989a, b). Consistent with these data are reports of alterations in DNA synthesis as a consequence of EMF exposure (Rosenthal and Obe, 1989). These kinds of effects have been observed both with pulsed (e.g., Takahashi, et al., 1986) and sinusoidal magnetic fields (Liboff et al., 1984; Goodman and Henderson, 1986).

Central to the question of cancer is whether EMF exposure affects the expression of oncogenes (or proto-oncogenes) by altering the normal regulatory mechanisms for transcription of the DNA code within the cell. Transcription refers to the reading of the DNA code to form ribo nucleic acid (RNAs) that will later be used in translation to direct the syntheses of specific proteins coded for in the original genomic DNA (Figure 5-1).

Changes in cellular RNA and in mRNA concentrations as a consequence of EMF exposure have been reported by Goodman and colleagues (1983, 1989, 1991) and others. Attempts by Goodman and Henderson (1986, 1987) to use increased RNA levels as a means to determine what characteristics of the imposed magnetic fields constituted dose in this biological response were inconclusive. However, without determining the specific spectral characteristics responsible, Greene et al. (1991) were able to demonstrate that the induced electric field is required for incorporation of radiolabel in the presence of magnetic fields in the HL-60 cell line which they studied. When observed, EMF-induced increases in RNA levels are generally in the 1.5- to 3.5-fold range (e.g., Phillips and McChesney, 1991).

Goodman and Henderson (1987) reported increases in specific genes including histone H2B, c-myc, and b-actin as a result of EMF exposure. Czernska et al. (in press) have shown increased expression of c-myc in the Daudi lymphocytic cell line. They showed that this response varied with the field amplitude and time of exposure. The pattern of gene expression in response to EMF exposure varies among cell lines as would be anticipated for

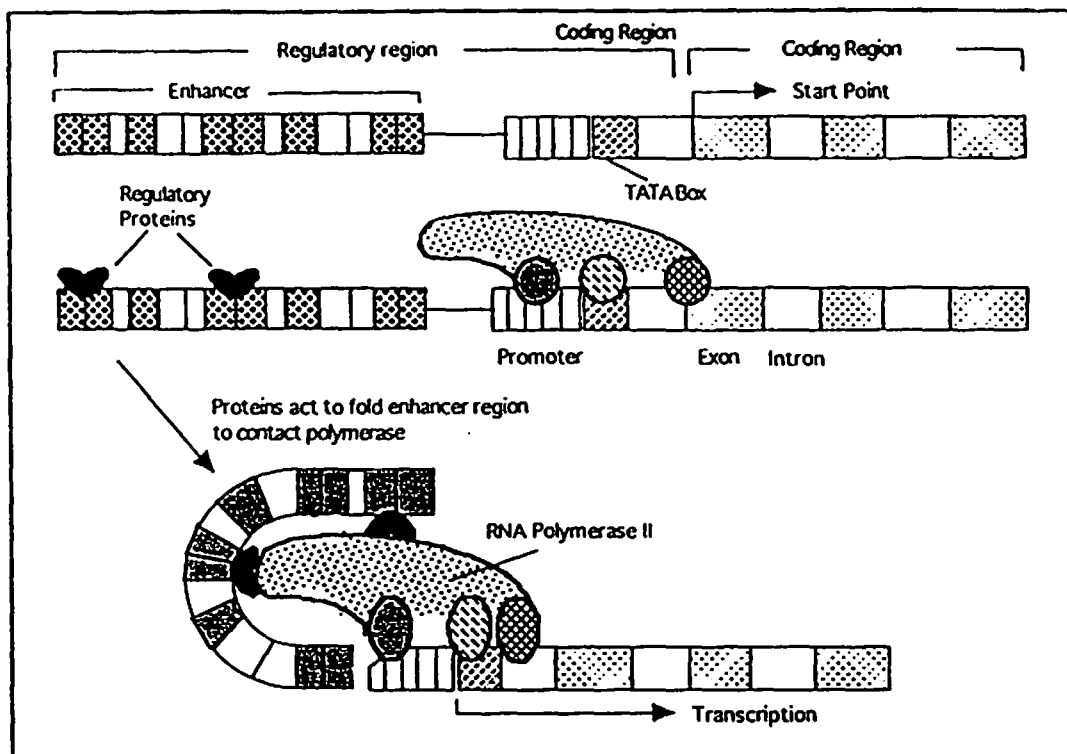

Figure 5-1. Schematic of the interaction between regulatory and coding regions and the action of regulatory proteins and RNA polymerase in the transcription process. The coding region is transcribed by RNA polymerase II into a messenger RNA that is, in turn, translated into specific proteins. (Adapted from Kandel et al., 1991)

a non-artifactual effect. Phillips et al. (in press) have shown with a human cell line (C EM-CM3 T-lymphoblast) that 60 Hz magnetic fields at 100 μ T cause an increase in expression of three proto-oncogenes: c-fos, c-jun, and c-myc. These authors showed that in this instance, the increase in the various RNAs involved was due to accelerated synthesis rates and not instability or degradation.

In-vitro studies on effects of EMF exposure have provided data consistent with the hypothesis that the cell membrane is an important site of action for the fields, and that the electric field component is important in determining these effects. Studies showing alterations in calcium ion uptake by cells are consistent with the observed changes in cellular regulation of RNA and protein synthesis since calcium is an important second messenger in most of these processes. Alterations in synthesis or activity of enzymes such as ornithine decarboxylase (ODC) (Byus et al., 1987) and serotonin, N-acetyl transferase (SNAT) (Wilson et al., 1981) are consistent with these findings.

Of particular interest with regard to breast cancer are the findings of Liburdy et al. (1992), who showed that exposure to weak 60 Hz magnetic fields blocked the cytostatic action of melatonin on MCF-7 breast cancer cells in culture. This effect showed a threshold that was between approximately 2.5 and 12 mG. The authors suggested that melatonin may exert its cytostatic action on the MCF-7 cells by occupying receptors on the cell surface, and that these receptors were altered by EMF exposure such that the normal response to melatonin was blocked.

Figure 5-2 illustrates processes by which both short-term and longer-term effects can result from second messenger signaling subsequent to events at the cell membrane. Short-term responses by the cell in this illustration involve the protein kinase mediated phosphorylation of the ion channel which, in turn, affects ion conductance. Longer-term effects arise from phosphorylation of nuclear regulatory proteins that control the synthesis of both receptor and, as illustrated here, ion channel proteins. Changes in ion channel or receptor population, or structure, can have long-lasting effects on cell function.

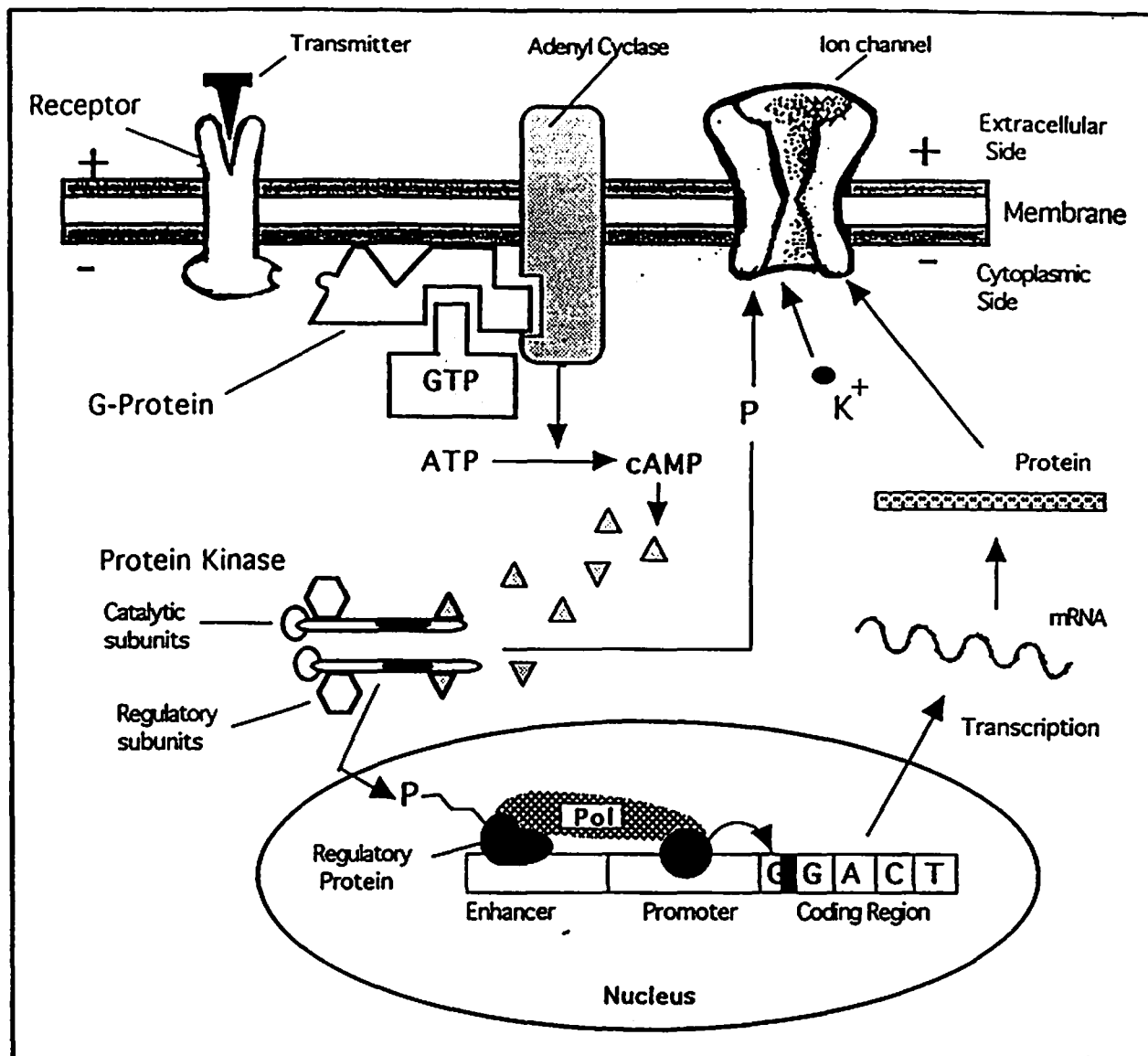

Figure 5-2. Possible short and longer term consequences of neurotransmitter binding are depicted. Short term effect arises from the phosphorylation of the ion channel directly by protein kinase. Longer term effects are dependent on phosphorylation of regulatory proteins that control synthesis of receptor or channel proteins. In other systems, not depicted, channel function may be controlled directly by the action of G-protein, as a result of neurotransmitter binding. (Adapted from Kandel et al., 1991)

5.4.2 In-Vitro Studies Using Simulated Maglev Magnetic Field Exposure

Several human cell lines were exposed to various magnetic fields including a simulated field having components from 0 Hz to 1620 Hz, in experiments reported by Groh (1993). These studies evaluated a total of 22 different combinations of exposure conditions and cell types. Magnetic field exposure conditions included the simulated maglev signal (1x to 7x TR-07 amplitude). Maglev exposure fields were oriented either in opposed or parallel direction to the ambient geomagnetic field. Either continuous or intermittent exposures to these fields were carried out for six days (through the exponential and into the stationary phase of culture growth).

Melanin-producing cells (SK-MEL-131 melanoma) were scored for melanin production. SH-SHY neuroblastoma cells were scored for cell differentiation in the presence or absence of mycophenolic acid (MPA) or phorbol 12-myristate 13-acetate (PMA) with and without magnetic field exposure. HL-60 and CEM cells were scored for reactivity to specific antibodies and surface antigens.

Exponential growth of the CEM cell cultures treated with PMA was inhibited but there was no effect of magnetic field exposure. Likewise, no changes were detected as a result of magnetic field exposure in the SK-MEL-131, HL-60, or SH-SY5Y cell lines as compared to controls.

5.4.3 In-Vivo Studies

Many of the biological effects observed in animals with whole body exposure to ELF EMF appear to be mediated, either directly or indirectly, by the nervous system. Overall, findings of neurological effect from various EMF exposures have been mainly confined to a few endpoints and to certain types of exposure. For certain endpoints, including pineal gland function (Wilson et al., 1981; Welker et al., 1983; Lerchl et al., 1990, 1991), short-term memory (Lovely et al., 1990; Thomas et al., 1986), heart rate (Graham et al., 1991), and circadian rhythm alterations (Vasquez et al., 1988), experimental evidence for effects has been fairly consistent. Neurological, neuroendocrine, and behavioral effects of EMF have been recently reviewed by Anderson (1991) and include reported effects in rodents (Wilson et al., 1981; Lerchl et al., 1990), non-human primates (Seegal et al., 1989; Rogers et al., 1991), and humans (Wilson et al., 1990; Graham et al., 1991; Anninos et al., 1991; Bell et al., 1991).

In many of the experiments that showed effects (including Graham et al., 1991; Wilson et al., 1990; Rogers et al., 1991; Lerchl et al., 1991), the EMF treatment was intermittent or involved repetitive discrete or pulsed exposures. This is in contrast to many chronic exposure regimens for sinusoidal or static field exposure in laboratory studies, which are customarily for 12-20 hours per day, with sinusoidal fields actuated at zero crossing, or used with tuned exposure systems, so as not to induce transients, spikes, or higher frequency components into the exposure fields.

Among findings in laboratory experiments, recent studies showing a co-promotional effect of exposure to sinusoidal EMF are of particular interest with regard to the issue of possible increased cancer risk from these fields. These initiation promotion and initiation promotion/co-promotion studies are discussed in greater detail in Section 5.4.5.

5.4.4 Effects on Neuroendocrine Function

Of particular interest with regard to neuroendocrine effects of EMF is evidence from several laboratory experiments that pineal circadian rhythms in serotonin, melatonin, and other tryptophan metabolites are substantially altered in rats exposed to ELF EMF during the hours of darkness (e.g., Wilson et al., 1981; Lerchl et al., 1990). The most consistent finding in these studies is that of suppressed melatonin synthesis in rats. Pineal secretory products are believed to impel a number of circadian as well as seasonal rhythms (Arendt, 1988).

Reported biological changes resulting from melatonin suppression are multifaceted and include alterations in immune system function (Maestroni et al., 1986), as well as increased production of gonadal steroids and prolactin (Bartsch et al., 1988). These primary consequences can, in turn, lead to reproductive changes in seasonal breeders (Reiter, 1981), and to increased cancer rates in animals that have been treated with chemical carcinogens or inoculated with cancer cells (Buswell, 1975; Blask, 1984). Noteworthy in regard to these animal studies, several papers in the literature suggest links between reduced melatonin levels and neoplastic disease in humans. These include breast cancer (Cohen et al., 1978; Tamarkin et al., 1982) and prostate cancer (Bartsch et al., 1988).

Wilson and co-workers (1981) showed that the biosynthetic activity of the pineal gland is influenced by 60 Hz electric fields (E-fields). The biochemical activity of the pineal gland was specifically chosen as an endpoint in these studies because of the reported effects of ELF field exposure on biological rhythms, particularly in humans (Wever, 1973).

Biochemical parameters measured by Wilson and colleagues (1981) included the most thoroughly studied hormonal output of the pineal gland, i.e., melatonin, as well as the expression of the enzyme (serotonin N-acetyltransferase or NAT) which controls its synthesis (Figure 5-3). Furthermore, they measured the pineal content of another potential pineal hormone, 5-methoxytryptophol (5Mtol).

The quantity of melatonin in the pineal, in addition to the activity of the enzyme NAT, is closely correlated with the light:dark (LD) environment to which animals and humans are exposed. During the day, melatonin synthesis is suppressed due to the presence of environmental light. During the night, the suprachiasmatic nuclei (SCN) signals the pineal gland and melatonin production increases (Reiter, 1991a, b). In virtually all species, nighttime is associated with a rise in the content of melatonin in the pineal and, because the hormone is quickly released from the gland, blood levels of the hormone rise at night. Whereas melatonin levels are always higher at night than during the day, the nocturnal pattern of melatonin production does vary slightly among species (Reiter, 1987). High nighttime production of melatonin is rapidly inhibited by the exposure of animals to light at

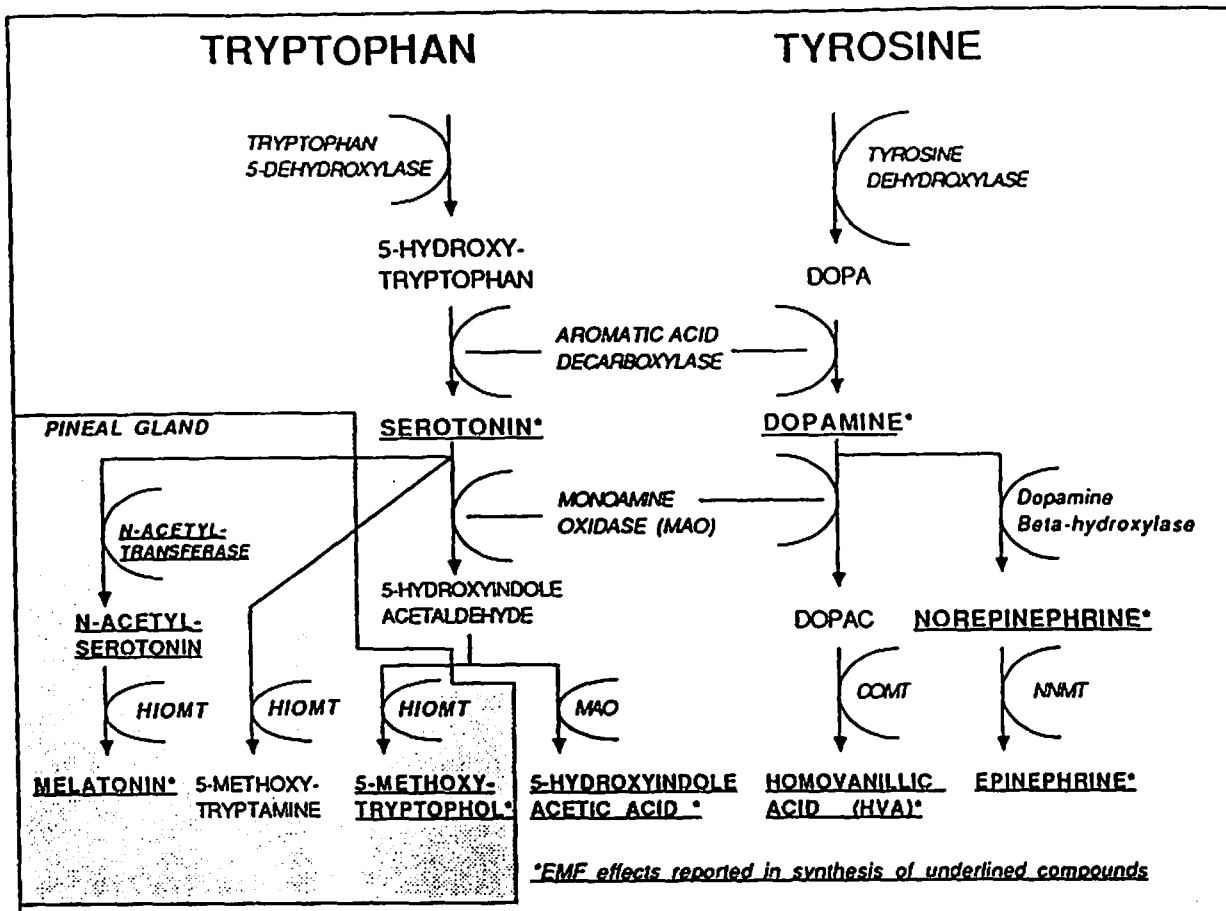

Figure 5-3. Metabolic pathways for synthesis of neurotransmitters and metabolites from tyrosine and tryptophan. Effects of EMF have been reported on those compounds or enzymes that are underlined. Metabolic pathways found in the pineal gland are shown in shaded area.

night, and the nocturnal increase is readily suppressed by the extension of light into the normal dark period (Reiter, 1985).

Initial papers of Wilson et al. (1981) provided a foundation for much of the current work on possible health effects of EMF exposure. They examined the ability of E-fields to influence the nocturnal production of melatonin. Following a period of acclimation, groups of randomly assigned rats were either exposed or not exposed (controls) to E-fields. The exposed animals were placed in a facility that provided a uniform, vertical 60 Hz E-field. (For details on the exposure system, see reports by Jaffe et al., 1979, and Hilton and Phillips, 1980.) During exposure, the rats were subjected to an unperturbed field strength of 65 kV/m for 20 hours per day for 30 days.

Because of mutual shielding of animals in adjacent cages, the unperturbed field strength was estimated to be reduced by 35% (Kaune, 1981); therefore, the "effective" field strength was calculated as 39 kV/m. The control rats were placed in a similar facility, but they were not exposed to the E-fields. After 30 days of exposure, pineal melatonin and 5Mtol levels were estimated using a gas chromatography/mass spectrometry (GC/MS) method previously developed by Wilson and colleagues (1977). Exposure of male rats to 60 Hz E-fields for 20 hours per day for 30 days led to a marked reduction in the nighttime levels of melatonin at

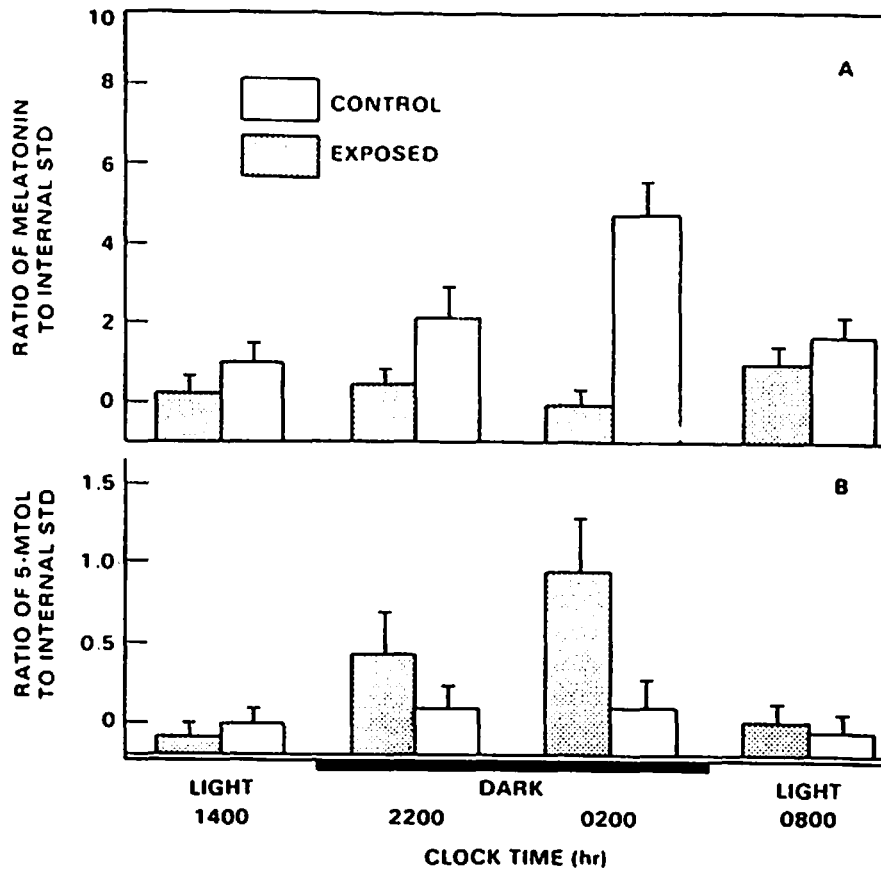

Figure 5-4. Ratios of melatonin (panel A) and 5MTOL (panel B) to internal standards in pineal glands of control rats and rats exposed to 60 Hz E-fields for 30 days. Lights were out daily from 2000 to 0600 H (represented by the black bar at the base of the figure). Vertical lines from the top of each bar represent SEM. Pineal glands were collected either during the day (0800 and 1400) or at night (2200 and 0200 h). $p < 0.05$ for control and exposed melatonin levels at 0200 h; no other differences in either melatonin or Mtol levels between exposed and control animals were documented. (From Wilson et al., 1981.)

0200 hours (6 hours after darkness onset) (Figure 5-4), while nocturnal 5Mtol levels were not significantly changed. No changes in daytime levels of melatonin or 5Mtol were noted.

Wilson et al. (1981) drew the following tentative conclusions. Exposure of rats to E-fields reduces the amplitude of the pineal melatonin rhythm by attenuating the nocturnal increase in melatonin synthesis; this change is probably due to a delay or a suppression of the nocturnal rise in the activity of pineal NAT, the rate-limiting enzyme in melatonin synthesis. The authors further surmised that E-field exposure may be operating like light to inhibit pineal metabolic activity. In an attempt to explain their results mechanistically, they cite work of others who have demonstrated changes in the electrical firing of neurons in the brain (Hjeresen et al., 1980) including one publication wherein the firing rate of neurons in the superior cervical ganglia, which innervate the pineal, decreased in animals exposed to 60 Hz E-fields (Jaffe et al., 1979). A reduction in the firing rate of these neurons would be expected to change pineal melatonin production as seen in these experiments. Although the reported field strength in this study was initially thought to be 65 kV/m, a short note

published two years later suggested it was in fact much lower; thus, the induced changes in pineal melatonin synthesis can apparently be produced by field strengths on the order of 2kV/m.

In 1986, the same group of investigators (Wilson et al., 1986) provided another confirmation of their original observation and extended the findings by showing that the changes induced by the E-field did not permanently damage the melatonin biosynthetic machinery of the pineal gland. In this case, rats were exposed to a uniform, vertical 39 kV/m ("effective" field strength), 60 Hz E-field. The results showed that a slow parallel decrease in nighttime pineal NAT and melatonin levels occurs as a consequence of 60 Hz E-field exposure with the difference between the control and exposed levels in both cases becoming statistically valid after 3 weeks (Figure 5-5). After 4 weeks exposure when the nighttime rise in melatonin was severely attenuated, the E-field was withdrawn. As early as 3 days after removal from the field (and continuing for at least 14 days), normal nighttime levels of pineal melatonin were re-established. The authors concluded that the metabolic competence of the pineal gland was obviously not permanently compromised by E-field exposure.

Wilson et al. (1986) also noted that whereas the mechanism of suppression of melatonin synthesis by E-field exposure remains unknown it may involve changes in the electrical activity in the postganglionic sympathetic neurons which innervate the gland. Based on earlier work by Welker, Semm, and others (Semm et al., 1980; Welker et al., 1983), Wilson and colleagues suggested that the eyes should be investigated as an organ for detecting the E-fields. If so, the E-field exposure could reduce pineal melatonin by mimicking the inhibitory effects of light on the pineal gland (Reiter, 1985).

In another study using sinusoidal E-fields, pregnant rats, beginning at the time of conception, were exposed to either 0 (controls), 10, 65, or 130 kV/m E-fields for 19 hours of every 24-hour period; following delivery of the pups, the exposure was continued until the young were 23 days of age, at which time pineal glands were collected (Reiter et al., 1988). These glands were analyzed for their melatonin content using a radioimmunoassay. Each of the E-field exposures, i.e., 10, 65, and 130 kV/m, significantly depressed ($p < 0.001$ in each case) peak nocturnal pineal melatonin levels when compared to those in the control rats (0 kV/m); however, no dose-response relationship was observed. Besides attenuating the melatonin peak, E-field exposure delayed the melatonin rise by about 1.4 hours in all groups of E-field exposed rats.

The inhibitory effect of E-field exposure on melatonin in adult rats has been calculated to have a threshold of 0.2 to 2 kV/m (Wilson and Anderson, 1990). These researchers also feel that there is no dose-response relationship to E-field exposure in either immature or adult rats. Above a certain threshold, the effect appears to be "all-or-none." Furthermore, these authors point out that a variety of factors may interfere with or modify the response of the pineal gland to E-field exposure; included in these are strain differences, male/female differences, and differences due to cutaneous pigmentation. Whether these are indeed mitigating factors remains unknown. Some of these may have come into play in a recent report where E-field exposure failed to depress the nocturnal increase in pineal melatonin in rats (Sasser et al., 1991).

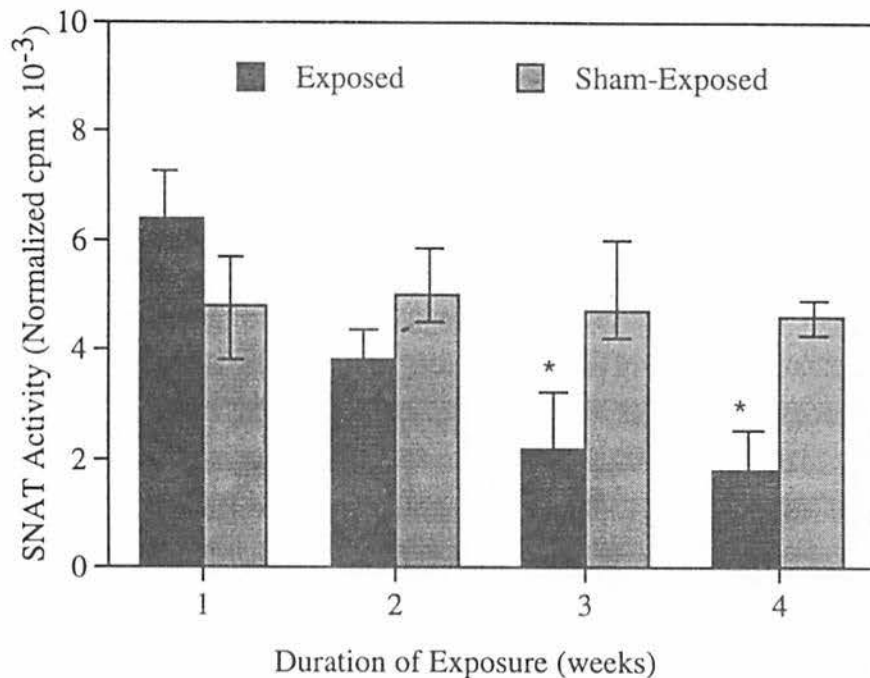
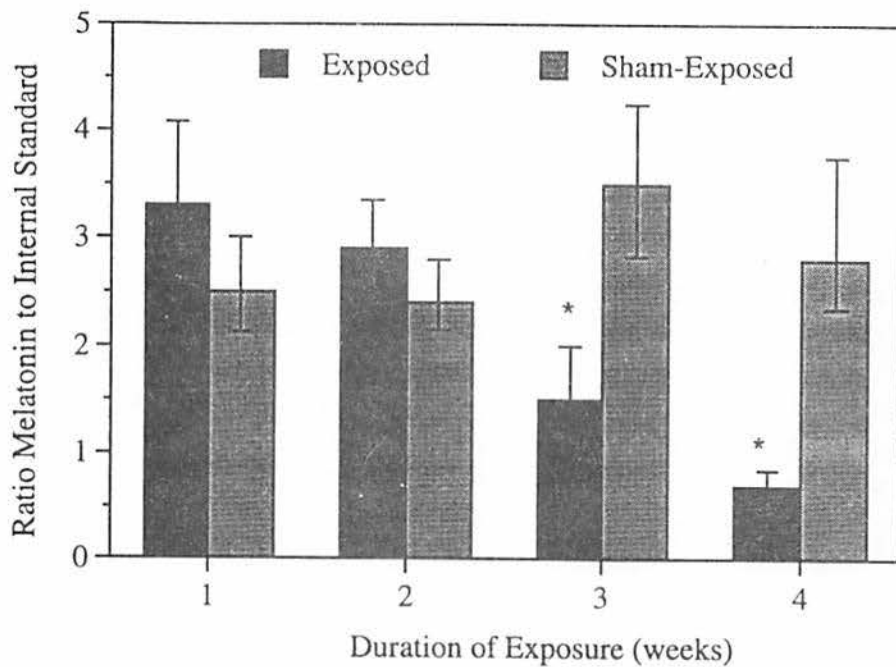

Figure 5-5. Pineal melatonin (top panel) and nat levels (bottom panel) in male rats exposed to a 60 Hz E-fields for 1, 2, 3 or 4 weeks. Sham-exposed control rats were treated identically except the E-field was never activated. Glands were collected at 0200 h, 6 hours after darkness onset. Within 3 weeks of field onset, both pineal NAT activity and melatonin levels were significantly depressed. Vertical lines from the top of the bars represent the SEM. * $p < 0.05$. (From Wilson et al., 1986).

Considering the numerous reports showing that pineal metabolism responds to perturbations of the static geomagnetic field (for reviews see Olcese et al., 1988a; Villa et al., 1991), Yellon (1991) examined the consequences of a 15-minute exposure (2 hours before lights out) to 60 Hz magnetic field (B-field) at a field strength of 1 G (horizontal component) on the subsequent rise in nighttime pineal and plasma melatonin in adult male and female Djungarian hamsters. This brief B-field exposure in the late light period led to a marked alteration in the nocturnal rise of melatonin in both the pineal gland and in the blood.

The nighttime increase in pineal melatonin production was delayed; in the blood, melatonin concentrations essentially remained at daytime levels throughout the night, while in the controls, the usual increase was seen. These findings were interpreted to mean that sinusoidal B-field exposure probably disrupts the timekeeping capabilities of the endogenous biological clock, presumably in the SCN, which is subsequently reflected in the observed alterations in the circadian melatonin rhythm. The findings show that daytime exposure to such fields may have significant consequences in terms of the subsequent night's melatonin rise.

Rogers et al. (1991) used a combined 60 Hz E- and B-field exposure to test whether ELF fields change the circadian production and secretion of melatonin in a non-human primate, the baboon (*Papio cynocephalus*). In an initial study, blood samples were collected from two baboons over a 24-hour period during a pre-exposure period and after 10 and 20 days of exposure to a combined E- and B-field. The exposure consisted of a combined intermittent, variably scheduled 30 kV/m E-field and a 1.0 G B-field with a rapid onset component. The 30 kV/m field is considered to be perceptible to baboons whereas the B-field is not (Orr and Rogers, 1985). The B-field was produced "instantaneously" by means of a relay switch; within 2 minutes, the E-field was applied "instantaneously" to 14 kV/m with a subsequent ramping of the field strength to 30 kV/m (1.5 kV/m/sec). For the first 10 days, exposure was during the daytime only, although by 20 days some exposure had occurred during both the day and night. At both 10 and 20 days after exposure onset, nocturnal serum melatonin levels were reduced to 15% of those during the pre-exposure period (Rogers et al., 1991).

In a second study using six baboons, the exposure parameters were changed such that there was daytime exposure only to 6 kV/m E-field and 0.5 G B-field. In this experiment, both the E- and B-fields were introduced over a 4-second period (rather than "instantaneously"). Following this exposure, the melatonin rhythm was not perturbed. Likewise, when the same animals were exposed to a combined 30 kV/m and 1.0 G field (daytime only), no measurable effects on serum melatonin levels were noted (Rogers et al., 1991); in this study, the fields were again ramped rather than being applied "instantaneously."

Since the exposure parameters were different between the initial study using two baboons and the second study using six baboons, their outcomes cannot be directly compared. If the suppression of circulating melatonin in the first study was a consequence of the ELF exposure, then it can be assumed that the changes in field parameters introduced in the subsequent experiments account for their inability to modify the circadian production of the pineal hormone.

Excretion of 6-hydroxymelatonin sulfate (6-sulfatoxymelatonin), the chief hepatic metabolite of melatonin was measured in the urine of humans who slept under electric blankets at night. These studies (Wilson and Anderson, 1990; Wilson et al., 1990) indicate that the circadian melatonin rhythm in some individuals may be changed by ELF associated with some electric blankets. In this study, two types of electric blankets were compared: conventional (snap safety switch) and continuous polymer wire (CPW). Compared to conventional blankets, CPW blankets have a short duty (on-off) cycle and they produce roughly a 50% higher magnetic field. Of the 28 subjects who slept under the CPW blankets, 7 (6 women and 1 man) were judged to exhibit some disturbance of their 6-sulfatoxymelatonin cycle. In these seven subjects, the metabolite changes occurred at the initial onset of the CPW blanket usage and after cessation of its use (the post-exposure period) (Figure 5-6). These authors concluded that either or both intermittent dc and/or intermittent 60 Hz ac EMF may give rise to changes in 6-sulfatoxymelatonin (same as 6-hydroxymelatonin sulfate; 6-OHMS) excretion in healthy adult humans.

Magnetic resonance imaging (MRI) requires the subject to be exposed concurrently to a static magnetic field, a radio-frequency field, and a time-varying magnetic field. Prato and co-workers (1988-89) collected nighttime blood samples from four healthy male volunteers (aged 22-35 years) before, during, and after MRI exposure. The procedure used resulted in 40.5 imaging minutes during a period of roughly 1 hour; the exposure was done between

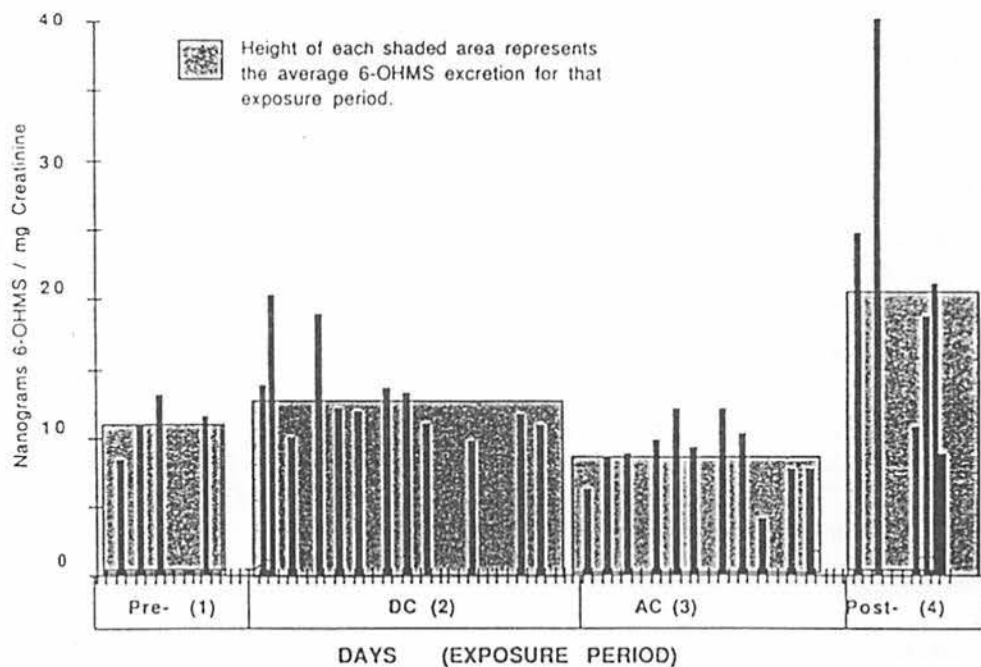

Figure 5-6. Nightly urinary excretion of the chief melatonin metabolite, 6-sulfatoxymelatonin (6-OHMS), in one healthy adult human during a pre-exposure period (1), during a period of exposure to a D.C.-powered (2) or A.C.-powered CPW electric blanket, (3) and during the post-exposure (4) period. Shortly after exposure onset and offset nightly urinary excretion of 6-sulfatoxymelatonin seemed to change in this individual. (From Wilson et al., 1990.)

midnight and 0200 hours. No effect of the treatment on circulating melatonin concentrations (MRI exposure vs. sham exposure) or time period (pre-exposure vs. post-exposure) was observed. This finding is consistent with an observation in which melatonin synthesis in the rat pineal also was not influenced by exposure to a 0.14 T magnetic field from a magnetic resonance machine (Reuss et al., 1985).

Exposure of rats to an alteration of the Earth's static magnetic field (MF) [field strength, approximately 0.5 Gauss or 50 milliTesla (mT)] quickly and significantly depressed the activity of the rate-limiting enzyme in melatonin production, i.e., NAT, and the levels of melatonin itself in the pineal gland (Welker et al., 1983). This group further reported that a 5° horizontal rotation of the Earth's MF was able to change pineal indoleamine metabolism. Because of these findings, the authors concluded that the pineal gland was directly "magnetosensitive."

Induction of pineal metabolic and physiologic changes by weak, static MF have also been reported by other authors (Semm et al., 1980; Reuss et al., 1983; Olcese et al., 1985; Rudolph et al., 1988; Stehle et al., 1988), with the bulk of the evidence suggesting that perturbed static MF exposure, by either direct or indirect mechanisms, changes both the electrical activity of the pinealocytes and their ability to produce the critical pineal hormone melatonin. These publications often lacked details concerning the specific parameters of exposure that were employed, although usually it seems that the MF field was inverted a single time during the exposure period. Whether the field was inverted with the animals in the field was also not always apparent.

A recent study also indicates that the production of the intracellular second messenger, i.e., cAMP, which is required for the nocturnal rise in pineal NAT activity and melatonin content, also is depressed by the exposure of rats to static MF (Rudolph et al., 1988). In general, the descriptions of these studies do not allow the reader to determine what parameters of the field are critical for inducing the observed changes in pineal indoleamine metabolism.

Using pulsed static magnetic fields (0.4 Gauss), Lerchl and co-workers (1990, 1991) carried out a series of studies on rodents during the night when pineal melatonin synthesis is naturally elevated. A pair of Helmholtz coils (1 m diameter with a clearance of 0.5 m) was oriented in a North/South direction. The coils produced a rapid inversion of the horizontal component when connected by a relay switch to a D.C. power supply. Using this apparatus, the reversal of MF was accomplished within approximately 25 msec, while its compensation was reached at about 5 msec after the coils were activated. Beginning at 3.5 hours after darkness onset, either young adult rats or mice were placed between the coils and exposed to an altered geomagnetic field for 1 hour; during this interval, the coils were automatically (and "instantaneously") activated or deactivated six times each at regular intervals of 5 minutes. All nighttime exposure procedures were carried out under a weak red light which has no effect on pineal melatonin production (Reiter, 1985).

After 1 hour exposure to the repeatedly pulsed static MF, the pineal gland of both male rats and male and female mice exhibited a significant increase in 5HT levels. Furthermore, 5HIAA values were likewise elevated in the pineal gland while the activity of the rate limiting enzyme in melatonin production, i.e., NAT, was depressed. It was presumed that

the rise in pineal 5HT was a direct consequence of the reduction in 5HT acetylation by NAT; likewise, as 5HT accumulated, it was quickly oxidatively deaminated to 5HIAA. The concentrations of 5HT and melatonin in the pineal gland are usually inversely related; thus, in the presence of high NAT activity melatonin is formed at the expense of 5HT. In contrast, when NAT activity is suppressed, e.g., by MF perturbations, 5HT accumulates while melatonin concentrations drop.

In a later study, Lerchl et al. (1991) also exposed rats to an inverted MF but in this study the application of the MF was changed in an important way. At 3.5 hours after darkness onset, one group of rats was subjected to the automatic inversion (by means of a relay switch) of the geomagnetic field at 1 minute intervals for 1 hour, while another group was exposed to the same frequency of MF inversion; however, in this case the voltage was regulated manually by means of an integrating potentiometer. The manual procedure required about 1 second for activating or deactivating the artificial MF, while with the use of the relay switch, the voltage in the coils changed essentially instantaneously. For both groups, the artificially generated field inverted the horizontal component of the Earth's MF; however, the coils allowed for the production of a measurable induced electrical current (eddy current) only in those animals exposed to the automatically inverted fields (Figure 5-7).

The rate of change of the generated MF (dB/dt) was estimated by measuring the eddy currents induced in a search coil placed between the Helmholtz coils. Whereas the automatic activation of the Helmholtz coils produced eddy currents when the power supply was switched on and off (maximal dB/dt values occurring at the moments of connecting and disconnecting the voltage), manual activation and deactivation of the Helmholtz coils (during a 1 second interval) did not produce measurable eddy currents (Lerchl et al., 1991).

These inversions of the MF produced different effects on pineal 5HT metabolism. In rats exposed to the automatically inverted fields (with induced eddy current), pineal 5HT and 5HIAA levels increased. Likewise, this treatment significantly depressed pineal NAT activity and melatonin levels (Figure 5-8). In contrast, in rats exposed to the manually inverted fields (with few or no induced eddy currents), pineal 5HT, 5HIAA, and melatonin levels and the NAT activity remained unaltered (Lerchl et al., 1991).

Many of these studies indicate that indoleamine metabolism in the pineal gland is altered by MF changes during the night. Other observations suggest that the pineal gland may not be the only organ in which neurochemical changes occur as a result of such treatment. Preliminary studies have shown that when female mice are exposed to a similar paradigm of automatically inverted MF for 1 hour at night, brainstem levels of both 5HT and 5HIAA are higher than those in unexposed control mice. Subsequent studies in this area should examine potential effects of altered MF on neurochemical processes in other areas of the brain.

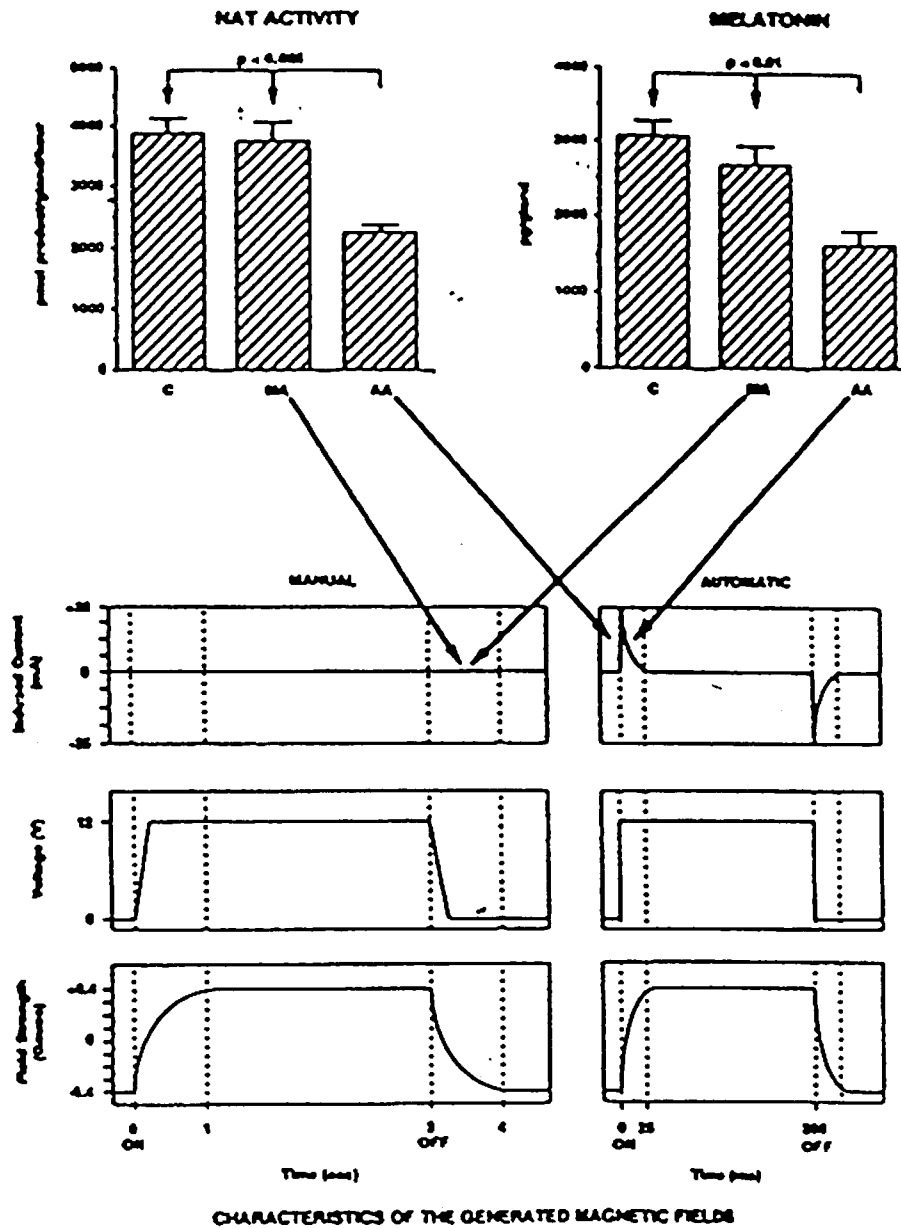
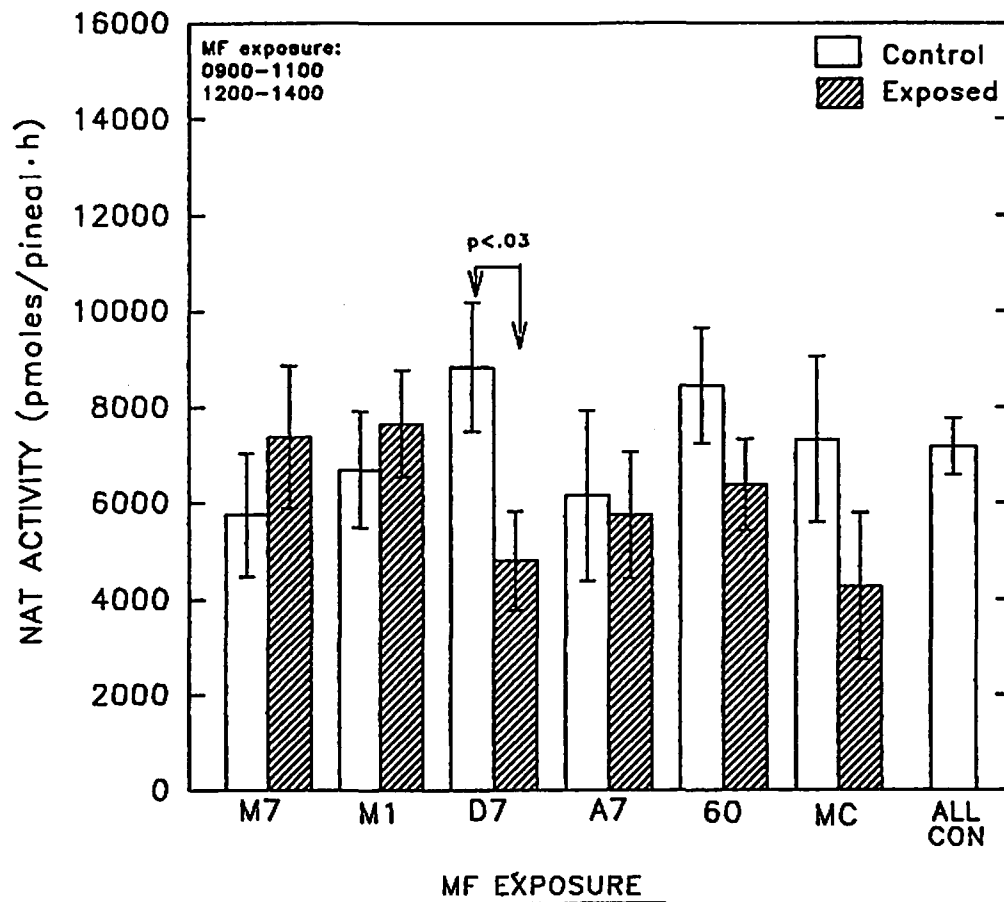

Figure 5-7. Changes in pineal NAT activity and melatonin content in rats exposed to repeatedly inverted static magnetic fields (top). The bottom half of the figure illustrates the characteristics of exposure and the presumed induced currents in the animals. When the coils were automatically activated (AA) by means of a relay switch, pineal NAT activity and melatonin levels fell; on the other hand, when the coils were ramped up manually (MA) by means of an integrating potentiometer over approximately a 1 sec interval, no effect on melatonin synthesis was seen. The implication is that the reduction in melatonin may be related to the induced eddy currents. (From Reiter and Richardson, 1992)



- Inverted, Intermittent, 45 s on, 15 s off

M7: 7X TR-07 intensity

M1: 1X TR-07 Intensity

D7: 7X dc MAGLEV component

A7: 7X ac MAGLEV component

60: 60-Hz (net, -450 mG)

- MC: 7X Intensity, Continuous

- ALL CON: Mean of all controls

Figure 5-8. NAT activity as measured in response to six different magnetic field exposures. (From Groh, 1993)

5.4.5 Studies on Neuroendocrine Effects of Simulated Maglev Fields

Groh (1993) used a pulsed static magnetic field as a positive control exposure in a series of experiments to determine the possible effects of simulated maglev magnetic fields on pineal melatonin concentrations and NAT activity. The simulated field was comprised of discrete frequency components between 0 Hz (dc) and 1620 Hz with relative amplitudes approximating those measured for the TR-07 maglev vehicle. Exposures were either intermittent (45 s. on and 15 sec off) or continuous (20 h/day), and were at either 1x, 2x, 4x, or 7x the TR-07 maglev magnetic field amplitude. Some groups received exposure to both the ac and dc components of this simulated maglev field and some groups received only the ac or the dc components. Other groups received either pulsed dc or 60 Hz magnetic field exposure. Various orientations of the fields to the geomagnetic field were also noted among the groups.

Group size in the study was small with only six animals per group. Nonetheless, intermittent exposure to the 7x amplitude (1-2 G) dc component of the simulated maglev magnetic field resulted in a statistically significant depression of pineal NAT activity and a proportionately substantial but nonstatistically significant depression in melatonin concentration. A less pronounced effect on both NAT and melatonin was observed from intermittent exposure to the 1-2 G ac component and from continuous exposure to the combined (ac+dc) simulated 1-2 G maglev magnetic field. Figure 5-8 displayed earlier from Groh et al., (1993) shows the NAT response to several types of magnetic fields.

5.4.6 Other CNS Effects of EMF Exposure

Since the eyes, in particular the retinas, have been often implicated as a site for the detection of EMF field perturbations, findings related to changes in retinal dopamine (DA) after the exposure of animals to pulsed static magnetic fields may be germane to the observed changes in pineal melatonin production. Light exposure at night, like the exposure of animals to perturbed MF fields, reduces the nocturnal production of melatonin. It is possible that the EMF exposure acts like light to induce changes in the retinas which eventually lead to a reduction of pineal melatonin synthesis.

One retinal constituent, DA, reportedly changes in the retinas of rodents after they are exposed to pulsed static magnetic fields. DA is the major catecholaminergic neurotransmitter in the pineal gland. According to Olcese and co-workers (Olcese, 1990; Olcese and Hurlbut, 1989; Olcese et al., 1987, 1988b), the daytime exposure of rodents to perturbed MF changes substantially the retinal content of the catecholamine even when the exposure duration is short (30 minutes in most cases). In both the Sprague-Dawley rat (a nocturnally active rodent with rod-dominated retinas) and the Richardson ground squirrel (a diurnally active rodent with cone-dominated retinas), retinal DA levels dropped by 50% after the exposure of the animals to altered MF during the day. Conversely, in the Syrian hamster, the same treatment caused greater than a 100% increase in retinal DA; the hamster, like the rat, is a nocturnal rodent whose predominant retinal photoreceptor is the rod.

While the retinal DA changes are large, they are seemingly inconsistent in terms of their direction of change. Also, whereas DA is the major catecholaminergic neurotransmitter in the retina, it is not substantially involved in the primary visual pathway. Thus, even though DA levels may change as a function of MF exposure, how this would relate to pineal melatonin alterations remains unknown. Nevertheless, it may be a cell biological alteration that is significant in its own right, and therefore, the response should be studied in other laboratories.

Other neurochemical changes have been reported in experimental animals as a consequence of EMF exposure. Vasquez and colleagues (1988) studied monoaminergic neurotransmitter rhythms in various areas of the central nervous system in rats. The exposure of rats for 20 hours per day to a 60 Hz electric field (39 kV/m) for 30 days changed the circadian fluctuations of norepinephrine (NE), DA, and the 5-hydroxyindole acetic acid (5HIAA) in the hypothalamus of the animals. Minor changes were also apparent in the striatum of these rats. The physiological significance of these induced changes is currently unknown. Concentrations of neurotransmitters, which were reported in this case, are not very informative concerning the synthesis or catabolism of the constituents in question. Nevertheless, in view of the neurotransmitter content changes reported by both Olcese (1990) and Vasquez et al. (1988), it appears that EMF exposure may change the metabolism of neural monoamines.

According to Zecca et al. (1991), brain amino acid neurotransmitters also may respond to 50 Hz electric fields in the range of 20-180 kV/m. The duration of exposure in these studies was 330 to 1408 hours (roughly 13 to 55 days). Initially, there was a slight increase in the amino acid concentrations in the striatum; however, after 1240 and 1408 hours of exposure the values declined compared to those in control animals. The changes observed were not related to the field strengths employed, and the authors interpreted the results to mean that the electric field exposure initially stimulated and then depressed brain function. The magnitude of the changes was slight, albeit statistically significant, and the concentrations of the altered amino acid neurotransmitters still were in the physiologically normal range.

5.4.7 In-Vivo Cancer Studies

To date, no peer-reviewed reports of laboratory studies concerning the effect of chronic EMF exposure on spontaneous tumor risk are available. However, papers and abstracts describing initiation/promotion and co-promotion studies have appeared, and information is available about other ongoing studies. We will summarize these here because of their relevance to the issue of cancer.

Using exposure to 60 Hz electric fields at 40 kV/m as a treatment, in two separate studies, Leung et al. (1988) reported that rats initiated with DMBA by gavage at 54 days of age had more mammary tumors per tumor-bearing animal at either 18 or 23 weeks of exposure than did similarly initiated animals that were not subsequently exposed to the field. In neither individual study was the difference statistically significant. Nor was an increase in tumor incidence observed for the exposed group in either of the studies. Taken together, however, the studies did show a statistically significant increase in tumors per tumor-bearing animal.

Although the initiator used was a complete carcinogen, Walborg (1991) has interpreted these results to be suggestive of a weak promotional effect of electric fields.

Citing the above study, Beniashvili et al. (1991) reported that both 50 Hz ac and dc magnetic field exposure increased mammary tumor burden and decreased latency time and survival in rats initiated with N-nitrosomethyl urea (NMU) and compared to initiated animals not exposed to EMF. Groups of 50 rats (exposed) or 20 rats (not exposed) each, were initiated with NMU. Animals were then exposed for either 30 minutes or 3 hours/day for up to 2 years. Those animals subjected to 3 hours/day exposure had higher tumor burdens and shorter latency than animals exposed for only 30 minutes/day. The authors hypothesized that reduction in melatonin was a possible mechanism for the observed effect (see Table 5-2).

Table 5-2. Effect of magnetic field exposure on mammary tumor latency and yield after initiation with N-nitrosomethylurea. Exposure was for either 3 hours per day or 30 minutes per day to either a 50 Hz ac or static D.C. magnetic field. (Data adapted from Beniashvili et al., 1991.)

	Rats with Tumors	Total Tumors	Mean Latency
Control	27	31	74.4 ± 14.9
50 Hz MF (3 hrs.)	43	75	45.5 ± 11.7
Static MF (3 hrs.)	39	43	52.8 ± 17.1
50 Hz MF (30 min.)	33	40	64.8 ± 10.5
Static MF (30 min.)	32	36	65.4 ± 18.2

In a multi-generation study, Fam and Makhail (1990) exposed mice to 60 Hz magnetic fields at 25 mT (250 G) for three generations. Animals from the second and third generations were conceived and raised in the field. When sacrificed at 4 months of age, there were no gross histopathological changes and no evidence of leukemic transformation.

Buntenkoetter et al. (1990) chemically initiated adenocarcinomas by gastral intubation of DMBA in 96 Sprague-Dawley rats at 52 days of age. Thirty-three of the animals were exposed to a 30 mT (300 G) homogeneous 50 Hz magnetic field for 91 days. The remainder of the animals were either sham or cage controls. No differences between exposed and control animals were observed with regard to incidence or number of tumors.

A Swedish study by Rannug, Holmberg, and Mild (1990) employed a hepatocyte model to determine possible co-promotional effects of 0.5 mT 50 Hz magnetic fields. Sprague-Dawley rats were subjected to partial hepatectomy and later injected with subcarcinogenic doses of dimethylnitrosamine, a known initiator. Phenobarbital was administered as a known promoter to provide a positive control. Magnetic field exposures of 0.5 μT, 5 μT, 0.05 mT, and 0.5 mT (5, 50, 500, and 5000 mG) were administered for 19 to 21 hours per day. Results showed that the magnetic fields had no significant promotional effect as determined by the number of foci observed in the liver.

McLean et al. have conducted two studies (McLean et al., 1990, 1991) to determine if magnetic field exposure can serve as a co-promoter. Again, DMBA was used as an initiator. However, in these studies, DMBA was given in sub-carcinogenic doses and the rats were subsequently promoted with 12-O-tetradecanoylphorbol-12-acetate (TPA). Magnetic field exposure was then tested both as a promoter (without concurrent TPA promotion) and as a co-promoter (with concurrent TPA promotion). In the first of these studies, there was a difference in time to tumor with the magnetic field +TPA group having a shorter latency. The difference was not statistically significant. Magnetic fields alone showed no promotional effect. In the second of these studies, which is still underway, lower doses of both DMBA and TPA were used. At 12 weeks after initiation, the magnetic field +TPA group had approximately twice as many tumors as did the TPA-only group.

5.4.8 Effects on Behavior

A number of behavioral effects have been reported as a consequence of electric field exposure, including change in circadian rhythms in mice as determined by respiration and motor activity (Groh et al., 1990), as well as changes in task performance in rats (Liboff et al., 1990) and baboons (Rogers et al., 1987). Certain of these experiments have not yet been carried out using magnetic field only exposure. The longest ongoing behavioral study, that involving the Southwest Research Institute baboon colony, has demonstrated both operant and social behavioral effects from electric field exposure alone. Changes in social behavior have been observed with combined EMF.

Short-term memory is dependent on the motion of calcium ions through specific channels in the neuronal membrane. One view of the memory process is that activation of N-methyl-D-aspartate (NMDA) receptor by the excitatory amino acid glutamate is required for the induction of long-term potential (LTP). In the present context, LTP may be considered the basis of memory "formation." Agents that either chelate calcium or block the function of NMDA receptor prevent the induction of LTP. However, once LTP is established, these agents have no effect on its expression. Of interest relative to the question of EMF effects on memory is that the NMDA receptor antagonists not only prevent induction of LTP, but adversely affect the animal in a radial arm maze. Radial arm maze tasks test spatial memory, which appears to be adversely affected in a dose-dependent manner by administration of compounds that prevent normal function of the NMDA activating calcium ion channel in the neuron.

Lovely et al. (1990) devised an experiment aimed at determining whether consequences of reported EMF effects on calcium mobility in animal cortex (Bawin and Adey, 1976) might be detected in live animal experiments. LTP in the rat hippocampus and memory utilized in the radial arm maze task are both known to be dependent on free movement of calcium in the brain. Glutamate binding to NMDA receptors with subsequent conformational changes in the calcium ionophore is a process central to both LTP and RAM performance. Both can be adversely affected by injection of calcium chelators, or of specific agents that interfere with the NMDA receptor. In the Lovely et al. experiments, task acquisition performance in the maze was significantly altered by the presence of a horizontal 450 mG magnetic field at 60 Hz. In more recent studies, Lovely and Creim (1991, personal communication) observed

that exposed animals made significantly more errors while learning the task than did control animals when only half of the arms were baited (Lovely et al., 1990). These findings are consistent with those of Thomas et al. (1986) who reported reduced performance in a timed task after animals had been exposed to a magnetic field.

More recent data from this series of studies suggest that adjusting conditions for coupling with Mg^{++} ion can improve task acquisition performance in rats, as would be predicted by NMDA current understanding of the magnesium ion's role in the function of NMDA receptor (Lovely et al. 1993).

5.5 SUMMARY

Biological responses to EMF are many and varied. Both magnetic and electric field sensing are observed in the animal kingdom. Specialized organs have evolved that allow sensing of electric fields at exceedingly low field strengths. Likewise, many animals exhibit sensitivity to the geomagnetic field and use it for homing, navigation, or both. To what extent this sensing may depend on the presence of magnetite in biological tissue is currently an area of some interest.

Effects on bone growth can be elicited by both direct current injection and non-invasive induction of electric fields by means of pulsed magnetic field application. Observed and theoretical attributes of such fields important in these effects have been discussed.

Extended ensembles of cells, in electrical contact via gap junctions, can theoretically detect and amplify lower frequency signals, and such effects may lead to induced electric fields having energies near or above that of ambient thermal noise. Clinical data in bone growth stimulation yield substantial evidence that such amplification does take place.

Experimental and clinical evidence indicates that stimulated or rapidly cycling cells and stressed in-vivo systems are more likely to be responsive to EMF exposure than are systems in resting states. Examples include the requirement that cells be treated with a mitogen in order to show changes in calcium uptake under exposure to magnetic fields (Liburdy et al., 1992), and the selective stimulation by PEMF of growth in bone cells immediately adjacent to a fracture site.

In-vivo effects of environmental strength magnetic fields, as applied in phenomenologic studies appear to be, for the most part, neuronally mediated. Induced alterations in cardiac EKG, EEG activity, MEG, and pineal gland function are among the observed neuronal responses to magnetic field application. Consistent with these findings are observed changes in behavior of animals exposed to time-varying magnetic fields.

Studies from several laboratories suggest that EMF exposure may affect CNS function. Effects, found in both rodents and humans, are consistent with the hypothesis that EMF may affect calcium ion transport, either directly or by alterations in receptors or other membrane-associated molecules that control ion channels.

Melatonin plays a role in cancer risk as determined in animal models and controls reproduction in many seasonal breeders. Although not yet well understood, it is clear that melatonin rhythms play a role in some types of affective disorders in humans. The neuroendocrine or melatonin hypothesis has been tested in several epidemiologic studies that found breast cancer risk to be elevated in men with occupational exposure to magnetic fields. There are now two published reports of laboratory studies in which EMF exposure increased breast cancer risk in rodents that had been chemically initiated.

Several studies suggest that exposure to magnetic fields at 50 or 60 Hz can enhance the development of cancer, as determined by several endpoints, in animals that have had a single treatment with chemical initiators and concurrent chemical promoter treatment along with magnetic field exposure.

6. THE NEUROENDOCRINE HYPOTHESIS: A PLAUSIBLE MECHANISM FOR EMF-ASSOCIATED HEALTH EFFECTS

6.1 SYNOPSIS

In preceding sections, we have reviewed proposed physical mechanisms for EMF-induced biological effects, and many of those effects have been discussed. If, indeed, EMF exposure can result in adverse health effects, then between the physical mechanism of interaction and the manifestation of such health effects are physiological processes that will require further study. Determining what such processes are and how they may be affected by EMF exposure is a primary objective of EMF research that uses animals as models.

This chapter discusses hypotheses regarding the physiological processes that may contribute to EMF-induced adverse health effects, as indicated by epidemiologic studies. Emphasis is on the neuroendocrine hypothesis, because the physiologic effects of EMF on which it is based are generally acknowledged by the scientific community as a whole, as evidenced in recent government independent reviews (ORAU, 1992; Walborg, 1991; Theriault 1991). Recent work of Groh (1993) indicating that simulated maglev magnetic field signals may affect pineal NAT activity underscores the relevance of this hypothesis to the question of possible biological or health effects in humans from use of electric transport systems.

6.2 INTRODUCTION

As a result of early work on the effects of EMF on melatonin, Wilson and colleagues (1981) suggested that changes in neuroendocrine function may account for many of the biological effects associated with exposure to EMF. Stevens (1987) proposed that the EMF-induced alterations in melatonin may account for possible increased risk of cancer in EMF-exposed occupations.

This was termed the "neuroendocrine hypothesis" and was based largely on the work of Wilson and colleagues (1981, 1983), and on that of Semm and colleagues, including papers by Semm et al. (1980) and Welker et al. (1983). The hypothesis has been expanded and refined by Wilson et al. (1989) and by Stevens et al. (1993) as a possible physiologic mechanism by which EMF fields may affect mood, immune function, and reproductive function, as well as hormone-dependent cancers.

Based on results from laboratory studies, this hypothesis has been successful in predicting specific types of cancers that have been found in higher than expected numbers in EMF exposed occupational cohorts, including male breast and prostate cancers, and melanoma (Chapter 7). It has been the basis for successful laboratory experiments on breast cancer (Wilson et al., 1988; Beniashvili et al., 1991), and for hypothesis-testing epidemiologic studies in depression (Poole et al., 1992) and breast cancer (Tynes and Anderson, 1990; Demers et al., 1991).

Finally, this hypothesis is relevant to the issue of maglev and electric transport systems in general because of recent results indicating that, at increased flux densities, magnetic fields created to simulate maglev exposure may have effects on pineal gland function in laboratory rats. These data are discussed later in this chapter. As reviewed in chapter 4, these fields had no apparent effects in a number of cultured cellular test systems.

Extended treatment of pineal gland function and effects is outside the scope of this chapter. Information on this gland, and the role of melatonin in cancer risk, mood, reproduction, immune system function, and aging, is provided in the Appendix.

There are a number of other proposed physiologic mechanisms that may be important in understanding possible physiologic mechanisms underlying the observed associations between magnetic field exposure and increased cancer risk. Clearly, the observations of altered calcium ion mobility discussed in the previous chapter may be important in this regard. This general consequence of EMF exposure may underlie many, if not most, of the observed physiologic effects that may be linked to the adverse health outcomes of interest. Many of the effects observed in cellular systems such as changes in ODC activity, possible effects on gene transcription, and effects on second messenger systems, including protein kinase C, for example, are among the other biological effects of EMF which may also prove important in this regard. However, to date, the physiologic mechanism that has been most widely confirmed in different laboratories and has been linked by laboratory studies to many of the health endpoints of interest is the effect of EMF exposure on melatonin synthesis and release by the pineal gland. In this chapter, the effect of EMF on pineal function will be discussed both as an illustration of how exposure to weak EMF may, theoretically at least, be a contributing factor to negative health outcomes as suggested by the epidemiologic studies.

6.3 THE NEUROENDOCRINE IMMUNE AXIS

Direct interactions among the nervous, endocrine, and immune systems are emerging as important facets in the function of these three main regulatory systems in the body. Most studied in this regard are the interactions of the so-called hypothalamic pituitary gonadal axis, the hypothalamic pituitary adrenal axis, and the hypothalamic pituitary thyroid axis with the immune system.

Examples of these interactions include the recently reported effects of the gonadal and adrenal steroids on brain development and memory, the effects of immune system thymosins on brain function at the level of the pituitary gland, and the effects of neurohormones on thymus function (for a review, see Cotman et al., 1987). There is growing recognition that the pineal and its principal hormone melatonin are likely to play an important role in communication among the neuronal, endocrine, and immune systems (Wilson et al., 1989).

6.4 EMF EFFECTS ON CIRCADIAN RHYTHMS

It is likely that the observed effects of EMF exposure on melatonin are but one manifestation of more fundamental effects from magnetic field exposure on those nuclei and glands in the CNS and neuroendocrine system that mediate, and are affected by, photic stimuli. One of the earliest reported effects of EMF exposure in laboratory animals concerned circadian rhythms in activity and metabolic rate (Groh et al. 1990). Pineal function is an important manifestation of these circadian rhythms. As discussed in some detail in the Appendix, the pineal synthesizes and releases melatonin in a circadian rhythm that is strongly dependent on the external light/dark cycle.

In the hypothalamus, cells of the suprachiasmatic nuclei comprise an internal clock that is also affected by the periodic perception of light and, under some circumstances, may use the nightly peak in melatonin for synchronization. The SCN is thought to be the "master clock" in mammalian and possibly other species (Moore-Ede et al. 1982). The exact nature of the interactions among the SCN, the other hypothalamic nuclei, the pineal, and external timing cues or Zeitgebers such as periodic light varies according to species, time of year, availability and type of food, and other factors.

Alterations in the circadian rhythms of the hypothalamic nuclei and the pineal can have profound effects on the other glands in the neuroendocrine system. Based on evidence for circadian effects outside the pineal, such as those observed by Groh et al. (1990) and Wilson et al., (1993), it is clear that EMF exposure may affect the circadian system as a whole, including certain of the hypothalamic nuclei. The view that EMF may affect the circadian system as a whole was also expressed as a result of earlier work by Groh et al. (1990), showing EMF-induced circadian changes in activity and metabolism. Reiter (1985) has suggested that these effects may be dependent on the visual system and may be mediated in much the same manner as the effects of light.

If such is the case, then the alterations in melatonin rhythms may be only one of a constellation of changes in neurotransmitters and hormones in response to EMF exposure. Exposure of Djungarian hamsters to magnetic fields in the late afternoon, during a time period when the animal is sensitive to melatonin, can delay the subsequent timing of the night time melatonin peak (Yellon et al 1991). These observations have been confirmed and extended by Wilson and colleagues (1993) who also reported alterations in hypothalamic norepinephrine in short day animals. These increases in NE in the medial basal hypothalamus, including the SCN, were of the type that would be expected in animals exposed to extended day length. These observations are consistent with either primary or secondary effects of EMF on a number of components in the circadian system. Although the focus of this chapter is on the possible consequences of alterations in the melatonin rhythm in response to EMF exposure, the possible wider scope of circadian system effects from EMF exposure should be kept in mind.

6.5 NEUROENDOCRINE EFFECTS OF EMF EXPOSURE

Most consistent among the observed effects of EMF exposure in the laboratory have been those that are mediated by the nervous system. An important manifestation of EMF interaction with the nervous system in these studies has been alteration in the circadian rhythm of a number of hormones and neurotransmitters (Vasquez et al., 1988). Because of the reported oncostatic properties of one of these compounds, melatonin, suppression in the synthesis and release of this hormone by exposure to both electric (Wilson et al., 1981) and magnetic field exposure (Welker et al., 1983) has been of interest relative to the question of EMF and cancer.

Some 20 studies now appear in the literature reporting effects of EMF on pineal gland function. Those that were carried out primarily to determine effects of anthropogenic EMF on neuroendocrine function were reviewed in the preceding chapter. Semm and colleagues (1980) reported that specific cells in the pigeon pineal gland alter their firing rates in response to changes in the direction of the local static magnetic field. Subsequent work by Welker (1983) and by Olcese, Reuss and colleagues (1985, 1986) has shown that the rat can also respond to changes in the magnetic field by altering pineal gland function. These studies were with dc magnetic fields and were aimed primarily at determining if rodents could detect the Earth's magnetic fields and use this information for navigation or homing.

Concurrent work by Wilson et al. (1981) showed that exposure to 60 Hz electric fields for 20 hr/day over a period of 3 weeks, suppressed the night time rise in pineal melatonin. This reduction appeared to be a threshold all or none response with onset at electric field levels of between 200 and 2000 volts per meter. Subsequent studies by this group showed that the effect was reversible with night time melatonin levels for exposed animals indistinguishable from those for controls within 3 days after cessation of exposure. The specific biochemical lesion induced by EMF exposure was subsequently identified by direct determination of activity for NAT, the rate limiting enzyme in the conversion of serotonin to melatonin. Activity of this enzyme was suppressed by field exposure. Observed accumulation of serotonin, its metabolite 5-hydroxy indole acetic acid, and of 5-methoxy tryptophol in the pineal gland was consistent with an effect on NAT. The latter two compounds are produced using serotonin as a substrate, via an enzymatic pathway not involving NAT, and would be expected to increase in concentration under conditions of decreased NAT activity.

The pineal gland was thought by Descartes to be the seat of the soul. Since his time, it has been termed vestigial, a neuroendocrine transducer (Wurtman, 1969), and an end organ of the visual system (Reiter, 1987). Its principal hormone melatonin is secreted on a circadian cycle with both blood and pineal concentrations increasing during the hours of darkness to peak between approximately 2 am and 4 am, falling thereafter, and remaining low during the day. Timing and duration of the melatonin signal is thought to convey information about time of day and season to the internal organs of the body and is important in synchronizing a number of other circadian and seasonal biological rhythms.

In mammals, its rhythms appear to be determined by internal timing signals from the master clock of the suprachiasmatic nuclei in the hypothalamus, and synchronized to the external day/night cycle by the onset of light and darkness. Melatonin can be found in nearly every tissue and in every bodily fluid. In many mammals, including rodents, melatonin is antigonadal (Reiter 1986). It interacts with the immune system where its properly timed administration enhances immune surveillance, and natural killer cell activity (Maestroni and Conti, 1986). Overall, melatonin appears to suppress the activity of other endocrine organs (Nir, 1978).

6.6 THE NEUROENDOCRINE HYPOTHESIS

The neuroendocrine hypothesis specifically addresses the problem of how ELF fields, with energy deposition insufficient to break chemical bonds and thus unable to cause mutation directly, may nonetheless effect changes in biological function that can result in increased cancer risk. It states that EMF-induced suppression or phase shifting of the night time peak in melatonin synthesis and release by the pineal gland may lead to the same kinds of biological changes that occur when pineal function is experimentally suppressed in laboratory animals by surgical or pharmacologic means, or by constant light exposure.

Manipulations of circulating melatonin concentrations by suppression of the melatonin rhythm, pinealectomy, or administration of exogenous melatonin have been shown to affect reproduction (Reiter, 1980), mood (Lewy et al., 1986), immune function (Maestroni and Conti, 1991a, b), and life span (Stokkan et al., 1991), as well as affecting the risk of cancer in chemically initiated animals (Tamarin et al., 1982). Figure 6-1 depicts the relationships between the physiologic effects of melatonin in animal experiments and the health endpoints that may be affected by EMF exposure in human as suggested by epidemiologic studies.

The hypothesis is attractive because the proposed physiological mechanisms do not require that the low-energy EMF exposure cause chemical changes in biological tissue. It requires only that the fields be detected by the organism and subsequently affect pineal gland function. Such detection of the geomagnetic magnetic field is observed in a number of vertebrate species and thus does not appear to be precluded by energetic considerations. Because of the diverse actions of melatonin in the neuroendocrine and immune systems, changes in the timing and rate of this hormone's synthesis in the pineal may affect cancer risk, reproduction, and mood and affect.

Pineal function in the endocrine system is that of suppressing most other endocrine glands (Wurtman and Cardinali, 1974; Nir, 1978). Pinealectomy in rats results in endocrine changes which include increases in circulating levels of gonadal steroids as well as FSH and prolactin (Kamberi et al. 1971). Pineal ablation also causes measurable functional changes in the hypothalamus, pituitary, and gonads, as well as in the thyroid and parathyroid glands (Nir, 1978).

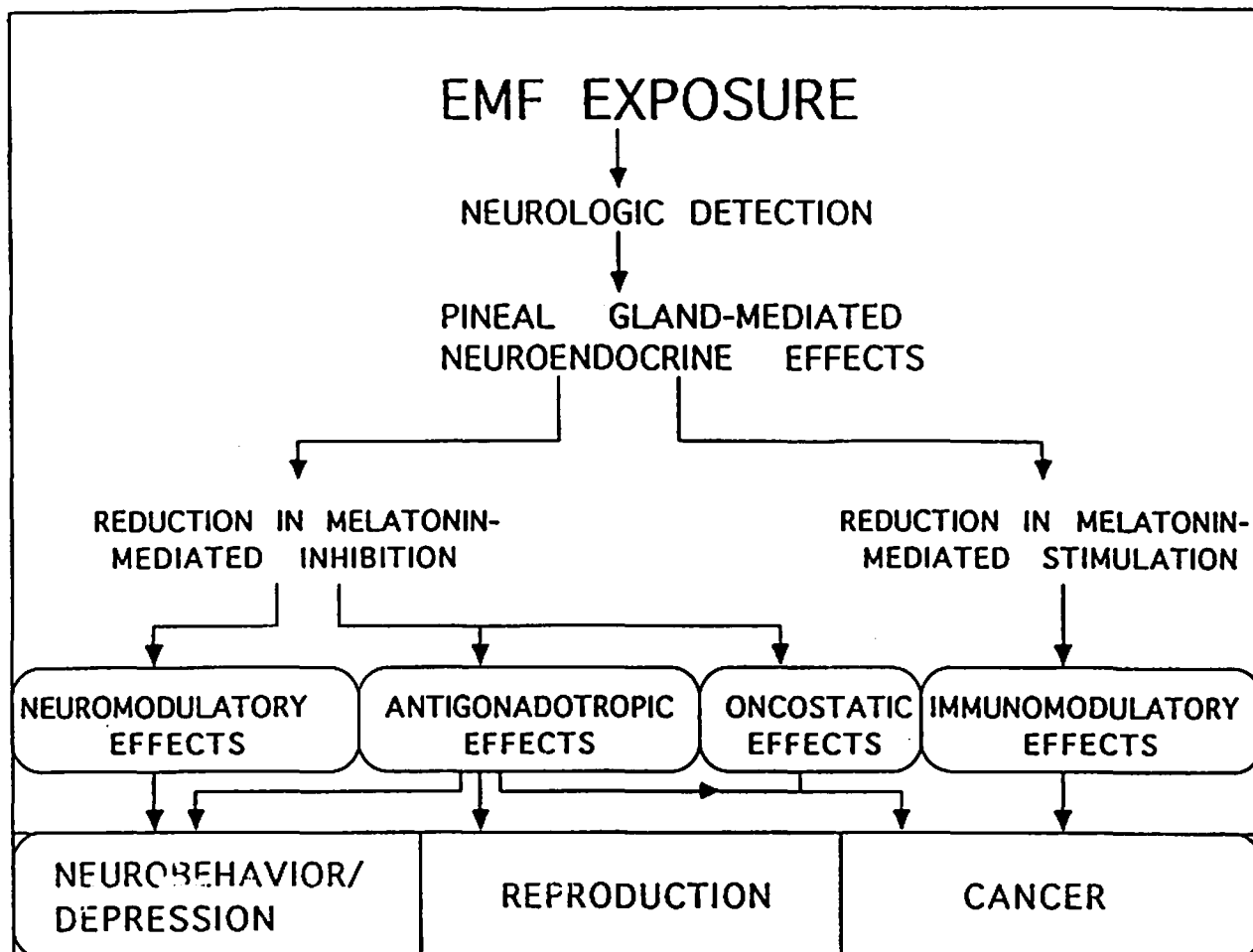

Figure 6-1. Depicts the possible consequences of EMF detection by the pineal gland, which results in reduction or phase-shifting of the nighttime peak in melatonin. Consequences are based on well-documented effects of melatonin.

The pineal gland is innervated by noradrenergic fibers of the superior cervical ganglion. Nocturnal release of norepinephrine activates the adenylate second-messenger system. This event stimulates an increase in N-acetyl transferase (NAT) activity which, along with hydroxy-O-methyl transferase, converts serotonin to melatonin (Axelrod and Weisbach, 1960). NAT appears to be the rate-limiting enzyme in this pathway (Wurtman and Ozaki, 1978). Melatonin and other serotonin metabolites in the pineal exhibit strong circadian rhythms in most reptiles and mammals studied thus far, including man (Lewy et al. 1986).

There are also superimposed annual cycles in the clock time for peak melatonin levels in the circulation as well as estrus cycle rhythms in humans and rats (Wetterberg et al. 1976, Hariharasubramanian et al. 1985). In all species, pineal and blood levels of melatonin begin to increase shortly after the onset of darkness and reach peak concentrations 2 to 4 hours before the onset of light. Exposure to light during the normal dark cycle leads to a precipitous drop in circulating melatonin in several species, including sheep, rats and man (Lewy et al. 1980).

Melatonin is cytotoxic in several cancer cell lines in vivo, protective against several cancers in vivo including prostate, and breast cancers, and melanoma. No studies of melatonin effects on brain cancer models in animals have been reported. However, melatonin has been used as an adjunct to chemotherapy in a variety of advanced cancers, and its use has been shown to help slow progress of the disease.

Certain immune system functions appear to be affected by melatonin, which acts to enhance natural killer cell activity, and can antagonize the immunosuppressive effects of corticosterone injections, for example. Melatonin can act postsynaptically as a neuromodulator or as an inducer of sleep in humans. Timing of the melatonin rhythm is strongly implicated in seasonal affective disorder syndrome (SADS), a winter depression for which light therapy is curative. Reduced melatonin concentrations in the circulation have been associated with major depression by several authors. Melatonin apparently influences several aspects of maturation and ageing.

Finally, melatonin plays an important regulatory role in fertility of many seasonal breeding animals. As illustrated by this partial listing of demonstrated melatonin effects, pineal gland function can play a role, or be an etiologic factor, in each of the broad disease or disorder categories (cancer, depression, and reproduction) associated with surrogates of EMF exposure in epidemiologic studies.

These effects of melatonin, as determined in animal studies as well as in some clinical work with humans, are reviewed in some detail in Appendix A. An expanded treatment of pineal gland function and the evidence for melatonin's role in the etiologies of certain cancers, and other disorders may be found in this appendix. Because of the current interest in the possibility that magnetic field exposure may be a risk factor in certain types of cancer, the effects of melatonin on physiologic functions that relate to cancer are discussed in more detail.

6.6.1 Pineal Function and Cancer Risk

An association between the pineal gland function and tumor growth was demonstrated some 70 years ago (Georgiou, 1929). The significance of this early work has been recognized during the last decade as evidence has mounted that the pineal hormone melatonin is protective against a number of neoplasms, including leukemia, breast and prostate cancers, and melanoma. In the case of chemically induced breast cancer models, a number of studies now demonstrate, unequivocally, the protective effect of both endogenous and administered melatonin.

Several possible mechanisms have been proposed to account for melatonin's effect on cancer growth. First considered are the hormone-dependent cancers such as estrogen receptor positive breast carcinoma and prostate adenocarcinomas. These cancers require adequate circulating concentrations of estrogen and testosterone, respectively, for growth and proliferation. Increased circulating levels of prolactin are thought to be a risk factor in breast cancers. One of the earliest recognized physiologic roles for melatonin was that of antigonadal principal. Melatonin normally acts to reduce circulating levels of the gonadal steroids and of prolactin.

Melatonin is also directly oncostatic against several cancer cell lines in vitro, including a subclone of MCF-7 breast cancer cells (Blask, 1990) and B-16 melanoma cells. Melatonin has been shown protective, whether produced endogenously or administered, against a number of cancers in vivo, including DMBA induced mammary carcinoma and Dunning prostate adenocarcinoma.

A third general means by which melatonin may influence cancer risk is indirectly via modulation of the immune response. Results from a number of studies, designed and carried out specifically to gather data on the interaction of melatonin with the immune system, have suggested that this hormone may influence the activity of several components, including NK cell activity (Maestroni and Conti, 1986). It should be noted that in several of these studies, the timing of the melatonin administration was often critical in obtaining the immune system effects.

Wilson et al. (1990) reported changes in melatonin excretion in volunteers who used modified electric blankets. At onset of exposure, there was a short-lived increase in excretion of the urinary metabolite 6-hydroxy melatonin sulfate. This was followed by a general decline in urinary excretion of this melatonin metabolite as exposure continued (for up to 10 weeks). At cessation of exposure, there was again a short-lived (5-8 day) increase in melatonin production. The magnitude of this increase was substantially higher than that of the first increase, and in some subjects was 4-5 times the amount measured on for the evening prior to cessation of exposure.

Figure 6-2 shows the findings from various studies that are deemed consistent with the hypothesis that EMF exposure may affect cancer risk via mechanisms mediated by the neuroendocrine system.

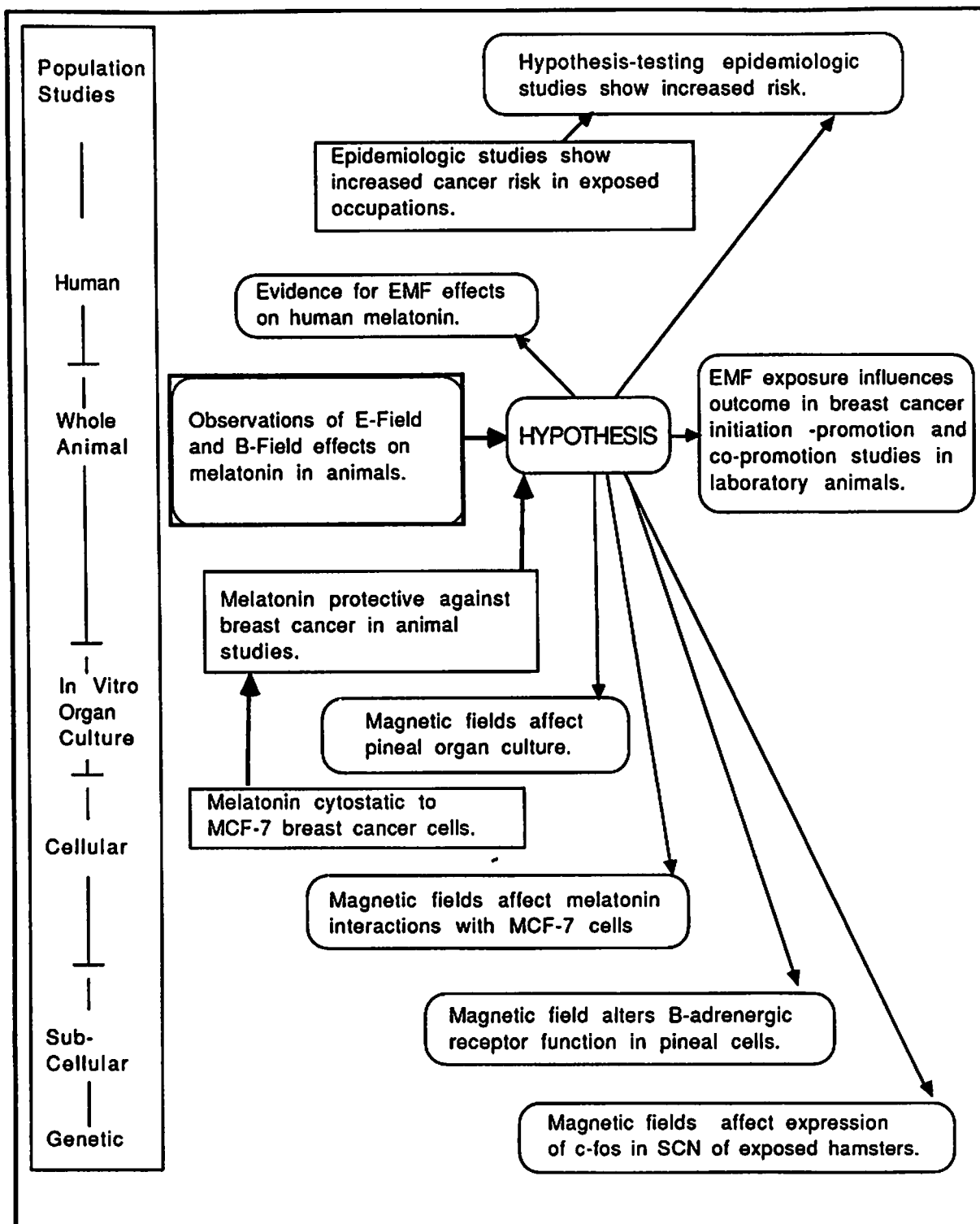

Figure 6-2. Schematic showing the findings that led to the breast cancer hypothesis by Stevens (1987) and subsequent experimental and epidemiologic findings that are consistent with that hypothesis.

6.7 DISCUSSION AND CONCLUSIONS

Work has been carried out to determine specifically the possible biological effects on the neuroendocrine system of exposure to magnetic fields such as those that may be generated by electric transport systems (Groh 1993). As reviewed in the preceding chapter, results from these experiments are consistent in terms of the effect of bipolar pulsed dc magnetic fields on melatonin concentration in the pineal as reported by Lerchl et al., 1990, 1991. These studies also provided evidence that a simulated maglev signal at 7x the flux density measured for the TR-07 affected activity of the enzyme NAT and also had a proportionally substantial but statistically nonsignificant effect on melatonin concentrations. Taking into account customarily applied scaling factors between humans and rats for magnetic fields, the 7x exposure is approximately equivalent to the original 1x amplitude exposure in man.

Thus the results of Yellon et al. (1991) showing that short-duration exposures of 15 minutes to a 60 Hz, 1000 mG magnetic field can affect pineal melatonin rhythms in hamsters are of possible relevance in the context of the electric rail transport studies. Administration of the field in these experiments was timed to coincide with a period of the day wherein administration of melatonin is known to have maximal effect. It is believed that at this time, approximately two hours before the onset of darkness, melatonin receptors are optimally expressed in cells outside the pineal gland.

This work is in an early stage; however, in view of similar results by Wilson and colleagues (1993) and the results of Groh (1993), short-duration exposures to reasonably strong magnetic fields, such as those associated with some electric rail systems (possibly exceeding 10,000 mG in the Washington, DC, Metro system, for example) should be further investigated as a possible environmental factor that could affect circadian rhythms. The fact that use of these trains by the public is for short-duration trips during roughly the same time period each day makes the timing of the administration of the fields, as in the Yellon studies, a parameter of interest in further studies.

From a broader perspective, the question of possible biological or health effects of EMF exposure associated with electric rail transport will be addressed to some degree by other studies that test the neuroendocrine hypothesis. These include studies such as the National Institute of Health (NIH) epidemiology study that is being conducted to determine if there is an association between breast cancer risk and EMF exposure in women. As shown in later chapters, however, it is unlikely that exposure to maglev magnetic fields, as measured for the TR-07 vehicle, will have biological effects that are substantially different from those that may be associated with existing rail transport systems.

7. EPIDEMIOLOGIC STUDIES CONCERNING EMF EXPOSURES

7.1 SYNOPSIS

This section begins with a brief description of those cancers that have been statistically associated with EMF exposure, or EMF exposure surrogates, through epidemiologic studies. These include leukemias, lymphomas, brain cancer, melanoma, and neuroblastoma, as well as breast and prostate cancer in males. While a thorough review of EMF-related epidemiology is outside the scope of this document, we will use the results of many of these studies to establish that at least a statistical association does exist between increased EMF exposure and the various cancers listed. Increased risk for miscarriage and mood disorders have also been linked to EMF exposure by epidemiologic studies.

Types of cancers linked to increased EMF exposures are described briefly. We list risk factors for these cancers where they are known or suspected and provide estimates of the normal incidence of the cancers.

Characteristics of the links between EMF and disease that should be evaluated in judging whether a cause and effect relationship may exist are presented and discussed. We consider epidemiologic studies relevant to a possible association between EMF and cancer under two categories: residential and occupational. Where available, we include information about the spectral characteristics of the distinguishing EMF exposure in the populations studied. Many of the fields associated with occupations found to have increased incidence of cancers, where such fields have been adequately characterized, appear to be other than purely sinusoidal.

We also review epidemiologic studies that have investigated possible associations between EMF exposure and miscarriage and depression. The general disease categories so far associated with EMF exposure, as well as the types of cancer themselves, are known to be affected by pineal gland function in animal or human models. We discuss limitations in the interpretation of these epidemiologic studies and caveats that should be taken into account when considering the significance of these studies.

7.2 INTRODUCTION

Concern regarding possible adverse health effects from EMF exposure has arisen primarily as a result of epidemiologic studies. Such studies have suggested an association between increased EMF exposure and increased risk of depression, miscarriages, and specific cancers. While many of these reports have indicated no detrimental effects (e.g., Severson et al., 1988), an increasing number of epidemiologic studies report a statistically significant association between EMF exposure, or exposure surrogates, and increased cancer risk. These reports suggest that elevated risk of childhood and adult leukemias, lymphomas, and brain cancer, as well as melanoma and male breast and prostate cancers in adults, may be associated with increased exposure to electric or magnetic fields (see reviews by Theriault, 1991, and Walborg, 1991).

Interpretation of the epidemiologic studies varies widely with regard to any actual risk associated with EMF exposure. Zangwill et al. (1992) have recently called into question the criteria (if any) used by reviewers for inclusion of epidemiologic studies to be considered. These authors note that of the more than 20 reviews since 1989, there have been few that described criteria for evaluation and inclusion of primary studies. Several qualified epidemiologists maintain that, overall, these studies reflect no increased risk from EMF exposure (e.g., Jackson, 1992). While those who maintain that EMF exposure has no association with risk are a minority, among those who have published reviews of the literature in this area, there is a consensus that no cause and effect linkage between EMF exposure and cancer has been demonstrated (Theriault, 1991; Walborg, 1991; NRPB, 1992).

7.3 EVIDENCE SUPPORTING CAUSAL ASSOCIATIONS IN EPIDEMIOLOGIC STUDIES

Statistical associations between environmental factors or anthropogenic agents and disease do not, by themselves, prove that the associated factors cause the disease. Such associations, when found, may simply be coincidental, or the factor being investigated may be related to the disease in a non-causative manner. Epidemiologists have established guidelines that are used to assess whether an agent or environmental factor may be causally related to disease. These derive to some degree from the work of Koch (1882) and have been extended by Hill (1953). The following listing is adapted from a report of the Surgeon General's advisory committee report on smoking and health (PHS, 1964), which discusses what is termed the "causal significance of an association" and maintains that a determination of causality is a judgment that extends beyond any statement of statistical probability.

Characteristics that have been suggested for determining causal significance, as applicable to the EMF studies, may be summarized as follows:

Consistency: Implies that diverse methods of investigating an association will lead to similar results and conclusions regarding an association.

Strength: Refers to the risk for disease for groups exposed to an agent compared to the risk for groups not exposed, assuming that the groups are matched for age and other characteristics. The magnitude of this ratio is an indication of the strength of the association.

Specificity: Refers to the precision with which one component of an associated pair can be used to predict the other. For example, how often lung cancer predicts smoking or vice versa.

Temporal Association: Onset of exposure to the agent must precede appearance of the disease. In diseases known to have a latency period, this period should be taken into account when evaluating the strength of the temporal association.

Coherence (Plausible Mechanism): Hypothesis of causality is strengthened if exposure to the agent can increase disease incidence or severity by biological mechanisms that are known and understood.

While not specifically listed as one of these criteria, the concept of dose/response can be considered as an aspect of the specificity criteria, an important aspect in the EMF epidemiologic studies. Dose/response can be defined as evidence that increased exposure to a putatively causative factor, in terms of strength, concentration, quantity, or time, should be associated with increased disease incidence or severity. The lack of a clear dose/response relationship has been repeatedly cited as a weakness of the EMF epidemiologic studies.

7.4 OVERVIEW OF CANCERS LINKED TO EMF EXPOSURE

7.4.1 Carcinogenesis: The Process of Cancer

More than 80 such studies have appeared in the literature, and these authors suggest methods for a rigorous meta-analysis. Carcinogenesis is now viewed as a stochastic process comprising several stages, with certain of these stages occurring in sequence (Slaga, 1989). Each stage involves several events, the effects of which may be either reversible or non-reversible. Some of these events are signaled by occurrence of specific heritable changes in the cellular genome.

Early experiments in mouse skin cancer models (Berenblum and Shubik, 1947) led to the development of the two-stage, or initiation/promotion, model of carcinogenesis. In this model, initiation is a heritable mutation to the genome. Such mutations may lead to the activation of oncogenes or to the inactivation or inhibition of tumor suppressor genes. Ionizing radiation and certain chemicals are demonstrated initiators (many of these are also complete carcinogens).

Promotion may comprise both genetic and epigenetic processes which allow the initiating event to be expressed eventually as malignancy (Figure 7-1). In the classical two-stage experiment, initiation is accomplished with a single application of a chemical carcinogen such as DMBA. If the dose is sub-carcinogenic, then tumors will not form without subsequent, usually repeated, application of the promoter (Figure 7-2). Application of a promoter such as TPA prior to, or in the absence of, initiation will not affect development of cancer.

Epigenetic factors such as increases in circulating steroidal hormone levels (Blask 1990), stimulation of cell proliferation (Ames and Gold, 1990), inhibition of DNA methylation, increased chromosomal instability, and inhibition of normal cell-to-cell interaction, especially those involving intercellular transport of small molecules via gap junctions, can increase the risk of progressing the initiated cell, or its progeny, to malignancy (Walborg, 1991). Agents that interact to affect any of these epigenetic processes can lead to increased cancer risk. Depending on the biological activity of such agents, or how they are used in the laboratory or encountered in the environment, they may be designated as promoters, co-promoters, or co-carcinogens.

Since ELF and static magnetic fields are of insufficient energy to cause direct chemical damage to DNA, it is now generally accepted that these fields are not mutagenic and are

unlikely to be initiators of carcinogenesis. Therefore, if ELF magnetic fields do affect cancer risk, it is likely that they do so via one or more epigenetic processes or by effects on the immune system (Figure 7-3).

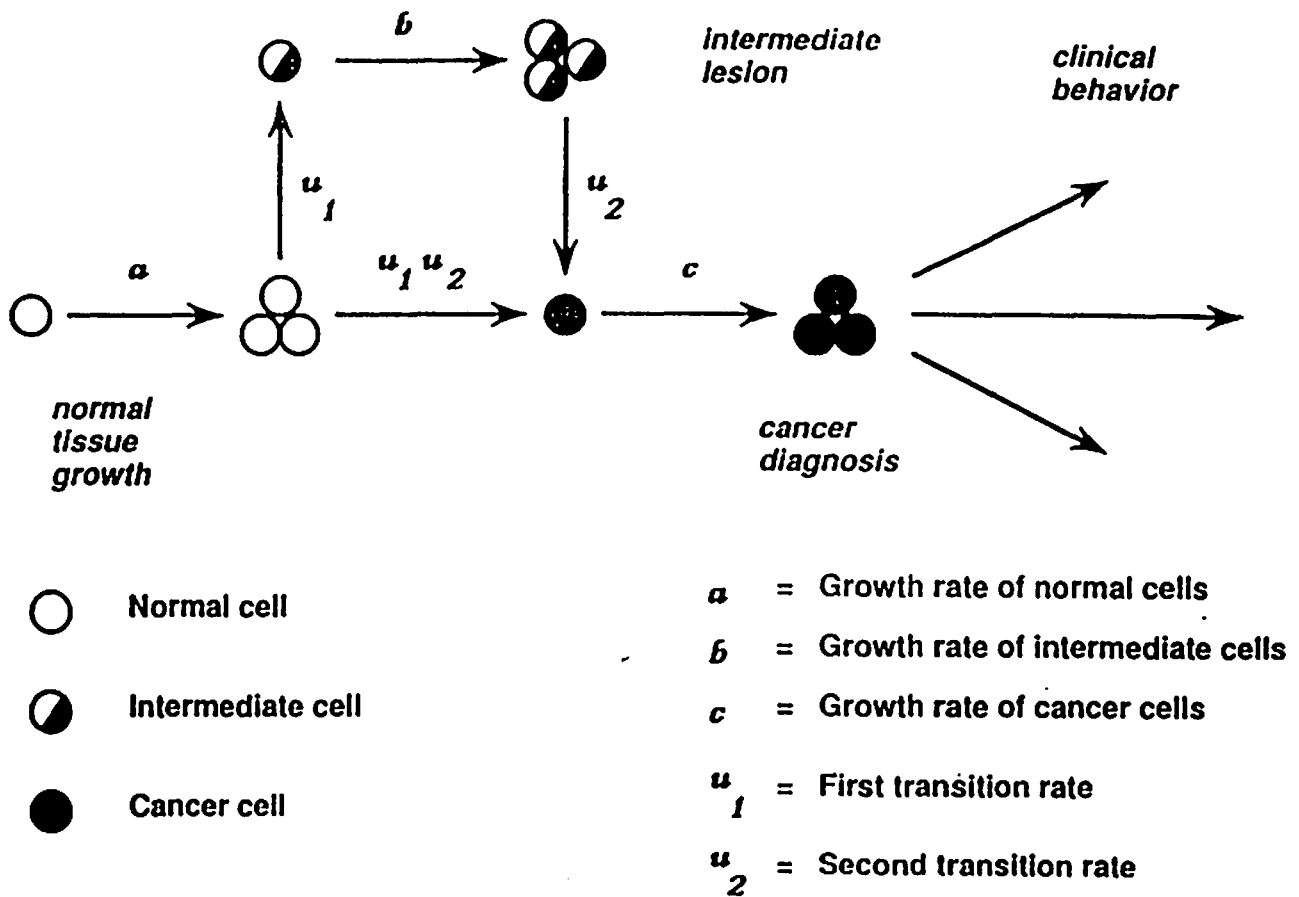

Figure 7-1. The model for cancer incorporates growth characteristics of normal cells ("a"), intermediate cells ("b"), and cancer cells ("c"). It also incorporates transition (or "mutation") rates " u_1 " and " u_2 ." Agents that affect growth of cells, transition rates, or clinical behavior will influence the risk of dying of cancer, although the biological mechanisms for these various effects may be very different.

(a)

Promoter	Initiator	Promoter →	Tumor
None	Sufficient dose	None	YES
Large Dose	None	Repeated Dose	NO
None	None	Large Dose (Repeated)	NO
Large Dose	Low Dose	None	NO
None	Low Dose	Repeated Dose	YES

(b)

Initiator	Promoter	Co-Promoter →	Tumor
YES	YES	NO	YES
YES	YES	YES	Increased
Low Dose	NO	YES	NO

Figure 7-2. (A) tumor outcomes for various combinations of initiators and promoters in animal experiments; (b) expected outcomes for initiation promotion experiments when a co-promoter is used.

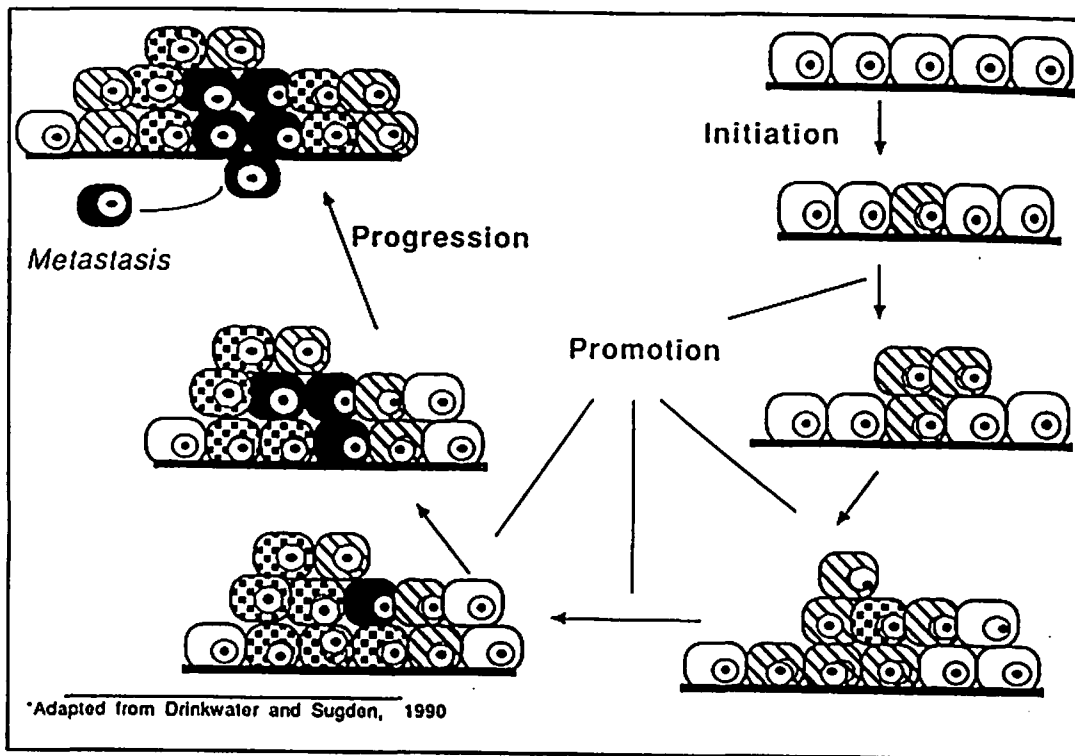

Figure 7-3. Cellular changes that occur in the carcinogenic process, beginning with initiation of normal cells (white) and continuing through promotion and progression to metastasis. Note that malignant cells (solid black) which eventually have the ability to leave the original tumor site and grow elsewhere are phenotypically different from cells immediately after initiation.

7.4.2 Cancers Linked to EMF Exposure

As an introduction to the epidemiologic studies reviewed here dealing with cancer, we briefly describe the various cancers that have been cited by qualified authors as having an association with EMF exposure or exposure surrogates. Factors known or suspected to increase risk for these neoplasms are mentioned, where such information is available.

Epidemiologic studies considered here may be classified as either cohort or case-control. In cohort studies, a group or groups of individuals are defined prior to the appearance of the disease under investigation. This study group is then observed over a period of time to determine the incidence of a given disease within the group. In case-control studies, two groups are defined in terms of whether they have or do not have the disease under investigation. Cases of a specific disease (case group) are sought out within a population and are compared with a group who are matched for such factors as race, age, sex, and socioeconomic status, but who do not have the disease under investigation (control group). An effort is then made to determine if exposure to the suspect agent was different between the two groups as a whole.

7.4.2.1 Leukemia. Leukemias are neoplastic diseases that result from the clonal expansion of hematopoietic cells. Cancer registries commonly classify leukemias as either acute lymphocytic (ALL), chronic lymphocytic (CLL), acute myeloid (AML), chronic myeloid (CML), monocytic (ML), "other," or "unspecified" (Hosfeld, 1990). Ionizing radiation, benzene exposure and chemotherapeutic agents, certain retroviruses, and congenital disorders associated with chromosomal breakage are known risk factors for leukemia. Onset of the overt leukemia can occur fairly soon (within 2 years) after ionizing radiation exposure and 5-7 years after the first chemotherapy course of treatment. Leukemia accounts for some 3% of all cancers with remarkably little international variation in incidence rates.

ALL is believed to arise from clonal expansion of lymphoid progenitor cells. ALL is primarily a disease of childhood, mainly affecting children younger than 15 years of age, with a peak between ages 2 and 4. Incidence in males is approximately double that in females. Rates of this disease in children have remained fairly constant. Mortality is decreasing, however, presumably because of improved treatment.

In acute myeloid leukemia, malignant transformation may occur at different stages of stem cell development. The hierarchy of cell differentiation continues to function in this leukemia, although immature (blast) cells from different lineages tend to accumulate. AML is generally considered a curable neoplasm, although patients who exhibit a loss of chromosomes 5 and 7 in the affected cells have a poor prognosis. Such patients generally have a history of exposure to ionizing radiation or leukemogenic chemicals. Treatment consists of aggressive chemotherapeutic treatment to reduce blast cell populations followed by consolidation and then by maintenance chemotherapy.

While ALL is primarily a disease of childhood, chronic lymphocytic leukemia is a disease of the elderly. In over 95% of cases, CLL results from clonal expansion of B-lymphocytes. CLL patients often remain asymptomatic in early stages of the disease and are often diagnosed during routine blood workup procedures. No therapy is considered curative for CLL, although radio- or chemotherapy may be useful in alleviating specific symptoms later in the course of the disease.

A specific acquired chromosomal abnormality, the "Philadelphia" chromosome, is strongly linked to chronic myelocytic leukemia, with more than 95% of diagnosed cases exhibiting this translocation (review by Hammond, 1990). Other chromosomal changes may also be seen in these patients. Bone marrow transplantation is the only effective therapy for CML patients. Survival rates with use of this therapy decrease with age, and it is not recommended for patients over 50 years old. Chemotherapy, while not curative, is often employed as a useful palliative treatment.

7.4.2.2 Neuroblastoma. Neuroblastomas are solid tumors arising from the adrenal glands or other tissue in the sympathetic nervous system. Tumors are most commonly found in the abdomen or thorax. There is a genetic component to the disease. Familial patterns in incidence are becoming more apparent as treatment improves and survivors of the disease grow to have children of their own. Approximately 75% of neuroblastomas are diagnosed in children under 5 years of age. If detected at an early stage, surgery to remove the primary tumor is the recommended treatment. Metastasis of the primary tumor often involves the

liver, lung, or bone, in which case chemotherapy is indicated. Spontaneous regression of neuroblastoma has been reported.

7.4.2.3 Brain and Central Nervous System Cancers. Approximately 50% of cancers in the central nervous system (CNS), including both gliomas and astrocytomas, arise from glial cells. Other cancers of the CNS include meningeal cancers, cancer of the neuroendocrine organs, and secondary tumors from metastasis of systemic cancers, especially those of the breast, lung, and gastrointestinal tract.

Although tumors of CNS origin may be classified as malignant, they metastasize only rarely to sites outside the CNS. Distinctions between malignant and benign tumors are less definitive in prognosis of CNS tumors than for systemic tumors. Slow-growing, infiltrating tumors of the CNS, for example, although technically benign, may be inoperable when diagnosed and are therefore often fatal.

Malignant gliomas can suppress immune system function. They also apparently employ several strategies to escape detection by the immune system. For example, they direct amplified expression of specific oncogenes to attain resistance to the body's natural defenses against cancers. These include resistance to tumor necrosis factor. Patients suffering from malignant gliomas have a generally poor prognosis. Exposure to ionizing radiation and head trauma are known risk factors for gliomas and astrocytoma (Mack et al., 1991).

7.4.2.4 Breast Cancer. Breast cancer in males is rare, with men contracting the disease at a rate far less than 1 case per 100,000 population. Breast cancers may be hormone dependent, with tumors elaborating estrogen and progesterone receptors and requiring estrogen for continued growth and proliferation. Histologically, most male breast cancer is essentially the same as estrogen receptor positive breast cancer in females; the tumors are hormone dependent in both instances (Sherman and Hossfeld, 1990).

In women, the breast is the most common site for cancer, and breast cancer is the leading cause of death for females in some countries. There is wide international variation in breast cancer incidence. Rates in North America and Great Britain, for example, are substantially higher than rates in countries such as Japan and Venezuela. Environmental factors are implicated in this variation in breast cancer incidence; increased rates are seen in groups who have migrated from low-risk countries to those with higher risk. For example, women of Japanese descent living in Hawaii show rates approximating those of the United States and not Japan.

Risk factors for breast cancer include familial history of the disease, especially in a mother or sister, early age at menarche, late age at menopause, and late age at birth of first child. Dietary intake of fat has also been investigated as a possible risk factor; however, epidemiologists disagree about the importance of dietary fat as a risk factor.

In the United States, the incidence of this disease in women is approximately 9%; about 1 in 10 women will eventually be diagnosed with breast cancer. Rates in the United States are rising, but known risk factors do not appear to account for the increase (Stevens et al., 1992). Estrogen receptor positive breast cancer appears to be increasing at a much greater

rate than the estrogen receptor negative form of the disease. Hormonal factors have been suggested as the most likely reason for the differential increase (Glass and Hoover, 1990).

Melatonin may play a role in the etiology of breast cancer in humans. Melatonin is protective against breast cancer in rodents (Blask, 1990) and inhibits growth of breast cancer cells in vivo. Tamarkin et al. (1982) have suggested, based on clinical studies, that "the absence of nocturnal peak melatonin may serve as a biochemical marker for increased risk of estrogen positive breast cancer."

7.4.2.5 Melanoma. Melanoma is a cancer of the pigmented melanocyte cell, which is derived from the neural crest and normally migrates to the skin during development. Although less frequent, migration of these cells to the mucous membranes and the nervous system is also evident. Primary melanoma is normally a disease of the skin and as such may be detected by simple visual examination. With early detection, the cure rate can be as high as 80%. Untreated, however, melanoma is one of the most dangerous of cancers, and once metastasis has taken place, prognosis is poor.

Melanoma rates are increasing worldwide. In the United States, incidence has doubled every 15 years since 1930. Incidence is highest in light-skinned populations. Blacks rarely contract melanoma, and when they do, it is normally on the lighter skin on the soles of the feet or the palms of the hand. Melanoma risk increases with increased exposure to direct sunlight, especially that encountered at lower latitudes. There is evidence from laboratory studies that both human and animal melanomas may be steroid-responsive cancers (Stanbury et al., 1983). Melanoma is one of the few cancers for which complete spontaneous regression has been observed clinically, suggesting that some immunologic process may be important in the etiology of the disease. There is also evidence that melatonin is protective against melanoma (Narita et al., 1985).

7.4.2.6 Lymphomas. Lymphomas are malignant diseases of lymphoreticular cells and are thus related to the leukemias. The two are coded closely in International Classification for Disease (ICD) (i.e., lymphomas are coded line break 200-201 and leukemias are coded 204-207). Two main classes are recognized: Hodgkins disease (HD) and non-Hodgkins lymphoma (NHL). A great variety of diseases are grouped under NHL, owing to the diversity among the immune cells from which these neoplasms arise. As in the leukemias, chromosomal translocations are found in most lymphomas, especially in NHL. Risk of lymphoma is increased in immune-compromised individuals (Gatti and Good, 1971).

Epstein-Barr virus infection is strongly suspected, though not proven, as an etiologic factor, especially in Burkitt's lymphoma. Most common among symptoms is swelling of the lymph nodes. Diagnosis requires lymph node biopsy. Radiotherapy is the treatment of choice in lymphomas, and high cure rates can be achieved with early detection.

7.4.2.7 Prostatic Cancer. Prostatic cancer is an important cause of morbidity and mortality among middle-aged and elderly men in developed Western countries. In the United States, incidence in blacks is about twice that in whites. U.S. rates overall are about 40 times those observed in Japan. In the United States, approximately 1 in 10 men will develop clinically evident carcinoma of the prostate. Incidence of the disease is underestimated in the overall

population because many tumors are considered benign hyperplasia or remain asymptomatic and are detected only upon post-mortem examination. Malignant prostatic cancers are hormone dependent.

While the causes of prostate cancer are not well understood, environmental factors are implicated because rates increase in migrants moving from low incidence areas to higher incidence areas. Epidemiologic studies that have looked at socio-economic status, sexual practices, and venereal disease as possible risk factors have been inconclusive. Hormonal influences have been well established; however, prostate cancer is not found in men castrated before puberty.

7.5 EPIDEMIOLOGIC STUDIES LINKING EMF AND CANCER

7.5.1 Use of Surrogates for EMF

Early EMF epidemiologic studies, both residential and occupational, distinguished "exposed" or "higher exposure" groups from "non-exposed" or "lower exposure" groups by the use of surrogates for EMF. These surrogates reflect indirect estimates rather than direct measurements of the magnetic fields. In the residential studies, the surrogate used was the configuration of electrical service wires outside the home known as the Wertheimer/Leeper wiring code (Wertheimer and Leeper, 1979). The wiring code is categorical with five levels of imputed exposure from low to high based upon the numbers of transmission and distribution wires near the home, their gauge, distances to these wires, and whether or not they are buried.

In occupational studies, the surrogate used most often was job title. In some later studies such as that of Savitz et al. (1988), spot magnetic field measurements were made. Later studies, such as London et al. (1991) and others not yet completed, will include data from both spot and longer term magnetic field measurements in the home or work environment.

Some investigators have suggested that the surrogate measures, although crude, are more stable than short-term measurements, and therefore may be more indicative of long-term exposures. There is also the possibility that the surrogates are indicative of some aspect of magnetic field exposure that is more closely associated with increased risk than is the time-weighted average 60 Hz field. (Measurements of field strength done in studies to date are used to estimate a time-weighted average exposure at 60 Hz.) Others have suggested that the surrogates in the residential studies may reflect risk factors (as yet unknown) other than magnetic field exposure.

In all of these studies, measurements of the fields or estimates of the fields based on surrogates were made after the occurrence of the disease. Prospective epidemiologic studies, wherein field exposure is measured before the disease occurs, are currently being planned or are underway. Because field levels preceding the disease will be known in these studies instead of inferred from later measurements, the outcome of these studies will be important in eventually determining if a causal link exists between EMF exposure and cancer.

7.5.2 Residential Studies.

Although exposure assessment in EMF epidemiologic studies has been generally inadequate, many have interpreted data from these studies to suggest that the magnetic field component of EMF may be more strongly associated with increased cancer risk than is the electric field component. While measurements have generally shown a weak association between magnetic field strength and risk, no association has been found between measured electric fields and risk.

Wertheimer and Leeper (1979) reported that increased childhood leukemia was associated with magnetic field exposure in a study which considered the size and proximity of outside electrical power lines to the residences of cases and controls. This early study eventually led to serious consideration of the hypothesis that magnetic fields may be correlated with cancer risk.

Severson et al. (1988) studied adult leukemia as a function of wiring code and measured magnetic field in Seattle. This study showed no effect of the fields. As a component of this study, Kaune et al. (1987) found that center of room measurements for household magnetic fields for homes in the Seattle study were generally below 1 mG.

Savitz et al. (1988) performed residential magnetic field measurements under conditions of low power (wherein power to the home was switched off) and high power (wherein all home appliances and lights were turned on). Magnetic field measurements were stratified into four categories ($< 0.065 \mu\text{T}$; 0.065 to $< 0.1 \mu\text{T}$; 0.1 to $0.25 \mu\text{T}$; and $> 0.25 \mu\text{T}$). There was an elevated but not statistically significant correlation to observed cancer rates when data were analyzed using these categories. Nonsignificant increases in cancer were observed when comparing households in the lowest category to those in the upper three categories under low power conditions (odds ratio: 1.28-1.49). Trend tests for these comparisons were, however, significant.

London et al. (1991) studied childhood leukemia in relation to wiring codes and measured magnetic fields in cases and controls in Los Angeles County. While their data provided little support for an association between measured household 60 Hz magnetic fields and childhood leukemia, there was evidence for an association between wiring code and childhood leukemia (Table 7.1). This study also found evidence of an association between use of certain electrical appliances by children and childhood leukemia. These appliances included hair dryers, black and white television sets, and electric blankets.

Lovely and colleagues (1992) hypothesized that, if magnetic field exposure were related to leukemia risk, then the use of personal electrical appliances that were operated in close proximity to the body, and in essentially the same manner on a daily or periodic basis, should be correlated with the incidence of this cancer in adults. Accordingly, they reviewed reported use of 28 appliances for approximately 114 leukemia cases and their controls from the data set of Severson et al. (1988). The hypothesis was that one or more of the appliances used closest to the body (i.e., electric razors, hair dryers, and hand held massage units), would be correlated with increased leukemia risk.

Results of this analysis indicated that, of these appliances, electric razor use was statistically significantly correlated with leukemia risk in men. Relative risk in this study was estimated at 2.15 for those who had reported an average of 5 minutes or more per day of electric razor use. Risk appeared to increase with increasing reported time of daily use, and the trend persisted when social economic status, smoking (overall increased risk), and reported allergies (overall decreased risk) were taken into account.

Magnetic field flux density and spectral measurements made on electric razors manufactured during the time period of assumed critical exposure for these cases showed that they generated fields of 4,500 mG (0.45 mT) or more at the surface that contacted the face. Both time and frequency domain analyses showed that the 110 VAC models generated signals with frequencies in the greater than 100 kHz range. It was noted that these fields were of sufficient flux density to induce electric fields in biological tissue well above those due to normal metabolic processes.

In a study of approximately 500,000 people in Sweden who lived within 300 meters of high voltage power lines (220 and 400 kV), Feychting and Ahlbom (1992) found a positive correlation between proximity to the lines and leukemia risk in children. Based on historical line load data and magnetic field models, exposures were calculated for nearly half a million residences near the lines. For a subset of the study subjects, 24-hour spot magnetic field measurements were also taken in the residence.

Based on the calculated fields, the risk ratio for childhood leukemia increased between 1.0 and 2.0 mG, and was estimated at 2.7 (statistically significant) for flux densities of 2.0 mG and greater. When considering residences calculated to have fields greater than 3.0 mG on average, the relative risk increased to 3.8 with a corresponding trend test p-value of 0.005. This study found a slight (relative risk 1.7) but non-significant increase in adult leukemia incidence for residences with higher fields. There was no observed increase in brain tumor risk or in the risk for all cancers combined for either children or adults.

No correlation was found between cancer incidence and magnetic fields as determined by the 24 hour spot measurements in a subset of the residences. The correlation between calculated fields and disease held for single family residences but not for multi-family dwellings. No increase in brain tumor risk was observed in this study.

Overall, when measured in residential epidemiologic studies, magnetic field strengths in the home have generally shown weaker correlations with actual cancer incidence than do classifications such as wiring code or proximity as used to model field flux densities in the Feychting and Ahlbom study. Table 7-1 lists the estimated relative risk for childhood leukemia in three residential studies, as related to wiring code, spot in-home magnetic field measurements, and 24-hour in-home measurements.

Bowman et al. (1991) have recently reported a re-analysis of the London et al. (1991) data designed as a test of the quantum resonance theory hypothesis. Two different dc magnetic field strengths (380 mG and 506 mG) that would be anticipated to be resonant for calcium ions in combination with a 60-Hz ac field were arrived at empirically. Static magnetic fields, arising primarily from the earth's geomagnetic field, were measured at the homes of

Table 7-1. Relative risks for childhood leukemia. Reported by Wertheimer and Leeper (1979), Savitz et al. (1988), London et al. (1991) and Feychting and Ahlbom (1992) residential studies, as they relate to magnetic fields estimated by wiring codes, spot measurements, and 24-hour measurements.

		Study Authors				
		Wertheimer & Leeper, 1979	Savitz et al., 1988	Feychting et al., 1992	London et al., 1991	
		Relative Risk	Relative Risk	Relative Risk	Relative Risk	
Metric					Metric	
Wiring Code						
UG+VLCC	1.00	1.00			1.00	
OLCC		1.10			0.90	
OHCC		1.30			1.40	
VHCC	3.00	2.50			2.10	
Spot Measurements (milligauss)					Spot Measurements (milligauss)	
< 0.65		1.00			< 0.6	1.00
0.65-1.00		0.90			0.67-1.24	1.40
1.00-2.49		1.40			> 1.25	1.20
> 2.50		2.10				
Calculated Flux density (milligauss)					24-hour Measurement (milligauss)	
≥ 2.0				2.70		
≥ 3.0				3.80		
					< .68	1.00
					0.68-1.18	0.70
					1.19-2.67	0.90
					> 2.68	1.50

cases and controls. When only homes within the resonance intervals centered about 380 mG or 506 mG were considered, the calculated odds ratios for leukemia risk were increased compared to those for all cases versus controls (although the numbers of cases within the resonance intervals were relatively small). Furthermore, within these intervals, the authors reported an increase in incidence with increased 60 Hz magnetic field strength. Thus, the authors contend that they have provided preliminary evidence that the quantum resonance model may be valuable in interpreting epidemiologic studies and in understanding the mechanisms for effects of EMF in humans.

7.5.3 Occupational Studies

Occupational studies have looked at cancer risks to workers in industries, occupations, and specific job categories presumed to involve EMF exposure (e.g., electricians, power line workers, and electrical transport workers). Some of the later studies have measured

magnetic fields encountered in some job categories using a personal dosimeter (EMDEX) or other field measurement devices. To date, however, most epidemiological studies of occupation and risk of cancer have relied upon job description to impute a "high" or "low" exposure.

Before discussing the occupational studies, we mention two important caveats with regard to the value of these data in inferring a cause and effect relationship between the fields and cancer risk. Most important, the magnetic fields were, in most cases, not directly measured. Also, much of the information cited on occupation and cancer risk comes from studies not originally designed to assess the effects of EMF exposure. There is likely to be an important reporting bias in these studies, because those investigators who find effects when re-analyzing their data sets for EMF-related disease incidence are more likely to report results than are those who find no effects.

Magnetic fields have been measured in conjunction with several of the studies reviewed in this section. Fields associated with specific job classifications were measured either by on-site measurements after the fact, or by fitting healthy workers currently engaged in those jobs with personal dosimeters.

A study of male New York telephone workers by Matanoski et al. (1989 and 1991a) used detailed employment and mortality records for some 1.5 million employed and retired workers during the years 1976 to 1980. The study showed elevated risks of "all cancers" in one of four job categories thought, *a priori*, to have high EMF exposure compared to other workers in the telephone-worker cohort. Specific cancer types that showed a "significant" excess in at least one of the four presumed high-exposure job categories were leukemia, oral cancer, lymphomas, prostate cancer, and breast cancer.

These researchers then measured actual magnetic field exposures on a sample of men in each job category. Among 56 men in the job category (cable splicers) with a significant increased risk of cancer, the full-shift time-weighted average magnetic field exposure was 4.3 mG (the geometric mean was 3.2 mG). The next highest average was 2.6 mG (the geometric mean was 2.1) in the job category in which prostate cancer was elevated and in which two cases of breast cancer appeared. The average magnetic field exposure among a sample of 43 men in job categories not thought to have high EMF exposure was 1.6 mG.

Bowman et al. (1988) also made actual magnetic field measurements in the work environments of people in occupations that were reported by Savitz and Calle (1987) to have increased leukemia risk. The geometric mean 60-Hz magnetic fields in 67 occupational settings designated as used by "electrical workers" was 4.64 mG, with a range of 0 to 621. Transmission station operators and overhead linemen had the highest exposures according to this study. Deadman et al. (1988) also studied occupational EMF exposure, but used a field meter that was worn by volunteer subjects throughout their work day. They compared exposures in presumed exposed job categories to exposures in presumed nonexposed jobs. The geometric mean 60-Hz magnetic field among 20 subjects in "exposed" jobs was 16.6 mG; among 16 subjects in "nonexposed" jobs it was 1.6 mG.

Table 7-2 is a partial listing of those occupational epidemiologic studies in which authors reported a statistically significant ($p < 0.05$) elevation in risk for one or more cancers. As noted earlier, there are a number of epidemiologic studies that did not show an association between EMF exposure and increased cancer risk.

Table 7-2. Epidemiologic Studies by Occupation/Magnetic Field. Occupational epidemiologic studies that reported statistically significant elevations in one or more types of cancer in jobs thought to involve increased EMF exposure. Where several cancers or exposure categories are reported in a single paper, the highest statistically significant measure of risk is listed.

Category Author/Type	Job/Exposure Source	Endpoint	Rel. Risk
Electric Transport			
Tynes & Anderson, 1990/Cohort	Electrical Occupations (Electric Tram Drivers)	Breast Cancer	2.07 12.00
Howe & Lindsay, 1983/Cohort	Transport Workers	Leukemia	1.68
Balli-Antunes et al., 1990/CC	Electric Engine Drivers	Leukemia/ Lymphoma	1.73
Telecommunications			
Matanoski, 1989/Cohort	Cable Splicers	Leukemia All Cancers	7.00 1.81
Matanoski, 1991a/CC	Cable Splicers	Breast Cancer	6.00
Vagero, 1990/Cohort	Telephone Operators	Melanoma	12.03
Demers, 1990/CC	Telephone Linemen	Breast Cancer	6.00
Juutilainen et al., 1988/Cohort	Electrical Occupations (Probable Exposure)	Leukemia	2.40
Electric Utility			
Speers, 1988/CC	Electric Utility Employees	Brain Cancers	13.10
Savitz, 1990/CC	Electric Power Repair	Brain Cancer	2.40
Demers, 1990/CC	Electric Power Workers	Breast Cancer	6.00
Milham/1982 + 1985/Cohort	Power Station Operators	Leukemia	2.26
Wright, 1982/Cohort	Power Company Linemen	AML	1.90
Linnet, 1988/Cohort	Electrical Power Linemen	CLL	1.90
Mack et al., 1991	Power Line Workers	Brain Cancer	3.40
Floderus et al., 1992/CC	Electric Utility Employees (Sweden)	CLL	3.72

Table 7-2. Occupational epidemiologic studies that reported statistically significant elevations in one or more types of cancer in jobs thought to involve increased EMF exposure. Where several cancers or exposure categories are reported in a single paper, the highest statistically significant measure of risk is listed. (cont'd)

Category Author/Type	Job/Exposure Source	Endpoint	Rel. Risk
Radio Communications			
Demers, 1990/CC	Radio Communications Workers	Breast Cancer	2.90
Milham, 1988/Cohort	Amateur Radio Operators	AML	1.76
Calle & Savitz, 1985/Cohort	Radio and Telegraph Oper.	Leukemia	2.35
Welding*			
Preston-Martin et al., 1982/CC	Electric Welders	CML	25.4
Stern et al., 1986/CC	Welders	ML	3.83
Aluminum Reduction			
Milham, 1982 + 1985 Cohort	Aluminum Potroom Workers	Lymphoma	2.60
Mining			
Gilman et al., 1985/CC	Miners/Electric Trolleys	Leukemia (Chronic L.)	2.53 8.22
Military			
Garland et al., 1990/Cohort	Navy Electrician's Mate/Radioman	Leukemia	2.40
Electrical Occupations			
Bastuji-Garin et al., 1990/CC	Occupations with Field Exposure	Leukemia	4.04
Vagero et al., 1983/Cohort	Electronics Industry	Melanoma	1.35

* Stern (et al. 1986) has reviewed available epidemiological studies on electric welders, and has concluded that the association between welding as an occupation and increased leukemia is very weak .

To investigate specifically the risk of acute myelogenous leukemia in the New York telecommunications worker population, Matanoski et al. (1991b) used a case-control design to compare field exposures of 124 men (cases) who died of AML to that of 337 controls matched by age, year of hire, and region. Direct magnetic field measurements were made with workers currently employed in the same job categories as the cases and controls. Indices of field exposure determined included time-weighted average exposure, exposure to fields above a certain level, and the average magnitude of peak exposures.

The latter index of exposure was the only one that showed a statistically significant correlation to increased risk for AML in these workers. The association between peak exposure and AML risk was strengthened when a 10 to 15-year latency period between initial peak exposures and onset of disease was taken into account. Spectral analysis of magnetic fields was made in the areas where this group worked. The fields arose primarily from telephone switching equipment, and the analysis showed that they could best be characterized as "spiky."

A case control study of electrical workers in Sweden supports the hypothesis of an EMF link with chronic lymphocytic leukemia (Floderus et al., 1992). Extensive magnetic field characterization (more than 1000 sets of measurements) was carried out in the various work environments, and included use of personal dosimeters. In this study, CLL incidence increased monotonically with percent time spent above 0.2 μT , and became statistically significant for groups determined to spend more than 29% of their work time in such fields. At greater than 29% of time in fields greater than 0.2 μT , age adjusted relative risk was 2.42, increasing to 2.53 for greater than 39%. Risk also increased monotonically with increasing flux density. Age adjusted relative risk for exposure to fields equal to or greater than 0.41 μT was 3.72 (95% CI: 1.79-7.74).

More than 1,600 persons were included in the study which considered 250 leukemia cases and 261 brain tumor cases. These investigators found no increased risk associated with magnetic field exposure for other types of leukemia nor for brain tumors.

7.5.3.1 Occupational Studies on Central Nervous System Cancer. In a number of case-control studies, elevated brain cancer incidence rates have been associated with occupations believed to have greater exposure to EMF. As discussed earlier, where measurements have been made, electrical occupations do tend to have greater exposure to EMF than those classed as non-electrical. In the course of a study by Lin et al. (1985), an independent panel of experts classified occupations as involving definite, probable, possible, and no excess exposure to EMF. In this study, there appeared to be a dose-response relationship between the exposure gradations and risk for gliomas and astrocytomas, but not for unspecified brain tumors.

Speers et al. (1988) reported an odds ratio of greater than 13:1 for risk for gliomas among electrical utility employees. Among electrical engineers in New Zealand, Pearce et al. (1989) found a 4.47 fold increased risk for brain tumors. Mack, et al. (1991) found excess astrocytomas in electrical occupations for those employed longer than 10 years. These three were case-control studies.

With regard to CNS cancers, cohort studies have shown lower risk ratios and have been less likely to indicate statistically significant excesses for brain cancer than have case-control studies. However, several of the more recent cohort studies (since 1990) have also shown relative risks greater than 1 that were statistically significant. Studies finding statistically significant increases in CNS tumors are included in Table 7-2.

7.5.3.2 Occupational Studies on Malignant Melanoma. Increased risk of malignant melanoma has been noted in several epidemiologic studies of electrically exposed workers. From a cohort study of telecommunication workers in Sweden, Vagero et al. (1985) noted a statistically significant relative risk (SMR=2.5) for malignant melanoma of the skin in telecommunications workers. Of all cancers considered, only melanoma and nodular lymphoma were increased in males. Melanoma was also increased in females (SMR=2.8). In a 1985 report, Vagero and colleagues noted excess skin melanoma in electronics industry workers. Again in 1990, excess melanoma was reported by Vagero in telecommunications workers. A study of telecommunications workers in Canada by De Guire et al. (1988) indicated an increased risk for melanoma in men (SIR = 2.7) but not women. Swerdlow et al. (1983) found increased melanoma of the eye for electronics and electrical workers in the United Kingdom. Gallagher (1985), however, found no increased melanoma in electronics or electrical workers in western Canada. It has been pointed out that excess melanoma in electronics and telecommunications workers may be a consequence of their generally higher socioeconomic status (Swerdlow, 1990).

7.5.3.3 Occupational Studies on Male Breast Cancer. Association of increased risk for rare cancers with a specific agent can lend considerable weight to the evidence on whether the agent may be a carcinogen. Male breast cancer is such a disease, and thus studies that suggest an association between EMF exposure and this cancer are of particular interest to many epidemiologists. They are also of interest here because one of the key occupational studies suggesting male breast cancer risk included electrical transport workers among the exposed cohort. Stevens (1987) and Stevens et al. (1992) suggested that increased male breast cancer risk may result from EMF-induced changes in melatonin synthesis and release by the pineal gland. To date, three epidemiologic studies that considered male breast cancer have been reported. Results from each have been consistent with this hypothesis.

From a cohort study in Norway, involving some 38,000 workers and some 800,000 occupational man-years, Tynes and Anderson (1990) have reported greater than expected breast cancer rates in males working in designated electrical occupations. Overall, the risk ratio for male breast cancer in the combined electrical occupations grouping was 2.07. Significant to this report were the risk ratios for certain of the specific occupational groups within these electrical occupations. Electrical tram operators, for example, had an apparent 12-fold increase in their risk of breast cancer, the highest among the specific job classifications analyzed. Although we could find no information concerning detailed characteristics of the magnetic fields in the tram drivers' environment, the fields are likely to be intermittent owing to the frequent changes in electrical motor load. The fields are also likely to have occasional broad spectrum content because of commutator arcing in the electrical drive motors.

Demers et al. (1990, 1991) compared exposures based on job category for 227 male breast cancer cases and 300 controls. This study was conducted specifically to test the Stevens (1987) hypothesis and designed to determine if EMF exposure was linked to increased breast cancer risk. Highest risks (OR = 6.0, CI:1.7-21.5) were found for those in the electrical occupations described as electricians, telephone linemen, and electric power workers. A second related category with putatively increased exposure to higher frequency fields was

classified as radio and communications workers, and this group also showed an increased risk (OR=2.9, CI:0.8-10.2). The consolidated exposed group in these studies was also calculated to have an increased risk (OR=1.8, CI:1.0-3.2) compared to assumed non-exposed job categories.

Matonoski et al. (1991a, b) published findings of higher than expected breast cancer risk in a study of a large telephone workers cohort. Obtained in conjunction with this work, but not yet published, were spectral analyses of the magnetic fields in several of the work environments for job categories considered in the study. Highest risk for breast cancer was noted among office workers, who were in many cases exposed to spiky fields generated by switching equipment.

7.5.3.4 Occupational Studies on Lymphomas. Several epidemiologic studies have linked elevated lymphoma mortality with electrical occupations, including that of electric railway engine drivers (discussed earlier). Most striking among these is a series of studies showing an apparent substantial increase in risk of non-Hodgkins lymphoma in aluminum reduction plant pot-room workers. Originally reported from studies of workers in Washington State by Milham (1976) and subsequently by Davis and Milham (1990), increased NHL risk has also been reported by another group (Spinelli et al., 1989) that surveyed workers in a Canadian aluminum reduction plant. In the latter study, authors reported an 8-fold increase in risk of hematopoietic diseases.

High D.C. magnetic fields (estimated to be in the 100 Gauss range) are present in the pot-rooms during reduction operations. These arise from current usage in the tens of thousands of amperes. Imposed on the D.C. field is a 360 Hz ripple byproduct of full-wave rectification of three-phase 60-Hz power. Anodes used in the Soderberg process are of a paste made of carbon and coal tar pitch. During the "baking" of the anodes, done in place in the Soderberg process, coal tar volatiles are released into the pot-room atmosphere. These authors note that the coal tar pitch volatiles concentrations in pot-room atmospheres are lower than those associated with coke oven operations, an industry in which excess lung cancers are seen but not excess lymphomas. Polycyclic aromatic hydrocarbons associated with coke oven operations are a known risk factor for lung cancer but not for lymphoma. An additional potential confounding factor in these studies is the high ambient temperature in the pot-rooms.

Davis and Milham (1990) reported that at least 5 cases of B-cell lymphoma had occurred among employees of an aluminum reduction plant where only 0.2 cases would have been expected. From a study of 23 volunteers, the authors showed that, as a group, those who had ever worked in the pot-room showed an approximate doubling of T8 (mean =1,227) cell counts as compared to those who had never worked in the pot-room (mean=597). The authors concluded that the elevated T8 cell counts and abnormal T8/T4 cell ratios suggested an underlying immune system alteration in the pot-room workers. They suggested that alteration was associated with the high magnetic field present in the pot-room relative to other areas in the plant.

7.6 MOOD DISORDERS AND CIRCADIAN FUNCTION LINKED TO EMF EXPOSURE

7.6.1 Overview

"Mood disorders" is a general term that is now preferred to the term "depression" in denoting a range of manifestations of which sustained depression or extreme elation are the most common. Clinical mood disorders comprising depressive syndromes and mania represent the common final stages of a number of psychopathological processes. Although diagnostic criteria may vary in specific details, clinical depression is generally characterized by three or more of the following pathological processes: sustained depressed mood, impairment of normal work functions, impairment of social and intimate relationships, irrational and exaggerated erosion of self-esteem, specific changes in vegetative functions such as appetite and sleep, and appearance of non-specific physical complaints.

Milder forms of depression, often classified as reactive, arise in response to a stressful life event or profound grief. Depression symptoms may result from another illness or disorder or from use of specific drugs or medications. Endogenous depression is that which cannot be associated with adverse life events or other external factors. It is therefore often presumed to have an organic or biochemical component and is so treated.

It is now widely acknowledged that both psychological and biochemical factors are likely to be important in the etiology of mood disorders. Patterns of hormone secretion are often disturbed in affective disorders; however, for the most part, hormone therapy has not been valuable in managing these disorders. Pharmacologic treatments aimed at altering neurotransmitter synthesis and function are now commonly used as a first line of treatment. Distinctions between unipolar and bipolar depression, for example, are important in terms of the pharmaceutical treatments prescribed.

Unipolar depression is defined as sustained pathological depressive mood state; it is distinguished from bipolar depression in that the latter is characterized by alternating elation (mania) and depressive episodes. Cyclicity is often a hallmark of mood disorders (von Zerssen, 1983). Cases exhibiting very precisely timed transitions from mania to depression have been reported (Dirlich et al., 1981). Such observations have led to hypotheses regarding the etiology of depressive illness wherein alterations in circadian rhythms in secretions from the hypothalamic-pituitary-adrenal (HPA) and HP gonadal (HPG) axis are studied as possible causative and contributing factors (Moline and Wagner, 1987). The latter axis is involved in changes in the daily cycles of gonadotropins and gonadal steroid secretion, both associated with depression in men and women. Increased circulating levels of both estradiol and testosterone have been reported in depressives (Vogel et al., 1978). Changes in circadian rhythms are often associated with depression (Wehr and Goodwin, 1983). Such changes may be manifest as sleep disturbances or as alterations in neurotransmitter cycles or cortisol synthesis.

A specific form of winter depression, SADS, is now widely recognized as being closely tied to biological rhythms. The disorder is found predominantly at higher latitudes where

day-length between winter and summer days is more pronounced. Sufferers experience profoundly depressed mood, accompanied by carbohydrate craving and additional need for sleep in the fall and winter months. These symptoms disappear in the spring and summer months. Exposure to light of sufficient intensity can suppress melatonin in humans (Lewy et al., 1980), and there is evidence that depressive patients may be much more sensitive to light in this regard than non-depressed individuals (McIntyre et al., 1990). Light therapy (exposure to bright lights during the day), which has the effect of shifting the timing of the nightly melatonin peak, is the therapy of choice for this disorder (Lewy et al., 1987).

Dexamethasone-induced suppression of cortisol as a means of diagnosing depression is of interest in the context of the melatonin hypothesis discussed below. In normal individuals, administration of the artificial steroid dexamethasone suppresses cortisol levels. It has been found that such suppression rarely occurs in patients with major depression. The dexamethasone suppression test (DST) has thus become valuable as an objective criteria in diagnosis of depression (Cobolov and Rubin, 1987). Wetterberg et al. (1984) and Beck Friis et al. (1985) have proposed that measurement of circulating melatonin levels may also be of use in diagnosing certain types of depression. They reported on clinical studies wherein lower levels of melatonin in the circulation were associated with major depression.

Lifetime risk for all clinical depression is estimated at 12% for men and 18% for women. Rates in females are higher for milder forms of depression. The incidence of manic depressive disorders in women is about the same as that for men. Mood disorders are the most prevalent psychological disorder, accounting for approximately 25% of institutionalized patients, approximately 40% of mental facility outpatients, and about 70% of all diagnoses in psychiatric medical practice (Kandel et al., 1991).

Known causes for, or contributing factors to, symptomatic depression include certain pharmaceuticals, such as steroidal contraceptives and reserpine, infectious diseases such as mononucleosis, endocrine dysfunction, neurological disorders including stroke and sleep apnea, nutritional disorders such as pellagra, and certain CNS neoplasms. Primary risk factors include heredity, stressful life events, introverted passive-dependent personality type, and childhood loss of a parent.

Increased incidence in women may be due to one or more of several factors. Women have an additional X-chromosome which may be important if dominant X-linkage is associated with bipolar depression. Women also commonly use steroid contraceptives, undergo more endocrine changes in their life cycle than do men, and have higher levels of monamine oxidase, the enzyme that degrades neurotransmitters (including serotonin) important in mood.

Of primary interest in the context of EMF exposures are the pre-clinical symptoms of depression, including dysphoria, headache, inefficient or disturbed sleep, carbohydrate craving, etc. It should also be noted that suicide risk is substantially increased for depressive patients. At least one study (discussed below) suggests a link between EMF exposure and depression as determined by suicide incidence.

7.6.2 Epidemiologic Studies Considering Mood and Affect

Results from at least three epidemiologic studies have suggested an association between EMF exposures and depressive illness. In an early study, Perry et al. (1981) and Perry and Pearl (1988) studied populations living in housing projects in the United Kingdom. They reported a positive correlation between magnetic field levels in individual apartments and increased incidence of depression. Reichmanis et al. (1979) noted an apparent increase in depression, as determined by suicide rates, in populations that lived near overhead transmission lines. This variation was statistically significant, and other environmental factors considered in homes studied did not appear to confound the results. Wilson (1988) has reviewed both human and laboratory animal data on EMF exposure as it may relate to mood changes and depression and suggested that EMF-induced changes in pineal melatonin may be a factor in increasing risk for these disorders.

Poole et al. (1992) reported that persons living closer (within view) of power transmission or primary distribution lines were more likely to report headache and other depressive symptoms than were people living further away from (not in view of) the lines. In this study involving some 900 subjects, the association between reported proximity to power lines and depressive symptoms was statistically significant ($p < 0.01$). Of particular interest in this study, the authors took extensive measures to control for possible confounders.

7.7 EPIDEMIOLOGIC STUDIES CONSIDERING ELECTRIC BLANKET USE

Of special interest when considering the metric of intermittency in magnetic field exposure are studies that determined associations between adverse health outcomes and electric blanket use. As discussed below, electric blanket exposure is intermittent. Most electric blankets manufactured before 1989 generated magnetic fields, close to the blanket surface, in the 30-300 mG range (Florig and Holberg, 1990). However, more recent studies by Wilson et al. (1992) suggest that internal body fields are much lower than those measured at the blanket surface or as estimated from modelling studies. In a study that compared laboratory and field measurements of flux densities at a distance of 10 cm from the blanket (mid-torso), these investigators found that the mean exposure was between approximately 4.5 and 7.5 mG, depending on blanket type.

Electric blankets commonly operate on a duty cycle, typically being switched on for approximately 40-100 seconds, then off for about the same time or longer, depending on the blanket controller setting and room temperature. These blankets thus represent exposure that is intermittent, of relatively long duration, and of relatively high field strength, compared to ambient household magnetic fields. Considering the daily duration of their use, these blankets probably constitute the greatest single daily magnetic field exposure source for most individuals who use them. It should be noted that since 1989 electric blankets have been available that employ effective magnetic field cancelling designs.

Wilson et al. (1990) reported changes in melatonin excretion in volunteers who used modified electric blankets. At onset of exposure, there was a short-lived increase in excretion of the urinary metabolite 6-hydroxy melatonin sulfate. This was followed by a

general decline in urinary excretion of this melatonin metabolite as exposure continued (for up to 12 weeks). At cessation of exposure, there was again a short-lived (5-8 day) increase in melatonin production. The magnitude of this increase was substantially higher than that of the first increase, and in some subjects was 4-5 times the amount measured on the evening before cessation of exposure.

Several studies have associated various reproductive effects with electric blanket use. First among these was a case-control study of more than 1700 births in Colorado by Wertheimer and Leeper (1986). They reported that a prolonged gestation period, low birth weight, and early fetal loss were more likely if the mother reported electric blanket or heated water bed use. In a second study, the use of ceiling installed electrical heating was also considered, along with that of electric blankets and electrically heated water beds. In this study, the earlier observation of early fetal loss associated with use of these electrical devices appeared to be confirmed. A prospective epidemiologic study, currently being conducted in California, will address this question of EMF exposure and miscarriage (Lee et al., 1992). Data on urinary gonadotropins and other indicators of pregnancy status are being collected for this study, and data from this study should be valuable in reducing the uncertainty regarding EMF and miscarriage.

In a study published in 1990, Savitz et al. reported that electric blanket use by the mother was associated with an increase in brain cancer in the offspring. In the more recent study on childhood leukemia by London et al. (1991), cases were seven times more likely to use electric blankets than were controls. However, this odds ratio was unstable because of the small number of parents (seven cases and one control) reporting electric blanket use in children. Vena et al. (1990) found no increase in breast cancer in post-menopausal women who used electric blankets. Relative risks associated with electric blanket use, as determined by epidemiologic studies, for several health outcomes are shown in Table 7-3.

Lee et al. (1992) have developed an exposure metric that reflects the amount of change or intermittency for longer term magnetic field exposure measurements. This metric, which is based on the absolute difference between consecutive (every 10 second) field levels as determined by a personal dosimeter, provides a measure of the total amount of change in magnetic field amplitude per unit time. This metric has been applied to measurement data from over 200 women in the California Women's Reproductive Health Study. The rate of change metric has a stronger association with electric blanket use, and an apparently stronger correlation with birth outcome, in this study than does the time-weighted average metric.

Table 7-3. Epidemiologic studies that determined effects of electric blanket use on various health outcomes.

Study Authors	Endpoint	Odds Ratio > 1
Wertheimer & Leeper, 1986	Fetal Loss Childhood Brain Cancer	(YES) (YES)
Wertheimer & Leeper, 1986	Fetal Loss	(YES)
Savitz, et al., 1990	Childhood Leukemia	(YES)*
London et al., 1991	Childhood Leukemia	(YES)*
Vena et al., 1990	Female Breast Cancer (Post-Menopausal)	(No Effect)
Verreault et al., 1990	Testicular Cancer	(No Significant Effect)
*Non-significant		

7.8 STUDIES ON VIDEO DISPLAY TERMINAL (VDT) USE

Schnorr et al. (1991) recently completed a study that considered VDT use and reproduction. Results showed no statistically significant effects. The study was prompted in part by anecdotal reports of miscarriages associated with long-term daily VDT use. Several well-done studies of possible EMF effects on reproduction have reported no effects in rodents (Anderson, 1991).

More recently, Hietanan (1992) has reported that VDT users exposed to magnetic fields in the 4-9 mG range had nearly twice the incidence of miscarriage as women exposed to VLF fields at strengths below 4 mG. These authors stated that the effect was seen only when exposures were classified according to measured magnetic field strength.

7.9 EPIDEMIOLOGIC STUDIES RELATED TO ELECTRIC TRANSPORT WORKERS

Epidemiologic studies concerning a possible association between cancer risk and magnetic field exposure that include data on workers in the electrically powered transportation sector include studies by Balli Antunes, et al. (1990); Tynes and Anderson (1991); Tynes et al., (1993); Baroncelli et al. (1986); and Nakagawa et al. (1992). Findings from the first two of these studies have been discussed previously, and results from all studies are summarized in Table 7-4.

Table 7-4. Data from epidemiologic studies of workers in the electrically-powered rail transport sector, and a comparison of estimated or measured magnetic field characteristics for respective electrically-powered transport systems, where such data were available.

Country	Flux Density & Operating Freq.	Epidemiologic Findings	Authors
Italy	Reported Mean: 15 μ T 50 Hz	No increased health risk found in screening studies	Baroncelli et al. (1986)
Norway	Reported range: 8 -880 μ T 16.67 Hz	No increase in leukemia or brain tumors	Tynes et al. (1993)
Norway	Reported range: 8 -880 μ T 16.67 Hz	Increased male breast cancer	Tynes and Anderson (1991)
Switzerland	Estimated Max. by Authors: 1000 μ T 16.67 Hz	Increased risk of combined leukemia and lymphoma	Bali-Antunes et al. (1991)
Japan	No exposure data reported.	No increase in cancer risk	Nakagawa et al. (1992)

Several studies of railroad workers in the epidemiologic literature provide cancer incidence data related to EMF exposure surrogates. The report by Tynes and Anderson was concerned with male breast cancer and is discussed in Section 7.5.8. The second (Balli-Antunes, 1990) is a study from Switzerland which ascertained malignancies of the hematopoietic and lymphatic systems (MHLS) for the job classification of railway engine drivers. Authors noted that the entire Swiss railway system has been electrified for some 70 years, and hence the job classification used was a legitimate surrogate for exposure. MHLS included all leukemias and "other" hematopoietic diseases as well NHL and Hodgkins disease. Authors of this report observed 70,000 man-years for the electric engine drivers and compared these to two control groups. Relative risk compared to the first group (C1) was 1.44 expressed as a PMR. Compared to the second group (C2), the relative risk was 1.63 (PMR=163; C1=103-244). Standard mortality ratio compared to C2 was 171. In this study, exposure was to a 16.6 Hz field estimated to be on the order of "several tens of Gauss." The authors noted that railway engine drivers have relatively low mortality overall, and suggested that EMF exposure was a plausible explanation for the observed elevation in MHLS incidence.

In Italy, an epidemiology study was performed comparing health status among electrically exposed workers who were separated into three groups according to mean weekly duration of exposure to the maximum magnetic field flux density encountered on the system which was determined to be in the 15 μ T range. These exposures came from proximity to interconnection or conversion substation equipment. In the system are 244 conversion stations that convert 220 kV ac to 3 kV dc and 14 interconnection substations that connect the main power grid to the rail system power network and convert 220 kV ac input to 132 kV ac and 3 kV dc output.

In the Italian study, worker groups were composed of 224 subjects in the 20 hr per week exposure category, 153 subjects in the 10 hr per week category, 117 subjects in the 1 hr per week category, and 133 in the no-exposure-to-maximum-field-per-week category. Health exams were performed that included hematologic, electrocardiogram, and physiologic tests. Socioeconomic status and smoking habits were taken into account. All four groups comprised healthy subjects, and the specific analyses did not reveal any differences between groups in terms of the health parameters surveyed. The authors concluded that exposure to magnetic field of moderate strength did not affect the physiologic parameters determined in these workers.

Nakagawa and colleagues (1992) have reported on mortality of non-executive cohorts of male workers from 1968-1985. The cohort consisted of six groups classified according to job title. Standard Mortality Rates (SMR) for these cohorts were generally below the national average for Japan. When malignant neoplasms were considered, the six groups have SMRs of 0.69, 0.6, 0.54, 0.85, 0.69 and 0.84, respectively. In summary, this study indicated that SMR workers generally lived longer than the national average and that, among SMR job classifications, jobs that involved greater exposure to magnetic fields did not show increased rates of malignancy or mortality.

Tynes et al. (1993) have recently reported data on approximately 13,000 railroad workers in Norway in a nested case control study in which they compared risk of leukemia and brain tumors in individuals who worked primarily on electrified sections of the system to those who worked on the non-electrified sections where engines were diesel powered. The authors report that approximately one-half of Norway's railroad system is electrified. Among these workers, 52 cases of leukemia and 39 brain tumor cases were ascertained.

Electrified sections of the Norwegian rail system operate at a frequency of 16.67 Hz. Magnetic field flux densities to which this group were exposed ranged between 8 and 880 mG. No difference in risk was found between the risk of either leukemia or brain tumors between groups who worked on electrified as compared to diesel-powered sections of the rail line. Additionally when groups were stratified according to exposure as determined by job title and spot measurements, there was no apparent dose response relationship between the risk of either of these cancers and magnetic field exposure as determined by the methods employed.

7.10 CONCLUSIONS

Primary frequencies for fields that have constituted the exposure of interest in epidemiologic studies include 0, 16.67, 50, and 60 Hz. Increased risk for one or more neoplasms has been reported for exposures involving each of these frequencies. Insufficient information is currently available to allow any kind of rank-ordering of these frequencies in terms of increased risk as suggested by epidemiologic studies. (It should be noted, however, that for the 0 Hz case, field strengths encountered were substantially higher than in other occupations or residential settings considered and commonly extended into the 100 G range.)

Thus, with the exception of the report by Bowman et al. (1991) that local geomagnetic field strength affected risk of leukemia in a subset of homes from the London et al. (1991) study, epidemiologic studies do not provide data that support the magnetic-field-based mechanism hypotheses. This lack of supporting evidence may arise from the lack of data on the frequency characteristics of the field exposures in question.

Cancers associated with EMF exposure have some common characteristics. Based on animal models or human studies, for example, melatonin appears to be protective against the cancers associated with EMF exposure in epidemiologic studies. The brain cancers are an exception; as far as could be determined, no data on the effects of melatonin on these cancers have yet been published. Estrogen receptor positive breast cancer and prostate adenocarcinoma are among the endocrine cancers. These two require estrogen and testosterone, respectively, for growth and proliferation.

Increases in risk for lymphomas as a consequence of EMF exposure may be consistent with the hypothesis that EMF exposure has a suppressive effect on immune function. Lymphoma incidence is known to be increased in immuno-compromised individuals (Gatti and Good, 1971). Immuno-suppression in the case of EMF exposure may arise via reduction in melatonin synthesis, or by direct action on T-cells such as suggested by in-vitro studies of Lyle et al. (1988).

Based on observations in the laboratory and consideration of the human cancers putatively associated with EMF exposure, investigators have proposed a number of possible biological mechanisms whereby EMF exposure may affect cancer risk. Stevens (1987) and Wilson et al. (1989) have proposed that, regardless of the fundamental physical mechanisms by which biological systems interact with the fields, physiological mechanisms explaining how exposure could affect cancer risk may include inhibition of melatonin synthesis and secretion leading to reduced concentrations of a humoral oncostatic factor (melatonin), increase in circulating levels of gonadal steroids and prolactin, or inhibitory effects on immune function. Stevens et al. have also suggested that EMF may exacerbate oxidative stress in cells via changes in normal calcium metabolism.

Adey (1990) has proposed that EMF exposure may increase cancer risk by mechanisms involving alteration in intercellular and intracellular communication, including inhibition of gap junction formation and function and changes in transmembrane signaling leading to changes in gene expression. Walborg (1991) has added to this list possible specific cellular mechanisms including inhibition of DNA methylation, enhancement of chromosomal

instability, and direct stimulation of cell proliferation. Ames and Gold (1990) have pointed out that increased cell proliferation may render tissues more susceptible to malignant transformation. They suggest that mitogenic agents may increase cancer risk in this way.

Conclusions regarding the possibility that EMF exposure may affect cancer risk in humans are remarkably consistent among reviewers from the fields of cancer epidemiology and cellular carcinogenesis. We present here a set of conclusions representing those from reviewers in the field (Nair et al., 1989; Theriault, 1991; Walborg, 1991; Stevens et al., 1992), as well as those from recent deliberations of the EPA Science Advisory Board Subcommittee on Non-Ionizing Electric and Magnetic Fields (NIEMF) Subcommittee.

As demonstrated experimentally, EMF exposure can affect several biological processes that could enhance development of cancer in initiated cell populations. On the cellular level, these processes include changes in RNA transcription and cell proliferation. Observed effects that may be related to these changes include alterations in calcium ion mobility, intercellular exchange (via gap junctions) of small molecules, intracellular signaling as determined by changes in enzyme production, and impaired function of immune system cells.

At the level of the intact organism, changes in neuronally mediated and neuroendocrine function have been observed, including alterations in heart rate, circadian rhythms, and pineal gland function. The latter two may affect cancer outcome owing to resulting increases in circulating gonadal steroids and prolactin and changes in humoral and cell-mediated immunity.

Several government agencies in the United States and Europe have prepared documents that review and interpret EMF epidemiologic data. One objective of these reviews has been to determine if, taken as a whole, the epidemiologic and laboratory studies provide evidence of a cause and effect relationship between EMF exposure and cancer risk. Among these agencies are the U.S. EPA and the British National Radiation Protection Board (NRPB). In each case, these government agencies and the experts who prepared or reviewed the documents have found that evidence is insufficient to conclude that a cause and effect relationship exists between EMF exposure and the risk of any cancer.

A recently published NRPB document concluded that evidence is sufficient only to form hypotheses to be tested in further studies (NRPB, 1992). The U.S. EPA Science Advisory Board, after review of the EPA draft document on EMF and cancer, concluded, in part, that:

... the epidemiologic evidence is suggestive of an association between surrogate measurements of magnetic-field exposure and certain cancer outcomes...the existence of confounders is always a possibility, but since no common confounder has been identified, the existing evidence cannot be dismissed. Absence of much better exposure information,... an understanding of which exposures are significant, and no precise exposure-dose relationship, together with limited understanding of ...mechanisms, weakens the inference of cancer causality...

Based on results from the Feychting and Ahlbom (1992) and the Floderus et al. (1992) studies, however, the Swedish National Board for Industry and Technical Development (NUTEK) has decided that future policy will be based on the assumption that "there is a connection between exposure to power frequency magnetic fields and cancer, in particular, childhood cancer" (MWN 1992).

7.11 SUMMARY

Epidemiologic studies have linked EMF exposure, as determined mainly by surrogate measures, to increased risk for a number of cancers as well as possible increased risk of mood disorders and miscarriage. Whether there is indeed a link between these disorders and actual EMF exposure, and whether such a link, if found, is a causal one, remains to be determined. However, much of the laboratory data available on biological effects of EMF exposure appear consistent with the reported health effects.

In residential studies on childhood leukemia, incidence exhibits either a weak association or no association, with 50 or 60 Hz magnetic field flux densities as measured in the residences of cases and controls. In each study where an association has been found, the strongest correlation with leukemia incidence was proximity to high current wires external to the residence, regardless of whether proximity was determined by wiring code on a house by house basis, or by ascertaining incidence in all homes near certain power lines as in the Swedish study (Feychting and Ahlbom, 1992).

With regard to adult leukemia in the residential studies, the Swedish study found a slight but non-significant increase with proximity to power lines, and the other published study showed no effect. Lovely and colleagues reported a statistically significant correlation between leukemia risk and use of electric razors by men. It is of interest that where such information has been gathered in the residential studies, there is evidence of a correlation between personal appliance use and leukemia risk, and in contrast, no evidence for an association between adult leukemia and EMF exposure as determined by wiring code.

Based on data from clinical and laboratory studies as well as indications from epidemiologic studies, broad spectrum field characteristics, both in terms of frequencies from 0-3 Hz, as well as higher frequency components, appear to be more effective in eliciting biological response than are purely sinusoidal fields at similar amplitudes. Where actually characterized, in occupational epidemiologic studies, spiky fields or intermittent high-strength fields appear to be associated more strongly with cancer risk than are measures of time-weighted average exposure to 60 Hz fields. More broad band spectral characterization of magnetic fields is needed to determine specifically what frequency or temporal characteristics of the fields, if any, are most strongly associated with disease incidence.

There are a number of consistencies between the epidemiologic data in terms of cancers that are associated with EMF exposure and the laboratory data that address the issue of biological effects of EMF. For example, a common attribute among the cancers associated with EMF is that the hormone melatonin appears protective against many of them. Thus, the effects of

EMF exposure on melatonin, as demonstrated in numerous reports, may be significant in terms of cancer risk.

Another consistency is between the effects on immune system cells and the increased incidence of lymphomas. Risk for the latter cancers is known to increase in individuals who have immune systems that have been compromised by immunosuppressive drugs, by radiation exposure, or by acquired immune deficiency syndrome (AIDS). Reported behavioral effects of EMF exposure are consistent with observed changes in Ca^{++} mobility and other excitable cell effects as discussed in Chapter 5. As pointed out in the previous chapter, induced phase shifts in the melatonin rhythm are also consistent with changes in circadian rhythms and, in turn, with reported increased risk of depressive symptoms and miscarriage.

Temporal aspects of magnetic EMF exposure in terms of clock time have received little attention in epidemiologic studies. A possible exception is electric razor use, which probably occurs predominantly during a short time period in the morning or evening on a near daily basis. Electric transport for those who use it to travel to work also has a strong periodic component. Clock time and periodic use of transport may be of interest with regard to the neuroendocrine effects of EMF exposure. As shown in Chapter 5, the effects of stimulation to the neuroendocrine system can be highly dependent on clock time or circadian phase. Thus, the relative importance of night time exposure as compared to daytime exposure, for example, or of highly periodic exposure as compared to random time exposures, should probably be ascertained in appropriate laboratory studies.

Government agencies or their select committees in the U.S.A., the U.K., and Holland who have reviewed the EMF literature for evaluation as to a possible cause and effect relationship between EMF and cancer have stated that there is presently insufficient evidence to conclude that such a relationship exists. However, it should be noted that these conclusions were reached before results from the two recent Swedish studies were made public. Currently stated policy of the Swedish government, based in large part of results from the Feychting and Ahlbom (1992) and Floderus et al. (1992) studies, is that future decisions regarding siting and construction of power lines will be made under the assumption that magnetic field exposure may increase risk of leukemia.

8. MAGLEV MAGNETIC FIELDS AND EMF-ASSOCIATED BIOLOGICAL EFFECTS

8.1 SYNOPSIS

This chapter considers the various attributes of magnetic fields that appear to influence responses in biological systems. The discussion takes into account proposed biophysical and physiologic mechanisms in addressing the question of what may constitute dose in EMF bioeffects. The various proposed mechanisms for signal detection and physiologic response are then considered as to their possible relevance to magnetic fields as measured for the TR-07 maglev and other electrically-powered transport systems.

8.2 INTRODUCTION

Gaining an understanding of which EMF characteristics are responsible for various biological effects observed in nature and in laboratory studies is critical to the study of possible health effects from EMF exposure. It appears unlikely that there is a single field attribute that determines response in all biological systems. Rather, there is evidence that various biological systems respond to different field parameters, and often do so in a fairly specific manner. Such specificity can be found in many areas of the literature on EMF interactions with living systems and has been discussed throughout this document.

8.3 SPECIFICITY IN RESPONSE TO EMF EXPOSURE

Early reports of changes in calcium ion flux in response to EMF exposure included observations of windows of response that were frequency dependent. Observation of a frequency dependent or frequency windowed response in a biological system may result from either the physiologic mechanisms or biophysical mechanisms involved.

In humans, for example, the magnetic field required for perception of visual phosphenes, as mediated by the retina and the optic tract nerves, shows a frequency dependence (Tenforde, 1991). Minimum flux densities required to produce the phenomenon are observed when the frequency of the magnetic field is between approximately 20 and 30 Hz. Frequency of the ELF signal component also appears important in a number of other human responses. Magnetic-field-induced changes in EEG (e.g., Bell et al., 1991) and MEG, (Anninos et al., 1991) also suggest that frequency is an important attribute in eliciting physiological response. Other EMF effects in humans showing frequency dependence is stimulation of bone growth (Pilla 1974) and effectiveness of low-energy emission therapy for treatment of insomnia (Hajdukovic, et al., 1992).

With regard to stimulation of bone growth, Pilla et al. (1985) have also identified a frequency-related magnetic field parameter, the time-rate-of-change of a pulse leading or trailing edge, as important in this effect. Likewise, Lerchl et al. (1991) has identified the

dB/dt characteristics of the switched (pulsed) dc magnetic field as important in determining pineal response in animals.

In laboratory experiments, frequency dependence has been reported for a number of phenomena. Calcium-dependent diatom mobility was enhanced by exposure to a 16 Hz magnetic field when these organisms were placed on a calcium-depleted agar medium (Liboff, et al., 1990). In other experiments, mitogen-stimulated rat lymphocytes exposed to a combination of a 16 Hz sine wave at 42 μ T and a static magnetic field at 23 μ T, showed an inhibition of calcium ion influx. Exposure of the cells to either field alone was without effect. Exposure of the rat lymphocytes to a 60-Hz, 22-mT field enhanced, rather than inhibited, calcium uptake following mitogen stimulation.

In the literature on EMF are many more examples of frequency-dependent responses. Those cited here suffice to illustrate that bimodal responses (inhibitory/stimulatory) have been observed that are frequency dependent, that frequency-dependent phenomena have been observed in human responses to EMF, and that both physiologic (e.g., perception of phosphenes) and physical mechanisms (e.g., resonance-condition dependent uptake of calcium ions by diatoms) can be involved in determining frequency specificity.

Amplitude is another attribute of magnetic fields that has been observed to be specific for a number of responses. Amplitude specificity may be manifest in terms of windows, thresholds, and dose/response relationships. All have been observed. In humans, EMF-induced changes in heart rate exhibit an amplitude window between approximately 100 and 400 mG. While precisely measured thresholds are not common in the literature on EMF, there are a number of examples, including the work of Liburdy (1992) who recently reported that 60 Hz magnetic fields of 12.4 mG antagonize the cytostatic effects of melatonin in MCF-7 cells, while the same fields at 4.5 mG had no effect. Liburdy also has provided evidence for flux density dose-response in in-vitro studies, and showed that the observed effects in this system were due to the induced electric field.

In in-vivo studies, reports of McLean et al. (1990), and Beniashvilli et al. (1991) provide examples of dose response, both in terms of flux density and total time of exposure. In these studies, animals exposed to higher flux density fields experienced more skin papillomas and mammary cancers respectively than animals at lower or control flux densities. In the Beniashvilli studies, longer daily exposure times (3 hr/day as compared to 30 min/day) also resulted in shorter latency, higher incidence, and higher tumor burden.

Intermittency of field presentation enhanced the slowing of the heart rate in humans by 60 Hz magnetic and electric fields, and intermittency is also an important field characteristic in determining effects of EMF on event-related brain potentials and other performance measures in humans (Cook et al., 1992). Other results from human studies (e.g., Wilson et al; 1990) are consistent with the hypothesis that intermittency may be an important field attribute. Intermittency on the seconds to minutes time scale can be considered as contributing frequency components below the ELF range.

With regard to intermittency, it has suggested an exposure metric based on the concept that it is change in field state that is an important determinant of effect. The underlying concept

here is that the external field affects homeostasis and that changes in such fields require an adaptive response by the organism. Rapid changes or repeated changes may tax the adaptive capability of the organism, leading to a stress response. Kavet (1992) has proposed that intermittency be somehow assessed in future epidemiologic studies. Lee et al. (1992) have evaluated a rate of change metric for assessing exposure from electric bed heating devices in conjunction with an epidemiologic study on miscarriage.

Coherence of the time-varying magnetic field is another attribute that has been proposed as being important to eliciting certain effects. Litovitz (1992) asserts that cells and tissues can detect and respond to signals that are coherent in that the same information reaches cells for a certain minimum period of time. Thus, in this model, a pure sinusoidal 60 Hz signal that is coherent and has a duration of approximately 10 seconds or more will elicit a response. Coherent signals that last for substantially less than this time will have no effect according to this model.

Phase-locking to the input signals demonstrated in the *Aplasia* neuron is an observed phenomena cited as being consistent with this model. In phase-locking, the aplasia neuron will consistently fire near the positive peak of a sinusoidal input signal, so long as the signal frequency is near that of the natural firing rate of the cell. Doubling the input signal frequency often results in the firing of the neuron to coincide with every other peak in the sinusoidal signal. Coherence theory predicts that there would be no response to a constant amplitude signal that altered between 50 Hz and 60 Hz at a constant a rate of more than once every 10 seconds or so, and that there would be a response to either of the signals if unaltered.

As illustrated by these examples, especially those from human studies, it is important to consider the spectral attributes of the electric and magnetic fields in attempting to determine what constitutes dose. Frequency, intermittency, coherence, flux density, and time-rate-of-change for pulsed fields are among the spectral characteristics that have been identified as important in various biological systems for which EMF effects have been studied.

8.4 MAGNETIC AND ELECTROMAGNETIC EFFECT MECHANISMS

At a fundamental level, possible metrics for dose related to magnetic fields may be classed as either magnetic or electromagnetic. What we will term the *magnetic* mechanisms assumes that the primary effect arises from coupling of the magnetic field with magnetic moments in biological tissue. In these models, the magnetic field affects, for example, the motion of charged species such as divalent cations or energy states of free radicals through Zeemann processes, thus influencing free radical concentrations and their roles in promoting other biochemical reactions.

Some have proposed that the magnetic field acts directly to distort the normal conformation of receptors or other large proteins that have biological function which is dependent on tertiary structure or shape. Among the magnetic force models are several which hold that such parameters as ac magnetic field frequency and intensity and ambient dc field intensity are determinant. These are often termed resonance models.

In what have been termed the *electromagnetic*, or *induced current* models, also termed *Faradayic* models, biological effect is assumed to arise from electrical fields and their resulting currents induced in biological tissue by the time-varying magnetic field. In these models, time-rate-of-change of the field, higher frequency content, ac field strength, and body dimensions are important parameters. When broadband field characteristics are considered, these processes may become relatively more important, because the magnitude of the induced electric field increases with frequency.

8.5 PROPOSED DOSE METRICS FOR ENVIRONMENTAL MAGNETIC FIELDS

A number of magnetic field attributes or combinations of attributes or parameters have been considered as possible determinant or important factors in the literature of observed EMF bioeffects. New definitions of dose continue to be proposed. Review of the literature shows that a number of characteristics of magnetic fields have been proposed as determinant, or important, in eliciting biological response. The following attributes have been suggested, and there are data in the literature that are at least consistent with each proposed characteristic. They are:

- time-weighted average exposure to the sinusoidal field
- time exposed to sinusoidal fields above a certain intensity threshold
- time-rate-of-change of the field
- intermittency or on/off nature of the field
- frequency or frequency content, especially of pulsed fields
- resonance characteristics:
 - ratio of magnetic field frequency to local ambient dc magnetic field strength
 - ratio of a combination of sinusoidal field frequency and field strength to local dc magnetic field strength
- temporal aspects of exposure:
 - periodicity, repetition rate
 - clock time or circadian phase characteristics
- coherence.

Table 8-1 provides (in the right-hand column) a few examples of reported effects that support, or are consistent with, the proposed dose metrics listed in the right-hand column. This list of possible dose metrics has many similarities with the list of possible effects functions proposed by Morgan and Nair (1992) as discussed above.

Table 8-1. Examples of studies consistent with each of seven selected dose metrics.

Dose Metric	Effect and Study First Author.
Time-weighted average magnetic field*	Childhood leukemia studies (Savitz, et al.; London, et al.) Skin tumor co-promotion (McLean et al.; Beniashvili et al.)
Intermittency / on-off nature of the field	Heart interbeat interval increase (Cook et al.) Human mental task performance (Cook et al.) Melatonin reduction in rats (Lerchl et al.)
Frequency / frequency content/ repetition rate	Bone growth stimulation (Pilla et al.) Transcription effects (Goodman et al.)
Clock time or circadian phase of exposure	Circadian activity rhythms (Groh et al.) Baboon blood melatonin levels (Rogers et al.) Hamster melatonin phase shift (Yellon et al.)
Resonance conditions (ac frequency and dc field flux density)	Radial maze performance (Lovely et al.) Calcium efflux (Blackman et al.) Re-evaluation of London et al. data. (Bowman et al.)
Peak field exposure	Leukemia in electrical workers (Matanoski et al.) Intensity dependent effects in co-promotion cancer studies (Beniashvili et al.; McLean et al.)

* for the epidemiologic studies; as estimated by proximity to power lines

8.6 MAGNETIC FIELD PARAMETERS AND DOSE IN INDUCED FIELD MODELS

Time-varying magnetic fields induce electric fields in biological tissue. It is important to establish whether the magnetic or the electromagnetic (electric field) component, or some combination of these two, is responsible for the bioeffect. With regard to the well-studied therapeutic application of bone growth stimulation, the induced electric field is clearly responsible for the effect, a conclusion supported by the similarity between effects of injected and induce currents. Similarly, nearly all of the in-vitro bioeffects described in Chapter 5 can be related to the induced electric field. Studies such as those by Liburdy et al. (1992) (see Chapter 4) clearly demonstrate that the induced electric field is the responsible stimulus.

With regard to these effects, the question reduces to a definition of the critical amplitude and spectral density characteristics of the induced electric field at the target site.

An equally important issue is the reactivity of the biological system to the exogenous field. Many results to date, from both clinical and in-vitro studies, suggest that biological systems are generally unreactive to weak EMF unless shifted from homeostasis by chemical stimuli, trauma, pathology, etc. Best known among the many examples of this phenomenon is the clinical bone repair application, in which only the repairing bone site is affected by EMF. The surrounding normal bone, which also detects a similar EM dose, is unaffected. Other examples include the absence of an effect of EMF on calcium uptake, unless cells are

stimulated with a mitogen. With this in mind, a brief outline of the signal and target characteristics that affect electric field dosimetry is presented below.

The following physical characteristics are among those that determine the amplitude and spectral density of the induced electric field in the target tissue:

- The maximum time-rate-of-change of the magnetic field (dB/dt) determines the peak E field at the target.
- The pulse shape determines its spectral or frequency content which may allow the dielectric properties of the target to be matched.
- The relative geometries of the EMF (coil position, polarization, etc.) and the target determine which part of the target receives the peak E.

The characteristics of the EMF signal on which the reactivity of a biological system may depend are:

- The periodicity or repetition rate which accommodates refractory times in the responding biochemical pathway(s).
- The total exposure time in one 24-hour period, relating to such processes as cell cycle, clock time, or circadian phase.

The characteristics of the target tissue which determine EMF sensitivity are:

- The maximum size of the induced current loop determines peak E. This means that, from the same source, peak E will be much higher in the brain than in the small toe.
- Isolated cells vs tissues or organs. The cell array tissue model clearly shows that cell-cell communication via electrically conducting gap junctions increases EMF sensitivity by several orders of magnitude vs a single cell exposed to the same EMF source.
- The biochemical and physiological state of the target. This means that the detected EMF signal may result in a bioeffect only if the target is not in a resting (maintenance) state.

8.7 MAGNETIC FIELD PARAMETERS DETERMINING DOSE IN THE DIRECT MAGNETIC EFFECT MODELS

Substantial data have accumulated from observations of animals in their natural habitat and from both *in vivo* and *in vitro* studies in the laboratory showing that the magnetic field may interact directly with magnetic moments in tissue to effect biological response. From the early work of Blackman and colleagues (e.g., 1985a,b) and of Liboff (e.g., 1990), there is also evidence that that the dc component of the magnetic field may be important in certain of

these responses. This view has given rise to the various resonance models as discussed in Chapter 4.

In the resonance models, it is the relative orientation, frequency, and flux density of the ac field relative to the dc field that gives rise to conditions wherein magnetic moments such as ions or unpaired electrons can couple to the field. According to these models, including the mechanisms suggested by Lednev (1991), certain combinations of these field parameters will be effective in affecting the motion of specific ions and others will not.

In the free-radical effects model (McLaughlin, 1991), the flux density of the magnetic field is the determinant parameter, and frequency, as long as it is in the ELF or quasi-static range, is unimportant. It is not clear that thermodynamic considerations such as inherent noise in the system is of much consequence in this model since the unpaired electron interactions are fast indeed (nanosecond range), and these electrons will interact with the external magnetic field in a manner based on spin orientation rather than on the translational (or thermal) motion of their associated radicals.

Thus, according to the various magnetic moment models, the following parameters may be of importance in determining dose:

- presence of the dc magnetic field
- orientation of the dc magnetic field
- flux density of the dc magnetic field
- frequency of the ac magnetic field
- flux density of the ac magnetic field
- duration of coherent exposure
- polarization of the ac magnetic field

8.8 EXPERT OPINION ON WHAT MAY CONSTITUTE DOSE

As an example of the various field attributes that have been proposed as important in determining dose from magnetic field exposure, we consider the recently published work by Morgan and Nair (1992). These authors used expert opinion in a structured workshop setting to review available data on EMF biological effects and determine what attributes of the fields or "effects functions" may be important or warrant further investigation as determinant parameters that may constitute dose.

Experts ranked the possible significance of seven possible effects functions as being "supportive," "consistent," "irrelevant," or "at odds" with six classes of observed biological effects as reported in the literature. Figure 8-1, adapted from their report, shows the relative importance attached to each of several field attributes as they may relate to these classes of biological effects. Frequency windows, of course, cannot be considered as a potential dose metric, but their observation was considered an important aspect of the literature on EMF exposure, and their possible relevance to the six classes of observed biological effects was at issue.

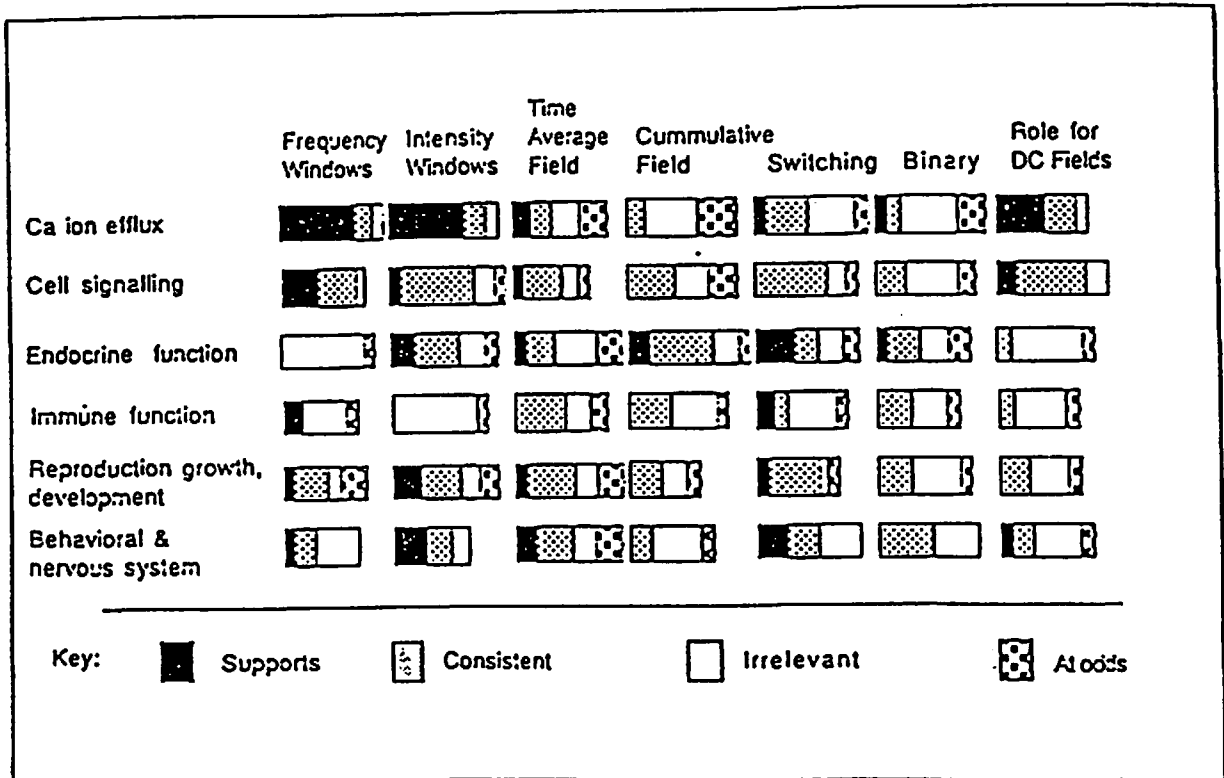

Figure 8-1. Results from a poll of expert opinion as to the relevance of various proposed magnetic field dose metrics or "effects functions" to classes of biological effects. (Adapted from Morgan and Nair, 1992)

8.9 ELECTRICALLY-POWERED TRANSPORT SYSTEM MAGNETIC FIELDS AND BIOLOGICAL EFFECTS STUDIES

Electric drive power for all of the transport systems considered in Chapter 3 is supplied as dc or at frequencies up to 60 Hz. Characterization of the fields by ERM concentrated on the frequency range below about 2.5 kHz, and, as anticipated, the amplitude of frequency components in the 305-2560 bandwidth were relatively low for all of the technologies considered.

From measurements available to date, it is apparent that the TR-07 maglev vehicle does not give rise to magnetic fields that are greater in flux density than those already encountered in many existing electrically powered rail systems. Recently available information on the bandwidth and frequency characteristics of several existing electrically powered rail transports systems allows some comparisons with the available maglev data.

It is appropriate to consider possible biological effects that are observed as a consequence of exposure to dc and magnetic fields with frequencies below about 2.5 kHz, as well as those that may be related to other magnetic field attributes of these systems. With regard to the dc components, there is evidence from animal studies that mammals can detect and respond to these fields. Work of Welker et al. (1983), Lerchl et al. (1991), and more recently of Groh (1993) demonstrates this response in rats. The latter studies indicate that intermittent exposure to the dc component at flux densities in the 1-2 G range appeared more effective in reducing NAT activity and melatonin concentrations in rats than did intermittent exposure to the ac component or the combined ac or dc components. When considered in light of results by Yellon et al. (1991) and Wilson et al. (1993), which indicate that exposures of short duration (15 min.) are capable of altering melatonin, it would be prudent to determine if exposure to dc fields presented in similar manner can alter melatonin secretion in humans. While it can be reasonably argued that a number of stimuli in man's environment can alter melatonin rhythms, the possible effects of intermittent dc magnetic fields such as those associated with the 3000 series Washington, D.C., Metro cars should be explored further.

Of the several systems considered by ERM, maglev magnetic fields exhibit less coherence in ELF ranges than the ac powered rail systems. If coherence is eventually confirmed to be a factor in dose, then the 25 Hz and 60 Hz systems would be of more interest than maglev. maglev also appears to score lower for both ac and dc peak fields than at least one of the other systems. Intermittency *per se* is difficult to judge, because it depends on the length of the trip and the number of stops. However, it is probably safe to assume that subway systems would always score higher than maglev in intermittency of the dc field at least, simply because of the number of stops during an average journey.

In view of these data, there is no evidence that the TR-07 maglev vehicle is likely to represent any risk from magnetic field exposure that is greater than that associated with one or more of the presently operating electrically powered rail systems. However, because of the unusual temporal characteristics of the maglev magnetic fields, and in view of the results from preliminary studies on the effects of high amplitude synthetic maglev fields on neuroendocrine function in rats, the same considerations that are currently being given to conventional rail exposure should also apply to maglev. It should also be noted that TR-07 is only one type of system and that other system designs may generate magnetic fields that are substantially different in terms of both flux density and frequency content.

8.10 REPORT SUMMARY AND CONCLUSIONS

A number of epidemiologic studies have shown an association between EMF exposure surrogates and increased risk for certain cancers. From a scientific standpoint, whether this association represents a cause and effect linkage of EMF to cancer risk remains to be determined.

EMF exposure cannot cause direct chemical damage to the genome. Laboratory studies, both *in vitro* and *in vivo*, have shown that weak electric and magnetic fields can interact with biological systems to elicit a variety of responses. Mechanisms for these effects likely

involve cell membrane and second messenger systems and, therefore, could possibly contribute to increased cancer risk via epigenetic processes.

One epigenetic mechanism for which there is now support from both laboratory and epidemiologic data is the reduction of pineal melatonin secretion by exposure to EMF. Cancers associated with EMF exposure have a number of common characteristics. Based on animal models and human studies, melatonin appears to be protective against the cancers associated with EMF exposure in epidemiologic studies. Excepted are the brain cancers, where no data on the effects of melatonin have yet been published. Data showing effects on immune system components are also of interest, because compromised immune function is a risk factor in certain leukemias and lymphomas.

Laboratory and clinical studies have demonstrated that EMF fields can interact with biological systems to affect cell growth and a number of neuroendocrine endpoints. However, there is not yet a great deal of direct evidence for an effect on cancer risk. With few exceptions, the most relevant studies are those that tested fields as tumor promoters or co-promoters. EMF exposure has been reported to enhance onset of skin cancer (initiation with DMBA and promotion with TPA) and breast cancer (after initiation with DMBA only or after initiation with NMU and promotion with TPA).

Study of EMF effects on cellular regulatory mechanisms and gene expression promises to be a fruitful area in terms of knowledge of EMF interactions as well as gene function. Research in these areas must include repetition of critical findings to verify the existence of gene expression effects. Cellular studies have provided evidence that EMF exposure can affect gene transcription and translation. Findings of alterations in NAT enzyme activity in animal studies are consistent with such effects. Recent reports indicate that EMF effects may extend to the expression of oncogenes or proto-oncogenes in certain cell types. These observations should be extended to define the biological parameters necessary for the effects. To determine the link between these effects and cancer risk, cellular studies will likely require the development of new model systems; an ability to progress from cellular work to tissues and finally to whole animals will be a key for this next generation of cellular work.

It appears likely that more than one mechanism for the transduction of the EMF signals by biological systems will eventually emerge. It is unlikely that a single mechanism could account for the various EMF effects in a variety of animals and over the wide range of field strengths and frequencies for which such effects have been observed.

Considering data from EMF epidemiologic studies, including those of the Swedish study, the association between measured 60 Hz Magnetic Fields and increased cancer risk appears weak. Specifically there is poor correlation between increased time weighted average exposure and increased cancer risk. Because of this fact, and considering occupational data suggesting that high amplitude peak exposure, intermittent exposure, or exposure to fields with a high time-rate-of-change, or higher frequency components may correlate with risk, interest has increased in developing exposure metrics that take account of these latter characteristics for fields found in the environment.

Induced current models for the interaction of EMF with biological systems are consistent with much of the data from clinical studies on bone healing, as well as with a variety of *in vitro* studies designed to determine directly if electrical currents were the active attribute of the fields. This model should be seriously considered in cases where epidemiology has suggested an association between exposure and disease in environments where strong or rapidly time-varying magnetic fields may be found.

Direct magnetic field models continue to be proposed and laboratory data continue to be gathered that are consistent with such mechanisms. The latter are of additional interest to electric transport systems because of the frequent presence of relatively strong dc magnetic field components.

Increased research in the area of EMF effects on biological systems is rapidly becoming an economic necessity, as well as a possible health effects issue. Future research should concentrate on improved understanding of mechanisms, with the objective of determining what constitutes dose. Regardless of whether any increased cancer risk is eventually causally linked to EMF exposure, this research will provide valuable knowledge regarding biological responses to the changes made by man in his EMF environment.

Among presently operating electric rail systems are associated magnetic fields that exceed those of the TR-07 vehicle in terms of each of the characteristics cited as possibly being a component of dose in EMF-associated biological effects. There is some evidence that simulated maglev fields may affect pineal function in rats. Given the attributes of the simulated fields which were most effective in eliciting these effects in these preliminary studies by Groh, 1993, these results do not constitute strong evidence that the magnetic fields generated by the TR-07 maglev vehicle are likely to represent any risk that is greater than that associated with magnetic fields from one or more of the presently operating electrically powered rail systems.

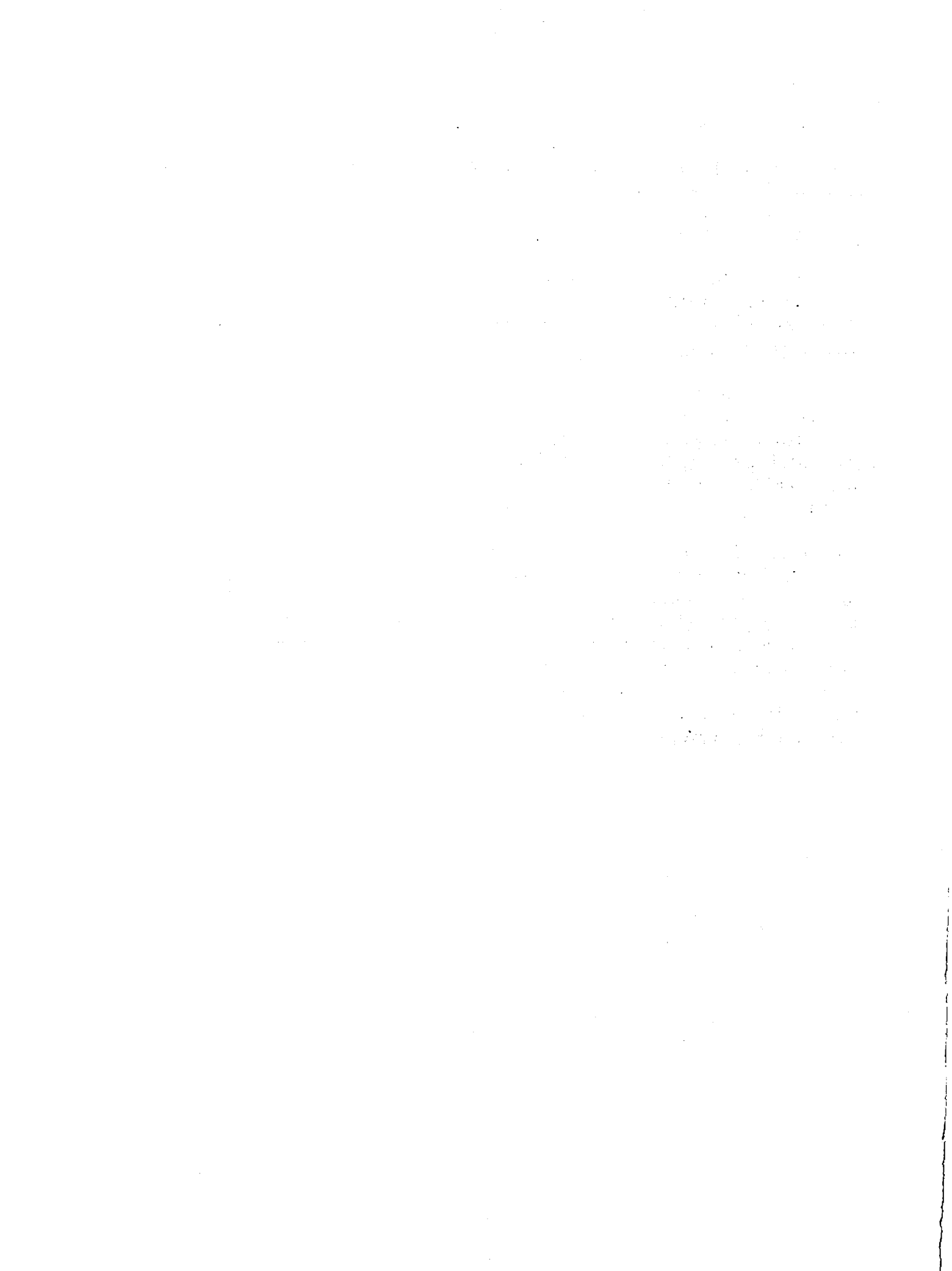

9. REFERENCES

9.1 REFERENCES FOR SECTION 2

- Adair RK (1991): Constraints on biological effects of weak extremely-low-frequency electromagnetic fields. *Phys. Rev. A* 43:1039-1048.
- Adey WR (1988): Physiological signaling across cell membranes and cooperative influences of low frequency electromagnetic fields. In Frolich H (ed.): *Biological coherence and response to external stimuli*. Heidelberg: Springer Verlag, pp. 148-170.
- Adey WR (1992): Signal functions of brain electrical rhythms and their modulation by external electromagnetic fields. In Basar E, Bullock TH (eds.): *Induced rhythms of the brain*, Birkhauser, pp. 323-351.
- Balli-Antunes M, Pfluger DH, Minder CE (1990): The mortality from malignancies of the hematopoietic and lymphatic systems (MHLS) among railway engine drivers. *Environmetrics* 1:121-130.
- Baroncelli P, Battista S, Checcucci A, Comba P, Grandolfo M, Serio A, Vecchia P (1986): A health examination of railway high voltage substation workers exposed to ELF electromagnetic fields. *Am. J. Med.* 10:45-55.
- Bell GB, Marino AA, Chesson AL, Struve FA (1991): Human sensitivity to weak magnetic fields. *Lancet* 338:251.
- Beniashvili DSh, Bilanishvili VG, Menabde MZ (1991): Low frequency electromagnetic radiation enhances the induction of rat mammary tumors by nitrosomethyl urea. *Cancer Letters* 61:75-79.
- Bowman JD, Garabrant DH, Sobel E, Peters JM (1988): Exposures to extremely low frequency (ELF) electromagnetic fields in occupations with elevated leukemia rates. *Appl. Ind. Hyg.* 3:189-194.
- California Department of Education, (1989): California School Site Selection and Approval Guide, p 4. School Facilities Planning Division, P.O. Box 944272, Sacramento, CA 94244.
- ERM (1992): *Magnetic field testing of TR07 maglev vehicle and system*, final report. Prepared by Electric Research and Management for the Federal Railroad Administration under Contract # DTFR53-91-C-00047, February 1992. (Available through NTIS)
- Florig HK, Holberg JF (1990): Power frequency magnetic fields from electric blankets. *Health Physics* 58:493-502.

9.1 REFERENCES FOR SECTION 2 (cont'd)

- Gauger JR (1985): Household appliance magnetic field survey. *IEEE Trans. Pwr. Appar. Sys.*, PAS-104:2436-2444.
- Goodman R, Weisbrot D, Alun U, Henderson A (1992): Transcription in *Drosophila melanogaster* salivary gland cells is altered following exposure to low frequency electromagnetic fields: Analysis of chromosome 3R. *Bioelectromagnetics* 13:111:118.
- Groh, KR (1993): The biological effects of maglev-generated magnetic fields, draft report, (DTRS-57-90-00103). US Department of Transportation, Federal Railroad Administration, Washington D.C. Argonne National Laboratory, Argonne, IL.
- Kaune WT, Stevens RG, Callahan NJ et al. (1987): Residential magnetic and electric fields. *Bioelectromagnetics* 8:315-335.
- Kirschvink JL, Jones DS, McFadden (eds.) (1985): *Magnetite biomineralization and magnetoreception: A new biomagnetism*. New York: Plenum Press, 682 pp.
- Kirschvink JL (1992): Constraints on biological effects of weak extremely low frequency electromagnetic fields. *Physical Rev. A.*, Vol. 46, No. 4.
- Lerchl A, Nonaka KO, Reiter RJ (1991): Pineal gland "magnetosensitivity" to static magnetic fields is a consequence of induced electric currents (eddy currents). *J. Pineal Res.* 10:109-116.
- London SJ et al. (1991): Exposure to residential electric and magnetic fields and the risk of childhood leukemia. *Am. J. Epidemiol.* 134:923-937.
- Lovely RH, Miller DL, Anderson LE (1990): Assessment of rats' behavior in a radial arm maze during exposure to magnetic fields (Abstract). 12th Annual Bioelectromagnetics Society Meeting, San Antonio, Texas, June 1990.
- Lovely RH, Buschbom RL, Slavich AL, Anderson LE (1992): EMF and leukemia: exposure assessment at the razor's edge (Abstract A-46). Annual Review of Research on Biological Effects of Electric and Magnetic Fields from the Generation, Delivery and Use of Electricity, San Diego, California, November 8-12, 1992.
- Mader DL, Peralta SB (1992): Residential exposure to 60 Hz magnetic fields from appliances. *Bioelectromagnetics* 13:287-301.
- Nair I, Morgan MG, Florig HK (1989): *Power-frequency electric and magnetic fields exposure, effects, research, and regulation*. Carnegie Mellon University, for the Energy and Materials Program of the US Congressional Office of Technology Assessment. (Washington, DC 20510-8025), 1989.

9.1 REFERENCES FOR SECTION 2 (cont'd)

- Nakagawa M, Tomita M, Koana T, Odaka M, and Ohno K (1992): Estimation of standardized mortality rates in JNR (JPN. National Railways) cohort by occupation. First World Congress for Electricity and Magnetism in Biology and Medicine, Lake Buena Vista, Florida, June 14-19, 1992.
- Rommereim DN, Rommereim RL, Anderson LE, Sikov MR (1988): Reproduction and teratologic evaluation in rats chronically exposed at multiple strengths of 60-Hz electric fields. Abstract: 10th Annual Meeting, June 1988, Stamford, Connecticut.
- Rommereim DN, Rommereim RL, Buschbom RL, Anderson LE (1990): Developmental toxicity study in rats exposed to 60-Hz horizontal magnetic fields (Abstract). 12th Annual Meeting of Bioelectromagnetics Society, San Antonio, Texas, June 1990.
- Tenforde TS (1989): Biological responses to static and time-varying magnetic fields. In Lin, JC (ed.): *Electromagnetic interaction with biological systems*. Plenum Publishing Corporation.
- Tenforde TS (1991): Biological interactions of extremely low frequency electric and magnetic fields. *J. Electroanal. Chem.* 320:1-17.
- Tynes T, Anderson A (1990): Electromagnetic fields and male breast cancer. *Lancet* 1596.
- Tynes T, Jynge H, and Vistnes (1993) A nested case control study of leukemia and brain tumors in Norwegian railway workers. (Abstract) Fifteenth Annual Meeting of the Bioelectromagnetics Society, Los Angeles, CA, June 13-17, 1993. pg 85.
- Walborg EF (1991): *Extremely low frequency electromagnetic fields and cancer: Focus on tumor initiation, promotion, and progression*. Prepared for National Electric Manufacturers Association (NEMA).
- Wilson BW, Anderson LE (1990): ELF electromagnetic field effects on the pineal gland. In: Wilson BW, Stevens RG, and Anderson LE (eds.): *Extremely low frequency electromagnetic fields: The question of cancer*. Columbus: Battelle Press, pp. 159-186.
- Wilson BW, Lee GM, Yost M, Davis C, Wilson M, Heimbigner T, Hartman J (1992): Magnetic fields from electric bed heating devices: Flux densities and spectral characteristics (Abstract A-41). Annual Review of Research on Biological Effects of Electric and Magnetic Fields from the Generation, Delivery and Use of Electricity, San Diego, California, November 8-12, 1992.
- Wilson BW, Lovely RH, Davis C, Hansen N (1993) Magnetic field flux density and spectral characteristics of personal appliances. (Abstract) Fifteenth Annual Meeting of the Bioelectromagnetics Society. Los Angeles CA, June 13-17, 1993, pg. 32.

9.2 REFERENCES FOR SECTION 3

Balli-Antunes M, Pfluger DH, Minder ChE (1990): The mortality from malignancies of the hematopoietic and lymphatic systems (MHLs) among railway engine drivers. *Environmetrics* 1:121-130.

Baroncelli P, Battista S, Checcucci A, Comba P, Serio A, Vecchia (1986) A health examination of railway high voltage substation workers exposed to ELF electromagnetic fields. *Am J Int Med* 10:45-55.

Chadwick PJ, Lowes FI (1992): Magnetic fields from transport systems in the U.K. *Proceedings of the First World Congress for Electricity and Magnetism in Biology and Medicine* June 14-19, 1992.

ERM (1992a): *Magnetic field testing of TR07 maglev vehicle and system*, final report. Prepared by Electric Research and Management for the Federal Railroad Administration under Contract # DTFR53-91-C-00047. February 1992. (Available through NTIS.)

ERM (1992b): *Magnetic and electric field testing of the French train A Grande Vitesse (TGV) rail systems*, final report. Prepared by Electric Research and Management for the Federal Railroad Administration under Contract # DTFR53-91-C-00047. December 1992. (Available from NTIS.)

ERM (1993a): *Magnetic and electric field testing of the Washington Metropolitan Area Transit Authority metrorail system*, final report. Prepared by Electric Research and Management for the Federal Railroad Administration under Contract # DTFR53-91-C-00047. January 1993. (Available from NTIS.)

ERM (1993b): *Magnetic and electric fields testing of the Massachusetts Bay Transportation Authority (MBTA) urban transport system*. Prepared by Electric Research and Management for the Federal Railroad Administration under Contract # DTFR53-91-C-00047. January 1993. (Available through NTIS.)

ERM (1993c): *Magnetic and electric field testing of the AMTRAK and METRO North Northeast Corridor and New Jersey Transit North Jersey coast line rail systems*, final report. Prepared by Electric Research and Management for the Federal Railroad Administration under Contract # DTFR53-91-C-00047. March 1993. (Available through NTIS.)

Groh KR (1993): The biological effects of maglev-generated magnetic fields. Draft report (DTRS-57-90-00103) to US Department of Transportation, Federal Railroad Administration, Washington D.C. Argonne National Laboratory, Argonne, IL.

9.2 REFERENCES FOR SECTION 3 (cont'd)

Nakagawa M, Tomita M, Koana T, Odaka M, Ohno K (1992): Estimation of standardized mortality rates in JNR (JPN. National Railways) cohort by occupation. First World Congress for Electricity and Magnetism in Biology and Medicine, Lake Buena Vista, Florida, June 14-19, 1992.

Tynes T, Anderson A (1990): Electromagnetic fields and male breast cancer. *The Lancet* 1596.

Tynes T, Jynge H, Vistnes A (1993): A nested case-control study of leukaemia and brain tumors in Norwegian railway workers (Abstract). Fifteenth Annual Meeting of the Bioelectromagnetic Society, Los Angeles, California, June 13-17, 1993.

9.3 REFERENCES FOR SECTION 4

Adair RK (1991): Constraints on biological effects of weak extremely-low-frequency electromagnetic fields. *Phys. Rev. A.*, 43:1038-1049.

Adey WR (1988): Cell membranes: The electromagnetic environment and cancer promotion. *Neurochem. Res.* 13:671.

Barnes FS (1992): Some engineering models for interaction of electric and magnetic fields with biological systems. *Bioelectromagnetics*, Supplement 1: 67-86.

Bawin SM, Adey WR (1976): Sensitivity of calcium binding in cerebral tissue to weak environmental electric fields oscillating at low frequency. *Proc. Natl. Acad. Sci. USA* 73:1999.

Blackman CF et al. (1982): Effects of ELF fields on calcium ion efflux from brain tissue in vitro. *Radiat. Res.* 92:510.

Blackman CF et al. (1985): A role for the magnetic field in the radiation-induced efflux of calcium from brain tissue in vitro. *Bioelectromagnetics* 6:327.

Blackman CF et al. (1988): Influence of electromagnetic fields on the efflux of calcium ions from brain tissue in vitro: A three model analysis consistent with the frequency response up to 510 Hz. *Bioelectromagnetics* 9:215.

Boonstra J et al. (1981): *Exp. Cell Res.* 131:452-455.

Boonstra J et al. (1982): Regulation of Na⁺, K⁺-pump activity by nerve growth factor in chick embryo dorsal root ganglionic cell. *J. Cell Physiol.* 113:28-34.

9.3 REFERENCES FOR SECTION 4 (cont'd)

Boynton AL et al. (1977): Different extracellular calcium requirement for proliferation of nonneoplastic, preneoplastic and neoplastic mouse cells. *Cancer Res.*, 37:2657-2661.

Bretscher MS (1972): Membrane structure: Some general principles. *Science*, 181:622-629.

Caveney S (1985): *Ann. Rev. Physiol.*, 47:319-335.

Chafoules JG et al. (1982): *Cell*, 28:41-50.

Cheng DK (1959): *Analysis of linear systems*. London: Addison Wesley.

Chiabrera A et al. (1982): Modelling of the perturbation induced by low-frequency electromagnetic fields on the membrane receptors of stimulated human lymphocytes. *Stud. Biophys.* 90:77.

Chiabrera A, Grattarola M, Viviani R (1984): Interaction between electromagnetic fields and cells: Microelectrophoretic effect on ligands and surface receptors. *Bioelectromagnetics* 5:173.

Chiabrera A et al. (1985): Electric and magnetic field effects on ligand binding to the cell membrane. In A. Chiabrera et al. (eds.): *Interactions between electromagnetic fields and cells*. New York: Plenum, p. 253.

Chiabrera A, Bianco B (1987): The role of the magnetic field in the EM interaction with ligand binding. In Blank M and Findl E (eds.), *Mechanistic approaches to interactions of electric and electromagnetic fields with living systems*. New York: Plenum Press, p. 79.

Chiabrera A et al. (1989): Conf. on: *Interaction mechanisms of low level electromagnetic fields in living systems-resonant phenomena*. Stockholm: Royal Swedish Academy of Sciences, p. 256.

Chiabrera AA et al. (1991): In Brighton CT, Pollack SR (eds.): *Electromagnetics in medicine and biology*. San Francisco Press Inc., p. 27.

Conti P et al. (1983): Reduced mitogenic stimulation of human lymphocytes by extremely low frequency electromagnetic fields. *FEBS Lett.* 162:156.

Cooper MS (1984): Gap junctions increase the sensitivity of tissue cells to exogenous electric fields. *J. Theor. Biol.* 111:123.

DeFelice, LJ (1981): In: *Introduction to membrane noise*. New York: Plenum.

Dietrich FM et al. (1992): *Proceedings First World Congress for Electricity and Magnetism in Medicine and Biology*. San Francisco Press, in press.

9.3 REFERENCES FOR SECTION 4 (cont'd)

Doty SB (1981): Morphological evidence of gap junctions between bone cells. *Calcif. Tissue Int.*, 33:509-512.

Fletcher WH et al. (1986): *Proc. Bioelectromagnetics Soc., 8th Annual Meeting*, Madison, Wisconsin, p. 12.

Gearsa D et al. (1979): Ionophore A 23187 raises cyclic AMP levels in macrophages by stimulation prostaglandin E formation. *Exp. Cell. Res.*, 118:55-62.

Goldstein L et al. (1964): *Biochemistry*, 3:1913-1919.

Hayt WH (1981): *Engineering electromagnetics*. New York: McGraw-Hill, pp. 346-358.

Hazelton B, Tupper J (1979): Calcium transport and exchange in mouse 3T3 and SV40-3T3 cells. *J. Cell Biol.*, 81:538-542.

Helman SI and Van Driessche W (eds) (1990): Channels and noise in epithelial tissues. *Curr. Top Membr. Transp.* Vol. 37.

Kaufman JJ et al. (1990): Stimulation of Lorentz force effects on ion binding kinetics. Abstracts: 12th Annual Meeting, Bioelectromagnetics Society, June 10-14, San Antonio, p. 66.

Kirschvink JL, Jones DS, MacFadden BJ (eds.) (1985): *Magnetic biomineralization in organisms: A new biomagnetism*. New York: Plenum Press, 682 pp.

Kirschvink JL (1989): Magnetite biomineralization and geomagnetic sensitivity in higher animals: An update and recommendations for future study. *Bioelectromagnetics* 10:239-59.

Kirschvink JL, Kobayashi-Kirschvink A (1992): Magnetite (Fe₃O₄) biomineralization in human tissues: A solution to the thermal noise problem of ELF bioeffects (Abstract). First World Congress for Electricity and Magnetism in Biology and Medicine, Lake Buena Vista, Florida, June 1992.

Lednev VV (1991): Possible mechanism for the influence of weak magnetic fields on biological systems. *Bioelectromagnetics* 12:71-75.

Liboff RL (1965): A biomagnetic hypothesis. *Biophys. J.* 5:845.

Liboff RL (1966): Brownian motion of charged particles in crossed electric and magnetic fields. *Physical. Rev.* 144:222.

Liboff AR (1985): Cyclotron resonance in membrane transport. In Chiabrera A et al. (eds.): *Interactions between electromagnetic fields and cells*. New York: Plenum, p. 281

9.3 REFERENCES FOR SECTION 4 (cont'd)

Liboff AR, Smith SD, McLeod BR (1987a): Experimental evidence for ion cyclotron resonance mediation of membrane transport. In Blank M, Findl E (eds.): *"Mechanistic Approaches to Interactions of Electric and Electromagnetic Fields with Living Systems."* New York: Plenum Press, p. 109.

Liboff AR et al. (1987b): Calcium 45 Cyclotron Resonance in Human Lymphocytes. *J. Bioelectricity* 6:13.

Liboff AR, McLeod BR (1988): Kinetic of channelized membrane ions in magnetic fields. *Bioelectromagnetics* 9:39.

Liburdy RP (1992): Calcium signaling in lymphocytes and ELF fields. *FEBS Letters*, 301:53-59.

Litovitz TA, Krause D, Mullins JM (1991): *Effect of Coherence Time of the Applied Magnetic Field on Ornithine Decarboxylase Activity.*

Litovitz TA, Farrell JM, Krause D, Doinov P, Montrose CJ (1993): Superimposing Electromagnetic Noise blocks the Alteration of Ornithine Decarboxylase Activity in Developing Chick Embryos Caused by a Weak 60-Hz Sinusoidal Field. (Abstract) Bioelectromagnetic Society Fifteenth Annual Meeting, Los Angeles, California June 13-17, 1993.

Loewenstein WR (1981): Junctional intracellular communication: the cell-to-cell membrane channel. *Physiol. Rev.* 61:829-841.

Lopez-Rivas A et al. (1982): *Proc. Natl. Acad. Sci. USA* 79:6275-6279, 1982.

Lyle DB et al. (1991): Calcium uptake by leukemic and normal T lymphocytes exposed to low frequency magnetic fields. *Bioelectromagnetics* 12:145.

Markov MS, Wang S, Pilla AA (1992): Effects of weak low frequency sinusoidal and dc magnetic fields on myosin phosphorylation in a cell-free preparation. In: *Bioelectrochemistry and Bioenergetics* (in press).

McLauchlan K (1992): Are environmental magnetic fields dangerous? *Physics World* (UK) January 1992, pp. 1-5.

McLaughlin S et al. (1970): Surface charge and the conductance of phospholipid membrane. *Proc. Natl. Acad. Sci. USA*, 67:1268-1275.

McLaughlin S (1972): The mechanism of action of DNP on phospholipid bilayer membranes. *J. Memb. Biol.*, 9:361-372.

9.3 REFERENCES FOR SECTION 4 (cont'd)

McLean JRN, Birnboim HC, Scaiano JC, Thansandote A, Lecuyer D, Johnson F (1992): Modification of tumor promotion by exposure to 60 Hz magnetic field: A possible mechanism (Abstract). Society of Toxicology of Canada, 25th Annual Meeting. Montreal, Canada, December 3,4, 1992.

McLeod BR, Pilla AA, Sampsel MW (1983): Electromagnetic fields induced by Helmholtz aiding coils inside saline-filled boundaries. *Bioelectromagnetics* 4:357.

McLeod BR, Liboff AR (1987): Cyclotron resonance in cell membranes: The theory of the mechanism. In Blank M. and Findl E. (eds.): *Mechanistic approaches to interactions of electric and electromagnetic fields with living systems*. New York: Plenum Press, p. 97.

McLeod KJ, Lee RC, Ehrlich HP (1987): Frequency dependence of electric field modulation of fibroblast protein synthesis. *Science* 236:1465.

Meldrum FG, Heywood BR, Mann S (1992): Magneto ferritin: In-vitro synthesis of a novel magnetic protein. *Science* 257:522-523.

Mendoza J et al. (1980): *J. Cell Physiol.* 103:17-27.

Mullins JM, Krause D, Desta A, Litovitz TA (1993): Elimination of the 60-Hz magnetic field-induced enhancement of ornithine decarboxylase activity in 929 and daudi human lymphoma cells by simultaneous application of a random noise field. (Abstract) Bioelectromagnetic Society Fifteenth Annual Meeting, Los Angeles, California June 13-17, 1993

Parsegian VA (1975): Possible modulation of reactions on the cell surface by changes in electrostatic potential that accompany cell contact. *Ann. N.Y. Acad. Sci.* 264:161-174.

Pascoe GA (1990): Calcium homeostasis and oxidative stress. *Extremely low frequency electromagnetic fields: The question of cancer*. B.W. Wilson, R.G. Stevens and L.E. Anderson (eds), Battelle Press, Columbus.

Pilla AA (1972): Electrochemical information and energy transfer in vivo. *Proc., 7th IECEC*, Am. Chem Soc., Washington, D.C., p. 761.

Pilla AA (1974): Electrochemical information transfer at living cell membranes. *Ann. N.Y. Acad. Sci.* 238:149.

Pilla AA, Margules GS (1977): Dynamic interfacial impedance at cell membranes: Application to toad urinary bladder. *J. Electrochem. Soc.* 124:1697.

Pilla AA (1980): Electrochemical information transfer at cell surfaces and junctions. In Keyzer H, Gutman F (eds.): *Bioelectrochemistry*. New York: Plenum Press, pp. 353-396.

9.3 REFERENCES FOR SECTION 4 (cont'd)

Pilla AA, Sechaud P, McLeod BR (1983): Electrochemical and electrical aspects of low-frequency electromagnetic current induction in biological systems. *J. Biol. Phys.* 11:51.

Pilla AA et al. (1985): Electromagnetic modulation of biological processes: Consideration of cell-waveform interactions. In Chiabrera A, Nicolini C, and Schwann HP (eds.): *Interactions between electromagnetic fields and cells*. New York: Plenum Press, p. 423.

Pilla AA et al. (1992): Broadband acceleration of bone repair in a rabbit model is independent of magnetic component. In: *Proceedings, First World Congress on bioelectricity*, San Francisco Press, in press.

Reese JA et al. (1991): Evaluation of changes in diatom mobility after exposure to 16 Hz electromagnetic fields. *Bioelectromagnetics* 12:21.

Savitz DA et al. (1988): Case control study of childhood cancer and exposure to 60Hz magnetic fields. *Am. J. Epidemiol.*, 128:21-38.

Schwann HP (1985): In Chiabrera A, Nicolini C, Schwann HP (eds.): *Interactions between electromagnetic fields and cells*. New York: Plenum Press, p.75.

Sheridan JD et al. (1985): *Ann. Rev. Physiol.*, 47:337-353.

Shiba H (1971): Heaviside's "Bedssel Cable" as an electric model for flat couple epithelial cells with low resistive junctional membranes. *J. Theor. Biol.*, 30:59-68.

Shuvalova LA et al. (1991): *Weak magnetic field influence on the speed of calmodulin dependent phosphorylation of myosin in solution*. Dokladi Acad. Nauk USSR 217:227.

Singer SJ (1971): Rothfeld LI (ed.): *Structure and function of biological membranes*. New York: Academic.

Stevens CF (1972): Inferences about membrane properties from electric noise measurements. *Biophys. J.* 12:1028-1047.

Stevens RG, Wilson BW, Anderson LE (1990): The question of cancer. In *Extremely low frequency electromagnetic fields: the question of cancer*. B.W. Wilson, R.G. Stevens, and L.E. Anderson (eds), Battelle Press, Columbus.

Tsai K, Lenard J (1975): Asymmetry of influenza virus membrane bilayer demonstrated with phospholipase C. *Nature*, 253:554-555.

Tsong TY, Astumian RD (1988): Electroconformational coupling: How membrane-bound ATPase transduces energy from dynamic electric fields. *Ann. Rev. Physiol.* 50:273.

9.3 REFERENCES FOR SECTION 4 (cont'd)

Tsong TY et al. (1989): Resonance electroconformational coupling: A proposed mechanism for energy and signal transductions by membrane proteins. *Bioscience Rep.* 9:13.

Urry DW (1978): *Ann. N.Y. Acad. Sci.*, 307:3-27.

Van Amelsfort AMJ (1991): An analytical algorithm for solving inhomogeneous electromagnetic boundary-value problems for a set of coaxial circular cylinders. Ph.D. Thesis, Eindhoven University, The Netherlands.

Weaver JC, Astumian RD (1990): The response of living cells to very weak electric fields: The thermal noise limit. *Science* 247:459.

Weaver JC and Astumian RD (1992): Estimates for ELF effects: Noise-based thresholds and the number of experimental conditions required for empirical searches. *Bioelectromagnetics*, Supplement 1: 119-138.

Wei LX, Goodman R, Henderson AS (1990): Changes in levels of c-myc and histone H2B following exposure of cells to low-frequency sinusoidal electromagnetic fields: Evidence for a window effect. *Bioelectromagnetics* 11:269.

Westerhoff HV et al. (1989): How enzymes can capture and transmit free energy from an oscillating electric field. *Proc. Natl. Acad. Sci. USA* 83:4734.

Whitfield JF et al. (1981): The roles of calcium and cyclic AMP in cell proliferation. *Ann. N.Y. Acad. Sci.*, 339:216-240.

Zwaal RFA, Roelofsen B, Colley CM (1973): Localization of red cell membrane constituents. *Biochem. Biophysical Acta*, 300:159-182.

9.4 REFERENCES FOR SECTION 5

Aaron RK, Ciombor DM, Jolly G (1989a): Stimulation of experimental endochondral ossification by low-energy pulsing electromagnetic fields. *J. Bone Miner. Res.* 4:227.

Aaron RK, Lennox D, Bunce GE, Ebert T (1989b): The conservative treatment of osteonecrosis of the femoral head. A comparison of core decompression and pulsing electromagnetic fields. *Clin. Orthop.* 249:209.

Adey WR (1988): Cell membranes; the electromagnetic environment and cancer promotion. *Neurochem. Res.* 13:671-677.

9.4 REFERENCES FOR SECTION 5 (cont'd)

Adey WR (1990): Electromagnetic fields and the essence of living systems. Plenary Lecture, International Union of Radio Sciences, 23rd General Assembly, Prague. In: *Modern radio science*, JB Andersen, ed., Oxford University Press, pp. 1-37.

Albertini A, Noera G, Pierangeli A, Zucchini P, Cadossi R (1991): *Electromagnetics in biology and medicine*, C.T. Brighton, S.R. Pollack, eds., San Francisco Press, p. 187.

Anderson LE (1991): Biological effects of extremely low frequency electromagnetic fields: In vivo studies. In: *Proceedings of scientific workshop on health effects of electromagnetic radiation on workers*. U.S. Department of Health and Human Services, Cincinnati, Ohio, January 1991.

Anninos PA, Tsagas N, Sandvyk R, Derpapas K (1991): Magnetic stimulation in the treatment of partial seizures. *Intern. J. Neuroscience* 60:141-171.

Arendt J (1988): Melatonin and the human circadian system. In: *Melatonin-clinical perspectives*, A. Miles, D.R.S. Philbrick, C. Thompson, eds. Oxford: Oxford University Press, pp. 43-61.

Baranowski TJ, Black J, Brighton CT, Friedenber ZB (1983): Electrical osteogenesis by low direct current. *J. Orthop. Res.* 1:120.

Bartsch C, Bartsch H, Fluchter SH, et al. (1988): Evidence for a modulation of melatonin secretion in men with benign and malignant tumors of the prostate: Relationship with pituitary hormones. *J. Pineal Res.* 2:121.

Bassett CAL, Becker RO (1962): Generation of electrical potentials by bone in response to mechanical stress. *Science* 137:1063.

Bassett CAL (1968): *Calc. Tiss. Res.* 1:252.

Bassett CAL, Pilla AA, Pawluk RJ (1977): A non-surgical salvage of surgically-resistant pseudoarthroses and non-unions by pulsing electromagnetic fields. *Clin. Orthop.* 124:11

Bassett CAL (1989): Fundamental and practical aspects of therapeutic uses of pulsed electromagnetic fields (PEMFS). *CRC Crit. Rev. Biomed. Engineer.* 17:451-529.

Bassett CAL, Mitchell SN, Gaston SR (1981): Treatment of ununited tibial diaphyseal fractures with pulsing electromagnetic fields. *J. Bone Joint Surg.* 63A:511.

Bassett LS, Tzitzikalakis G, Pawluk RJ, Bassett CAL (1979): *Electrical properties of bone and cartilage*, C.T. Brighton, J. Black, S.R. Pollack, eds., New York; Grune and Stratton, p.311.

9.4 REFERENCES FOR SECTION 5 (cont'd)

- Bawin SM, Adey WR (1976): Sensitivity of calcium binding in cerebral tissue to weak environmental electric fields oscillating at low frequency. *Proc. Natl. Acad. Sci. USA* 73:1999.
- Bell GB, Marino AA, Chesson AL, Struve FA (1991): Human sensitivity to weak magnetic fields. *Lancet* 338:251.
- Beniashvili D, Vilanishvili VG, Manabde MZ (1991): Low frequency electromagnetic radiation enhances induction of rat mammary tumors by nitrosomethylurea. *Cancer Letters* 61:75-79.
- Binder A, Parr G, Hazleman B, Fitton-Jackson S (1984): Pulsed electromagnetic field therapy of persistent rotator cuff tendinitis. *Lancet* 8379:695, 31 March.
- Black J, Baranowski TJ, Brighton CT (1984): Electrochemical aspects of D.C. stimulation of osteogenesis. *Bioelectrochem. Bioenergetics*. 12:323.
- Black J (1987): *Electrical stimulation. Its role in growth, repair, and remodeling of the musculoskeletal system*. New York: Praeger.
- Blackman CF, Benane SG, House DE, Joines WT (1985a): Effects of ELF (1-120 Hz) and modulated (50 Hz) RF fields on the efflux of calcium ions from brain tissue in vitro. *Bioelectromagnetics* 6:1-11.
- Blackman CF, Benane SG, Rabinowitz JR, House DE, Joines WT (1985b): A role for the magnetic field in the radiation-induced efflux of calcium ions from brain tissue in vitro. *Bioelectromagnetics* 6:327-337.
- Blask DE (1984): The pineal: An oncostatus gland? In: *The pineal gland*, R. J. Reiter (ed). New York: Raven Press.
- Borgens RB, Blight AR, McGinnis ME (1987): Behavioral recovery induced by applied electric fields after spinal cord hemisection in guinea pig. *Science* 238:366.
- Borsalino G, Bagnacani M, Bettati E, Fornaciari F, Rocchi R, Uluhogian S, Ceccherelli G, Cadossi R, Traina GC (1988): Electrical stimulation of human femoral intertrochanteric osteotomies. *Clin. Orthop.* 237:256.
- Bourguignon GJ, Jy W, Bourguignon LYW (1989): Electric stimulation of human fibroblasts causes an increase in calcium influx and the exposure of additional insulin receptors. *J. Cell. Physiol.* 140:379.
- Brighton CT (1981): The treatment of non-unions with electricity. *J. Bone Joint Surg.* 63A:847.

9.4 REFERENCES FOR SECTION 5 (cont'd)

Brighton CT, Tadduni GT, Pollack SR (1985): Treatment of sciatic denervation disuse osteoporosis in the rat tibia with capacitively coupled electrical stimulation. *J. Bone Joint Surg.* 67A:1022.

Brighton CT, Pollack SR (1985): Treatment of recalcitrant non-union with a capacitively coupled electric field. *J. Bone Joint Surg. (Am)* 67:577-585.

Brighton CT, Jensen L, Pollack SR, Tolin BS, Clark CC (1989a): Proliferative and synthetic response of bovine growth plate chondrocytes to various capacitively coupled electric fields. *J. Orthop. Res.* 7:759.

Brighton CT, Luessenhop CP, Pollack SR, Steinberg DR, Petrik ME, Kaplan FS (1989b): Treatment of castration-induced osteoporosis by a capacitively coupled electrical signal in rat vertebrae. *J. Bone Joint Surg. (Am)* 71A:228.

Brighton CT (1991): *Electromagnetics in biology and medicine*, C.T. Brighton, S.R. Pollack, eds., San Francisco Press, p. 293.

Buntenkoetter S, Brinkmann K, Zittlay E, Zwingelberg R, Reinhard HJ, and Mevissen M (1990): An oncological study of DMBA on rats exposed to 50 Hz magnetic fields. Abstract: 12th Annual Meeting of the Bioelectromagnetics Society, June 1990.

Buswell RS (1975): The pineal and neoplasia. *The Lancet* (ii) 134-135.

Byus CV, Pieper SE, Adey WR (1987): The effects of low-energy 60-Hz environmental electromagnetic fields upon the growth-related enzyme ornithine decarboxylase. *Carcinogenesis* 8:1385-1389.

Cadossi R, Emilia G, Torelli G, Ceccherelli G, Ferrari S, Ruggieri P (1985): The effect of low-frequency electromagnetic fields on the response of human lymphocytes to phytohemagglutinin. *Bioelectrochem. Bioenerg.* 3:115.

Cadossi R, Emilia G, Ceccherelli G, Torelli G (1989a): Lymphocytes and pulsing electromagnetic fields. In *Modern Bioelectricity*. New York: Marcel Dekker, pp. 451.

Cadossi R, Hentz VR, Kipp J, Eiverson R, Cecherelli G, Zucchini P, Emilia G, Torelli G, Franceschi C, Cossarizza A (1989b): Effect of low frequency low energy pulsing electromagnetic field (PEMF) on X-ray-irradiated mice. *Exp. Hemat.* 17:88.

Cain CD, Adey WR, Luben RA (1987): Evidence that pulsed electromagnetic fields inhibit coupling of adenylate cyclase by parathyroid hormone in bone cells. *J. Bone Min. Res.* 2:437.

Carson JJ, Prato FS, Drost DJ, Diesbourg LD, Dixon SJ (1990): Time-varying magnetic fields increase cytosolic free calcium in HL-60 cells. *Am. J. Physiol.* 259:C687.

9.4 REFERENCES FOR SECTION 5 (cont'd)

Carter EL, Vresilovic EJ, Pollack SR, Brighton CT (1989): Field distributions in vertebral bodies of the rat during electrical stimulation. *IEEE Trans. Biomed. Eng.* 36:333.

Chakkalakal DA, Lippiello L, Wilson RF, Shindell R, Connolly JF (1990): Mineral and matrix contributions to rigidity in fracture healing. *J. Biomech.* 23:425.

Chiabrera A, Bianco B, Caratozzolo F, Gianetti G, Grattarola M, Viviani R (1985): Electric and magnetic field effects on ligand binding to the cell membrane. In *Interactions between electromagnetic fields and cells*, A. Chiabrera, C. Nicolini, H.P. Schwan (eds.). New York: Plenum, p. 253.

Cohen MC, Lippman C, Chabner B (1978): Role of the pineal gland in the etiology and treatment of breast cancer. *Lancet* 2:814-816.

Cohen MM, Kunska A, Astemborski JA, McCulloch D, Paskewitz DA (1986): Effect of low-level, 60-Hz electromagnetic fields on human lymphoid cells: I. Mitotic rate and chromosome breakage in human peripheral lymphocytes. *Bioelectromagnetics* 7:415-423.

Conti P, Gigante GE, Cifone MG, Alesse E, Ianni G, Reale M, Angeletti PU (1983): Reduced mitogenic stimulation of human lymphocytes by extremely low frequency electromagnetic fields. *FEBS Lett.* 162:156.

Conti P, Gigante GE, Alesse E, Cifone MG, Fieschi C, Reale M, Angeletti PU (1985): A role for calcium in the effect of very low frequency electromagnetic fields on the blastogenesis of human lymphocytes. *FEBS Lett.* 181:28.

Cooper MS, Keller RE (1984): Perpendicular orientation and directional migration of amphibian neural crest cells in D.C. electrical fields. *Proc. Natl. Acad. Sci. USA* 81:160.

Cossarizza A, Monti D, Bersani F, Cantini M, Cadossi R, Sacchi A, Franceschi C (1989a): Extremely low frequency pulsed electromagnetic fields increase cell proliferation in lymphocytes from young and aged subjects. *Biochem. Biophys. Res. Comm.* 160:692.

Cossarizza A, Monti D, Sola P, Moschini G, Cadossi R, Bersani F, Franceschi C (1989b): DNA repair after gamma irradiation in lymphocytes exposed to low-frequency pulsed electromagnetic fields. *Radiat. Res.* 118:161-168.

Czerska E, Casamento J, Davis C, Elson E, Ning J, Swicord M (in press): *Effects of ELF on c-myc oncogene expression in normal and transformed human cells.*

Dixey R, Rein GA (1982): 3H-Noradrenaline release potentiated in a clonal nerve cell line by low-intensity pulsed magnetic fields. *Nature* 296:253.

9.4 REFERENCES FOR SECTION 5 (cont'd)

Dunn MG, Doillon CJ, Berg RA, Olson RM, Silver FH (1988): Wound healing using a collagen matrix: Effect of D.C. Electrical stimulation. *J. Biomed. Mater. Res.* 22A:191.

Fam WZ, Mikhail EL (1990): Biological effects in mice exposed to 25-mT, 60-Hz magnetic field. Abstract: 12th Annual Meeting of the Bioelectromagnetics Society, June 1990.

Farndale RW, Murray JC (1986): The action of pulsed magnetic fields on cyclic AMP levels in cultured fibroblasts. *Biochim. Biophys. Acta* 881:46.

Fessard, A. (1974) *Handbook of sensory physiology*. Volume 3: *Electroreceptors and other specialized receptors in lower vertebrates*. Springer Verlag, Berlin

Fitzsimmons RT, Farley J, Adey WR, Baylink DJ (1989): Frequency dependence of increased cell proliferation, in vitro, in exposures to a low amplitude, low frequency electric field: Evidence for dependence on increased mitogen activity released into culture medium. *J. Cell. Physiol.* 139:586.

Frazier ME, Reese JA, Morris JE, Jostes RF, Miller DL (1990): Exposure of mammalian cells to 60-Hz magnetic or electric fields: analysis of DNA repair of induced, single-strand breaks. *Bioelectromagnetics* 11:229-234.

Friedenberg ZB, Brighton CT (1966): Bioelectric potentials in bone. *J. Bone Joint Surg.* 48A:915.

Glassman LS, McGrath MH, Bassett CAL (1986): Effect of external pulsing electromagnetic fields on the healing of soft tissue. *Ann. Plast. Surg.* 16:287.

Goodman R, Bassett CAL, Henderson A (1983): Pulsing electromagnetic fields induce cellular transcription. *Science* 220:1283-1285.

Goodman R, Henderson AS (1986): Sine waves enhance cellular transcription. *Bioelectromagnetics* 7:23-29.

Goodman R, Abbott J, Henderson AS (1987): Transcriptional patterns in the X chromosome of *Sciara coprophila* following exposure to magnetic fields. *Bioelectromagnetics* 8:1-7.

Goodman R, Henderson AS (1988): Exposure of salivary gland cells to low frequency electromagnetic fields alters polypeptide synthesis. *Proc. Natl. Acad. Sci. USA* 85:3928.

Goodman R, Henderson AS (1990): Exposure of cells to extremely low frequency electromagnetic fields: Relationship to malignancy. *Cancer Cells* 2:355.

Goodman R, Shirley-Henderson A (1991): Transcription and translation in cells exposed to extremely low frequency electromagnetic fields. *Bioelectrochem Bioenergetics* 25:335-355.

9.4 REFERENCES FOR SECTION 5 (cont'd)

Goodman R, Wei L-X, Xu J-C, Henderson A (1989): Exposure of human cells to low-frequency fields results in quantitative changes in transcripts. *Biochim. Biophys. Acta* 1009:216-220.

Graham C, Cohen HD, Cook MR, Gerkovich MM, Riffle DR, Hoffman SJ (1991): Human cardiac activity in 60 Hz magnetic fields (Abstract). In: *Proc. Bioelectromagnetic Society Annual Meeting*, June 23-27, p. 54.

Greene JJ, Skowronski WJ, Mullins JM, Nardone RM (1991): Delineation of electric and magnetic field effects of extremely low frequency electromagnetic radiation on transcription. *Biochem. Biophys. Res. Commun.* 174:742-749.

Grodzinsky AJ (1983): Electromechanical and physicochemical properties of connective tissue. *CRC Crit. Rev. Biomed. Eng.* 9:133.

Groh KR, Ready MA, Ehret CF (1990): Chronobiological effects of electric fields. In: *Extremely low frequency electromagnetic fields: The question of cancer*. B.W. Wilson, R.G. Stevens, and L.E. Anderson (eds.). Columbus, Ohio: Battelle Press.

Groh, KR (1993): The biological effects of maglev-generated magnetic fields. Draft report (DTRS-57-90-00103) to US Department of Transportation Federal Railroad Administration, Washington D.C. Argonne National Laboratory, Argonne, IL.

Hilton DI, Phillips RD (1980): Cardiovascular response of rats exposed to 60-Hz electric fields. *Bioelectromagnetics* 1:55-64.

Hjeresen DL, Kaune WT, Decker JR, Phillips RD (1980): Effects of 60-Hz electric fields on avoidance behavior and activity in rats. *Bioelectromagnetics* 1:299-312.

Iannacone WM, Pienkowski D, Pollack SR, Brighton CT (1988): Pulsing electromagnetic field stimulation of the in vitro growth plate. *J. Orthop. Res.* 6:239.

Ieran M, Zaffuto S, Bagnacani M, Annovi M, Moratti A, Cadossi R (1990): Effect of low frequency pulsing electromagnetic fields on skin ulcers of venous origin in humans: A double blind study. *J. Orthop. Res.* 8:276.

Jaffe RA, Laszewski BL, Carr DB, Phillips RD (1979): Chronic exposure to a 60-Hz electric field: Effects on synaptic transmission and peripheral nerve function in the rat. *Bioelectromagnetics* 1:131-148.

Jolley WB, Hinshaw DB, Knierim K (1983): Magnetic field effects on calcium efflux and insulin secretion in isolated rabbit islets of Langerhans. *Bioelectromagnetics* 4:103.

9.4 REFERENCES FOR SECTION 5 (cont'd)

Jones DB (1984): The effect of pulsed magnetic fields on cyclic AMP metabolism in organ cultures of chick embryo tibiae. *J. Bioelec.* 3:427.

Kalmijn AD (1992): Ampullae of Lorenzini detect nanovolt/centimeter fields (Abstract). First World Congress for Electricity and Magnetism in Biology and Medicine, Lake Buena Vista, Florida, June 1992.

Kandel ER, Schwartz JH, Jessell TM (1991): *Principles of Neural Science*. New York: Elsevier, pp. 805-810.

Kaune WT (1981): Interactive effects of 60-Hz electric field exposure systems. *Bioelectromagnetics* 2:33-50.

Kirschvink JL, Kobayashi-Kirschvink A (1992): Magnetite (Fe₃O₄) biomineralization in human tissues: A solution to the thermal noise problem of ELF bioeffects (Abstract). First World Congress for Electricity and Magnetism in Biology and Medicine, Lake Buena Vista, Florida, June 1992.

Korenstein D, Somjen D, Fischler H, Binderman I (1984): Capacitive pulsed electrical stimulation of bone cells: Induction of cyclic AMP changes and DNA synthesis. *Biochim. Biophys. Acta* 803:60.

Lerchl A, Nonaka KO, Stokkan K-A, Reiter RJ (1990): Marked rapid alterations in nocturnal pineal serotonin metabolism in mice and rats exposed to weak intermittent magnetic fields. *Biochem. Biophys. Res. Commun.* 169:102-108.

Lerchl A, Nonaka KO, Reiter RJ (1991): Pineal gland "magnetosensitivity" to static magnetic fields is a consequence of induced electric currents (eddy currents). *J. Pineal Res.* 10:109-116.

Leung FC, Rommereim DN, Stevens RG, Wilson BW, Buschbom RL, Anderson LE (1988): Effects of electric fields on rat mammary tumor development induced by 7, 12-dimethylbenz(a)anthracene. Abstract: 10th Meeting of the Bioelectromagnetics Society, June 1988.

Liboff AR, Williams T, Strong DM, Wistar R (1984): Time varying magnetic fields: effect on DNA synthesis. *Science* 223:818.

Liboff AR, Rozek RJ, Sherman ML, McLeod BR, Smith SD (1987): Calcium 45 cyclotron resonance in human lymphocytes. *J. Bioelectricity* 6:13.1

9.4 REFERENCES FOR SECTION 5 (cont'd)

Liboff AR, McLeod BR, Smith SD (1990): Ion cyclotron resonance effects of ELF fields in biological systems. In: *Extremely low frequency electromagnetic fields: The question of cancer*. B.W. Wilson, R.G. Stevens, and L.E. Anderson (eds). Columbus, Ohio: Battelle Press.

Liburdy RP (1992): Calcium signaling in lymphocytes and ELF fields. Evidence for an electric field metric and a site of interaction involving the calcium ion channel. *FEBS Lett.* 301:53-59.

Liburdy RP, Sloma TR, Sokolic R, Yaswen P (1992): ELF magnetic fields, breast cancer and melatonin: 60 Hz fields block melatonin's oncostatic action on ER+ breast cancer cell proliferation. *J Pineal. Res.* (in press).

Liburdy RP and Yost MG (1992): Time varying and static magnetic field combinations of calcium signal transduction in the lymphocyte. (Abstract) First World Congress for Electricity and Magnetism in Biology and Medicine, Lake Buena Vista, Florida, June 14-19, 1992.

Lovely RH, Miller DL, Anderson LE (1990): Assessment of rats behavior in a radial arm maze during exposure to magnetic fields. Abstract: 12th Annual Bioelectromagnetics Society Meeting, San Antonio, Texas, June 1990.

Lovely RH, Creim JA, Miller DL and Anderson LE (1993): Behavior of rats in a radial arm maze during exposure to magnetic fields; Evidence for effects of magnesium ion resonance. (Abstract) Fifteenth Annual Meeting of the Bioelectromagnetic Society, Los Angeles, California June 13-17, 1993.

Luben RA, Cain CD, Chi-Yun Chen M, Rosen DM, Adey WR (1982): Effects of electromagnetic stimuli on bone and bone cells in vitro: Inhibition of responses to parathyroid hormone by low-energy low-frequency fields. *Proc. Natl. Acad. Sci. USA* 79:4180.

Maestroni GJM, Conti A, Pierpaoli W (1986): Role of the pineal gland in immunity: Circadian synthesis and release of melatonin modulates the antibody response and antagonizes immuno-suppressive effect of corticosterone. *J. Neuroimmunology* 13:19-30.

McCaig CD (1990): Nerve growth in a small applied electric field and the effects of pharmacological agents on rate and orientation. *J. Cell Science* 95:617.

McKibbin B (1978): The biology of fracture healing in long bones. *J. Bone Joint Surg.* 60B:150.

McLean J, Stuchly MA, Mitchel R, Wilkinson R, Lecuyer DW (1990): Tumor promotion in the mouse skin by 60 Hz magnetic field. Abstract: 12th Annual Meeting, Bioelectromagnetic Society, San Antonio, Texas, June 1990.

9.4 REFERENCES FOR SECTION 5 (cont'd)

McLean JRN, Stuchly MA, Mitchel REJ, Goddard M, Lecuyer DW (1991): Cancer co-promotion in the mouse skin model by 60-Hz magnetic fields: Tumor development and immune response. Abstract: 13th Annual Bioelectromagnetics Society Meeting, Salt Lake City, Utah, June 1991. Bioelectromagnetics Society, Frederick, Maryland.

McLeod KJ, Lee RC, Ehrlich HP (1987): Frequency dependence of electric field modulation of fibroblast protein synthesis. *Science* 236:1465.

McLeod KJ, Rubin CT (1990): Frequency specific modulation of bone adaptation by induced electric fields. *J. Theor. Biol.* 145:385.

McLeod KJ, Donahue HJ, Levin PE, Rubin CT (1991): Temporal response of bone cells to physical stimuli: changes in calcium mobilization following electrical stimulation. *Trans. Orthop. Res. Soc.* 37:12.

Mooney V (1990): A randomized double-blind prospective study of the efficacy of pulsed electromagnetic fields for interbody lumbar fusions. *Spine* 15:708.

Murray JC, Lacy M, Fitton-Jackson S (1988): Degradative pathways in cultured synovial fibroblasts: Selective effects of pulsed electromagnetic fields. *J. Orthop. Res.* 6:24.

Nessler JP, Mass DP (1987): Direct current electrical stimulation of tendon healing in vitro. *Clin. Orthop.* 217:303.

Olcese J (1990): The neurobiology of magnetic field detection in rodents. *Prog. Neurobiol.* 35:325-330.

Olcese J, Hurlbut EC (1989): Comparative studies on retinal dopamine response of altered magnetic fields in rodents. *Brain Res.* 498:145-149.

Olcese J, Reuss S, Vollrath L (1985): Evidence for the involvement of the visual system in mediating magnetic field effects on pineal melatonin synthesis in the rat. *Brain. Res.* 333:382-384.

Olcese J, Reuss S, Stehle J, Steinlechner S, Vollrath L (1987): The mammalian pineal gland and retinae as geomagnetic field detectors. In: *Fundamentals and clinics in pineal research*, G.P. Trentini, C. De Gaetani, and P. Pevet, eds., New York: Raven, pp. 79-82.

Olcese J, Reuss S, Semm P (1988a): Geomagnetic field detection in rodents. *Life Sci.* 42:605-613.

Olcese J, Reuss S, Stehle J, Steinlechner S, Vollrath L (1988b): Responses of the mammalian retina to experimental alteration of the ambient magnetic field. *Brain Res.* 448:325-330.

9.4 REFERENCES FOR SECTION 5 (cont'd)

- Onuma EK, Hui S (1988): Electric field-directed cell shape changes, displacement, and cytoskeletal reorganization are calcium dependent. *J. Cell. Biol.* 106:2067.
- Orgel MG, O'Brien WJ, Murray HM (1984): Pulsing electromagnetic field therapy on nerve regeneration: An experimental study in the cat. *Plast. Reconst. Surg.* 73:173.
- Orr JL, Rogers WR (1985): Determination of threshold intensity for detection of 60 Hz electric fields. Abstract: Seventh Ann. Mtg. Bioelectromagnetics Soc., p. 58.
- Patterson D (1984): Treatment of non-union with a constant direct current: A totally implantable system. *Orthop. Clin. NA* 15:49.
- Phillips JL, Winters WD, Rutledge L (1986): In vitro exposure to electromagnetic fields: Changes in tumor cell properties. *Int. J. Radiat. Biol.* 49:463-469.
- Phillips JL, Rutledge L, Winters W (1986a): Transferrin binding to two human colon carcinoma cell lines: Characterization and effect of 60 Hz electromagnetic fields. *Cancer Res.* 46:239.
- Phillips JL, McChesney L (1991): Effect of 72 Hz pulsed magnetic field exposure on macromolecular synthesis in CCRF-CEM cells. *Cancer Biochem. Biophys.* 12:1-7.
- Phillips JL (in press): Effects of electromagnetic field exposure on gene transcription. *J. Cell Biochem.*
- Phillips JL, Haggren W, Thomas WJ, Ishida-Jones T, Adey WR (in press): Magnetic field-induced changes in specific gene transcription. *Biochem. Biophys. Acta.*
- Pilla AA (1974): Electrochemical information transfer at living cell membranes. *Ann. N.Y. Acad. Sci.* 238:149.
- Pilla AA, Figueiredo M, Nasser PR, Kaufman JJ, Siffert RS (1992): *Bioelectrochem and bioenergetics*, in press.
- Politis MJ, Zanakis MF, Albala BJ (1988): Galvanotropic regeneration of the mammalian optic nerve. *J. Trauma* 28:1548.
- Pollack SR (1984): Bioelectrical properties of bone. Endogenous electrical signals. *Orthop. Clin. NA* 15:3.
- Rannug A, Holmberg B, Mild KH (1990): Studies of 50 MHz alternating magnetic fields in a rat liver foci bioassay. Abstract: 12th Annual Meeting of the Bioelectromagnetics Society, June 1990.

9.4 REFERENCES FOR SECTION 5 (cont'd)

Reddi AH, Wientroub S, Muthukumaran N (1987): Biologic principles of bone induction. *Orthop. Clin. NA* 18:207.

Reese J, Jostes R, Frazier M (1988): Exposure of mammalian cells to 60-Hz magnetic or electric fields: analysis for DNA single-strand breaks. *Bioelectromagnetics* 9:237-247.

Reiter RJ (ed.) (1981): *The pineal gland*, Vols. I and II. Boca Raton, Florida: CRC Press.

Reiter RJ (1985): Action spectra, dose-response relationships, and temporal aspects of light's effects on the pineal gland. *Ann. N.Y. Acad. Sci.* 453:215-230.

Reiter RJ (1987): The melatonin message: Duration versus coincidence hypotheses. *Life Sci.* 40:2119-2131.

Reiter RJ, Anderson LE, Buschbom RL, Wilson BW (1988): Reduction of the nocturnal rise in pineal melatonin levels in rats exposed to 60 Hz electric fields in utero and for 23 days after birth. *Life Sci.* 42:2203-2206.

Reiter RJ (1991a): Melatonin: That ubiquitously acting pineal hormone. *News Physiol. Sci.* 6:223-227.

Reiter RJ (1991b): Pineal melatonin: Cell biology of its synthesis and of its physiological interactions. *Endocrine Rev.* 12:151-180.

Reiter RJ, Richardson BA (1992): Magnetic field effects on pineal metabolism and possible biological consequences. *FASEB Journal*, Vol. 6, pp. 2283-2287.

Reuss S, Semm P, Vollrath L (1983): Different types of magnetically sensitive cells in the rat pineal gland. *Neurosci. Lett.* 40:23-26.

Reuss S, Olcese J, Vollrath L, Skalej M, Meves M (1985): Lack of effect of NMR-strength magnetic fields on rat pineal melatonin synthesis. *IRCS Med. Sci.* 13:471.

Rodan GA, Bourret LA, Norton LA (1978): DNA synthesis in cartilage cells is stimulated by oscillating electric fields. *Science* 199:690.

Rogers WR, Feldstone CS, Gibson EG, Polonis JJ, Smith HD, Cory WE (1987): Effects of high-intensity, 60-Hz electric fields on operant and social behavior of nonhuman primates. In: *Interaction of biological systems with static and elf electric and magnetic fields*, L.E. Anderson, R.J. Weigel, G.J. Kelman (eds.). Proceedings of the 23rd Annual Hanford Life Sciences Symposium, Richland, Washington, pp. 365-378. NTIS. CONF841041. Springfield, Virginia.

9.4 REFERENCES FOR SECTION 5 (cont'd)

Rogers WR, Reiter RJ, Smith HD, Barlow-Walden L (1991): Under some circumstances, combined electric and magnetic field exposure reduces serum melatonin concentration in nonhuman primates. Abstracts of the Annual Review of Research on Biological Effects of 50 and 60 Hz Electric and Magnetic Fields, Milwaukee, Wisconsin, p. A-26.

Rosenthal M, Obe G (1989): Effects of 50 hertz electromagnetic fields on proliferation and on chromosomal alterations in human peripheral lymphocytes untreated or pretreated with chemical mutagens. *Mutation Res.* 210:329-335.

Rubin CT, Lanyon LE (1984): Regulation of bone formation by applied dynamic loads. *J. Bone Joint Surg.* 66A:397. Rubin CT, Lanyon LE (1987): Osteoregulatory nature of mechanical stimuli: function as a determinant for adaptive remodeling of bone. *J. Orthop. Res.* 5:300.

Rubin CT, McLeod KJ, Lanyon LE (1989): Prevention of osteoporosis by pulsed electromagnetic fields. *J. Bone Joint Surg.* 71A:411.

Rudolph K, Wirz-Justice A, Krauchli K, Feer H (1988): Static magnetic fields decrease nocturnal pineal cAMP in the rat. *Brain Res.* 446:159-160.

Sah RL, Kim YJ, Doong JH, Grodzinsky AJ, Plaas AH, Sandy JD (1989): Biosynthetic response of cartilage explants to dynamic compression. *J. Orthop. Res.* 7:619.

Sasser LB, Morris JE, Buschbom RL, Miller DL, Anderson LE (1991): Effect of 60 Hz electric fields on pineal melatonin during various times of the dark period. Abstracts of the Annual Review of Research on Biological Effects of 50 and 60 Hz Electric and Magnetic Fields, Milwaukee, Wisconsin, p. A-24.

Seegal RF, Wolpaw JR, Dowman R (1989): Chronic exposure of primates to 60-Hz electric and magnetic fields, II: Neurochemical effects. *Bioelectromagnetics* 10:287-301.

Semm P, Schneider T, Vollrath L (1980): Effects of an earth-strength magnetic field and electrical activity of pineal cells. *Nature* 288:607-608.

Shamos MH, Lavine LS, Shamos MI (1963): Piezoelectric effect in bone. *Nature* 197:81.

Sharrard WJW (1990): A double-blind trial of pulsed electromagnetic fields for delayed union of tibial fractures. *J. Bone Joint Surg.* 72B:347.

Shimizu T, Zerwekh JE, Videman T, Gill K, Mooney V, Holmes RE, Hagler HK (1988): Bone ingrowth into porous calcium phosphate ceramics: Influence of pulsing electromagnetic field. *J. Orthop. Res.* 6:248.

9.4 REFERENCES FOR SECTION 5 (cont'd)

Sisken BF, McLeod B, Pilla AA (1984): PEMF, direct current and neuronal regeneration: effect of field geometry and current density. *J. Bioelec.* 3:81.

Sisken BF, Kanje M, Lundborg G, Herbst E, Kurtz W (1989): Stimulation of rat sciatic nerve regeneration with pulsed electromagnetic fields. *Brain Res.* 485:309.

Skerry TM, Pead MJ, Lanyon LE (1991): Modulation of bone loss during disuse by pulsed electromagnetic fields. *J. Orthop. Res.* 9:600.

Smith OL, Goodman EM, Greenebaum B, Tipnis P (1991): An increase in the negative surface charge of U937 cells exposed to a pulsed magnetic field. *Bioelectromagnetics* 12:197.

Smith RL, Nagel DA (1983): Effects of pulsing electromagnetic fields on immature bone growth and articular cartilage. *Clin. Orthop.* 181:278.

Stehle J, Reuss S, Schroder H, Herschel M, Vollrath L (1988): Magnetic field effects on pineal N-acetyltransferase activity and melatonin content in the gerbil - Role of pigmentation and sex. *Physiol. Behav.* 44:91-94.

Steinberg ME, Brighton CT, Bands RE, Hartman KM (1990): Capacitive coupling as an adjunctive treatment for avascular necrosis. *Clin. Orthop.* 261:11.

Tabrah F, Hoffmeier M, Gilbert F, Batkin S, Bassett CAL (1990): Bone density changes in osteoporosis-prone women exposed to pulsed electromagnetic fields. *J. Bone Mineral Res.* 5:437.

Takahashi K, Kaneko I, Date M, Fukada E (1986): Effect of pulsing electromagnetic fields on DNA synthesis in mammalian cells in culture. *Experientia* 42:185-186.

Tamarkin L, Danforth D, Lichter A, Demoss E, Cohen B, Chabner B, Lippman M (1982): Decreased nocturnal plasma melatonin peak in patients with estrogen receptor positive breast cancer. *Science* 216:1003-1005.

Tenforde TS (1991): Biological interactions of extremely low frequency electric and magnetic fields. *J. Electroanal. Chem.* 320:1-17.

Tenforde TS (1989): Biological responses to static and time-varying magnetic fields. In: *Electromagnetic interaction with biological systems*, James C. Lin (ed). Plenum Publishing Corporation.

Thomas JR, Schrot J, Liboff R (1986): Low-intensity magnetic fields alter operant behavior in rats. *Bioelectromagnetics* 7:349-357.

9.4 REFERENCES FOR SECTION 5 (cont'd)

Trosko JE, Chang CC (1987): Oncogene and chemical inhibition of gap-junctional communication: Implications for teratogenesis and carcinogenesis. In: *Genetic toxicology of environmental chemicals, Part B: Genetic effects and applied mutagenesis*. New York: Allan R. Liss.

Vasquez BJ, Anderson LE, Lowrey CI, Adey WR (1988): Diurnal patterns in brain biogenic amines of rats exposed to 60 Hz electric fields. *Bioelectromagnetics* 9:229-236.

Villa M, Mustarrelli P, Caprotti M (1991): Biological effects of magnetic fields. *Life Sci.* 49:85-92.

Walborg EF (1991): *Extremely low frequency electromagnetic fields and cancer: Focus on tumor initiation, promotion, and progression*. Prepared for National Electric Manufacturers Association (NEMA).

Wei LX, Goodman R, Henderson AS (1990): Changes in levels of c-myc and histone H2B following exposure of cells to low-frequency sinusoidal electromagnetic fields: Evidence for a window effect. *Bioelectromagnetics* 11:269.

Welker HA, Semm P, Willig RP, Commentz JC, Wiltschko W, Vollrath L (1983): Effects of an artificial magnetic field on serotonin N-acetyltransferase activity and melatonin content in the rat pineal gland. *Exp. Brain Res.* 50, 426-432.

Wever R (1973): Human circadian rhythms under the influence of weak electric fields and the different aspects of these studies. *Int. J. Biometeorol.* 17:227-232.

Wilson BW, Snedden W, Mullen PE, Silman RE, Smith I, Laudon J (1977): A gas chromatography-mass spectrometry method for the quantitative analysis of melatonin in plasma and cerebrospinal fluid. *Anal. Biochem.* 81:283-291.

Wilson BW, Anderson LE, Hilton DI, Phillips RD (1981): Chronic exposure to new line 60-Hz electric fields: Effects on pineal function in the rat. *Bioelectromagnetics* 2:371-380.

Wilson BW, Chess EK, Anderson LE (1986): 60 Hz electric-field effects on pineal melatonin rhythms: Time course for onset and recovery. *Bioelectromagnetics* 7:239-242.

Wilson BW, Anderson LE (1990): ELF electromagnetic field effects on the pineal gland. In: *Extremely low frequency electromagnetic fields: The question of cancer*. B.W. Wilson, R.G. Stevens, and L.E. Anderson, eds. Columbus: Battelle Press, pp. 159-186.

Wilson BW, Wright CW, Morris JE, Buschbom RL, Brown DP, Miller DL, Sommers-Flanigan R, Anderson LE (1990): Evidence for an effect of ELF electromagnetic fields on human pineal gland function. *J. Pineal Res.* 9:259-269.

9.4 REFERENCES FOR SECTION 5 (cont'd)

Wiltschko, W., and Wiltschko, R.: Orientation by the Earth's magnetic field in migrating birds and homing pigeons. In *Progress in biometeorology, vol. 8, Effects of atmospheric and geophysical variables in biology and medicine* (H. Lieth, ed.). SPB Academic Publishing, The Hague, Netherlands, 1991, pp. 31—43.

Yamasaki H (1987): The role of cell-to-cell communication in tumor promotion. In: *Nongenotoxic mechanisms in carcinogenesis; 25th Banbury Report*, Cold Spring Harbor Laboratory, New York 11724, pp. 297-309.

Yamasaki H (1991): Aberrant expression and function of gap junctions during carcinogenesis. *Environ. Health Perspectives* 93:191-197.

Yasuda I (1954): Piezoelectric activity of bone. *J. Japanese Orthop. Surg. Soc.* 28:267.

Yellon SM (1991): An acute 60 Hz magnetic field exposure suppresses the nighttime melatonin rise in the pineal and circulation of the adult Djungarian hamster. Abstracts of the Annual Review of Research on Biological Effects of 50 and 60 Hz Electric and Magnetic Fields, Milwaukee, Wisconsin, p. A-25.

Yen-Patton GPA, Patton WF, Beer DM, Jacobson BS (1988): Endothelial cell response to pulsed electromagnetic fields: Stimulation of growth rate and angiogenesis in vitro. *J. Cell. Physiol.* 134:37.

Zecca L, Ferrario P, Margonato V, Cerretelli P, Zonta N (1991): Neurotransmitter amino-acid variations in striatum of rats exposed to 50 Hz electric fields. *Biochem. Biophys. Acta* A1075:1-5.

Zienowicz RJ, Thomas BA, Kurtz WH, Orgel MG (1991): A multivariate approach to the treatment of peripheral nerve transection injury: The role of electromagnetic field therapy. *Plast. Reconstr. Surg.* 87:122.

9.5 REFERENCES FOR SECTION 6

Axelrod J, Weisbach H (1960): Enzymatic O-methylation of N-acetylserotonin to melatonin. *Science* 131:1312.

Beniashvili D, Vilanishvili VG, Manabde MZ (1991): Low frequency electromagnetic radiation enhances induction of rat mammary tumors by hitrosomethylurea. *Cancer Letters* 61:75-79.

Blask DE (1990) The emerging role of the pineal gland and melatonin in oncogenesis. In: *extremely low frequency electromagnetic fields: The question of cancer*, Wilson BW, Stevens RG and Anderson LE (eds), Battelle Press, Columbus.

9.5 REFERENCES FOR SECTION 6 (cont'd)

Cotman CW, Brinton RE, Galaburda A, McEwen B, Schneider DM (1987): *The neuro-immune-endocrine connection*. New York: Raven Press, 150 pp.

Demers PA, Thomas DB, Rosenblatt KA et al. (1991): Occupation exposure to electromagnetic fields and breast cancer in men. *Am. J. Epidemiol.* 134:340-370.

Georgiou E (1929): Uber die Natur und die Pathogenese der Krebstumoren Radiale Heilung des Krebses bei weissen Mausem. *Zeit. Krebsforsch.* 38:562-572.

Groh KR, Ready MA, Ehret CF, (1990): Chronobiological effects of electric fields. In: *Extremely low frequency electromagnetic fields: The question of cancer*. B.W. Wilson, R.G. Stevens, and L.E. Anderson, eds. Columbus: Battelle Press, pp. 47-86.

Groh, KR (1993): The biological effects of maglev-generated electromagnetic fields. Draft report (DTRS-57-90-00103). U.S. Department of Transportation. Prepared by Argonne National Laboratory, Argonne IL 60434.

Hariharasabramanian N, Nair NPV, Pilapil C (1985): Circadian rhythm of plasma melatonin and cortisol during the menstrual cycle in the pineal gland: Endocrine aspects. In Brown GM, Wainwright SD (eds): *Advances in the Biosciences*, Vol. 53. Oxford: Pergamon Press.

Kamberi IA, Mical RS, Porter JC (1971): Effects of melatonin and serotonin on release of FSH and prolactin. *Endocrinol* 88:1288-1293.

Lerchl A, Nonaka KO, Stokkan K-A, Reiter RJ (1990): Marked rapid alterations in nocturnal pineal serotonin metabolism in mice and rats exposed to weak intermittent magnetic fields. *Biochem. Biophys. Res. Commun.* 169:102-108.

Lerchl A, Nonaka KO, Reiter RJ (1991): Pineal gland "magnetosensitivity" to static magnetic fields is a consequence of induced electric currents (eddy currents). *J. Pineal Res.* 10:109-116.

Lewy AJ, Sack RL, Miller LS, Hoban TM, Singer CM, Samples JR, Krauss GL (1986): The rise of plasma melatonin levels and light in the assessment and treatment of chronobiologic sleep and mood disorders. *J. Neural Transm., Suppl.* 21:311-322.

Maestroni, GJM, Conti, A, Pierpaoli W (1986): Role of the pineal gland in immunity circadian synthesis and release of melatonin modulates the antibody response and antagonist immunosuppressive effect of corticosterone. *J. Neuroimmunol.* 13:19-30

Maestroni GJM, Conti A (1991a): Action of melatonin on immune system. In: *Role of melatonin and pineal peptides in neuroimmunomodulation*, F. Fraschini and R.J. Reiter, eds. New York: Plenum, pp. 201-210.

9.5 REFERENCES FOR SECTION 6 (cont'd)

- Maestroni GJM, Conti A (1991b): Beta-endorphin and dymorphin mimic the circadian immunoenhancing and anti-stress effects of melatonin. *Int. J. Immunopharmacol.* 11:333-337.
- Moore-Ede MC, Sulzman FM, Fuller CA (1982): *The clocks that time us. Physiology of the circadian timing system.* Harvard University Press, Cambridge. ISBN 0-674-13580-6.
- Nir, I (1978): Non-reproductive systems and the pineal gland. *J. Neural Transm. (Suppl.)* 13:225-244.
- Olcese J, Reuss S, Vollrath L (1985): Evidence for the involvement of the visual system in mediating magnetic field effects on pineal melatonin synthesis in the rat. *Brain Res.* 333:382-84.
- Olcese J, Reuss S (1986): Magnetic field effects on pineal gland melatonin synthesis: comparative studies on albino and pigmented rodents. *Brain Res.* 369:365-68.
- ORAU, (1992): *Health effects of low-frequency electric and magnetic fields.* Prepared by an Oak Ridge Associated Universities Panel for The Committee on Interagency Radiation Research and Policy Coordination. Report ORAU 92/F8, June 1992.
- Papke RL, Podleski TR, Oswald RE (1986): Effects of pineal factors on the action potentials of sympathetic neurons. *Cell Mol Biol* 6:381-395.
- Poole C, Kavet R, Funch DP, Donelan K, Chan JM, Dreyer N (1992): Depression and headaches in relation to an alternating-current electric power transmission line. *Am. J. Epidemiol.* (in press).
- Reiter RJ (1980): The pineal and its hormones in the control of reproduction in mammals. *Endocrine Rev.* 1:109-131.
- Reiter RJ (1985): Action spectra, dose-response relationships, and temporal aspects of light's effects on the pineal gland. *Ann. N.Y. Acad. Sci.* 453:215-230.
- Reiter RJ (1986): Normal patterns of melatonin levels in the pineal gland the body fluids of human and experimental animals. *J. Neural Transm., Suppl.* 21:35-64.
- Reiter RJ (1987): The melatonin message: Duration versus coincidence hypotheses. *Life Sci.* 40:2119-2131.
- Semm P, Schneider T, Vollrath L (1980): Effects of an earth-strength magnetic field and electrical activity of pineal cells. *Nature* 288:607-608.
- Stevens RG, Davis S, Thomas DB, Anderson LE, Wilson BW (1992): Electric power and breast cancer risk. *FASEB J.,* Vol 6, 853-860.

9.5 REFERENCES FOR SECTION 6 (cont'd)

Stevens RG, et al. (1993).

Stokkan KA, Reiter RJ, Nonaka KO, Lerchl A, Yu BP, Vaughan MK (1991): Food restriction retards aging of the pineal gland. *Brain Res.* 545, 66-72.

Tamarkin L, Danforth D, Lubter A, DeMoss E, Cohen M, Chabner B, Lippman M (1982): Decreased nocturnal plasma melatonin peak in patients with estrogen receptor positive breast cancer. *Science* 216:1003-1005.

Theriault G (1991): Health effects of electromagnetic radiation on workers: Epidemiologic studies. *Proc. Scientific Workshop on Health Effects of Electromagnetic Radiation on Workers*. NIOSH Publication, U.S. Department of Health and Human Services.

Tynes T, Anderson A (1990): Electromagnetic fields and male breast cancer. *The Lancet* 1596.

Walborg EF (1991): *Extremely low frequency electromagnetic fields and cancer: Focus on tumor initiation, promotion and progression*. National Electrical Manufacturers Association, Washington, D.C.

Welker HA, Semm P, Willig RP, Commentz JC, Wiltshko W, Vollrath L (1983): Effects of an artificial magnetic field on serotonin N-acetyltransferase activity and melatonin content in the rat pineal gland. *Exp. Brain Res.* 50:426-432.

Wilson BW, Anderson LE, Hilton DI, Phillips RD (1981): Chronic exposure to 60-Hz electric fields: Effects on pineal function in the rat. *Bioelectromagnetics* 2:371-380.

Wilson BW, Lueng F, Buschbom R, Stevens RG, Anderson LE, Reiter RJ (1988): Electric fields, the pineal gland and cancer. In: *The pineal gland and cancer*, D. Gupta, A. Attanasio, R.J. Reiter, eds. Brain Research Promotions, Tuebingen, pp. 245-259.

Wilson, BW, Stevens, RG, Anderson, LE (1989): Neuroendocrine mediated effects of electromagnetic-field exposure: Possible role of the pineal gland. *Life Sciences*, 45:1319-1332.

Wilson BW, Wright CW, Morris JE, Buschbom RL, Brown DP, Miller DL, Sommers-Flannigan R, Anderson LE (1990): Evidence for an effect of ELF electromagnetic fields on human pineal gland functions. *J.Pineal.Res.* 9:259-269.

Wilson BW, Lovely RH, Davis K, Hansen NH (1993): Changes in hypothalamus and pineal gland function in the Djungarian Hamster from short-term exposure to 60Hz magnetic fields. 15th Annual Bioelectromagnetic Society Meeting, Los Angeles, CA, June 13-17, 1993.

9.5 REFERENCES FOR SECTION 6 (cont'd)

Wurtman, RJ and Anton Tay, F (1969): The mammalian pineal as a neuro endocrine transducer. *Rec. Prog. Horm. Res.* 25, pp. 493-522.

Yellon SM (1991): An acute 60 Hz magnetic field exposure suppresses the nighttime melatonin rise in the pineal and circulation of the adult Djungarian hamster. Abstracts of the Annual Review of Research on Biological Effects of 50 and 60 Hz Electric and Magnetic Fields, Milwaukee, Wisconsin, p. A-25.

9.6 REFERENCES FOR SECTION 7

Adey WR (1990): Electromagnetic fields and the essence of living systems. In: *Modern radio science*, JB Andersen (ed.). Oxford: Oxford University Press, pp. 1-37.

Ames BN, Gold LS (1990): Too many rodent carcinogens; mitogenesis increases mutagenesis. *Science* 249:970-971.

Anderson LE (1991): Biological effects of extremely low frequency electromagnetic fields: In vivo studies. In: *Proceedings of scientific workshop on health effects of electromagnetic radiation on workers*. U.S. Department of Health and Human Services, Cincinnati, Ohio, January 1991.

Balli-Antunes M, Pfluger DH, Minder CE (1990): The mortality from malignancies of the hematopoietic and lymphatic systems (MHLs) among railway engine drivers. *Environmetrics* 1:121-130.

Baroncelli P, Battista S, Checcucci A, Comba P, Grandolfo M, Serio A, Vecchia P (1986): A health examination of railway high voltage substation workers exposed to ELF electromagnetic fields. *Am. J. Med.* 10:45-55.

Bastuji-Garin S, Richardson S, Zittoun R (1990): Acute leukemia in electrical workers exposed to electromagnetic fields. *Eur. T. Cancer* 26:1119-1120.

Beck-Friis J, Kjellman BF, Aperia B, Uden F, Von Rosen D, Ljunggren J-G, Wetterberg L (1985): Serum melatonin in relation to clinical variables in patients with major depressive disorder and a hypothesis of a low melatonin syndrome. *Acta. Psychiatr. Scand.* 71(4):319-330.

Berenblum I, Shubik P (1947): The role of croton oil applications, associated with a single painting of a carcinogen, in tumor induction in the mouse's skin. *Brit. J. Cancer* 1:379-391.

Blask DE (1990): The emerging role of the pineal gland and melatonin in oncogenesis. In *Extremely low frequency electromagnetic fields: The question of cancer*, Wilson BW, Stevens RG and Anderson LE (eds.). Columbus: Battelle Press.

9.6 REFERENCES FOR SECTION 7 (cont'd)

Bowman JD, Garabrant DH, Sobel E, Peters JM (1988): Exposures to extremely low frequency (ELF) electromagnetic fields in occupations with elevated leukemia rates. *Appl. Ind. Hyg.*, 3:189-194.

Bowman JD, Thomas DC, Peters JM (1991): The risk of childhood leukemia from home exposure to resonances from static and power frequency magnetic fields (Abstract A-40). Proc. DOE Contractors meeting, Milwaukee, Wisconsin, Nov. 1991.

Calle E, Savitz DA (1985): Leukaemia in occupational groups with presumed exposure to electrical and magnetic fields. *N. Engl. J. Med.* 313:1476-7.

Cobolov DL, Rubin RT (1987): Endocrine disturbances in affective disorders and schizophrenia. In *Handbook of psycho-neuroendocrinology*, Nemeroff CB and Loosen PT (eds.). London, New York: Guildford Press.

Davis RL, Milham S (1990): Altered immune status in aluminum reduction plant workers. *Am. J. Industrial Hyg.* 18:79-87.

Deadman JE, Camus M, Armstrong BG, et al. (1988): Occupational and residential 60-Hz electromagnetic fields and high-frequency electric transients: Exposure assessment using a new dosimeter. *Am. Ind. Hyg. Assoc. J.* 49:409-19.

De Guire L, Theriault G, Iturra H, Provenhers S, Cyr D, Case BW (1988): Increased incidence of malignant melanoma of the skin in workers in the telecommunications industry. *Brit. J. Ind. Med.* 45:824-828.

Demers P et al. (1990): Occupation exposure to electromagnetic fields and breast cancer in men. Presented at the 23rd Annual Meeting of the Society for Epidemiologic Research. Snowbird Ski and Summer Resort, Utah, June 15, 1990.

Demers PA, Rosenblatt KA, Jimenez LM, McTiernan A, Stalsberg H, Stemhagen A, Thompson WD, Curnen MGM, Satariano W, Audtin DF, Isacson P, Greenberg RS, Key C, Kolenel LN, West DW (1991): Occupational exposure to electromagnetic fields and breast cancer in men. *Am. J. Epidemiol.* 134:340-370.

Dirlich G, Kammerloher A, Shultz H, Lund R, Doerr P, von Zerssen B (1981): Temporal co-ordination and rest activity cycle body temperature, urinary free cortisol, and mood in a patient with unipolar-depressive cycles in clinical and time cue free environments. *Biological Psychiatry* 16:163-179.

Drinkwater NR, Sugden B (1990): Mechanisms of carcinogenesis. In: *Manual of clinical oncology, 5th edition*, DK Hossfeld, CD Sherman, RR Love, FX Bosch (eds.). New York: Springer Verlag.

9.6 REFERENCES FOR SECTION 7 (cont'd)

Feychting M, Ahlbom A (1992): *Magnetic fields and cancer in people residing near Swedish high voltage power lines*. IMM - rapport 6/92 Institute for miljmdicin, Karolinsk Institute, Sweden.

Floderus B, Persson T, et al. (1992): *Occupational exposure to electromagnetic fields in relation to leukemia and brain tumors: A case control study*. PM edition: National Institute of Occupational Health, Solna Sweden.

Florig HK, Holberg JF (1990): Power frequency magnetic fields from electric blankets. *Health Physics* 58:493-502.

Gallagher RP, Elwood JM, Rootman J, Spinelli JJ, Hill GB, Threlfall WJ, Birdsell JM (1985): Risk factors for ocular melanoma: Western Canada melanoma study. *JNCI* 74:775-778.

Garland FC, Shaw E, Gorham ED, Garland CF, White MR, Sinsheimer P (1990): Incidence of leukemia in occupations with potential electromagnetic fields exposure in United States Navy personnel. *Am. J. Epidemiol.* 132:293-303.

Gatti RA, Good RA (1971): Occurrence of malignancy in immunodeficiency diseases. *Cancer* 28:89-98.

Gauger JR (1985): Household appliance magnetic field survey. *IEEE Trans. Pwr. Appar. Sys.* PAS-104:2436-44.

Gilman PA, James RG, McCawley A (1985): Leukemia risk among U.S. white male coal miners. *JOM* 27:669-671.

Glass AG, Hoover RN (1990): Rising incidence of breast cancer: Relationship to stage and receptor status. *J. Natl. Cancer Inst.* 82:693-696.

Hammond WP (1990): Oncogenes and Leukemia. In: *Extremely low frequency electromagnetic fields: The question of cancer*. B.W. Wilson, R.G. Stevens, and L.E. Anderson (eds.). Columbus: Battelle Press.

Hietanan M (1992): Strong magnetic fields may cause miscarriages. *VDT News*, Lew Slesin (ed.), March/April 1992 (advance press release of study results from study in Finland).

Hill AB (1953): Observation and experiment. *New England J. Med.* 248:995-1001.

Howe GR, Lindsay JP (1983): A follow-up study of a ten percent sample of the Canadian Labour Force 1: Cancer mortality in males 1965-1973. *JNCI*, 70:37-44.

Hossfeld DK (1990): *Manual of clinical oncology*. DK Hossfeld, CD Sherman, RR Love, and FX Bosch (eds.). New York: Springer Verlag.

9.6 REFERENCES FOR SECTION 7 (cont'd)

Jackson JD (1992): Are the stray 60-Hz electromagnetic fields associated with distribution and use of electric power a significant cause of cancer? *Proc. Nat. Acad. Sci. USA* 89:3508-3510.9.6

Juutilainen J, Pukkala E, Laara E (1988): Results of epidemiological cancer study among electrical workers in Finland. *J. of Bioelectricity* 7:119-121.

Kandel ER, Schwartz JH, Jessell TM (1991): *Principles of neural science*. New York: Elsevier, pp. 805-810.

Kaune WT, Stevens RG, Callahan NJ et al. (1987): Residential magnetic and electric fields. *Bioelectromagnetics* 8:315-335.

Koch R (1882): The aetiology of tuberculosis. *Berlin Klin. Wschr.* 19:221. Translated and reprinted in: *Aetiology of tuberculosis*. Pinner M. (Transl.), National Tuberculosis Association. New York, 1932.

Lee GM, Yost MB, Neutra RR, Hristova L, Duane D, Tarshis T, Hiatt R, Leonard AR (1992): Descriptive assessment of 24 hour personal exposure to 60 Hz fields using a rate of change metric (Abstract). First World Congress for Electricity and Magnetism in Biology and Medicine. Lake Buena Vista, Florida, June 14-19, 1992.

Lewy A, Sack R, Miller S, Hoban T (1987): Antidepressant and circadian phase-shifting effects of light. *Science* 235:352-354.

Lewy AJ, Wehr TA, Goodwin FK et al. (1980): Light suppresses melatonin secretion in humans. *Science* 210:1267-1269.

Lin R, Dischinger PC, Conde J, Farrell KP (1985): Occupational exposure to electromagnetic fields and the occurrence of brain tumors. *J. Occup. Med.* 27:413-419.

Linet M, Malker H, McLaughlin J, Weiner J, Stone BJ, Blot W, Ericsson J, Fraumeni JF (1988): Leukemias and occupation in Sweden: A registry-based analysis. *Am. J. Ind. Med.* 14:319-330.

London SJ, Thomas DC, Bowman JD, Sobel E, Cheng T-C, Peters JM (1991): Exposure to residential electric and magnetic fields and the risk of childhood leukemia. *Am. J. Epidemiol.* 134:923-937.

Lovely RH, Buschbom RL, Slavich AL, Anderson LE (1992): EMF and leukemia: Exposure assessment at the razor's edge (Abstract A-46). Annual Review of Research on Biological Effects of Electric and Magnetic Fields from the Generation, Delivery and Use of Electricity, San Diego, California, November 8-12, 1992.

9.6 REFERENCES FOR SECTION 7 (cont'd)

Lyle DB, Ayotte RD, Sheppard AR, Adey WR (1988): Suppression of T-lymphocyte cytotoxicity following exposure to 60 Hz sinusoidal electric fields. *Bioelectromagnetics* 4:303-313.

Mack WS, Preston-Martin S, Peters J (1991): Astrocytoma risk related to job exposure to electric and magnetic fields. *Bioelectromagnetics* 12:57-66.

Matanoski G, Elliott E, Breyse P (1989): Cancer incidence in New York telephone workers. Poster presented at the Annual Department of Energy-Electric Power Research Institute Contractor's Review, Portland, Oregon, November 1989 (Abstract).

Matanoski GM, Breyse PN, Elliot EA (1991a): Electro-magnetic field exposure and male breast cancer. *The Lancet* 337:737.

Matanoski GM (1991b): Results of occupational magnetic field study announced. (Abstract) Environmental Update, Electric Power Research Institute, Palo Alto, California, September 1991.

McIntyre IM, Norman TR, Burrows GB, Armstrong SM (1990): Melatonin supersensitivity to dim red light in seasonal affective disorder. *Lancet* 335:488.

Milham S (1976): *Occupational mortality in Washington State 1950-1971*. National Institute for Occupational Safety and Health (NIOSH) Publication #76-175-A,B,C.

Milham S (1982): Mortality from leukemia in workers exposed to electric and magnetic fields. *New Engl. J. Med.* 307:249.

Milham S (1985a): Mortality in workers exposed to electromagnetic fields. *Env. Health Perspect.* 62:297-300.

Milham S (1985b): Silent keys: leukemia mortality in amateur radio operators. *Lancet* 1:811.

Milham S (1988): Increased mortality in amateur radio operators due to lymphatic and hematopoietic malignancies. *Am. J. Epidemiol.* 127:50-54.

Moline ML, Wagner DR (1987): Neuroendocrine and other biological rhythms in psychiatric illness. In: *Handbook of clinical psychoneuroendocrinology*, CB Nemeroff and PT Loosen (eds.). New York: Guildford Press, pp. 209-235.

MWN (1992): Swedish officials acknowledge EMF - Cancer connection; *Microwave News* XII, No. 5. pg. 1,12, L.Slesin (ed.), September, October, 1992.

9.6 REFERENCES FOR SECTION 7 (cont'd)

- Nair I, Morgan MG, Florig HK (1989): *Biological effects of power frequency electric and magnetic fields - background paper*. U.S. Congress, Office of Technology Assessment, Government Printing Office, OTA-BP-E-53, Washington, D.C.
- Nakagawa M, Tomita M, Koana T, Odaka M, and Ohno K (1992): Estimation of standardized mortality rates in jnr (jpn. National railways) cohort by occupation. First World Congress for Electricity and Magnetism in Biology and Medicine, Lake Buena Vista, Florida, June 14-19, 1992.
- Narita T, Kudo H (1985): Effect on melatonin on B-16 melanoma growth in athymic mice. *Cancer Res.* 45:4175-4177.
- NRPB (1992): Electromagnetic fields and the risk of cancer. *Report of the advisory group on non-ionising radiation*. Vol 3, No 1. National Radiation Protection Board (R. Southwood Chairman). Chilton, UK. ISBN 0-85951-346-7.
- Pearce NE, Reif J, Frazer J (1989): Case control studies of cancer in New Zealand electrical workers. *Int. J. Epidemiol.* 18:55-59.
- Perry FS, Pearl L (1988): Power frequency magnetic fields and illness in multi-story blocks. *Public Health* 102:11-18.
- Perry FS, Reichmanis M, Marino AA, Becker RO (1981): Environmental power frequency magnetic fields and suicide. *Health Phys.* 41:267-277.
- Poole C, Kavet R, Funch DP, Donelan K, Chan JM, Dreyer N (1992): Depression and headaches in relation to an alternating-current electric power transmission line. *Am. J. Epidemiol.* (in press).
- PHS (1964): *Smoking and health. Advisory Committee to the Surgeon General of the Public Health Service*. P.H.S. Publication No.1103. Public Health Service, Washington, D.C., pp. 182-189.
- Preston-Martin S, Henderson SE, Peters JM (1982): Descriptive epidemiology of central nervous system neoplasias in Los Angeles County. *Ann. N.Y. Acad. Sci.* 381:202-208.
- Reichmanis M, Perry FS, Marino AA, Becker RO (1979): Relation between suicide and electromagnetic field of overhead power lines. *Physiol. Chem. Phys.* 11:395-403.
- Savitz DA, Calle EE (1987): Leukemia and occupational exposure to electromagnetic fields: Review of epidemiologic surveys. *J. Occup. Med.* 29:47-51.
- Savitz DA, Wachtel HA, Barnes F, John EM, Tvrdik JG (1988): Case-control study of childhood cancer and exposure to 60-Hz magnetic fields. *Am. J. Epidemiol.* 128:21-38.

9.6 REFERENCES FOR SECTION 7 (cont'd)

Savitz DA, John EM, Kleckner RC (1990): Magnetic field exposure from electric appliances and childhood cancer. *Am. J. Epidemiol.* 131:169-172.

Schnorr T et al. (1991): Video terminal displays and the risk of spontaneous abortion. *New England J. Med.* 324:727-733.

Severson RK, Stevens RG, Kaune WT, Thomas DB, Heuser L, Davis S, Sever LE (1988): Acute non-lymphocytic leukemia and residential exposure to power frequency magnetic fields. *Am. J. Epidemiol.* 128:10-20.

Sherman CD, Hossfeld DK (1990): Breast Cancer. In: *Manual of clinical oncology*, DK Hossfeld, CD Sherman, RR Love and FX Bosch (eds.). New York: Springer Verlag.

Slaga TJ (1989): Cellular and molecular mechanisms involved in multistage carcinogenesis. In *Skin tumors: Experimental and clinical aspects*, C.J. Conti, T.J. Slage, and A.J.P. Klein-Szanto (eds.). New York: Raven Press, pp. 1-18.

Speers MA, Dobbins JG, Miller VS (1988): Occupational exposures and brain cancer mortality: A preliminary study of East Texas residents. *Am. J. Ind. Med.* 13:629-638.

Spinelli J, Band P, Gallagher R, Oleniuk D, Svirchev L (1989): *Mortality and cancer incidence in workers at the ALCAN aluminum plant in Kitimat B.C.*, final report. Cancer Control Agency of British Columbia, October 1989.

Spitz MR, Johnson CC (1985): Neuroblastoma and paternal occupation: A case control analysis. *Am. J. Epidemiol.* 121:924-9.

Stanbury LR, Das Gupta TK, Beatie CW (1983): Photoperiodic control of melanoma growth in hamster: Influence of pinealectomy and melatonin. *Endocrinology* 113: 469.

Stern RM (1987): Cancer incidence among welders: Possible effects of exposure to extremely low frequency radiation ELF and welding fumes. *Environ. Health Perspectives* 76:221-229.

Stevens RG (1987): Electric power use and breast cancer, a hypothesis. *Am. J. Epidemiol.* 125:556-561.

Stevens RG, Davis S, Thomas DB, Anderson LE, Wilson BW (1992): Electric power, pineal function, and the risk of breast cancer. *FASEB J.* 6:853-860.

Swerdlow AJ (1983): Epidemiology of eye cancer in adults in England and Wales, 1962-1977. *Am. J. Epidemiol.* 118:317-324.

9.6 REFERENCES FOR SECTION 7 (cont'd)

Swerdlow AJ (1990): International trends in cutaneous melanoma. *Ann. New York Acad. Sci.* 609:235-251.

Tamarkin L, Danforth D, Lubter A, DeMoss E, Cohen M, Chabner B, Lippman M (1982): Decreased nocturnal plasma melatonin peak in patients with estrogen receptor positive breast cancer. *Science* 216:1003-1005.

Theriault G (1991): Health effects of electromagnetic radiation on workers: epidemiologic studies. *Proc. Scientific Workshop on Health Effects of Electromagnetic Radiation on Workers*. NIOSH Publication, U.S. Department of Health and Human Services.

Tynes T, Anderson A (1990): Electromagnetic fields and male breast cancer. *The Lancet* 1596.

Tynes T, Jynge H, Vistnes (1993): A nested case control study of leukemia and brain tumors in Norwegian railway workers. (Abstract) Fifteenth Annual Meeting of the Bioelectromagnetics Society Los Angeles, CA, June 13-17, 1993, pg 85.

Vagero D, Ahlbom A, Olin R, Sahlsten S (1985): Cancer morbidity among workers in the telecommunications industry. *Br. J. Ind. Med.*, 42:191-195.

Vagero D, Swerdlow AJ, Beral V (1990): Occupation and malignant melanoma, a study based on cancer registration data in Wales and in Sweden. *Brit. J. Indust. Med.* 47:317-324.

Vena JE, Graham S, Hellmann R, Swanson M, Brasure J (1990): Use of electric blankets and risk of postmenopausal breast cancer. *Am. J. Epidemiol.* 132:791.

Verreault R, Weiss NS, Hollenbach KA (1990): Use of electric blankets and risk of testicular cancer. *Am. J. Epidemiol.* 131:759-61.

Vogel W, Klaiber EL, Broverman DM (1978): Roles of gonadal steroid hormones in psychiatric depression in men and women. *Progress in Neuropsychopharmacology* 2, 487-503.

von Zerssen D (1983): Chronobiology of depression. In: *The origins of depression: Current concepts and approaches*, J. Angst. (ed.). Berlin: Springer Verlag, pp. 253-271.

Walborg EF (1991): *Extremely low frequency electromagnetic fields and cancer: Focus on tumor initiation, promotion and progression*. National Electrical Manufacturers Association, Washington, D.C.

Wehr TA, Goodwin FK (1983): Biological rhythms in manic depressive illness. In: *Circadian rhythms in psychiatry*, Wehr TA, Goodwin FK (eds.). Pacific Grove, California: Boxwood Press.

9.6 REFERENCES FOR SECTION 7 (cont'd)

Wertheimer N, Leeper E (1979): Electrical wiring configuration and childhood cancer. *Am. J. Epidemiol.* 109:273-284.

Wertheimer N, Leeper E (1982): Adult cancer related to electrical wires near the home. *Int. J. Epidemiol.* 11:345-355.

Wertheimer N, Leeper E (1986): Possible effects of electric blankets and heated water beds on fetal development. *Bioelectromagnetics* 1:13-22.

Wetterberg L, Beck-Friis J, Kjellman BF, Ljunggren JG (1984): Circadian rhythms in melatonin and cortisol secretion in depression. *Advances in Biochemical Psycho-pharmacology* 39:197-205.

Wilson BW, Stevens RG, Anderson LE (1989): Neuroendocrine mediated effects of electromagnetic-field exposure: Possible role of the pineal gland. *Life Sciences*, 45:1319-1332.

Wilson BW, Wright CW, Morris JE, Buschbom RL, Brown DP, Miller DL, Sommers-Flannigan R, Anderson LE (1990): Evidence for an effect of ELF electromagnetic fields on human pineal gland functions. *J. Pineal. Res.* 9:259-269.

Wilson BW (1988): Chronic exposure to ELF fields may induce depression. *Bioelectromagnetics* 9:195-205.

Wilson BW, Lee GM, Yost M, Davis C, Wilson M, Heimbigner T, Hartman J (1992): Magnetic fields from electric bed heating devices: Flux densities and spectral characteristics (Abstract A-41). Annual Review of Research on Biological Effects of Electric and Magnetic Fields from Generation, Delivery, and Use of Electricity, November 8 - 12, San Diego, California.

Wright WE, Peters JM, Mack TM (1982): Leukemia in workers exposed to electric and magnetic fields. *Lancet* 2:1160-4.

Zangwill L, Husted J, McCoil S (1992): A systematic review of the epidemiologic evidence of an association between power frequency EMF and cancer (Abstract). Annual Review of Research on Biological Effects of Electric and Magnetic Fields from Generation, Delivery, and Use of Electricity, November 8 - 12, San Diego, California.

9.7 REFERENCES FOR SECTION 8

Anninos PA, Tsagas N, Sandvyk R, Derpapas K, (1991): Magnetic stimulation in the treatment of partial seizures. *Intern. J. Neuroscience* 60 :141-171.

9.7 REFERENCES FOR SECTION 8 (cont'd)

Bell GB, Marino AA, Chesson AL, and Struve FA (1991): Human sensitivity to weak magnetic fields. *Lancet* 338:251.

Beniashvili D, Vilanishvili VG, Manabde MZ (1991): Low frequency electromagnetic radiation enhances induction of rat mammary tumors by nitrosomethylurea. *Cancer Letters* 61:75-79.

Bowman JD, Thomas DC and Peters JM (1991): The risk of childhood leukemia from home exposure to resonances from static and power frequency magnetic fields. (Abstract A-40) *Proc. DOE contractors meeting*, Milwaukee WI, Nov. 1991.

Blackman CF, Benane SG, House DE, Joines WT (1985a): Effects of ELF (1-120 Hz) and modulated (50 Hz) RF fields on the efflux of calcium ions from brain tissue in vitro. *Bioelectromagnetics* 6:1-11

Blackman CF, Benane SG, Rabinowitz JR, House DE, Joines WT (1985b): A role for the magnetic field in the radiation-induced efflux of calcium ions from brain tissue in vitro. *Bioelectromagnetics* 6:327-337.

Cook MR, Graham C, Cohen HD, Gerkovich MM (1992): A replication study of human exposure to 60 Hz fields: Effects on neurobehavioral measures. *Bioelectromagnetics* 13:261-285.

Goodman R, Henderson AS (1988) Exposure of salivary gland cells to low-frequency electromagnetic fields alters polypeptide synthesis. *Proc Natl Acad Sci USA* 85:2928-2932.

Groh KR, Ready MA, Ehret CF (1990): Chronobiological effects of electric fields. In: *Extremely low frequency electromagnetic fields: The question of cancer*. B. W. Wilson, R. G. Stevens, and L. E. Anderson (eds.). Battelle Press, Columbus, Ohio.

Groh, KR (1993): The biological effects of maglev-generated magnetic fields. Draft report (DTRS-57-90-00103) to US Department of Transportation Federal Railroad Administration, Washington D.C. Argonne National Laboratory, Argonne, IL.

Hajdukovic R, Mitler MM, Pasch B, Erman M.(1992): Low energy emission therapy (LEET) on sleep structure First World Congress for Electricity and Magnetism in Biology and Medicine, Lake Buena Vista, Florida, June 1992. Abstract.

Kavet R (1992): A brief perspective on biological effects from EMF exposure. In: *Proc. workshop on future epidemiologic studies on EMF* (Buffer P.ed). Carmel, CA, Feb. 5-8, 1991. EPRI document TR 101175.

Lednev VV (1991): Possible mechanism for the influence of weak magnetic fields on biological systems. *Bioelectromagnetics* 12:71-

9.7 REFERENCES FOR SECTION 8 (cont'd)

- Lee GM, et al. (1992): Descriptive assessment of 24 hour personal exposure to 60 Hz fields using a rate of change metric (Abstract). First World Congress for Electricity and Magnetism in Biology and Medicine. Lake Buena Vista, Florida, June 14-19, 1992.
- Lerchl A, Nonaka KO, Reiter RJ (1991): Pineal gland "magneto-sensitivity" to static magnetic fields is a consequence of induced electric currents (eddy currents). *J. Pineal Res.*, 10, 109-116.
- Liboff AR, McLeod BR, Smith SD (1990): Ion cyclotron resonance effects of ELF fields in biological systems. In: *Extremely low frequency electromagnetic fields: The question of cancer*. B.W. Wilson, R.G. Stevens, and L.E. Anderson (eds). Columbus, Ohio: Battelle Press.
- Liburdy RP (1992): Calcium signaling in lymphocytes and ELF fields. Evidence for an electric field metric and a site of interaction involving the calcium ion channel. *FEBS Lett.* 301:53-59.
- Litovitz TA et al. (1991):, *Biochem. Biophys. Res. Comm.*, 178: 862-865)
- Litovitz TA, Farrell JM, Krause D, Doinov P, Montrose CJ (1993): Superimposing Electromagnetic noise blocks the alteration of ornithine decarboxylase activity in developing chick embryos caused by a weak 60-Hz sinusoidal field. (Abstract) Bioelectromagnetic Society Fifteenth Annual Meeting, Los Angeles, California June 13-17, 1993.
- London SJ, Thomas DC, Bowman JD, Sobel E, Cheng T-C, Peters, JM (1991): Exposure to residential electric and magnetic fields and the risk of childhood leukemia. *Am. J. Epidemiol.* 134: 923-937.
- Lovely RH, Miller DL, Anderson LE (1990): Assessment of rats' behavior in a radial arm maze during exposure to magnetic fields (Abstract). 12th Annual Bioelectromagnetics Society Meeting, San Antonio, Texas, June 1990.
- Matanoski GM (1991b): Results of occupational magnetic field study announced. Environmental Update, September 1991, Electric Power Research Institute, Palo Alto CA (Abstract).
- McLean J, Stuchly MA, Mitchel R, Wilkinson R, Lecuyer DW (1990): Tumor promotion in the mouse skin by 60 Hz magnetic field. Abstract: 12th Annual Meeting Bioelectromagnetic Society, San Antonio, Texas, June 1990.
- Morgan MG, Nair I (1992): Alternative functional relationships between ELF field exposure and possible health effects: Report on an expert workshop. *Bioelectromagnetics* 13:335-350.

9.7 REFERENCES FOR SECTION 8 (cont'd)

Pilla AA (1974): Electrochemical information transfer at living cell membranes. *Ann. N.Y. Acad. Sci.* 238:149.

Pilla A, et al. (1985): Electromagnetic modulation of biological processes: Consideration of cell-waveform interactions. In: Chiabrera A Nicolini C, Schwann HP (eds.) *Interactions between electromagnetic fields and cells*. New York: Plenum Press, p.423.

Rogers WR, Reiter RJ, Smith HD, Barlow-Walden L (1991): Under some circumstances, combined electric and magnetic field exposure reduces serum melatonin concentration in nonhuman primates. Abstracts of the Annual Review of Research on Biological Effects of 50 and 60 Hz Electric and Magnetic Fields, Milwaukee, WI, p. A-26.

Savitz DA, Wachtel HA, Barnes F, John EM, Tvrdik JG (1988): Case-control study of childhood cancer and exposure to 60-Hz magnetic fields. *Am. J. Epidemiol.* 128:21-38.

Tenforde TS (1991): Biological interactions of extremely low frequency electric and magnetic fields. *J. Electroanal. Chem.* 320:1-17.

Welker HA, Semm P, Willig RP, Commentz JC, Wiltschko W, Vollrath L (1983): Effects of an artificial magnetic field on serotonin N-acetyltransferase activity and melatonin content in the rat pineal gland. *Exp. Brain Res.* 50, 426-432.

Wilson BW, Wright CW, Morris JE, Buschbom RL, Brown DP, Miller DL Sommers-Flanigan R, Anderson LE (1990): Evidence for an effect of ELF electromagnetic fields on human pineal gland function. *J. Pineal Res.* 9:259-269.

Wilson BW, Morris J, Anderson LE, Sasser L, Matt K (1993): Changes in pineal gland and hypothalamus of the Djungarian hamster from short term exposure to 60 Hz magnetic fields (Abstract). Fifteenth Annual Bioelectromagnetics Society Meeting, Los Angeles, CA, June 13-17, 1993.

Yellon SM (1991): An acute 60 Hz magnetic field exposure suppresses the nighttime melatonin rise in the pineal and circulation of the adult Djungarian hamster. Abstracts of the Annual Review of Research on Biological Effects of 50 and 60 Hz Electric and Magnetic Fields, Milwaukee, WI, p. A-25.

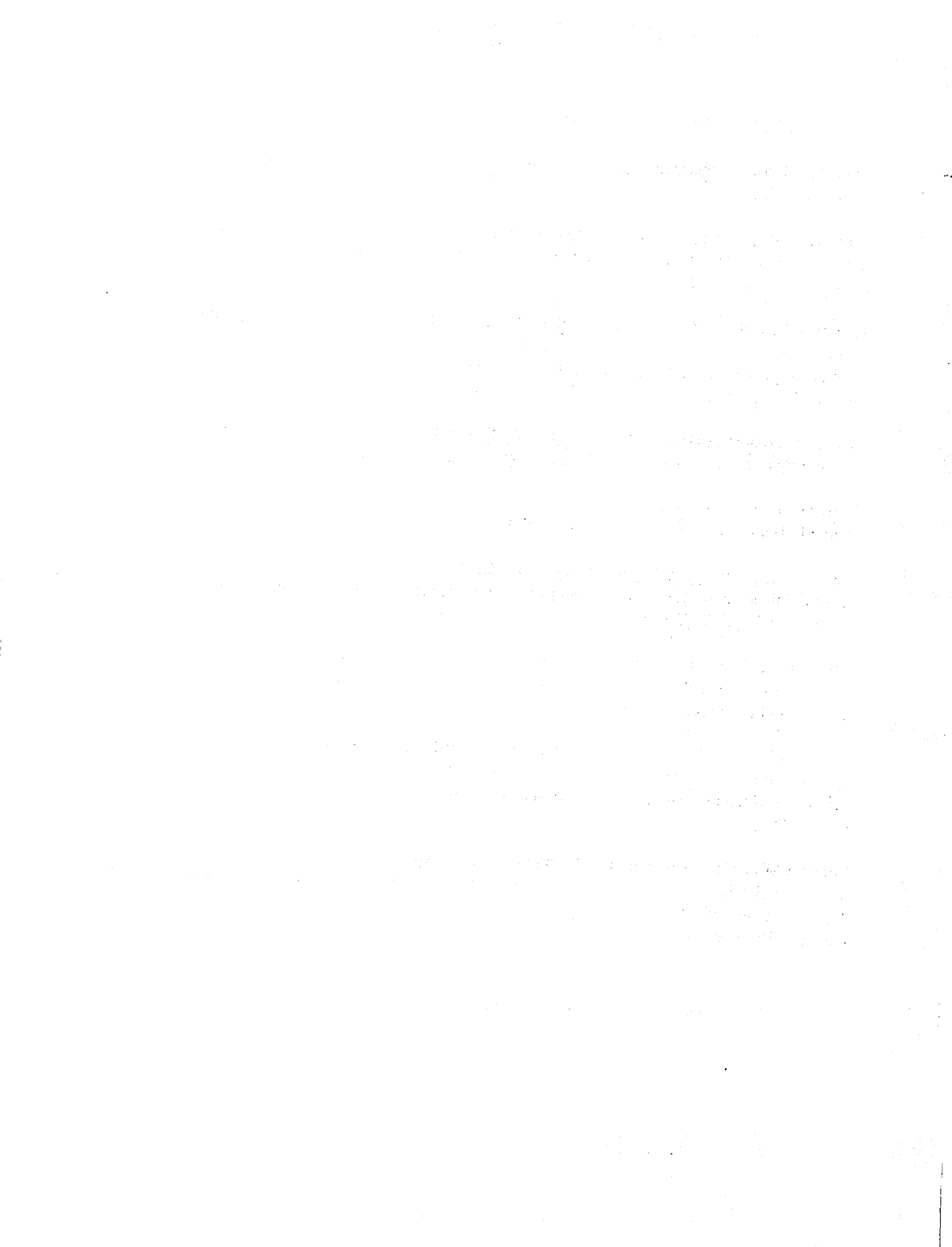

APPENDIX A

PINEAL GLAND FUNCTION AND MELATONIN: PHYSIOLOGICAL EFFECTS OF MELATONIN AND CONSEQUENCES OF PINEAL DYSFUNCTION

A.1 INTRODUCTION

Physiologic actions of melatonin far transcend the early observations that unequivocally documented it as the essential neuromediator of seasonal reproductive events in photoperiodic species (Reiter, 1973, 1974). Melatonin has been subsequently found to be linked to the function of a variety of other endocrine organs as well as to organs and organ systems not classically included in the neuroendocrine framework (Vriend, 1983; Heldmaier and Lynch, 1986; Kothari, 1988; Armstrong, 1989; Maestroni et al., 1989). Current knowledge holds that the pineal gland, via the secretion of its chief hormone melatonin, seems to be one of the most ubiquitously acting organs of internal secretion (Reiter, 1991a, b). Thus, perturbations of the melatonin rhythm could lead to a variety of physiological consequences which have the status of melatonin synthesis and release as their common denominator.

Circadian production of melatonin seems to be an essential event for normal physiology. Perturbations of this rhythm are associated with a multitude of clinical conditions considered abnormal (Blask, 1984; Waldhauser et al., 1984; Gupta and Attanasio, 1988; Sack and Lewy, 1988; Thompson, 1988; Waldhauser and Dietzel, 1988; Reiter, 1992). Thus, any event that alters the 24-hour rhythm of either melatonin production and/or secretion may predictably have physiological consequences.

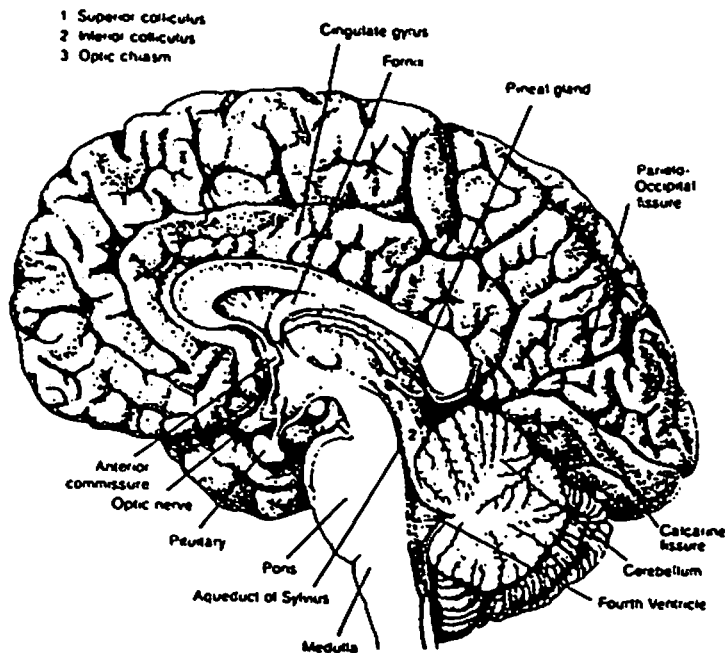

Figure A-1. Medial view of a half of the human brain showing the location of the pineal gland near the anatomical center. In the human, the pineal gland is about the size of a pea, weighing an average of 120 mg with wide individual variations. The pineal gland in all mammals including man is anatomically connected to the eyes which, in this figure, would be just anterior to the optic nerve.

A.2 MELATONIN SYNTHESIS

In mammals, melatonin is a synthesis product and hormone of the pineal gland, a small outgrowth of the dorsal diencephalon of the brain (Vollrath, 1981). In many mammals including man, the pineal is near the anatomical center of the brain (Figure A-1); in other mammals, it has, during embryological development, migrated to a more superficial position such that its final location is on the midline just beneath the superior sagittal sinus and at the junction of the parietal and occipital bones (Vollrath, 1981).

Functional activity of the pineal gland is synchronized by the prevailing light:dark cycle. Normally, melatonin synthesis and secretion are low during the day and elevated at night (Reiter, 1986a). This is true for both nocturnally and diurnally active mammals and means that nighttime levels of melatonin in the blood are always higher than those measured during the day (Vaughan, 1984; Arendt, 1988a, b). Because of this persistent rhythm of melatonin, the pineal gland imparts essential time of day information to every organ in the body that otherwise cannot "see" light and that has the necessary machinery (melatonin receptors or binding sites) to read the melatonin message. Besides providing time of day information, since day length (and as a result night length) vary with season, the melatonin signal also provides time of year message as well. It is well known that the nighttime duration of elevated melatonin is proportional to the length of the night and, in fact, this forms the basis for one of the hypotheses, i.e., the duration hypothesis, of melatonin action (Reiter, 1987).

In the true sense of the word, the pineal gland is an end organ of the visual system just as is the visual cortex of the cerebral hemispheres. Both the pineal gland and the visual cortex are anatomically linked to the eyes and both respond to light input to the retinas; the pineal responds to the photoperiodic cycle with the production and secretion of hormone while the visual cortex translates neural messages into visual impressions.

Neural connections between the eyes and the pineal gland involve the retinohypothalamic fibers which originate from the ganglion cells of the retinas and terminate in the SCN of the hypothalamus (Moore and Klein, 1974). The SCN are important structures in circadian physiology since they seem to be in whole or in part the anatomical substrate for the biological clock governing circadian rhythmicity.

Indeed, most 24-hour rhythms in the organism seem to require intact SCN (Moore, 1981); as a consequence, the SCN are often referred to as the central rhythm generator. Between the SCN and the pineal gland, the neuroanatomical connections include synapses in the paraventricular nuclei of the hypothalamus, the intermediolateral cell column of the upper thoracic cord, and the superior cervical ganglia (SCG) in the neck (Bittman, 1984) (Figure A-2). The SCG contain postganglionic sympathetic neurons that end among the parenchymal cells of the pineal gland (Ariens Kappers, 1960) where, during the night, they release the neurotransmitter norepinephrine (NE) which drives the nocturnal production and secretion of melatonin (Axelrod, 1974). Besides the postganglionic sympathetic input to the mammalian pineal gland, there is an alternate source of fibers that enter the gland via its stalk (Korf and Mueller, 1984). Whereas these fibers are morphologically well documented, their functional relevance to pineal melatonin production has not been established.

The point has already been made that the light:dark cycle is the major factor that determines the circadian production of melatonin. The nighttime increase in the conversion of serotonin to melatonin within the pineal gland is determined by the activity of the sympathetic neurons which innervate it (Axelrod, 1974). The neural activity originates in the SCN when the nuclei are relieved of the inhibitory effects of light which reaches the SCN via the retino-hypothalamic tracts (which are found in the optic nerves) (Figure A-2).

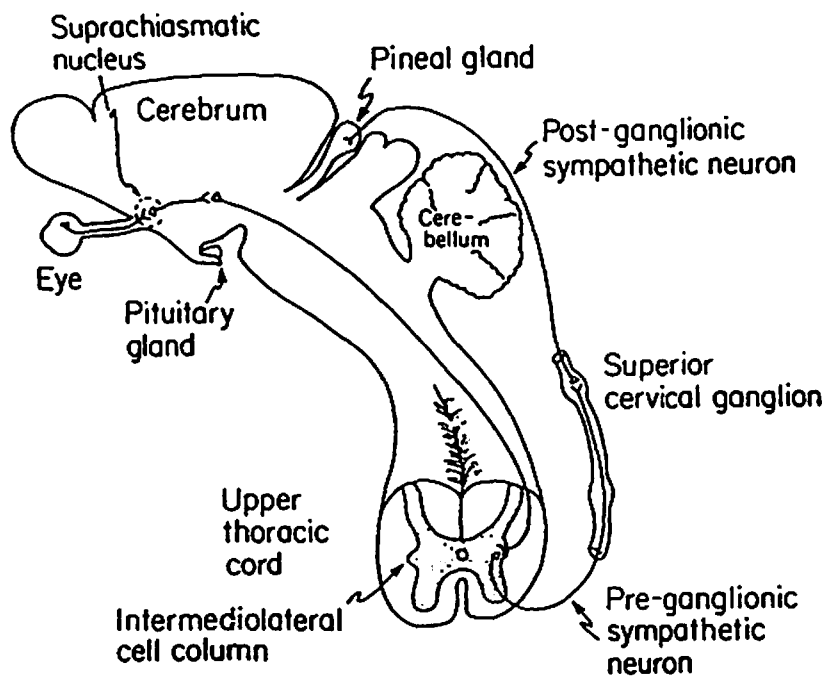

Figure A-2. Schematic representation of the anatomical connections between the eyes and the pineal gland of mammals including man. The retinohypothalamic tract projects from the eyes to the suprachiasmatic nuclei (SCN). The neural connections between the SCN and the pineal gland must be intact for the gland to produce melatonin during darkness. If these pathways are interrupted, the gland is rendered non-functional so far as can be presently ascertained.

Action potentials in the postganglionic sympathetic fibers which terminate in the pineal gland release NE into the synaptic clefts adjacent to the pinealocytes (Zatz, 1981), the hormone-producing cells of the gland. The released NE interacts primarily with b-adrenergic receptors and, to a lesser extent, with a-adrenergic receptors, located in the pinealocyte membranes. These interactions lead to a cascade of intracellular events (Figure A-3) which culminate eventually in the intracellular production of melatonin (Axelrod, 1974; Ebadi, 1984; Reiter, 1991b).

The intracellular second messenger which mediates the nocturnal synthesis of melatonin is cyclic AMP (Weiss and Costa, 1968). The increased production of the cyclic nucleotide leads to the expression of the enzyme, N-acetyltransferase (NAT), which N-acetylates serotonin to N-acetylserotonin, the immediate precursor of melatonin. N-acetylserotonin is converted to melatonin by the enzyme hydroxyindole-O- methyltransferase (HIOMT) (Figure A-3).

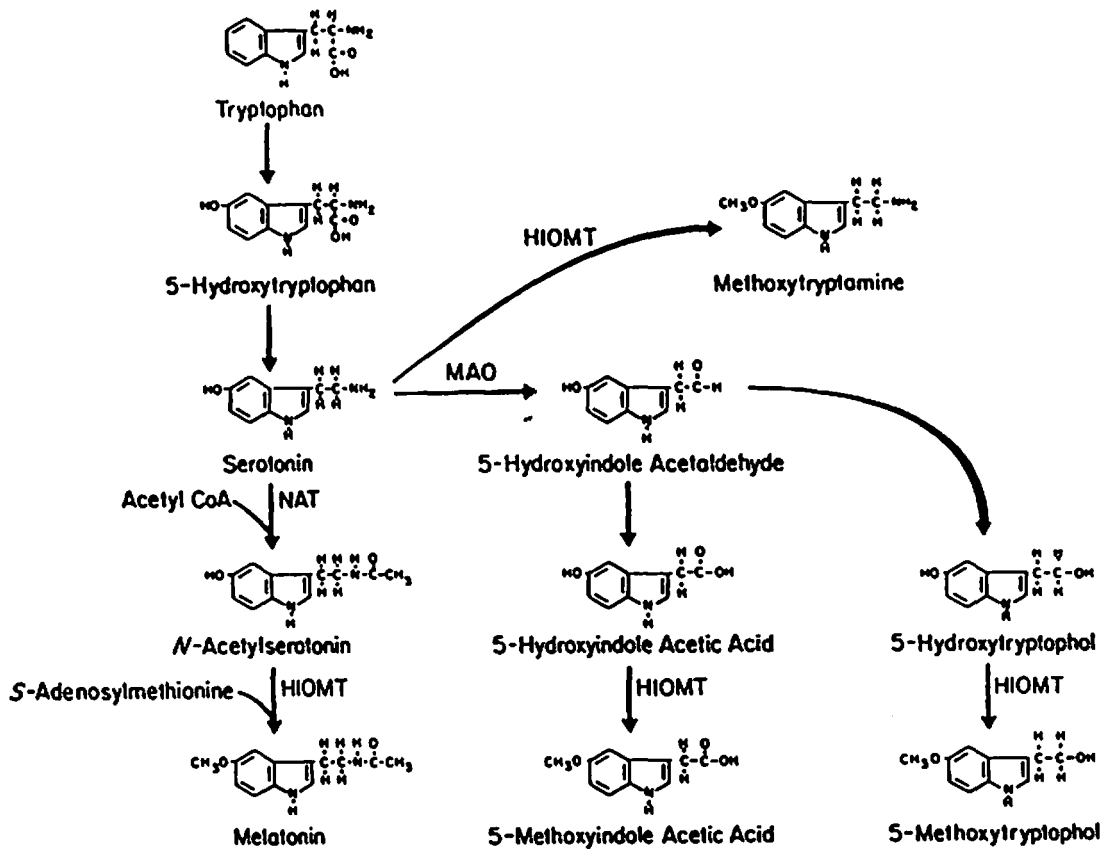

Figure A-3. Schematic representation of the synthesis of melatonin and other tryptophan-derived compounds in the pineal gland. The enzymes involved in converting serotonin to melatonin are NAT and hydroxyindole-O-methyltransferase (HIOMT), monoamine oxidase (MAO).

The transcriptional and translational processes that induce the rise in NAT activity at night have been only poorly defined (Reiter, 1991b). NAT activity, depending on the species studied, exhibits very large (rat - Klein and Weller, 1970) or more modest (Syrian hamster, gerbil, guinea pig - Rudeen et al., 1975) nighttime increases. This enzyme seems to rate limit the quantity of melatonin formed (Ebadi, 1984). Thus, in general, the rise in NAT activity is usually accompanied by a parallel increase in the levels of melatonin within the pineal gland.

Once produced, melatonin seems to be quickly released from the gland. Because of its high lipophilicity, it is generally believed that melatonin merely diffuses passively out of the pinealocytes and into the rich capillary beds which perfuse the gland. On the other hand, melatonin does seem to be released from the pineal gland in a pulsatile (episodic) manner; the episodic mode of secretion seems not to be totally consistent with a compound that continually diffuses through the cell membrane.

Regardless of the specific mode of secretion, blood melatonin levels parallel the production of the indole within the pineal gland (Wilkinson et al., 1977; Arendt, 1985). Thus, the measurement of the concentrations of melatonin in the blood provides a reasonable assessment of the synthetic activity of the pineal gland immediately preceding the blood collection.

However, organs other than the pineal gland could at least theoretically contribute to the circulating melatonin levels. Organs known to contain the enzymatic pathways necessary to produce melatonin include the retinas (Pang and Allen, 1986), Harderian glands (large tubululoalveolar exocrine, and possibly endocrine, glands located in the orbital cavity of some mammals) (Menendez-Pelaez et al., 1988), extra-orbital lacrimal glands (Mhatre et al., 1988), the gut (Bubinek et al., 1977), and red blood cells (Rosengarten et al., 1972). Under certain conditions, the discharge of melatonin from these organs could confound the interpretation of circulating melatonin levels in terms of pineal melatonin release. To date, however, no one has reliably demonstrated in mammals that organs other than the pineal gland actually release melatonin into the blood vascular system.

Blood melatonin values are typically 5-10 times greater at night than during the day (Figure A-4). Melatonin is primarily bound to albumin (Pardridge and Mietus, 1980) and is rapidly cleared from the blood (half-time of 10-40 min) (Gibbs and Vriend, 1981; Chan et al., 1984). The primary metabolic site for melatonin degradation is the liver, with the chief hepatic metabolite being 6-hydroxymelatonin sulfate (Arendt, 1986). About 75% of the circulating melatonin is taken up by the hepatic cells on any given pass of the blood through the liver (Pardridge and Mietus, 1980). 6-hydroxymelatonin sulfate escapes from the hepatic cells back into the blood; it is excreted from the kidneys into the urine where it, like blood melatonin levels, exhibits a clear circadian rhythm (Figure A-5) (Fellenberg et al., 1981; Broadway et al., 1988).

Thus, both blood levels of melatonin and the urinary concentrations of 6-hydroxymelatonin sulfate are used as reliable indices of pineal synthetic activity. Small amounts of melatonin also are excreted into the urine where they can be estimated (Lynch et al., 1975); however, because of the small quantities of melatonin (< 1% of that produced by the pineal gland)

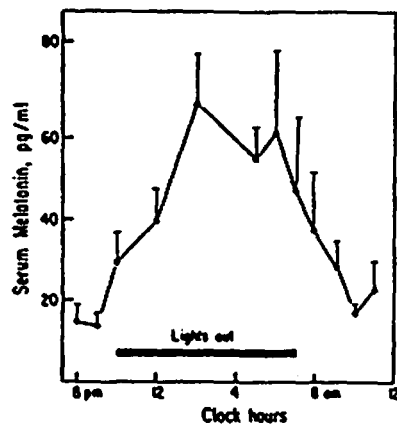

Figure A-4. Night rise in serum melatonin levels (mean \pm se) in seven healthy male subjects. Individuals often exhibit marked differences in terms of the amplitude and phasing of the melatonin rhythm; within an individual, however, the melatonin level is highly reproducible. (From Waldhauser et al., 1984.)

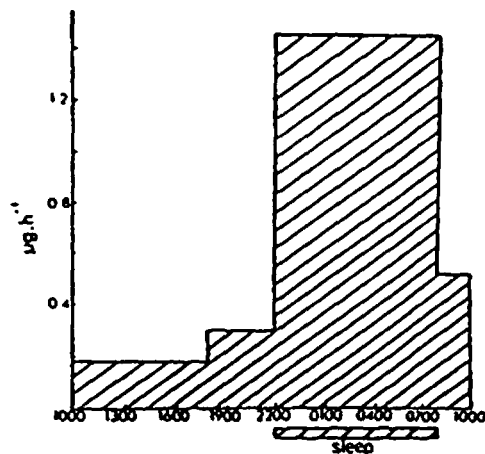

Figure A-5. Levels of the chief melatonin metabolite, 6-hydroxymelatonin sulfate, in the urine of an adult human male. Nighttime levels are always higher than daytime values. Sleep, although usually associated with darkness, is not a requirement for the rhythm. (Modified from Fellenberg et al., 1981.)

found in the urine, they are usually considered to be a less reliable index of pineal melatonin production.

While both blood melatonin and urinary 6-hydroxymelatonin sulfate levels are well correlated with the synthesis of the indole within the pineal gland, other fluids may provide equally reliable indices of pineal activity. Once in blood, melatonin, again presumably because of its highly lipophilic nature, quickly passes into other bodily fluids where it also exhibits a 24-hour rhythmicity. Thus, the cerebrospinal fluid (Wilson et al., 1977; Reppert et al., 1979), saliva (Vakkuri, 1985), male seminal fluid (Bornman et al., 1989), ovarian follicular fluid (Brzezinski et al., 1987), and fluid of the anterior chamber of the eye (Yu et al., 1990) also exhibit circadian cycles of melatonin reminiscent of those seen in the blood.

Rhythms in these fluids are usually of somewhat lower amplitude than those seen in the blood (Figure A-6) (Laakso et al., 1990). For each of the above-mentioned fluids, point-to-point correlations of melatonin concentrations in a specific fluid with those in the blood have not always been as detailed as those of Laakso et al. (1990).

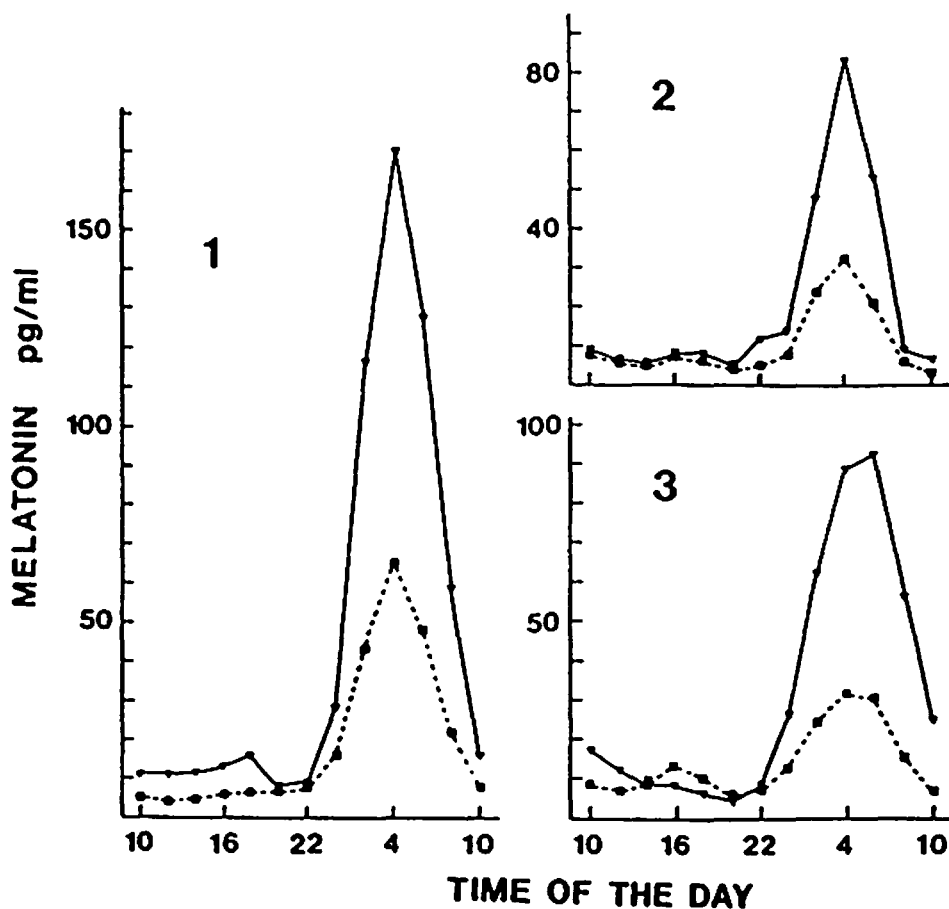

Figure A-6. Concomitant serum (solid line) and salivary (dashed line) melatonin levels in three adult humans over a 24-hour period. Whereas both fluids exhibit a 24-hour rhythm in melatonin concentrations, salivary levels are usually lower. (Modified from Laakso et al., 1990.)

One point that many researchers have repeatedly stressed when examining the 24-hour cycle of melatonin in the blood of humans is the reproducibility of the cycle over time. Thus, whereas two individuals may have quite different nocturnal blood melatonin peaks as well as different phasing of the rhythm, within a given individual the rhythm is repeated with high fidelity over time (Arendt, 1988a). Finally, in general, the melatonin rhythm is usually considered rather stable and not easily perturbed. Considering its stability, it clearly imparts important temporal as well as physiological information to a variety of other organs. As noted above, the actions of melatonin seem to be very broad (Reiter, 1991a).

A.3 PHYSIOLOGICAL EFFECTS OF MELATONIN

Shortly after the discovery of melatonin (Lerner et al., 1958, 1959), the indoleamine was examined for its endocrine consequences. In particular, its relationship to reproductive physiology was studied since earlier investigators, although often using questionable scientific data, had proposed a hormonal interaction of the pineal gland with the neuroendocrine-reproductive axis (Kitay and Altschule, 1954). Over the next three decades, however, it became apparent that the chief pineal hormone had a variety of effects both on other endocrine organs and tissues generally not considered to be part of the endocrine system (Reiter, 1991a).

The following section describes the diverse actions of melatonin on a variety of organ systems. These particular actions of melatonin were included in this report because many apply to the problem at hand; namely, they may relate to a mechanism by which either electric or magnetic fields may produce some or all of their physiological consequences (Wilson and Anderson, 1990).

A.4 PHYSIOLOGICAL CONSEQUENCES OF PINEAL GLAND DYSFUNCTION

A.4.1 Reproduction and Development

As already mentioned, functional association of the pineal gland with reproductive physiology was suspected for several decades before definitive experiments unequivocally established the connection (Kitay and Altschule, 1954). Soon after researchers discovered that the daily light:dark cycle changed the melatonin output of the pineal gland (Wurtman et al., 1963), appropriately designed experiments quickly showed that the pineal gland has a major regulatory effect on the reproductive capabilities of mammals (Hoffman and Reiter, 1965).

It is now well documented that changing patterns of melatonin production and secretion by the pineal gland determine the fertile and infertile states which are characteristic of the seasonal reproductive cycles in animals (Reiter, 1980; Bittman, 1984; Stetson and Watson-Whitmyre, 1984). In these cases, melatonin acts as a photoperiodic messenger of the pineal gland and synchronizes reproductive capability with the appropriate season of the year. In its functional capacity as a reproductive regulatory hormone, melatonin can clearly (1) inhibit the function of the hypothalamo-pituitary-gonadal axis, i.e., have antigonadotrophic actions (Tamarkin et al., 1976), and (2) promote reproductive fertility, i.e., have progonadotrophic actions (Bittman, 1984). However, if given at either the inappropriate time

(Chen et al., 1980) or via a non-physiological means (Reiter et al., 1975; Chen, 1981), melatonin may be ineffective in either inhibiting or stimulating reproductive function.

The effects of melatonin on reproductive physiology are highly species dependent. Besides the general status of the reproductive system following melatonin treatment, all of the reproductively active hormones have been extensively studied in animals treated with the pineal indoleamine. There is no doubt whatsoever that the rhythmic production of melatonin plays a major role in determining the functional status of the reproductive system in adult non-human mammals.

Just as the administration of melatonin to animals illustrates the regulatory effect of the indoleamine on reproduction, modification of endogenous melatonin production has clear sexual consequences as well. Thus, briefly suppressing the nightly melatonin peak or disturbing (e.g., shifting) the melatonin rhythm substantially alters the ability of this hormone to regulate reproduction. Usually, the suppression of nightly melatonin is achieved by short pulses of light at night (Earnest and Turek, 1983; Brainard et al., 1986) or by drug administration (Champney, 1990); however, perturbations of the melatonin rhythm produced by exposure of animals to electric and/or magnetic fields would be expected to have similar consequences in terms of the function of the sexual organs.

Whereas the preceding discussion primarily concerns the reproductive effects of melatonin in adult animals, the actions of the indole on sexual maturation have also been studied in detail. Pubertal development is a complex process involving many hormones, one of which is melatonin. When melatonin is infused at physiological concentrations into animals undergoing puberty, sexual maturation is very significantly delayed (Carter and Goldman, 1983). Conversely, reducing natural melatonin production by a variety of means has been shown to hasten reproductive development (Reiter, 1986a, b). Thus, perturbing the melatonin rhythm by either shortening the duration of the elevated levels at night, reducing the amplitude of the nocturnal peak, or changing the phasing of the cycle would be expected to alter one or more aspects of sexual physiology in animals undergoing puberty, just as in adults.

Three facets of the melatonin rhythm may be important in determining the ability of the pineal hormone to modify reproduction. As already noted, maximal pineal melatonin production and secretion are events virtually exclusively associated with the daily period of darkness. Likewise, the longer the night, the more prolonged the elevated melatonin (Goldman, 1983; Reiter, 1987). There is strong evidence that the duration of the melatonin peak is critical to the ability of the hormone to influence reproductive physiology and, indeed, any function in the organism (Carter and Goldman, 1983; Goldman, 1983; Reiter, 1987). This is referred to as the duration hypothesis of melatonin action. On the other hand, there are those who argue that melatonin's efficacy depends on its peak being coincident with a sensitivity period for melatonin (Stetson and Watson-Whitmyre, 1986; Reiter, 1987).

In this scheme, two rhythms are required, i.e., the melatonin cycle and the melatonin sensitivity cycle. Only when high melatonin levels are present during the period of maximal sensitivity is melatonin effective as a hormone; this is generally referred to as the internal

coincidence hypothesis of melatonin action. A third hypothesis has also been suggested to explain the actions of melatonin; this one relies on the amplitude of the nighttime rise. Simply stated, the functional effectiveness of melatonin is related to how high the nighttime values are. This is conveniently identified as the amplitude hypothesis.

Each of the hypotheses presented above has its advocates as well as its experimental support. Possibly, none of these hypotheses is totally correct or totally wrong. Rather, it is conceivable that under different circumstances each facet of the melatonin rhythm may become important. Environmental conditions that change any aspect of the melatonin rhythm could alter its physiology accordingly, and the changes in the melatonin rhythm may not have to be dramatic to result in a functional difference.

Melatonin also seems to be linked to reproductive physiology in humans, although the findings are certainly less clear than they are in experimental animals. Waldhauser and Geisinger (1986) have reported significant reductions in nighttime melatonin levels in males and females going through puberty (Figure A-7). These researchers claim that these reductions, which are a normal maturational process, may be necessary for sexual maturation. Without the attenuation of the nighttime melatonin peak in individuals passing through puberty, the investigators predict sexual maturation would be delayed.

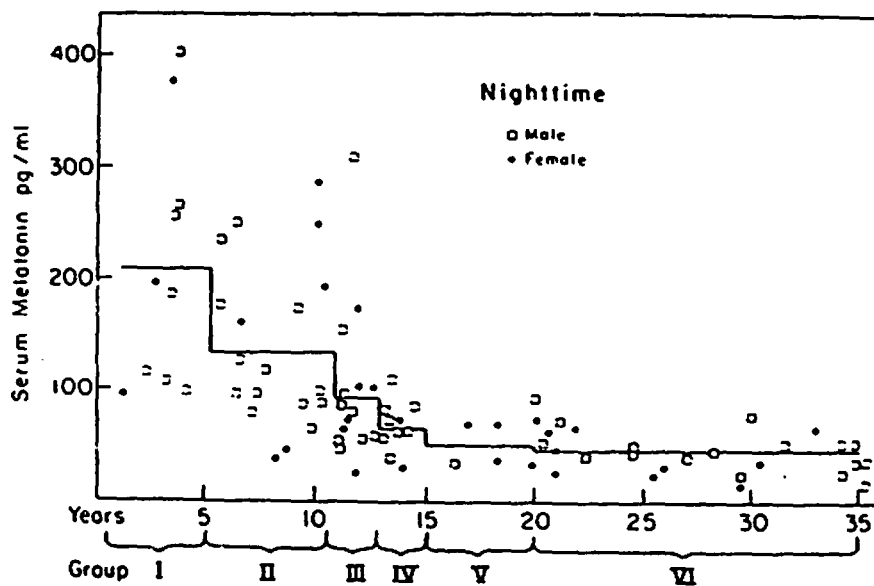

Figure A-7. Nighttime levels of blood melatonin in children, adolescents, and young adult humans according to chronological age of the individuals. The drop in nocturnal melatonin levels between ages 5 and 15 years may be permissive to pubertal development. (From Waldhauser and Dietzel, 1988.)

Certainly, other experimental work in humans (Tetsuo et al., 1982) lends validity to this assumption; however, there are also researchers who claim that the melatonin cycle changes minimally or not at all during pubescence and thus melatonin has little to do with sexual maturation (Ehrenkranz et al., 1982; Tamarkin et al., 1982). Some of the studies in this area of research have shortcomings or deficiencies that make it difficult to interpret the results. If excessively long or high melatonin levels at night do delay sexual maturation in the human, it is conceivable that depressed or absent melatonin would advance puberty. Pineal tumors, which presumably destroy the endocrine cells of the pineal gland (and thereby likely depress melatonin), are often associated with precocious puberty (Vaughan et al., 1978).

In adult humans, a number of studies suggest an association of pineal dysfunction with alterations of the gonadal hormones. As noted, the neuroendocrine system of adult mammals can be markedly influenced by the secretory pattern of melatonin. Excessive melatonin secretion at night has been reported in females with depressed fertility, e.g., in women with hypothalamic amenorrhea (Berga et al., 1988) and anorexia nervosa (Tortosa et al., 1989). Likewise, human males suffering from either oligospermia or aspermia have abnormally high circulating levels of melatonin (Karasek et al., 1990). Unusually high serum melatonin concentrations have also been reported in women with severe premenstrual syndrome (Parry et al., 1990), and exogenously administered melatonin in humans changes the pulsatility of luteinizing hormone (LH) secretion from the anterior pituitary gland (Cagnacci et al., 1991).

The precisely timed ultradian release of LH (which is reflective of the release of gonadotrophin releasing hormone or GnRH in the median eminence of the brain) is essential for normal reproductive function in humans (Cromley et al., 1987). If endogenously secreted melatonin indeed has the capability of altering this finely timed system, changes in the production and secretion of pineal melatonin could change reproductive physiology accordingly. The magnitude of the change in the absolute melatonin level as well as the degree of phase shift of the rhythm that would be required to noticeably disrupt normal reproductive function in humans remains unknown. However, based on overwhelming evidence showing a strong causal link between melatonin rhythmicity and reproduction in many non-human mammals, similar interactions are likely in humans.

A.4.2 Depression

Disorders of circadian rhythmicity are not uncommonly associated with depression and/or other affective syndromes (Siever et al., 1987). The melatonin rhythm, which is strongly circadian-based, has been implicated in a variety of abnormal psychological states. In particular, alterations of this rhythm have been described in seasonal affective disorder (SAD) (Lewy et al., 1990), bipolar mood disorder (Mayeda and Nurnberger, 1990), mood and sleep disorders (James, 1990), as well as schizophrenia (Miles and Grey, 1988), to mention only a few.

Inasmuch as electric and magnetic field exposure commonly leads to a reduction or phase shift of the melatonin cycle, the association of the melatonin rhythm with psychological depression is of significant interest. A subgroup of depressed patients were defined about 10

years ago (Beck-Friis et al., 1983) wherein the subjects had what was referred to as "low melatonin syndrome" (also sometimes identified as "depressive hypomelatoninemia"). This research group subsequently defined the following features of what has come to be known as low melatonin syndrome: reduced nocturnal melatonin levels, an abnormal dexamethasone suppression test, a disrupted 24-hour cortisol rhythm, and a less pronounced daily and annual cyclic variation in depressive symptoms (Wetterberg et al., 1990). Although the syndrome was named and extensively studied by Beck-Friis, Wetterberg, and their colleagues, many others have made similar observations, and it now seems well documented that reduced circulating melatonin levels, particularly at night, are a feature of some patients with psychological depression (Mendelwicz et al., 1979; Boyce, 1985).

Figure A-8 illustrates the 24-hour melatonin rhythm in psychologically normal and depressed individuals (Claustrat et al., 1984). Also of interest, the melatonin rhythm in depressed subjects may be more susceptible to suppression than that in normal subjects (Lewy et al., 1985). Hence, depressed individuals (possibly already with lower melatonin levels than normal) may be more susceptible to electric and magnetic field exposure than are otherwise normal humans.

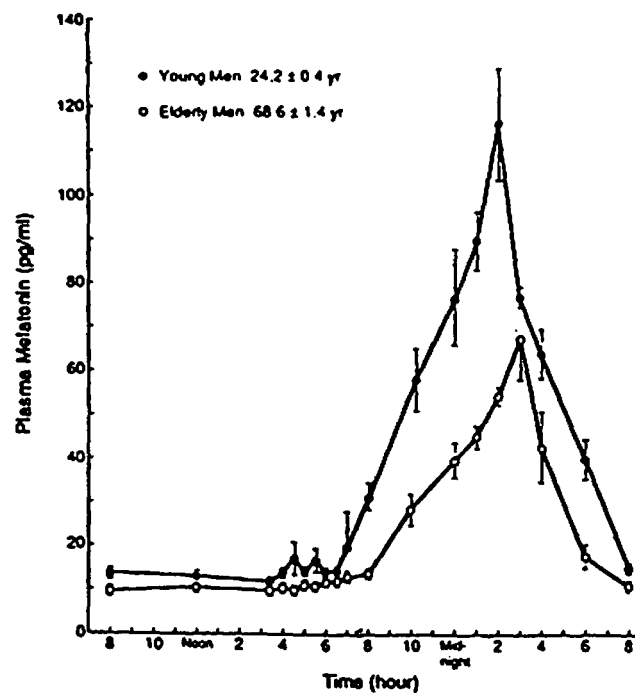

Figure A-8. Besides producing and secreting less melatonin at night, the pineal gland in elderly men exhibits a shorter duration of elevated nocturnal melatonin. (From Nir et al., 1986.)

There is at least one major question relating to the low melatonin syndrome as described. Is there a group of psychologically normal individuals who have melatonin levels in the range of those of the depressed subjects? Also unanswered is whether low melatonin can be regarded as a trait or a state marker of depressive illness. It is clear, however, that psychological depression, at least under some circumstances, may be accompanied by what appears to be an abnormal melatonin rhythm.

Besides depression, individuals with schizophrenia have been found to exhibit a greatly reduced melatonin cycle (Ferrier et al., 1982; Monteleone et al., 1992). At this point, it is again not clear whether the markedly depressed 24-hour melatonin rhythm is a result, a consequence, or even related to the schizophrenic state.

Reduced melatonin cycles are a possible causative factor in depressive illness; phase shifts in the rhythm have also been implicated. This is particularly true in a condition mentioned earlier, namely, SADS (Lewy et al., 1990). Whereas SADS is most often present in the winter months (then identified as winter depression), it can occur at any time of the year. Many individuals with SADS appear to exhibit a delayed circadian rhythmicity inducing a later than normal rise in their nocturnal melatonin levels (Lewy, 1983). Readjusting their melatonin rise onset to an earlier time in the evening (usually by early morning light exposure) often ameliorates the condition of SADS.

Electromagnetic field exposure, besides reducing the nighttime melatonin peak in animals, has been reported to change the phasing of the rhythm as well. Thus, theoretically at least, psychological depression, in some cases, could be a result of an altered melatonin cycle induced by EMF. This hypothesis, however, only provides a theoretical framework for subsequent investigation.

A.4.3 Cancer

The pineal gland has been implicated in tumor growth regulation for several decades (Georgiou, 1929; Das Gupta and Terz, 1967) although the significance of this work has come into focus only in the last 10 years when it was unequivocally demonstrated that melatonin plays a substantial role in inhibiting the growth of certain cancer cells (Blask and Hill, 1986).

The antiproliferative influence of melatonin on cancer cells both in vitro (Bartsch and Bartsch, 1984; Blask et al., 1988) and in vivo (Lapin, 1976; Blask, 1984) has now been demonstrated. These studies have been interpreted to mean that melatonin is a naturally occurring oncostatic agent (Blask, 1984). Most importantly, when melatonin was tested for its oncostatic effects on human MCF-7 human breast cancer cells in vitro, it was found that concentrations of melatonin in the physiological range (10⁻⁹M and 10⁻¹¹M) in human blood led to an 80% growth inhibition of the cultured cells; outside of this range of concentrations (either higher or lower), melatonin was ineffective in modifying the growth of the cancer cells (Blask and Hill, 1986). This is a critical finding since it proves that normal blood concentrations of melatonin may normally curtail tumor growth and, furthermore, if levels of melatonin fall out of this range, for any cause, the risk for growth of cancer cells may increase.

Besides the in vitro studies, many whole animal experiments have documented the ability of the pineal secretory product to restrict the promotion of tumors. For example, Tamarkin et al. (1981) and Kothari (1987, 1988) have reported a greatly reduced incidence of chemical carcinogen-induced mammary cancer in rats treated exogenously with melatonin. In virtually all studies, the effects of melatonin seem to be an inhibition of tumor promotion rather than tumor initiation (Blask et al., 1991). Thus, whereas the reduced melatonin levels will seemingly not limit the transformation of normal cells into tumor cells, it may prevent their proliferation. Figure A-9 illustrates the proposed complex interactions of melatonin with the growth of mammary gland tumors. The figure illustrates that, in addition to affecting tumor cells, melatonin also suppresses the release or prevents the action of other hormones that

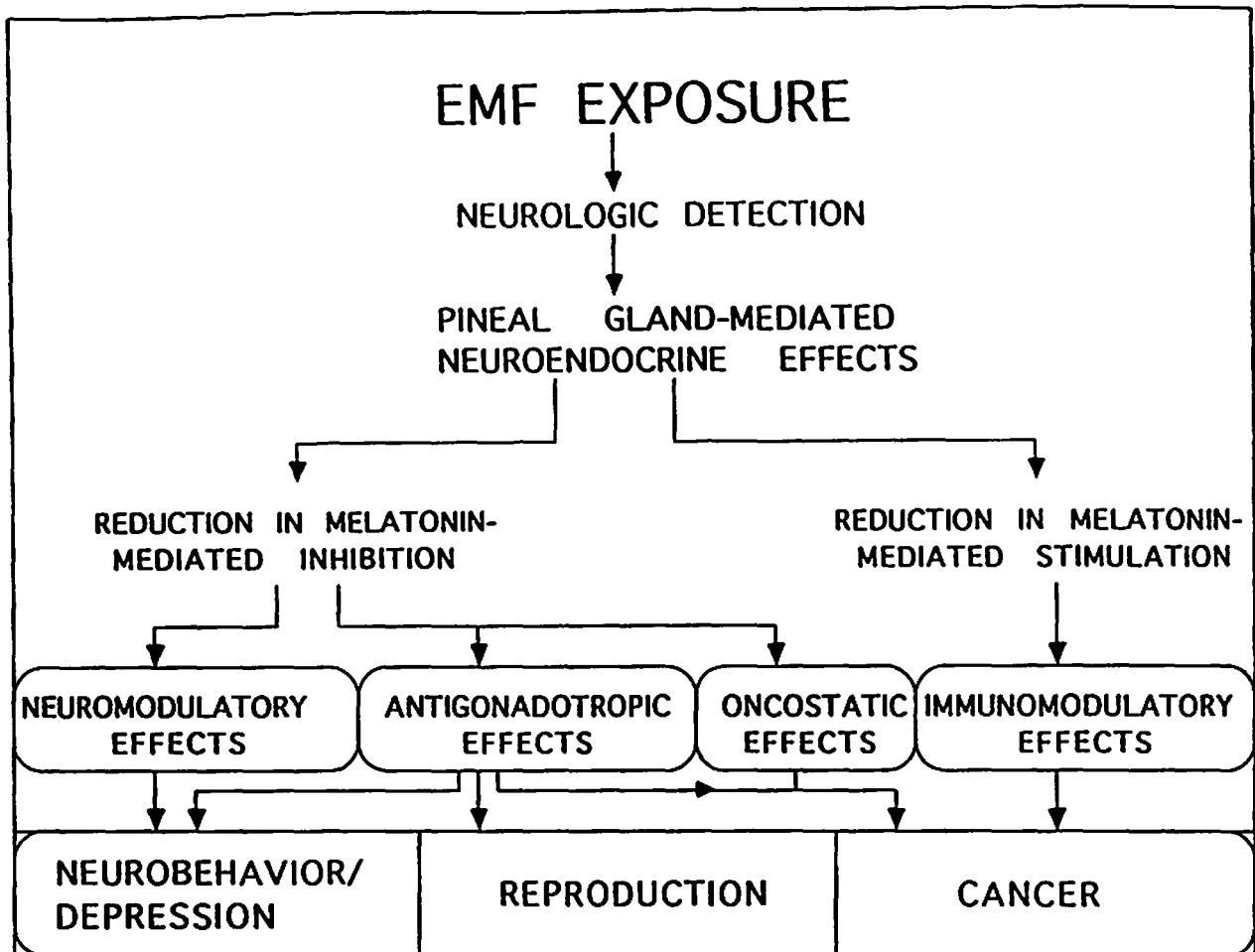

Figure A-9. Depicts the possible consequences of EMF detection by the pineal gland, which results in reduction or phase shifting of the nighttime peak in melatonin. Consequences are based on effects of melatonin in animal models.

stimulate the growth of these tumors. As seen from this figure, besides melatonin, other pineal factors may operate as oncostatic agents. This idea has also been recently espoused by H. Bartsch and C. Bartsch (1988).

In humans, reduced melatonin levels in the blood have sometimes been found when tumors are present. The implication of these findings is that the lower than normal melatonin levels may be causally related to the cancer; however, at this point, these are only correlations without any proof of causality. Nevertheless, based on the experimental work summarized above, the reduced melatonin levels in the blood of some cancer patients should be considered as possibly related to the growth of the tumor.

Melatonin levels have been described in a variety of tumor patients. Most notably, a reduced nocturnal peak of melatonin has been reported in human females with breast cancer (Bartsch et al., 1985; Tamarkin et al., 1982a, b; Danforth et al., 1985). The latter two studies found the lower amplitude melatonin cycles especially in females with breast tumors which were estrogen receptor positive. The blood melatonin rhythm has been studied in patients with carcinoma of the prostate on a number of occasions. Although the findings are not universally consistent (Blask and Hill, 1988), the most extensive study of serum levels of immunoreactive melatonin in elderly men (mean age of 70 years) with various prostate problems, including benign prostatic hyperplasia (BPH), incidental prostate cancer (IPC), and clinical prostatic carcinoma (CPC), revealed a potential relationship between melatonin and the development of prostate cancer (Bartsch et al., 1985).

The most notable finding was that in the CPC patients, i.e., those with overt tumors, the melatonin rhythm in the blood was virtually absent. While there were apparently some abnormalities in the melatonin rhythms of the subjects with BPH and IPC, their levels were clearly higher than those in the subjects suffering from CPC.

While breast and prostate tumor patients have been used more often than any others to examine melatonin levels relative to cancer growth, it may be equally worthwhile to consider extensive studies in patients with other types of tumors. It is possible that subjects with a wide variety of tumor types may be deficient in melatonin. For example, experimental evidence has linked melatonin with the ability of melanotic melanoma (MM) to grow and metastasize in the hamster; thus, the lower the melatonin, the more aggressive is the tumor (Das Gupta and Terz, 1967; Ghosh et al., 1983). Narita and Kudo (1985) found that melatonin had a similar growth-retarding effect on the growth of melanoma cells in male BALB/c athymic mice.

Melatonin cycles of humans with malignant melanomas have not been extensively investigated. Interestingly, melatonin was discovered because of its capability to cause the movement of pigment granules in melanin-containing cells. If melatonin were to be active in terms of any tumor cells, those may be melanoma cells.

A variety of tumors have been reported to be associated with exposure of humans to EMF. Breast cancers, brain tumors, and various types of leukemia are most often noted. Melatonin levels in patients with brain tumors and leukemias remain essentially unstudied. However, in animal studies, melatonin protects against at least one transplanted leukemia (Buswell, 1975).

There appears to be some correspondence between those neoplasms against which melatonin has been shown to be protective in laboratory studies, and those which appear associated with EMF epidemiologic studies. Melatonin has been demonstrated to protect against leukemia (Buswell, 1975), breast cancer (Blask et al., 1988), prostate cancer (Philo and Berkowitz, 1988), and melanoma (Das Gupta and Terz, 1967). Melatonin infusion has been reported successful in the treatment of lymphomas and breast cancer, as well as leukemia and several other neoplasms in humans.

Epidemiologic studies have cited leukemia, breast cancer, melanoma, prostate cancer, brain cancer, and lymphoma as neoplasms associated with EMF exposure or surrogates. (For a review, see Theriault, 1991.) No reports were found in the literature concerning melatonin effects on central nervous system cancers of interest (gliomas or astrocytomas). It is not known whether pineal function affects these neoplasms.

The seemingly higher incidence of breast cancer in humans exposed to EMF, along with the extensive experimental work (some of which is cited above) in which melatonin was found to be linked to the growth of such tumors, prompted Stevens (1987) to propose the melatonin hypothesis to explain the increased breast cancer risk in these individuals. This hypothesis was expanded by Stevens et al. (1992). If found to be valid, it could well be extended to any other cancer types that have a higher than normal incidence in humans living in high electromagnetic field environments.

This hypothesis is of interest to the field as a whole and bears consideration. Early tests of this hypothesis, wherein breast cancer risk was ascertained for men in occupations with increased EMF exposure, have been reported. As discussed in the next chapter, three such studies have been reported to date and all have shown increased breast cancer risk in men who are occupationally exposed.

A.4.4 Immune System Effects

In general, melatonin has been shown to have an immunostimulatory role (Maestroni et al., 1989). It has been suggested that one general function of the circadian melatonin rhythm is to optimize the ability of the organism to cope with environmental challenges. Although a single group initially conducted the bulk of these studies, the field has expanded and various scientists are now working on these interesting interactions.

Exogenous melatonin administration enhances antibody production by the spleen of mice injected with sheep red blood cells (SRBC). The primary antibody response to the SRBC was measured using the plaque-forming cell assay. Consistent with melatonin's actions on other systems, it was effective only when it was injected in the late afternoon but not when administered in the morning (Maestroni et al., 1986). Maestroni and Conti (1988) also found that melatonin's immunostimulatory effects were apparent only in antigen-primed animals. An examination of the initial studies of these workers suggests that the immuno-enhancing action of melatonin in mice is antigen-dependent and is primarily exerted on humoral responses to T-dependent antigens.

A variety of stressful conditions produce dramatic involution of the lymphoid organs and profound depression of immune reactivity; likewise, the injection of pharmacological doses of corticosteroids has similar effects on the immune system. Again, as little as 1 mg melatonin injected into mice daily virtually totally counteracted the effects of restraint stress and of corticosteroid administration (Maestroni and Conti, 1988). As previously demonstrated, the ability of melatonin to overcome the involutory changes of the immune system in stressed or corticosteroid-treated mice was apparent only if they were primed with T-dependent antigen.

Maestroni and Conti (1988) have gone on to show that the beneficial influence of melatonin on immune function is via the endogenous opioid system (EOS) on antigen-activated immunocompetent cells. When activated and non-activated mouse spleen cells were incubated in the presence of melatonin, it was readily shown that melatonin stimulates activated T-helper cells to release opioid agonists which, in turn, can enhance immunoresponsiveness; similar observations were obtained when the tests were done on human lymphocytes (Maestroni and Conti, 1991a, b). In summarizing the work of this group, it is apparent that melatonin is an important factor which is physiologically relevant to the T helper cell/opioid peptide/immune system.

Besides melatonin's action directly on cancer cells and its ability to suppress hormones that promote tumor growth, Maestroni and Conti (1991a) found melatonin may potentiate the anti-cancer action of interleukin-2 (IL-2) in murine tumor models in vivo. If this important finding is documented in a series of laboratories and under a variety of experimental conditions, it would be important in any situation where circulating melatonin levels are abnormally depressed. In general, Maestroni and Conti (1991b) provide interesting evidence and argue effectively that melatonin may reduce tumor growth via the indirect method described above; however, the definitive studies in humans showing that melatonin is reliably immunostimulatory and oncostatic have yet to be performed.

A.4.5 Aging Effects

In advanced age, the melatonin rhythm deteriorates, although there is evidence that the neuroendocrine system exhibits an increased sensitivity to the hormone (Reiter, 1992). The attenuation of the melatonin cycle with age seems to be a gradual process associated with the generalized decline in the functional capacity of many organs; thus, there seems to be no specific degenerative aging process which abruptly diminishes the ability of the pineal gland either to synthesize or secrete melatonin. Among mammals, reduced pineal melatonin synthesis with age has been studied most thoroughly in the Syrian hamster, rat, Mongolian gerbil, and man.

The biosynthetic activity of the human pineal gland responds like that of other species in advanced age; thus, the general consensus is that the amplitude of the blood melatonin rhythm drops gradually as humans become old (Touitou et al., 1981; Iguchi et al., 1982). Besides producing and secreting less melatonin at night, the pineal gland in elderly individuals exhibits a shorter duration of elevated nocturnal melatonin (Nir et al., 1986)

(Figure A-8). Finally, the chief urinary metabolite of melatonin, 6-hydroxymelatonin sulfate, shows a gradual age-related decline in humans between 20 and 95 years of age.

While a reduction in the amplitude of the melatonin rhythm in advanced age is now well documented, this is not the only parameter of the rhythm that changes with age. Usually, as the melatonin peak diminishes, so does the duration of elevated melatonin. Both the amplitude as well as the duration of the melatonin peak may be important to aspects of melatonin's ability to express its physiological activity. The most frequently proposed mechanism invoked to explain the attenuation of the pineal and plasma melatonin rhythms in old age is a reduction in the number of b-adrenergic receptors on the pinealocyte membrane. These receptors are primarily responsible for mediating the effects of nocturnally released NE from sympathetic neurons within the gland and initiating the intracellular events which lead to the augmented nighttime production of melatonin.

The progressive attenuation of the melatonin rhythm during aging may relate to a gradual diminution of b-receptor availability on the pinealocyte membrane. That the observed depression in pinealocyte b-receptor density accounts for the reduced melatonin-forming ability of the pineal gland in advanced age has recently received strong experimental support. Fisher 344 rats are a commonly used model in investigations of aging phenomena. Using this rat strain, it has been shown that life can be dramatically prolonged by restricting food intake throughout life.

Thus, ad libitum fed Fisher 344 rats usually die at approximately 30 months of age, while food-restricted animals not uncommonly survive to 44 months of age. When pineal biosynthetic activity and b-adrenergic receptor density were compared, ad libitum fed old rats (compared to 3-month-old animals) had highly depressed nocturnal pineal NAT activity and pineal and serum melatonin levels (Stokkan et al., 1991). All three parameters were significantly preserved in old rats that had experienced virtually life-long food restriction. Preservation of pineal melatonin synthesis was accompanied by a similar maintenance of high b-adrenergic receptor density in the pineal gland.

In recent years, melatonin has been at least theoretically defined as an anti-aging hormone. Indeed, the hypothesis has been put forward that "aging is secondary to pineal failure" (Rozenchwaig et al., 1987). According to this hypothesis, aging is a syndrome of a relative melatonin deficiency accompanied by a diminished melatonin:serotonin ratio, which is detrimental to neurophysiology and causally related to the aging process. The findings discussed above could relate to the theory. Namely, dietary restriction clearly increases the life span of a variety of animals; likewise, the procedure also tends to preserve the pineal melatonin rhythm.

Conservation of the melatonin rhythm in food-restricted animals is particularly interesting since, typically, prolonged food restriction depresses the function of virtually every other endocrine organ, yet the melatonin cycle responds in an opposite manner, i.e., it is maintained.

Data relating the ability of melatonin to influence the duration of survival are limited, but the correlations are positive. When mice are given melatonin in their drinking water, they lived

noticeably longer (20%), i.e., from a mean of 752 ± 80 days in non-melatonin treated mice to a mean of 931 ± 80 days in mice given melatonin every night (Macstroni et al., 1989). The contrary expectation would be that pinealectomized animals, with the resulting melatonin deficiency, would die at an earlier age than animals with the pineal intact; such studies have not been performed.

A.5 SUMMARY

Far from functioning as independent biological systems, the nervous, endocrine, and immune systems are now recognized to be closely coupled. These systems communicate among themselves using electrical nerve impulses, neurotransmitters, hormones, and "immunotransmitters."

In-vivo effects of EMF exposure in the laboratory appear to a great extent to be mediated by the nervous system. The physiologic mechanisms by which primary effects on nervous system function may have consequential effects on endocrine and immune system function are now understood relatively well.

Reviewers agree that evidence is now insufficient to determine if a causal association exists between EMF exposure and cancer. Plausible mechanisms for such a causal link have been suggested as hypotheses for further testing. The melatonin hypothesis is only one of many possible physiologic mechanisms that have been proposed to account for the association between EMF exposure and health effects as determined by epidemiologic studies. This hypothesis has been of interest because it can be tested readily in both animal and human populations.

A.6 REFERENCES FOR APPENDIX A

Arendt J (1985): Mammalian pineal rhythms. *Pineal Res. Rev.* 3:161-213.

Arendt J (1986): Assay of melatonin and its metabolites: Results in normal and usual environments. *J. Neural Transm.* (Suppl.) 21:11-35.

Arendt J (1988a): Melatonin and the human circadian system. In: *Melatonin-Clinical Perspectives*, A. Miles, D.R.S. Philbrick, C. Thompson, eds. Oxford: Oxford University Press, pp. 43-61.

Ariens Kappers J (1960): The development, topographical relations and innervation of the epiphysis cerebri in the albino rat. *Z. Zellforsch.* 52:163-215.

Armstrong SM (1989): Melatonin: The internal Zeitgeber of mammals? *Pineal Res. Rev.* 7:158-202.

Axelrod J (1974): The Pineal gland: Neurochemical transducer. *Science* 184:1341-1344.

- Bartsch C, Bartsch H, Jain AK, Laumas KR, Wetterberg L (1981): Urinary melatonin levels in human breast cancer patients. *J. Neural Transm.* 52:281-294.
- Bartsch C, Bartsch H (1984): The link between the pineal gland and cancer: An interaction involving chronobiological mechanisms. In: *Chronobiological approach to social medicine*, Istituto Italiano di Medicina Sociale, Rome, pp. 105-126.
- Bartsch C, Bartsch H, Fluchter SH, Attanasio A, Gupta D (1985): Evidence for modulation of melatonin secretion in men with benign and malignant tumors of the prostate: Relationship with pituitary tumors. *J. Pineal Res.* 2:121-132.
- Bartsch H, Bartsch C (1988): Unidentified pineal substances with anti-tumor activity. In: *The pineal gland and cancer*, D. Gupta, A. Attanasio, and R.J. Reiter, eds. Brain Research Promotion, T #bingen, pp. 369-376.
- Beck-Friis J, Hanssen T, Kjellman BF, Wetterberg L (1983): Serum melatonin and cortisol in subjects after the administration of dexamethasone and propranolol. *Psychopharmacol. Bull.* 19:646-648.
- Berga SL, Mortola JF, Yen SSC (1988): Amplification of nocturnal melatonin secretion in women with hypothalamic amenorrhea. *J. Clin. Endocrinol. Metab.* 66:242-245.
- Bittman EL (1984): Melatonin and photoperiodic time measurement: Evidence from rodents and ruminants. In: *The pineal gland*, R.J. Reiter, ed. New York: Raven Press, pp. 155-192.
- Blask DE (1984): The pineal: An oncostatic gland? In: *The pineal gland*, R.J. Reiter, ed. New York: Raven Press, pp. 253-284.
- Blask DE, Hill SM (1986): Effects of melatonin on cancer: Studies on MCF-7 human breast cancer cells in culture. *J. Neural Transm., Suppl.* 21:433-450.
- Blask DE, Hill SM (1988): Melatonin and cancer: Basic and clinical aspects. In: *Melatonin: Clinical perspectives*, A. Miles, D.R.S. Philbrick, and C. Thompson, eds. Oxford: Oxford University Press, pp. 128-173.
- Blask DE, Hill SM, Pelletier DB (1988): Oncostatic signaling by the pineal gland and melatonin in the control of breast cancer. In: *The pineal gland and cancer*, D. Gupta, A. Attanasio, and R.J. Reiter, eds. Brain Research Promotions, T #bingen, pp. 195-206.
- Blask DE, Cos S, Hill SM, Burns DM, Lemus-Wilson A, Grosso DS (1991): Melatonin actions on oncogenesis. In: *Role of melatonin and pineal peptides in neuroimmunomodulation*, F. Fraschini and R.J. Reiter, eds. New York: Plenum, pp. 233-242.
- Bornman MS, Oosthuizen JMC, Barnard HC, Schulenburg GW, Boomker D, Reif S (1989): Melatonin and sperm motility. *Andrologia* 21:483-487.

Boyce PM (1985): 6-sulfatoxymelatonin in melancholia. *Amer. J. Psychiat.* 142:125-127.

Brainard GC, Vaughan MK, Reiter RJ (1986): Effect of light irradiance and wavelength on the Syrian hamster reproductive system. *Endocrinology* 119:648-654.

Broadway J, Folkard S, Arendt J (1988): Bright light phase shifts the human melatonin rhythm in Antarctica. *Neurosci. Lett.* 79:185-188.

Brzezinski A, Seidel MM, Lynch HJ, Deng MH, Wurtman RJ (1987): Melatonin in human preovulatory fluid. *J. Clin. Endocrinol. Metab.* 64:865-869.

Bubinek GA, Brown GM, Grotta LJ (1977): Immunohistochemical localization of melatonin in the rat digestive system. *Experientia* 33:662-663.

Buswell RS (1975): The pineal and neoplasia. *The Lancet* (ii) 134-135.

Cagnacci A, Elliott JA, Yen SSC (1991): Amplification of pulsatile LH secretion by exogenous melatonin in women. *J. Clin. Endocrinol. Metab.* 73:210-212.

Carter DS, Goldman BD (1983): Antigonadal effects of timed melatonin infusion in pinealectomized hamsters (*Phodopus sungorus sungorus*): Duration is the critical parameter. *Endocrinology* 113:1261-1267.

Champney TH (1990): Propranolol blockade of short photoperiod-induced gonadal regression: Modification by melatonin injections or implants. *J. Pineal Res.* 9:75-83.

Chan MY, Pang SF, Tang PL, Brown GM (1984): Studies on the kinetics of melatonin and N-acetylserotonin in the rat at mid-light and mid-dark. *J. Pineal Res.* 1:227-236.

Chen HJ (1981): Melatonin: Failure of pharmacological doses to induce testicular atrophy in male golden hamster. *Life Sci.* 28:767-771.

Chen HJ, Brainard GC, Reiter RJ (1980): Melatonin given in the morning prevents the suppressive action of the reproductive system of melatonin given in the afternoon. *Neuroendocrinology* 31:129-132.

Claustrat B, Chazot G, Brun J, Jordan D, Sassolas G (1984): A chronobiological study of melatonin and cortisol secretion in depressed subjects: Plasma melatonin, a biochemical marker in major depression. *Biol. Psychiat.* 19:1215-1228.

Cromley WF Jr., Filicori M, Santori NF (1987): Gn RH secretion across the normal menstrual cycle. In: *The episodic secretion of hormones*, W.F. Cromley, Jr., and J.G. Hufner, eds. New York: Wiley, pp. 219-232.

Danforth DN, Tamarkin L, Mulvihill JJ, Bagley CS, Lippman M (1985): Plasma melatonin and the hormone-dependency of human breast cancer. *J. Med. Oncol.* 3:941-948.

- Das Gupta TK, Terz J (1967): Influence of the pineal gland on the growth and spread of melanoma in the hamster. *Cancer Res.* 27:1306-1311.
- Earnest DJ, Turek FW (1983): Effect of one-second light pulses on testicular function and locomotor activity in the golden hamster. *Biol. Reprod.* 28:557-563.
- Ebadi M (1984): Regulation of the synthesis of melatonin and its significance to neuroendocrinology. In: *The pineal gland*, R.J. Reiter, ed. New York: Raven, pp. 1-37.
- Ehrenkranz JR, Tamarkin L, Comite F, Johnsonbaugh RE, Bybee DE, Loriaux DL, Cutter GB Jr. (1982): Daily rhythm of plasma melatonin in normal and precocious puberty. *J. Clin. Endocrinol. Metab.* 55:307-310.
- Fellenberg AJ, Phillipou G, Seamark RF (1981): Urinary 6-sulfatoxy melatonin excretion and melatonin production rate: Studies in sheep and man. In: *Pineal function*, C.D. Matthews, and R.F. Seamark, eds. Amsterdam: Elsevier, pp. 143-149.
- Ferrier IN, Arendt J, Johnstone EC, Crow TJ (1982): Reduced nocturnal secretion of melatonin in chronic schizophrenia: Relationship to body weight. *Clin. Endocrinol.* 17:181-187.
- Georgiou E (1929): Uber die Natur und die Pathogenese der Krestumoren Radiale Heilung des Krebses bei weissen Mausen. *Zeit. Krebsforsch.* 38:562-572.
- Ghosh BC, El-Domeiri AAH, Das Gupta TK (1983): Effect of melatonin on hamster melanoma. *Surg. Forum* 24:121-122.
- Gibbs FP, Vriend J (1981): The half-life of melatonin elimination from rat plasma. *Endocrinology* 107:1796-1798.
- Goldman BD (1983): The physiology of melatonin in mammals. *Pineal Res. Rev.* 1:145-182.
- Gupta D, Attanasio A (1988): Pathophysiology of pineal function in health and disease in children. *Pineal Res. Rev.* 6:262-300.
- Heldmaier G, Lynch GR (1986): Pineal involvement in thermoregulation and acclimatization. *Pineal Res. Rev.* 4:97-139.
- Hoffman RA, Reiter RJ (1965): Pineal gland: Influence on gonads of male hamsters. *Science* 148:1609-1611.
- Iguchi H, Kato K, Ibayashi H (1982): Age-dependent reduction in serum melatonin concentrations in healthy human subjects. *J. Clin. Endocrinol. Metab.* 55:27-29.

- James SP (1990): Melatonin rhythm disturbances in mood disorders and sleep. In: *Biological rhythms, mood disorders, light therapy, and the pineal gland*, M. Shafii and S.L. Shafii, eds. Washington: American Psychiatric Press, pp. 191-208.
- Karasek M, Pawlekawski M, Nowakowska-Jankeiwicz B, Kolodziej-Maciejewska H, Zieleniewski J, Cieslak D, Leidenberger F (1990): Circadian variations in plasma melatonin, FSH, LH, and prolactin and testosterone levels in infertile males. *J. Pineal Res.* 9:149-156.
- Kitay JI, Altschule MD (1954): *The pineal gland*. Cambridge: Harvard University Press, 280 pp.
- Klein DC, Weller JC (1970): Indole metabolism in the pineal gland: A circadian rhythm in N-acetyltransferase. *Science* 169:1093-1095.
- Korf HW, Miller M (1984): The innervation of the mammalian pineal gland with special reference to central pinealopetal projections. *Pineal Res. Rev.* 2:41-86.
- Kothari LS (1987): Influence of chronic melatonin on 9,10-dimethyl-1,2-benzanthracene induced mammary tumors in female Holtzman rats exposed to continuous light. *Oncology* 44:64-71.
- Kothari LS (1988): Effect of melatonin on the mammary gland morphology, DNA synthesis, hormone profiles and incidence of mammary cancer in rats. In: *The pineal gland and cancer*. D. Gupta, A. Attanasio and R.J. Reiter, eds. Brain Research Promotions, T #bingen, pp. 207-219.
- Laakso ML, Porkka-Heiskanen T, Alila A, Sternberg D, Johannson G (1990): Correlation between salivary and serum melatonin: Dependence on serum melatonin levels. *J. Pineal Res.* 9:39-50.
- Lapin V (1976): Pineal gland and malignancy. *Osterreich. Zeit. Onkol.* 3:51-60.
- Lerner AB, Case JD, Takahashi Y, Lee Y, Mori W (1958): Isolation of melatonin, the pineal factor that lightens melanocytes. *J. Amer. Chem. Soc.* 80:2587.
- Lerner AB, Case JD, Heinzelmann RV (1959): Structure of melatonin. *J. Amer. Chem. Soc.* 81:6084-6085.
- Lewy AJ (1983): Biochemistry and regulation of mammalian melatonin production. In: *The pineal gland*, R. Relkin, ed. New York: Elsevier, pp. 77-128.
- Lewy AJ, Nummerger JI, Wehr TA (1985): Supersensitivity to light - a possible trait marker for manic-depressive illness. *Amer. J. Psychiat.* 142:725-727.

Lewy AJ, Sack RL, Singer CM (1990): Bright light, melatonin, and winter depression: The phase-shift hypothesis. In: *Biological rhythms, mood disorders, light therapy, and the pineal gland*, M. Shafii and S.L. Shafii, eds. Washington: American Psychiatric Press, pp. 141-174.

Lynch HJ, Wurtman RJ, Moskowitz MA, Archer MC, Ho MH (1975): Daily rhythm in human urinary melatonin. *Science* 187:169-170.

Maestroni GJM, Conti A (1988): Role of the pineal gland in immunity. III. Melatonin antagonizes the immunosuppressive effect of acute stress via an opiateergic mechanism. *Immunology* 63:465-472.

Maestroni GJM, Conti A (1991a): Action of melatonin on immune system. In: *Role of melatonin and pineal peptides in neuroimmunomodulation*, F. Fraschini and R.J. Reiter, eds. New York: Plenum, pp. 201-210.

Maestroni GJM, Conti A (1991b): Beta-endorphin and dymorphin mimic the circadian immunoenhancing and anti-stress effects of melatonin. *Int. J. Immunopharmacol.* 11:333-337.

Maestroni GJM, Conti A, Pierpaoli W (1986): Role of the pineal gland in immunity. Circadian synthesis and release of melatonin modulates the antibody response and antagonizes the immunosuppressive effect of corticosterone. *J. Neuroimmunol.* 13:19-26.

Maestroni GJM, Conti A, Pierpaoli W (1989): Melatonin, stress and the immune system. *Pineal Res. Rev.* 7:203-226.

Mayeda A, Nurnberger J, Jr. (1990): Melatonin and circadian rhythms in bipolar mood disorder. In: *Biological rhythms, mood disorders, light therapy, and the pineal gland*, M.Shafii and S.L. Shafii, eds. Washington: American Psychiatric Press, pp. 117-139.

Mendelwicz J, Linkowski P, Branchey L (1979): Abnormal 24 hour pattern of melatonin secretion in depression. *Lancet* ii:1362.

Menendez-Pelaez A, Reiter RJ, Guerrero JM, Puig-Domingo M, Howes KA (1988): Sexual dimorphism in N-acetyltransferase activity, hydroxyindole-0-methyltransferase activity, and melatonin content in the Harderian gland of Syrian hamster: Changes following gonadectomy. *Proc. Soc. Exp. Biol. Med.* 187:287-292.

Mhatre MC, van Jaarsveld AS, Reiter RJ (1988): Melatonin in the lacrimal gland: First demonstration and experimental manipulation. *Biochem. Biophys. Res. Commun.* 153:1186-1192.

Miles A, Grey JE (1988): Melatonin and schizophrenia - S biochemical link. In: *Melatonin: Clinical perspectives*, A. Miles, D.R.S. Philbrick, and C. Thompson, eds. Oxford: Oxford University Press, pp. 243-252.

Monteleone P, Maj M, Fusco M, Kemali D, Reiter RJ (1992): Depressed nocturnal plasma melatonin levels in drug-free paranoid schizophrenics. *Schizophrenia Res.*, in press.

Moore RY (1981): The suprachiasmatic nucleus, circadian rhythms, and regulation of brain peptides. In: *Neurosecretion and brain peptides*, J.B. Martin, S. Reichlen, and K.L. Bick, eds. New York: Raven, pp. 449-458.

Moore RY, Klein DC (1974): Visual pathways and the central neural control of a circadian rhythm in pineal serotonin N-acetyltransferase activity. *Brain Res.* 71:17-33.

Narita T, Kudo H (1985): Effect of melatonin on B16 melanoma growth in athymic mice. *Cancer Res.* 45:4175-4177.

Nir NPV, Hariharasubramanian N, Pilapil C, Isaac I, Thavundayil JX (1986): Plasma melatonin -- An index of brain aging in humans? *Biol. Psychiat.* 21:141-150.

Pang SF, Allen AE (1986): Extra-pineal melatonin in the retina: Its regulation and physiological function. *Pineal Res. Rev.* 4:55-95.

Pardridge WM, Mietus LJ (1980): Transport of albumin-bound melatonin through the blood-brain barrier. *J. Neurochem.* 34:1761-1765.

Parry BL, Berga SL, Kripke DF, Gillin JC (1990): Melatonin and phototherapy in premenstrual depression. In: *Chronobiology: Its role in clinical medicine, general biology, and agriculture, Part B*, D.K. Hayes, J.E. Pauly, and R.J. Reiter, eds. New York: Wiley-Liss, pp. 35-43.

Philo R, Berkowitz AS (1988): Inhibition of Dunning growth by melatonin. *J. Virol.* 139:1099-1102.

Reiter RJ (1973): Comparative physiology: Pineal gland. *Ann. Rev. Physiol.* 35:305-328.

Reiter RJ (1974): Circannual reproductive rhythms in mammals related to photoperiod and pineal function: A review. *Chronobiologia* 1:365-395.

Reiter RJ (1980): The pineal and its hormones in the control of reproduction in mammals. *Endocrine Rev.* 1:109-131.

Reiter RJ (1986a): Normal patterns of melatonin levels in the pineal gland the body fluids of human and experimental animals. *J. Neural Transm.*, Suppl. 21:35-64.

Reiter RJ (1986b): The pineal gland and pubertal development in mammals: A state of the art assessment. In: *The pineal gland during development*, D. Gupta and R.J. Reiter, eds. London: Croon Helm, pp. 100-116.

- Reiter RJ (1987): The melatonin message: Duration versus coincidence hypotheses. *Life Sci.* 40:2119-2131.
- Reiter RJ (1991a): Melatonin: That ubiquitously acting pineal hormone. *News Physiol. Sci.* 6:223-227.
- Reiter RJ (1991b): Pineal melatonin: Cell biology of its synthesis and of its physiological interactions. *Endocrine Rev.* 12:151-180.
- Reiter RJ (1992): The aging pineal gland and its physiological consequences. *BioEssays*, 14:169-175.
- Reiter RJ, Richardson BA (1992): Magnetic field effects on pineal indoleamine metabolism and possible biological consequences, *FASEB T.*, in press.
- Reiter RJ, Vaughan MK (1991): Dynamic organization of endocrine networks: The neuroendocrine-reproductive axis and the pineal gland as examples. *Ann. N.Y. Acad. Sci.* 118:11-29.
- Reiter RJ, Vaughan MK, Blask DE, Johnson LY (1975): Pineal methoxyindoles: New evidence concerning their function in the control of pineal-mediated changes in the reproductive physiology of male golden hamsters. *Endocrinology* 96:206-213.
- Reppert SM, Perlow MJ, Tamarkin L, Klein DC (1979): A diurnal rhythm in primate cerebrospinal fluid. *Endocrinology* 104:295-300.
- Rozenchwaig R, Grad BR, Ochoa J (1987): The role of melatonin and serotonin in aging. *Med. Hypotheses* 23:337-352.
- Rosengarten H, Meller E, Friedhoff AJ (1972): In vitro enzymatic formation of melatonin by human erythrocytes. *Res. Commun. Chem. Pathol. Pharmacol.* 4:457-465.
- Rudeen PK, Reiter RJ, Vaughan MK (1975): Pineal N-acetyltransferase activity in four mammalian species. *Neurosci. Lett.* 1:225-229.
- Sack RL and Lewy AJ (1988): Melatonin and major affective disorder. In: *Melatonin*, A. Miles, D.R.S. Philbrick and C. Thompson, eds. Oxford: Oxford University Press, pp. 205-227.
- Siever LJ, Caccaro EF, Davis KL (1987): Chronobiologic instability of the noradrenergic system in depression. In: *Chronobiology and psychiatric disorders*, A. Halaris, eds. New York: Elsevier, pp. 1-22.
- Stetson MH, Watson-Whitmyre M (1984): Physiology of the pineal and its hormone melatonin in annual reproduction in rodents. In: *The pineal gland*, R.J. Reiter, ed. New York: Raven Press, pp. 109-154.

- Stetson MH, Watson-Whitmyre M (1986): Effects of exogenous and endogenous melatonin on gonadal function in hamsters. *J. Neural Transm.* (Suppl. 21):55-80.
- Stevens RG (1987): Electric power use and breast cancer: A hypothesis. *Am. J. Epidemiol.* 125:556-561.
- Stevens RG (1992): Electric power use and breast cancer. *FASEB J.*, in press.
- Stokkan KA, Reiter RJ, Nonaka KO, Lerchl A, Yu BP, Vaughan MK (1991): Food restriction retards aging of the pineal gland. *Brain Res.* 545, 66-72.
- Tamarkin L, Westrom WK, Hamill AI, Goldman BD (1976): Effect of melatonin on the reproductive systems of male and female Syrian hamsters: A diurnal rhythm in sensitivity to melatonin. *Endocrinology* 90:1534-1541.
- Tamarkin L, Cohen M, Roselle D, Reichert C, Lippman M, Chabner B (1981): Melatonin inhibition and pinealectomy enhancement of 7,12-dimethylbenz (a) anthracene-induced mammary tumors in rats. *Cancer Res.* 41:4432-4437.
- Tamarkin L, Abastillas P, Chen H, McNemar A, Sidbury JB (1982a): The daily profile of plasma melatonin in obese and Prader-Willi syndrome children. *J. Clin. Endocrinol. Metab.* 55:491-495.
- Tamarkin L, Danforth D, Lubter A, DeMoss E, Cohen M, Chabner B, Lippman M (1982b): Decreased nocturnal plasma melatonin peak in patients with estrogen receptor positive breast cancer. *Science* 216:1003-1005.
- Tetsuo M, Poth M, Markey SP (1982): Melatonin metabolite excretion during childhood and puberty. *J. Clin. Endocrinol. Metab.* 55:311-313.
- Theriault G (1991): Health effects of electromagnetic radiation on workers: Epidemiologic studies. *Proc. Scientific Workshops on Health Effects of Electromagnetic Radiation on Workers.* NIOSH Publication, U.S. Department of Health and Human Services.
- Thompson C (1988): Melatonin and seasonal affective disorder. In: *Melatonin*, A. Miles, D.R.S. Philbrick, and C. Thompson, eds. Oxford: Oxford University Press, pp. 228-242.
- Tortosa F, Puig-Domingo M, Peinado MA, Oriolo J, Webb SA, deLievra A (1989): Enhanced circadian rhythm of melatonin in anorexia nervosa. *Acta Endocrinol.* 120:205-210.
- Touitou Y, Fevre M, Lagugvey M, Carayon A, Boydon A, Reinhert A (1981): Age and mental health related circadian rhythms of plasma levels of melatonin, prolactin, luteinizing hormone and follicle stimulating hormone. *J. Endocrinol.* 91:467-475.

- Vakkuri O (1985): Diurnal rhythm of melatonin in human saliva. *Acta Physiol. Scand.* 23:151-155.
- Vaughan GM (1984): Melatonin in humans. *Pineal Res. Rev.* 2:142-201.
- Vaughan GM, Meyer GC, Reiter RJ (1978): Evidence for a pineal-gonad relationship in humans. In: *The pineal and reproduction*, R.J. Reiter, ed. Karger, Basel, pp. 191-223.
- Vollrath L (1981): *The pineal organ*. Berlin: Springer, pp. 44-65.
- Vriend J (1983): Pineal-thyroid interactions. *Pineal Res. Rev.* 1:183-207.
- Waldhauser F, Lynch HJ, Wurtman RJ (1984): Melatonin in human body fluids: Clinical significance. In: *The pineal gland*, R.J. Reiter, ed. New York: Raven Press, pp. 345-352.
- Waldhauser F, Dietzel M (1988): Melatonin and aging. In: *Melatonin*, A. Miles, D.R.S. Philbrick, and C. Thompson, eds. Oxford: Oxford University Press, pp. 174-189.
- Waldhauser F, Gesinger B (1986): The pineal gland and its development in human puberty. In: *The pineal gland during development*, D. Gupta and R.J. Reiter, eds. London: Croom-Helm, pp. 134-143.
- Waldhauser F, Lynch HJ, Wurtman RJ (1984): Melatonin in human body fluids: Clinical significance. In: *The pineal gland*, R.J. Reiter, ed. New York: Raven Press, pp. 345-3752.
- Weiss B, Costa E (1968): Selective stimulation of adenyl cyclase activity in rat pineal by pharmacologically active catecholamines. *J. Pharmacol. Exp. Therap.* 161:310-319.
- Wetterberg L, Beck-Friis J, Kjellman BF (1990): Melatonin as a marker of a subgroup of depression in adults. In: *Biological rhythms, mood disorders, light therapy, and the pineal gland*, M. Shafii and S.L. Shafii, eds. Washington: American Psychiatric Press, pp. 69-96.
- Wilkinson M, Arendt J, Bradtke J, deZiegler D (1977): Determination of the dark induced increase of pineal N-acetyltransferase activity and the simultaneous radioimmunoassay of melatonin in the pineal, serum and pituitary tissue in the rat. *J. Endocrinol.* 72:243-244.
- Wilson BW, Snedden W, Mullen PE, Silman RE, Smith I, Laudon J (1977): A gas chromatography-mass spectrometry method for the quantitative analysis of melatonin in plasma and cerebrospinal fluid. *Anal. Biochem.* 81:283-291.
- Wilson BW, Anderson LE (1990): ELF electromagnetic field effects on the pineal gland. In: *Extremely low frequency electromagnetic fields: The question of cancer*. B.W. Wilson, R.G. Stevens, and L.E. Anderson, eds. Columbus: Battelle Press, pp. 159-186.

Wurtman RJ, Axelrod J, Phillips L (1963): Melatonin synthesis in the pineal gland: Control by light. *Science* 142:1071-1073.

Yu H-S, Yee RW, Howes KA, Reiter RJ (1990): Diurnal rhythms of immunoreactive melatonin in the aqueous humor and serum of male pigmented rabbits. *Neurosci. Lett.* 116:309-311.

Zatz M (1981): Pharmacology of the rat pineal gland. In: *The pineal gland, Vol. I, anatomy and biochemistry*, R.J. Reiter, ed. Boca Raton: CRC Press, pp. 229-242.

