



U.S. Department  
of Transportation

# A Guide to Land Use and Public Transportation Volume II: Applying the Concepts

December 1993





***A Guide to Land Use and Public Transportation***

***Volume II: Applying the Concepts***

***Prepared By  
The Snohomish County Transportation Authority***

***December 1993***



*Printed on recycled paper*

HE  
148.5  
G85  
v. 2

18432

OCT 11 '94



---

***The Snohomish County Transportation Authority  
Board of Directors***

**Chairman Bill Brubaker**, Snohomish County Council  
**Vice Chairman Pete Kinch**, Mayor, City of Everett  
**Laura Hall**, Mayor, City of Edmonds  
**Peter Hurley**, Snohomish County Council  
**Bob Kraski**, Mayor, City of Arlington  
**Liz McLaughlin**, Snohomish County Council

***Technical Advisory Committee***

**Gordon Burch**, City of Bothell  
**Rob Chave**, City of Edmonds  
**Ned Conroy**, Puget Sound Regional Council  
**Dave Crout**, County of Snohomish  
**Dennis Derickson**, County of Snohomish  
**John Dewhirst**, County of Snohomish  
**Dave Dunneback**, Everett Transit  
**Richard Embry**, Gramor Development, Inc.  
**Rob Fellows**, WA State Department of Transportation  
**Marvin Freel**, Community Transit  
**Pete Friedman**, City of Mill Creek  
**Celso Guitian**, MAKERS  
**Bryant Harrison**, City of Lynnwood  
**Tom Jensen**, City of Monroe  
**Paul Kaftanski**, City of Everett  
**Johannes Kurz**, County of Snohomish  
**Renée Marquardt**, MAKERS  
**Justin Osemene**, City of Everett  
**John Owen**, MAKERS  
**Charles Prestrud**, Community Transit  
**Nick Roach**, Puget Sound Regional Council  
**Brent Russell**, Community Transit  
**John Shadoff**, WA State Department of Transportation  
**Julie Shaw**, City of Mukilteo

***Consultants***

Illustrations, desktop publishing, and urban design  
consultation by:

**MAKERS Architecture and Urban Design**  
Seattle, WA

Chapter 1, Developing an Urban Center,  
research, writing, and consultation by  
**Steve Clagett**  
Seattle, WA

Chapter 6, Barrier-Free Pedestrian Access,  
consultation by:

**Barbara Allan**, Easter Seals, Seattle, WA, and  
**Don Ankney & Gretchen Weber**, Community Transit

***The Snohomish County Transportation Authority Staff***

**Caroline Feiss**, Executive Director  
**John Dewhirst**, Senior Planner  
**Matt Feeney**, Senior Planner  
**Penelope Bell**, AICP, Associate Planner  
**Ardelle Bailey**, Office Administrator  
**Roberta Wilson**, Administrative Secretary

**SNO-TRAN**

1133 164th Street SW, #102  
Lynnwood, WA 98037  
(206) 787-1901

This project was funded in part by grants from the Federal Transit Administration (FTA). The contents of this book reflect the views of SNO-TRAN, which is solely responsible for the information presented here. The contents do not necessarily reflect the views or policy of the FTA or the U.S. Government.



December 31, 1993

Dear Interested Community Member:

SNO-TRAN is pleased to present its new publication, "A Guide to Land Use and Public Transportation, Volume II: Applying the Concepts."

In Volume I, we introduced the topic of "public transportation compatible land use" and surveyed a variety of transit-friendly community planning and design ideas. Volume II explores these ideas further, offering specific strategies and designs for public officials, planners, developers, and citizens interested in making their communities more transit compatible. Volume II was two years in the making, and was prepared with the help of a team of planners, transit operators, developers, and consultants from Snohomish County and the Puget Sound region.

SNO-TRAN continues to be dedicated to helping Snohomish County communities create an environment in which people have a variety of transportation options. We believe this Guide gives communities tools that will help develop those options, as well as keep Snohomish County communities vibrant and attractive places to live. Along with this Guide, SNO-TRAN has educational slide shows, videos, and other materials that can help a community get started in creating a public transportation compatible environment. As always, you are free to use these materials fully. If you reprint text, ideas, or graphics from this Guide, we ask only that you cite this Guide as your source. For more information, you are welcome to call us at (206) 787-1901.

Sincerely,



Bill Brubaker, Chairman  
Snohomish County Councilmember

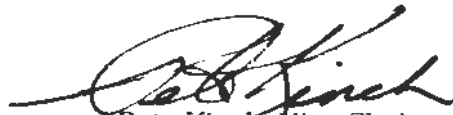

Pete Kinch, Vice Chairman  
Mayor, City of Everett



Liz McLaughlin  
Snohomish County Councilmember

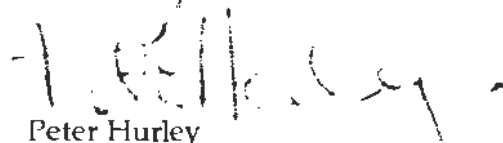

Peter Hurley  
Snohomish County Councilmember

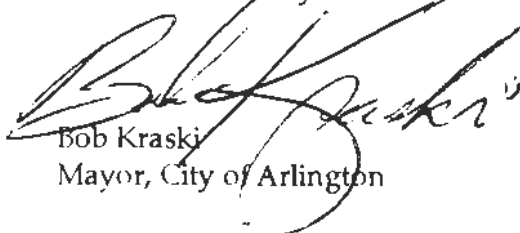

Bob Kraski  
Mayor, City of Arlington

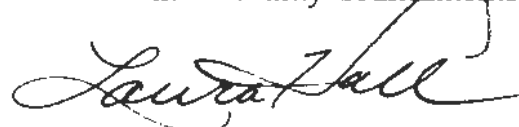

Laura Hall  
Mayor, City of Edmonds



## ***Table of Contents***

---

Developing an Urban Center	Chapter <b>1</b>
<hr/>	
Transit Compatible Site Plans	Chapter <b>2</b>
<hr/>	
Transit Friendly Shopping Centers	Chapter <b>3</b>
<hr/>	
Redesign of a Strip-Commercial Area	Chapter <b>4</b>
<hr/>	
Mixed Use	Chapter <b>5</b>
<hr/>	
Barrier Free Pedestrian Access	Chapter <b>6</b>
<hr/>	
Ideas for Small Communities	Chapter <b>7</b>
<hr/>	
Policies for Effective Public Transportation	Chapter <b>8</b>
<hr/>	
Transportation and Land Use Terms	Appendix <b>A</b>
<hr/>	
Sources	Appendix <b>B</b>
<hr/>	

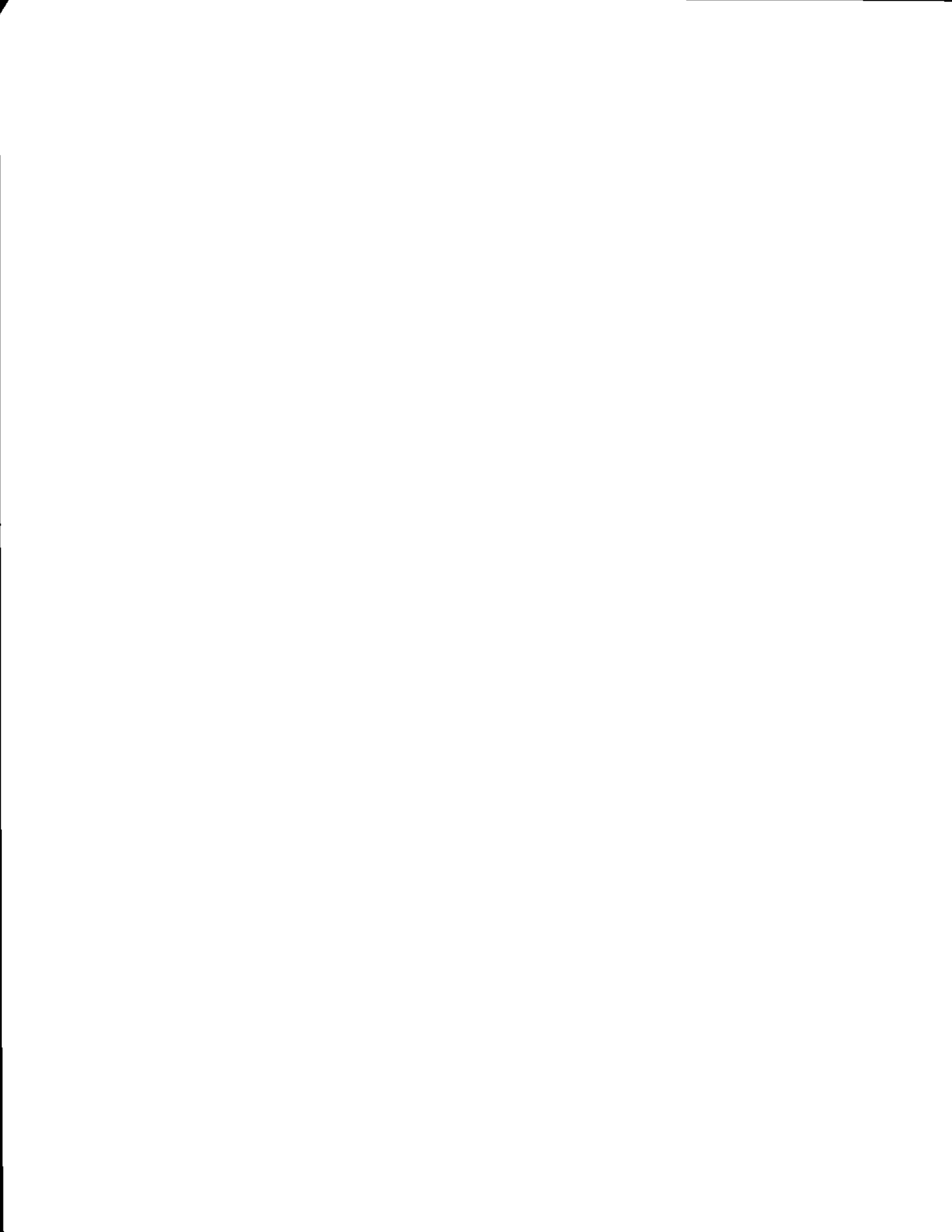

## ***Chapter 1: Developing an Urban Center***

---

***Introduction***

***Publicly Guided Development***

***Characteristics of a Good Urban Center***

***A Strategy for Action:***

- ***Visioning***
- ***Planning***
- ***Organizing***
- ***Implementing***

***Conclusions***

***Appendices***

- ***Public Development Financing***
- ***Suburban Retail Economics***
- ***Case Studies***

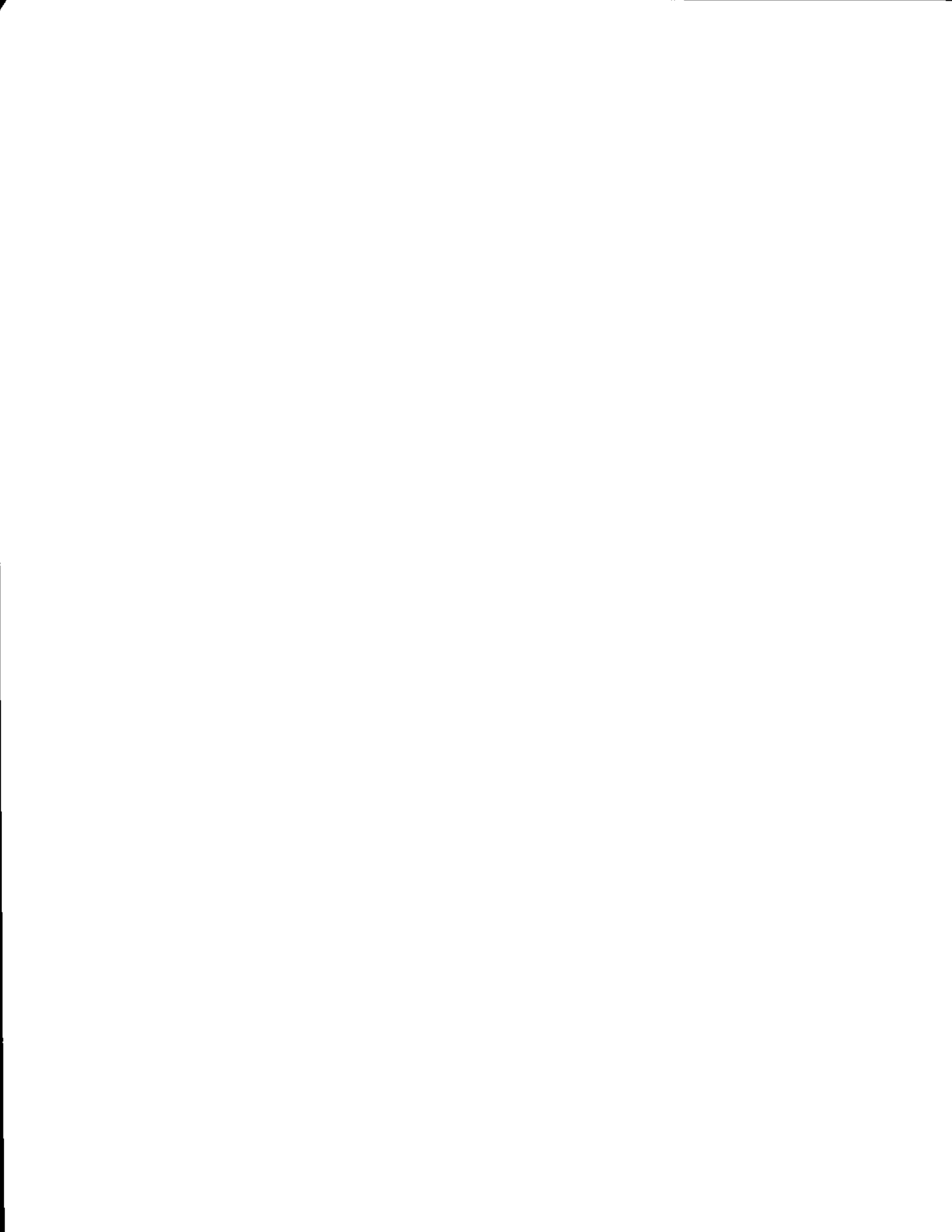



## Introduction: A Regional Vision

*"Consider the potential if the great American Land Use Game can be altered so that the commonwealth, the people and leaders of the Puget Sound region take charge, set the ground rules and then let the private sector execute the actual development."*

Neal Peirce

### **A Regional Vision**

"Consider the potential..." said author and public affairs analyst Neal Peirce when asked how the Puget Sound region might avert gridlock, smog and tract homes sprawling from the Sound to the foothills. Peirce had been invited by the *Seattle Times* to lend an "outside" perspective on the region's growing pains, and to offer a candid, impartial challenge to the region's citizens and leaders. *The Peirce Report* entreated the region to look critically at its booming industries and real estate market, and to visualize what might be achieved if these forces were harnessed by a coherent, 21st century vision.

Even as *The Peirce Report* rolled off the press, the Puget Sound Regional Council was taking the first step: leading the four central Puget Sound counties in preparing an ambitious thirty-year plan. Entitled *Vision 2020*, the plan called for growth boundaries to keep development from overrunning remaining forest and farmland, and proposed that new housing and jobs be concentrated in existing and planned urban centers. The vision was to create vibrant, attractive urban places, ranging in scale from "metropolitan centers" to "pedestrian pockets," and to link these centers via light rail, diamond lanes, and efficient, convenient transit services.



Urban centers of various scales form the cornerstone of the Puget Sound region's growth strategy. (Source: *Vision 2020*. Puget Sound Regional Council)

## Introduction: A Regional Vision

### At the Threshold

Today, *Vision 2020's* central places concept is the cornerstone of a State mandated growth management program, which in turn lays the foundation for an emerging regional rapid transit plan. The region has expressed a long-range vision, and the legal and administrative framework is in place. Now comes the real challenge. Can we overcome, as Neal Peirce put it, "the politics of postponement?" Can we move beyond studies and strategies, and begin investing in and building our vision?



*Vibrant, attractive urban places are the foundation of the regional vision.*

*This chapter is about how to make something happen through leadership and action at the local level. It is about city and county officials leading their communities and galvanizing the forces needed to carry out the urban centers strategy.*

### **Public Leadership and Local Action**

Building new urban centers and reinforcing the region's existing urban places will hinge on local effort. It must be community driven, meaning a concerted effort by developers, local and regional governments, citizens, business people, civic organizations, neighborhoods and interest groups. The Puget Sound region has the best of these players, and yet, noted Peirce, "when it comes to leadership that translates into action, more often than not, nothing happens."

This chapter is about how to make something happen through leadership and action at the local level. It is a rough blueprint for city and county officials to lead their communities (and the region) by galvanizing the forces needed to carry out the urban centers strategy.

## Introduction: A Regional Vision

---

### **What This Chapter is**

The chapter explains methods and tools that a city or town can use to envision, plan, organize, and build the centerpiece of its community. It draws from the experiences of other regions that have realized that good urban centers – vibrant, compact, and people-friendly – are key to livable regions and sustainable economies. From Toronto to Miami to San Francisco, regions are experimenting with new urban forms and with new approaches to urban center development. These experiences, as well as other, more time-tested urban planning methods, form the basis for the process described in this chapter.

*"Urban center," as used here, encompasses the full hierarchy of central places envisioned in Vision 2020 - and more. The chapter is about a process for the community ready to envision its own urban center, make a plan and begin developing it.*

### **What This Chapter is Not**

This chapter does *not* define the term "urban center." It will not determine for a community which "type" of urban center it should create, nor will it provide a formula for how much housing or retail space a city should attempt to absorb. "Urban center," as used here encompasses the full hierarchy of central places envisioned in *Vision 2020* – and more. The process suggested here is for any community ready to create its own vision, make a plan, and begin working actively to develop it.

The chapter is not a design manual. Where physical design is discussed it is discussed only briefly, and the examples are oriented toward those places that combine the greatest development potential with the greatest need for an infusion of civic design: suburbs, and particularly suburban commercial areas. But the techniques and concepts here can be used as effectively by the city looking to revitalize a historic downtown, or by a county working with a developer to create an urban "planned community."

Finally, the chapter is not meant to suggest that creating a vibrant urban center of even the smallest scale is as simple as fitting Tab A into Slot B. As urban historians are quick to point out, successful urban places *grow organically* (and messily) over time. In that respect, this chapter offers a process by which a community can plant the seeds for an urban center vision, and nourish their growth.

## Introduction: What's Wrong with the Suburban Center?

---

"There is no there there."

Gertrude Stein, 1937

### **A Place for Cars, Not People**

Perhaps the greatest challenge of the *Vision 2020* strategy is developing truly urban community centers in suburban, auto-oriented settings. The shopping centers, office parks, and "planned communities" built in the last 40 years grew out of a public policy to segregate land uses and market forces that promoted an automobile-oriented society. The result is a landscape characterized largely by:

- Housing segregated from work, shopping and recreation;
- Vast areas devoted to parking and roads;
- Disjointed (and congested) streets;
- Places scaled to driving, not walking;
- Lack of public places, buildings and activities;
- A degraded environment; and
- Lack of community identity.

This result did fairly well in the marketplace, but left a fragmented landscape lacking a sense of community or identity.

### **"Reactive" Planning**

Too much of community planning is *reactive*, a contradiction in terms that explains much about the haphazard layout of suburban places. In few instances have local governments taken a proactive role in shaping suburban centers. Instead, the basic form of these places was left to real estate and development industries driven solely by formulas that ensure a commercially viable "product." Private developers smartly learned what worked for the greatest number of consumers, then built it. Civic values and community needs, however, were largely left out of the process.

A city or county "comprehensive plan" may have preceded development, but that plan often did no more than apply "land use" labels and set general policies to "guide" market-driven development. Zoning was used as a means of separating rather than integrating land uses, while development standards were preoccupied with setbacks, parking, and other conveniences for cars. Government planners became entrenched in a *reactive* mode. They waited for developers to request a development permit, then tried to exact a few community "amenities" project by project, acre by acre, parking space by parking space – without a clear vision of what they were trying to achieve community-wide.

Perhaps the ultimate outcome of this process is the suburban commercial center, with its undifferentiated malls and commercial strips, which now substitute as "downtown" for most suburban places.

## Introduction: What's Wrong with the Suburban Center?

### Reactive Planning in a Suburban Setting

1. **Set Policy:** A vague guide for market-driven development and road improvements.
2. **Zone Land:** Segregate land uses, and accommodate cars.
3. **Apply Standards:** Design for automobile convenience.
4. **React to Permit Requests:** Try to exact a few community "amenities" project-by-project.

### Disadvantages:

- Auto-scaled/auto-dependent
- Hostile to pedestrians
- Disconnected activities
- Inefficient for transit
- Impermanent, poor quality architecture
- Lack of public places and community identity

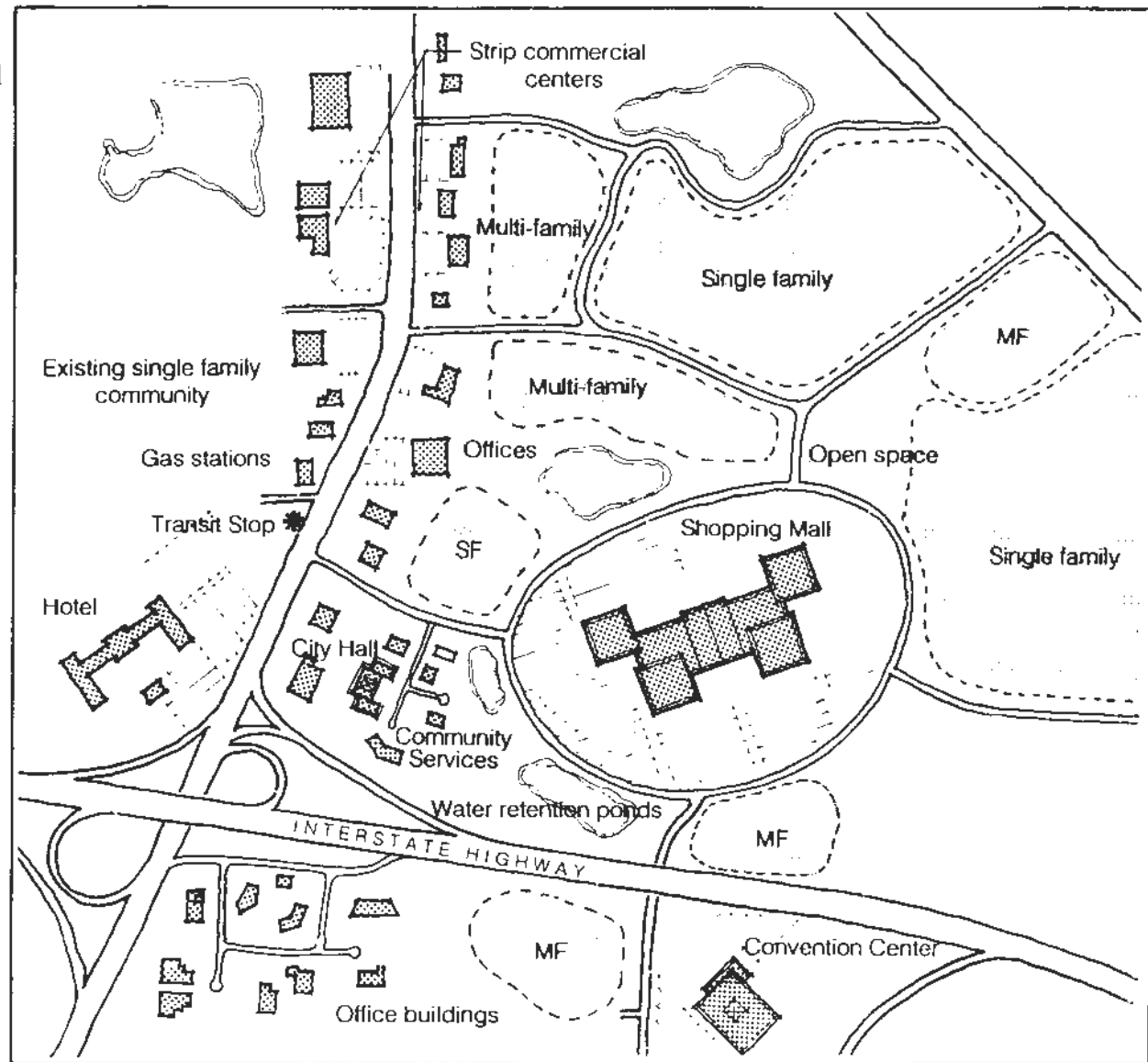

## Introduction: An Urban Center Alternative

---

### ***A Place for Community***

The lively, attractive urban center is certainly not a new idea for the Puget Sound area. Nor is the region lacking in good examples; such Seattle neighborhoods as Wallingford or Ballard or Green Lake, or towns such as Edmonds, Kirkland, or Snohomish all bring distinct community images to mind. Those images come from the dense, pedestrian-scaled, mixed use centers of these communities – places for walking in a people-oriented setting. Our best urban centers offer:

- Housing integrated with work, shopping, and recreation;
- More buildings and greenery, and fewer parking lots;
- A network of connected streets and sidewalks;
- Small blocks and walkable distances between buildings;
- Public parks, squares, and services;
- Conservation of environmental resources; and
- Community activities.

Some of these centers were planned; others grew more naturally in an era when walking and transit were essential. Today, pedestrian-friendly places are sometimes built from scratch by private developers, but typically only when a single land owner is involved. In today's suburban setting, with many land owners and diverse interests, duplicating what history or a single, determined developer has produced will take a new, more proactive approach on the part of local government.

### ***"Proactive" Planning***

Just as *reactive planning* is a contradiction in terms, *proactive planning* may technically be redundant. (Planning, after all, means to plot a strategy for future action.) Still, the term is used here to emphasize the conscious, action-oriented, community-controlled process needed to realize the urban centers concept. This process departs from the purely economic and for-profit development forces that have shaped most suburban places to date. It puts the "community" back into community planning and development.

While not a magic formula, proactive planning and publicly guided development are presented here as a four-step process:

1. ***Visioning*** – Creating a community-based visual image to guide urban center planning and development;
2. ***Planning*** – Drawing up thorough, specific, and action oriented plans for the urban center area;
3. ***Organizing*** – Assembling the public and private players and leading the effort to carry out the plan; and
4. ***Implementing*** – Investing public resources and becoming a partner with private developers.

Each of these steps is discussed in detail later in this chapter, in the section entitled "A Strategy for Action." Before getting to that strategy, the chapter explains the idea of publicly guided development, and briefly surveys key elements and principles for successful urban center design.

## Introduction: An Urban Center Alternative

### Proactive Planning of an Urban Center

1. **Establish a Vision:** Based on community goals and sound urban design principles.
2. **Create a Plan:** Comprehensive, specific, and aimed at implementation.
3. **Organize and Coordinate:** Create public and private development partnerships.
4. **Implement Development:** Regulate, invest, and jointly develop.

### Advantages:

- Pedestrian friendly
- Efficient for transit
- Scaled to people
- Attractive buildings and landscaping
- Public places and amenities
- Community identity

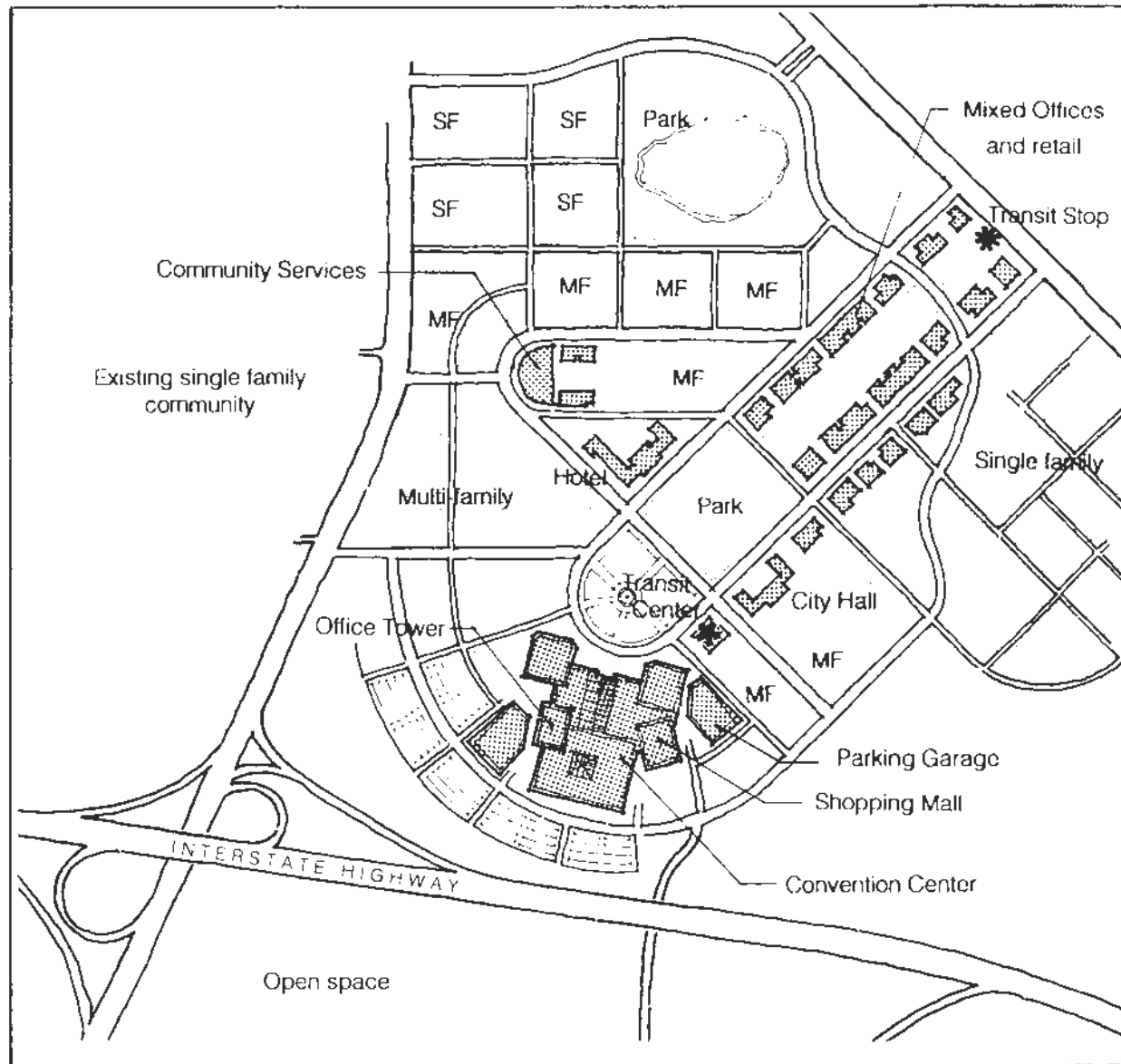

## Publicly Guided Development

### Local Government Leadership

Publicly guided development hinges on local government leadership. City officials must go beyond merely setting the ground rules; they must help create and promote a sound concept of the urban center, and must become a broker and partner in its development. The following are four areas where public leadership is critical.

#### 1 *Creating and Sustaining a Community Vision*

Developing an urban center, particularly in a suburban environment, is a long term prospect. It will involve multiple landowners and community interests, and will depart from established ways and patterns. Along the way there will be conflicting ideas about how development should proceed – or if it should proceed at all. A strong, community-based vision of the center is essential not only to set the process in motion, but to lift it over the inevitable hurdles. The vision needs to be documented in writing and drawings so that a few years into the effort, if momentum lapses, the participants can go back and rediscover where they were headed – and why.

While community visions sometimes begin as grass-roots efforts, this is rare and particularly unlikely to happen in a suburban area already lacking community cohesiveness. It is up to the local government, then, to gather the community and lead the effort to create a vision. Local officials must help their constituents dream big. These leaders must also see, keep, and share with their constituents a "second vision" – the path to success.

#### 2 *Creating Catalytic Value*

Central to urban center development is government's role in creating value that spurs, or "catalyzes," private development projects. Creating "catalytic value" means using public investment, regulation, incentives, and assistance to make a certain type of development or a certain location more enticing to private developers. Local governments can create value through physical improvements, such as streets and sewers, or through incentives, such as upzoning or streamlining permit requirements. These actions make land less expensive to develop and projects more marketable – the added "value" needed to attract private development partners. It may take a series of smaller, cumulative value-creating actions before the vision can take off on its own in the private sector.

*Creating "catalytic value" means using public investment, regulation, incentives and assistance to make a certain type of development or a certain location more enticing to private developers.*



## Publicly Guided Development

---

### ■ Planning and Coordination

Simply adopting a specific public plan for an area – and sticking to it – has immense value to private developers. Developers rely on predictable public policy to make sound investments. Time is money in land development, and the developer typically spends too much of both trying to figure out what the community wants. A clear vision and a sound plan to which the community is committed creates catalytic value by reducing cost and risk.

### ■ Regulatory Incentives

Zoning and other local regulations determine what types of buildings and activities can be built on a piece of land, and set standards for land use density and design. Loosening certain of those standards, such as parking requirements or building size limits, can create value by giving the developer more usable floor space than could otherwise be attained. Density bonuses can be built into regulations, offering greater floor space in exchange for certain public amenities. One approach to density bonuses, known as *transfer of development rights*, allows the owner of environmentally sensitive lands to sell their "development rights" to a developer seeking additional building intensity in an urban center.

### ■ Public Improvements

Perhaps the most obvious way for local governments to create catalytic value is to invest directly in public improvements:

- Sewer, water, and drainage facilities;
- Roads and walkways;
- Public transportation improvements;
- Parks, libraries, schools, public spaces and streetscape;
- Natural and historic resource preservation;
- Civic monuments and landmarks; and
- Public buildings, convention and cultural facilities.

Efficient public transportation is a key ingredient in an urban center. Often the city, transit agency, and developers can pool their resources in joint development projects that provide transit with riders, the city with transit facilities and amenities, and the developer with catalytic value in the form of good access, less parking demand, and other benefits.

## Publicly Guided Development

### ***Transit and Pedestrian Connections Create "Catalytic" Value:***

#### Efficient Circulation

- A grid of narrow streets defines pedestrian-scaled blocks.
- Sidewalks form a network for easy walking within the center.
- Local bus service connects the center to the rest of the community and provides local circulation.
- A transit center or rail station links the center with other communities.

#### Development Incentives

- Major businesses need less parking.
- A wide market, including commuters, residents and tourists, have easy access to center businesses.

#### Joint Development

- Local and regional transit agencies pool resources with local government and developers.
- Transit facilities provide public open space and amenities.
- Parking garages can be shared.

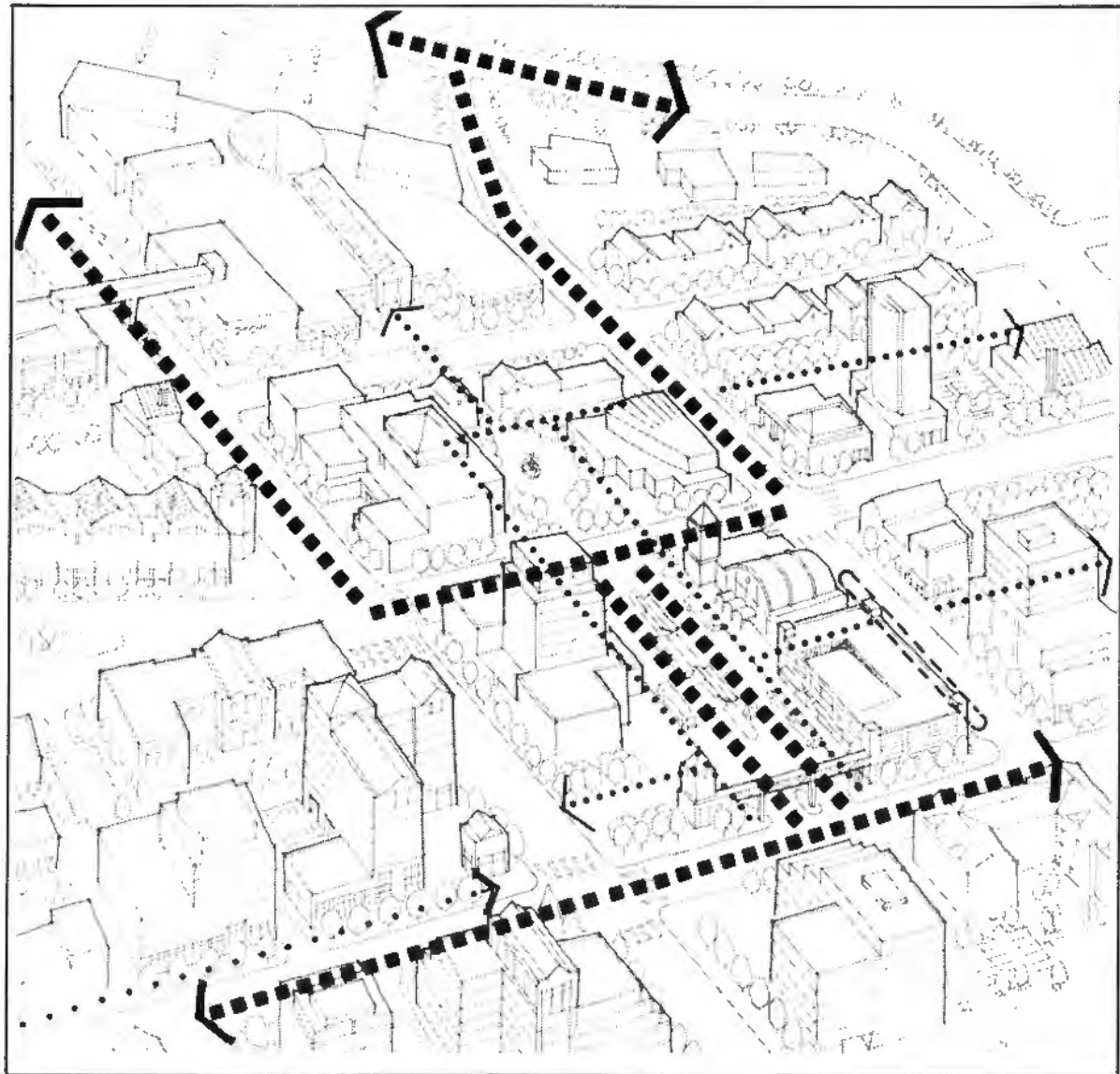

## ***Publicly Guided Development***

### ■ Public Assistance

Making a project financially feasible for a developer may take direct public assistance, especially in the first few years of center development. Public assistance can range from a reduction in the development fees normally imposed by the city to sharing of public facilities, such as a parking garage. With government help, projects that create affordable housing or meet other public goals may obtain financing at tax-exempt interest rates. Local government can create value through public assistance programs such as:

- Financing assistance for land development;
- Land assembly, sale, and lease;
- Tax exemptions for low-income housing; and
- Economic development projects.

Local public officials should become familiar with successful examples of publicly assisted development, including downtown revitalization in the '70s and '80s, and suburban redevelopment in similar communities in the region and elsewhere. Knowledge of the local economy should be bolstered with the advice of marketing and industry experts. A competitive bidding process can be a gauge. If a bid process for a private development partner fails to receive a response, additional public assistance may be needed. In Washington State, however, local governments need to be aware of prohibitions against public lending of credit imposed by the State's Constitution and other laws (see Appendix 1).

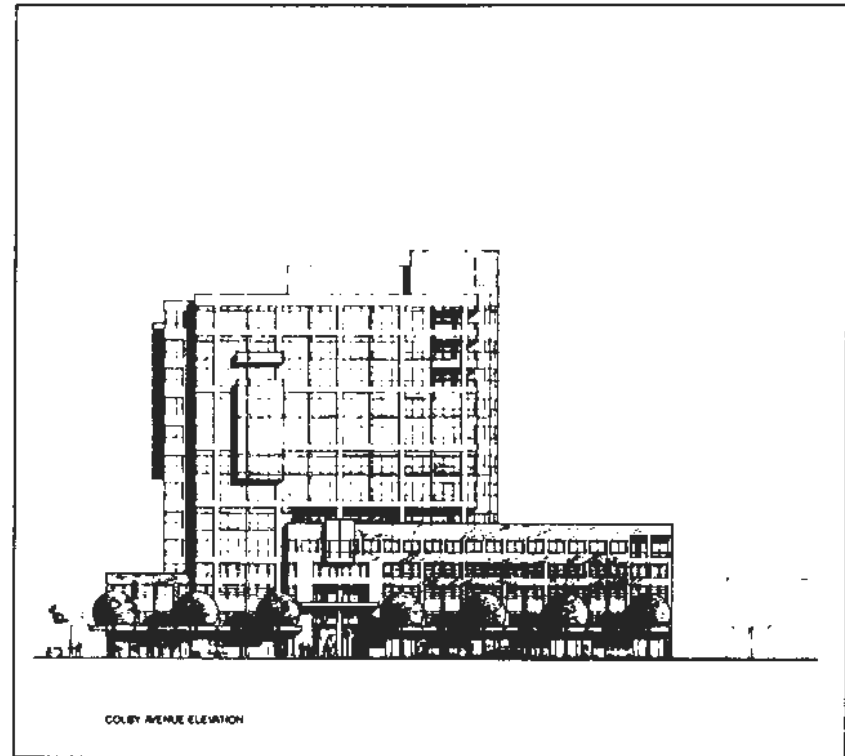

*The Everett Community Theater created catalytic value for the developer of "Colby Square," a downtown office/retail development.  
(Source: JDH Limited, Everett, WA)*

## Publicly Guided Development

### ■ Recapturing Value

Public development decisions create real estate financial windfalls (or wipeouts). It is the right and the responsibility of local jurisdictions to recapture for the public treasury a portion of newly created value. Many redevelopment authorities depend on the value they create to cover all or a portion of their operating costs and to finance additional public development activities. Public recapture of value needs to be balanced against the need for private investors to receive a fair return on their urban center development projects. The following are key ways for the public to recapture value:

1. **Property Taxes.** As improvements are built and an area becomes more economically attractive, land values and, with them, property tax revenues, will rise.
2. **Land Purchase, Assembly, and Resale.** With the legitimate public purpose such as developing an urban center, local governments can buy real estate early in the development process, then resell it when prices have appreciated. Some of the land can be used for public activities, transit facilities, affordable housing, etc., the remainder can be sold at a profit, taking advantage of the further appreciation that new public facilities bring.
3. **Executions/Inclusionary Zoning.** As the urban center takes off, property values will rise, making it reasonable to require developers to provide public amenities such as affordable housing and public spaces in exchange for land use and building permits. Zoning can be used to

make public amenities in private projects a precondition to the right to build. Economically strong parts of a development project will subsidize these requirements.

4. **Long-Term Leases and Equity Shares.** Transit and redevelopment authorities often buy excess land at a development site, then use long-term leases and equity sharing to share in the economic growth around their projects. Leases can be based in part on a percentage of the revenues developers receive from property tenants. As those rents rise, so does the return to the public. Similarly, publicly-provided financing or in-kind assistance creates an opportunity to require a share in any net proceeds, should the project be sold.

*Public recapture of value needs to be balanced against the need for private investors to receive a fair return on their urban center development projects.*

## Publicly Guided Development

### 3 Creating A Workable Conversion

To realize an urban center, public leaders must not only hold up a vision; they must navigate the path by which it is reached. While the objective is clear, public officials must work with developers, business-people, and citizens to take small steps toward intermediate objectives and must be prepared to find solutions when problems arise.

#### ■ Guiding the Forces of Evolution

Urban historian Jane Jacobs decried what she called "cataclysmic development," saying real, healthy neighborhoods and cities do not hatch from grand urban renewal schemes, but evolve over many years. Unfortunately, however, radical intervention may very likely be needed to launch an urban center vision, particularly in a suburban community. Still, a community must have patience as the new vision slowly emerges, and be open to new opportunities that come up over time. A small example of this evolutionary sequence is Boston's successful commercial marketplace, Faneuil Hall. Initially, developer James Rouse allowed pushcart vendors in the development. They provided character to the project and hid unleased space. Eventually many vendors graduated to permanent locations.<sup>1</sup>

<sup>1</sup>Frieden, Lynne B. Sagalyn and Bernard J. Downtown, Inc.: How America Rebuilds Cities. The MIT Press; Cambridge, MA 1992; p. 2f.

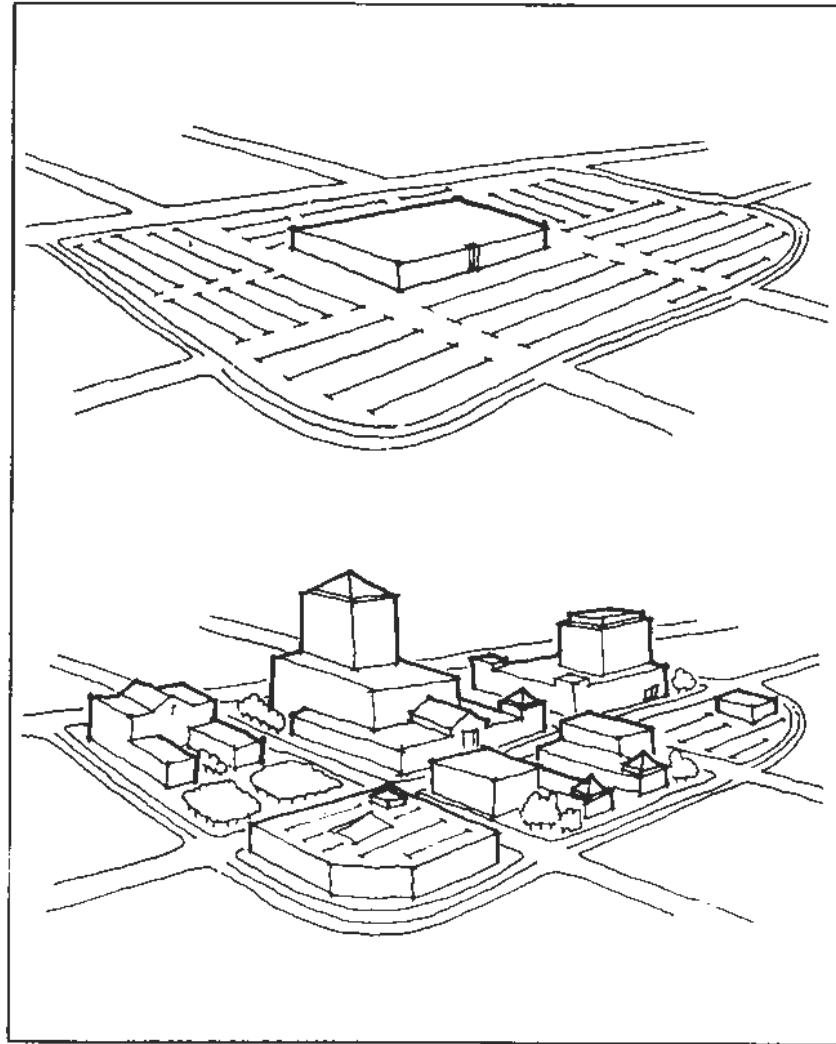

*Over time, parking garages, lower parking requirements and shared parking can allow for more intensive development of land.*

## Publicly Guided Development

### ■ Intermediate Steps

A workable conversion from a suburban or marginal urban area to a vibrant urban center will hinge in part on changing modes of transportation. To raise development density without creating traffic gridlock will mean less use of automobiles and more use of transit, walking, and cycling. To design and build places scaled to these modes, the land devoted to parking must be reduced.

As parking lots give way to more buildings and activities, the community should expect some additional traffic as part of the conversion process. In preparing urban center development regulations, the local government must be sure that standards for traffic flow allow more congestion in the urban center than might be tolerated elsewhere in the community. Otherwise, development may be stymied in the urban center and forced to less congested areas.

Parking will usually be one of the trickier parts of the conversion. Retailers now dependent on auto-driving customers must be assured that their parking is not going to be pulled out from under them if they are to be partners in urban center development. On-street parking, small "pocket" parking lots beside or behind buildings, and under-building garages can help ease the conversion to an urban form. There is probably no more potent a conversion device than a new parking garage which replaces surface parking. Parking structures keep the net number of parking spaces and free surface space for pedestrian and transit-oriented land uses. In an optimistic conversion strategy, the City of Boston built a largely unramped garage at Government Center. Later, as

parking demand diminished, the garage was converted, one floor at a time, to office space. Another conversion device is improved local transit service that connects surrounding suburban development with the center. The idea is to provide new alternatives as old ways are phased out.

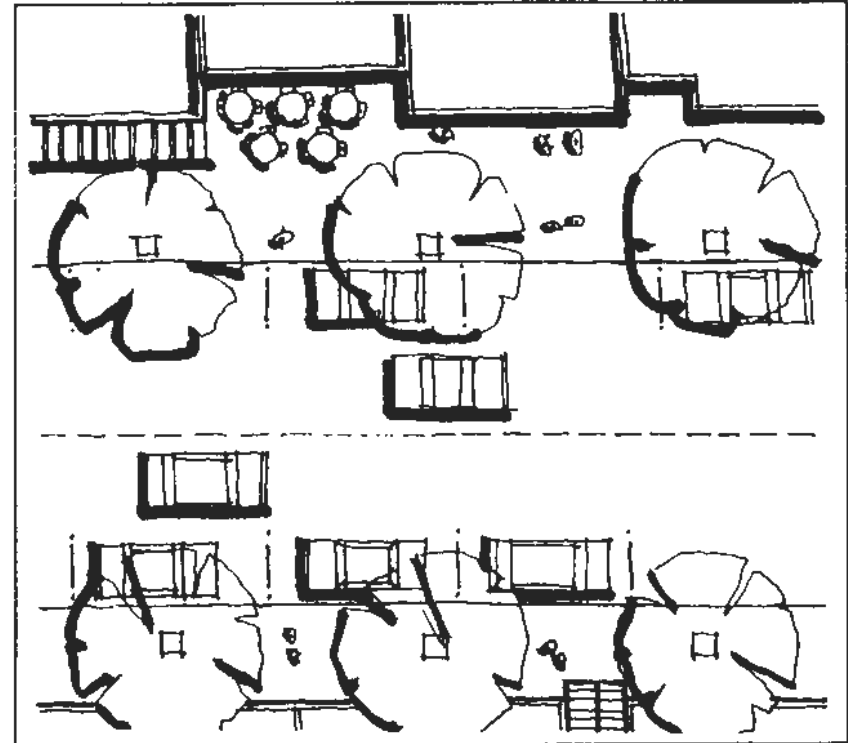

*On-street parking can help meet parking demand as center development takes place.*

## Publicly Guided Development

### 4 Fostering key deals

Key deals make projects happen. Land acquisition deals, financing deals, partnership deals, sales, leases and other agreements are critical points throughout the project. Key deals remove obstacles, saving each partner time and money. Wrapping up a key deal gives the project a surge and buoys public support. These deals most often happen by the parties going after them aggressively. Local government's job is to identify key deals, to bring together the players, and, where necessary, to use public resources to make the deal happen.

The Seattle Commons project (see Appendix 3) provides an example of a key deal in which a project opponent – and a major land owner in the project area – became a supporter through a complicated land exchange agreement. Most downtown revitalization projects in the '70s and '80s centered on the city-brokered sale of land to a developer at or below cost, usually with a publicly-built parking garage thrown in. These packages, as modified to fit the local setting and players, may be the key deal in developing an urban center.

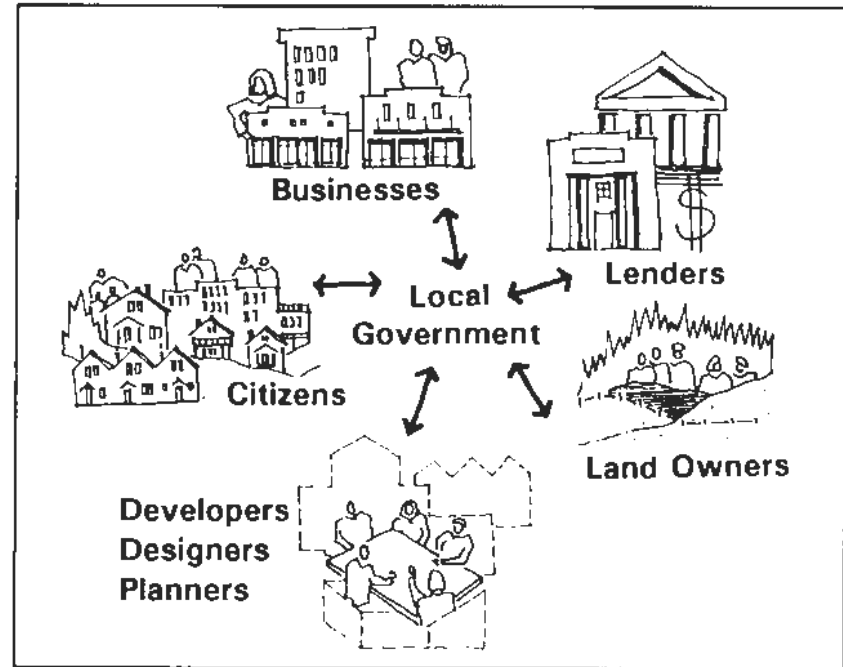

*Local government can broker key development deals between participants.*

## Characteristics of a Good Urban Center

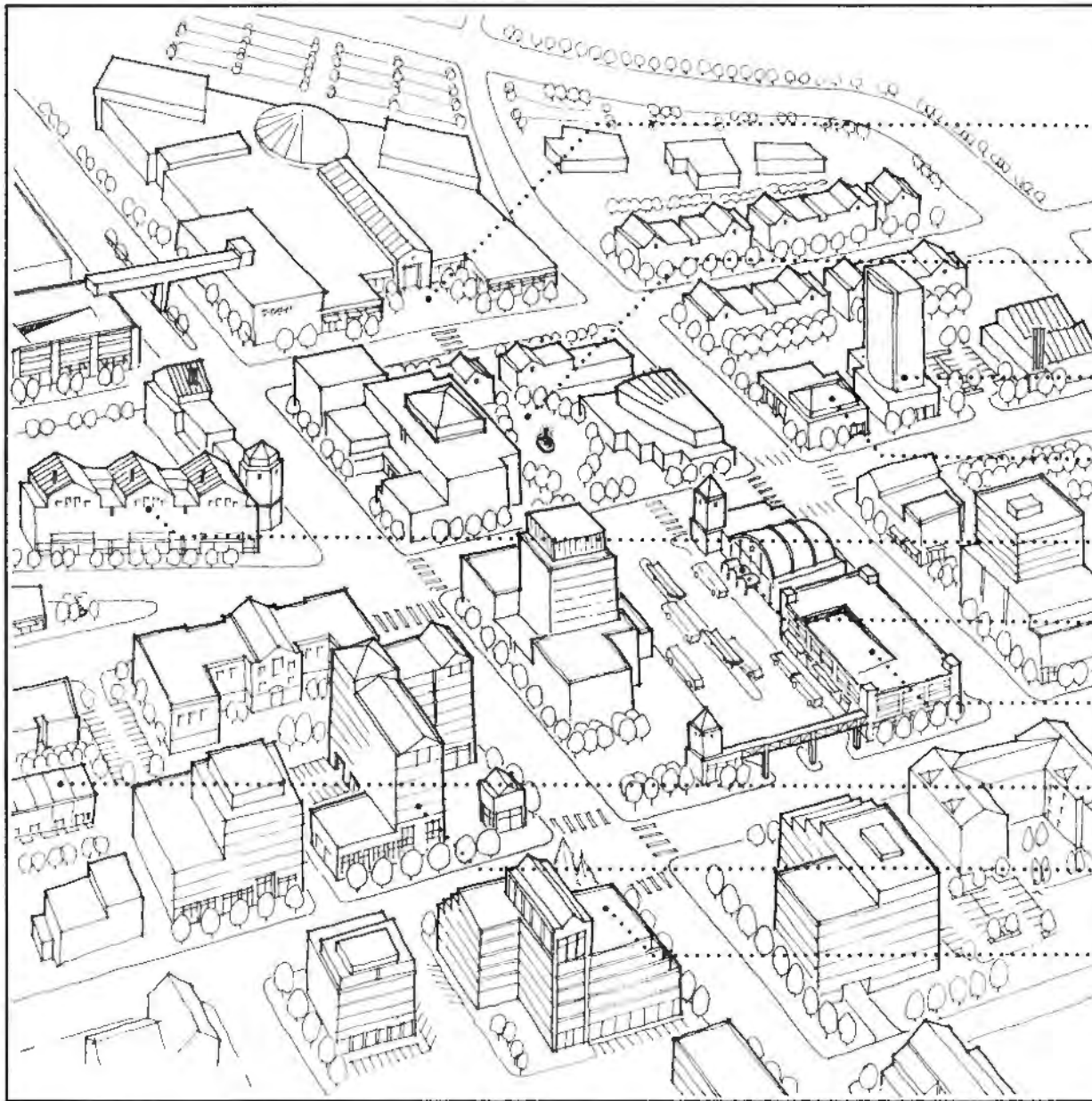

### **The Physical Elements of a Good Urban Center:**

- Shopping Center with main entrance facing the community center, not the highway
- Civic Center with City Hall, Library and Civic Plaza
- Senior Housing
- Community Center
- Housing and Offices over Retail
- Transit Center
- Parking Garages
- Townhouses
- Hotel
- Office Buildings



## Characteristics of a Good Urban Center

### What Makes an Urban Center Work?

Proactive planning and publicly guided development will not, by themselves, lead to an urban center. A community conditioned by auto-oriented planning and zoning can easily have its urban center vision veer toward more of the same suburban patterns. To prevent this from happening, the process must from the outset be guided by sound *urban* planning and design principles. These principles are beyond the scope of this chapter, but a few basic urban center characteristics and principles are mentioned here to emphasize the importance of a firm understanding of what makes an urban center a lively and attractive place to live and work.

#### ■ Compact Form and Diverse Activities

Compactness and diversity distinguish a true urban center from a suburban commercial area. A compact form allows people to move about without needing a car for every trip, while a mix of housing, work places, shops, restaurants,

recreation, parks, and public services gives people places to go and things to do. A good mix has activities that complement one another – like work and housing – and makes the urban center lively throughout the day, into the evening, and on weekends.

#### ■ Public Spaces and Civic Design

In a healthy and attractive urban center, streets, walkways, open spaces, and buildings are designed for public use – as places where people will gather and can interact with and enjoy their surroundings. The exact design of these public spaces and amenities is a matter of community taste, but a good urban center will contain certain elements and address certain basic principles of civic design. The facing page illustrates various elements that serve as urban center building blocks. The two pages that follow offer a brief survey of the principles needed to assemble these elements into an urban center that works.

*A variety of activities that overlap throughout the entire day is an important part of successful urban centers.*

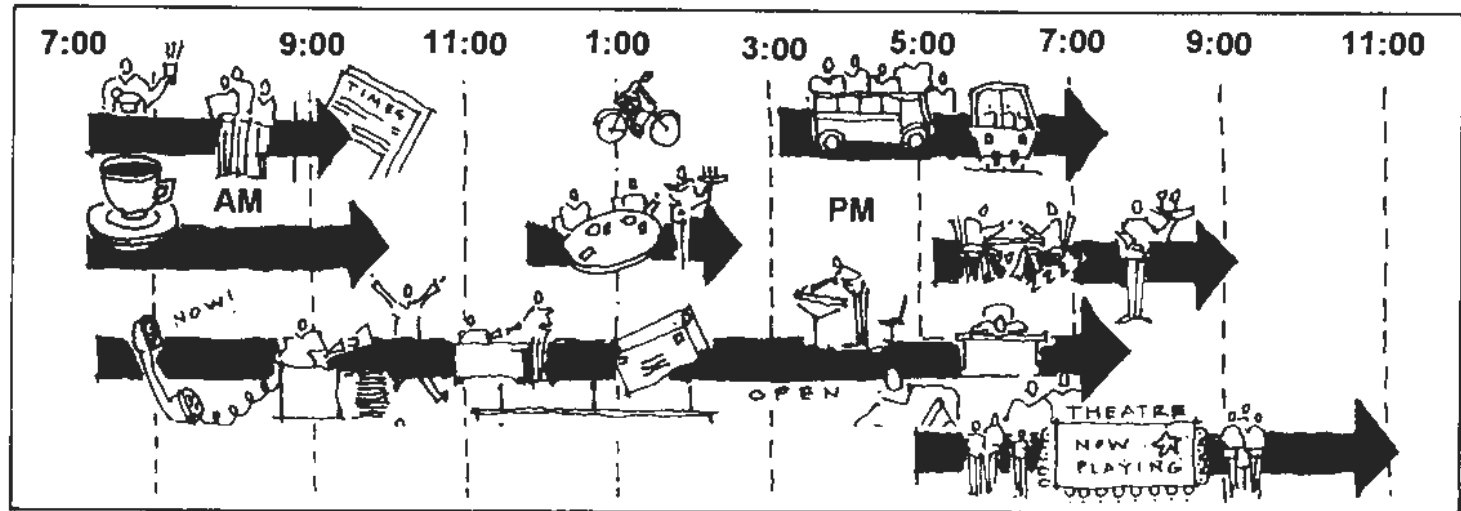

## Characteristics of a Good Urban Center

### Principles for Urban Center Visioning and Planning



1. **A Mix of Uses and Activities:**
  - Keeps the center active on weekends and evenings
  - Creates places for work, living, and recreation
  - Reduces the need to drive

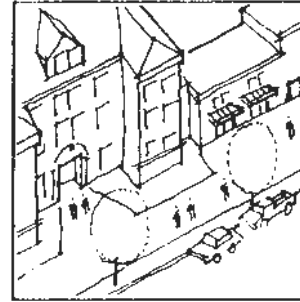

4. **Buildings Fronting the Street:**
  - Create an interesting, pleasant streetscape
  - Shorten walking distances; encourages street activity
  - Remove parking to behind or beside building

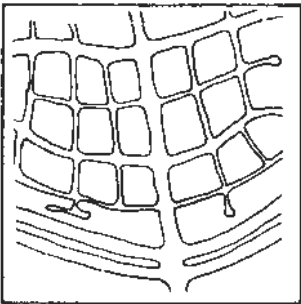

2. **A Network of Streets:**
  - Creates a pedestrian-scaled block size
  - Gives pedestrians, cyclists (and drivers) more route choices

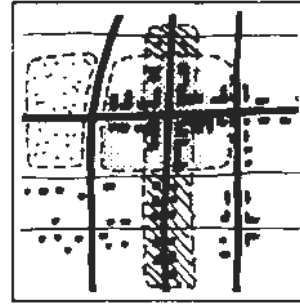

5. **Concentrated Development:**
  - Creates active community life
  - Makes transit efficient
  - Makes walking convenient

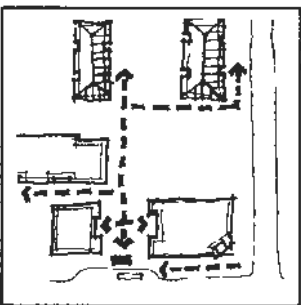

3. **Strong Connections:**
  - Link complementary uses and activities
  - Connect out to adjoining neighborhoods

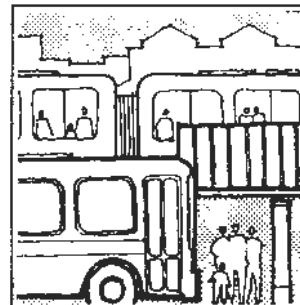

6. **Integrated Transportation Modes:**
  - Make it easy to travel without driving
  - Make alternatives to driving quick and safe for residents, commuters, shoppers, and tourists

## Characteristics of a Good Urban Center

### Principles for Urban Center Visioning and Planning

#### 7. Community Focal Point:

- Creates a central gathering place
- Organizes civic uses
- Provides for community services and activities

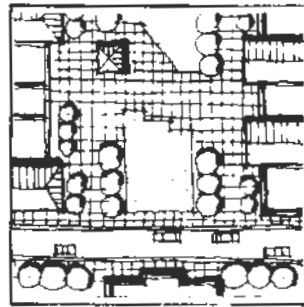

#### 8. Viable Residential Community:

- Creates a safe place to live
- Provides affordable housing; encourages community diversity and activity

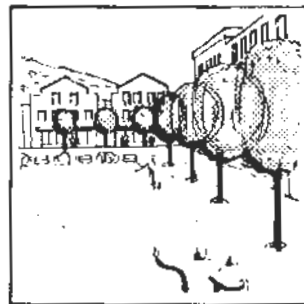

#### 9. Pedestrian Environment:

- Includes sidewalks, paths, trees, benches, and usable public open spaces
- Makes walking safe and enjoyable

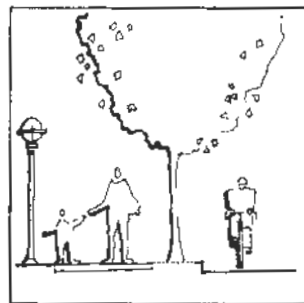

#### 10. On-Street Parking:

- Creates a buffer between pedestrians and moving cars
- Provides public parking
- Reduces need for parking lots

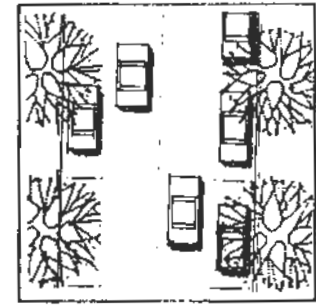

#### 11. Structured Parking:

- Reduces the amount of land used for storing cars
- Allows more land for buildings and open space

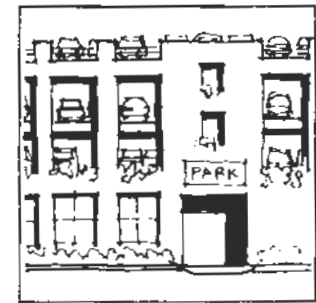

#### 12. Protected Natural Areas:

- Leave open space, add beauty and value
- Provide identity connected to natural features
- Leave a place for natural "residents"

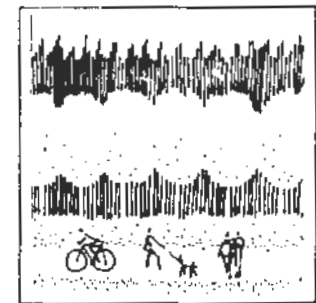

# A Strategy for Action

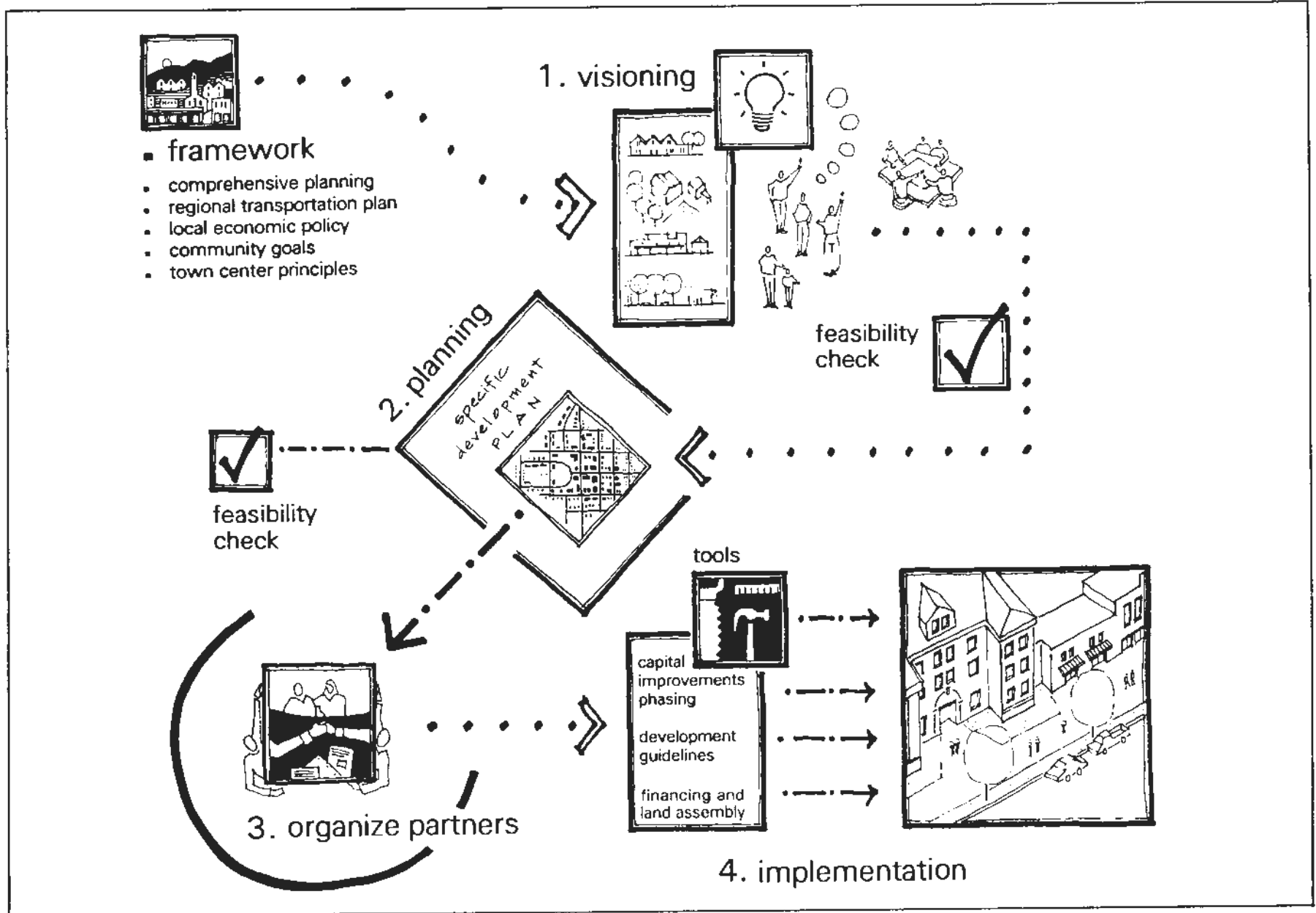

## A Strategy for Action: Phase One – Visioning



### ***Visioning and Consensus Building***

As the name implies, visioning means getting the community to express its common goals and values *visually*. It means using the skills of planners, designers, economists, and facilitators to create drawings and select photographs that illustrate and bring to life the community's dream. Visioning also means truly involving the community in the process of developing these images. If the vision is to have community ownership, the process must go well beyond normal "citizen participation" exercises. Citizens and stakeholders must have a chance to actively exchange their ideas and to interact with the experts. Everyone involved must feel their input made a difference - that their ideas were essential to creating the vision.

Successful community visioning will result in a clear image of the urban center and will generate enthusiasm about that image among developers, business people, citizens, and interest groups. The image will be based on sound urban design principles, but will also be realistic in terms of the types and amounts of development the market will support. The successful urban center vision will be embraced by a broad array of community stakeholders, because it will take the combined energies of these groups to realize the dream.

### ***Getting Started***

■ *Commit to a set of underlying objectives based on urban center elements and design principles.*

To start, there must be strong support from the city's political decision-making body. If the city government is not committed to the project - and to the idea of an urban center - it won't happen. City leaders must develop a clear understanding of the principles and elements involved in developing an urban center, and they must be prepared to commit the time and money needed to make the project work. Absent the rare emergence of a "grass roots" vision, city officials must, in fact, make the presumption even before the visioning process has begun, that the city needs, deserves, and will benefit from a thriving and unique urban center.

■ *Enlist the best professionals.*

In addition to a planning staff well-versed in urban design principles, visioning will require the aid of:

- Professional meeting facilitators;
- Private architects, planners, and urban designers;
- Economic and market analysts;
- Volunteers from the development industry; and
- Communications and public relations experts.

## ***A Strategy for Action: Phase One – Visioning***

---

■ ***Go public early with a simple concept that creates interest.***

Often planners spend a lot of time developing a concept behind closed doors or with a select group before going public. Nothing is more alienating to a local resident or businessperson than a detailed plan to which they had no input. The City should go public early with a simple urban center concept that attracts interest, coupled with a campaign that gets people involved in and excited by that early vision.

■ ***Meet with stakeholders to refine, verify, and get consensus on project objectives***

When Lynnwood, Washington, began its successful *Lynnwood Legacy* visioning process, city officials established these underlying objectives:

- Develop a compact mix of activities that take advantage of public transit services;
- Reduce automobile use;
- Increase transit use; and
- Create a place that encourages pedestrian activity.

With these basic objectives, the City set out to get others to understand the rationale behind the city center concept and to impart their enthusiasm about it to the community. At a "Kick-Off Meeting" of community stakeholders and interest groups, the objectives were refined to include:

- Express a clear community vision;
- Make the city center a transit district;
- Evaluate alternative designs for the center; and
- Develop a process for carrying out the resulting vision.

Keeping focus on an accepted set of underlying objectives prevents visioning from veering off course as each special interest group works to ensure its concerns are addressed.

■ ***Provide all participants with a solid background in the elements of good urban center design.***

In the initial meetings, every opportunity should be taken to educate participants about the elements of good urban centers and the principles of urban design. When newcomers get involved or the process begins to stray from the underlying objectives, a review of the urban center elements and principles is well worth the time.

■ ***Keep the vision within the bounds of what can reasonably be accomplished.***

A successful visioning process will get the community thinking big. However, from the outset participants must be wary of their dream becoming a pipe dream. Market analysts and developers can help select the most viable location and keep the size and the mix of activities within the bounds of what the local economy and real estate market will support. An official from the local transit agency can help the community capitalize on opportunities offered by public transportation services and facilities, while keeping expectations for service realistic. Expert advice is essential to a sound vision.

## ***A Strategy for Action: Phase One – Visioning***

### ***Getting the Word Out***

The first step in getting the community involved and building support is getting the word out. A public information campaign should include a variety of approaches and media:

- Mailed questionnaires to residents and businesses (utility companies might be willing to include these with their bills);
- Speaking engagements at civic organizations;
- Tours of the project area and of developments in other areas;
- Exhibits in public places;
- Informational brochures and newsletters; and
- Newspaper articles, press releases, and interviews.

The informational campaign should be designed with the help of public relations professionals, but volunteers can help with the hands-on work. The Seattle Commons project, a privately initiated urban center visioning exercise, has been a resounding success in part because it relies on volunteers for many of its outreach activities. This cuts costs, but more importantly, it gives citizens active involvement and a reason to take "ownership" in the vision.

### ***Building Community Consensus***

A true community-owned vision must be fleshed out through open processes that give stakeholders an opportunity to express their ideas to other citizens, facilitators, architects, planners, developers and political leaders. Different ideas and alternatives must be explored and evaluated. Lynnwood called this "collaborative planning." By bringing all stakeholders into the process, they sought to prevent the formation of alienated "NIMBY" groups and to develop a true community vision. Some innovative techniques being used to build community consensus for innovative visions follow.

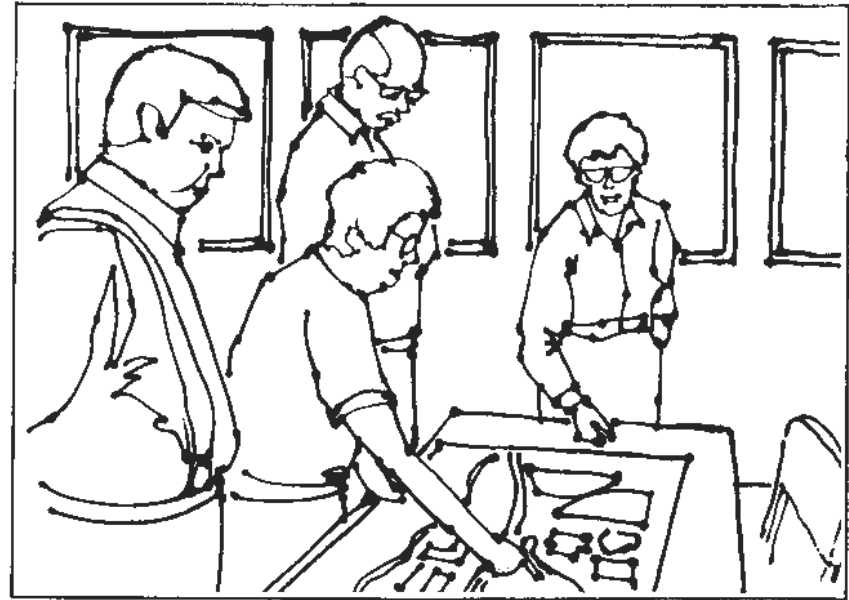

*Public workshops that actively involve members of the community help build consensus.*

## ***A Strategy for Action: Phase One – Visioning***

---

### ■ Comparative Slide Shows

Comparative slide shows are a new technique in community planning designed to help citizens express their ideas more clearly to professional planners and designers. This technique was pioneered by Anton Nelessen, a New Jersey based architect, who has refined the process into what he calls the Visual Preference Survey™. Participants are asked to look at two slides comparing two different ways of designing a building, a street, a sign, a plaza – the full range of elements of the physical environment. The slides are rated according to how attractive or unattractive they are. After many slides and tabulation of the results, the planners can draw conclusions about what people like and dislike. The "likes" are assembled into a report that consists primarily of photographs and illustrations – the first rough images of the community's vision. Such a report becomes a tool for further discussion of community preferences.

### ■ Design Charettes

The *charette* is an intensive workshop in which professional designers, often accompanied by citizens, stakeholders, and public officials, evaluate a variety of approaches to a specific planning problem or design issue. Participants receive a briefing on the area and the project objectives, then teams are formed, and each team independently creates its vision for the area. The teams present their results to each other for review and criticism. Finally, a formal presentation is made to the general public and community leaders. Charettes can be arranged through university architecture departments,

local chapters of the American Institute of Architects or the American Planning Association. A well-run charette will produce drawings, slides, and a booklet of the results.

### ■ Use-Oriented Symposiums

"Use-oriented" symposiums are a way to bring together the experts and stakeholders with an interest in a certain key element of the vision. If, for example, office development will be a large part of the urban center, owners, managers, and users of existing office space in the area can be convened to discuss the issues. The office symposium should include major office developers and even prospective tenants. The agenda should include preliminary concepts and findings, and the format should encourage comment and discussion. The symposium should not only ground first steps in reality, but ignite interest in the urban center concept.

### ■ Developer Interviews

It is never too soon to start talking with major land developers and financiers who will eventually take a major role in the urban center. Developers always appreciate learning of community plans early and having the opportunity to add their expertise. The community will gain by being able to tap into their experience. The one-on-one interview is often the best way to generate interest and discuss ideas with key developers.



## A Strategy for Action: Phase One – Visioning

### ■ Competing Alternatives

In the initial stages of refining the vision, there is no hurry to come up with a single urban center concept. As a basis for discussion, the City should consider presenting two, three, or four easily-understood alternatives that present clear choices – including a look at what is likely to happen if the community opts to stick with the status quo. Alternatives make it easier for the community to respond. Citizens and stakeholders should be asked not only which they prefer, but what they like and dislike about each proposal. With the responses, a "best of each" alternative can be designed.

### Checkpoints and Adjustments

#### ■ Continue to Broaden Community Involvement

A successful visioning process will continually attract new participants. Each phase of visioning offers new issues and challenges that will interest specific segments of the community. When interest is shown, the City should enlist new stakeholders in volunteer committees to work on the various parts of the emerging urban center concept. Probably no better example of this exists than the Seattle Commons. After a central committee of 52 had determined the general parameters of this new urban center concept, nine committees were formed involving over 100 people. Those committees plunged into issues of safety, parks, housing, human services, transportation, the environment, and business development – and became committed "owners" of the Seattle Commons vision.

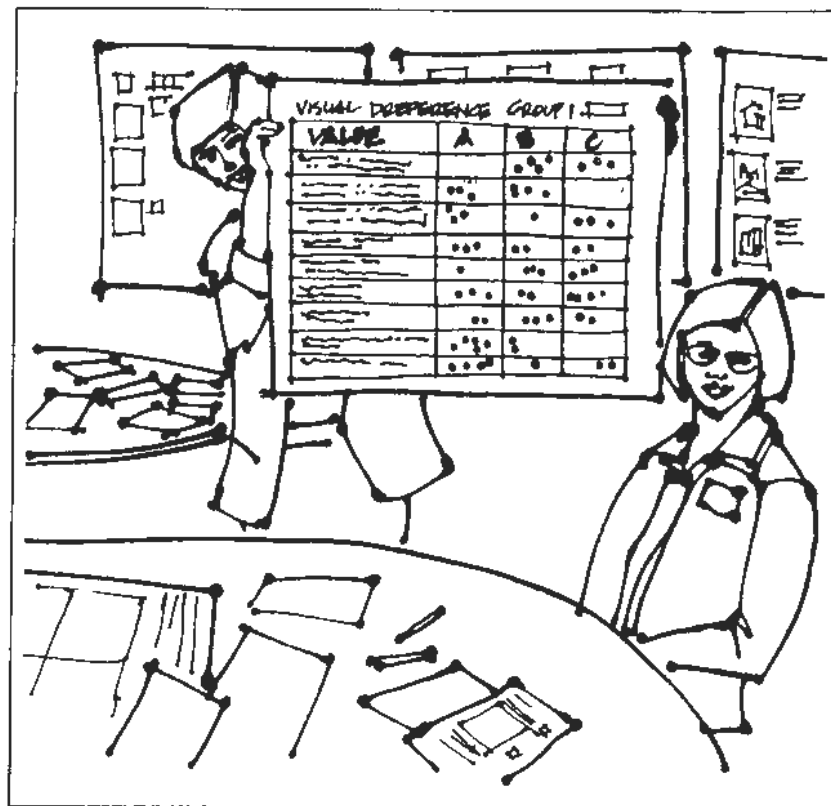

*A comparison of alternatives generates meaningful citizen discussion.*

## A Strategy for Action: Phase One – Visioning

### ■ Establish Milestones

The process of refining and gathering support for the vision never ends. To keep interest and show progress, the City must chart project milestones and renew public participation and interest after each one is reached. The visioning process should result in a draft plan – the first milestone. Two or more revisions, each successively more detailed and spaced to allow community input and participation, might be milestones two and three. The Seattle Commons citizen team presented a draft plan to the community in December 1992, asked for responses from the City and others on what they left out, and promised to answer those concerns in a final plan. Six months later, they released a well thought out, 200 page plan that was supposed to be the final plan, but was called "Draft Two." They had learned the tremendous power of a planning process that remains open to further refinement and participation.

Other key milestones will center around government approvals and legal requirements. These might begin at the local level, involve the regional transit authority (if a transit station is a key part of the plan) and ultimately draw in those who must finance the project, including taxpayers who may have to pass special tax levies. A clearly laid out chart showing all of the project's major milestones is part of sharing the "grand view" with all of the participants.

*Feasibility checks must be continued throughout the planning, organization and development of the urban center.*

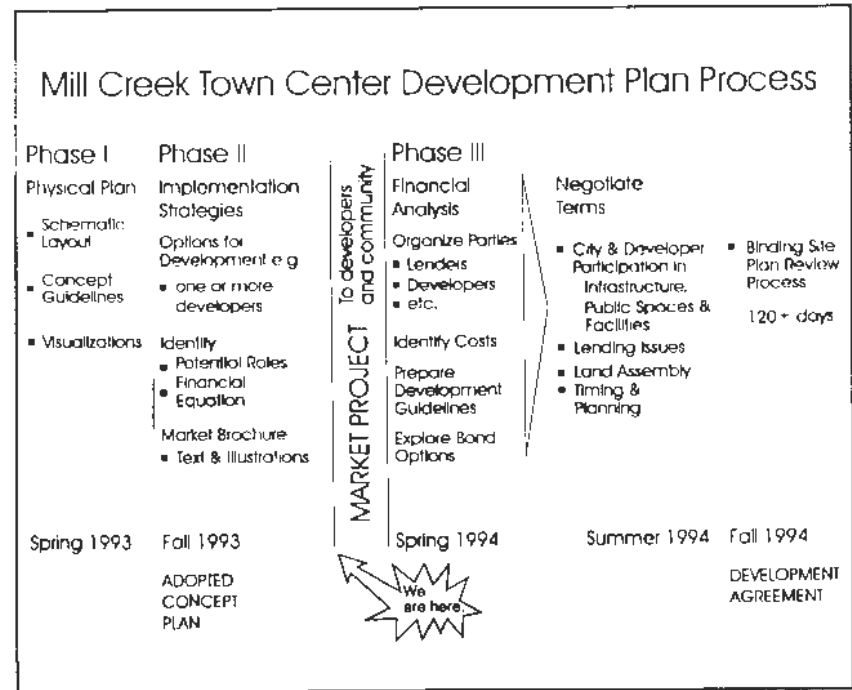

A process chart, like this example from Mill Creek's Town Center Plan, is an important step in publicizing the "milestones" and objectives of the community plan.

## A Strategy for Action: Phase One – Visioning

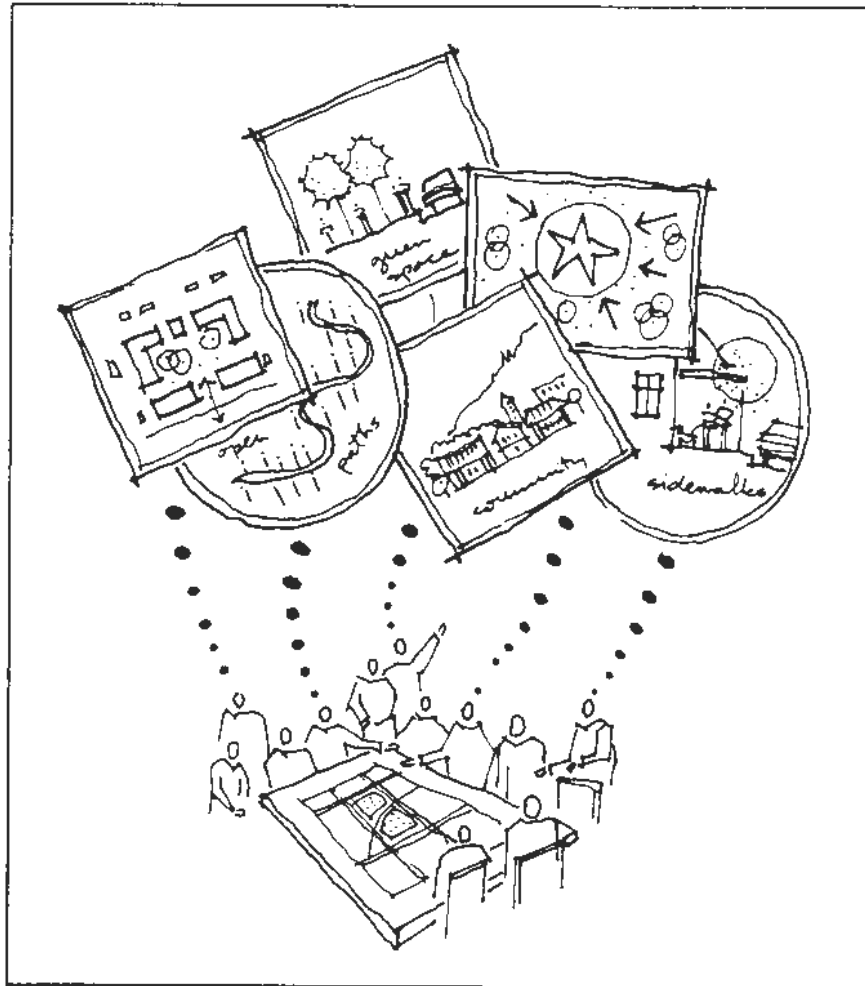

*The community planning process is an exciting and interactive exchange between advisory and planning committees, property owners, merchants, residents, city officials, developers and consultants.*

### ■ Continually monitor conditions and check feasibility

A community must continue to keep its vision grounded in reality. A mix of activities is a basic tenet of urban centers, but what comprises that mix is less certain. Some communities are ideal locations for major retail centers; some are not. Only some are suited to provide regional health care services. If there is not yet a strong office environment, is it desirable or possible to create one in the community? Cities should draw on the same expertise developers use to answer these questions: studies conducted by market research firms. These studies should explain not only how the community can build on its strengths, but what new opportunities will follow from new public and private investment. Over the long term, market conditions will change, regional transportation investments and other opportunities will present themselves, and the vision may have to be modified to take into account new opportunities and constraints. Feasibility checks must be continued through the planning, organization, and development of the urban center.

## A Strategy for Action: Phase Two – Planning

### The Specific Plan: A Model For Urban Center Planning

#### Advantages of Specific Planning:

- Area-wide master plan coordinated by community vision
- Opportunity to plan parks and public spaces
- Efficient planning and budgeting for streets, sewers, drainage and other infrastructure
- Clear criteria for development project design and approval
- Streamlined regulations and permitting procedures
- Area-wide, rather than project-by-project, environmental review
- Integrated design of individual development projects
- Joint public-private financing of infrastructure and amenities
- Readjustment of property boundaries for optimum use of land

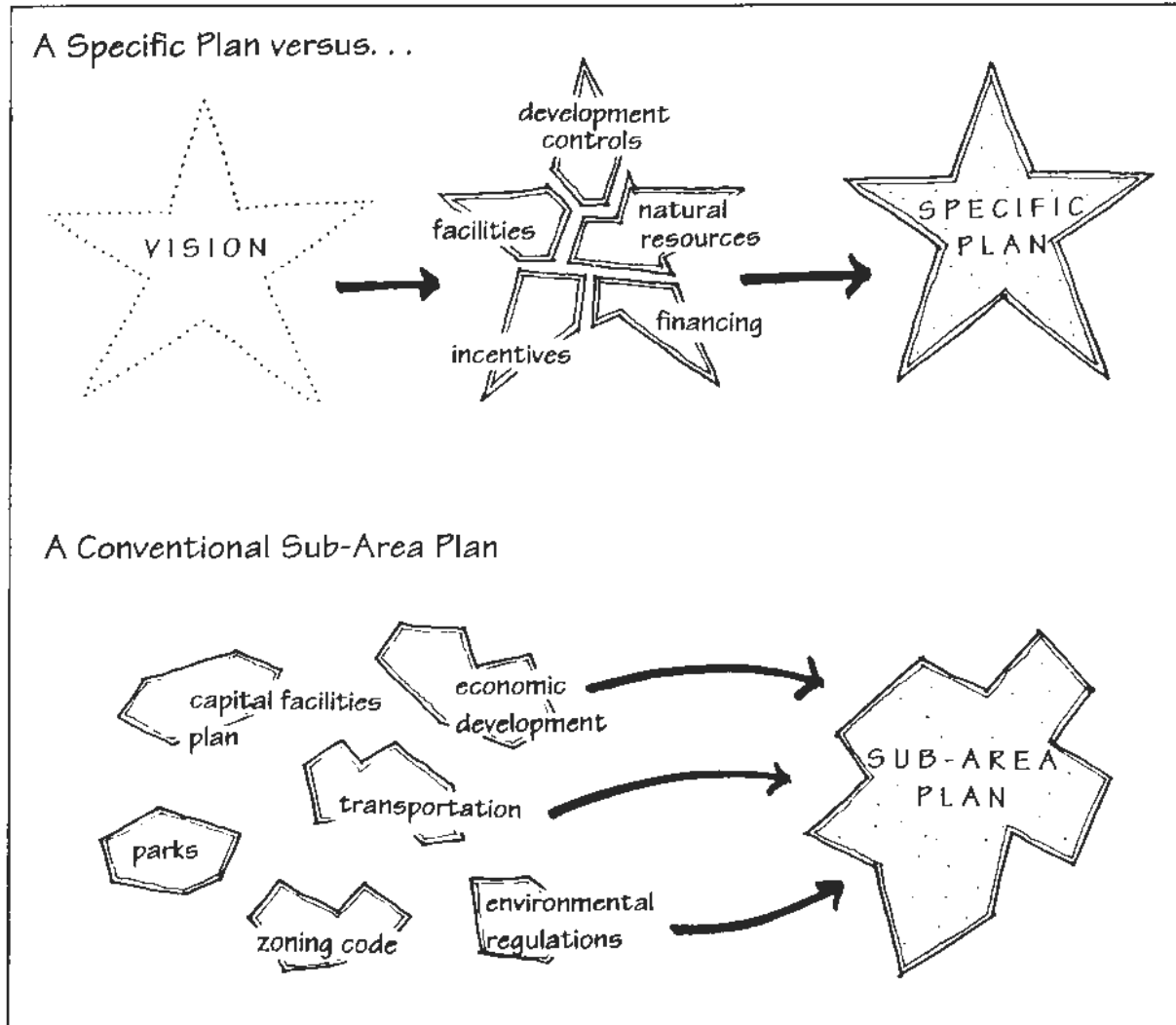

## A Strategy for Action: Phase Two – Planning

**A** comprehensive plan may include, where appropriate, subarea plans, each of which is consistent with the comprehensive plan.

Washington State Growth Management Act,  
RCW 36.70A.080 (2)



### Planning for Development

Once the urban center vision is formed, the community must create a plan for developing it. Planning the urban center may begin by incorporating the vision into the policies and elements of the City's comprehensive plan, and may end with changes to zoning and other land development regulations. But for the community to be truly proactive, the key step lies in between, with the creation of a development-oriented "sub-area plan." Sub-area planning is a recognized extension of comprehensive planning and is practiced in various ways across the country (including in many communities in Washington State). When used proactively, a sub-area plan can be both a blueprint for development and a driving force for realizing the urban center vision.

### The Specific Plan as a Model

A particularly good model for sub-area planning is the "specific plan." Pioneered in California, the specific plan is comprehensive and detailed, and departs from other sub-area plans by its strong orientation toward implementation. California has a long history of and many success stories using specific plans, with applications ranging from strip-commercial redevelopment to creating urban nodes along regional rapid transit lines. For that reason, the specific plan is highlighted here as a good example for urban center sub-area planning.

#### ■ What is a "specific plan"?

First and foremost, a specific plan is a reversal of traditional roles. The local government actively promotes and coordinates the planning of development projects, instead of simply establishing general policies and reacting to private development proposals. Second, the specific plan is a master development plan for multiple parcels of land in both private and public ownership. It treats the sub-area like a single, integrated project, rather than a series of individual projects on separate parcels of land.

The local government, land owners, and developers jointly develop the plan, and it covers all of the sub-area. Often the local government finances the specific plan, then recoups the costs through fees assessed of developers within the specific plan area. In California, specific plans can be initiated by a

## A Strategy for Action: Phase Two – Planning

---

city or county, or by land owners within the sub-area. In planning the urban center of the community, it is important that the local government, as the representative of the entire community, initiate and lead the specific planning effort.

### ■ How does a specific plan fit in with other plans and regulations?

Like any sub-area plan, a specific plan must conform to the comprehensive plan for the community in which it is located. It may be desirable at the outset of specific planning to add policies (based on the urban center vision) to the comprehensive plan. When the specific plan is adopted, it is usually adopted as part of the comprehensive plan.

When the plan is done, the area's zoning, public works standards, subdivision regulations, and design standards must conform to the specific plan. Ideally, the specific plan contains enough detail in all of these areas so that these regulations can be *replaced* by the plan. The plan, in effect, becomes a single, unified development plan and code.

The preparation of a specific plan is accompanied by an environmental report, as required under state law. If the plan and the report are thorough, environmental reports on the individual development projects within the area are waived (saving a great deal of paperwork for center planners, and a great deal of time and money for center developers).

### ■ What does a good specific plan have in it?

- **Land Use** – A specific plan includes a map showing where residential, commercial, industrial, and recreational and other activities will be located. Within a large center, these designations may be general and diagrammatic; within a smaller center the plan will likely show individual buildings and their intended uses. The plan should include standards for how these uses will be arranged and built (much like the zoning code it will replace). These standards must be firmly based in the community vision and sound urban planning principles.
- **Design Guidelines** – The plan should contain standards of design for buildings, streets, landscaping, and public spaces. These standards should reflect the images derived from the urban center visioning process. The most effective design guidelines are highly graphic, using drawings and photos to show desired effects.
- **Public Facilities** – The plan should map and describe existing and planned public facilities, including:
  - Transportation;
  - Sewage;
  - Water;
  - Drainage;
  - Solid waste disposal;
  - Energy; and
  - Public parks and open space.

## A Strategy for Action: Phase Two – Planning

- **Environmental Protection** – Key environmental resources within and nearby the center should be shown, and a program for conserving, developing, and using these resources included. Often, key resources and their significance to the community will be identified in the visioning process.
- **An implementation program** – The success of the plan will hinge on a sound program with standards and criteria by which development will proceed. This section should include:
  - Land use regulations;
  - Preconditions for and sequencing of development;
  - A capital improvement plan with a public investment timetable; and
  - Financing, including the cost of publicly and privately provided infrastructure and the program for paying for it.

### **How Specific Plans Promote Urban Center Development**

Specific planning not only lays out a clear path to realizing the urban center vision, but assures that the community, land owners, and developers all benefit from urban center development. In doing so, the specific plan harnesses market forces alongside the energies of each of these groups to move the urban center concept toward implementation.

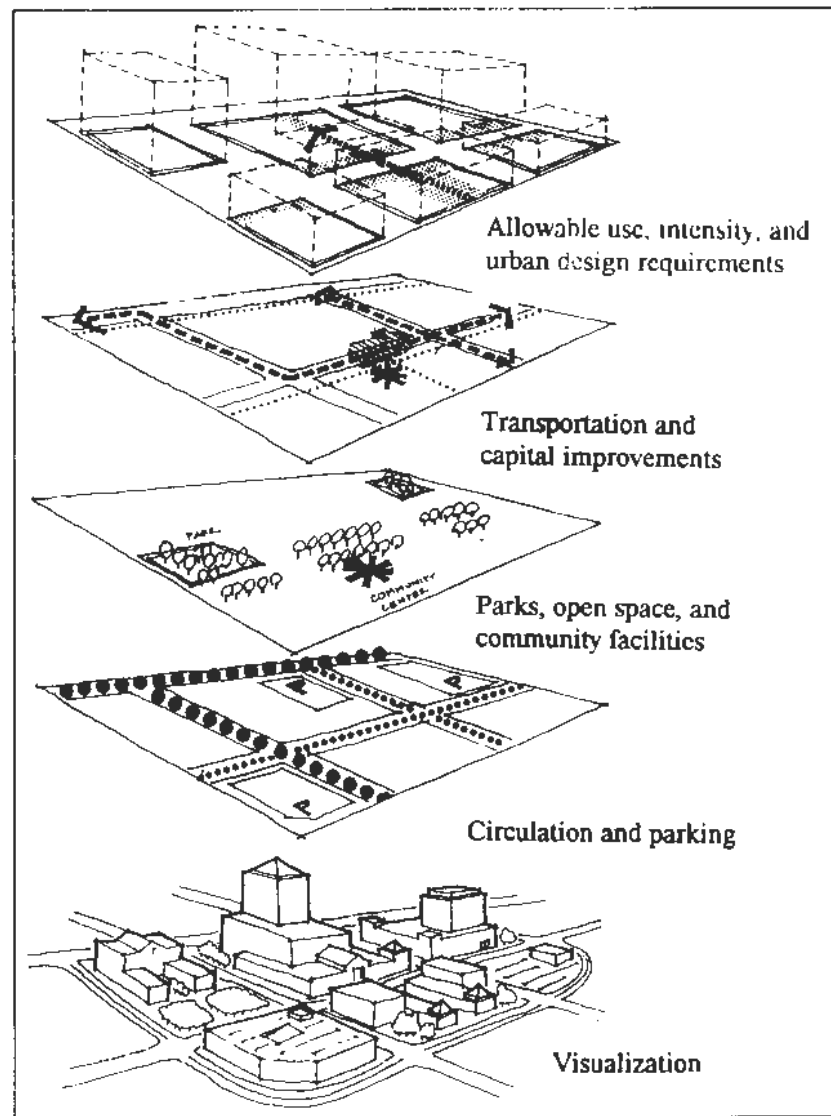

The "Layers" of a Specific Plan

## A Strategy for Action: Phase Two – Planning

### ■ Community Benefits from Specific Planning

Area-wide planning coordinated by a community vision results in a project reflecting community values and needs. With a sound plan, the community has an opportunity to gain public amenities such as beautiful streets, parks, and public spaces, and to protect environmental resources. The local government can more rationally plan infrastructure such as streets and sewers. The certainty and predictability of the specific plan helps the local government to plan and budget efficiently, and new development adds to the local tax base.

### ■ Developer Benefits

A specific plan gives developers a clear indication of community desires, which helps them design projects that will gain easy approval. The specific plan reduces a maze of regulations and permit procedures into a single, streamlined approval process. The specific plan also tells the developer specifically what development to expect adjacent to his or her project, making it easier to plan projects that fit well together.

Through area-wide planning of roads, drainage, sewers and other facilities, the specific plan allows developers to share the costs of these facilities jointly, predictably, and efficiently with each other and with public agencies. Those developers who build first can be reimbursed for building roads and other improvements that will be used by later developers. Also financing can be developed with greater public assistance, such as tax exempt financing and assessment districts. In the Evergreen Specific Plan, for an area near San Jose, California, 31 owners of 41 undeveloped parcels were able to jointly build a road that was needed before any of them could develop their land, but which was beyond the means of any single land owner.

*A specific plan gives developers a clear indication of community desires, which helps them design projects that will gain easy approval.*

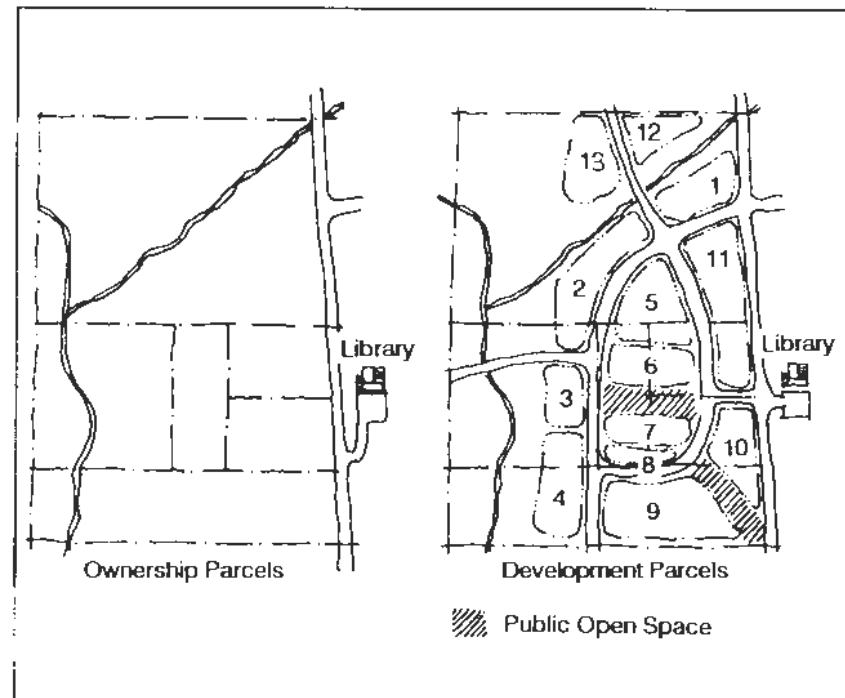

*Historic land divisions are reassembled into shapes and sizes conducive to urban developments.*



## ***A Strategy for Action: Phase Two – Planning***

### ■ Property-Owner Benefits

Finally, specific planning is an opportunity to reassemble pieces of property, which have been subdivided over the years, into parcels of shapes and sizes that get the optimum use for the property owner, as well as for the community and the developer.

Specific planning shares many similarities with another land development tool used in other countries, but rarely in the U.S., called "land readjustment."<sup>2</sup> Land readjustment assumes from the outset that old property boundaries will be eliminated. New streets and parks may mean that the reassembled land has less developable area overall, but eventually all the land owners will share in the proceeds of the new development (each according to their percentage of the land area prior to readjustment). Such collaboration is possible where it is clear that each land owner will gain value by the readjustment process.

---

<sup>2</sup>Schnidman, Frank. "Land Readjustment," *Urban Land*, February 1988; p. 2f. See also Letter to the Editor, *Urban Land*, June 1992, p. 5.

*The combination of specific community-based planning, strong station/facilities design and joint public/private development puts powerful forces to work behind the new center vision.*

### ***Transit and Specific Development Planning***

Specific development plans have been particularly effective in planning urban centers around regional rapid transit stations. The combination of a specific, community-based plan for a station area, a new transit station, and joint development with the regional transit authority and private developers puts powerful forces to work behind the new center vision.

In 1992, Portland, Oregon began using specific development planning as part of its "Livable City" program.<sup>3</sup> Although the program is not limited to areas served by rapid transit, the first site chosen was the Hollywood light rail transit station area. Urban centers developing around metropolitan Wash-

---

<sup>3</sup>Bureau of Planning, City of Portland, OR. "What is a Specific Development Envisioned under the Livable City Project?," September 1992, Informational Sheet.

## ***A Strategy for Action: Phase Two – Planning***

ington, D.C. rail stations also use variations of specific development planning. Arlington County, Virginia employs "Sector Plans."<sup>4</sup> and Montgomery County, Maryland uses "Transportation Development District Zoning."

In the Puget Sound Region, the Regional Transit Authority (RTA), created in 1993, is required by State law to link its rapid transit investments to sound urban center planning around stations. The RTA will likely help fund local specific planning in communities with sound urban center visions.

### ***Public Participation in Specific Planning***

The specific planning process is a good time to start bringing together public and private parties who will be key players in building the center. Many may already have participated in the visioning process. In addition to aligning its own departments around the plan, the local government should encourage the formation of a group representing land owners and businesses in the area. The plan will have a direct and critical impact on their interests, and they need to remain

fully involved and organized throughout the specific planning process. There may be some resistance to the planning effort; however, if the visioning process was successful, public officials should have a substantial amount of public support and momentum backing them up.

Specific Plans bring together all the elements required to realize a community vision through a process that aligns the community's interests with the interests of property owners and developers in the area. Once such a plan is created, all that remains is to get organized and to begin carrying it out.

*Once a specific plan is created, what remains is to get organized and begin carrying it out.*

---

<sup>4</sup>The Ballston Sector Plan covers 270 acres in 39 blocks. At its heart is a "coordinated mixed-use development district" that allows maximum office FAR's of 3.5, 135 residential units per acre and 210 units per acre for hotels. Up to .25 additional FAR was available for public plaza dedications.

## A Strategy for Action: Phase Three – Organizing



### Organizing for Development

Building and redeveloping urban centers will require a strong, cohesive organization that gets many levels of government working alongside the private sector. Organizing will begin during visioning and planning, and this organization will become the bridge to actual development of the urban center. This section highlights important considerations in organizing for large-scale, publicly guided development.

### Assembling and Managing a Team

Success in envisioning, planning, organizing, and developing an urban center will require the teamwork of a variety of "movers-and-shakers." It is up to local public officials to assemble a solid team of professional planners and designers, enthusiastic developers, and community boosters, as well as organize and coordinate the various government agencies that will be involved.

#### ■ Start building the team from within.

An urban center project will succeed only if public officials can "see" and effectively promote the vision. Planners and managers in the local government must be able to sell the vision to private developers and to other government agencies. Puget Sound communities can draw experienced people from places that have stronger redevelopment traditions than the Northwest. The community interested in developing an urban center will need a planning staff well-versed in urban design and in land development tools, and will need to commit its top staff to the effort.

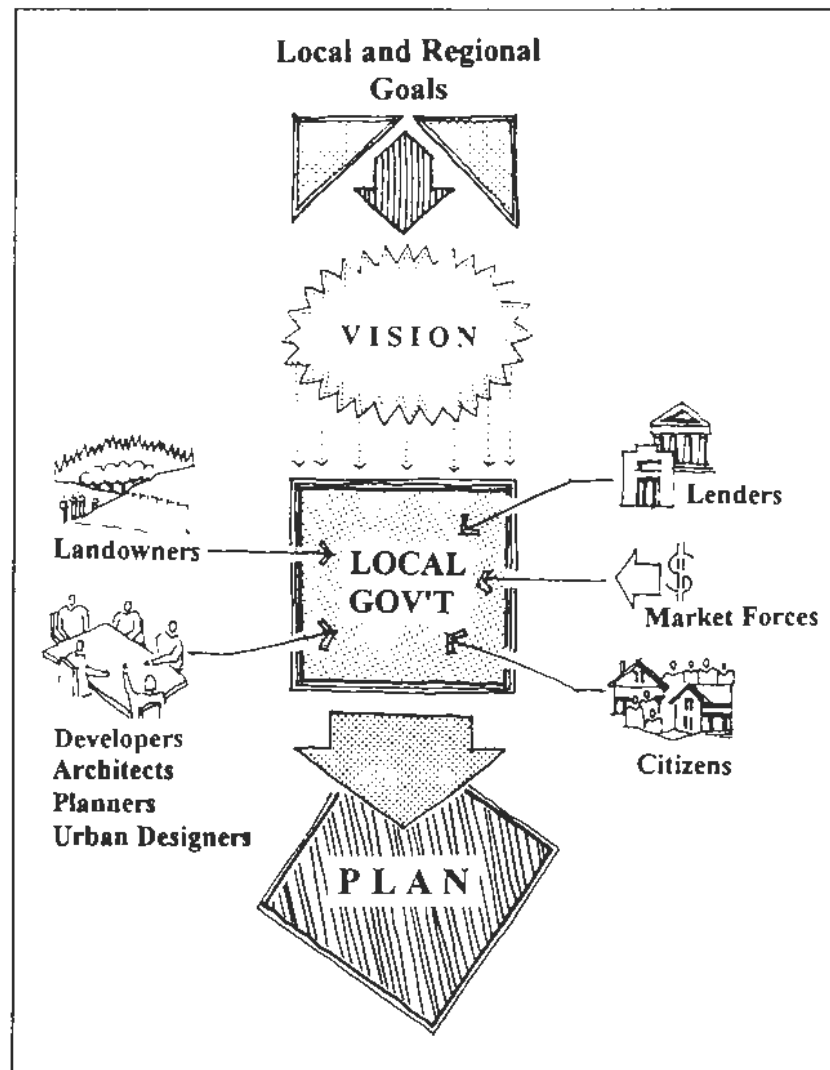

*Local government must assemble and manage a team of experienced and enthusiastic players.*

## A Strategy for Action: Phase Three – Organizing

### ■ Match key skills to key tasks.

Each phase of planning and development requires particular skills, so teams must be formed and changed to fit the task at hand. The visioning team must have top notch urban designers, graphic artists, feasibility analysts, and meeting facilitators. Sub-area planning requires urban planners, engineers, finance experts, and writers. Organizing and developing will hinge on planners, developers, architects, engineers, and bankers. Effort put into finding good team members will pay off with a smooth-working organization.

### ■ Encourage self-selected teams.

No amount of legally binding contracts will substitute for a good development team and players that work well together. To create teams that work well together, requests that consultants for each phase of the project come as a "package deal," including experts in all areas needed to round out the team. In visioning, for example, let the urban designers and planners pick the communications expert for the team (or vice-versa). Similarly, the key developer must choose its architect partner.

### ■ Create a chain reaction.

The experience and momentum from one stage should be used to frame the work plan for the next stage. For example, the visioning team might write the scope of work for specific planning and help select the planning team.

### ■ Choose a team to fit the community and the vision.

A large, ambitious urban center vision is likely to attract more capable and experienced development partners (and ideally developers who are more willing to try innovative town center concepts). So, for larger projects the organizing and development team takes on greater importance. Smaller urban center plans will likely attract less experienced, local developers. In this case, a well-established and documented community vision is crucial, backed up by a sound development plan.

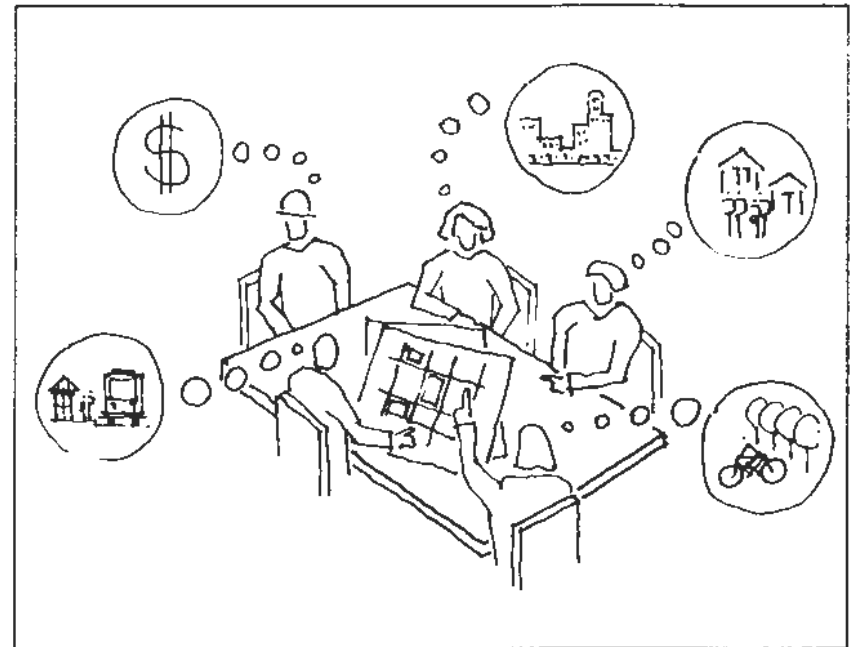

Success in large scale development projects hinge on a team of experienced professionals working toward key deals.

## ***A Strategy for Action: Phase Three – Organizing***

---

### ■ *Find experienced development partners.*

Suburban redevelopment, like the downtown revitalization of the '70s and '80s, may hinge on a single flagship project developed by an experienced private developer working closely with local officials. To such a partnership, public officials bring local knowledge, public resources, and the ability to facilitate permits and approvals. The private partner brings experience assembling a development team, a sound perspective on the market and project feasibility, the ability to finance certain up-front costs, contacts with lenders and eventual tenants of the project, and an attitude that makes things happen. The time for a city to seek a private partner is near the end of the visioning stage, when the community has expressed its desires but firm plans have not yet been made. While cities and counties must use competitive bidding in selecting private partners, this does not prevent officials from seeking advice from community-minded developers early in the urban center process.

*No amount of legally binding contracts will substitute for a good development team and players that work well together.*

### ***Getting the House in Order***

Large scale public development requires that a local government set out clear objectives and speak with one voice.

#### ■ **Intra-Agency Agreement**

The City should pass legislation or an executive order that spells out project objectives, staff responsibilities, project organization, and clear procedures for planning and developing the new town center. Such an agreement would be helpful during visioning and specific planning, and becomes crucial when organizing for urban center development.

#### ■ **Project Management**

It is important that a single project manager be designated and be given a clear mandate to move planning and development forward. This person may be a city department head who leads the larger town center team made up of other department heads. When internal differences arise, the project manager should be in charge of arriving at a mutually agreeable solution. Key decisions that cannot be resolved by adopted plans or policy should go to the city executive or to the city council.

## A Strategy for Action: Phase Three – Organizing

---

### **Regional and Interlocal Organization**

The success of a local urban center vision is important not only to the local community, but to the region as a whole. A city can enlist the regional council of governments, regional transportation authorities, and regional or countywide development authorities as partners in the urban center organization. The local government should be proactive in organizing these players. If a major transit facility is involved, the local government should seek a strong partnership with the transit agency that serves both regional transit objectives and the local urban center vision.

#### ■ Alliances with Other Governments

Regional and local "special purpose" governments can become key allies. Regional transit authorities in particular have helped build urban center projects throughout the country. The Puget Sound's Regional Transit Authority has a strong state mandate to link future transit investments to the development of urban centers. School boards, especially college districts, are also major players in community development. A high school or college located on the suburban fringe compounds the problem of haphazard development; but these facilities can add vitality and identity to an urban center. Utility companies, also major players in community development, must be key partners in center planning and development.

#### ■ Interlocal Agreements

A regional organization can be built around an *interlocal agreement* that spells out the roles and responsibilities of each agency. When a major transit facility is involved, the interlocal agreement will likely be developed in conjunction with regional transit planning. (Often, regional transit planning occurs before a community has given much thought to a new town center, in which case an interlocal agreement may precede the visioning and planning stages. In negotiating such an agreement, local jurisdictions should seek financing from the regional transit agency for visioning and planning, but should avoid giving away control of the process.) An interlocal agreement should address these issues:

- Which public agencies will participate in the planning of the town center, and what will be the role of each?
- If a major transit facility is involved, who will conduct the development or redevelopment around it?
- What new agencies will be created to carry out center development, and who will be represented in them?
- What land use controls and incentives will be used and who sets and controls them?
- How will environmental assessments and mitigation be handled?
- How will access to and from transit facilities be planned and implemented?
- What center amenities, such as parks and parking, will be local, which will be deemed regional, and how does that affect their development and financing?

## A Strategy for Action: Phase Three – Organizing

- Who will conduct the public involvement process?
- How will revenues from the project be distributed?
- If the agreement is made at the outset of visioning and planning, how will rights-of-way and development sites be preserved while the planning takes place?
- How will disputes be resolved?

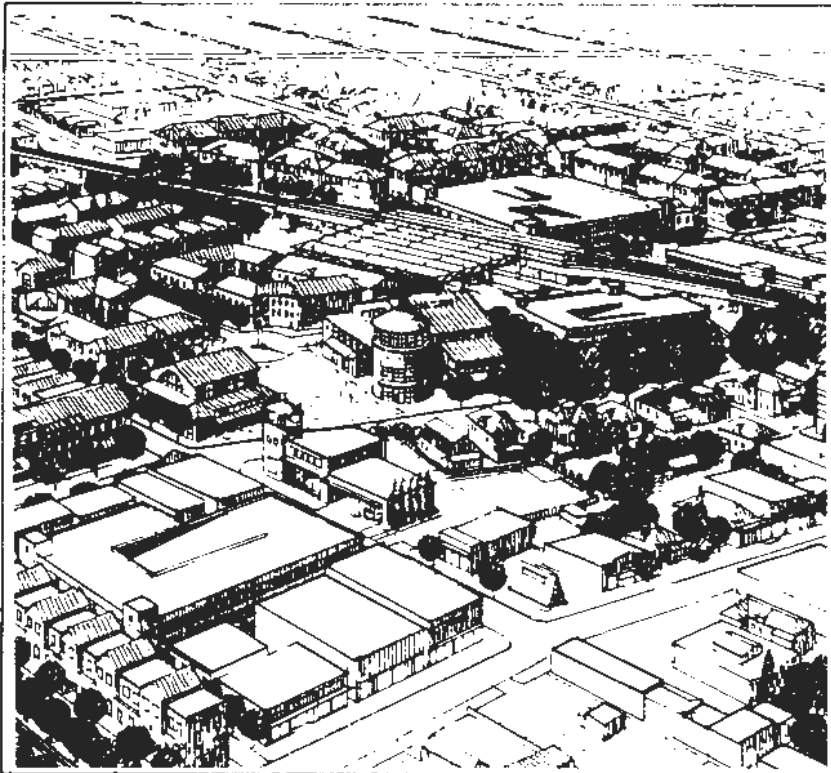

Hayward, California's Downtown Plan includes a land swap between the City and Bay Area Rapid Transit (BART) in order to build a new city hall and library adjacent to the transit station. (Source: *Rebuilding*, Solomon, D.)

*A Public Development Authority has the financial resources needed to catalyze large-scale, innovative development and can become a key partner in the local urban center.*

### **Working with Public Development Authorities**

Most successful urban center development or redevelopment taking place today is being done through a public development authority of some kind. These authorities have the financial resources needed to catalyze large-scale, innovative development and can become key partners in the local urban center.

#### ■ Regional Transit Authorities

In many parts of the country where large scale rapid transit systems are being built, the regional transit authority, in addition to building the transportation infrastructure, acts as the prime developer of land around some stations. The authority conducts a bid competition to choose a private partner for joint development, and typically assembles the land for long-term lease to the developer. For the community with a strong vision and a sound specific plan (developed with the help of developers and transit planners), this type of partnership can

## A Strategy for Action: Phase Three – Organizing

literally be a formula for making "the dream" come true. A well-crafted interlocal agreement between the regional and local governments helps assure that the two work well together.

### ■ Redevelopment Authorities

In many states, redevelopment authorities or commissions are set up with broad responsibilities to ensure development or redevelopment of land in specific areas. The Portland Development Commission operates throughout the City of Portland, Oregon. The Contra Costa County Redevelopment Agency serves all of its California county. In these and other areas, the redevelopment agency takes responsibility for station area redevelopment. These agencies can target a specific area and channel public investment into it in various ways. Usually they have the advantage of *eminent domain* powers that allow them to assemble land. Or, alternatively, they develop land assembled by the transportation authority.

Washington State does not have a tradition of city-wide or county-wide redevelopment authorities. Unlike most states, Washington has never permitted its redevelopment authorities to exercise eminent domain power directly, and, tax increment financing, which is a common and powerful tool used by development authorities in other states, is still not employed in Washington State (see Appendix A). Current practice notwithstanding, local governments should carefully consider whether a public redevelopment authority for urban center development is appropriate.



A public development authority preserves and operates Seattle's Pike Place Market. (Sketch by Victor Steinbrueck from his *Market Sketchbook*.)

### ■ Public Corporations, or Public Development Authorities

In Washington, the most common way of organizing for public development in a specific area is the "public corporation," also known as a "public development authority" (PDA)<sup>5</sup>. State law does not limit the area served by a PDA to the city or county that established it. By agreement with other juris-

<sup>5</sup> RCW, Chapter 35.21.



## ***A Strategy for Action: Phase Three – Organizing***

dictions, a PDA can expand and cross city boundaries. PDAs are now being used to redevelop areas ranging in scale from a small city center to a major urban activity center. In Seattle, public development authorities oversee the preservation and operation of the Pike Place Market, build and rehabilitate low-income housing in the Central District, help finance community development in the International District, operate the City-owned Pacific Medical Center, and more.

Cities, towns and counties may establish public corporations and may give them all the powers of a city or town except the powers of eminent domain and levying taxes or special assessments. Like regular corporations, a PDA's debts and liabilities are its own, not the city's. As quasi-governments, PDAs can obtain their own tax exempt financing. They do not pay taxes on low-income housing or property with historic value. They do, however, pay taxes on other properties, equal to what a private land owner would pay.

Public corporations can be strong organizing tools for local urban center development, and a city with an urban center vision should seriously consider creating a PDA. A PDA can give the community new flexibility to invest in the development of its vision. A strong alliance between the City, with its powers of eminent domain, taxing, special assessment, and land use regulation, and a PDA and its ability to borrow and loan money, purchase and lease land, and take advantage of tax exemptions, can be the core of an urban center development organization. An urban center PDA sends a clear signal that the community intends to carry through with its vision. It sets up a central contact point for other public and private

development partners. With good staff and close ties to local officials, a PDA can be the moving force behind urban center development.

### ■ Urban Renewal Agencies

Washington State law has an urban renewal law<sup>6</sup> dating from the federal urban renewal programs of the '50s, '60s and '70s that allows for the creation of local urban renewal agencies to alleviate blight. A liberal interpretation of clauses in the section's definition of blight would find the section applicable for the redevelopment of obsolete suburban commercial development. However, public corporations have all the powers of an urban renewal agency and are the preferred vehicle today for urban redevelopment. Seattle's Pike Place Market PDA was created from an urban renewal agency.

*A joint development agreement typically requires a greater contribution from the public side, with the agreement hinging on the public and private sectors each performing on schedule.*

---

<sup>6</sup> RCW, Chapter 35.81.

## A Strategy for Action: Phase Three – Organizing

### ■ Local Improvement Districts

Washington State allows Local Improvement Districts (LIDs)<sup>7</sup> to be set up by cities to pay for a wide range of public improvements. An LID can be created by either the city or a special district, or by the property owners in the project area. A special property tax assessment is levied in the LID to pay off bonds used to buy, build, maintain or repair improvements such as public streets, alleys, public places, squares, parks, sidewalks, curbing and crosswalks, street lighting systems and off-street parking facilities.

LIDs are desirable if the improvements will increase business to area businesses or raise property values. That increased value becomes the basis for the assessment. Assessments are determined by the proportional benefit each property owner can expect. The closer a person's property is to the improvements, the higher their tax rate.

LIDs have been used effectively in many Washington communities. The Kent Downtown improvements project was used to create a unified downtown image and promote the area as a shopping destination. It included walkways, landscaping, special paving, awnings, open spaces, a bandstand and a "public gathering area."

---

<sup>7</sup> RCW, Chapter 35.43.

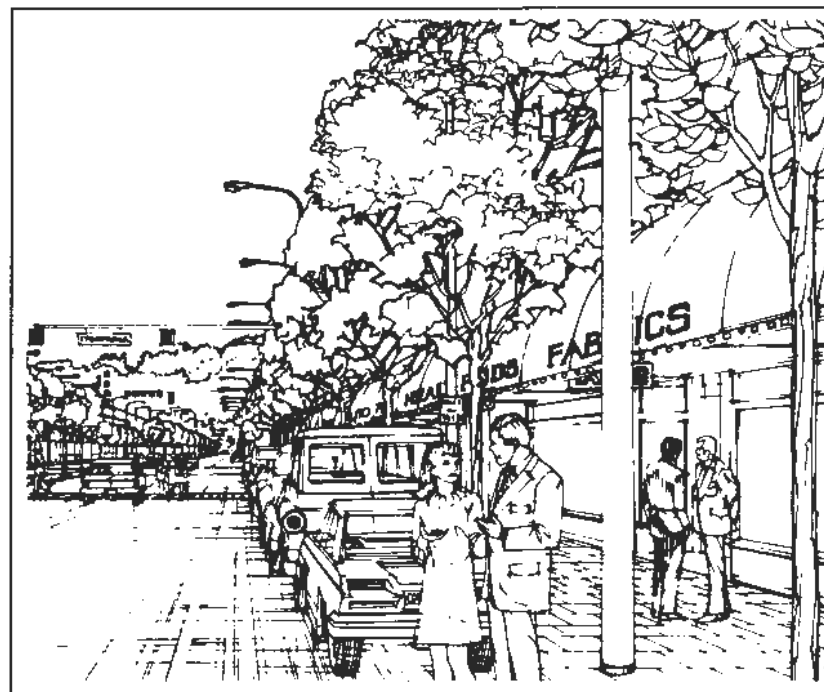

*An LID was used to add urban amenities along Lake City Way in north Seattle.*

### ■ Summary on Organizing

In summary, a city with an urban center vision needs to organize itself, form regional alliances, and put in place an institution with the power to invest in developing the urban center. Each step toward a solid organization sends a signal to potential public and private partners that the community is serious about building its urban center. Not only does organization fuel the momentum of positive change, it prepares a community to shape the development that will follow.

## A Strategy for Action: Phase Four – Implementing



### **Publicly Guided Development**

With a vision in place, a sound development plan taking shape, and a strong organization emerging, the local government must begin to guide and participate in the actual building of the urban center. Publicly guided development means using the full range of regulatory and corporate powers at the city's disposal to make the community vision take shape on the ground. These powers include legal controls over where and how private development takes place, the use of public funds to directly invest in key elements of the urban center, and the ability to attract and facilitate development projects that benefit both the community and its development industry partners. The right combination of regulatory controls, public investment, and development facilitation will spark and guide the growth of the urban center.

*The right combination of regulatory controls, public investment and development facilitation will spark and guide the growth of the urban center.*

### **Development Incentives and Controls**

A change from an auto-oriented environment to a new, pedestrian-oriented urban center will require innovative use of land use regulations. Whether the main regulatory tool is a specific plan, a transit overlay zone, or the more traditional series of individual zoning districts, the success of the urban center will depend on the city's ability to go beyond simply stating what activities will or will not be allowed. Urban center development regulation must emphasize mixed use, pedestrian-oriented development, public open space and consistent, high quality design. Land use regulations in the urban center must be designed around sound urban planning principles, and they must use incentives that promote development consistent with the urban center vision.

#### ■ **Development Incentives**

In exchange for public amenities and quality design that furthers the urban center plan, developers can be allowed:

- Density bonuses that give more usable floor area;
- Lower parking requirements;
- Greater flexibility in site design;
- Additional building heights;
- Streamlined permitting;
- Lower fees and mitigation assessments;
- The ability to buy and sell development rights; and
- Connections with public projects and transportation facilities.

## ***A Strategy for Action: Phase Four – Implementing***

---

### ■ Public Benefits

Incentives and regulatory requirements should be geared to gaining public benefits such as:

- Public plazas and open space;
- Retail shops on the ground level of buildings;
- A variety of housing for various income levels;
- Walkways and access easements;
- Day care or space for social services;
- Community review of architectural design;
- Consistent, pedestrian-scaled streets and pedestrian amenities;
- Reduced parking, and placement of parking behind or within buildings; and
- Multi-story buildings compatible in bulk and scale.

### ■ Development Agreements

As land regulation becomes more complex, trade-offs between development incentives and public benefits must be legally recorded in a way that assures each party follows through. *Development agreements* are an important tool for locking in the benefits of innovative land use regulation. Often recorded as a covenant, or an agreement that binds each successive owner of the land, development agreements ensure that the terms for development are clear and are followed.

### ■ Public Investment

A city can lead the way toward a successful urban center by investing directly in the center's development. Public resources can be used in the following ways:

- Building new roads and improving old ones;
- Adding sidewalks where needed;
- Building public parks and plazas;
- Locating city offices in the center, especially those that provide direct public services;
- Adding pedestrian amenities such as street lighting, sitting areas, street art, and landscaping;
- Building police and fire substations;
- Helping to build needed sewer, drainage, and other infrastructure capacity; and
- Working with the transit agency to site a transit center or station.

## ***A Strategy for Action: Phase Four – Implementing***

---

### ***Development Assistance and Facilitation***

A city can promote and facilitate the development of its urban center by forming partnerships with private developers. These partnerships often involve public land assembly for private development as well as agreements between the city and private developers that ensure the community greater control over the development of its center.

#### **Land Assembly**

Buying land for redevelopment gives a city many avenues for development partnerships. Publicly owned land within the urban center area can be used in the following ways:

- Sites for new public infrastructure or amenities;
- Reconfiguration into larger parcels or new blocks more conducive to redevelopment;
- Resale to private developers, with a development agreement that gives more public control over the project;
- Resale at higher prices, recapturing a portion of publicly created value (proceeds can subsidize low-income housing, other economic development projects, or pay for the community's administrative costs); and
- "Land banking" of selected parcels needed for future projects, but which will be too expensive later due to the land speculation during the development process.

Cities or redevelopment authorities can purchase property on the open market, or they can acquire it with powers of eminent domain. Public agencies have the advantage of lower, tax exempt financing rates and exemption from property taxation while land is held for redevelopment.

*A city can promote and facilitate the development of its urban center by forming partnerships with private developers.*

## A Strategy for Action: Phase Four – Implementing

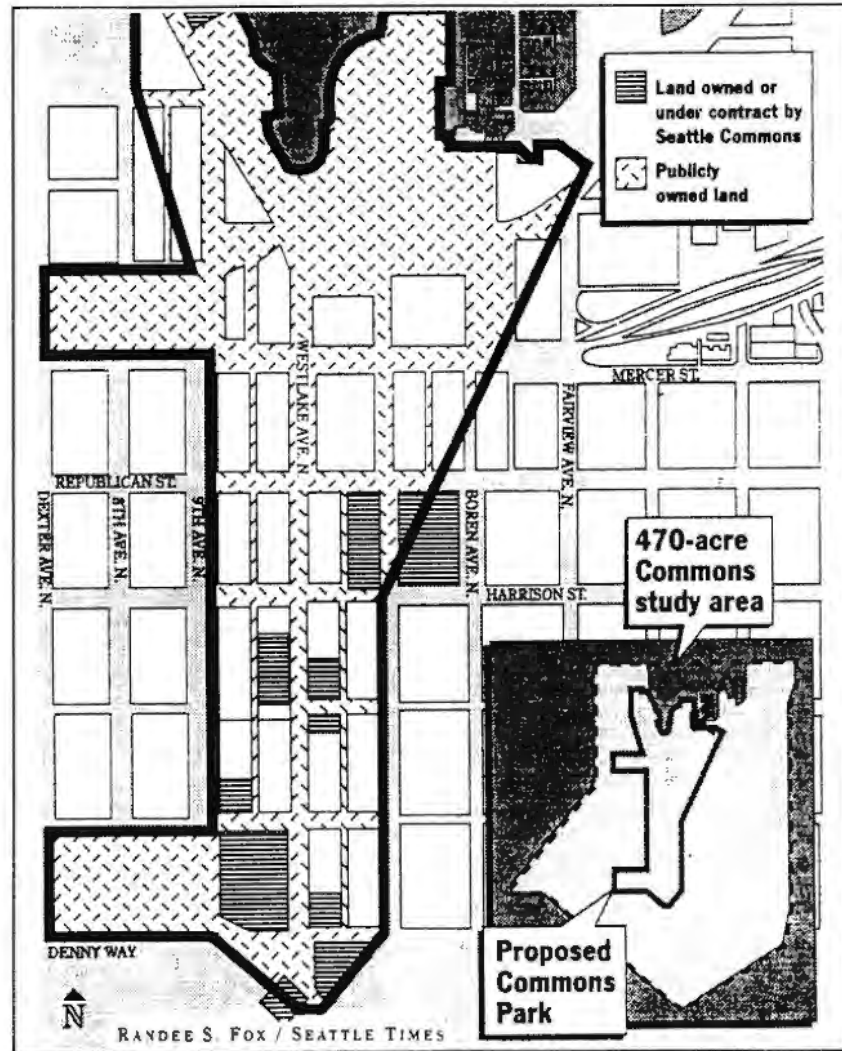

The Seattle Commons Committee is beginning to assemble land for a new city park – a crucial first step in the realization of the vision. (Source: *Seattle Times*, 1993.)

### ■ Development Agreements

As with public land regulation, public land assembly and redevelopment can be effectively managed using development agreements. Land is acquired by a public agency, then upon its resale to a private developer, a development agreement ensures its use to further urban center development objectives. The developer wins the right to purchase the property by promising, through a bid process, to purchase the land at a certain price and develop it to specific standards. The development agreement holds the developer to the promise. Occasionally, development agreements are used in lieu of taking private land through the power of eminent domain. In this case, an owner agrees to develop his or her land in accordance with a specific development plan within a certain time period.

Land assembly, especially when eminent domain is used, is a powerful tool that must be exercised with caution. Urban renewal, as practiced in the '50s, '60s and '70s often tore out whole blocks in low-income neighborhoods, then failed to bring new development and left these areas languishing for years. A cautious approach would first attempt redevelopment without extensive public land purchases, followed by a public purchase program if the former approach does not succeed. Contra Costa County, California, redeveloped the community of Pleasant Hill in this manner (see Appendix C). Only after an upzone and construction of a new BART station failed to induce a few, hold-out small land holders to sell to private developers did the county redevelopment agency begin purchasing lots under threat of eminent domain.

## ***A Strategy for Action: Phase Four – Implementing***

*A joint development agreement typically requires a greater contribution from the public side, with the agreement hinging on the public and private sectors each performing on schedule.*

### ■ Joint Development Agreements

Joint development agreements are one of the most important legal underpinnings of a redevelopment effort. Whereas regular development agreements ensure private development in accordance with a specific development plan, joint development agreements specify how public and private developers will each contribute to the development of strategic projects designed to anchor the success of the entire subarea. A joint development agreement typically requires a greater contribution from the public side, and the agreement hinges on the public and private sectors each performing on schedule. Joint development projects are often located next to or connected to a public facility, such as a transit station. The land or air rights the private developer uses may be leased from a public agency. Joint development agreements often involve

some sort of public support critical to the project, such as a public parking facility that satisfies the parking needs of the private development, but which would make the private development project economically infeasible if it had to bear the cost.

### ***Selecting a Private Development Partner***

The private partner in a joint development may be predetermined if there is an existing major private development or institution already located within the urban center. Where land is vacant or existing improvements will be torn down, the private joint development partner is selected through a competitive public bidding process. The following is an outline of this process, as used by the Washington (D.C.) Area Metropolitan Transit Authority, for selecting joint development partners:

1. **Prepare a prospectus** and review it with city officials;
2. **Issue the prospectus** by advertising and mailing it to interested parties;
3. **Hold a pre-proposal conference**, 30-60 days after issuing the prospectus. (This is an open meeting where potential joint development partners can learn more about the project);
4. **Hold private meetings** with prospective partners up until proposals are due;
5. **Receive proposals** within 90-120 days after prospectus is issued; and

## ***A Strategy for Action: Phase Four – Implementing***

---

6. Review proposals, using a Contractor Evaluation Board, in two stages:
  - a. First stage for sufficiency of application
  - b. Second for substance and final determination of winning proposal.

### ■ Evaluation Criteria

Bids for potential joint development partners are evaluated based on the following criteria:

- Conformance to the development plan;
- Value of air rights, rental income, etc., the agency will gain;
- How many new transit riders the proposal will bring;
- Excellence of design and fit with transit system; and
- Attainment of affirmative hiring goals.

### ***Development Phasing***

Whatever techniques are used to regulate development and build partnerships, it is crucial that development be guided by a strategic phasing plan. A logical order to public and private investment is key to making the site attractive to development and to building efficiently. Needed public infrastructure, such as streets and storm drains, and development attractors such as new public transit facilities and joint development projects should be set in motion first. If the area is large, subareas for development planning and phasing may be needed. A sound phasing strategy is to develop concentricity outwards from key projects.

### ***A Note on Not Shooting Yourself in the Foot***

This chapter focuses on a positive strategy for developing an urban center. However, the success of this process will depend in part on controlling development elsewhere in the community and on its fringes. There is only so much development potential in an area, and while another large strip mall along a main arterial or a giant home center on cheap land at the city edge represent easy additions to the local tax base, these projects may siphon off retail development crucial to the success of the urban center. A sound urban center development strategy includes a sound community plan and the will to resist rezonings and other actions that will undermine the urban center vision.

*A sound urban center development strategy includes a sound community plan which will resist rezonings and other actions that undermine the urban center vision.*



## Conclusion

### Community Building

There is little public work so important as establishing a place that serves as a true urban center. Visioning is a chance for the community to come together and create a common dream. Specific planning solidifies the dream and gives it substance. Organizing gives local officials and developers a way to sit down on the same side of the table and work out common objectives. And implementing publicly guided development brings the vision to life. Properly done, an urban center becomes more than brick and mortar alone; it becomes a place for and a symbol of community.

#### ■ In the Thick of It

Some day this chapter may be replaced with step-by-step historical accounts of how Puget Sound cities made the regional vision happen. Until then, each community must rely on its compelling vision, on proactive planning and publicly guided development, and on tenacity. The following two anecdotes suggest that the next step may not always be clear-cut. In both instances, however, determination made the project a success.

*I drove down to Hawthorne and talked with Ernie. After 10 minutes we both shook hands, and agreed we didn't know what we were doing. Each of us went back to our offices and told our staffs to make it work.*

- Cornelius Pings, Former Chairman of the Pasadena Redevelopment Agency<sup>8</sup>

<sup>8</sup> Downtown, Inc., pg. 103.

Mr. Pings, Former Chairman of the Pasadena Redevelopment Agency, is summarizing a meeting in 1971 with Ernest Hahn, the head of a large and experienced shopping center development firm. They were discussing working together to create Pasadena Plaza, a new downtown shopping complex for the City of Pasadena. In 1971, no one knew exactly how to redevelop shopping downtown. Successes such as Boston's Faneuil Hall Marketplace and Seattle's Westlake Center were still many years ahead.

#### ■ Seeing It Through

*While he was working on [the new town of] Columbia, one board member called to ask whether the company was in trouble. Developer James Rouse said, "Of course we're in trouble." His director told him that Wall Street was upset because of a report that Rouse was unable to raise any more money for the sewer system in Columbia. Rouse acknowledged that the report was correct. Asked what he intended to do about it, he replied, "I haven't the foggiest notion what we're going to do about it, but we'll find an answer."<sup>9</sup>*

Development involves *chutzpah*. You do the best job you can to estimate and anticipate costs, trends, and markets; but in the end, you just plunge ahead. Visionary planning and development requires that public officials and their private development partners be great optimists. The skilled developer is shored up by insight learned through experience, constant vigilance, creativity, and flexibility – a formula for seeing a

<sup>9</sup> Ibid., pg. 114.

## ***Conclusion***

---

project through to its success. Occasionally development projects fail, but not as commonly as one might think. Even projects that initially falter can be redirected and, in the end, be successful.

Developers must take risks, but not recklessly. They control development through careful budgets and estimates that are continually updated. Little is taken for granted. Developers keep a corner of their minds actively engaged plotting "outs" – alternative strategies to pursue if certain expectations are not met. "Well, if this happens, we can always fall back to this, or change this to ...."

Planning and developing an urban center will entail removing obstacles. Obstacles will crop up everywhere – reliably. Those obstacles will cost money and they will take extra time. If you expect the unexpected, you will be prepared to deal with it as the normal course of business. Proactive planning and publicly guided development is a complicated and long-term process, but tremendously satisfying. Development projects, as they have a habit of doing, will come to life, then grow and change for the better of their own accord, long after opening day. Plan to succeed – you will.

## **Appendix A: Case Studies**

---

- Introduction***
- Mashpee Commons (Mashpee, Massachusetts)***
- Seattle Commons (Seattle, Washington)***
- Mill Creek Center (Mill Creek, Washington)***
- Pleasant Hill Station Area (Contra Costa County, California)***
- Hazelwood Neighborhood (Portland, Oregon)***
- Ballston Metro Center (Arlington County, Virginia)***



## Appendix A: Case Studies

### Introduction

Across the U.S., communities are creating and building visions of urban, pedestrian-oriented centers, both from scratch and from existing suburban places. This appendix highlights a few examples noteworthy for various aspects of visioning, planning, organizing and developing. While the focus here is on the *process* of creating an urban center, the results in each of these cases demonstrate good urban design principles as well.

### **Mashpee Commons, Mashpee, Massachusetts**

- Auto-oriented zoning gives way to traditional, small town design

The starting point of Mashpee Commons was a standard, auto-oriented shopping center set in a vast parking lot—a product of suburban zoning and market forces aimed primarily at accommodating cars (often at the expense of pedestrians.) The architecture/planning firm Duany Plater-Zyberk Architects, Inc., set out to convert part of the parking area into a traditional main street, complete with shops, civic buildings, restaurants and a theater. The initial main street project required a change in zoning, resulting in a new code that encourages mixed use and pedestrian-oriented design. Mashpee Commons' main street is now built. In the grand scheme, an entire traditional New England village is to grow around the shopping center.

- Main Street finds a niche in the suburban market

Most communities seeking to establish an urban center are starting here, in a "strip commercial" landscape with suburban commercial market forces actively at work. The

challenge, then, is to create a place where cars and people can co-exist. Mashpee Commons shows one solution: the "two-faced" shopping center with orientations to both a pedestrian-scaled street and peripheral parking lots. Ultimately, more buildings and landscaping can help convert the parking "superblock" into a traditional, people-friendly grid of smaller blocks and streets.

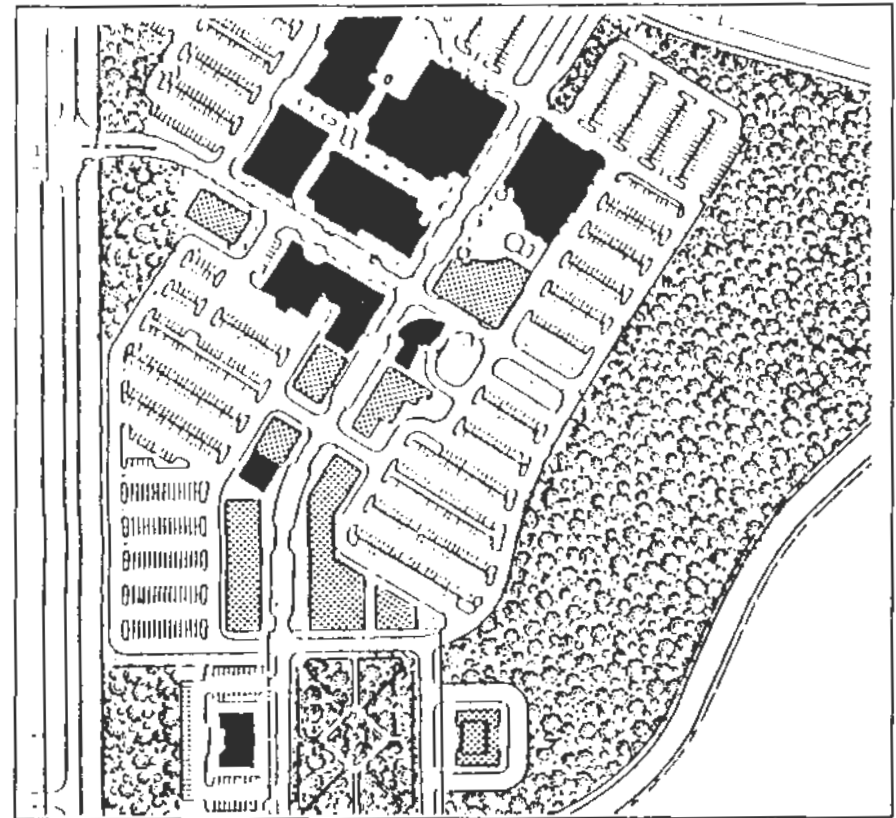

*Mashpee Commons: The addition of a "main street" begins the conversion of a suburban shopping center into a pedestrian-scaled village.*

## Appendix A: Case Studies

### Seattle Commons, Seattle, Washington

- A grass roots vision sets community activism into motion.

The Seattle Commons Project began with the lamentations of a *Seattle Times* columnist over the lack of a large downtown park in the "Emerald City." The article captured the imagination of civic leaders and key city officials who formed a group to look into how such a park might come into being. The idea began to grow until it not only encompassed a city park, but an entire mixed use community that would bring housing, jobs and recreation to an area now dominated by old industrial buildings and parking lots. In the process, Seattle Commons attracted a broad base of civic boosters and community activists, all contributing their enthusiasm and ideas. After an initial vision and plan came together, the project gained a substantial boost when a local businessman loaned the project \$20 million to begin buying land. (The loan will be repaid if the City embraces the plan and buys the park. If not, the land will be sold to repay the loan.)

The Seattle Commons project is distinguished by the enthusiasm and initiative of its backers. The initial commitment and "can-do" attitude attracted over a thousand volunteers to the project. The energy of these volunteers was channeled into 19 committees working on issues such as park design, transportation, public safety, and low income housing. The resulting plan was circulated and reviewed by the community, then revised and republished as a second draft, complete with technical studies on land economics, financing strategies, housing and job impacts, and traffic flows. In its current form, the Seattle Commons proposal would bring a

new 74-acre park, 18,000 new residents, and 21,000 jobs to the city center.

- A key deal keeps momentum going

Initially, the Seattle Commons project was opposed by the *Seattle Times*, which owned a large piece of land in the project area. After many meetings and discussions, *Times* representatives finally put their own development objectives on the table. The Commons team then put together a mutually beneficial deal involving the swap, sale, purchase, and donation of land.<sup>1</sup> Now, the Commons sponsors and the *Times* are working together to convince the City of Seattle to allow key street vacations needed to make the deal work.

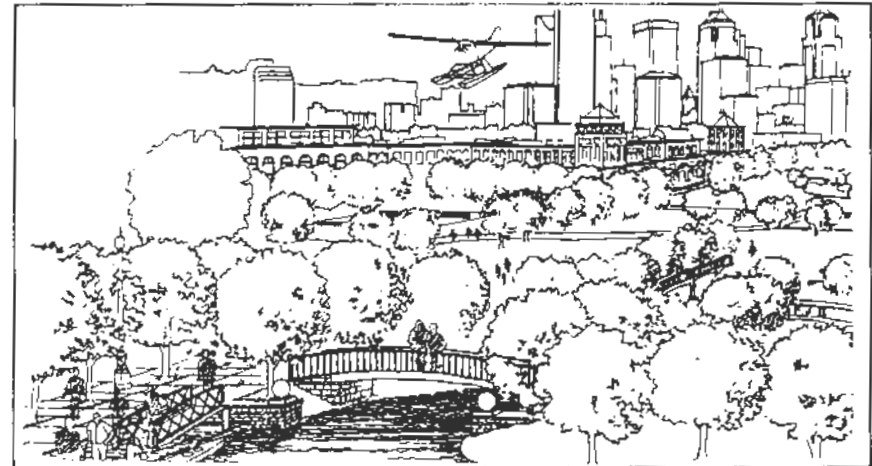

Seattle Commons: A grass roots vision of a new urban park and neighborhood attracts a broad base of community support.

<sup>1</sup> Lilly, Dick; "Big Land Deal for Seattle Commons"; *The Seattle Times*, July 26, 1993, p.1f.

## Appendix A: Case Studies

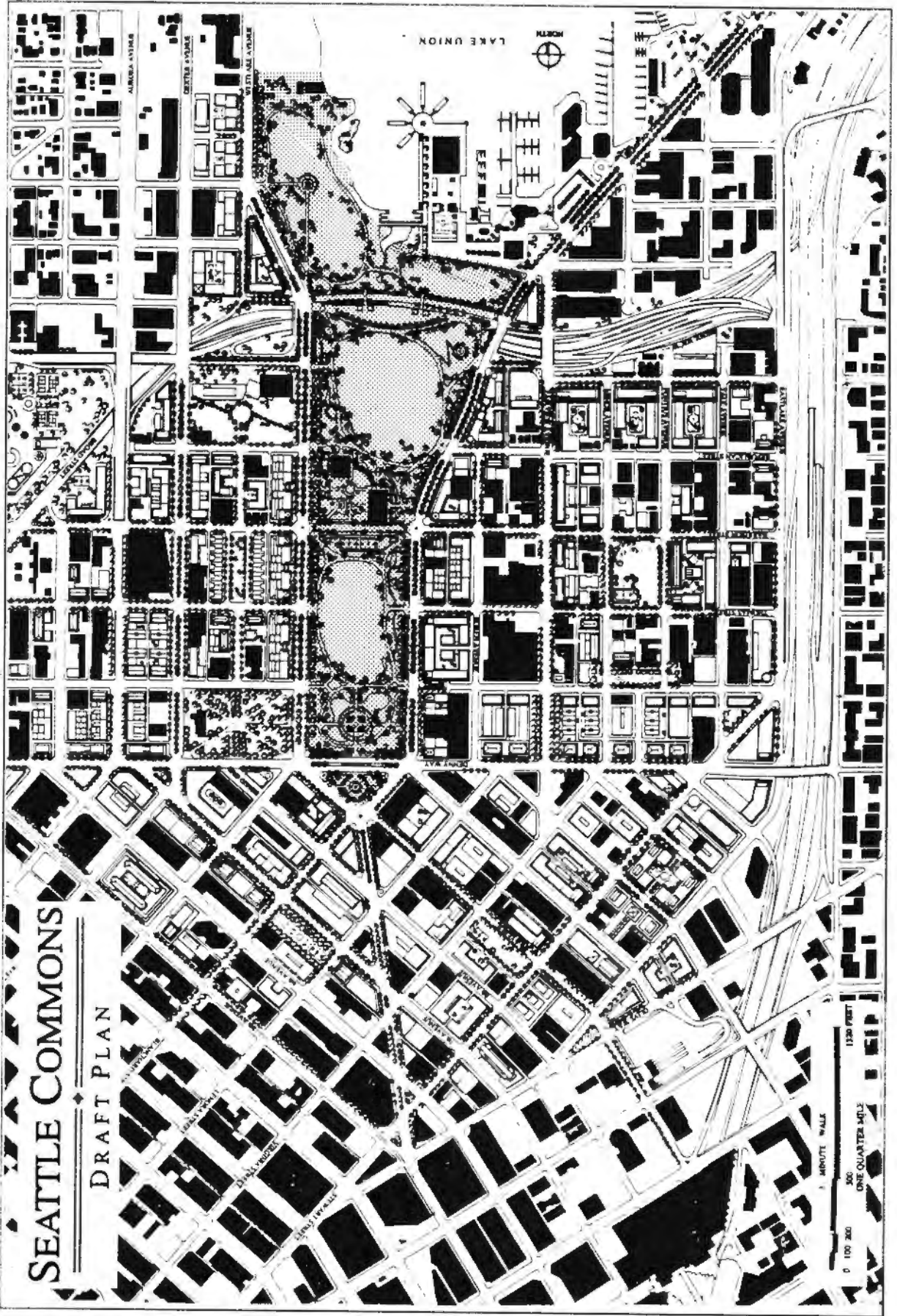



## Appendix A: Case Studies

### ***A Town Center for Mill Creek, Washington***

#### ■ A “planned community” finds its center

The City of Mill Creek, Washington, had its beginnings in the 1960's as an upscale planned residential development (PRD). In typical PRD fashion, the project was located near the intersection of two main highways, with residential tracts and condominiums arranged around a golf course and ample open space. At the crossroads, a strip shopping center was built, along with a cluster of offices and light industrial buildings (one of which currently serves as the City Hall). While designed with a network of recreational trails and exemplary parks and landscaping, the city was laid out for automobiles and had no real center to give its residents a sense of civic identity.

In 1991, with the City's population at nearly 8,500 and the development market amenable, local leaders decided the time had come for the community to create a real town center with housing, services, shopping, recreation, and an emphasis on public spaces. In an update of its comprehensive plan, the City designated 30 acres of largely undeveloped land adjacent to the existing business area as the site.

#### ■ City leadership results in a vision and a plan

The City began by organizing a Steering Committee, including City Council members, citizens, business representatives, and planning staff. The City hired an architecture and urban design firm to help the community develop a vision of the town center. To keep the vision grounded in the realities of the local land development market, they also hired an economic analyst. Using sound urban design principles, the committee led the community

through a visioning process that resulted in the Mill Creek New Town Center Development Plan, including a general site plan, design guidelines, and renderings of the community vision. Underlying the plan is a market analysis that will help the City work with developers to make the vision a reality. The community is already moving into the next phase, which will include soliciting a private development partner.

#### ■ Urban, pedestrian-friendly design and a public orientation

The Mill Creek town center plan reflects a conscious departure from suburban, auto-oriented design to a more pedestrian scaled environment oriented to the public. Some of the principle objectives include:

- A compact mix of housing, shops, offices, public services, and recreation,
- A public plaza, grassy commons, and a vertical landmark,
- Sidewalks, trails, and a transit center.

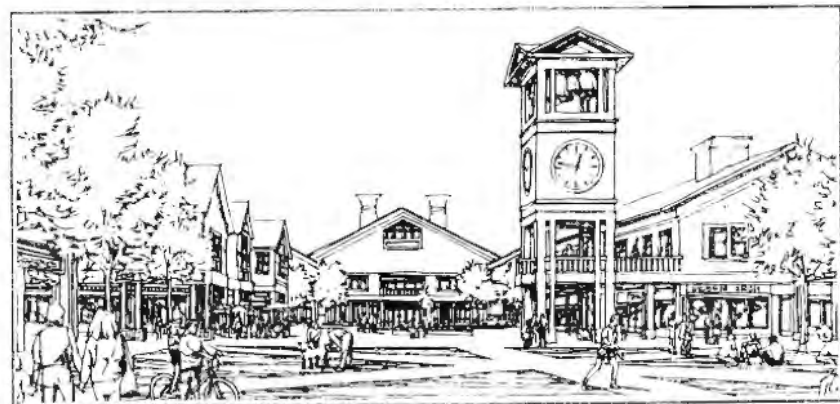

*A City organized effort resulted in the Mill Creek New Town Center Plan.*



## Appendix A: Case Studies

---

### ***Pleasant Hill BART Station Area, Contra Costa County, California***

- A specific plan helps residents, developers, and the regional transit authority define mutually beneficial goals

Pleasant Hill is a growing office, retail, and residential center surrounding a Bay Area Rapid Transit (BART) station. The development around the station is defined by a Specific Plan that was developed jointly by two cities, the county, BART, and the local homeowners association. The specific plan calls for 34% of the land around the station to be developed as apartments and condominiums. Higher density office buildings are included, as well as shopping and commercial services. The higher density, mixed use development helps bolster ridership on BART, while the transit station links Pleasant Hill to other centers around the region.

- A public redevelopment authority brokers key land assembly deals

The Pleasant Hill station area originally contained 190 homes on lots averaging 6,000 square feet in size. The specific plan called for these lots to be bought and reconfigured into larger parcels that could be developed for commercial and multi-family use and for new streets. The Contra Costa County Redevelopment Authority, a public agency with special powers to broker real estate and development deals, became a major player. The Redevelopment Authority approved the developers who were to participate in building the new offices, shops, and apartment buildings. Under Redevelopment Authority guidelines concerning price, these developers then negotiated with homeowners to buy their

lots. When a price was agreed upon, the redevelopment Authority stepped in as broker and purchased the lots, giving the property owners additional benefits under California state law. The authority then sold the lots to the developers. In a few cases, when the developer and property owner were unable to come to agreement, the Redevelopment Authority used its powers of eminent domain to force the sale.

## Appendix A: Case Studies

---

### **Hazelwood Community, Portland, Oregon**

- A Transit Overlay Zone preserves options for pedestrian-oriented, mixed-use development

In anticipation of Portland's "MAX" light rail system, many local governments have set up "Transit Overlay Zones." These zones foster a higher density, more urban form of development, ensuring that both the communities along the MAX line and the transit authority take full advantage of the new transportation investment. The Transit Overlay Zone centered on the Hazelwood Station at 102nd and Burnside Avenue in Portland put limits on the amount of parking and set *minimum lot coverage* requirements.

The Hazelwood station is located within one-quarter mile of a major shopping mall. Adjacent to the station is a twelve-acre site which, due to its proximity to the mall, was ripe for an auto-oriented "big box"<sup>2</sup> commercial development. When a big box developer secured the site, however, the City held fast to the Transit Overlay Zone's parking limit and minimum lot coverage requirement. By not allowing vast areas of surface parking, these limits ultimately ruled out the big box development. Today, the regional transit authority and the

City are exploring two alternatives for the site: One combines apartments and condominiums at 40 units to the acre with a small, on-street commercial center. The other combines a major public institution with housing. Both would be pedestrian-oriented, urban developments that complement the light rail station.

---

<sup>2</sup> A large store specializing in a single type of product, such as toys. Also known as "category killers," these stores sell their products at a discount and rely on a high volume of sales. While they don't depend on being part of a shopping center, they usually are located near a mall or other value-oriented stores. They are generally oriented to the car-driving customer, with large amounts of parking and an exclusively functional "box" design.

## Appendix A: Case Studies

### **Ballston Metro Center, Arlington County, Virginia**

- A public-private partnership leads to a mixed-use urban center around a Metro-rail station

In 1982, the Washington Metropolitan Area Transit Authority (WMATA) began to create mixed-use development surrounding three new suburban Metrorail sites. WMATA acquired land and site control in each area, then issued invitations to developers to competitively bid for the right to develop each site. Only one of the three sites received a bid. One that did not, Ballston, was not attractive because a private landowner controlled one third of the 103,000-square foot block on which the Metro-rail station would be located. Rather than rebid the project, WMATA granted the private landowner the right to negotiate the development rights for the Metro station property so long as the eventual developer of the combined parcels agreed to the WMATA's mixed-use concept. The adjoining private landowner found a major partner and several minor partners. Together, they formed the Ballston Metro Limited Partnership. Between the partnership's formation in 1984 and 1993, the Ballston sector gained 3.7-million square feet of commercial space, 4,300 residential units, and three hotels. An additional 2.5 million square feet of commercial space and 1,000 dwelling units await construction. A second partnership, called the Ballston Partnership, is made up of developers, businesses, residents and local officials. This broadly representative group coordinated infrastructure improvements, marketing, and building activities in the area.<sup>3</sup> Ballston Metro Center

<sup>3</sup> Miller, Richard; "Joint Development at Ballston Metro Center," *Urban Land*, June 1993, p. 23

contains a carefully worked out scheme to make the transition from the rail station to buses that has the effect of expanding the joint development site. Parts of an adjoining street were restricted to buses only and a system of bus bays constructed.

The success of the new Ballston Metro Center can be traced to these critical elements:

1. The transportation authority's willingness to cede development to a private property owner adjacent to the site who agreed to meet the authority's mixed-use development requirements;
2. Arlington County "sector plans" developed to anticipate and control development around the new Metrorail stations; and
3. Formation of the Ballston Partnership.

The sector plan named Ballston as Arlington County's new downtown area. The plan called for high density office and residential development in a 39-block, 270-acre area. To obtain the high office densities permitted in the plan, developers had to provide housing. The County awarded an additional 250,000 square feet of developable space for each 100,000 square feet of building site, if 50 percent of the building site is residential and the remainder commercial.



## ***Appendix B: A Primer on Suburban Retail Economics***

---

- Introduction***
- The Evolution of Suburban Commercial Areas***
- A Suburban Retail Glossary***
- Trends in the 1990's***

## Appendix B: A Primer on Suburban Retail Economics

### Introduction

Creating an urban center by community initiative requires an understanding not only of the public policies that guide suburban land use patterns, but of the powerful market forces that shape suburban development. These market forces are especially prevalent in retail commercial development. What may appear to the casual observer as undifferentiated acres of commercial buildings and parking lots are in fact much more complicated. With a better understanding of how developers of suburban commercial areas see the world, public planners, officials, and citizens can learn to work cooperatively with developers, find opportunities for redevelopment, and avoid strategies that are at odds with market forces.

### The Stages of Suburban Retail Growth

While shopping centers were conceived before the arrival of the federal interstate highway system, major new highways built over the last forty years have fueled the development of suburban shopping centers and continue to ensure their domination of the commercial retail market place. Virtually dependent on the automobile to link them with their customers, suburban retail areas have incorporated the concepts of segregated land uses and auto-oriented design to an unparalleled extent. The drawings at right and on the following page trace the evolution of a typical suburban retail area.

### Evolution of a Suburban Retail Area

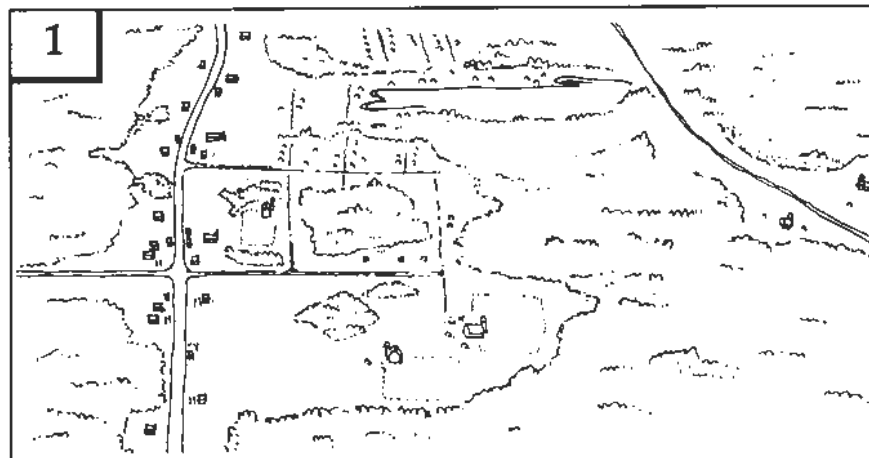

New residential subdivisions are built near the state highway, creating a "bedroom" for commuters who work in the nearby city. Auto-oriented "strip retail" development begins along the highway and at the main intersections.

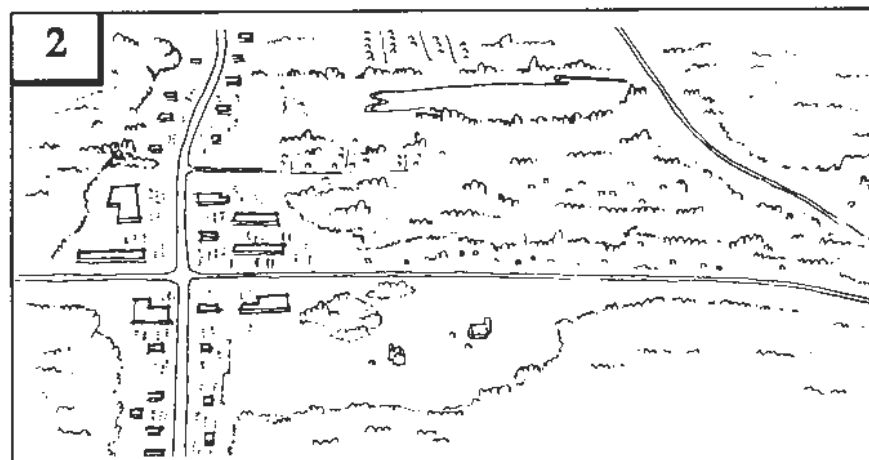

Shopping centers begin to appear at intersections where large, vacant tracts of land are rezoned for commercial development.

## Appendix B: A Primer on Suburban Retail Economics

### Evolution of Suburban Retail (continued)

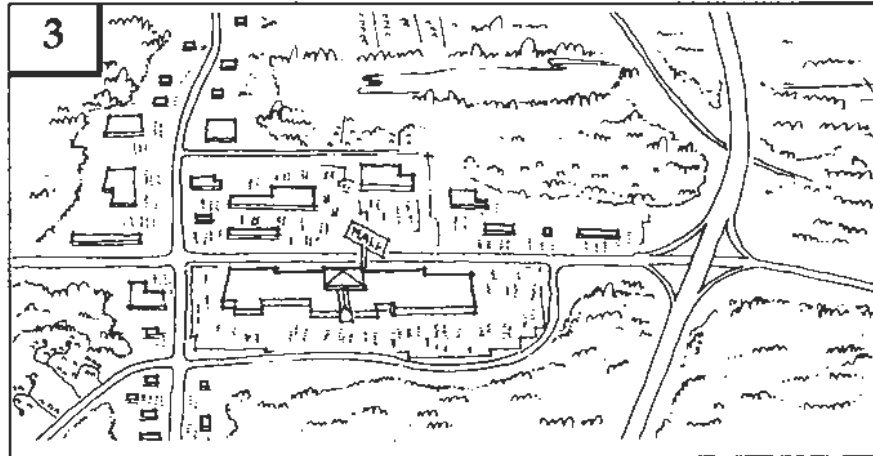

Suburban housing growth continues. Following construction of a new freeway, a major developer finds conditions ripe for a regional mall. A new freeway interchange clinches the decision.

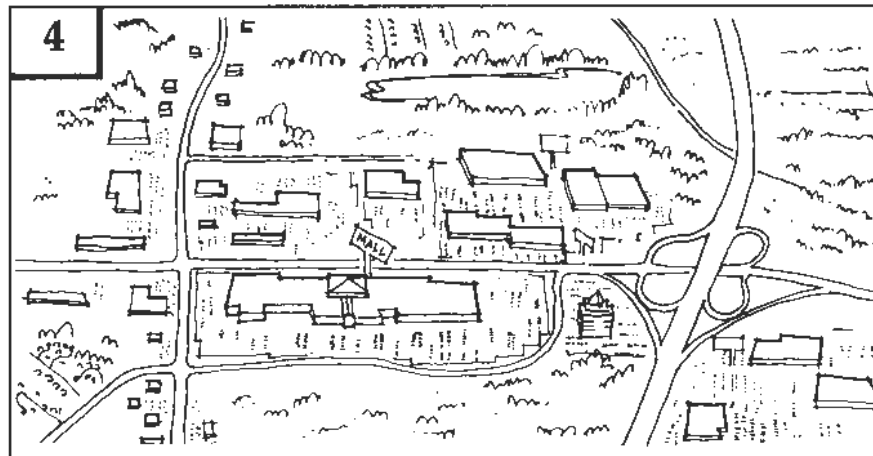

The new mall spawns adjoining shopping centers, creating niches for value-oriented "power centers," "category killers," and "power parks."

### Adapting with the Market

Most communities seeking to establish an urban center are starting here, in a "strip commercial" landscape with suburban commercial market forces actively at work. The task, then, is one of redevelopment, but unlike redevelopment in urban areas, suburban areas cannot rely on pronouncements of "blight" to justify large-scale public condemnation of land. Nor can they necessarily expect a public redevelopment effort to be warmly greeted by suburban retail land owners. The challenge is to co-exist (or to use an apt industry term, "co-locate") with the specialized retail activities—including malls—for which urban centers are seen as a remedy.

The starting point is an understanding of suburban retail uses and the obstacles and opportunities they present. The following are a few examples:

- A healthy, large retail centers with many diverse stores (a mall, for example) might be the anchor for a mixed use urban center.
- "Value-oriented" retail centers or factory outlet centers are auto-dependent and not compatible with an urban, pedestrian-friendly center.
- Smaller, traditional shopping centers, especially those that appear to have been eclipsed by newer developments, offer opportunities for redevelopment.

## ***Appendix B: A Primer on Suburban Retail Economics***

---

### ***A Suburban Retail Glossary for the 1990's***

**Big Box Retail:** See "Category Killer."

**Category Killer:** A large store specializing in a single type of product, such as toys. Category killers sell their products at a discount and rely on a high volume of sales. While they don't depend on being part of a shopping center, they usually are located near a mall or other value-oriented stores.

**Power Center:** A large (250,000 to 750,000 square feet) shopping center with as few as a dozen stores. Large stores take up from half to all of the center.

**Power Park:** A new concept where each store buys its own parcel at a joint location. Power parks often omit space for smaller retail stores.

**Regional Mall:** A very large shopping center (over 400,000 square feet of floor space) that includes at least two anchor stores. Regional malls may be one, two or three stories high and have shops facing inward upon an enclosed arcade. Since they depend on a large base of customers, regional malls are often located near at least one major freeway and are surrounded by parking.

**Shopping Center:** Several, single-story stores, each sharing a side wall with another, with at least one major store that acts as an anchor (often a grocery store). Parking is usually located between the building and the street.

**Strip Mall:** Any single-story, auto-oriented shopping center located along a major arterial road. Strip malls are usually characterized by a large amount of parking in front of the building.

**Value Mall:** A large, sprawling strip center located away from urban centers and traditional retail areas. Value malls bring together many different types of value-oriented retailers, including factory outlets.

**Warehouse Club:** A very large outlet store offering a wide selection of goods but with little variety. Prices and profit margins are very low, volumes high. Initially, warehouse clubs located away from other large anchors or retail draws, but the trend is now to co-locate with at least one other "power" store or a few smaller retailers.

### ***Trends in the early 1990's***

More people are shopping at value-oriented retailers, which is hurting both traditional department stores and smaller stores in shopping malls. But when value-oriented retailers can be enticed into a mall, the smaller stores don't seem to be harmed. Older shopping and strip centers have lost ground to regional malls, but shoppers are starting to return to these smaller, older centers, especially where they have thoughtfully renovated and changed their formats.

In summary, a community seeking to develop an urban center may be put off by the market-orientation (not to mention the jargon) of suburban retail economics. But for many communities, the key to a realistic urban vision lies in understanding and working with, rather than against, these market forces and trends.



## ***Appendix C: Public Development Financing***

---

- Public Financing of Private Development Projects  
in Washington State***
- Types and Uses of Public Financing***
- Tax Increment Financing***
- Other Types of Financing***

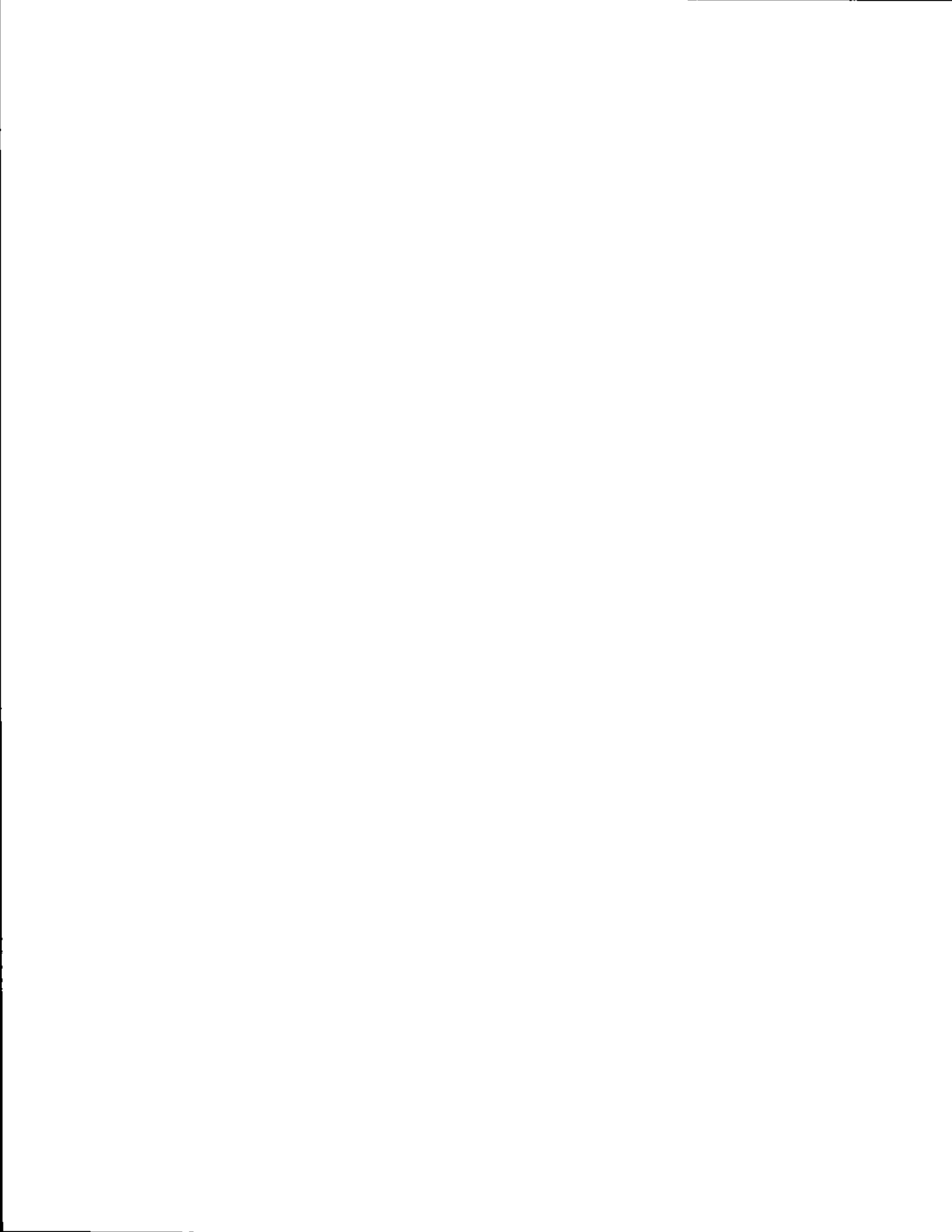

## Appendix C: Public Development Financing

---

### Public Financing in Washington State

Washington State law gives cities and other local governments a variety of tools to help finance urban center development. These range from bonds that help pay for urban center development projects to special assessments, fees, or "exactions" that help finance urban infrastructure and amenities. In using these tools, public officials need to be aware of certain legal restrictions, especially those created by Article 8, Section 5, of the State Constitution, which reads as follows:

No county, city, town, or other municipal corporation shall hereafter give any money or property or loan its money or credit to or in aid of any individual, association, company, or corporation, except for the necessary support of the poor and infirm, or become directly or indirectly the owner of any stock in or bonds of any association, company, or corporation.

These restrictions were put in place to curb excesses of the 19th century, when public officials gave land, credit, and other advantages to railroad companies in exchange for the local siting of railroad lines. Other states have similar laws, but in Washington the State Supreme Court has construed Article 8 as largely prohibiting public financing of private ventures. When such ventures have been allowed (and there have been more such cases in recent years), the legal criteria have been unclear. Public officials should therefore consult with their legal counsel when considering their options for investing in urban center development.

### Types and Uses of Public Financing

#### ■ General Obligation Bonds

Cities and counties can sell *general obligation bonds* to raise capital for urban center development (in effect, borrowing money from institutions that invest in bonds). General obligation bonds, because they are repaid from general tax revenues, can be used to pay for public facilities that aren't expected to directly earn back the money borrowed to build them. A public park or plaza, for example, can be built using general obligation bonds, even though these facilities don't directly earn money to pay back the bonds. Likewise, affordable housing will usually only pay off part of the debt taken on to build it. The amount of general obligation bond debt a city or county can take on is limited, however, both legally and politically, and in some cases, a public vote is required to issue general obligation bonds.

#### ■ Revenue Bonds

*Revenue bonds* can be used to finance "public enterprises" that will directly generate money, or "revenue," which is then used to pay off the bonds. Such enterprises include sports arenas, parking garages, museums, and convention centers—anywhere that a fee or admission might be charged. Revenue bonds are not counted against the public debt of the city or county issuing them, so there are no legal restrictions on their amount and they do not require a public vote. Lenders who buy the bonds will, however, require that revenues exceed the principal and interest payments on the bonds by 25% to 40%.

## Appendix C: Public Development Financing

### ■ Special Assessment Districts

Washington law allows for the delineation of *special assessment districts* within which a tax or fee may be levied to pay for a specific public service or facility. These special assessment districts can cross city and county boundaries, often taking in several local jurisdictions. They are used for a wide variety of public purposes, including:

- Parks
- Open space
- Transit facilities & services
- Parking
- Hospitals
- Sewer/water projects
- Roads and sidewalks
- Public amenities

A *Local Improvement District*, or LID, is a type of special assessment district frequently used by cities and counties for capital improvements that benefit a defined area such as an urban center. An LID can be initiated by the local government or by citizens in the affected area and requires voter approval.

In deciding whether to set up a special assessment district for urban center improvements, local officials should consider whether the costs of these improvements should be borne only by those owning land within the center. If the aim is to develop a place that serves as the community's center and a focal point for community activities, a reasonable case can be made for spreading the costs over the entire community.

### ■ Non-Recourse Conduit Financing

Also known as private activity bonds, industrial development activity bonds, non-recourse revenue bonds, and conduit

financing, *non-recourse conduit financing* allows a public agency to procure tax-exempt financing and pass that financing on to a private partner. Through non-profit or for-profit partners, a city can finance incubator retail areas that help new businesses get off the ground, can develop affordable housing, museums, parks, or other public uses, and do much more. Sources for this type of financing include:

- Affordable Housing: Washington State Housing Finance Commission
- Health Care Facilities: Washington State Health Care Facilities Authorities
- Educational Institutions: Washington Higher Education Facilities Authority
- Small Business Loans: Washington Economic Development Finance Authority

### ■ Exactions

*Exactions*, or impact fees, are fees charged by local governments to private developers to mitigate the impacts of new development projects on the community. A common example is a transportation impact fee, by which developers contribute money to a transportation account based on the amount of traffic their project will generate. In some cases, a developer is allowed credits for infrastructure built as part of the development which benefits the community. Exactions are allowed under the Growth Management Act (RCW 36.70A) and as voluntary agreements under the State Environmental Policy Act (SEPA).

## Appendix C: Public Development Financing

### Financing the Elements of Urban Center Development

#### General Obligation Bonds

- Civic Center with Plaza
- Transit Center
- Library
- Community Center

#### Revenue Bonds

- Parking Structure

#### Special Assessment District

- Streetscape Improvements
- Right-of-Way Purchase

#### Non-Recourse Conduit Financing

- Senior/Affordable Housing
- Incubator Business Space

#### Exactions

- Affordable Units in Housing Developments
- Public plazas/amenities

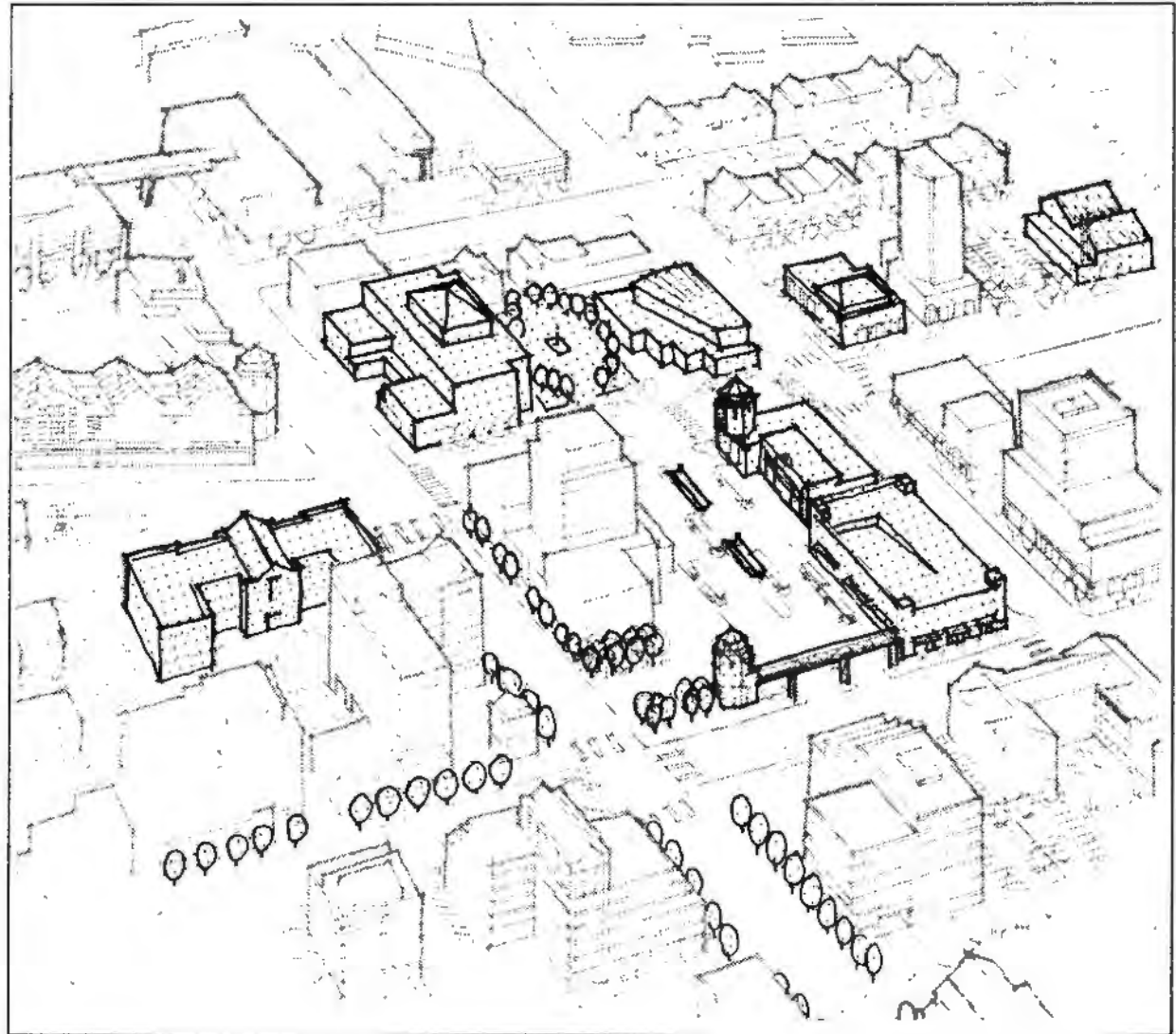

## Appendix C: Public Development Financing

### Tax Increment Financing

A 1982 law (RCW 39.88f) allows cities and counties in Washington State to establish *Community Redevelopment Financing Districts* which make it possible to use *tax increment financing*, one of the most powerful tools available for urban center financing. Community Redevelopment Financing Districts work as follows: First the District is set up, delineating a defined area. As property values rise in this area, the additional property tax revenues are kept within the district and invested in public improvements (rather than absorbed into the general tax base and distributed for a variety of state, county and other purposes). The investment in the district makes property values rise further and spurs private development, creating even more tax revenue for the district.

Generally, the criteria for establishing a Community Redevelopment Financing District are as follows:

- The area must be urban, and
- The purpose must involve providing public improvements approved by the city or county, as appropriate, that encourage private investment and which will increase the value of property in the district.

The diagram at right shows how property taxes are split after a Community Redevelopment Financing District is created. The tax revenues that existed before the district continue to go toward their original uses, but *new* revenues resulting from property value increases are reinvested in the district.

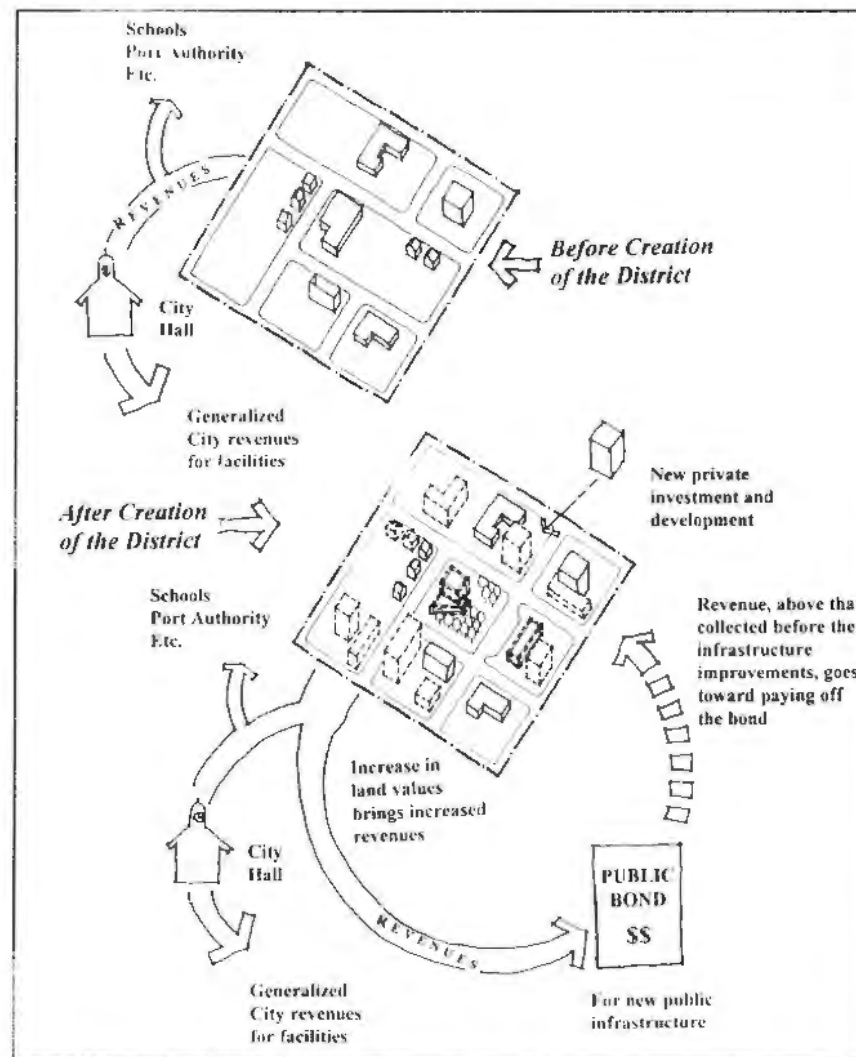

A Community Redevelopment Finance District allows new tax revenues to be reinvested in a growing urban center.

## ***Appendix C: The Public Role in Development***

---

### ■ **Legal Status of Community Redevelopment Finance Districts**

In Washington State, legal scholars have questioned the legality of Community Redevelopment Finance Districts (and tax increment financing in general), citing Article 7, Section 1 of the State Constitution which says that all taxes must be applied equally. In fact, taxes within such a district are assessed exactly as they would be if the district did not exist. At issue is whether retaining a portion of those taxes for exclusive use within the district instead of distributing them into general coffers results in unequal taxation. Twice since 1982, voters of the State have rejected an amendment to the Constitution that would remove this legal cloud over a powerful community development tool. In 1993, the City of Spokane created a district to bring a test case before the State Supreme Court. Should the Court rule against Community Redevelopment Finance Districts, cities can still obtain many of the same benefits through the Growth Related Housing Fund (described below).

### ■ **Abuse of Tax Increment Financing**

The power of tax increment financing can be abused. Suburban cities around Minneapolis, for example, set up too many districts, each hoping to lure major shopping center developments. Rather than create new development opportunities, cities in effect competed with each other, at great public expense, for projects that would have occurred anyway. As a result, the region now uses over four percent of its tax base to pay for public improvements in these districts—a substantial diversion from schools and other public purposes.

### ■ **Seattle's Growth Related Housing Fund**

In the 1980's Seattle was losing much of its lower income housing to commercial development. To combat this loss, the City Council created a Growth Related Housing Fund, agreeing to give five years worth of the City's portion of new taxes generated by downtown office developments to a fund for preserving low income housing. At the height of Seattle's downtown office boom, the fund generated \$1 million to \$2 million annually.

This method avoids the legal pitfalls of tax increment financing because it does not change how tax revenues are collected and distributed. The City is simply using its rightful discretion in spending its share of tax revenues to carry out its community redevelopment policies. The drawback, however, is that a city only receives one quarter of the potential tax revenues generated by the new development. Also, because city councils cannot allocate future revenue in advance, they must renew the plan each year. Once the concept has been adopted, however, bonds may be issued against the revenue, and this makes annual renewal of the program more likely.

## ***Appendix C: The Public Role in Development***

---

### ***Other Financing***

#### ■ **Transportation Benefit Districts**

In 1987, the Washington State legislature authorized Transportation Benefit Districts (TBDs) as a way of paying for transportation improvements that benefit an area in more than one city or county. A TBD could potentially be used to finance certain elements of an urban center transportation system. But TBDs, which are created by a public vote, have not fared well politically. TBDs in Snohomish and Lewis counties failed at the polls. A problem with TBDs and similar, ballot-approved benefit areas is that they require voters to tax themselves now for benefits that won't be realized perhaps for many years. As such, a TBD is often viewed as benefiting "newcomers." Many politicians also object to them as an additional and unnecessary layer of government.



## ***Chapter 2: Transit-Compatible Site Plans***

---

- Introduction***
  - Typical vs. Transit-Compatible Site Plans***
  - A Transit-Compatible Site Planning Process***
  - A Site Plan Checklist***
- 



## Introduction

---

*We can examine transit-compatible land use using the primary communication tool of community planners and developers: the site plan.*

### **Transit Compatibility in the Planner's Language**

Communities are shaped gradually, project-by-project, by the developers who apply for permits to develop land and by the community planners who review developers' plans to make sure they meet community standards. Once a community establishes transit-compatibility as a goal, the day-to-day task of making the goal a reality falls to community planners and private developers in a process called "current planning".

In current planning, the site plan is the primary means of communication. A developer applies for a development permit by drawing up and submitting a site plan that tells the community planner where new buildings, roads, landscaping and utilities will be built. The community planner then compares the site plan to local regulations and policies, and often will explain any changes needed in the project by drawing them on the site plan.

This paper examines transit-friendly land use using this fundamental tool of the developer and the planner: the site plan.

The paper shows site plans for ten *typical* development projects, ranging from shopping centers to business parks to subdivisions, and then offers a more transit-compatible alternative for each plan. In each case, the type and intensity of development remains essentially the same. The amount of parking, the floor-space of the buildings, and the amount of land the project covers are generally kept constant, except where noted. The difference between the *typical* and *transit compatible* site plans has mainly to do with how buildings are oriented with respect to streets and transit facilities and how sidewalks and other pedestrian features are designed. The key problems are labeled on the *typical* site plans, their solutions on the *transit-compatible* site plans. These problems and solutions are generic, highlighting the main issues surrounding each type of project. In the real world, each development project will pose its own unique problems and opportunities.

Generally, the site plans are drawn to scale. Buildings, parking and landscaping are proportionate, but the drawings are much more generalized than an actual site plan, showing only the most basic features needed to illustrate transit-compatible design.

Following the site plans is a matrix to help planners, reviewing a particular type of site plan, to hone in on the key issues for pedestrians and transit riders. Finally, the paper concludes with a checklist that identifies information needed on a site plan to thoroughly evaluate it against standards for transit and pedestrian compatibility.

# Neighborhood Shopping Center - Typical

## Typical Problems:

- ① Lack of walkways into and through the site.
- ② Unsafe and inconvenient access to bus stop and sidewalks.
- ③ No access to adjacent residential areas.
- ④ Large setback from street reduces pedestrian access.
- ⑤ Design creates uninviting and long walks for bus patrons and pedestrians.

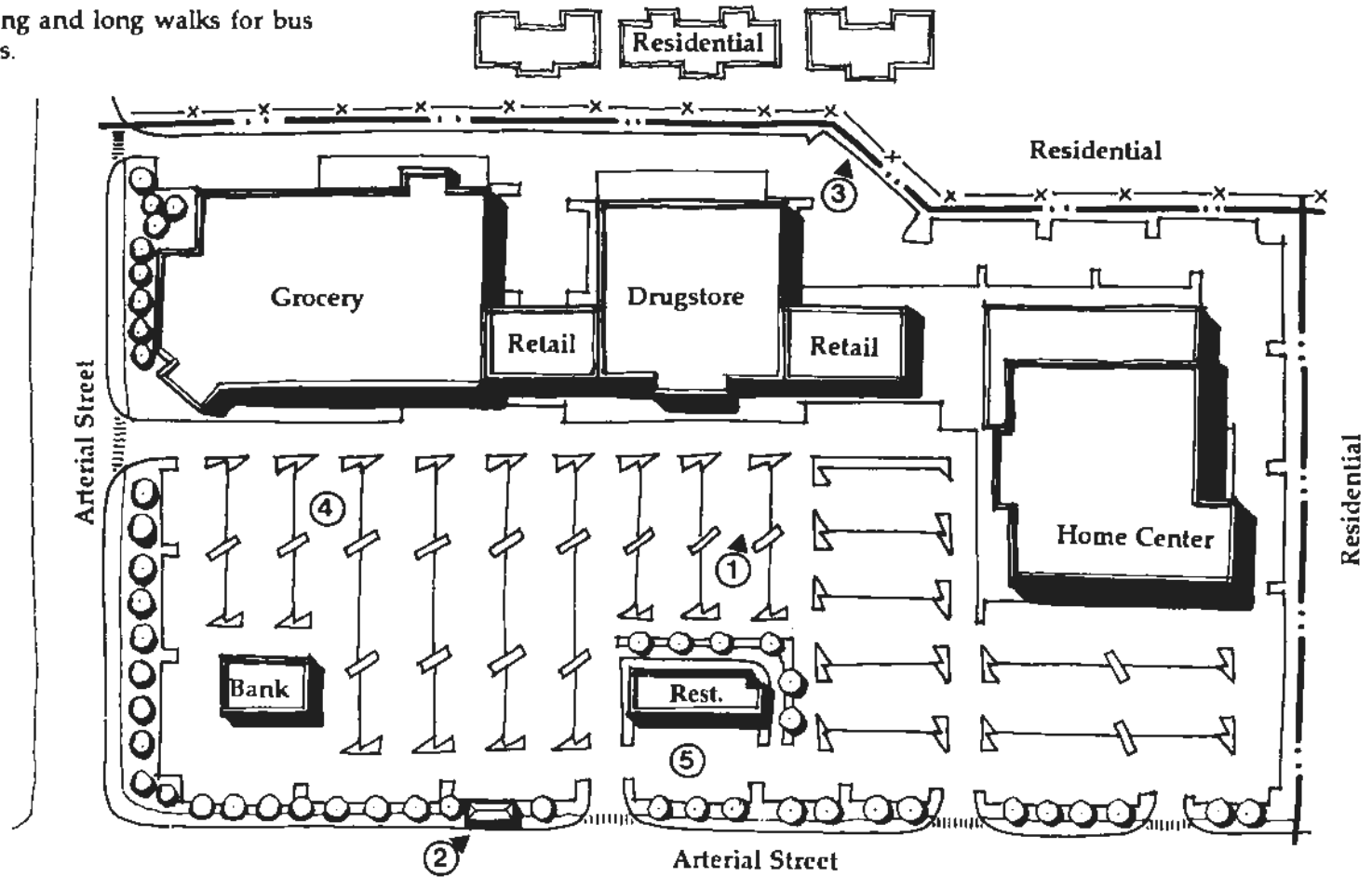

# Transit-Compatible - Neighborhood Shopping Center

## Transit-Compatible Objectives:

- ① Buildings and walkways located for safer and easier pedestrian access.
- ② Covered walkway links bus stop with stores.
- ③ Pedestrian access from neighboring residences.
- ④ Free standing businesses located on corner for better pedestrian access.
- ⑤ Interior walkways connected with perimeter sidewalks.

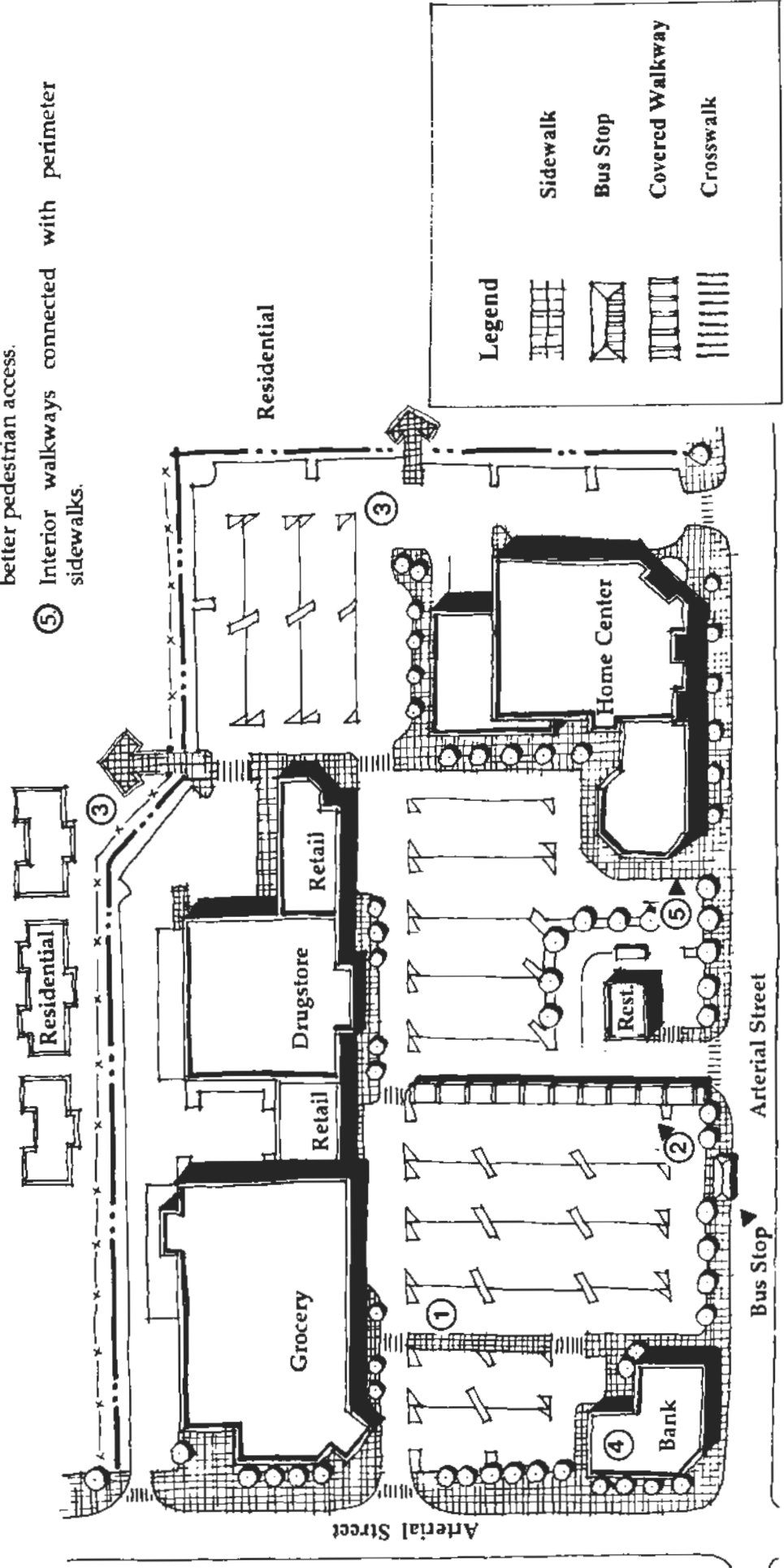

## Mid-Sized Office Building - Typical

### Typical Problems:

- ① Poor access to bus stop and sidewalks.
- ② Parking creates poor pedestrian access to building.
- ③ Driveway entry is too close to intersection (safety issues).
- ④ No pedestrian connections to adjacent developments.

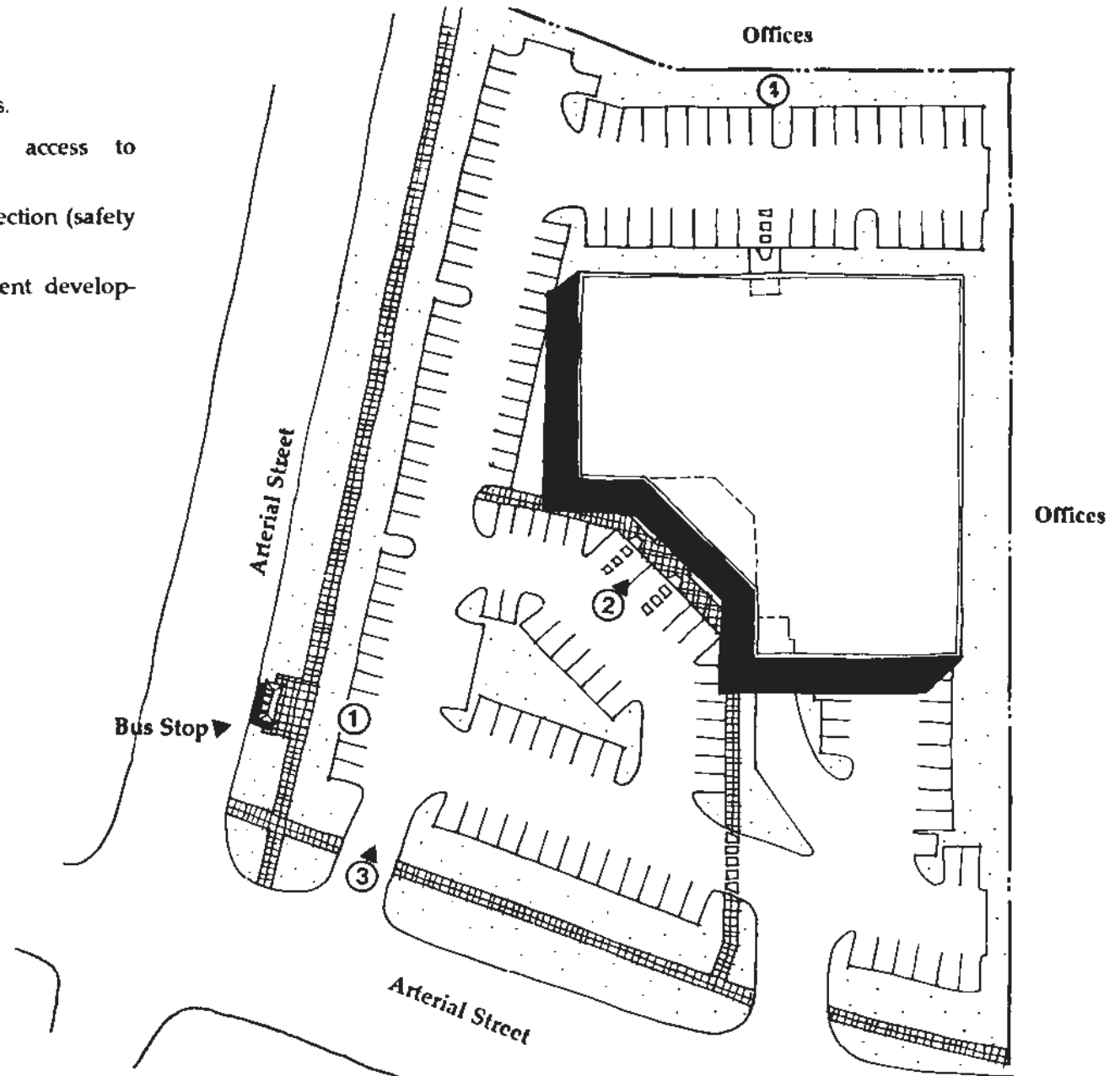
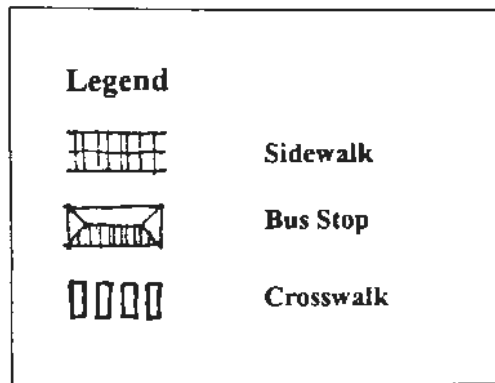

# Transit-Compatible - Mid-Sized Office Building

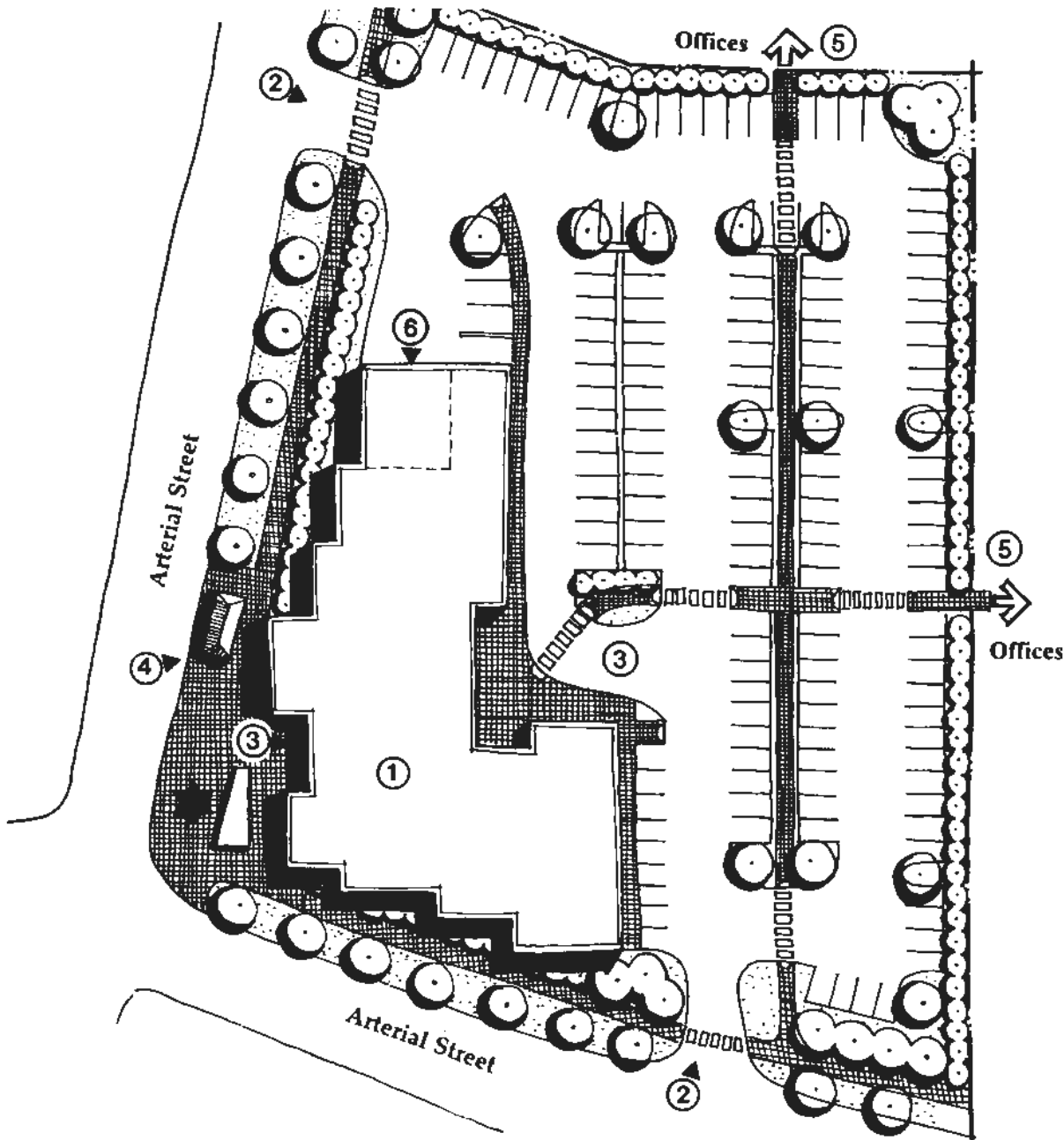

### Transit-Compatible Objectives:

- ① Locating building near street corner improves access to bus stop.
- ② Parking and driveways located behind building.
- ③ Building accessible from both rear parking and sidewalks.
- ④ Bus stop incorporated into plaza design.
- ⑤ Connections to neighboring activities.
- ⑥ Underground parking for car pools, van pools, bicycle, motorcycle, disabled.

Legend	
	Sidewalk
	Bus Stop
	Focal Feature
	Crosswalk

## Residential Subdivision - Typical

### Typical Problems:

- ① Lack of connecting streets isolates neighborhoods, creates long travel distances, and forces all autos onto the arterial street.
- ② Cul-de-sac layout discourages walking and encourages more driving.
- ③ A family living 200 feet from a bus stop must walk 2,640 feet to catch a bus.
- ④ "Dog-leg" intersections create unsafe traffic movements.
- ⑤ There is no safe pedestrian crossing to the bus stop.

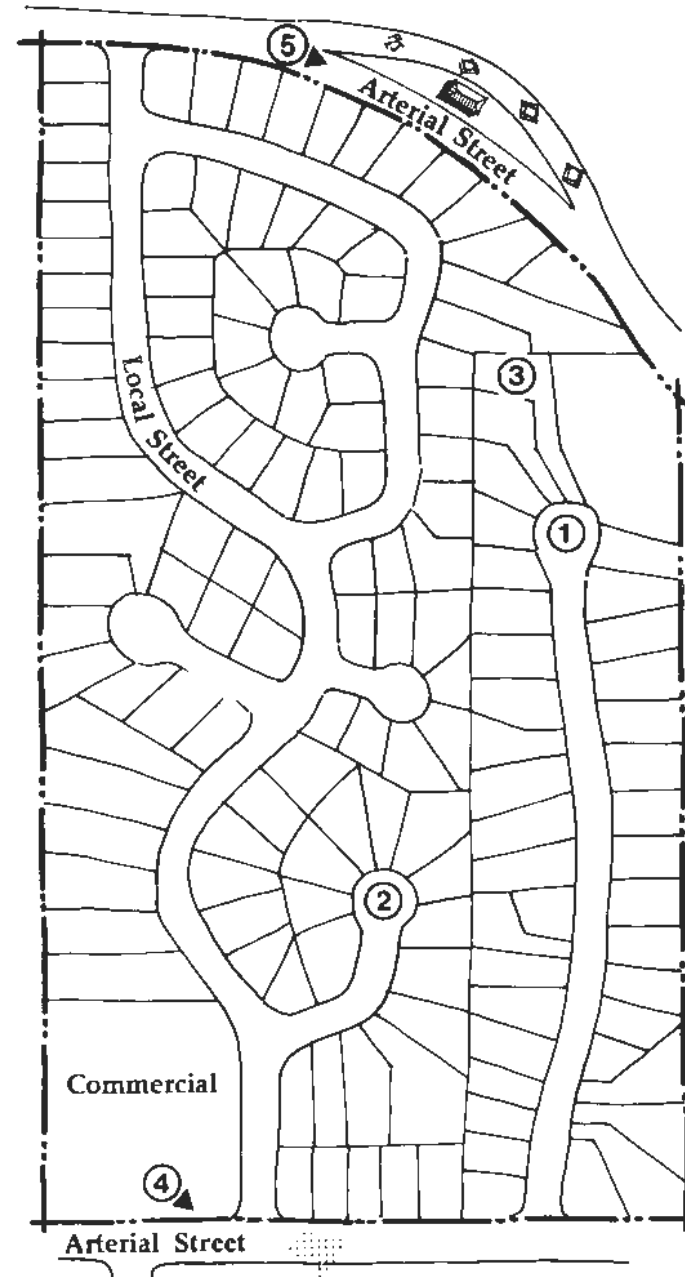



## Transit-Compatible - Residential Subdivision

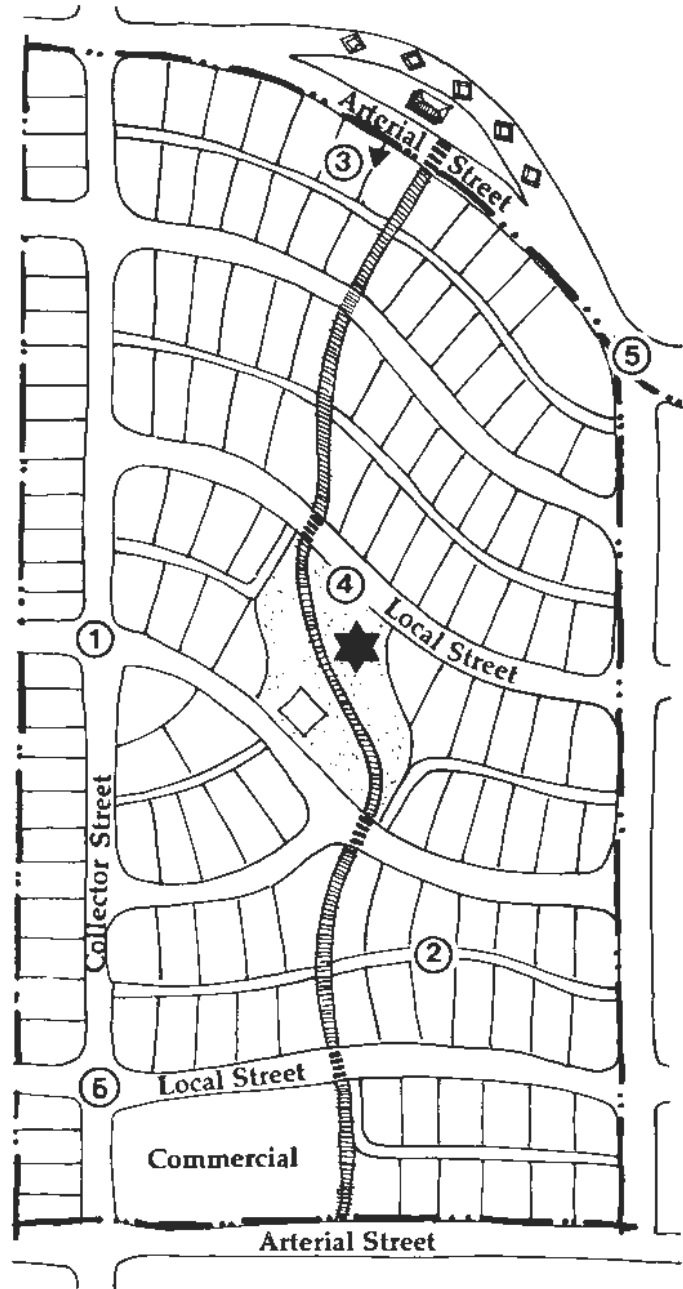

### Transit-Compatible Objectives:

- ① Connected streets allow convenient auto, pedestrian and bicycle circulation within the neighborhood and to adjacent activities.
- ② Alleys reduce congestion, take parking/utilities off the streets.
- ③ Bus stop has direct pedestrian access.
- ④ Neighborhood park has direct pedestrian access within walking distance of entire neighborhood.
- ⑤ System of arterials and local streets provides most direct routes between origins and destinations.

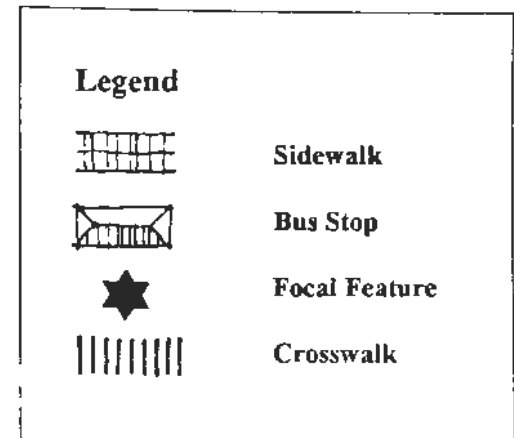

## Residential Lot Split (Short Plat) - Typical

### Typical Problems:

The three figures at left illustrate the typical short platting and development of rural parcels into residential and commercial lots over time. In **Figure A**, the land is divided into large, rural parcels. **Figure B** shows how in five years, the larger parcels are partially subdivided, or *platted*, for building homes. Roads are planned as needed, without thought of future connections, and are built to rural standards without sidewalks. **Figure C** shows the ultimate outcome of such a process: An inefficient, disconnected set of roadways without a clear pattern or through access. Here, neighborhoods are isolated and residents are dependent on their cars. Transit cannot serve the area and walking is a long and often dangerous undertaking.

Unplanned, piecemeal platting also results in lost opportunities for public parks and amenities. Providing shoreline access is a good example. Washington State Law requires that public access to the shoreline be maintained as land is subdivided. If this is done on an individual basis, small access easements must often be provided, which is inconvenient for property owners and provides little recreational value to the neighborhood.

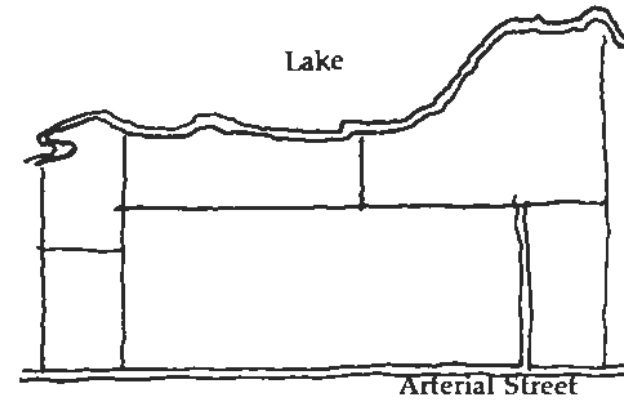
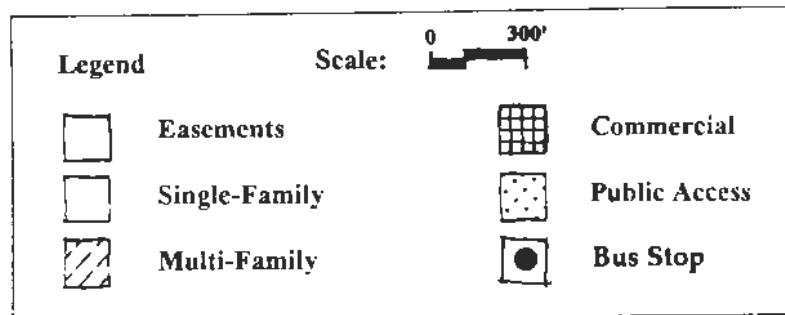

Figure A. Existing Rural Parcels

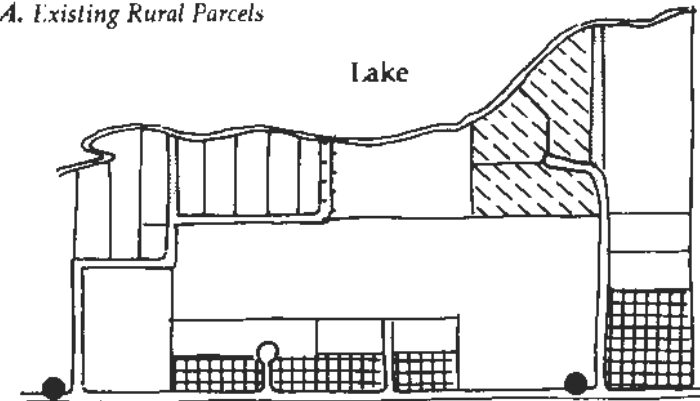

Figure B. Platting begun; roads planned as needed using rural standards. Short plats divide land without concern for circulation or sidewalks.

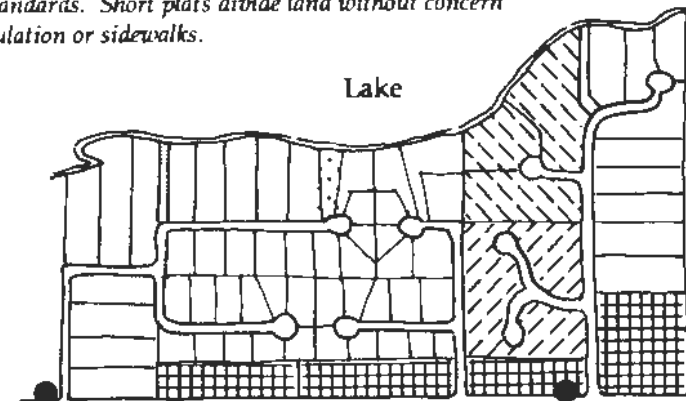

Figure C. Full development; disconnected street system

# Transit-Compatible - Residential Lot Split (Short Plat)

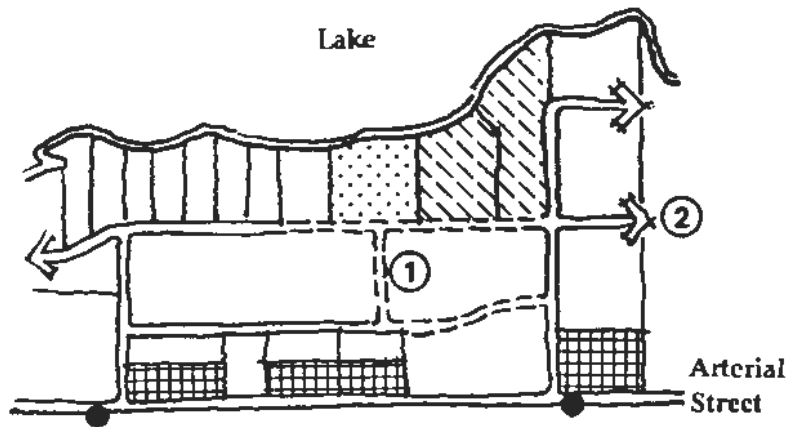

Figure D. +5 years with coordinated road and access easements

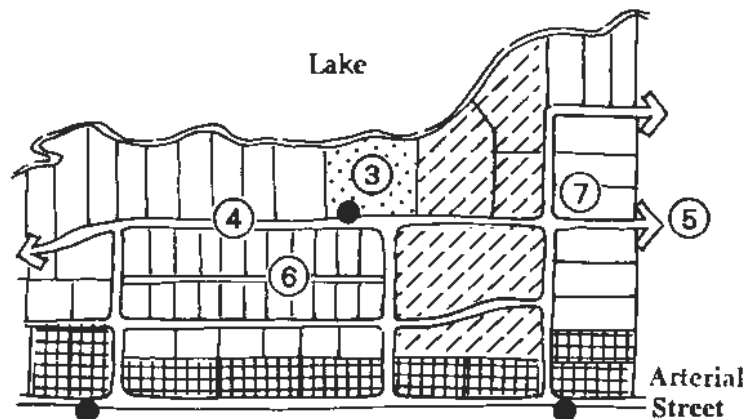

Figure E. +10 years - integrated street and access system

## Transit-Compatible Objectives:

Figures D and E illustrate a preferred development strategy. By dedicating road and open space easements according to an agreed plan, an effective and efficient street system can be developed, and a neighborhood park can be provided. This requires coordination between the local government and individual property owners, but provides many benefits.

## Short Plat Objectives

- ① Easements granted for a network of roads.
- ② Connections to other areas planned.
- ③ Individual shoreline access requirements combined into a neighborhood park.
- ④ Collector street alignment allows network of roads which distributes traffic and allows walking and cycling.
- ⑤ Road design allows potential for transit line if densities warrant.
- ⑥ Alley provides easier residential access.
- ⑦ All streets have sidewalks.

Legend		Scale: 0 300'	
	Easements		Commercial
	Single-Family		Public Access
	Multi-Family		Bus Stop

# Large Apartment Complex - Typical

## Typical Problems:

- ① Haphazard site design makes walkways disjointed and confusing.
- ② Interior walkways do not connect to sidewalks, adjacent activities or bus stop.
- ③ Looped interior street prohibits bus service and limits pedestrian access to bus stops.
- ④ Development oriented to parking lots.

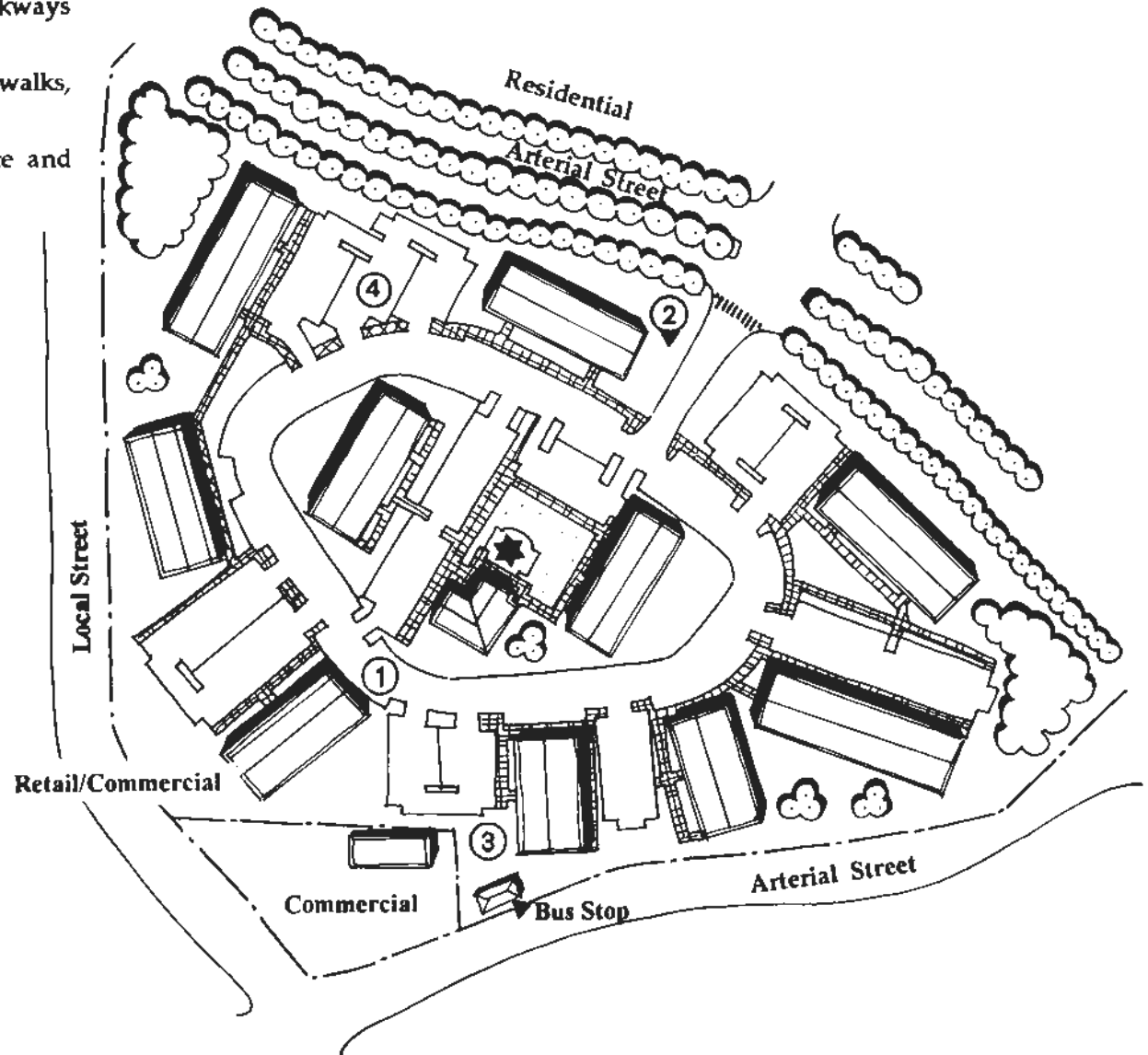
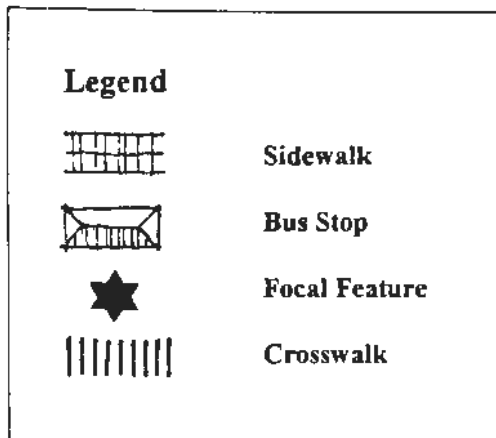

## Transit-Compatible - Large Apartment Complex

### Transit-Compatible Objectives:

- ① Local street improves access, circulation and building orientation.
- ② Walkways throughout the site provide convenient access to neighboring stores, offices, and bus stops.
- ③ Plazas between buildings create a pedestrian-friendly environment.
- ④ Underground parking frees site for open space, mixed uses, and creates pedestrian-friendly environment.
- ⑤ Bus stops are accessible to entire development.

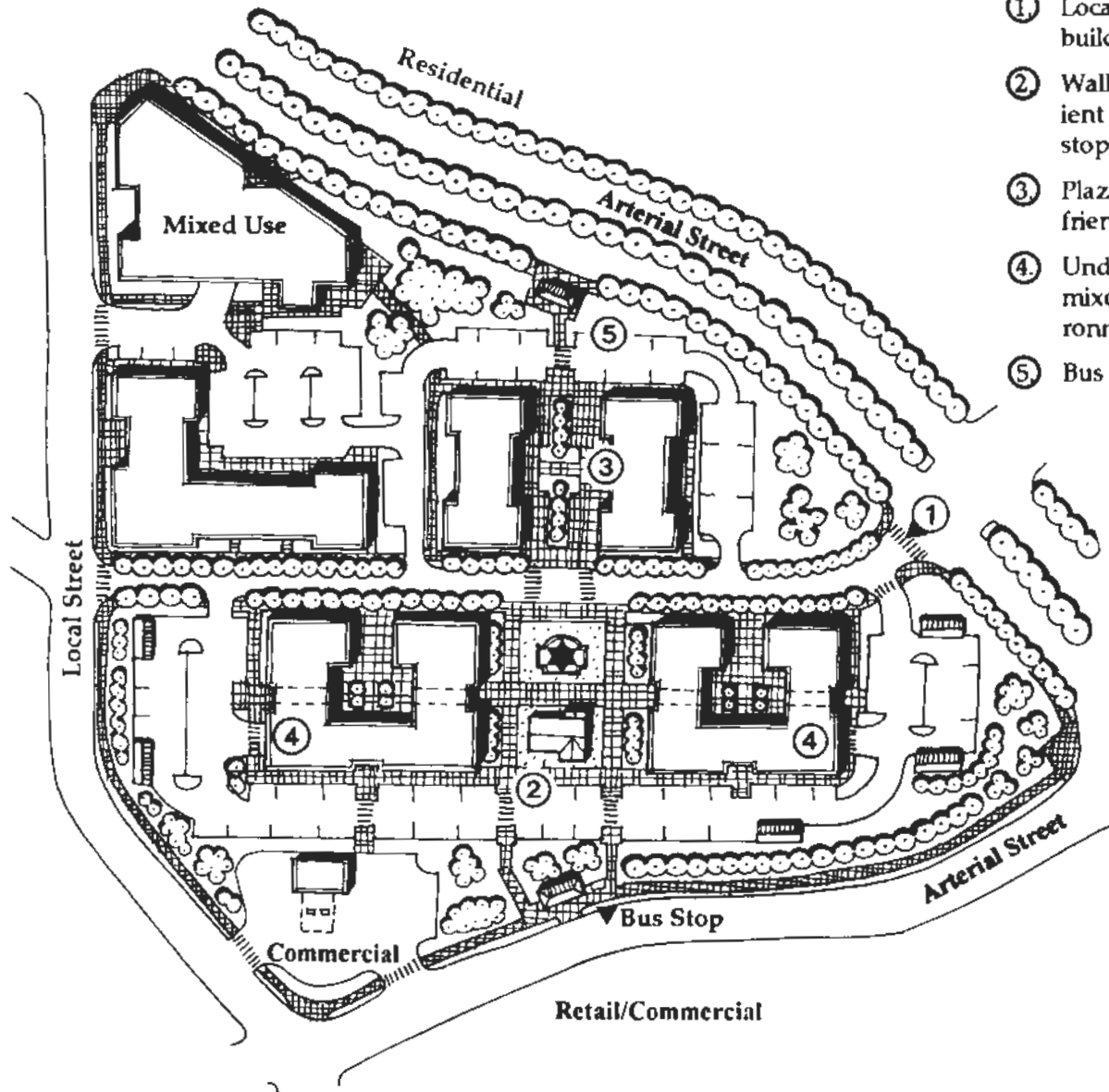

Legend	
	Sidewalk
	Bus Stop
	Focal Feature
	Crosswalk

## Office/Industrial Park - Typical

### Typical Problems:

- ① No through-streets make transit service impossible and restrict auto circulation, resulting in longer trips.
- ② Dispersed buildings increase walking distances.
- ③ Lack of continuous walkways between buildings discourages walking.
- ④ Buildings oriented to parking lots.

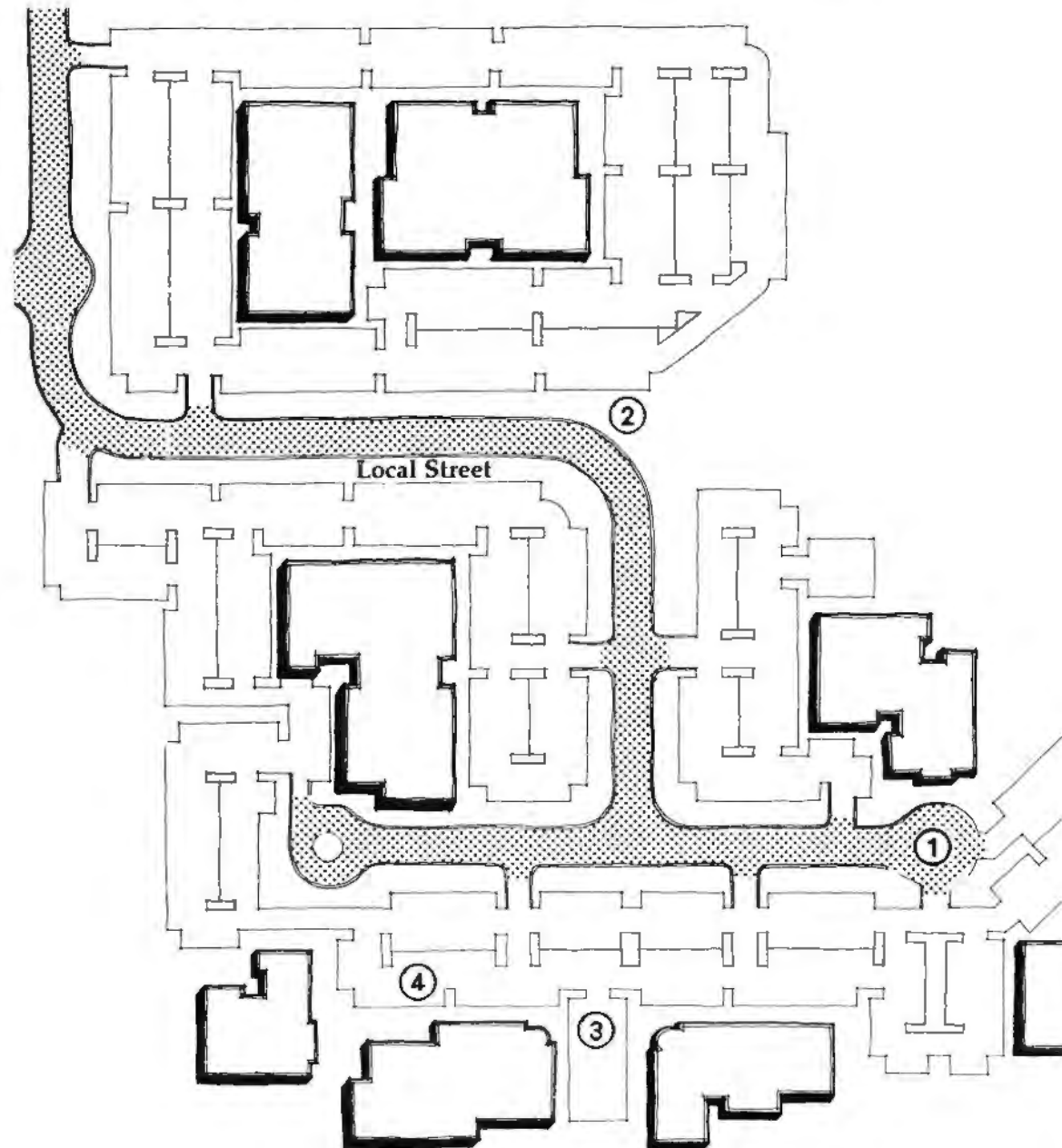
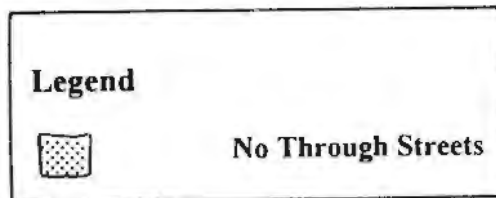

## Transit-Compatible - Office/Industrial Park

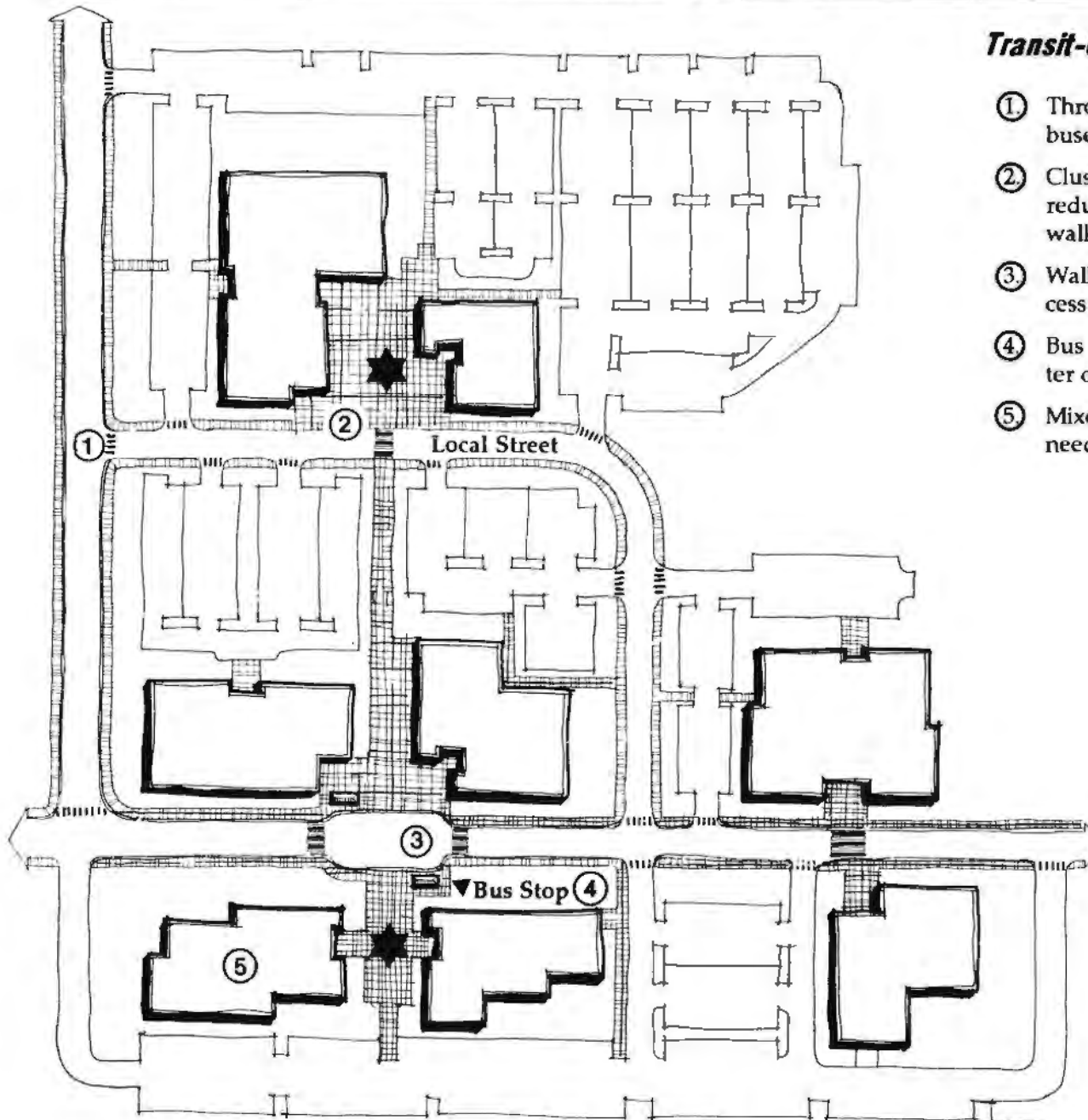

### Transit-Compatible Objectives:

- ① Through-streets provide alternative routes for buses, cyclists, and pedestrians.
- ② Clustering and orienting buildings to the street reduces walking distances which encourages walking.
- ③ Walkways and sidewalks provide convenient access to the bus stop and other buildings.
- ④ Bus stop is located at a central point within cluster of buildings.
- ⑤ Mixed uses (daycare, banks, cafeteria) reduce the need to drive.

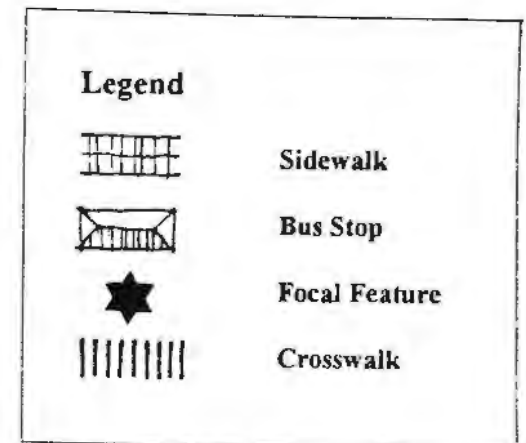

## Small Apartment Complex - Typical

### Typical Problems:

- ① No pedestrian entrance into the apartments.
- ② No connections to neighboring activities.
- ③ Parking is the dominant feature.
- ④ No buffer zone for pedestrians between front doors and parking.

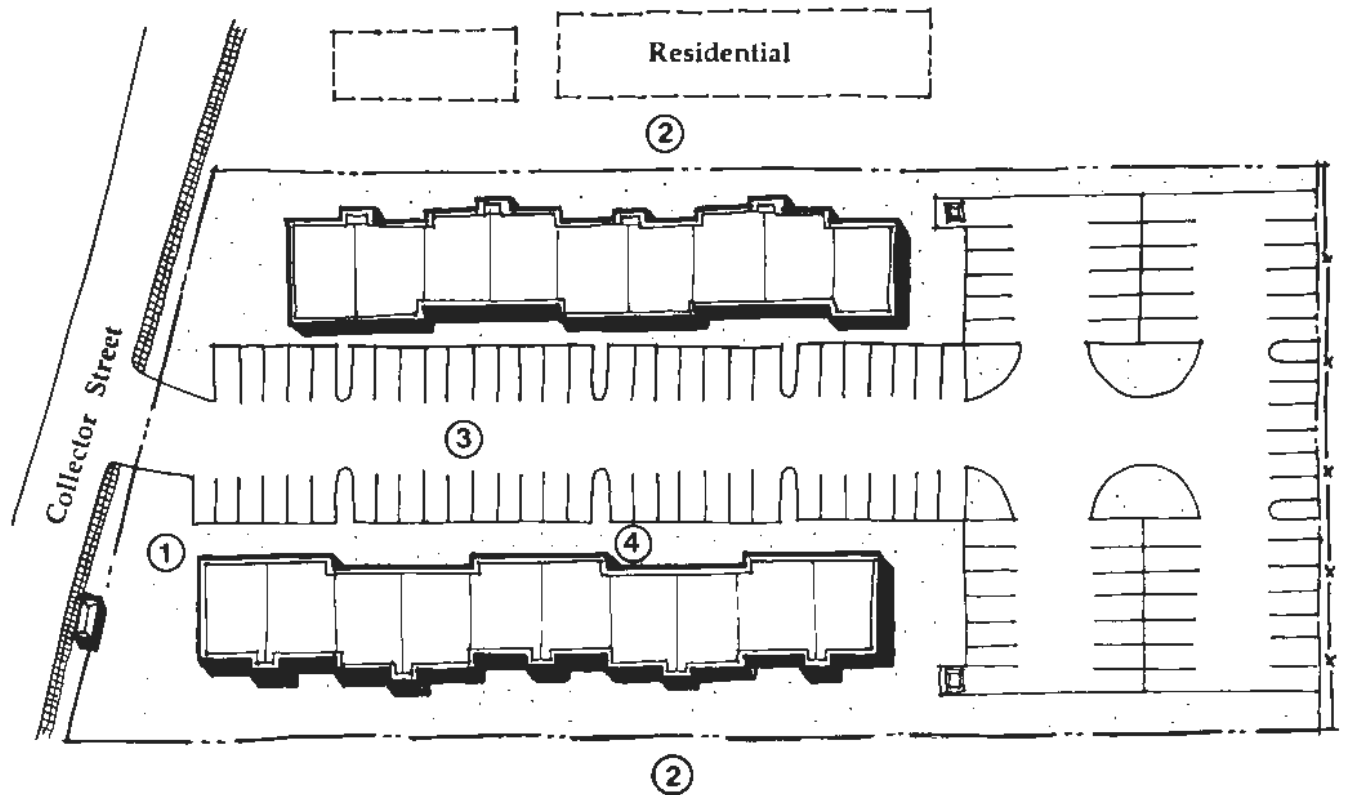
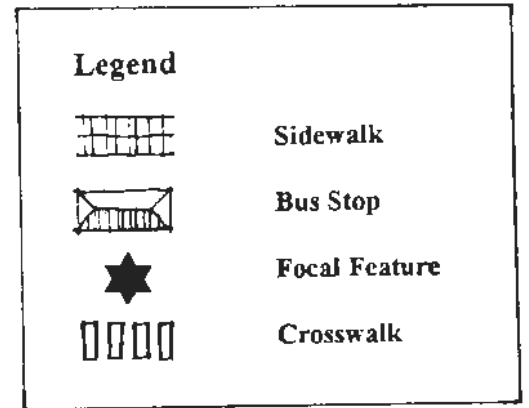



## Transit-Compatible - Small Apartment Complex

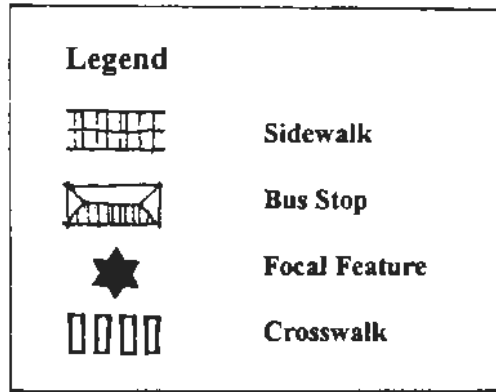

### Transit-Compatible Objectives:

- ① Attractive entrance from the sidewalk and adjacent bus stop.
- ② Walkways provide clear circulation throughout the development and connections to neighboring developments.
- ③ Bus stop is easily accessible.
- ④ Pedestrian courtyard with connections to neighboring developments.

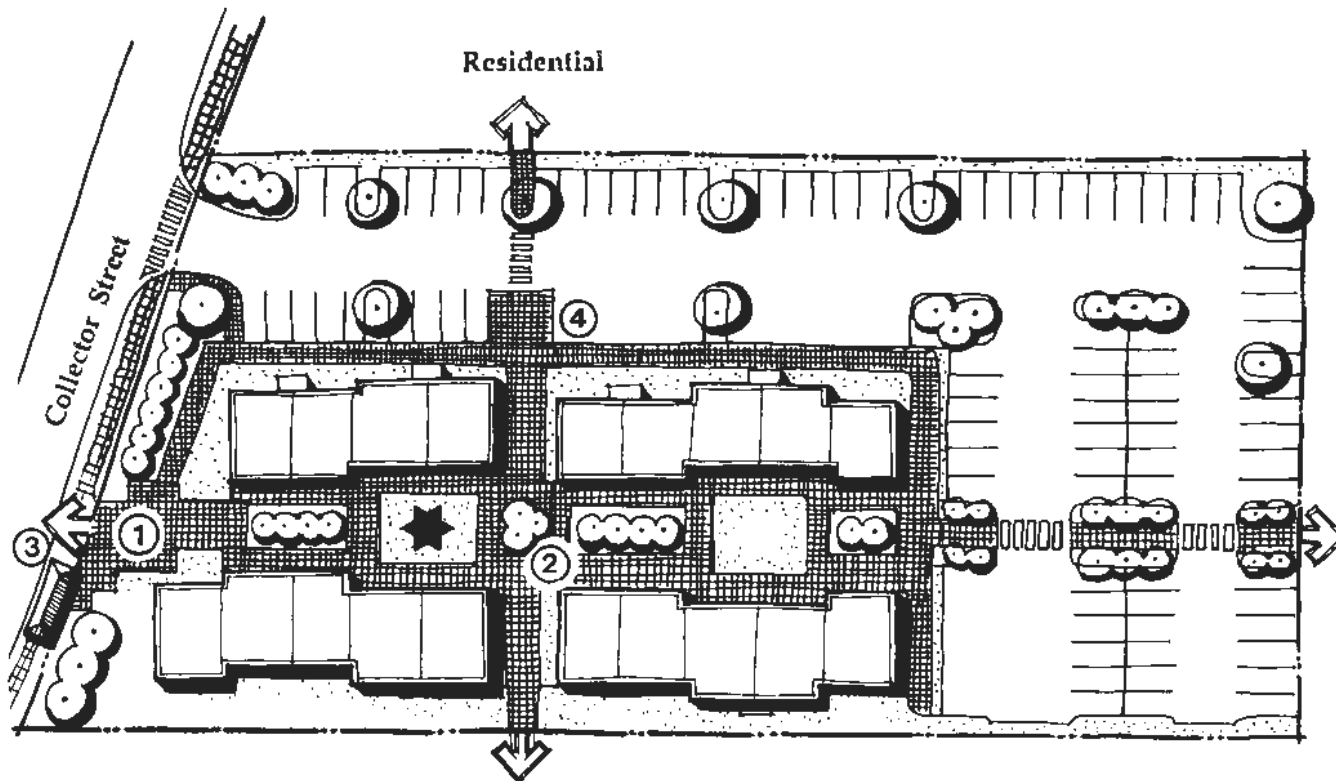

## Master-Planned Community - Typical

### Typical Problems:

- ① Loop roads and dead-end streets increase travel distances and discourage walking, cycling and transit service.
- ② The lack of a community center leaves no logical transit hub which can feed to a regional network.
- ③ All traffic is forced onto a single arterial loop.
- ④ Neighborhoods separated from commercial areas and from one another make the community auto-dependent.
- ⑤ Low densities place most residents more than 1/4 mile from transit service.
- ⑥ Neighborhoods and other activities lack pedestrian connections.

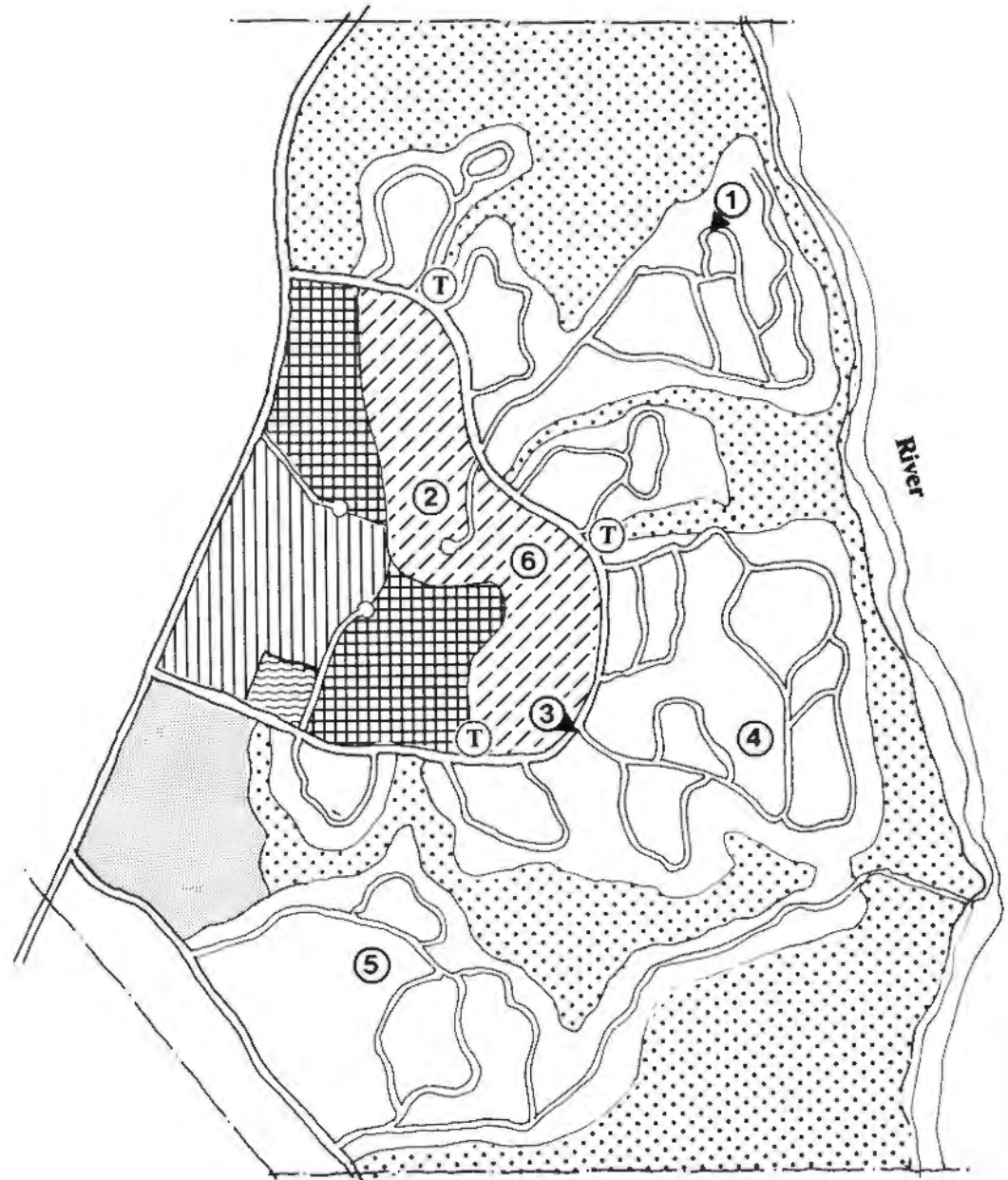
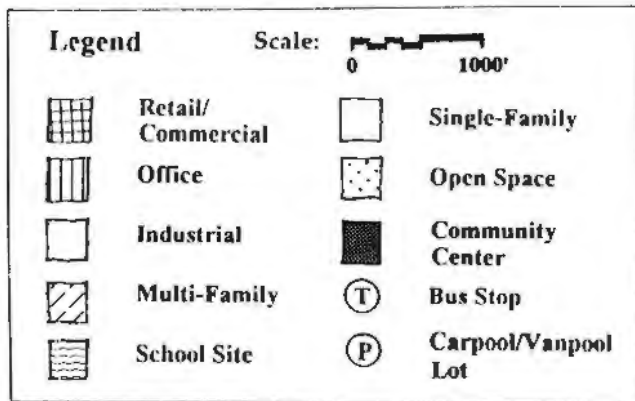

## Transit-Compatible - Master-Planned Community

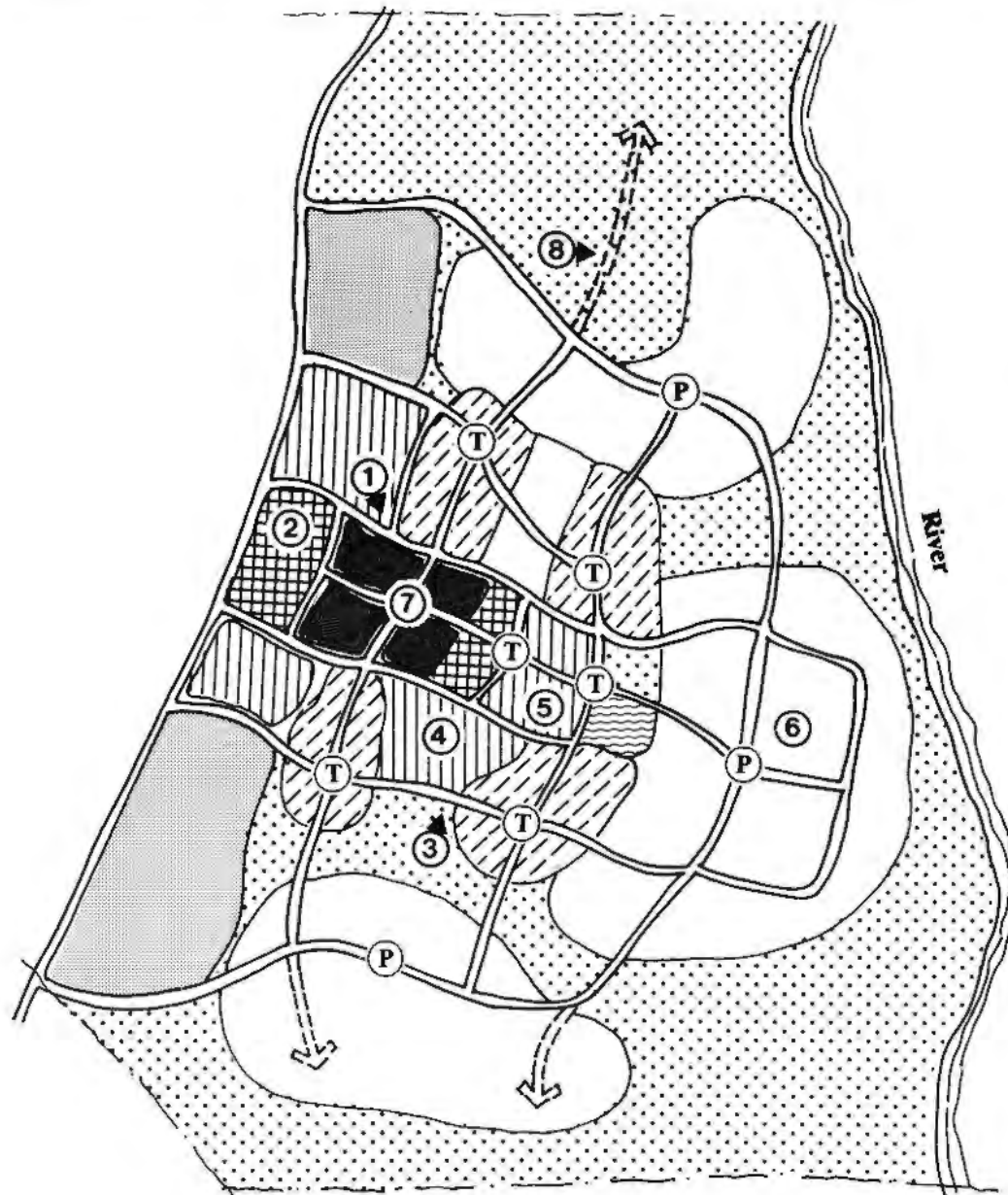

### Transit-Compatible Objectives:

- ① Grid of streets provides more convenient circulation for both cars and pedestrians.
- ② Community and commercial center provides a town center and a transit hub.
- ③ Street network encourages bicycle and pedestrian travel.
- ④ Mix of land uses puts services within walking distance of homes.
- ⑤ Higher density housing and office/industrial uses clustered along transit route.
- ⑥ Network of walkways and trails connect neighborhoods to each other, open space and community services.
- ⑦ Centrally located transit center serves as commuter park-and-ride lot as well as transfer center.
- ⑧ Easements for future roads connecting to adjacent properties and developments.

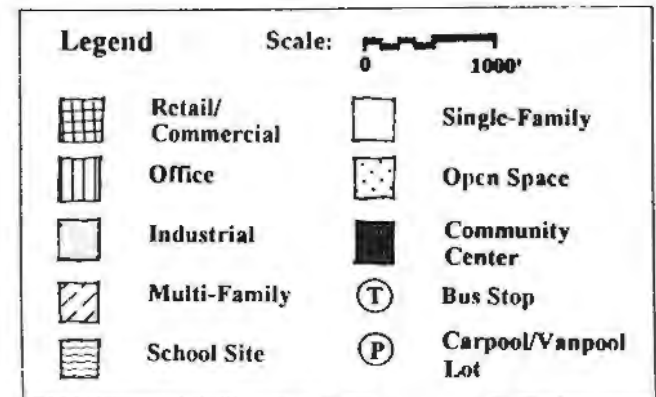

## Planned-Unit Development - Typical

### Typical Problems:

- ① Area is divided into single-use areas forcing people to drive the car to shop, work, recreation, and school.
- ② Streets do not connect neighborhoods with schools, jobs, or shopping.
- ③ Poor pedestrian circulation between areas.
- ④ No community center to serve as a transit hub.
- ⑤ Cul-de-sacs and lack of through streets force traffic onto arterial streets.

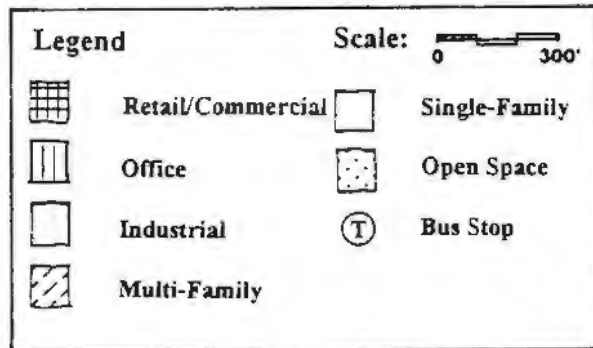

# Transit-Compatible - Planned-Unit Development

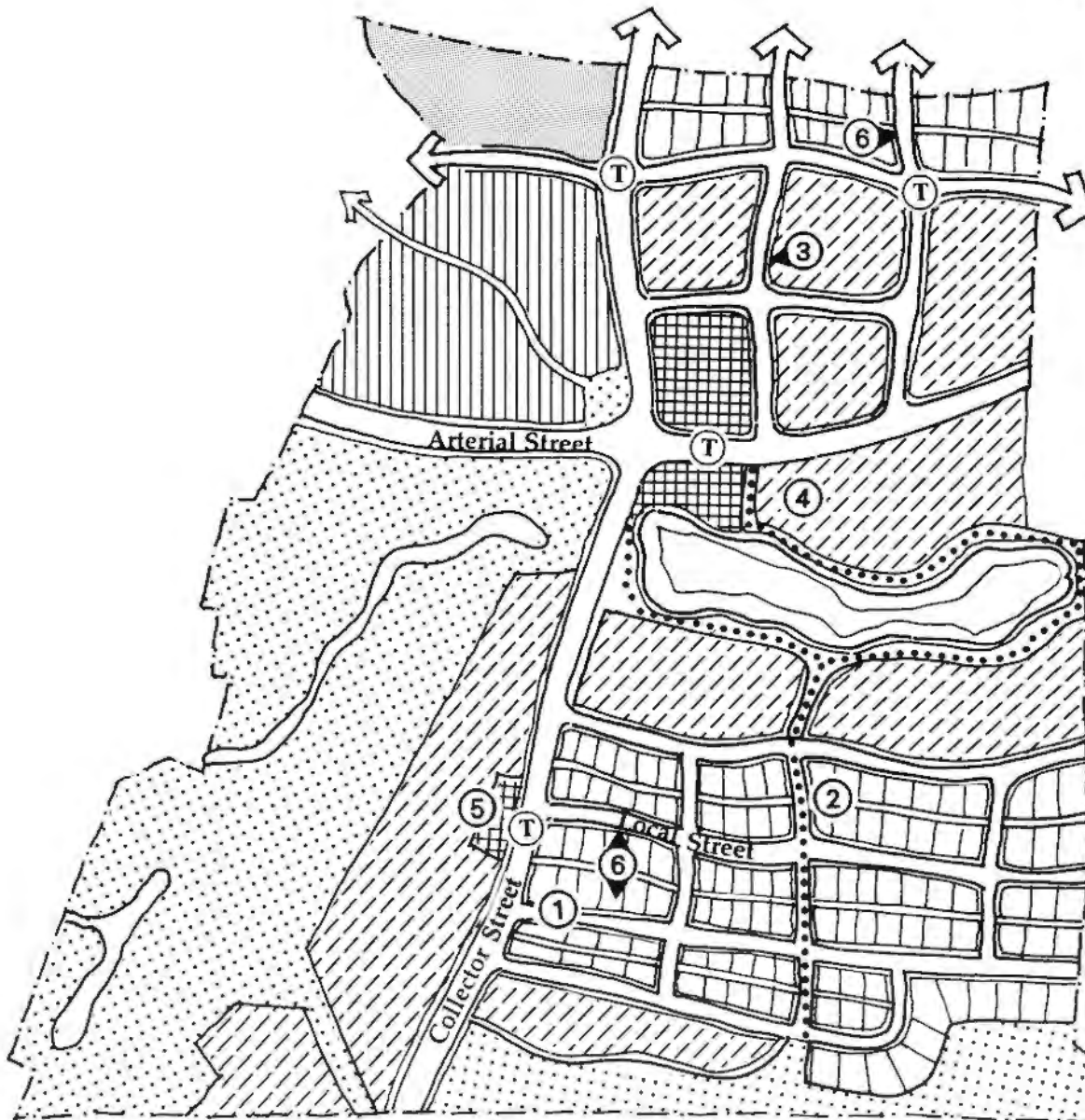

### Transit-Compatible Objectives:

- ① A grid of connected streets links neighborhoods to schools, parks, shopping and jobs.
- ② Street network encourages walking and bicycling.
- ③ Sidewalks and walkways provide safe and convenient access to all activities in the community.
- ④ Central area with a mix of housing, commercial and jobs becomes an activity center and transit hub.
- ⑤ A small store is located in multi-family area within walking distance from single family residential area.
- ⑥ Convenient bus service is possible to neighborhoods and community center with direct pedestrian access to bus stops.

Legend		Scale: 0 300'	
	Retail/Commercial		Single-Family
	Office		Open Space
	Industrial		Bus Stop
	Multi-Family		Public Access

## Park-and-Ride Lot - Typical

### Typical Problems:

- ① No compatible adjacent activities or land uses.
- ② No separate bus and auto entrances/exits.
- ③ No secured bicycle parking. Inadequate weather protection and waiting areas for patrons.
- ④ Park-and-ride lot uncomplimentary to neighborhood.
- ⑤ Inconvenient pedestrian access and circulation both into and on site.

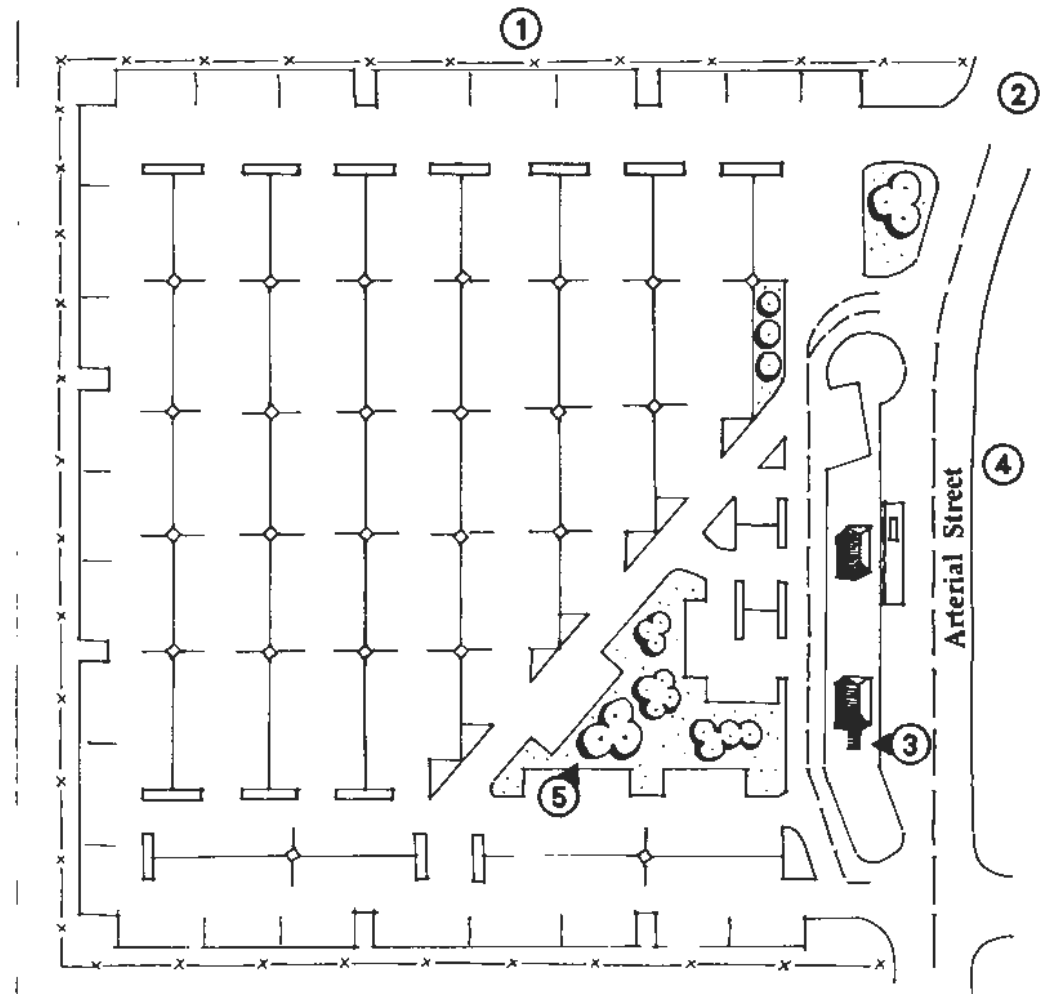
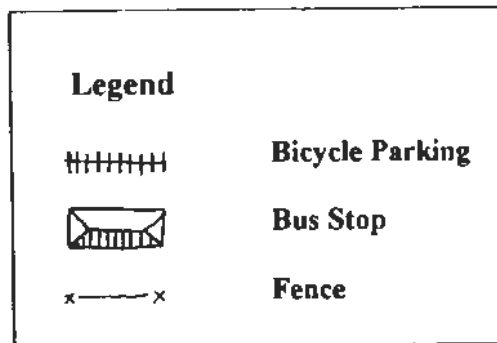

# Community-Compatible - Park-and-Ride Lot

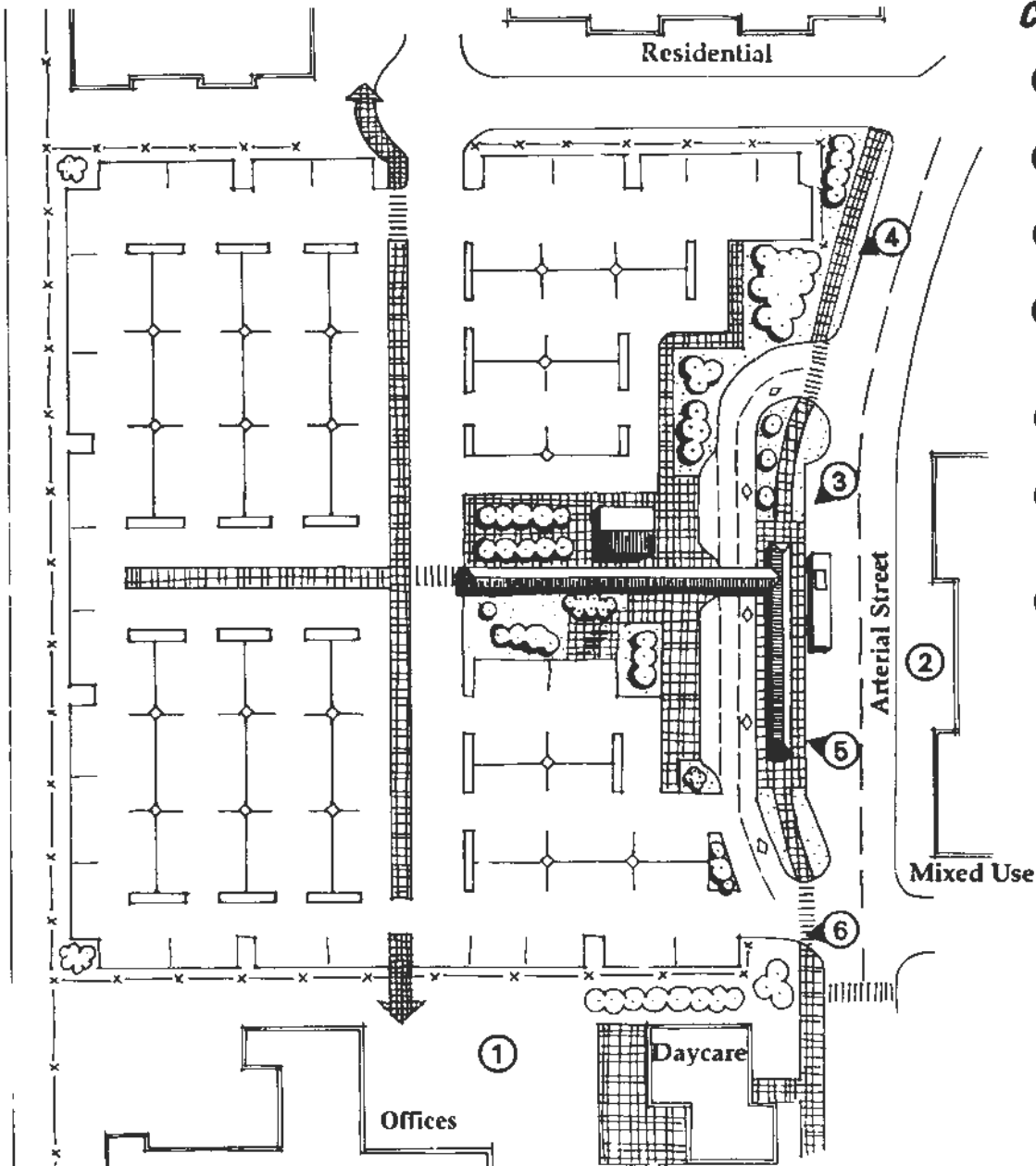

## Community-Compatible Objectives:

- ① Surrounding residential, service, and commercial activities provide patrons, service and security.
- ② Adjacent multi-story building(s) provide security around park-and-ride lot.
- ③ Attractive facility has high-visibility and sense of security for patrons.
- ④ Use of low ground covers and deciduous trees with high canopies balance visibility, security, site design, and buffering.
- ⑤ Covered walkway and shelters protect patrons from weather.
- ⑥ Perimeter fence and landscaping provide buffering except where access is needed from adjacent activities.
- ⑦ Neighborhood is enhanced by landscaping and facility amenities.

Legend	
	Sidewalk
	Bus Stop
	Bicycle Storage
	Crosswalk
	Fence



## A Transit-Compatible Site Planning Process

Not all of the elements of transit-compatible design can be applied to every project, but there are certain elements of transit-friendly site planning that are crucial to certain types of projects. The chart below lists the ten types of projects dealt with in this paper and highlights key site planning issues for each type of project (Residential Subdivision and

Lot Split have been combined in this chart). By focusing on the issues listed here, planners and developers can quickly develop an eye for transit obstacles typical in site plans and can learn to focus on opportunities for making a site plan, and ultimately a community, more transit-compatible.

Key Site Planning Issues for Transit Compatibility									
Type of Project	On-Site Pedestrian Circulation	Pedestrian Access	Pedestrian Shelter/ Amenities	Building Location/ Orientation	Parking Location/ Design	Links to Adjacent Land Uses	Street Network	Density	Bike Routes & Facilities
Neighborhood Shopping Center	●	●	○	○	○	●			○
Mid-Sized Office Building	○	●	○	●	●	●		○	○
Residential Subdivision/Split	●	●			○	●	●	○	●
Large Apartment Complex	●	●	○	●	○	●	○	●	○
Office/Industrial Park	●	●	○	○	○	●		●	
Small Apartment Complex	●	●	○	●	●		●	●	●
Master Planned Community	●	●	○	○	○	●	●	●	●
Planned Unit Development	●	●	●	●	●	●	●	●	●
Park-and-Ride Lot	●	●	●		●	●			●

● = Critical Site Planning Consideration    ○ = Important Site Planning Consideration



## ***A Site Plan Checklist***

---

Evaluating a site plan's transit compatibility requires having complete information about the project and its surroundings. Even when sketching out the initial draft site plan, the developer needs to include information on transit, pedestrian facilities, and adjacent uses on the site plan. Once the project has been submitted to the community planning department and to the transit agencies for review, planners can only make specific suggestions for a more transit-compatible project if they have complete information. Community planning departments typically have site plan checklists which they provide to developers as a guide to what should be shown on a site plan. Communities interested in transit-compatible site planning should make sure their checklists require the following information on every site plan:

### ***A Site Plan Checklist***

- The name, address, and phone number of the developer
- The name of the jurisdiction to which the project is being submitted
- A vicinity map (showing the site in relation to the roads in the area)
- Existing and proposed property boundaries
- Adjacent land uses (including building and driveway locations)
- Existing and proposed landscaped areas
- Existing and proposed fences, walls, berms and swales
- Existing and proposed sidewalks, walkways or paths, and arcades, both on and adjacent to the site
- Existing and proposed roads on or adjacent to the site, including cross section drawings
- Existing and proposed bus routes, bus stops or other transit facilities on or near the site
- A parking legend listing the number of spaces required by zoning and the number of spaces provided
- Parking stalls designated for special use (disabled, carpool, etc.)
- Existing and proposed buildings
- Building entrances
- Benches, shelters, special lighting, or other facilities for the pedestrian
- Bicycle lanes, parking areas, etc.
- Topographic contour lines
- Wetlands, steep slopes, or other environmentally sensitive areas
- Major utilities such as trunk sewer lines or power lines



## ***Chapter 3: Transit-Friendly Shopping Centers***

---

- Introduction***
  - Neighborhood Shopping Mall***
  - Neighborhood Strip Center With Standards***
  - L-Shaped Neighborhood Shopping Center***
  - Neighborhood Center***
- 



## Introduction

*Ideally, the buildings in shopping centers are built on the street, adjacent to the bus stop. But even when that's not possible, a well-designed network of walkways can make walking and transit attractive.*

There are many different ways to make neighborhood shopping centers with stand-alone buildings pedestrian accessible and transit-friendly. This section illustrates various design treatments for four neighborhood shopping centers with different site-plans.

The conventional design of most neighborhood shopping centers makes access other than by auto very difficult. This can discourage people from trying to walk, bicycle, or take a bus. Designing strictly for auto access makes auto dependence a self-fulfilling prophecy.

Transit operators are disinclined to bring buses into shopping centers because buses can become mired in auto congestion, and can be destructive to pavement not designed to handle their weight. Ideally, the buildings in shopping centers are built on the street, adjacent to the bus stop. But even when that's not possible, a well-designed network of walkways can make walking and transit attractive alternatives to the auto.

One feature of neighborhood shopping centers that needs special attention is the stand-alone or "pad" building. These are banks, restaurants, or similar businesses, usually with drive-through lanes, and approximately 1,000 square feet in building size. These buildings are typically located on the perimeter of the shopping center and oriented to the auto user. Shopping center owners and managers like to separate the traffic from these businesses from the rest of the shopping center. The existence of these pads can complicate pedestrian access through a shopping center, or it can be used to make the shopping center more pedestrian-friendly. It's all a matter of design.

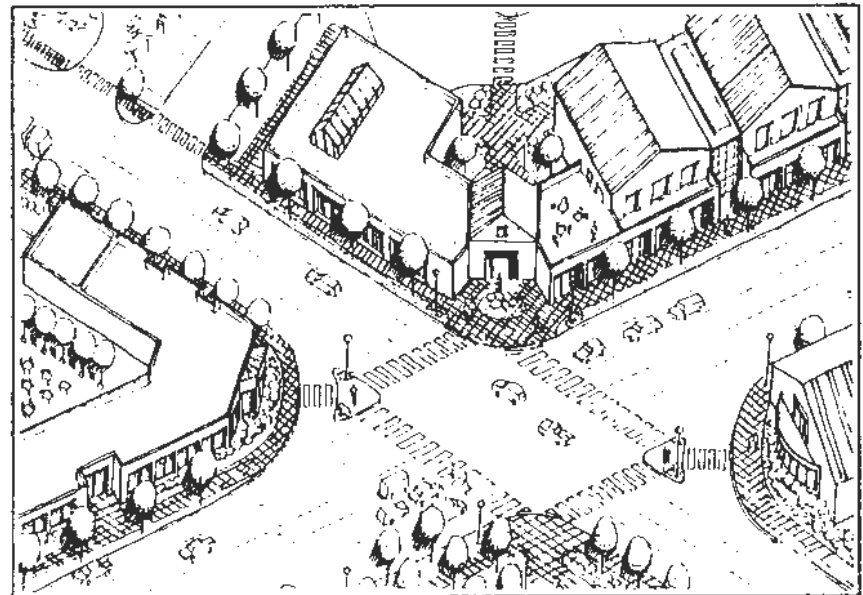

*A comfortable walking environment encourages transit use.*

## Introduction

### *The Problem:*

Shopping centers with free-standing businesses located on their peripheries can create dangerous walking environments for pedestrians and transit patrons. For example, pedestrians may need to:

- Walk long distances through parking lots and be exposed to rain, wind, and the cold;
- Walk with traffic across traffic aisles;
- Cross wide setbacks which isolate buildings from adjoining streets and activities;
- Deal with breaks in circulation patterns within shopping areas; and
- Take long detours around wall and landscaped areas.

These types of problems discourage walking and encourage auto use.

One solution is to locate the center's main buildings as close as possible to the streets served by transit and to improve access to stand-alone buildings. However, this solution is not always possible, especially in suburban settings. The following four examples illustrate alternative methods of making neighborhood shopping centers transit and pedestrian friendly. In all four examples, the shopping center designs focus on ways to increase pedestrian access to the center's activities and to the nearest transit stop.

*Each design shows pedestrian and transit facility treatments that can change an auto-oriented site plan into one that is more pedestrian and transit-friendly.*

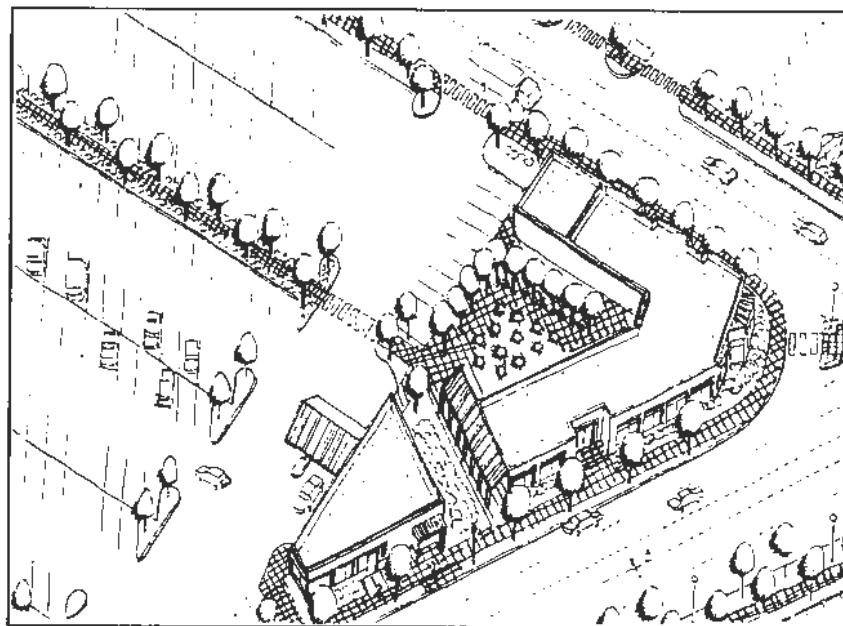

*Buildings on corners create a safer, inviting environment for pedestrians.*

## Shopping Center #1: Neighborhood Shopping Mall

### Description of Shopping Center

This shopping center is a neighborhood center with a major grocery and drug store, and one stand-alone, drive-through restaurant. Retail shops are situated in a small mall between the grocery and drug store. The parking lot is in front, facing an arterial street. Each of the major businesses has a loading area in the rear. There is a bus stop on the arterial street in front of the shopping center and a second bus stop on the local street immediately to the rear of the center.

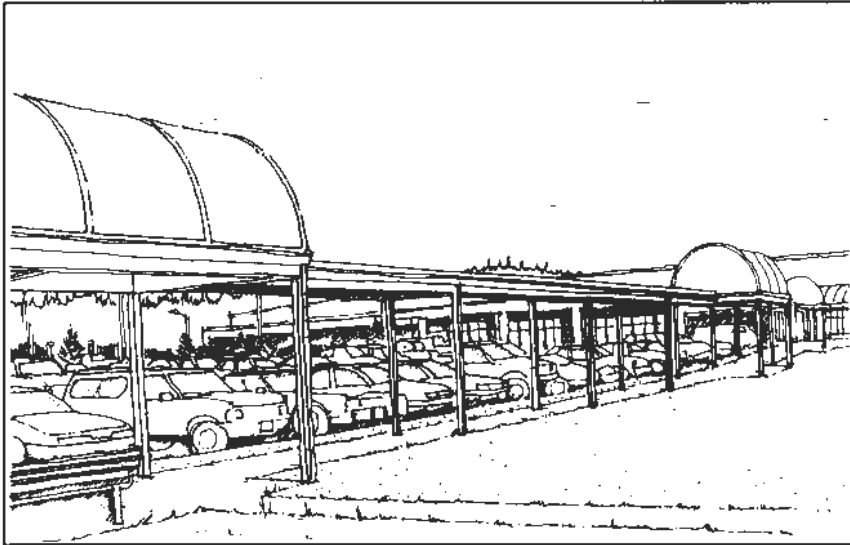

*Raised and covered walkways make parking areas more safe for pedestrians.*

### Pedestrian and Transit Treatments

The location of the drive-through restaurant does not impact pedestrian access, but does not allow designers to move the buildings to the arterial street. In this situation, it makes more sense to orient the shopping center to the surrounding uses on the adjacent local streets which normally would be considered to be the back of the center.

The shopping center offers a double orientation: pedestrian orientation to the local street and surrounding parcels and vehicle orientation to the arterial street in front of the center. This allows easy access to the drive-through restaurant and convenient parking.

A second major feature is a central walkway linking the two bus stops via the parking lot and stores. This walkway allows safe pedestrian access through the parking lot while not interrupting auto circulation. This walkway connects with a pedestrian mall which can be used for outdoor activities and displays. This walkway permits convenient pedestrian access from neighboring offices, residences and the abutting bus stops into the shopping center.

# Shopping Center #1: Neighborhood Shopping Mall

## Transit-Compatible Features:

1. A wide, safe walkway in front of stores (16 feet minimum, 20 feet preferred).
2. Safe, convenient pedestrian access to the surrounding sidewalks.
3. Bus stop with a transit shelter designed to fit with the architecture of the shopping center.

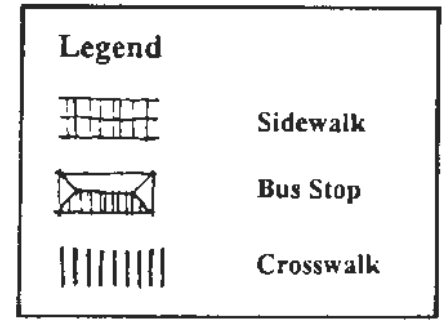
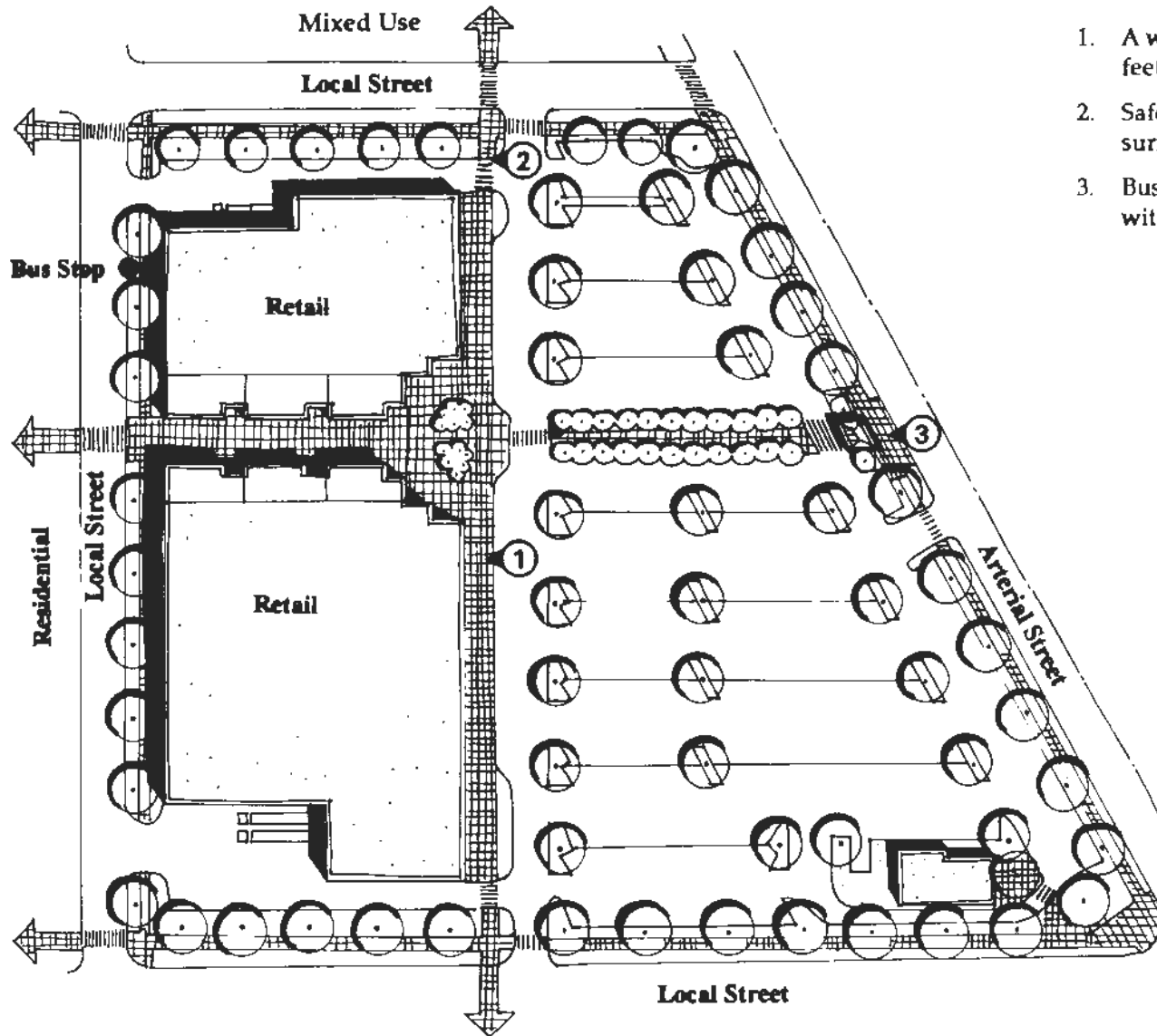



## Shopping Center #2: Neighborhood Strip Center With Standards

### Description of Shopping Center

This is a neighborhood shopping center with a major grocery, drug store and associated retail shops. There are two pads - a drive-through bank and a drive-through, fast food restaurant. The center is located at the intersection of two arterial streets. Parking is located between the pads and the major stores with truck access and loading in the rear. A bus stop is located on the arterial in front of the center, adjacent to the bank.

### Pedestrian and Transit Treatments

The location of the drive-through restaurant and the drive-through bank would prevent moving the main buildings closer to the arterial street served by transit. With a conventional site design, pedestrians would have to walk across the driveways to the bank and restaurant as well as through the parking lot.

In this design, the pads are brought forward to the street to create pedestrian-oriented corners. Pads in these locations, provide anchors and focal points for the walkways, create small plazas, and can offer weather protection to pedestrians.

Another major feature is the main entrance which functions like a regular street. Landscaped sidewalks along both sides provide clear, safe and convenient access from the bus stop

through the parking lot to the stores. These walkways are at least 12-16 feet wide, with trees, landscaping, and lighting, and they can easily accommodate the needs of disabled patrons.

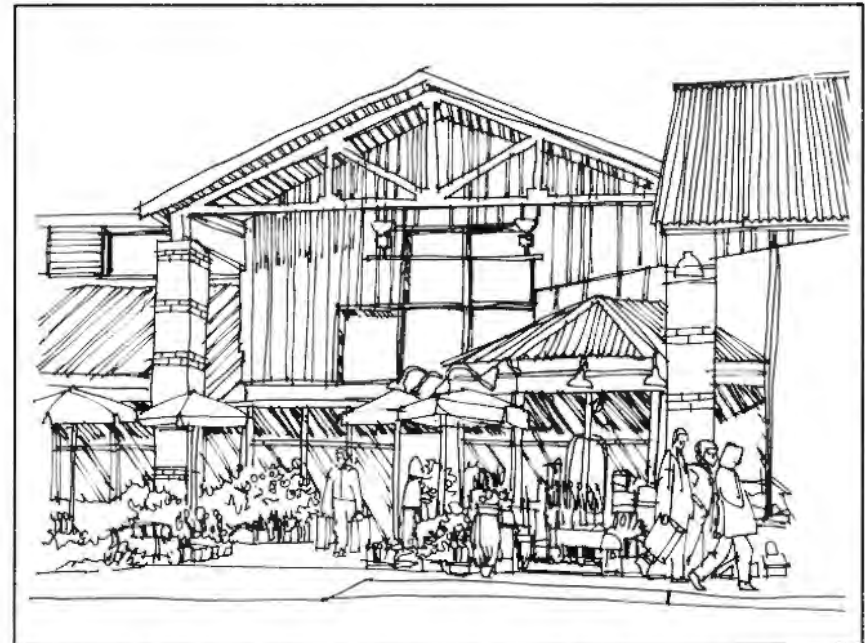

*Displays, signs, retail features, and outdoor seating areas combined with wide storefront walkways are crucial design elements in pedestrian-friendly developments.*

## Shopping Center #2: Neighborhood Strip Center With Standards

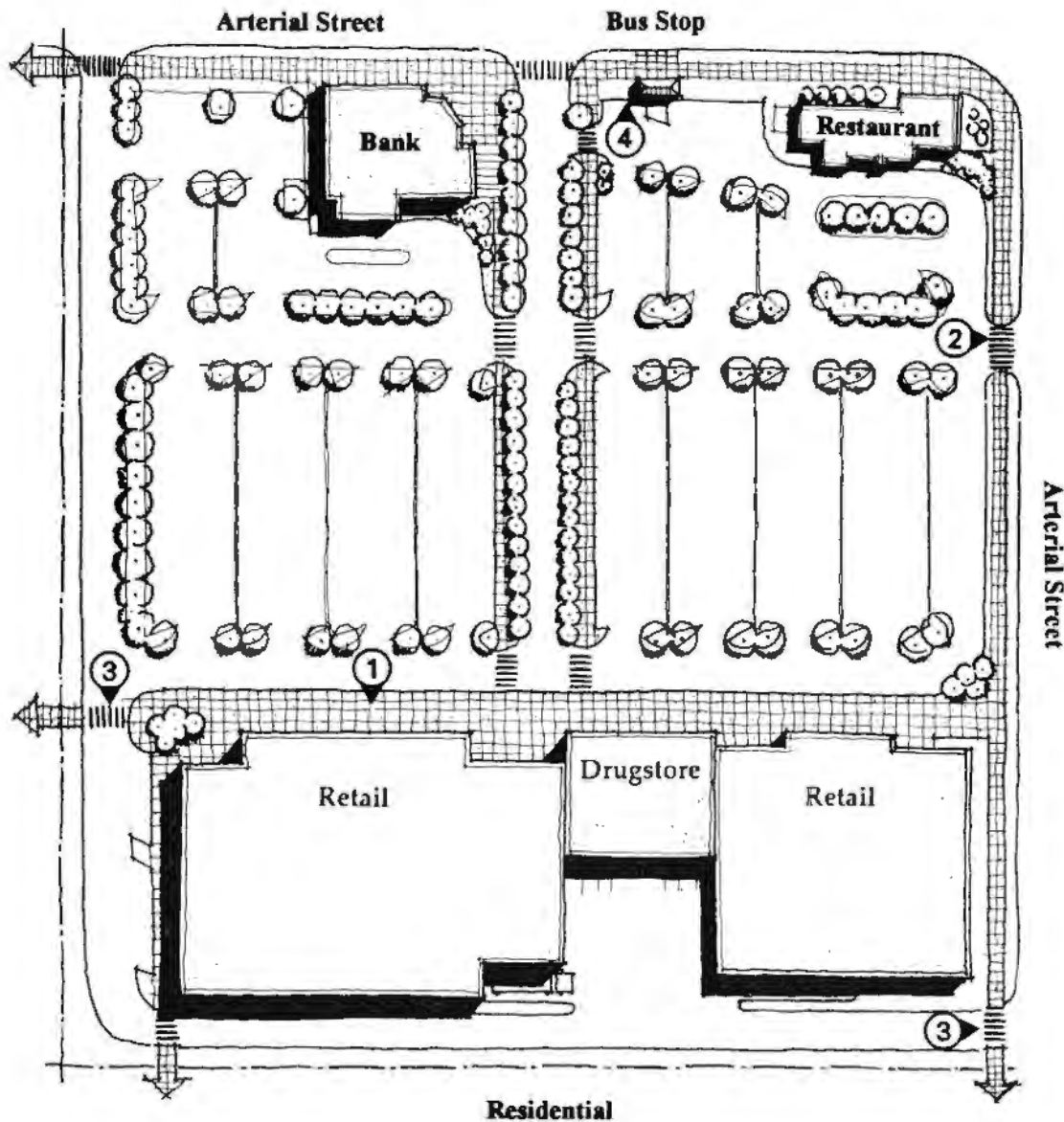

### Transit-Compatible Features:

1. A wide, safe walkway in front of stores (16 feet minimum, 20 feet preferred).
2. Driveways located away from the front of stores to minimize conflicts between patrons and cars.
3. Pedestrian connections to surrounding properties and sidewalks.
4. An attractive bus shelter adjacent to the main entrance walkways.

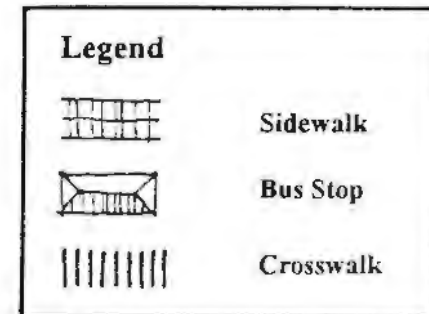

## Shopping Center #3: L-Shaped Neighborhood Shopping Center

### Description of Shopping Center

This shopping center has been designed to take advantage of its location by orienting the buildings to three abutting streets. It contains a large grocery store, four retail stores and three pad sites. In front of the shopping center, a drive-through restaurant and a retail space are oriented to an arterial street with a bus stop. Two shops are located behind the center and are oriented to the intersection of an arterial and a collector street with a bus stop. The loading area for the grocery store is located to its rear, sharing a driveway with retail shops.

### Pedestrian and Transit Treatments

A conventionally designed L-shaped shopping center usually does not provide convenient pedestrian access through the corner from the back of the center. Instead, the pedestrian must walk all the way around the end of the shopping center which doubles or triples the length of the walk. This is not only inconvenient, it discourages walking.

This shopping center provides a covered pedestrian walkway between the buildings to allow convenient pedestrian access to stores from adjacent activities. In addition, the rear pad site makes this corner of the shopping center more safe and attractive for pedestrians.

The two pads in front create pedestrian-oriented corners: one at the intersection of the two arterial streets and the other at the intersection of the local street and the arterial. The pads create small plazas and offer weather protection to pedestrians. A major design feature is a landscaped central

walkway through the parking lot. This walkway is at least 12-16 feet wide, with area for trees and lighting, and it can easily accommodate disabled patrons.

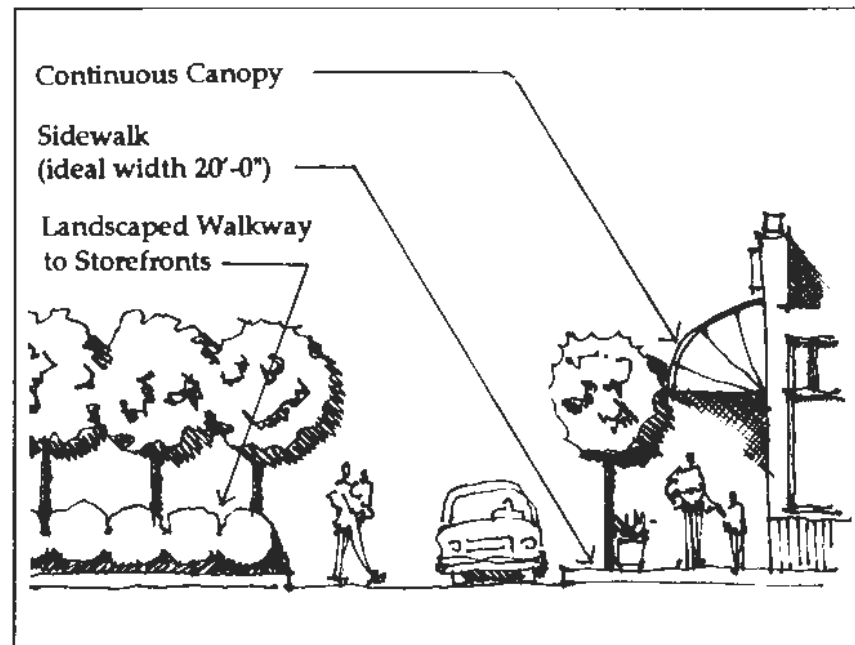

*Canopies provide weather protection, visual unity along storefronts, and identity for retail developments.*

## Shopping Center #3: L-Shaped Neighborhood Shopping Center

### Transit-Compatible Features:

1. A wide, safe walkway in front of stores (16 feet minimum, 20 feet preferred).
2. Driveways located away from fronts of stores to minimize conflicts between pedestrians and cars.
3. Safe internal pedestrian access and circulation with connections to surrounding properties.
4. Canopies in front of stores offer weather protection to the patrons.

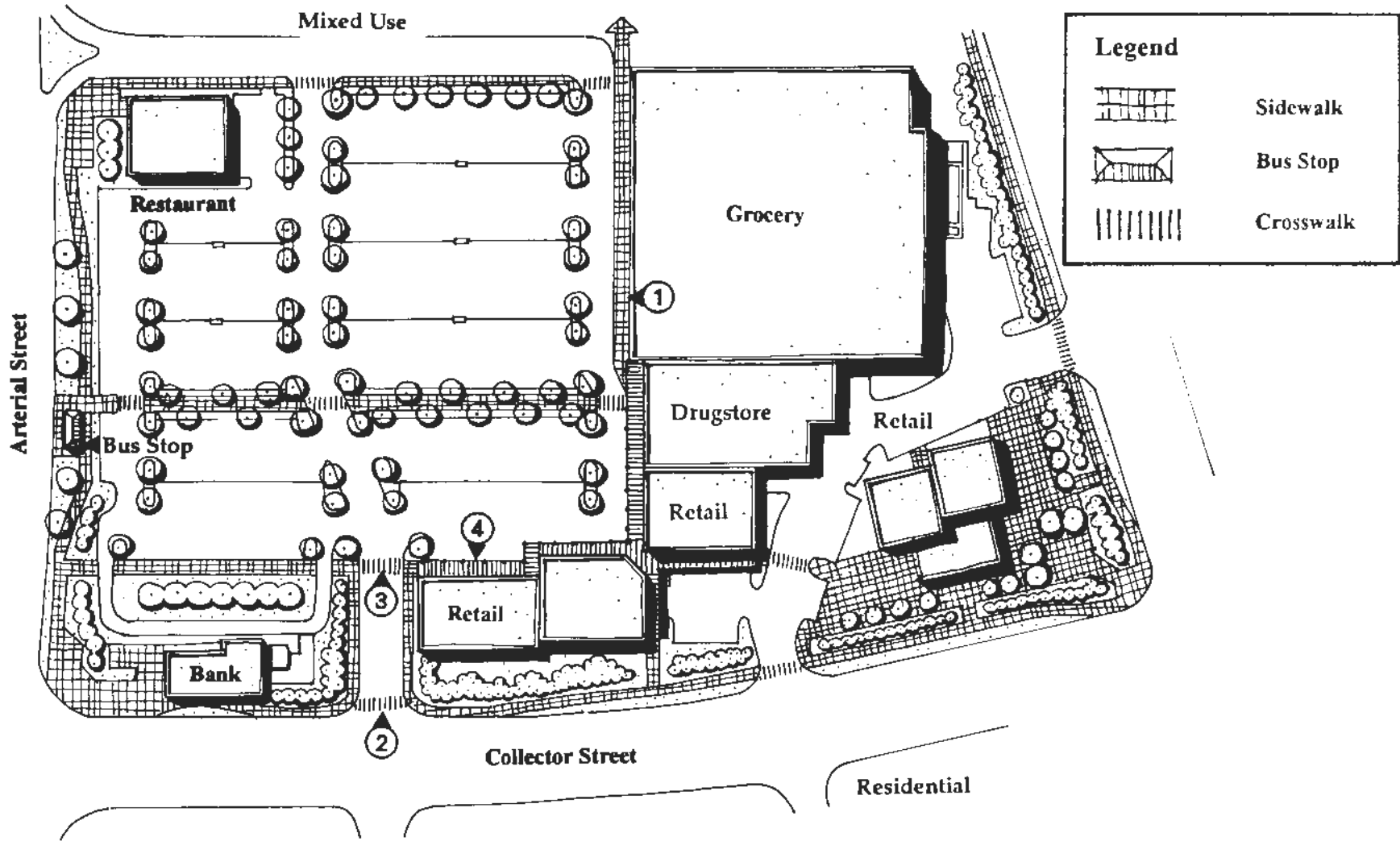

## Shopping Center #4: Neighborhood Center

### Description of Shopping Center

This shopping center functions as more than just a shopping center. By the mixture of uses and strong links to surrounding neighborhoods, it has become a neighborhood center. It features a grocery store with retail stores in three separate buildings surrounding a central parking area. There are three pads: A three-story office building, a day care center, and a building for small shops at the front of the center. An arterial street runs in front of the shopping center, and a bus stop is located adjacent to the shops on the street. The stores and offices share common parking since the times for use of parking vary. The service road behind the main buildings provides access to employee parking and truck loading areas.

### Pedestrian and Transit Treatment

The shopping center is oriented to the street with the transit stop and to adjacent activities. The design allows easy auto and pedestrian access to all parts of the shopping center. There is convenient pedestrian access to the center from adjacent activities (including neighboring apartments), as well as from the transit stop and the sidewalk along the street. There is a complete walkway network that does not hamper auto circulation or parking.

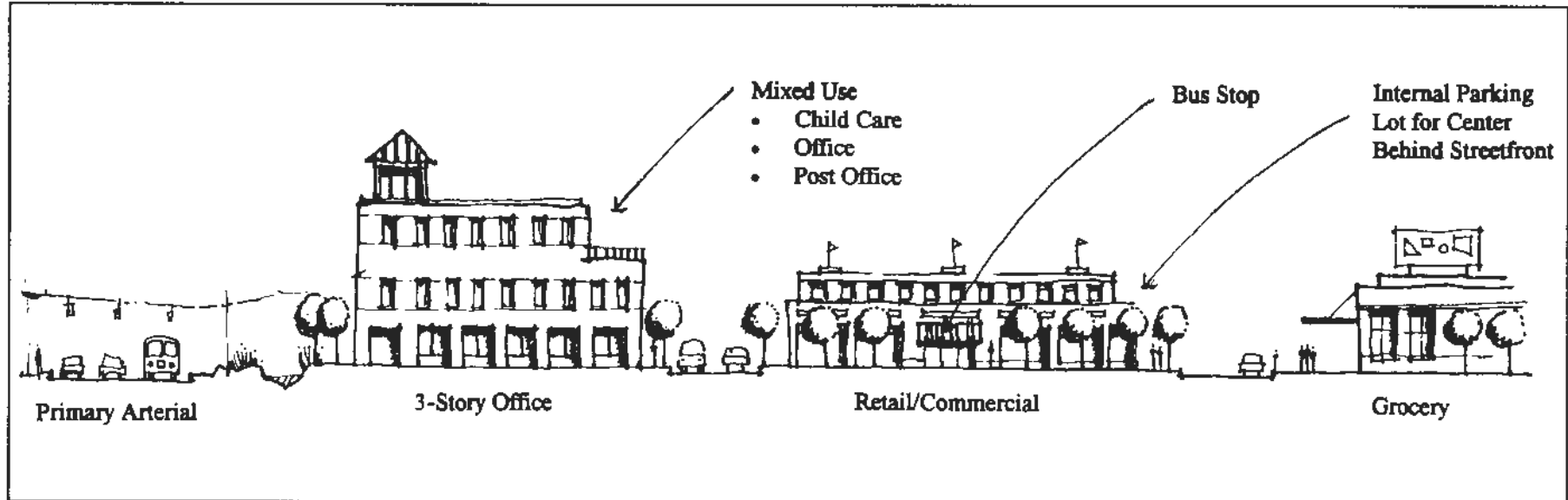

Street Elevation of Neighborhood Center (front view).

## Shopping Center #4: Neighborhood Center

### Transit-Compatible Features:

1. Canopies offer pedestrian protection from the weather.
2. A mixture of uses including retail, office, bank, day care, grocery. Residential is adjacent.
3. Several pedestrian plazas.
4. A wide, safe walkway in front of stores (16 feet minimum, 20 feet preferred).

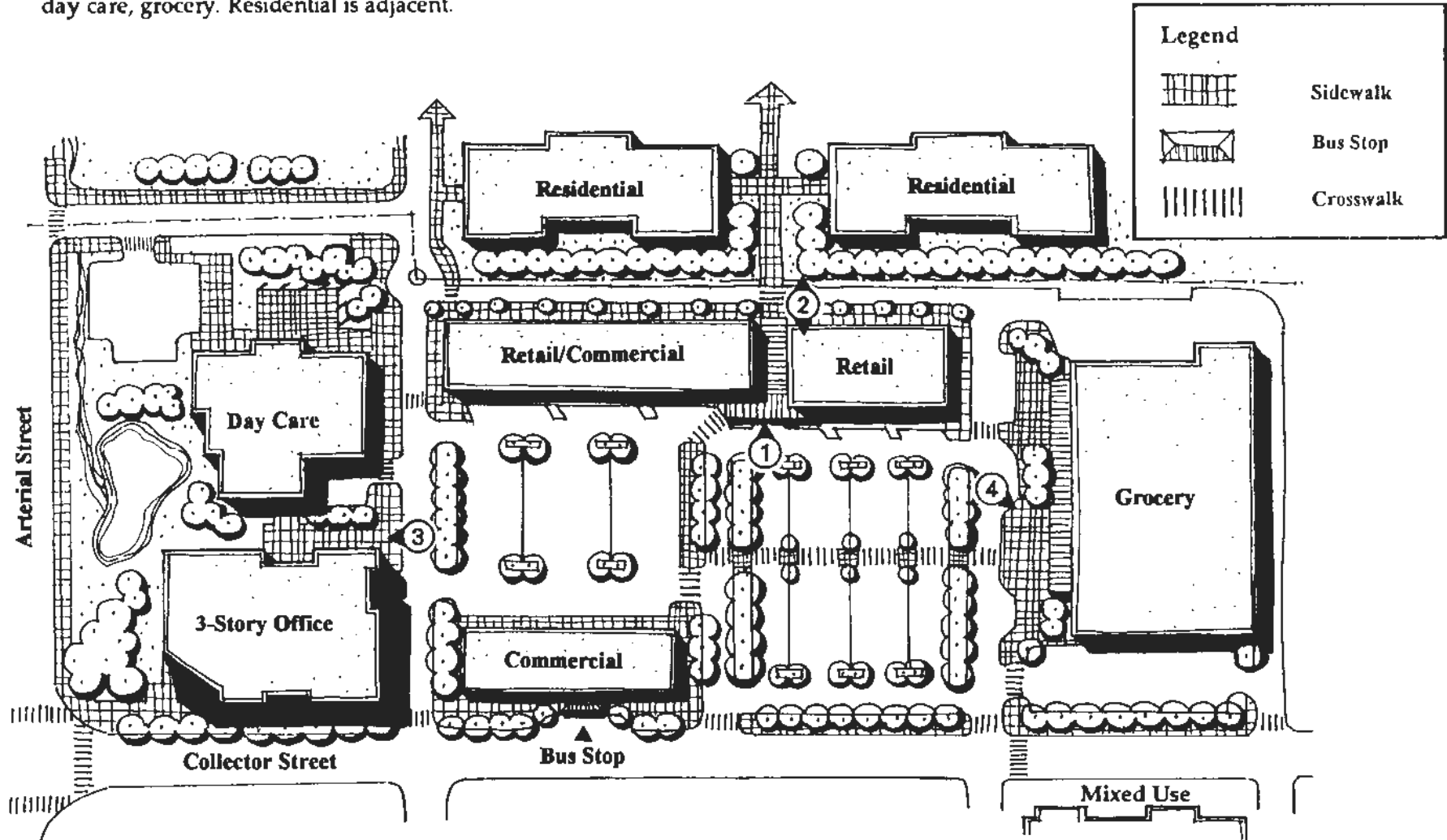

## ***Chapter 4: Redesign of a Strip Commercial Area***

---

- Introduction***
  - Current Conditions: Typical Strip Commercial Area***
  - Phase I: First Five Years - Street and Parking Improvements***
  - Phase II: Second Five Years - Transit and Walkway Improvements***
  - Phase III: Third Five Years - Major Redevelopment***
  - Final: A Neighborhood Center***
- 





## ***Introduction***

*Besides being notorious for traffic problems, strip commercial areas typically present problems for pedestrians and transit patrons.*

Since the automobile era began in the 1940's, the main roads of cities and suburbs have seen a common pattern of development: Bit by bit, gas stations, auto sales lots, mini-malls, warehouses, and office buildings have filled in along the road edges, bringing large asphalt parking lots, a clutter of signs, and a high-speed environment neither safe nor comfortable for the pedestrian. These strip commercial areas are strictly the domain of the car, lacking greenery, places for people to walk or sit, and curbs and sidewalks.

Besides being notorious for traffic problems, strip commercial areas present problems for pedestrians and transit patrons. Some examples include:

- No safe places to walk along streets, especially for young, elderly, or disabled people;
- Conflicts between pedestrians and cars;
- Unpleasant bus stops with poor access;
- Hazardous corners and street crossings;
- Hazardous routes to entrances of buildings; and
- Long walking distances between activities.

This chapter will illustrate how a typical strip commercial area can be changed into a pedestrian and transit-friendly shopping area. The changes are shown in three five-year phases. The illustrations include maps showing improvements from the prior phase in lighter tone, with the current phase improvements in bold. Perspective drawings focus on the key changes and improved elements in each phase.

*This chapter will illustrate how a typical strip commercial area can be changed into a pedestrian and transit-friendly shopping area.*

## Current Conditions: Typical Strip Commercial Area

The area is centered on the intersection of a major arterial and a local street. The development pattern is typical of strip commercial areas, consisting of commercial businesses with parking located in front of the buildings, a large grocery store in a strip mall with a large parking lot in front, vacant land, small-scale auto dealerships, and gas stations.

Much of the parking is located on the public right-of-way, and cars have uncontrolled access to parking areas from the arterial street. There are short sidewalk segments along the arterial street and part of the local street, a marked crosswalk at the signalized intersection, and two bus stops with small shelters on either side of the arterial street.

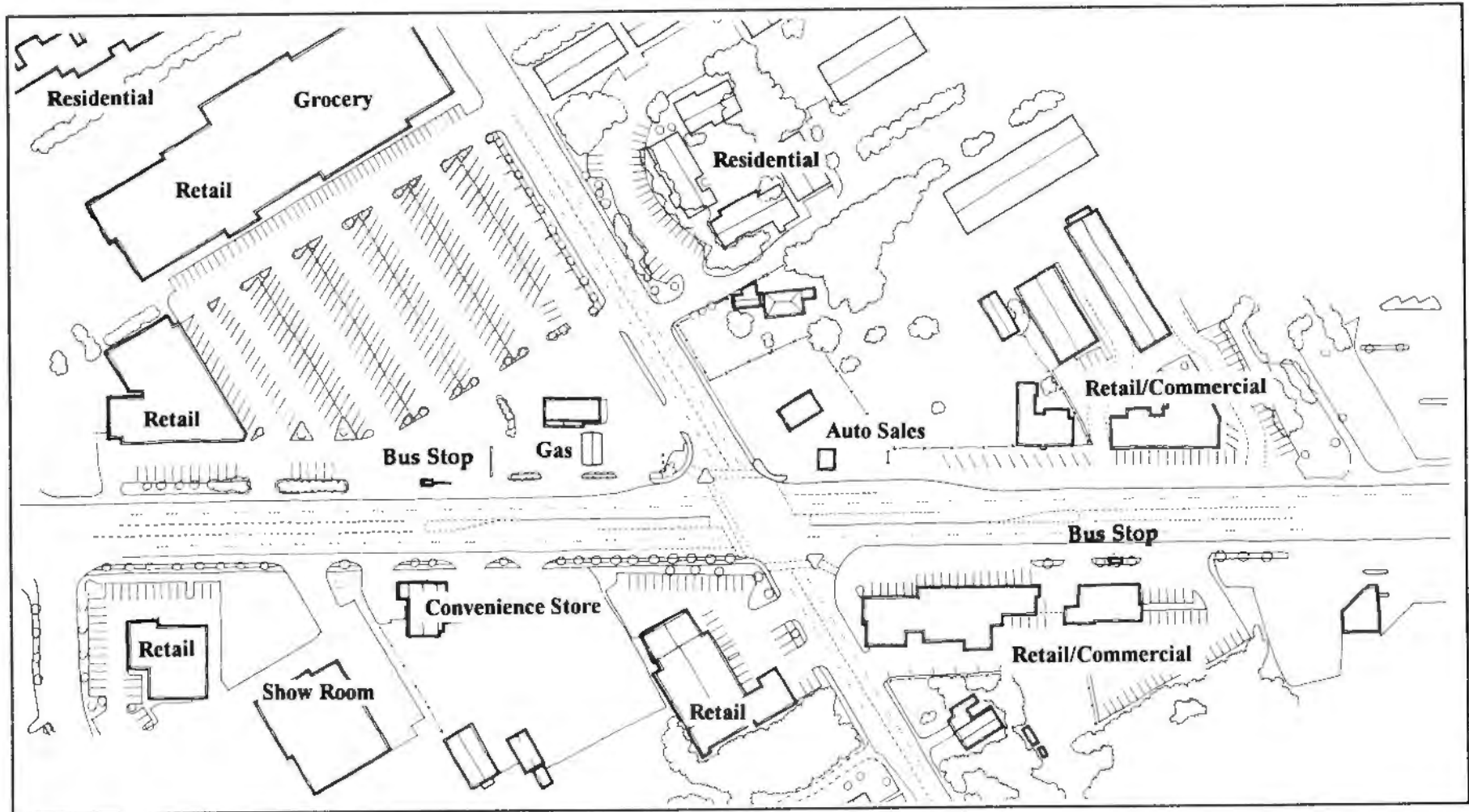

## Current Conditions: Typical Strip Commercial Area

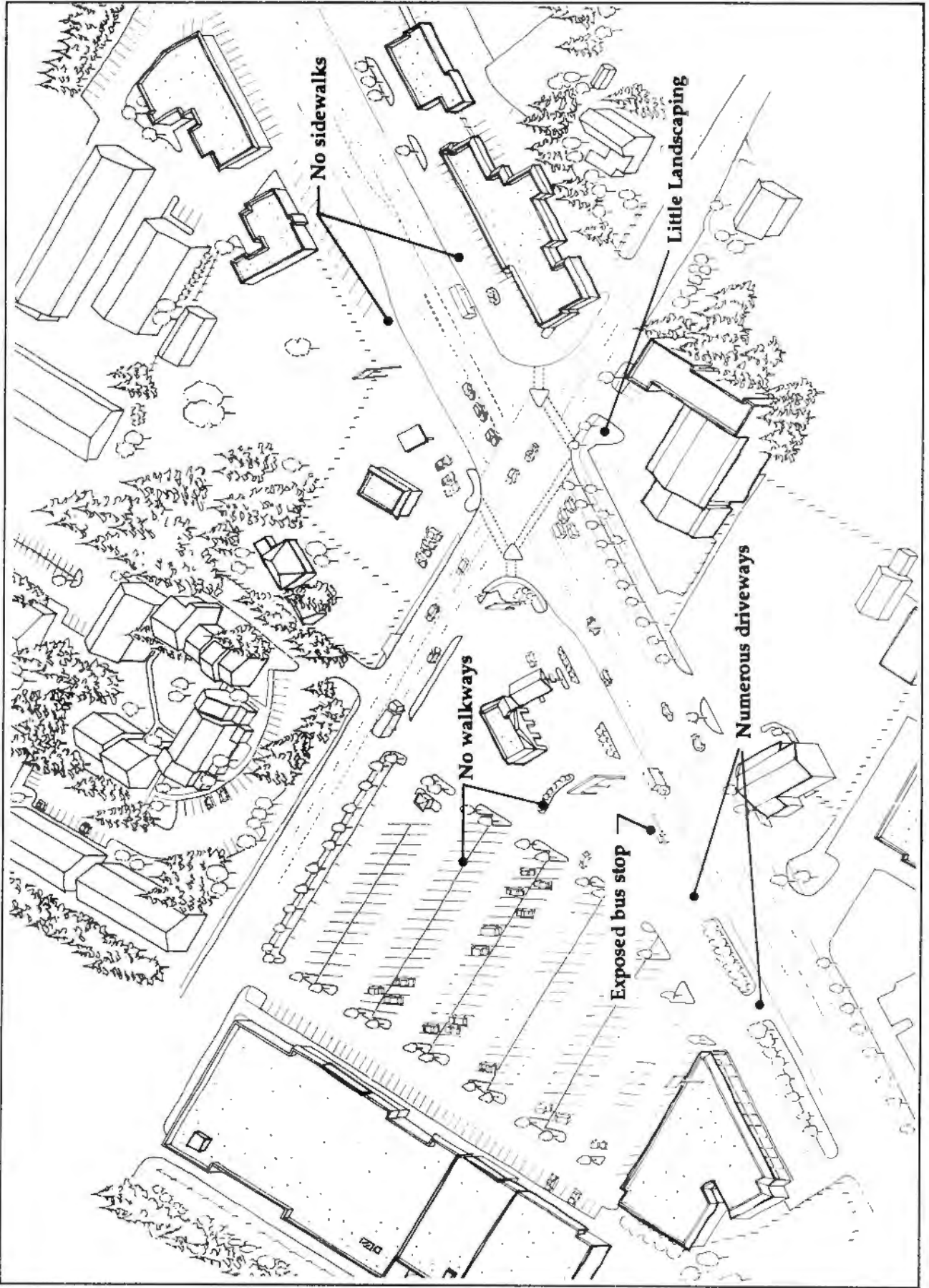

## Phase I: First Five Years

At the end of the first five-year period, the city has completed the following improvements:

- Installed sidewalks and lighting throughout the area;
- Improved the pedestrian crossings at intersections;
- Consolidated a number of driveways;
- Planted landscaping including street trees; and
- Eliminated parking in the public rights-of-way.

The business and property owners have concentrated on these improvements:

- Awnings, entrances, facades, signs, and lighting improvements;
- New landscaping;
- New parking areas; and
- On-site walkways to conform to the Americans with Disabilities Act.

The transit agency has moved its bus stops to better locations, and has increased the bus service along the arterial street.

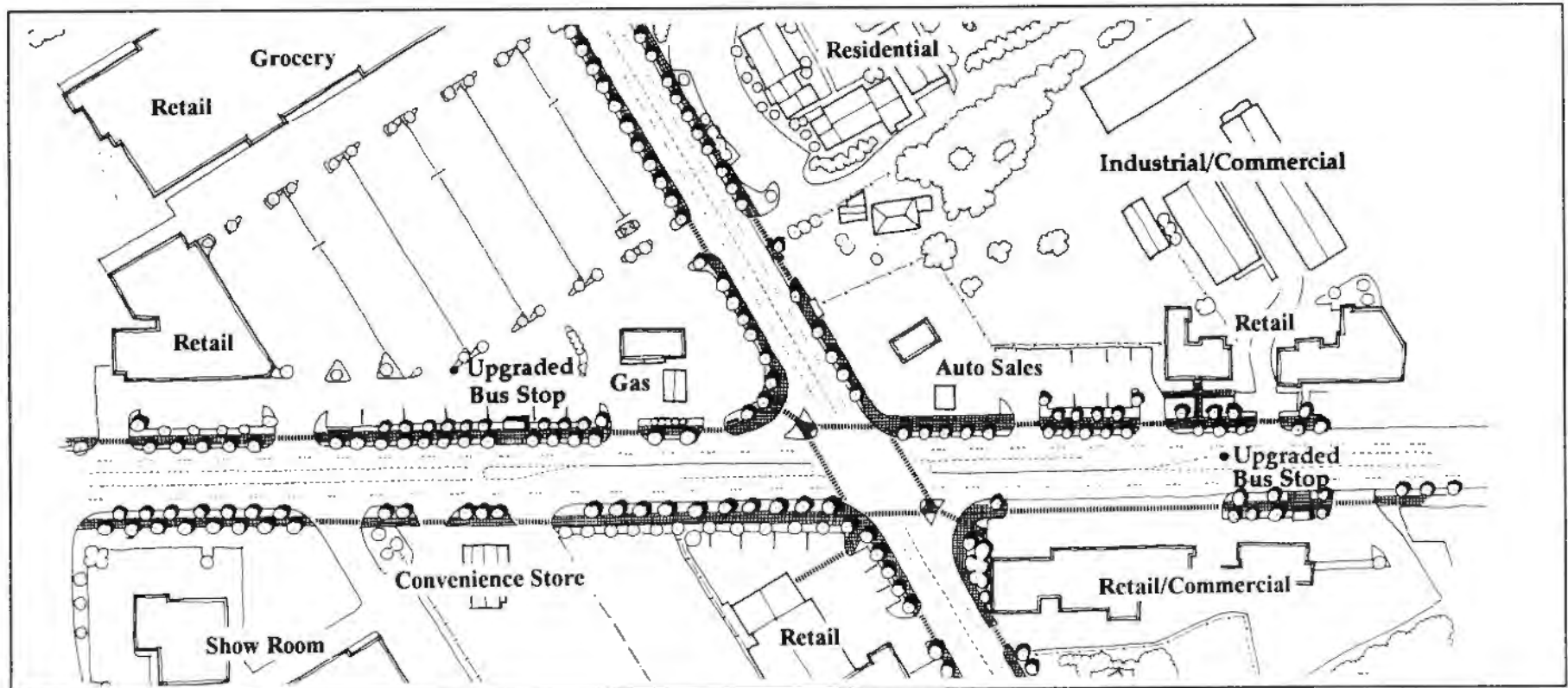

# Phase I: First Five Years - Street and Parking Improvements

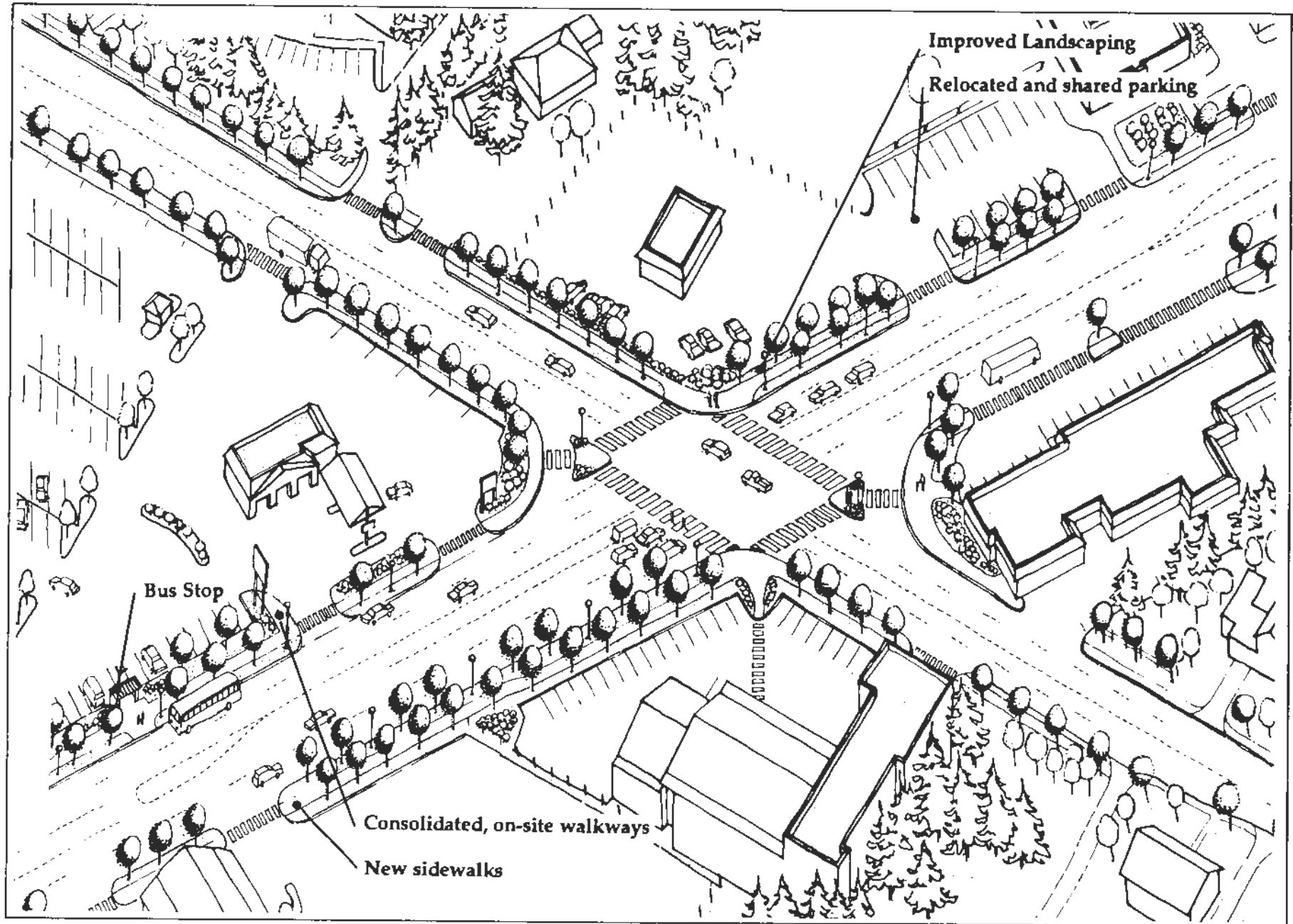



## Phase II: Second Five Years

At the end of the second five-year period, the city has improved the arterial street to five lanes, including curb and gutter, and has consolidated driveways.

The public improvements have renewed interest in the area and land values have increased. New businesses have opened in existing buildings, and new commercial buildings have replaced older buildings and vacant land. The northeast corner, originally a service/gas station, has been

redeveloped into a new building that has a restaurant, retail spaces and a gas station. The new building has several small pedestrian plazas, a courtyard adjacent to the sidewalk, and a new bus stop. This development anchors the corner for the pedestrian and connects to a new landscaped walkway. The walkway continues through the parking lot to the entrances of the stores in the shopping center. Parking for this new development is shared with the shopping center, since the spaces at the west end of the lot were never occupied.

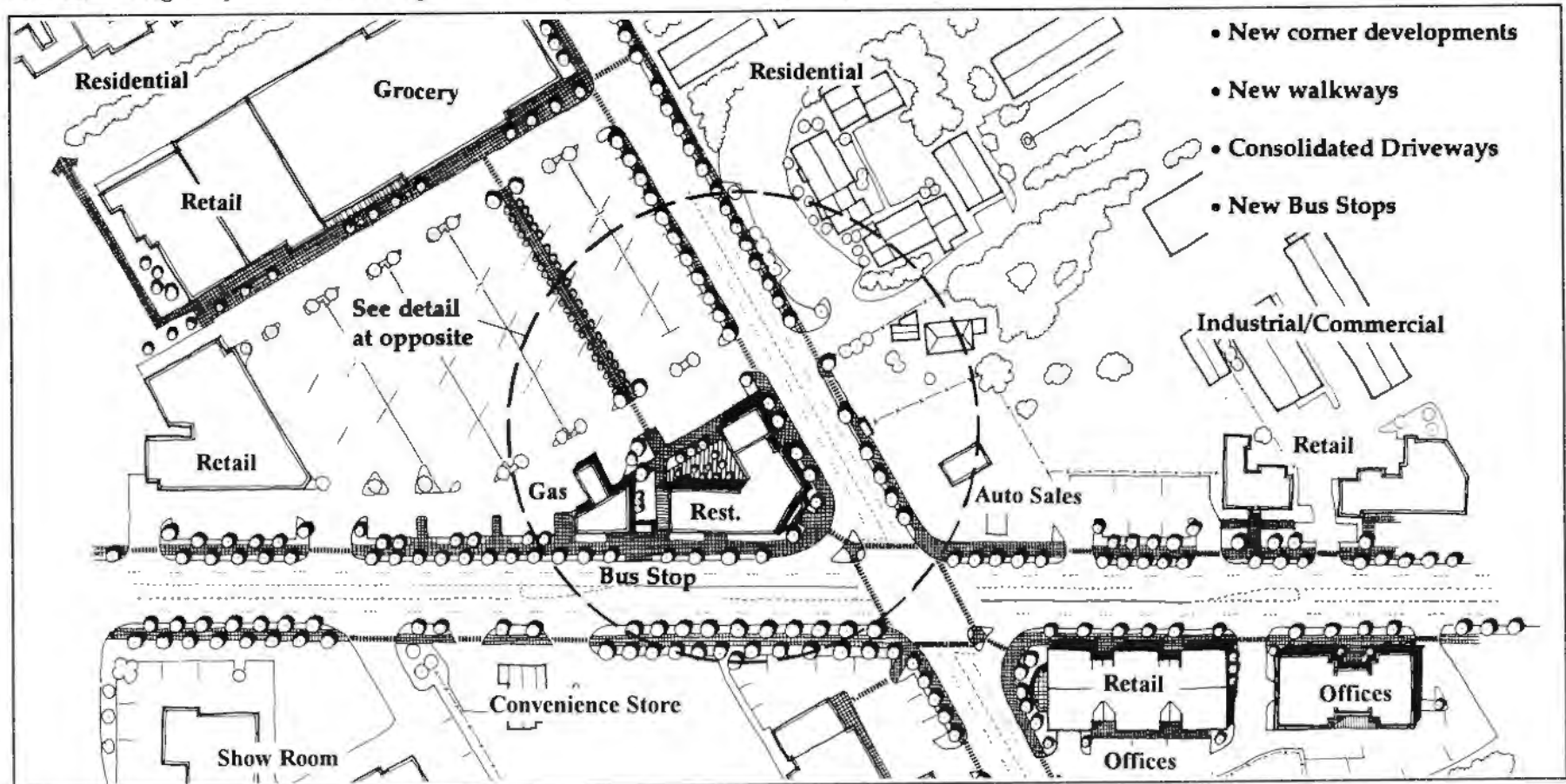

## Phase II: Second Five Years - Transit and Walkway Improvements

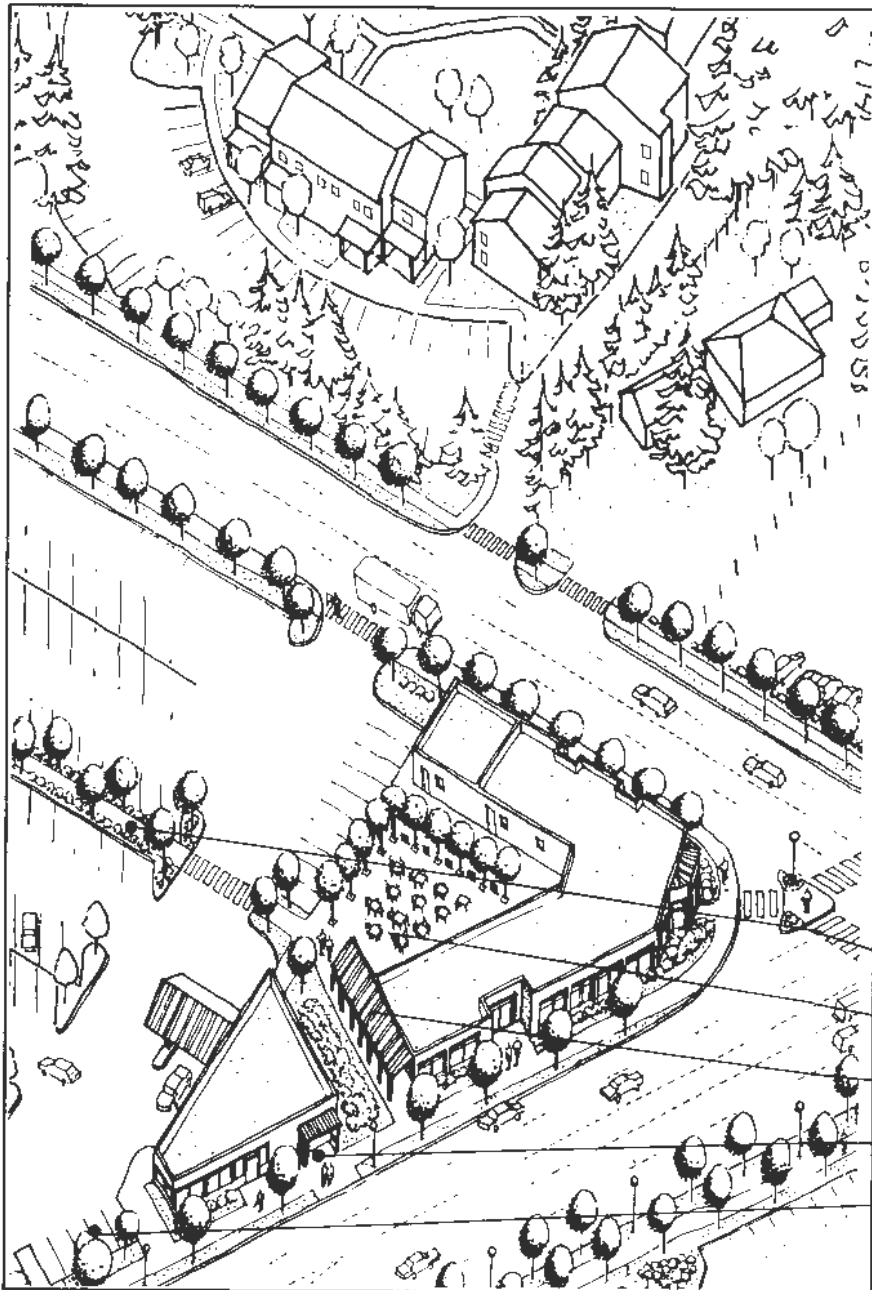

A new two-story office with parking underneath, along with a new commercial building with rear parking, has replaced an old one-story retail building at the southwest corner of the intersection. A small pedestrian plaza facing the intersection has been integrated into this development.

In this phase, the city and developers have focused on making the following improvements:

- Bringing new businesses into existing buildings;
- Relocating and reducing parking; and
- Creating internal walkways within and between properties, and improving access from adjacent neighborhoods.

The transit agency has upgraded the bus stops to provide larger, safer, and more attractive waiting areas to serve new development on either side of the arterial street. The transit agency has added more bus service, both for local trips and longer distance commuter service to activity centers. In addition, 20 park-and-ride parking spaces have been established in the shopping center parking lot adjacent to the bus stop on the east side of the arterial street.

- Landscaped Walkway to Storefronts
- Courtyard
- Covered Walkway
- Upgraded Bus Stop
- Park-and-Ride Spaces

## Phase III: Third Five Years

The city has improved the local side street by adding curbs and gutters. The transit agency has further improved bus services.

Several new developments have been built, and several additions have been made to the existing buildings. A two story apartment project has been developed along the west

side of the arterial street. On the southeast corner, a new mixed-use complex in a two-story building features underground parking, a courtyard, and an office and community-center building in the rear. The community-center houses a senior-center, day-care center, community meeting rooms and social service offices.

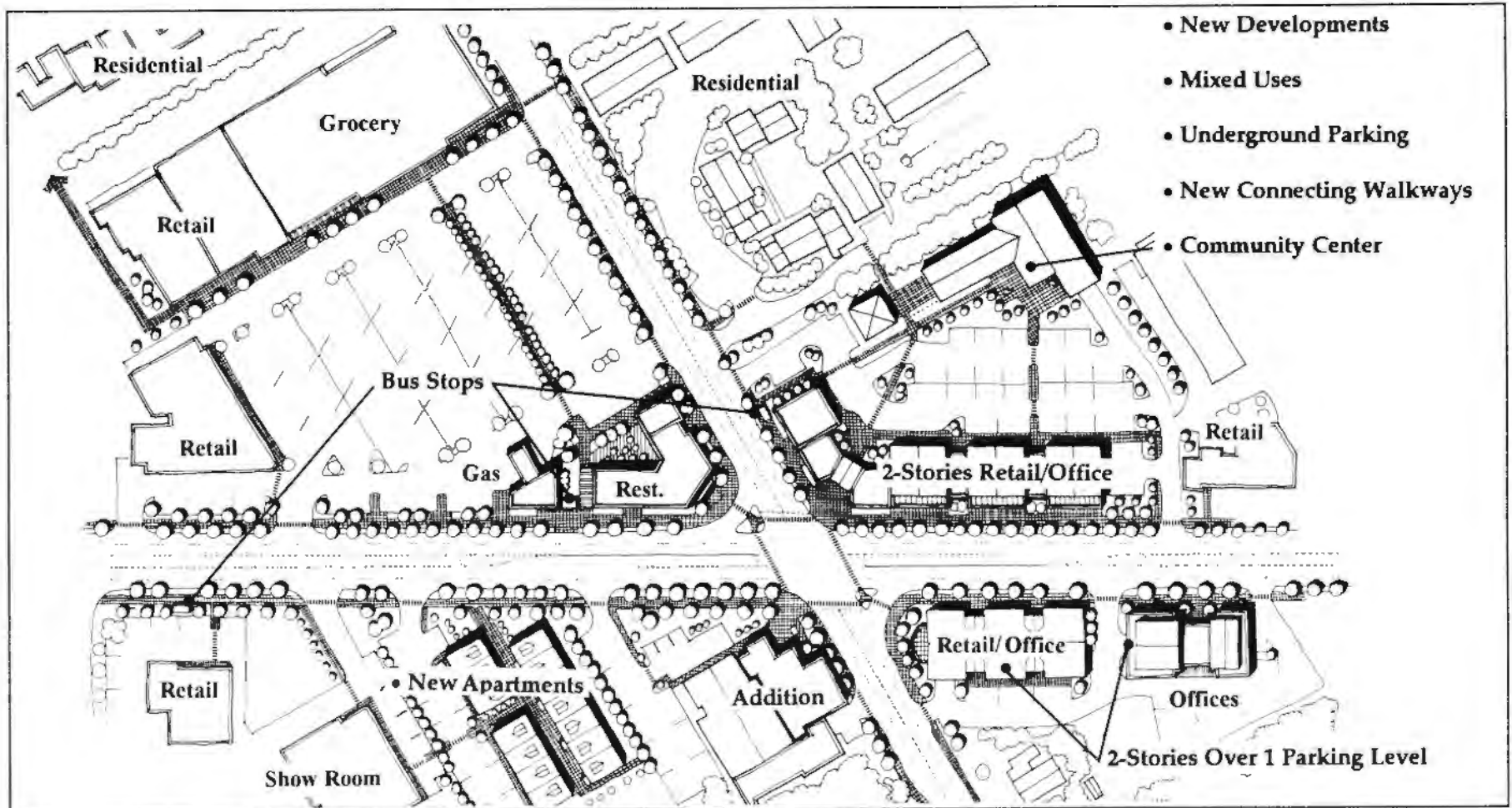



## Phase III: Third Five Years - Major Redevelopment

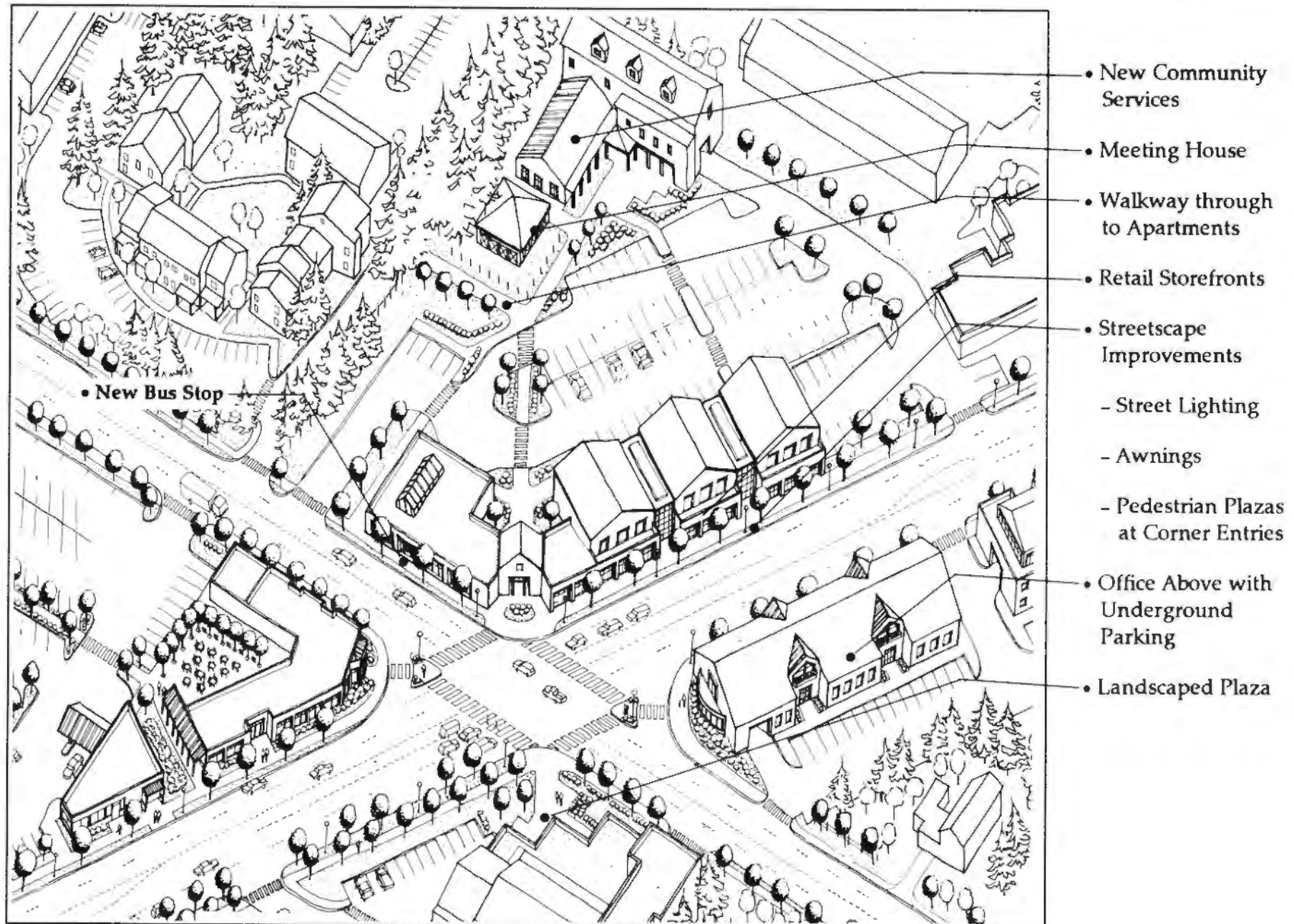

## Start: A Strip-Commercial Area

By improving the access from the neighborhoods, businesses have developed new markets for neighborhood retail and commercial services. Small retail and service activities

gravitate to and concentrate at the intersection, creating an attractive area similar in appearance and function to the older "streetcar communities."

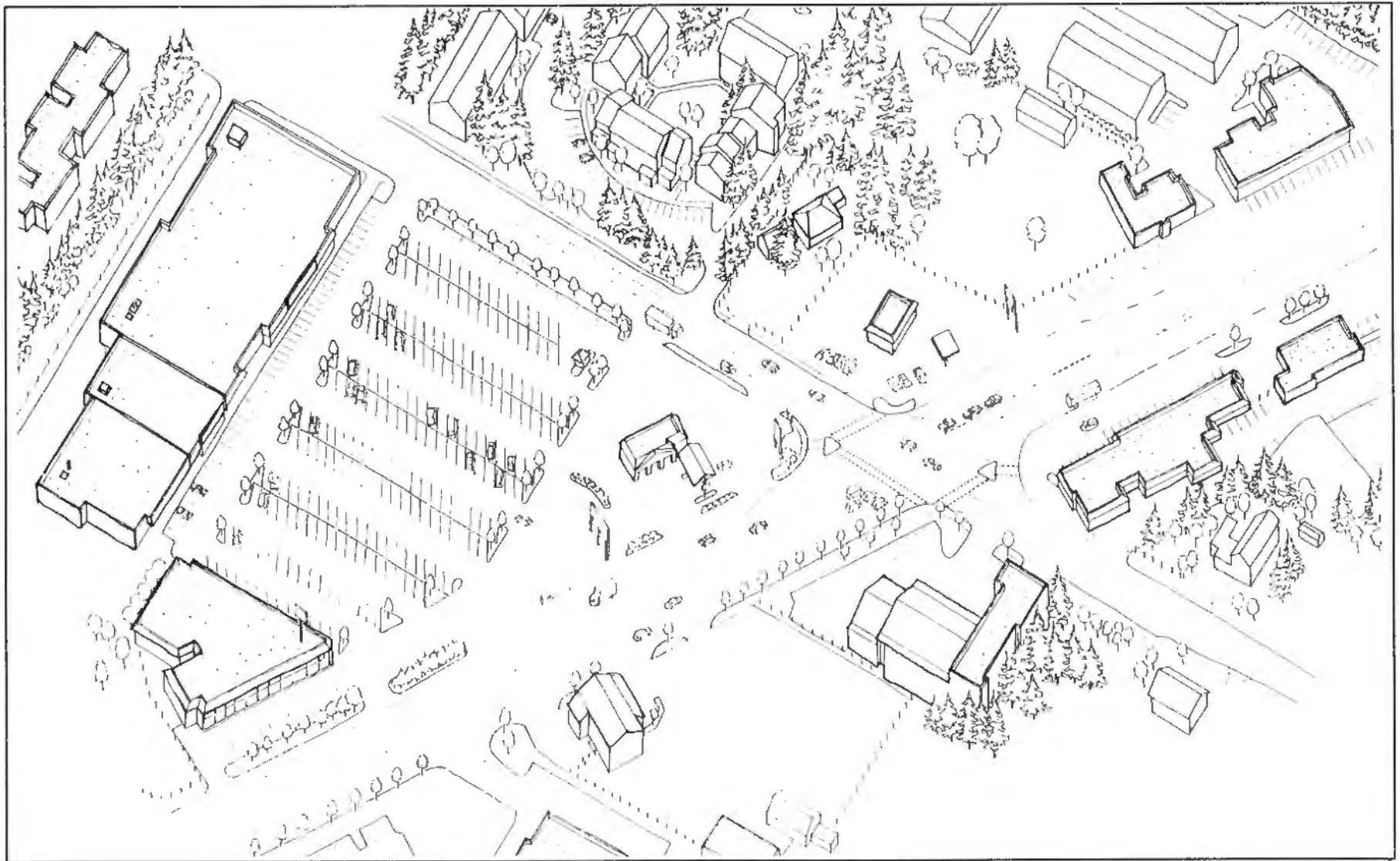

## ***Final: A Neighborhood Center***

The strip commercial area, shown below, has evolved into a mixed-use neighborhood center where people can easily and safely walk, cross streets, and get to neighborhood businesses.

Residents of nearby neighborhoods have easy access to businesses, and transit patrons can safely walk to bus stops, where they have a short wait in a pleasant environment.

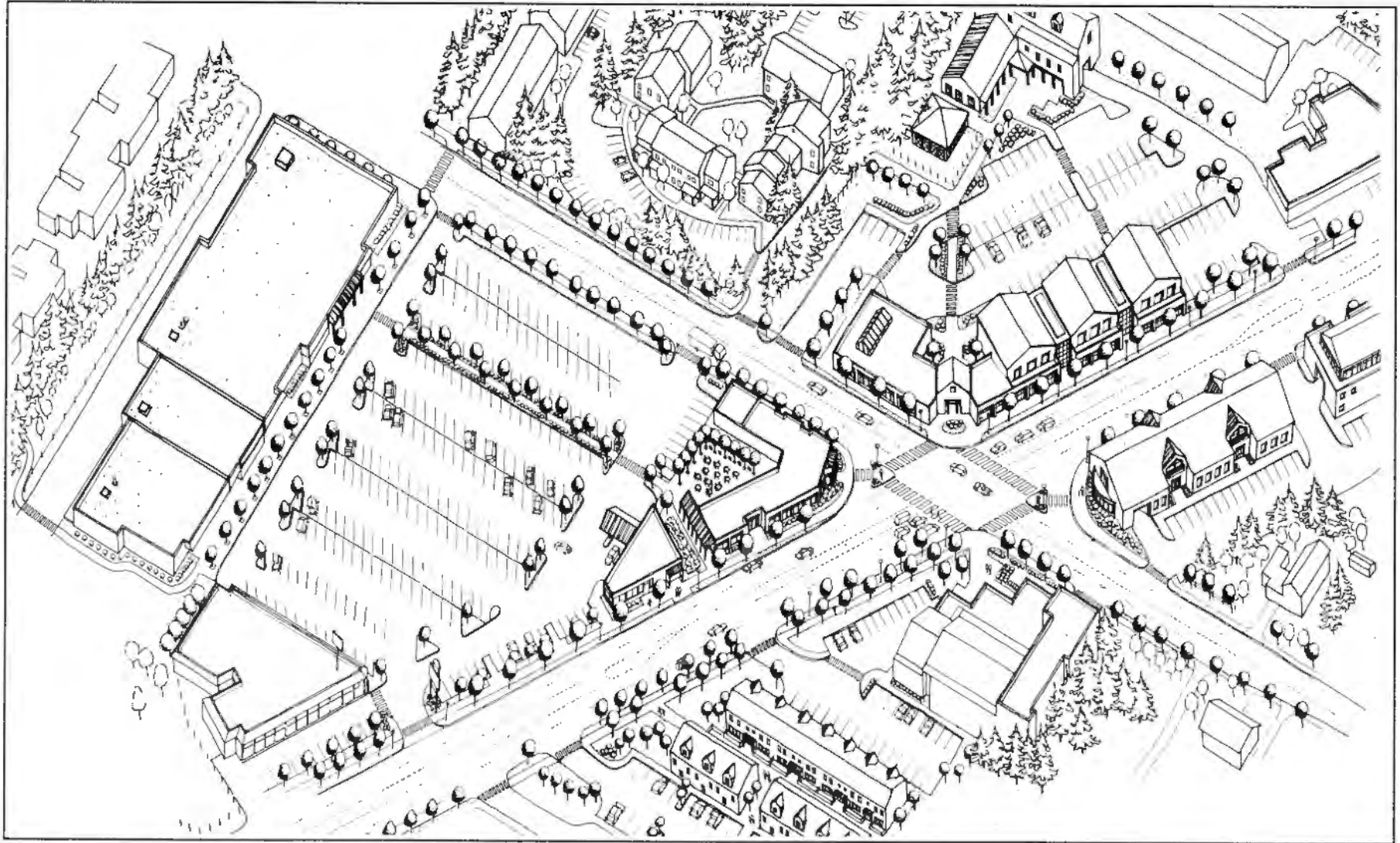

## ***Final: A Neighborhood Center***

---

### ***Assumptions***

The following assumptions were made about this exercise:

1. Redevelopment will be accomplished by property owners without major public redevelopment programs.
2. The city will change its zoning ordinance to allow development to become pedestrian and transit-friendly. The changes will reduce the amount of required parking near transit stops, allow flexibility in site design, encourage pedestrian and transit-friendly design, and permit new activities at greater densities along with a mixture of uses.
3. Activities will change and intensify over time as the value of the land increases and the current improvements become obsolete and depreciated. New office buildings, mixed use developments and higher-density residential developments will be attracted to the area.
4. The industrial and wholesale outlets, auto dealers, and similar large uses will gravitate to mid-block areas.
5. In many cases, small lots will have to be consolidated into larger parcels for redevelopment to be successful.
6. Businesses along the arterial that have been using public right-of-way for their parking without paying for that use (which is a violation of the State Constitution) will move their parking onto their property.

## ***Chapter 5: Mixed Use***

---

- Introduction***
  - Mixed Use Examples***
  - A Mixed Use Checklist***
  - Overcoming Institutional Obstacles to Mixed Use Projects***
  - Conclusion***
- 



## Introduction: Mixed Use Is...

### **An Old Idea**

An easy walk from the office to a nearby deli. A Saturday morning stroll to the neighborhood park with a stopover at the corner bakery. A single after-work stop to pick up the kids, drop off the cleaning, and shop for a few grocery items. Simple conveniences like these are possible where housing, shopping, work places, and recreation are "mixed," or arranged so that people can walk between them. *Mixed use*, as urban planners call such arrangements, would seem to be a common sense approach to community planning, and in fact it was the norm in communities designed in the "pre-auto" era. But over the past 50 years, the arrangement and design of land uses has been increasingly scaled to driving: housing, work, shopping, and recreation are now scattered miles apart, and even when located near one another, these basic daily activities are carefully "buffered" from one another with walls and landscaping that make it difficult to walk between them.

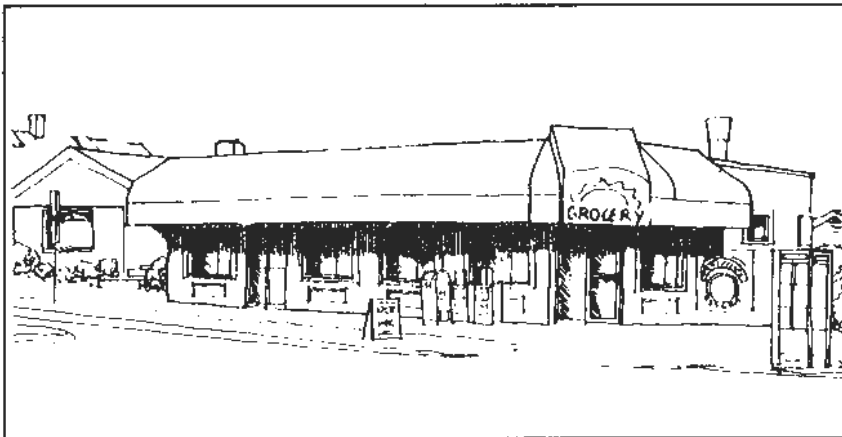

*A neighborhood store is an example of what planners call "mixed use."*

*Today, with traffic congestion putting the brakes on mobility, community planners and developers are rediscovering "mixed use" as a way to promote walking, cycling, and using transit.*

### **A New Idea**

Today, with traffic congestion putting the brakes on mobility, community planners and developers are rediscovering mixed use as a way to promote walking, cycling, and using transit. Even in the suburbs, people are beginning to see that segregated land uses not only limit their transportation options, but preclude the daily, human interactions that make a community a *community*. In the planning profession, mixed use and pedestrian-scaled design are now "in," segregated use and automobile-scaled design "out."

Acceptance of mixed use by professional planners will not, however, easily overcome a segregated land use policy institutionalized over several decades. Zoning and other regulatory road blocks to mixed use are firmly in place in most communities, and developers wishing to build mixed use projects must often convince conservative lending institutions that this "new" approach will sell. Equally important, citizens and local elected officials must be convinced that sound site planning and architectural design can alleviate their concerns about the "compatibility" of different land uses.



## Introduction

### A Simple Idea

A clear understanding of the basic elements of mixed use is a first step toward overcoming these obstacles. Many people think mixed use must take the form of the classic apartment over the store, or that it must include two different uses simultaneously developed on one parcel of land. But when broken down into three essential criteria, mixed use can fit into just about any setting or regulatory environment. These basic criteria are:

**1** **Complementary Land Uses**

When people frequently go from one use to another, the uses are *complementary* (a neighborhood and a store, for example).

**2** **Within Convenient Walking Distance of Each Other**

The closer together, the more mixed two activities are. (For most, a "convenient" walk is a quarter mile or less.)

**3** **Connected by Safe, Direct Walkways**

Two activities are only mixed when they are connected by safe and reasonably direct walkways.

Under these criteria, mixed use is simply a matter of planning and building on a *pedestrian scale*. It doesn't require that apartment buildings have retail shops on the ground floor (although this arrangement has community benefits beyond the scope of this chapter); it simply requires that as planners and developers go about the business of distributing land uses, they consider the fact that many people will walk to take care of some their daily business *if given the opportunity*.

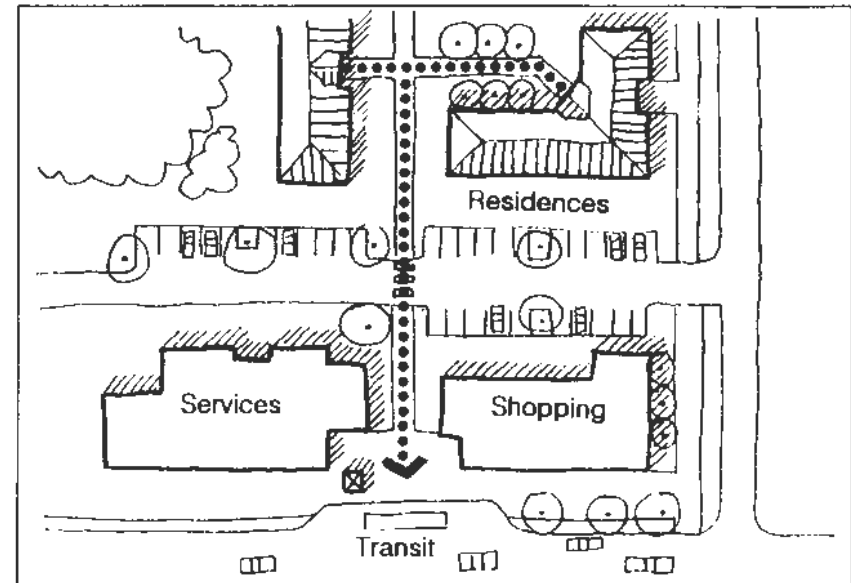

*Mixed use means making it possible for people to walk to and from the places they frequently go.*

### Benefits of Mixed Use

■ **Transportation Options and Efficiency**

Mixed use is essential to creating communities in which people have transportation options other than driving. The choice between taking your car or taking a bus or a carpool often hinges on whether you can walk from work to the bank or a restaurant. Likewise, having a grocery store or a park within walking distance of home means you don't always have to drive to accomplish simple tasks like picking up a newspaper or taking the dog for a walk.

By concentrating activities, mixed use also helps make bus routes more productive. A variety of activities located near



## Introduction

one another makes it possible to plan routes that serve both commuters and people who do their business outside the a.m. and p.m. commuting hours, making sure buses are well utilized over the course of the day. In downtown Edmonds, Washington, for example, a Senior Center creates a demand for transit services that also serve shoppers and business people. With different activities clustered together, buses can serve more people with fewer stops.

### ■ Livability and Convenience

Mixed use means variety, both in the form of a place and in the experiences it has to offer. While the thought of a neighborhood store or a block of apartments can raise a homeowner's hackles, this is more a reaction to poor quality design than to the uses themselves. A nicely designed store can be a neighborhood focal point—the place where kids meet and neighbors chat over espresso. A well-designed duplex or apartment building can offer housing opportunities for young people or people with lower incomes, bringing diversity and vitality at no expense to neighborhood appearance. With offices and other workplaces nearby, a neighborhood remains active and secure throughout the day. Some residents may even be able to skip a time-consuming commute, raising the question of whether the payment on the second family car might be put to better use.

*Mixed use means variety, both in the form of a place and in the experiences it has to offer.*

### ■ Land Development and Business Advantages

Mixed use can actually help make a development project more feasible. A project with residential and commercial land uses need not rely on a single market. One part might be built first, generating money to build the next. In some cases parking can be shared, reducing costly and unsightly asphalt. Mixed use can also strengthen existing neighborhoods, especially those with marginal commercial uses. In Bothell's Meridian neighborhood, planners anticipate that new services and residences will strengthen the existing businesses.

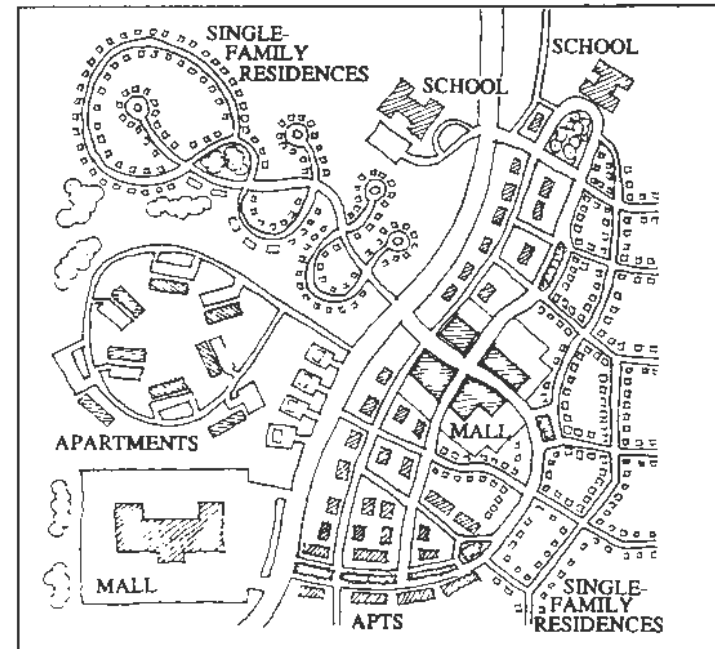

*A connected network of streets (right side of drawing) with sidewalks cuts walking distances between housing, shopping, work and school.*

*(Source: A. Duany/E. Plater-Zyberk)*

## Introduction

*Any community wishing to incorporate mixed use into its plans can find a suitable starting place among these examples. Together they offer a checklist of key features that make for successful mixed use planning and design.*

### ***In This Chapter***

This chapter offers twelve examples of mixed use situations from the Puget Sound region, ranging from a suburban neighborhood park to a downtown apartment tower with floors for offices and shops. Each example shows a variation of complementary uses within convenient walking distance of each other connected by safe, direct walkways (or, in a few cases, by elevators). Each case study also highlights a key feature of the mixed use example, such as an innovative technique for keeping parking out of the pedestrian's way or a design feature that helps make the different uses fit especially well together. Any community wishing to incorporate mixed use into its plans can find a suitable starting place among these examples. Together they offer a checklist of key features for successful mixed use planning and design.

The chapter also briefly explores the institutional obstacles to mixed use, especially those that make it difficult for a developer to build a mixed use building or site. Following the examples is a discussion of techniques for overcoming these obstacles based on successful mixed use projects in the Puget Sound area.

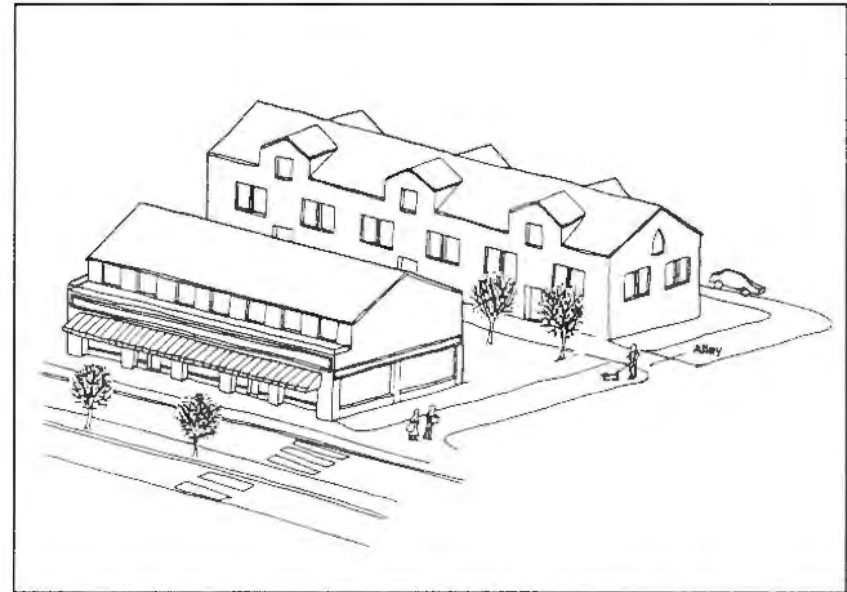

*Land uses are truly mixed only when complementary uses are linked by safe, direct, and inviting walkways.*

## Mixed Use Examples

---

**1. Wallingford Center  
Seattle, WA**

An historic, three-story school building converted to shops, restaurants, and apartments (page 5-6).

**2. Edmonds Town Center  
Edmonds, WA**

A small city center with a mix of housing, shopping, restaurants, recreation, and public services (page 5-8).

**3. Watermark Tower  
Seattle, WA**

A 22-story apartment and office building with ground floor retail shops (page 5-10).

**4. Library Park  
Mill Creek, WA**

A neighborhood park and library surrounded by apartments and town houses (page 5-12).

**5. Broadway Market  
Seattle, WA**

A 100,000 square foot specialty shop mall with cinemas, a discount store and apartments in the same building (page 5-14).

**6. Honey Bear Bakery  
Seattle, WA**

A small building with a bakery, deli, grocery, and offices in a traditional neighborhood center (page 5-16).

**7. Colby Crest Apartments  
Everett, WA**

A medium sized, affordable housing apartment building with ground floor shops (page 5-18).

**8. Canyon Park Shopping Center  
Bothell, WA**

A suburban shopping center with second story offices and walkways to adjacent businesses and housing (page 5-20).

**9. Harbor View Plaza  
Edmonds, WA**

A small office building with second story condominiums (page 5-22).

**10. Madison Valley Center  
Seattle, WA**

An established, mixed use neighborhood center undergoing new development and infill (page 5-24).

**11. C & C Deli  
Everett, WA**

A small grocery store in a neighborhood of upscale houses (page 5-26).

**12. Madrona Neighborhood Center  
Seattle, WA**

An historic neighborhood center anchored by quasi-public institutions (page 5-28).

# Mixed Use Examples

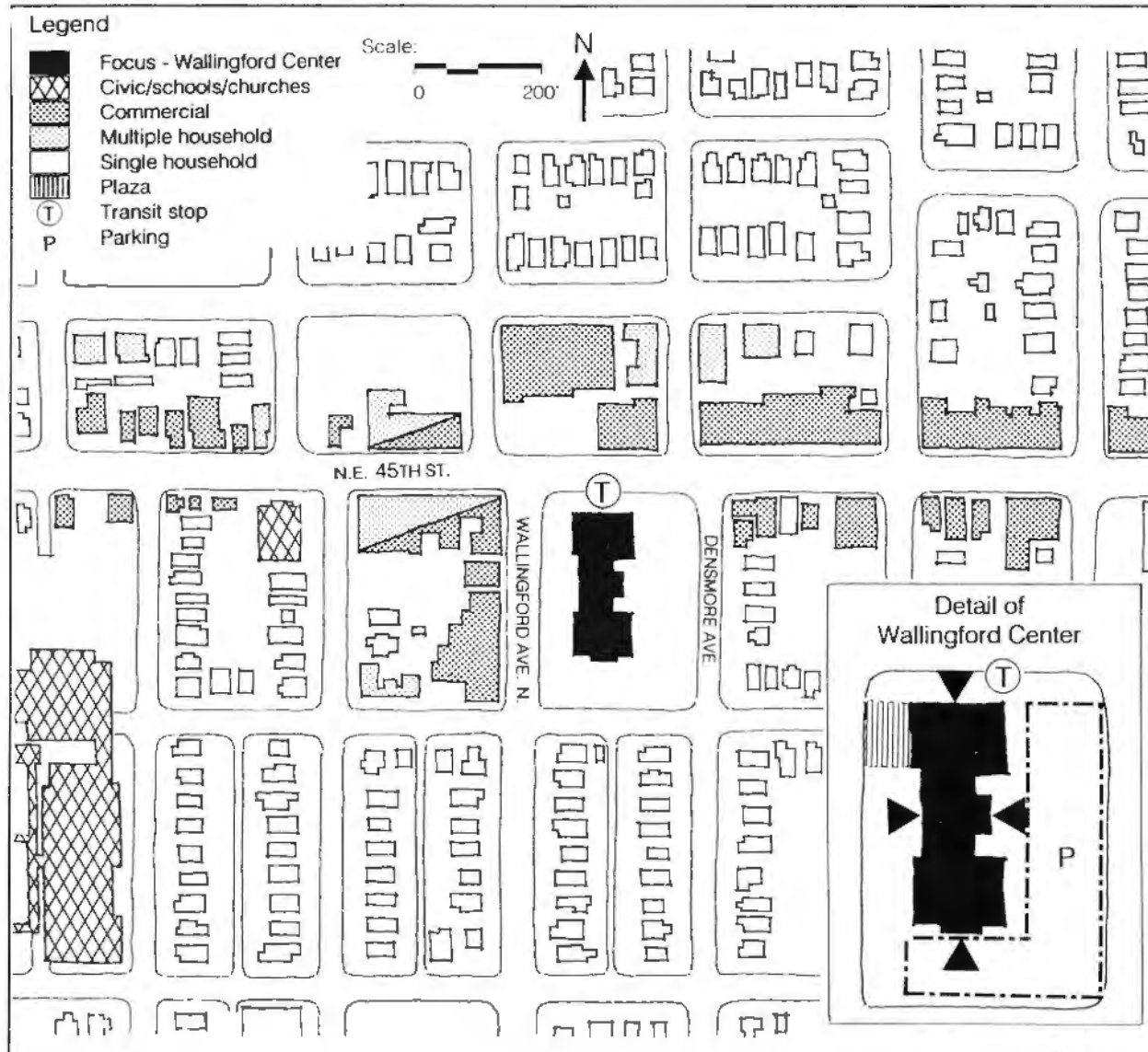

## Wallingford Center

- **Location:** N. 45th Street and Densmore Avenue, Seattle.
- **Type:** An historic, three-story school building converted to shops, restaurants, and apartments.
- **Mix:** 27,000 square feet of retail shops and restaurants; with 24 top floor apartments. A variety of stores, services, and housing is located nearby.
- **Pedestrian Features:** Wide sidewalks; buildings adjacent to sidewalk; entrances on all sides. Bus stop with covered waiting area near front door. Pedestrian-scaled blocks.
- **Context:** "Wallingford," a typical medium density neighborhood in north Seattle.
- **Parking:** A small "pocket" lot to the rear of the building, plus on street parking.

## Mixed Use Examples

### What is it?

Wallingford Center is a turn-of-the-century school building refurbished and converted to mixed use. The three-story building houses 21 retail shops and restaurants, along with 24 apartments on the top floor. With a popular deli, an espresso stand, clothing shops, a home furnishings store, a toy store and a book store, the Center has become a neighborhood hub in Seattle's historic Wallingford district. Surrounding blocks contain apartments, houses, shops, and restaurants, all set into a pedestrian-friendly pattern of small blocks.

### Why it Works

Residents of the Center's top floor apartments have direct access to its shops, while the residential floor is secured for tenants only. Located on a prominent corner at the heart of the Wallingford district, the Center's restaurants and specialty shops draw pedestrians from surrounding neighborhoods and shoppers from throughout the city.

Along with placing apartments just a staircase away from shops and services, the Center adds to the neighborhood's vibrant mix of housing and commerce. Within a few blocks are numerous shops, restaurants, businesses and entertainment, along with apartments and other mixed use buildings. Activity tapers off a block or so away, giving way to neighborhoods of single-family homes.

Pedestrian connectivity begins within the building, with wide hallways on each floor creating an interior mall. The building has large, welcoming entrances on all sides and sits right at the sidewalk edge. Along the streets, sixteen-foot sidewalks

connect the center with other businesses and apartments. A grid of narrow streets and small blocks—with sidewalks on both sides—gives residents of nearby neighborhoods safe, direct access to the center.

### Key Features

As the district's old school building—a natural focal point for neighborhood activity—Wallingford Center carries a sense of nostalgia as well as the design trademarks of the pre-auto era: where a new building might have been set back in a parking lot, the old school building sits at the sidewalk edge, with parking tucked behind. A large, open courtyard on the corner makes a natural space for cafe-style dining, a garden shop, art works, and places to simply sit and take in sights and sounds. A bus stop sits just outside the front entrance.

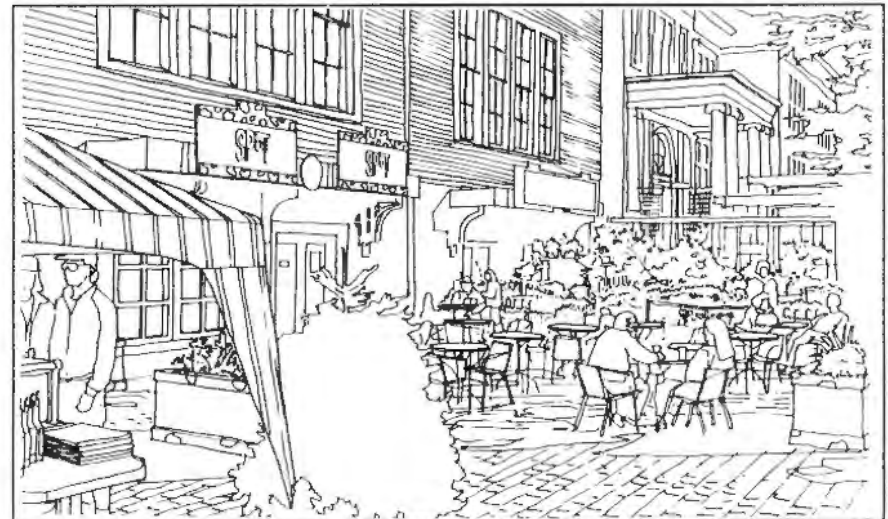

Public spaces make Wallingford Center a neighborhood hub.

# Mixed Use Examples

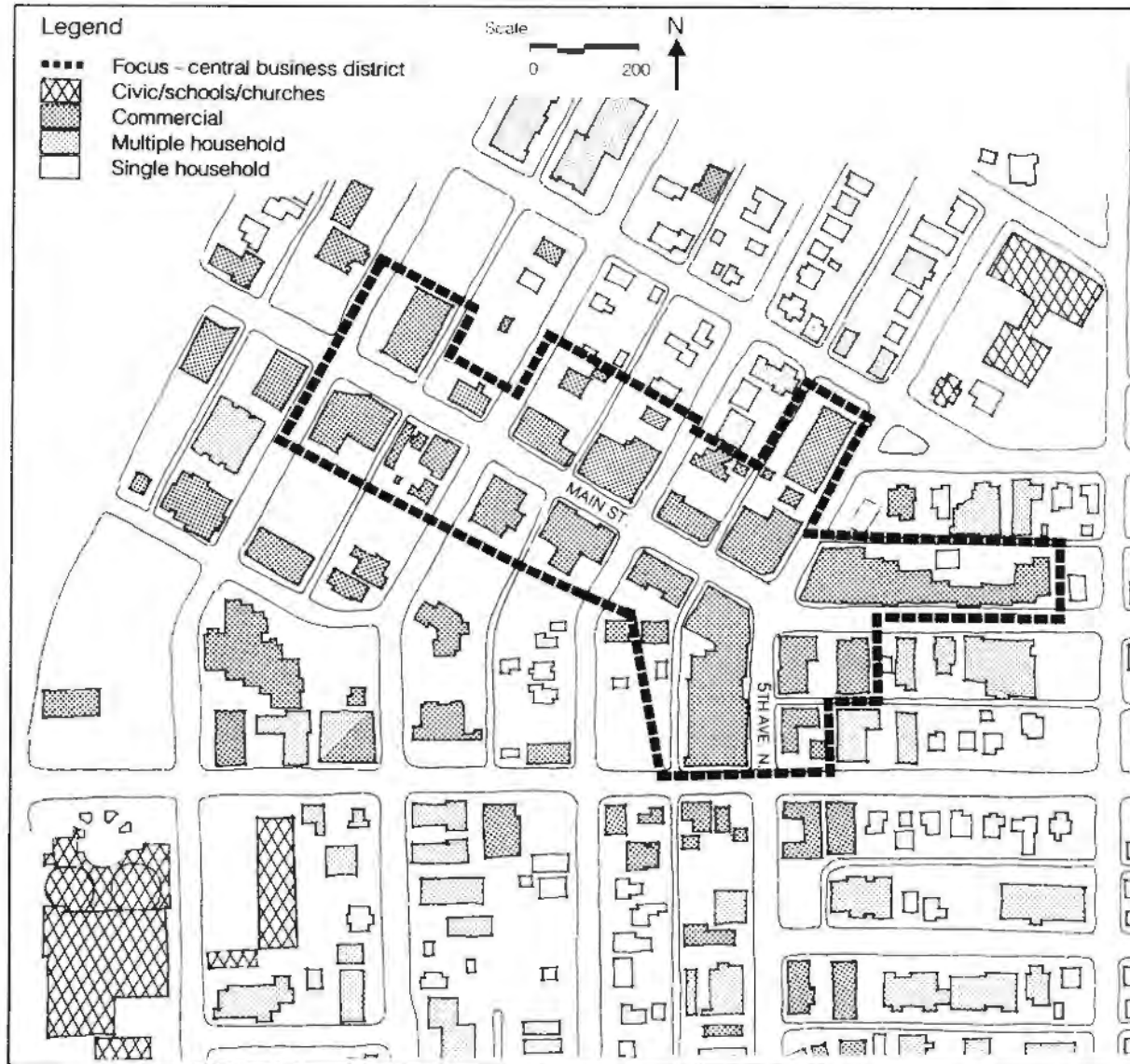

## Edmonds Town Center

- **Location:** A 20-block area centered on 5th & Main Street, Downtown Edmonds.
- **Type:** A small, historic city center with a commercially-oriented Main Street, recreation and public services.
- **Mix:** Shops and restaurants, consumer services, professional offices, apartments, houses, and light industry.
- **Pedestrian Features:** Small blocks and narrow streets with wide sidewalks; slow traffic speeds. Buildings entrances on sidewalks, with awnings, benches, lighting, art and landscaping. Several bus routes.
- **Context:** City of Edmonds, a waterfront community (pop. 31,000) halfway between Seattle and Everett, Washington.
- **Parking:** On street, in small off-street "pocket" lots, and within/under buildings.



## Mixed Use Examples

### What is it?

Downtown Edmonds is a charming, old-style town center with a compact mix of housing, shops, offices, parks, and public services. The focus of activities is Main Street, a narrow, tree-lined avenue fronted by ground floor shops, many with second-story offices and apartments. Within a few blocks of Main Street, the residential-commercial mix gives way to apartments and condominiums, then to blocks of individual homes. A post office, City Hall, senior center, school, library, and small parks are all clustered in and near the center. On the nearby waterfront is a State ferry terminal, along with a fishing pier and a thriving marina.

### Why it Works

Within the twenty-block center, about 1,700 apartments and homes are mixed with a variety of shops and professional offices, which makes for lively streets at nearly any time of day. Residents of the center and surrounding neighborhoods can walk to commercial and government services as well as to jobs. The specialty shops and restaurants along Main Street and the waterfront draw tourists from around the region. To maintain this mix, the City uses zoning to keep housing from displacing downtown businesses.

A large part of downtown Edmonds' allure comes from its compact form: streets are no wider than 40 feet (including two parking lanes), blocks are a short 150 to 200 feet long, and off-street parking is in small "pocket" lots set to the side or rear of buildings. The small-block grid gives the pedestrian a short, direct route between any two points in the

downtown area: Over 3,000 households are within a five-minute walk (1/4 mile) of the downtown area.

Sixteen-foot wide sidewalks line the major streets, giving the pedestrian nearly as much space as cars. Many shopfronts have protective canopies, and parallel parking creates a protected avenue for walking. Auto traffic is slowed by narrow traffic lanes, a central traffic roundabout, and narrowed crossings at intersections. Sidewalks link downtown with surrounding neighborhoods.

### Key Features

Mixed use works in downtown Edmonds because of its pedestrian-scaled layout, but also because of attention to detail in street design. Street trees, hanging flower baskets, benches, and decorative paving signal that Edmonds is a place for walking.

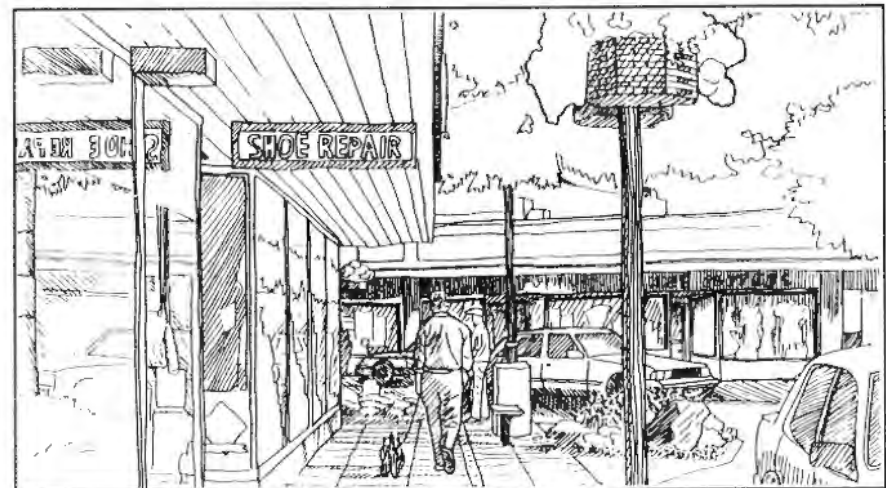

Walking is encouraged by Edmonds' small blocks and pedestrian-friendly streets.

## Mixed Use Examples

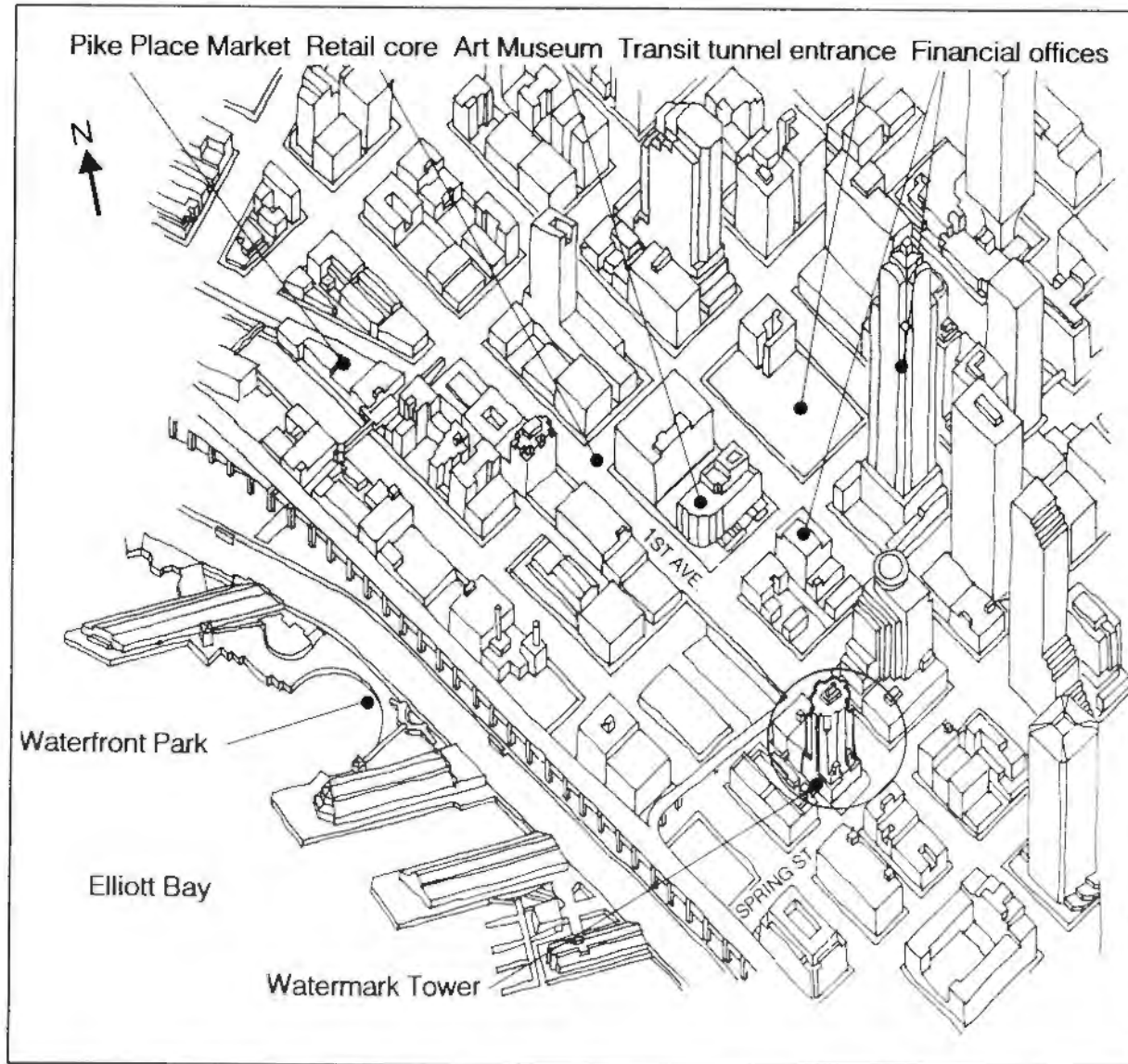

### Watermark Tower

- **Location:** 701 First Avenue, between Madison and Spring Streets, Seattle
- **Type:** A 22-story apartment and office building with ground floor retail shops. Classic high-density (300 units per acre) "vertical" mixed use scaled to large city center.
- **Mix:** 15 floors containing 94 apartments, 4 floors of offices, and 3 floors of offices mixed with retail shops.
- **Pedestrian Features:** Building adjoins wide sidewalk, with shop windows and entrances facing street. No surface parking lot.
- **Context:** Downtown Seattle business district, between Pike Place Market and Pioneer Square. Easy walk to nearby offices, stores, theaters, and transit services.
- **Parking:** On street and in an adjacent parking garage.



## Mixed Use Examples

### What is it?

Located on the waterfront edge of downtown Seattle, Watermark Tower is a half-block, 22-story building that mixes housing, shopping, and offices. The upper fifteen floors house 94 apartments above three floors of offices and four floors that mix retail shops with offices. Watermark Tower is the flagship building of Waterfront Place, a 1.4 million square foot redevelopment project that brought new housing, offices, and shopping to Seattle's once blighted First Avenue. Completed in the early 1980's, the project has helped turn the avenue into a pedestrian corridor bustling with tourists, business people, and new downtown residents.

### Why it Works

Watermark Tower residents have at their disposal a vast array of shopping, services, recreation, and employment opportunities—all within the compact and walkable central business district. The district has small blocks, narrow streets, and wide sidewalks throughout, providing easy access to the uphill financial district and the Puget Sound waterfront two blocks away, including the Pike Place Public Market.

The building itself helps create a pleasant walking environment with its wide sidewalks, ground floor shop windows, and an historic street-level facade preserved from the previous building on the site. Parking is in an adjacent garage, with one space per apartment. Over a dozen bus lines serve the site, and Seattle's bus tunnel and transit mall are a few blocks away.

### Key Features

While relatively few Puget Sound communities might consider a building the size of Watermark Tower, the project shows how an appropriate scale and mix of uses can enliven an area. Larger-scaled mixed use buildings, particularly those that bring housing to employment centers, will play a particularly important part in the regional strategy to guide growth into existing urban centers.

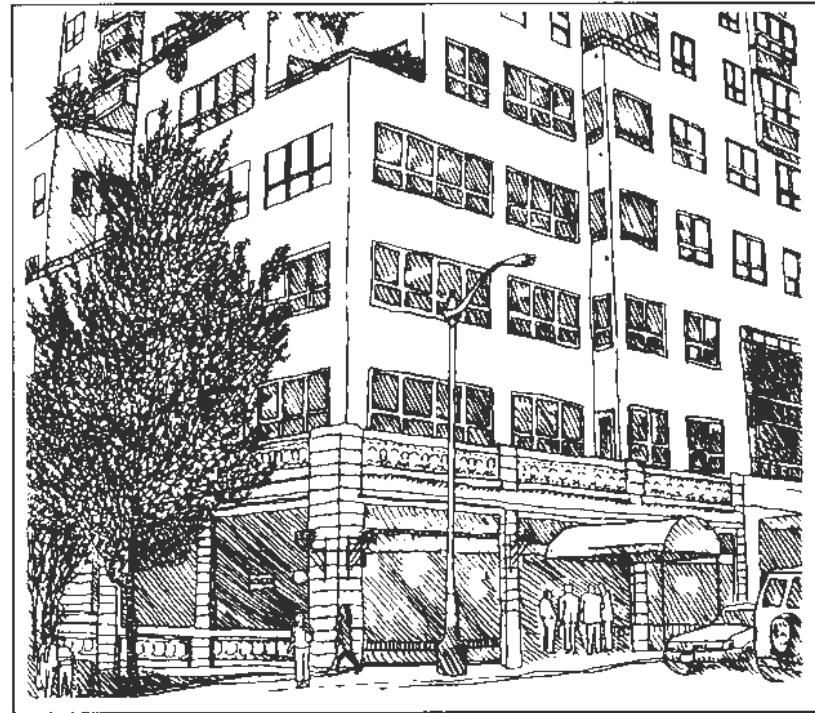

*A large mixed use project complements the jobs, services, transit availability, and amenities of the central city.*

## Mixed Use Examples

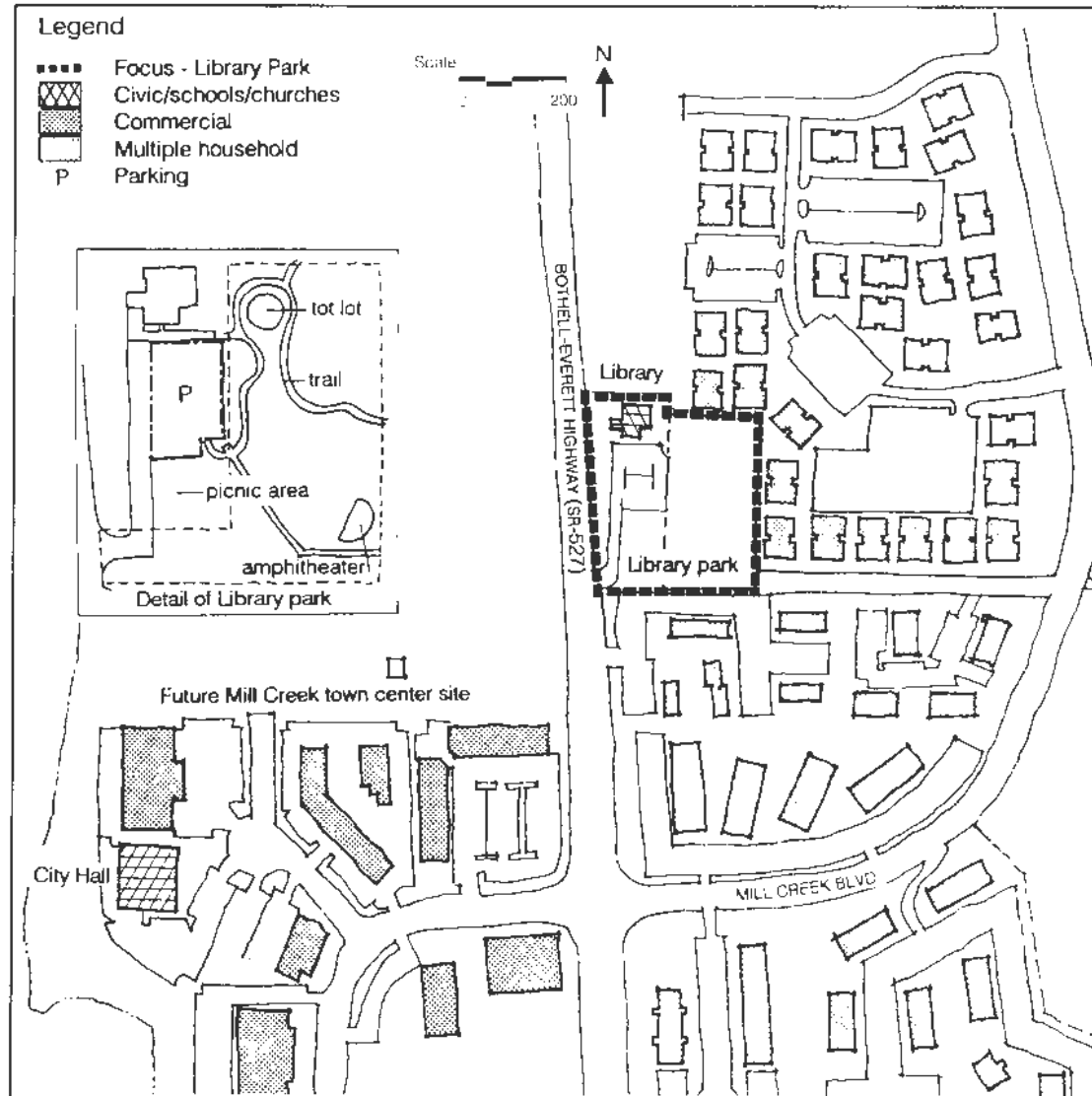

### Mill Creek's Library Park

- **Location:** On Bothell-Everett Highway, 1/8 mile north of Mill Creek's city center.
- **Type:** A neighborhood park surrounded by apartments and townhouses.
- **Mix:** A three-acre park and library adjacent to 200+ apartments and townhouses.
- **Pedestrian Features:** Sidewalks and trails connect housing, library, and park.
- **Context:** A neighborhood of apartments and townhouses adjacent to the main highway, 1/8 mile from Mill Creek's center.
- **Parking:** A 32-space "pocket" lot serves the library and park.

## Mixed Use Examples

### What is it?

Mill Creek's Library Park is a three-acre public park adjacent to the city library and surrounded on three sides by apartments and townhouses. The park has picnic and sitting areas, a "tot lot", a small amphitheater, lawns and stands of natural wetland forest. It was built in 1989 by the City using State and City funds, with construction help by a local developer.

### Why it Works

Library Park and the apartments and houses surrounding it represent a mix of housing and recreation that can fit in any neighborhood. The park gives neighborhood residents a place to walk, congregate, and play, while nearby housing ensures the park is well-utilized.

Within a few hundred feet of the park (the distance of about one city block) are nearly 200 apartments and townhouses. Nearly 500 dwellings, along with a shopping center, offices and City Hall, lie within a quarter mile—an easy, five-minute walk. The close proximity of housing, along with well-planned walkways, gives people access to recreation without driving. The apartments and townhouses adjacent to the park are connected directly to the park by walkways, and a network of sidewalks and paved paths link the larger neighborhood to the park and library.

### Key Features

Public activities, even neighborhood parks, can raise privacy concerns when located next to housing. A typical but

misguided solution is to build a wall or a landscape "buffer" completely separating the two activities. Library Park has townhouses built just a few feet from its edge, and a strip of natural forest was left between the two to give residents privacy. But a walkway through the trees also lets residents easily get to the park without having to drive. (In an even more traditional arrangement, housing might be situated around and face the neighborhood park.)



*Walkways linking library park to the surrounding neighborhood create a low intensity form of mixed use that can work in any neighborhood.*

Mill Creek was originally a private development and has a good network of private trails and open space (including a golf course). Since it became a city in 1983, three small public parks have been added, allowing nearly all of the city's residents to easily walk to a park.

# Mixed Use Examples

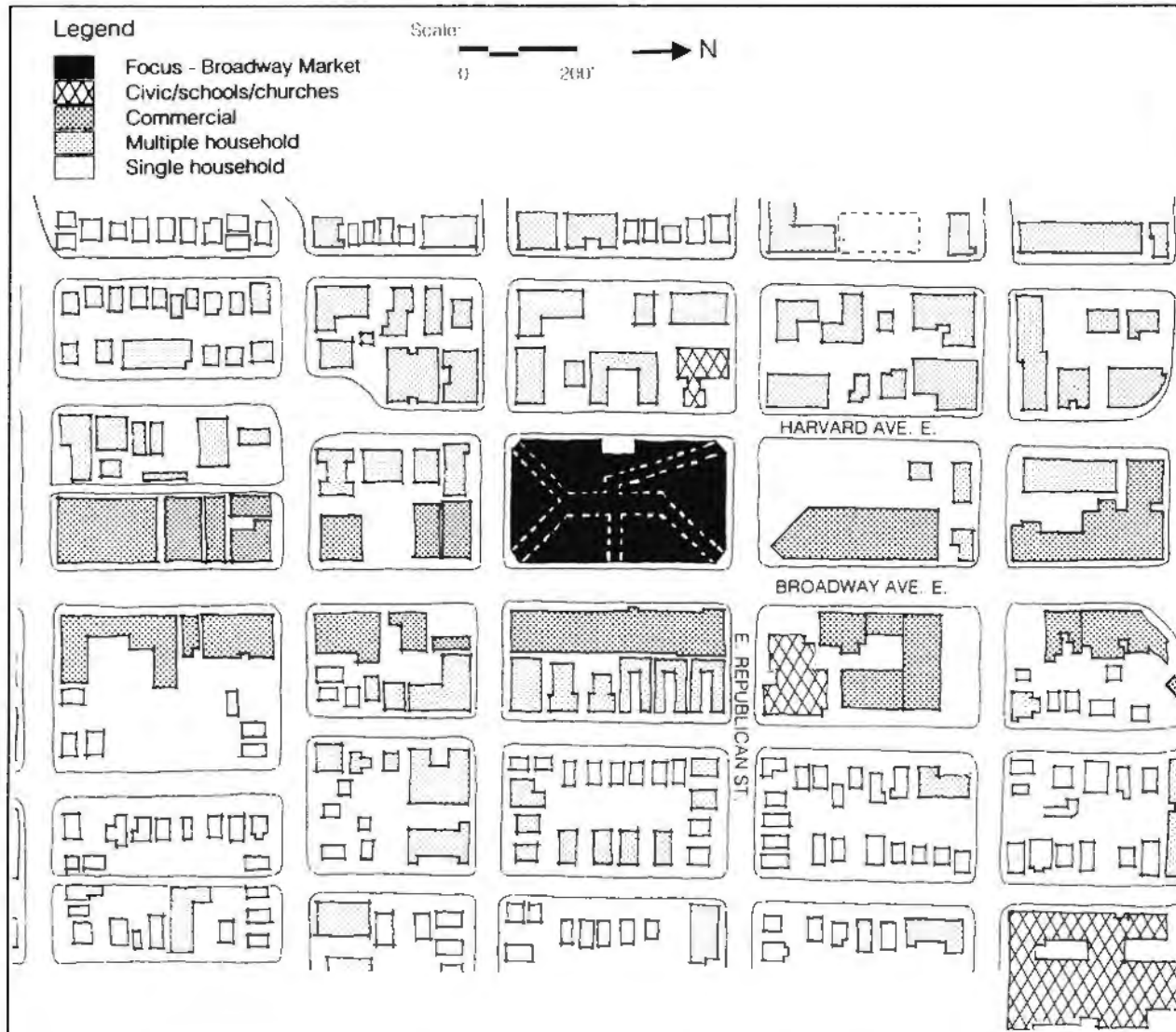

## Broadway Market

- **Location:** Between Broadway and Harvard at Republican Street, Capitol Hill Neighborhood, Seattle.
- **Type:** A 100,000 square foot specialty shop mall with theaters and a discount store, and apartments above.
- **Mix:** Over 30 shops and restaurants, 31 apartments, 4 theaters, and a few offices.
- **Pedestrian Features:** Indoor pedestrian mall, wide sidewalks, shopfront windows, street art. No surface parking lot. Bus stops at main entrances.
- **Context:** A thriving commercial boulevard in a high density Seattle neighborhood.
- **Parking:** Two floors of parking in the building; limited parking on street.

## Mixed Use Examples

### What is it?

Broadway Market is an eclectic mix of shops and apartments encompassing a full block in Seattle's lively Capitol Hill neighborhood. Formerly the district's grocery and later a Fred Meyer department store, this historic building was refurbished and converted to a mixed use mall in 1987. It now houses over 100,000 square feet of retail stores and restaurants (equal to the floor space of a mid-sized suburban shopping center), along with a four-theater cinema, an art gallery, 31 apartments, a scaled down Fred Meyer store, and a small amount of office space. The building fronts on Broadway, the district's main commercial thoroughfare, but also faces Harvard, a residential street lined with apartments.

### Why it Works

Broadway Market compatibly mixes shopping and entertainment with housing, all within the building and within the neighborhood as a whole. Residents of the Market are an elevator ride away from services and entertainment, while several apartment buildings ranging from 3 to 10 stories are within a five minute walk. The Market's lively mall, shops, restaurants, and theaters help support one another and the district by drawing customers from around the city. The building presents an open, neon-accented commercial front to the businesses on Broadway, but to the apartments along Harvard Avenue it presents a low-key, residential facade.

Walkability begins inside the center where pedestrians can window shop or browse among carts selling clothing and crafts. Unlike a segregated-use, suburban mall, Broadway's

interior corridor connects to sidewalks on all sides of the building. For the pedestrian walking along Broadway's wide front sidewalk, the mall becomes an optional diversion, going in one end and out the other. With parking out of the way in an underground garage, sidewalks lead directly to adjacent blocks to create a safe, direct connection between the Market and nearby housing and businesses.

### Key Features

Broadway Market's complementary mix of uses generates a lively atmosphere throughout the day. The restaurants, shops, and theaters keep the mall active in the evening and on weekends and draw the lunch crowd from nearby businesses. The Market's mix of business and housing along with a colorful mall make it the local center of activity.

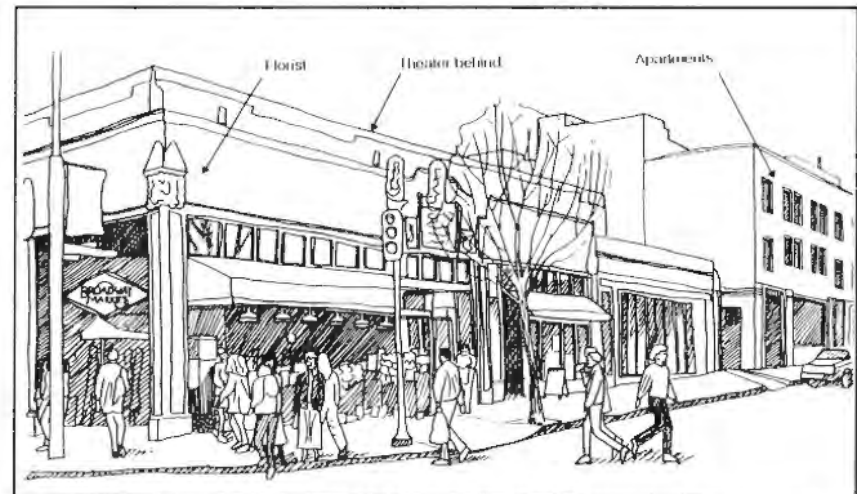

*Broadway Market's mix of housing, shopping, and entertainment generates a lively atmosphere throughout the day, seven days a week.*

## Mixed Use Examples

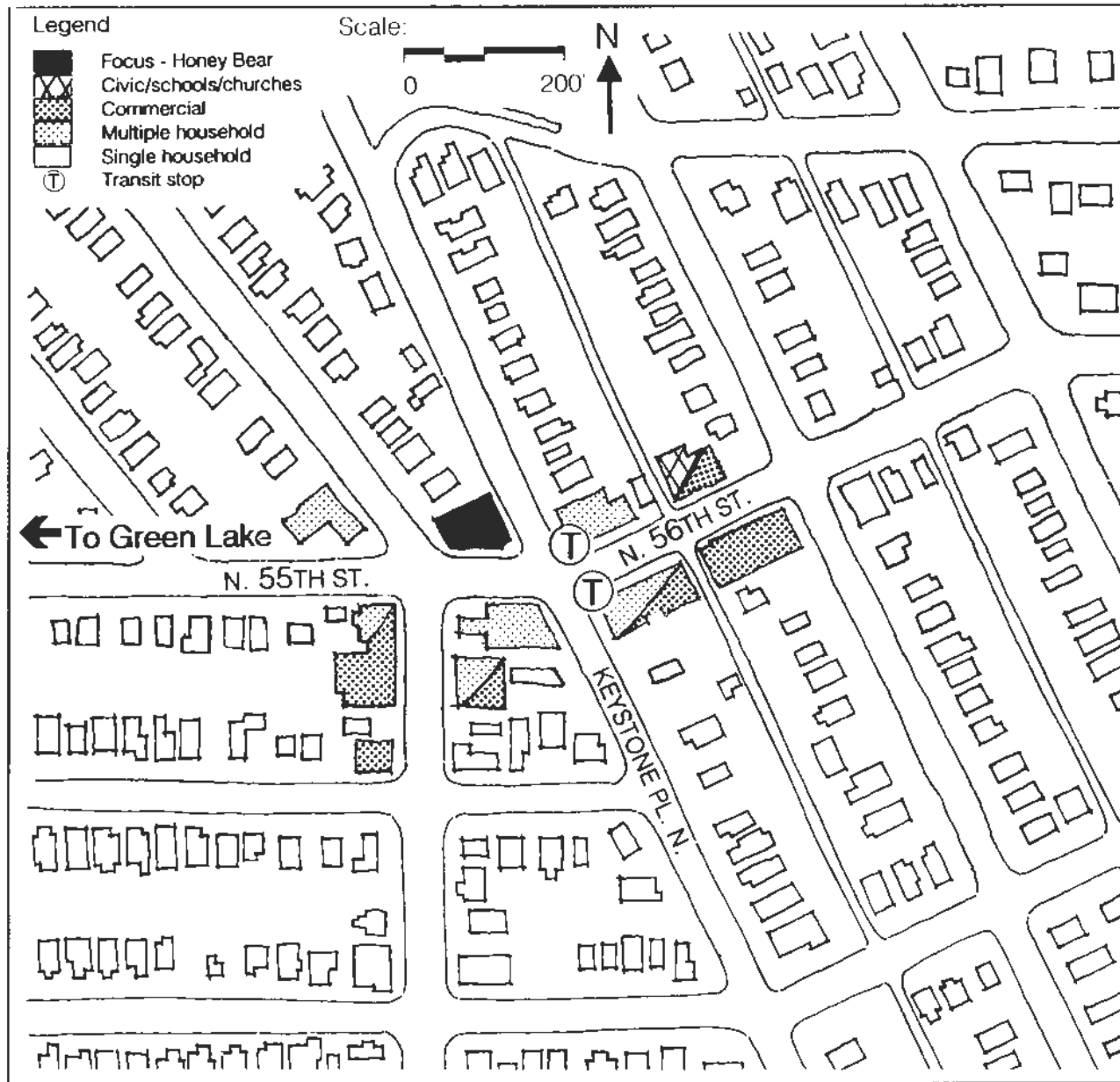

### Honey Bear Bakery

- **Location:** North 56th Street at Meridian, Green Lake neighborhood, Seattle.
- **Type:** A small (6,200 square foot) building with shops and offices in a traditional neighborhood center.
- **Mix:** A bakery/coffee shop, a deli, with a produce market and professional office space.
- **Pedestrian Features:** Narrow streets with wide sidewalks; building adjoins a wide sidewalk, parking in rear. Landscaping and outdoor seating.
- **Context:** A small commercial corner in a neighborhood of houses and apartments near Green Lake park.
- **Parking:** Short term parking on street; a 10-space "pocket" lot behind the building.

## Mixed Use Examples

### What is it?

This small (6,200 square foot) two-story building houses the "Honey Bear" bakery, a deli, a produce market, and three professional offices. The building occupies a prominent corner in a small cluster of shops and services located in Seattle's Green Lake neighborhood.

### Why it Works

The Honey Bear complements both its commercial neighbors and the surrounding residential blocks. The bakery, deli, and produce market draw people from the neighborhoods as well as from nearby Green Lake, a popular city park. Within this three-block center, residents and visitors find a pharmacy, professional services, a restaurant, a laundromat, a grocery, a church, and other services — all within a few hundred feet of each other.

Also clustered within a block of the Honey Bear are four small apartment buildings. Within a five-minute walk are an additional 260 homes, many of which have "accessory units," or apartments, which help raise densities to a level that supports businesses without affecting the neighborhood's well-kept appearance. (In fact, accessory dwellings allow property owners to improve their homes and often stabilize and enhance neighborhoods.) Conceivably, a person could walk to work, visit the dentist, shop for groceries and go jogging in the park, all within a few short blocks of home.

Nearby residents have direct routes to the commercial hub because the Green Lake district is built on a grid of small blocks. Eight-foot wide sidewalks line the front of the

commercial blocks, and sidewalks link the neighborhoods to the center, the park, and one another. Parking is minimal and located to the rear of buildings or on the street, keeping paved lots out of pedestrian pathways and maintaining an intimate pattern of store windows along the sidewalk. Streets are narrow, and traffic speeds kept slow.

### Key Features

The Honey Bear building not only has businesses that complement the neighborhood, but shows how a carefully designed, pedestrian-friendly commercial building can add to neighborhood character. The produce market and deli are a good excuse for a walk to the bakery, which partly explains the espresso-sipping crowds on weekend mornings. A peaked roof gives the building a friendly, residential look, and large front windows, awnings, plants, and benches make Honey Bear the neighborhood hub.

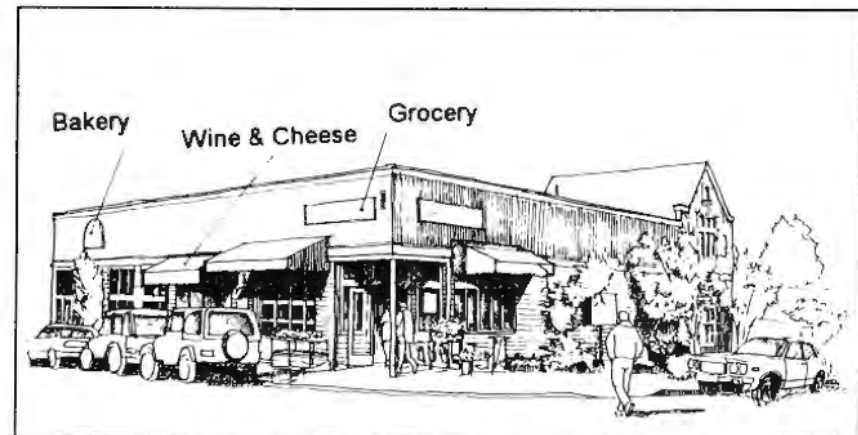

*A small, attractive mixed use building accents the surrounding neighborhood.*



## Mixed Use Examples

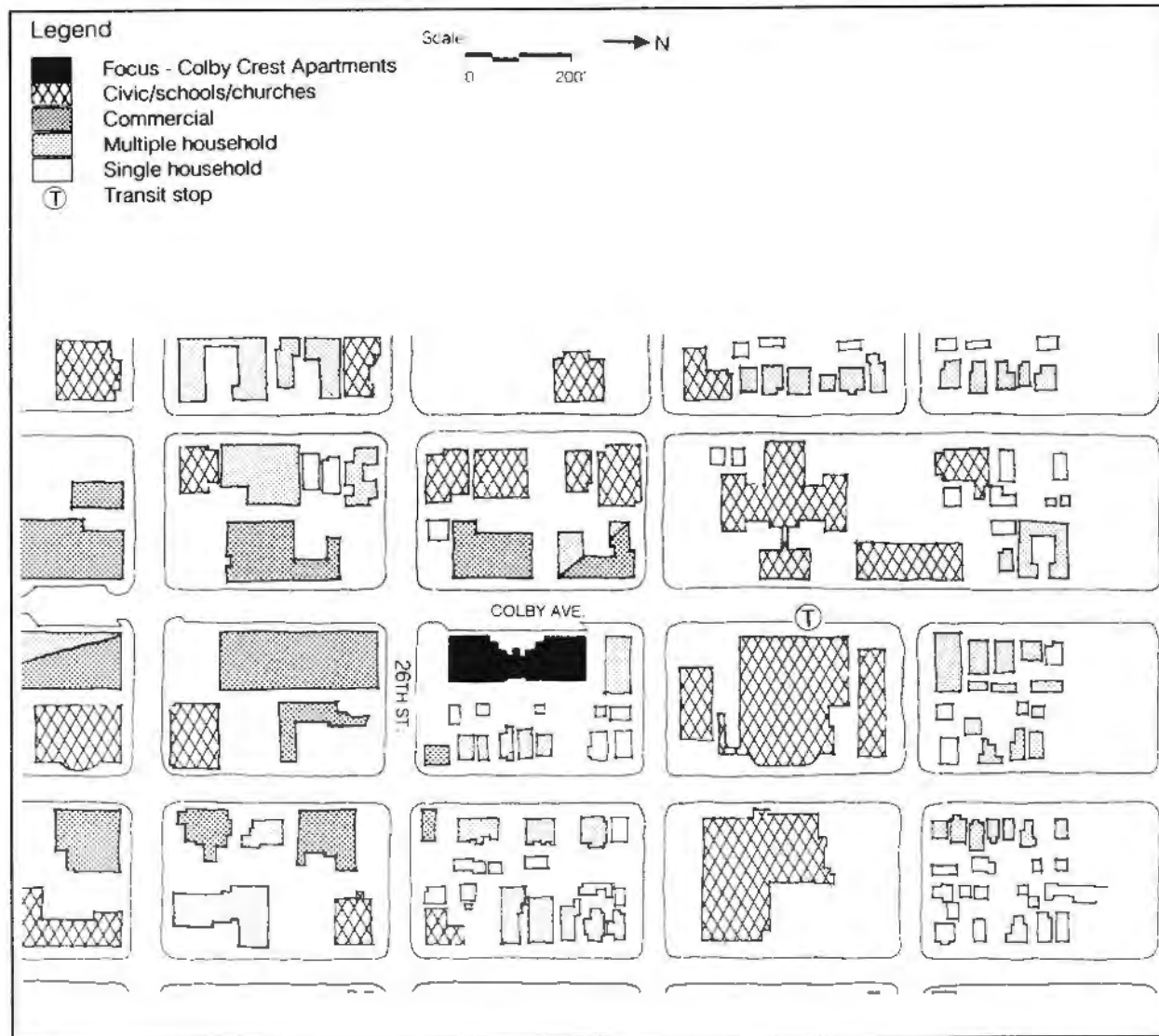

### Colby Crest Apartments

- **Location:** 2500 block of Colby Avenue, Everett.
- **Type:** A medium sized, affordable housing apartment building with ground floor shops.
- **Mix:** 69 apartments above 3,600 square feet of retail and office space.
- **Pedestrian Features:** Pedestrian plaza with sitting area, wide sidewalks, shopfront windows, outdoor lighting. Bus stop one block away.
- **Context:** Downtown Everett, along a "pedestrian corridor" experiencing major urban infill and revitalization.
- **Parking:** Limited parking within the building, with alley access, and on-street parking.



## Mixed Use Examples

### What is it?

Colby Crest is a new five-story apartment building with ground floor shops and offices. Located at the edge of Everett's central business district, the building fronts on Colby Avenue, a City-designated "pedestrian corridor" along which a number of new mixed use projects have been built in recent years. The construction of Colby Crest was financed in part by a federal subsidy for affordable housing, requiring apartments be rented to people with limited incomes. The building provides downtown housing for a market that includes students and retired people. The apartments and shops were rented within two years after the project was built.

### Why it Works

Colby Crest puts 69 apartments in the same building as a medical office, two successful crafts shops, and a tenant community room. Tenants have access to the in-building shops as well as to a broad range of downtown stores, services, restaurants, offices, churches, schools, arts and entertainment—all within a few blocks. The higher density housing provided by the project helps to bolster downtown businesses and create a lively, secure place to live and work.

Typical of downtown environments, Colby Crest's surroundings are compact, with a grid of pedestrian-scaled blocks and limited land devoted to surface parking (Colby Crest itself provides only 32 spaces for the 69 apartments, yet has a surplus during the day). The building's street-front improvements include a wide sidewalk, a bright commercial facade, outdoor lighting, and a pedestrian plaza with benches and landscaping. Sidewalks are found on all

sides of every block in the area, connecting the project to neighborhoods to the north and the central business district to the south. Colby Avenue is a major bus route, with a bus stop one block south of Colby Crest's front door.

### Key Features

The introduction of a bright, attractive mixed use apartment building is contributing to an urban revival in surrounding blocks. Two similar projects are being built along Colby Avenue, and neighboring businesses and apartments are sprucing up with repairs and new paint. With more people about at all hours, the neighborhood is more secure and restaurants and shops are seeing an upturn in business.

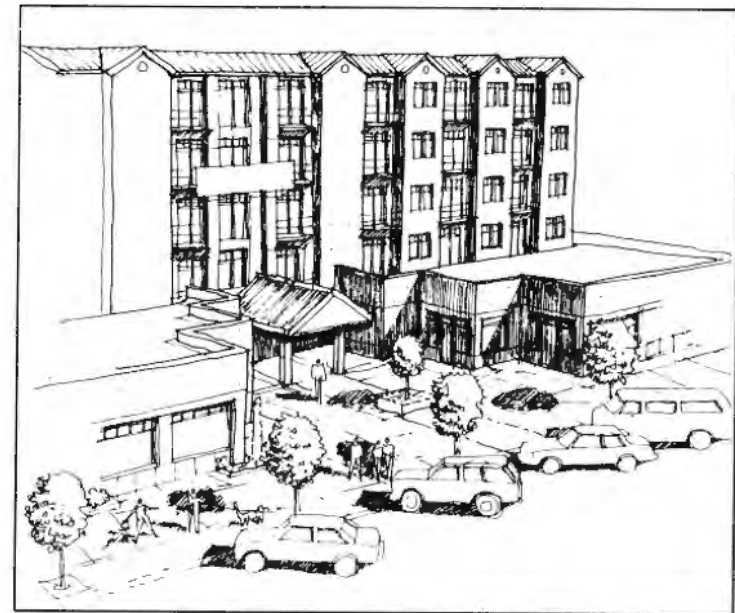

Colby Crest, a mixed use apartment building, is leading the revival of businesses at downtown Everett's northern edge.

## Mixed Use Examples

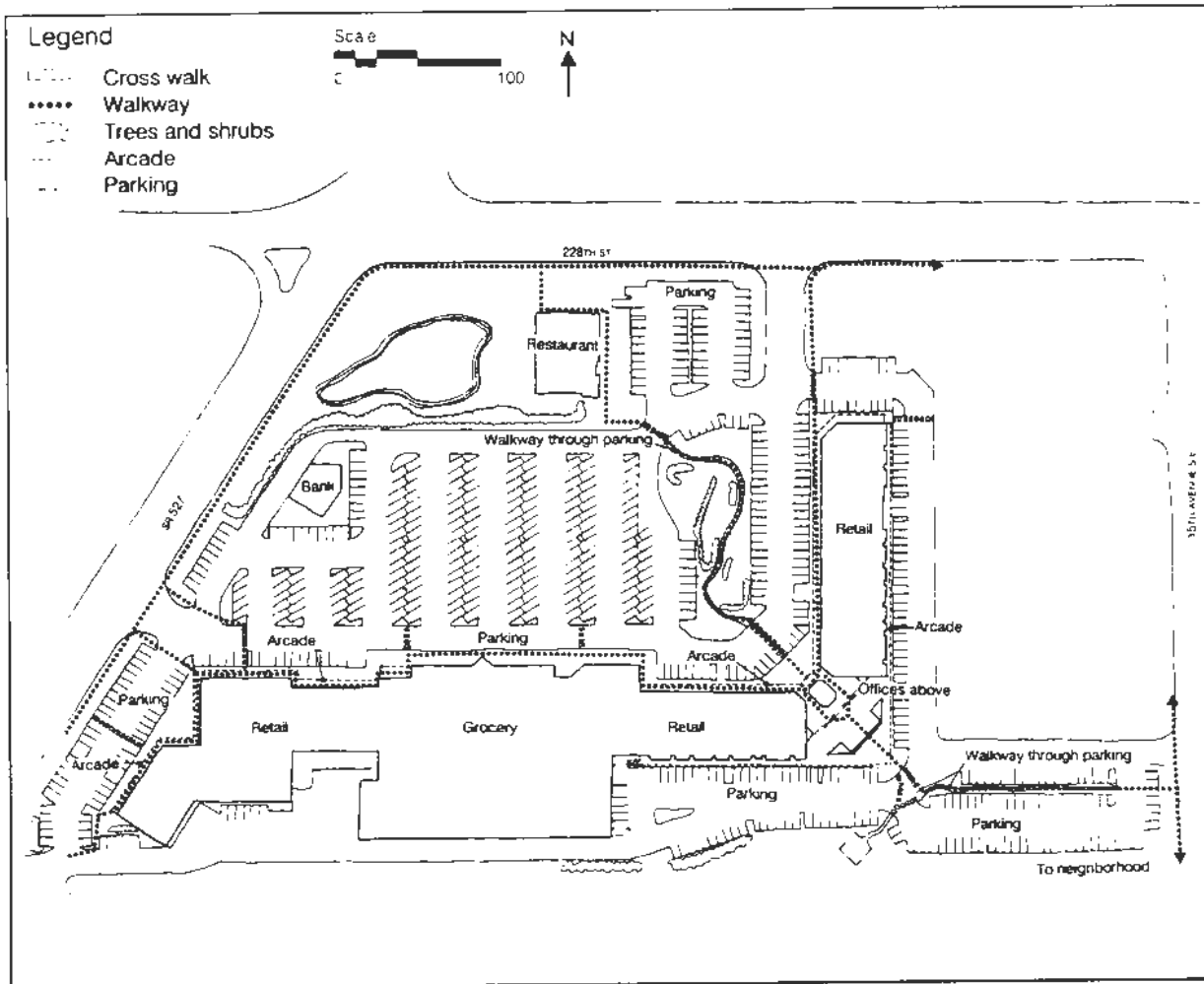

### Canyon Park Shopping Center

- **Location:** Southeast corner of 228th Street SE and Bothell-Everett Highway, Bothell.
- **Type:** A suburban shopping center with second story offices and walkways to adjacent neighborhoods.
- **Mix:** A supermarket, drug store, 23 specialty shops and services, and 15,000 square feet of office space.
- **Pedestrian Features:** Wide, covered walkway along store fronts, passageway through corner of L-shaped building. Walkways through parking lot connect building entrances with perimeter sidewalks. Outdoor café and benches.
- **Context:** A rapidly growing suburban area centered on arterial crossroads.
- **Parking:** Large lot in front for stores; small lot at rear for offices.

## Mixed Use Examples

### What is it?

Canyon Park Shopping Center is a suburban, L-shaped shopping center that departs from a standard "strip mall" by including a second story of offices and by providing exceptional walkways. While the large parking area makes the center primarily auto-oriented, the offices complement the retail stores and the walkways leave the potential for future connections to neighborhoods as they develop around the center. Currently the land uses on the other intersection corners include a strip mall, a gas station, and another shopping center. A large apartment complex lies a few hundred feet to the east, and individual homes are scattered to the south and east.

### Why it Works

The offices include a dental clinic, a chiropractor, a mortgage company, and an insurance agent. People who work in these offices have restaurants, a bank, a hair salon, and all sorts of shopping within a few hundred feet of their work place. Likewise, employees and customers of the retail stores have access to the center's professional services, which means a few less auto trips. All of these uses are connected by a wide, covered walkway spanning the length of the center. The covered walkway connects with perimeter sidewalks and crosswalks, giving employees of the businesses across either of the two highways reasonably safe, direct access to the center's professional services.

### Key Features

Canyon Park's mixed use potential is enhanced by the arcade that cuts through the corner of the L-shaped center. Typically, L-shaped shopping centers present a solid back wall to neighborhoods behind them, making anyone wanting to walk to the center or beyond go a long distance out of their way. By contrast, Canyon Park's arcade cuts through the building, connecting raised walkways that cut through parking lots to link directly with the block's outer sidewalks. Currently, the land behind the center is sparsely developed, but the area is growing rapidly. As homes and apartments fill in, mixed use can be achieved linking neighborhood sidewalks with walkways provided by the Canyon Park Shopping Center.

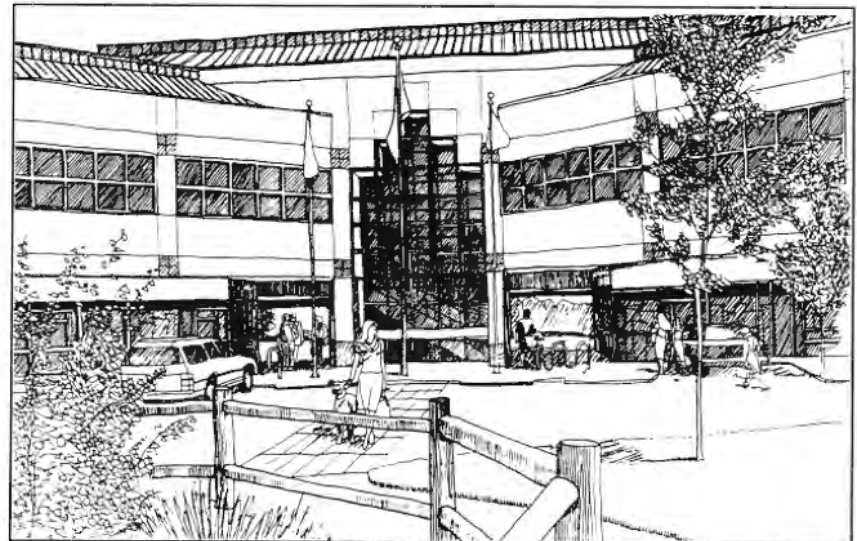

*Canyon Park's walkways create the beginnings of a network linking shopping and services with surrounding neighborhoods.*

## Mixed Use Examples

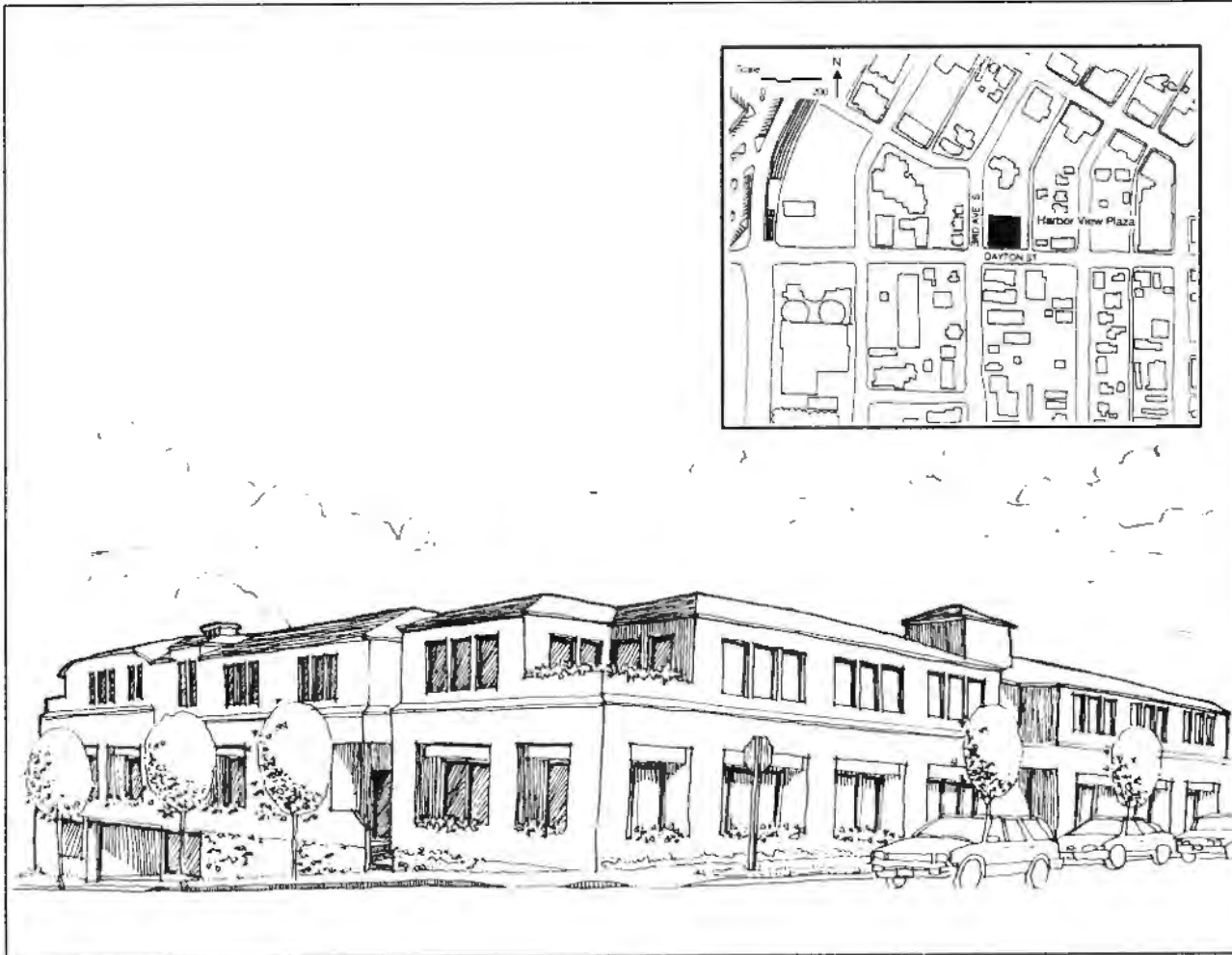

### Harbor View Plaza

- **Location:** Northwest corner of Third and Dayton, Edmonds.
- **Type:** A small office building with second-story condominiums.
- **Mix:** 12,500 square feet of office space and 4 condominiums.
- **Pedestrian Features:** Building set up to sidewalk, wide sidewalks lined with windows; all parking in underground garage. Near several transit routes.
- **Context:** Downtown Edmonds, on the edge of the City's central business district.
- **Parking:** A 24-space parking garage beneath the building; limited parking on street.

## Mixed Use Examples

### What is it?

Harbor View Plaza is one of several new, small-scaled mixed use buildings in the Edmonds town center. The building combines 12,500 square feet of office on the ground floor and part of the second floor with four second-floor condominiums. The building covers the entire lot, and parking is within an under-building garage. The building is located one block off Main Street, where the town center's mix of shops, restaurants, offices, and apartments makes a transition to neighborhoods of apartments, duplexes, and houses.

### Why it Works

The building adds professional offices and housing to the town's mixed use center, providing services and jobs to the center as well as customers for neighborhood businesses. People who live and work in Harbor View Plaza are just a few blocks away from shopping, banking, government services, restaurants and entertainment, all in a pedestrian-friendly grid of small blocks with sidewalks. The building is within a five minute walk of six bus routes, a train station, and a ferry terminal.

### Key Features

Harbor View Plaza builds on downtown Edmonds' compact arrangement of land uses and pedestrian-friendly design without exceeding the two-story pattern of surrounding buildings. Taking advantage of the sloping terrain, the developer tucked parking away underneath the building, so there is no parking lot in front to create a barrier between

sidewalks and building entrances or to push the building back from the street and disrupt the streetscape.

Eight-foot wide sidewalks are lined with windows, street trees, and planter boxes, adding to Third Street's pleasant walking environment. The combination of offices and condominiums in a small building makes a fitting transition between the predominantly commercial block on which it sits and the residential block directly across Dayton Street to the south.

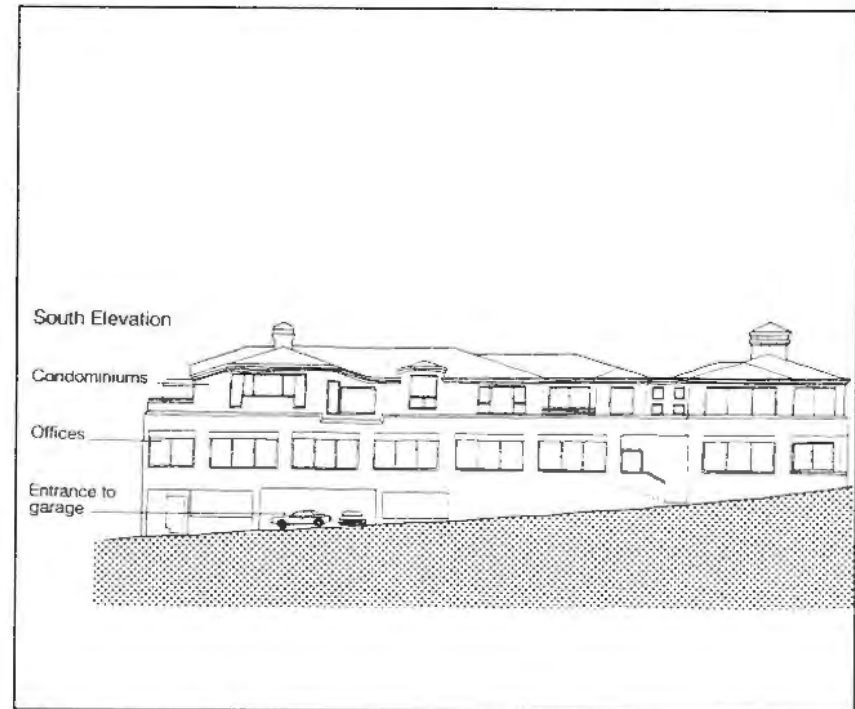

*Harbor View Plaza maintains downtown Edmonds' compact, pedestrian-friendly form by tucking parking under the building.*

## Mixed Use Examples

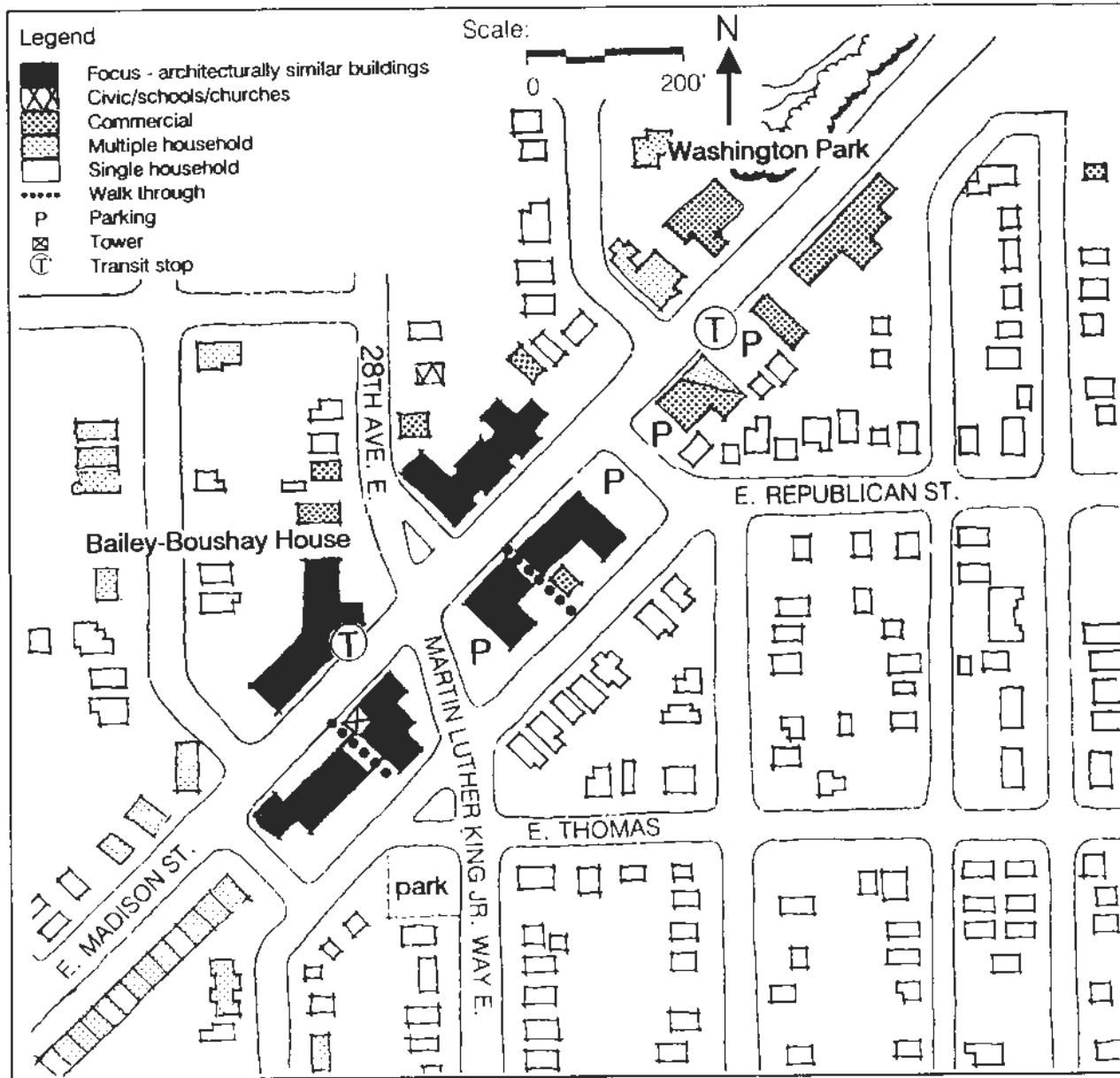

### Madison Valley Center

- **Location:** East Madison Street between Thomas and Republican streets, Seattle.
- **Type:** A three block neighborhood business and shopping center.
- **Mix:** About 40 shops, 90 offices, a medical clinic, 12 apartment buildings, 25 townhouses, 100 houses, and two parks.
- **Pedestrian Features:** Small blocks with sidewalks and crosswalks; sidewalk-oriented buildings with banking, mailboxes, etc.; bike racks, awnings, landscaping, and bus shelter.
- **Context:** A higher density node along a major arterial in a growing medium density residential area.
- **Parking:** On street and in small "pocket" lots set behind, beside, and under buildings.



## Mixed Use Examples

### What is it?

The Madison Valley mixed use complex is a compact, pedestrian enclave along E. Madison Street, a major arterial in Seattle's Madison Valley neighborhood. Clustered in this three-block area are a wide array of shops, restaurants, professional offices, services, and apartments. The newer commercial development is largely the work of one developer who, over the past 15 years, has led an effort to build lower cost housing, offices, and retail space. While relatively inexpensive, these shops and office buildings incorporate common design elements and pedestrian oriented features that distinguish this area as pedestrian and transit friendly.

### Why it Works

Providing a mix of activities that range from fast food dining to browsing for antiques, the Madison Valley complex is the commercial service center for residents of apartments in and around the complex as well as for surrounding lower density neighborhoods. About 90 professional offices along with the Bailey-Boushay Hospice keep the area lively during the day and provide customers for restaurants and retailers.

The complex has many of the design elements of an old-style "Main Street." Building entrances and windows face directly on the sidewalk, with parking on the street, in garages, or in small "pocket" lots located to the side or rear of buildings (in all, only 90 surface spaces serve 90 offices and 40 shops). Many of the buildings have protective canopies, and there are three walk-throughs that allow

pedestrians to pass between buildings to get to interior courtyards or parallel streets.

More than 375 houses and 15 apartment complexes lie within a five-minute walk of the Madison Valley Center. A grid of small blocks with sidewalks on both sides link the neighborhoods directly with the center. A major bicycle route runs past the complex, and a bus route provides daily service from the center to downtown Seattle.

### Key Features

Part of what makes mixed use work in Madison Valley is harmonious architecture. A single developer set a style using peaked roofs, simple framed windows, stucco, and a common color palette, and subsequent developers have built on that style. The buildings are compatibly scaled, generally one to four stories of offices and apartments above ground floor shops and restaurants. One of the new buildings includes a tower that gives the center its own, unique landmark.

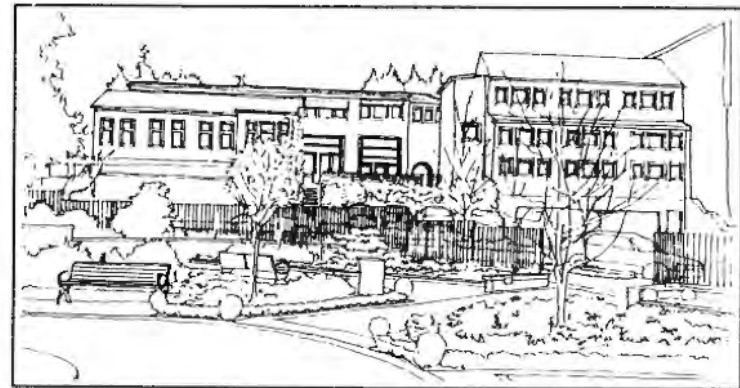

*Common architectural elements and pedestrian-friendly design help make mixed use work in Madison Valley.*

## Mixed Use Examples



### ***C & C Deli***

- ***Location:*** On the northwest corner of Colby Avenue and 14th Street, Everett.
- ***Type:*** A small grocery store in a neighborhood of individual homes.
- ***Mix:*** A 2,400 square foot grocery and deli within five minutes walk of 300 homes.
- ***Pedestrian Features:*** Small-block grid with wide sidewalks; building has protective canopy and no parking lot.
- ***Context:*** A corner lot on a main thoroughfare through Everett's north end residential neighborhood.
- ***Parking:*** On street only.



## Mixed Use Examples

### What is it?

C & C Deli is a classic, old-style neighborhood store built in the 1930's. Located on the corner of Colby Avenue, a main arterial leading to downtown Everett, and a local residential cross-street, the small grocery and deli is the only commercial building for several blocks in the City's prosperous, north-end neighborhood. Across Colby Avenue is a large hospital, and a community college lies a few blocks to the northeast. Otherwise, the blocks surrounding the store contain only houses.

### Why it Works

C & C Deli provides people living in the north end neighborhood with a place to shop for grocery items within walking distance of their homes. About 300 houses are within a five-minute walk of the store, and even from several blocks away, residents have a short, direct route to the store due to north Everett's grid of small blocks. Narrow streets, sidewalks and street trees make walking in the neighborhood safe and pleasant.

The store itself is built right up to the sidewalk, giving pedestrians easy access to a corner entrance, and the building has a protective canopy along the front. The only parking is parallel parking on the street.

### Key Features

C & C Deli is something of an anachronism: In this era of mega-markets, the corner store has a hard time competing, and many have gone out of business. C & C Deli may be an exception in part because of its location along a main arterial (where, not coincidentally, you will always find the

small grocery's modern counterpart: the gas station/convenience store). The store is in plain view of drivers passing between the hospital or college and downtown Everett, and this combines with the neighborhood customers to keep the store viable. In the past, planners discouraged mixing small commercial uses with residential neighborhoods, calling such arrangements "spot zoning." Today, the City of Everett is trying to encourage more small neighborhood stores like C & C Deli.



*A small neighborhood grocery means north Everett residents don't have to drive to pick up a newspaper or a quart of milk.*

## Mixed Use Examples



### Madrona Neighborhood Center

- **Location:** 34th Avenue between E. Pike and E. Spring streets, Seattle.
- **Type:** An historic neighborhood center anchored by community services.
- **Mix:** Retail shops, commercial services, two health clinics, a library, a school, and a park—all surrounded by housing.
- **Pedestrian Features:** Small-block grid with sidewalks; commercial buildings front on sidewalk. No large parking lots. On two bus routes.
- **Context:** Heart of Madrona, an established neighborhood of individual houses on Seattle's east side.
- **Parking:** On street and in small surface lots.

## Mixed Use Examples

### What is it?

Located on the east side of Seattle near Lake Washington, Madrona is an historic neighborhood with a small but distinctive commercial center. The two-block center grew and thrived with the neighborhood in the trolley-car era but had begun to decline by the 1970s. In the late '70s a children's medical clinic moved into a building in the center. In 1980 a Group Health Clinic took over a vacant grocery store at the main intersection. These two institutions have helped anchor what had been a dying shopping district.

Today, Madrona's center is once again lively, with four restaurants, a variety of shops, and professional offices. A new mixed use building with apartments over shops was recently built at the north end of the center. Within a few blocks of the center are a library, two small parks, and an elementary school. The surrounding neighborhood is made up primarily of individual homes on small lots.

### Why it Works

Madrona's mix of restaurants, shops, apartments, health clinics, and school keep the neighborhood lively from morning to evening. At one and two stories tall, the commercial buildings fit with the neighborhood, and alleys help separate the commercial district from housing on the other side of the block. The relatively dense neighborhood around the center provides customers for neighborhood businesses, and the clinics draw additional customers into the district. People who live nearby can easily walk to shopping, services, or the park. More than 260 homes and apartments are within a five-minute walk, and two bus routes make stops in the center.

Although in hilly terrain, Madrona was built with a pedestrian-friendly foundation of small blocks, narrow streets, and sidewalks. This gives residents short, direct routes to the neighborhood center. In the center itself, wide sidewalks are fronted by bright facades, shop windows and outdoor eating areas. East Union and 34th Streets are relatively narrow arterial roads, making it easy for pedestrians to cross.

### Key Features

The Madrona neighborhood center shows how institutions can complement a small neighborhood center. Together the two health care clinics bring over 40 employees and 125 clients into the district daily, giving the area new vitality and bringing local businesses new customers.



Two health care clinics complement Madrona's neighborhood center by drawing over 150 people each day.

## A Checklist for Mixed Use Planning

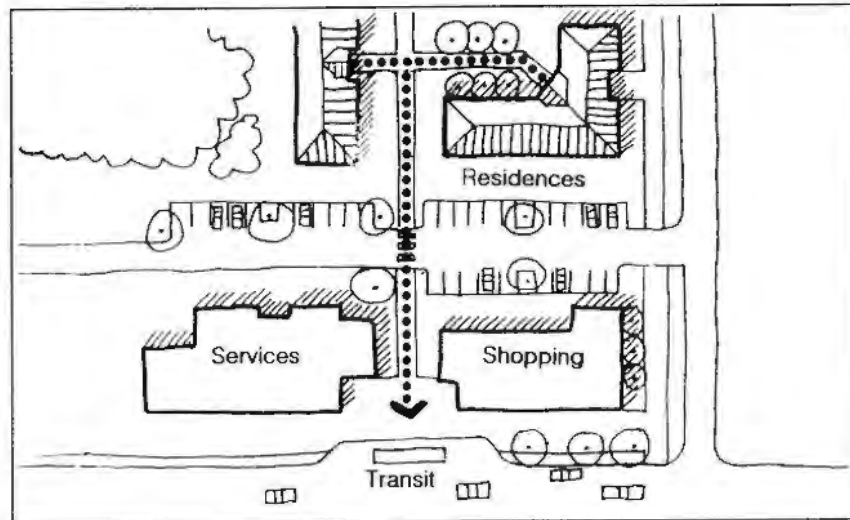

■ Are the uses complementary?



■ Are the uses linked by sidewalks or paved paths?

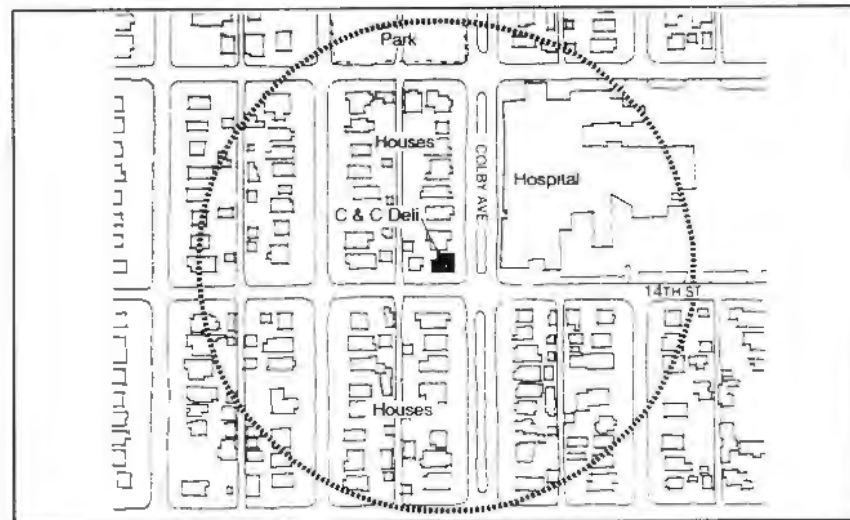

■ Are they within convenient walking distance of each other?

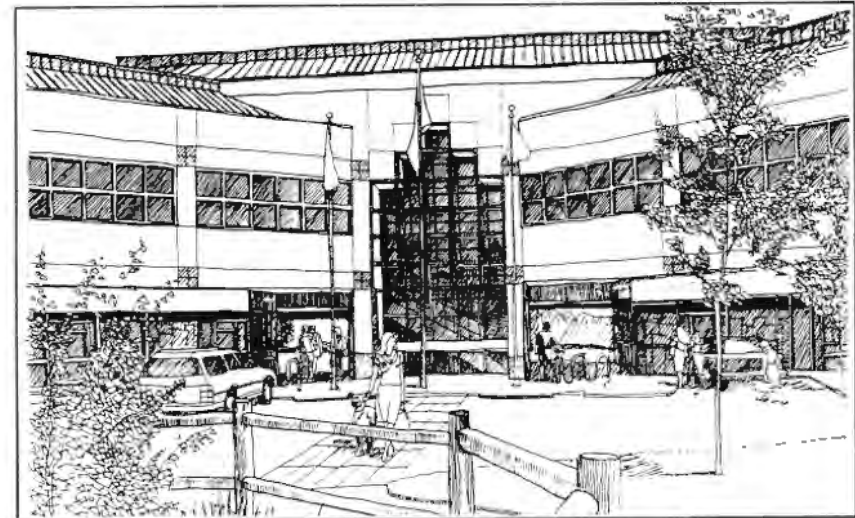

■ Are the walking routes short and direct?

## A Checklist for Mixed Use Planning

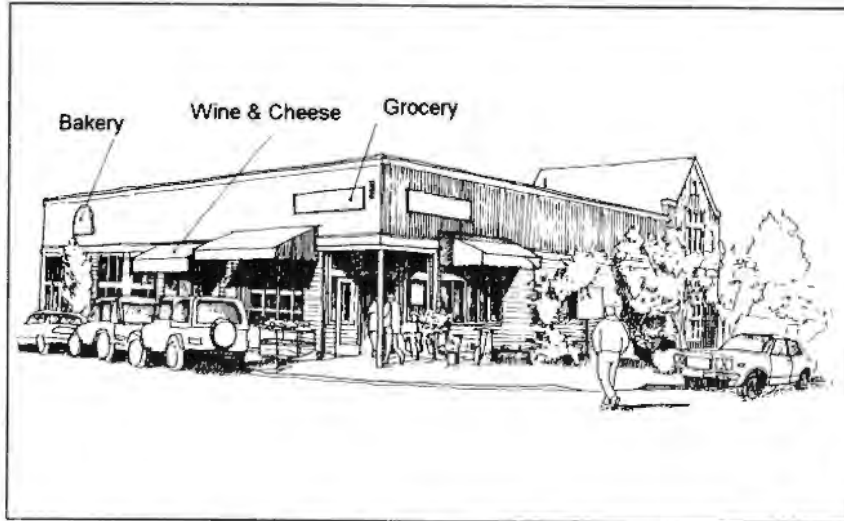

■ Do the buildings fit with and complement each other?

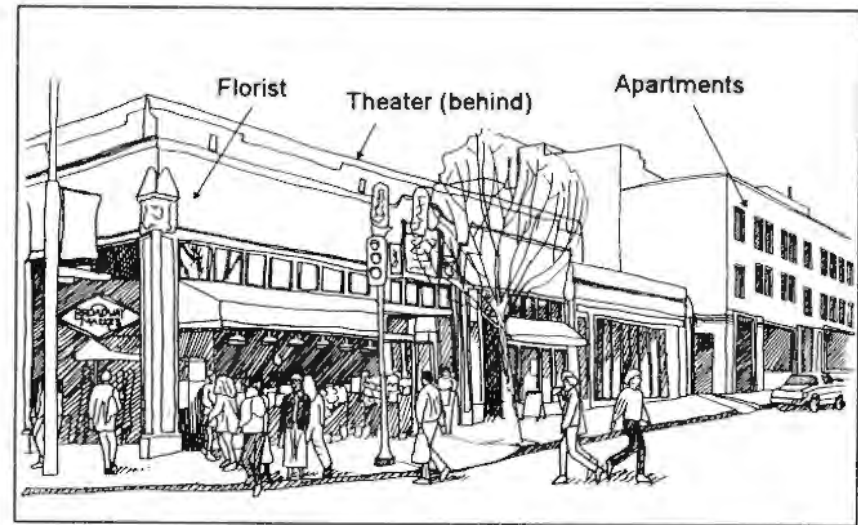

■ Do the uses create activity at different times of day?

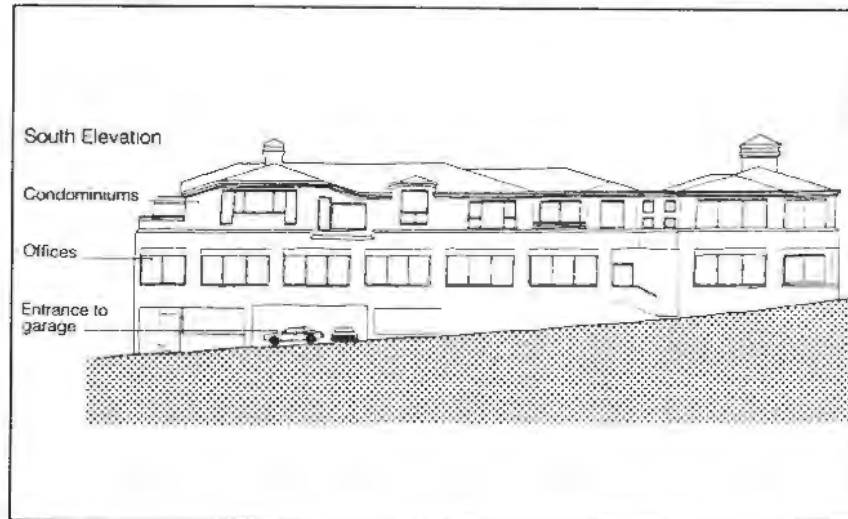

■ Is parking kept out of the pedestrian's path of travel?



■ Do they support one another economically?



## ***Overcoming Institutional Obstacles to Mixed Use***

*Land use planners are now trying to move back toward true community planning—to creating places where daily activities are integrated rather than segregated and where neighborhoods develop their own unique character.*

### ***Re-evaluating the Doctrine of Segregated Use***

In the early 1900s, when many American cities were largely industrial, housing was often built next to factories and people were exposed to noise, smoke, and other unhealthful by-products. By the 1920s public officials had found a logical remedy: divide the city into separate "zones" that would keep factories away from housing. The concept worked well enough that over the years zones were created specifically for stores, and other zones for offices. Zones were used to keep apartments separated from "single-family" homes and even to keep smaller homes apart from larger homes. With the expansion of highways and greater reliance on cars, zones became bigger, and the various land uses that once made up communities were scattered even further apart.

In today's post-industrial economy, many people still take for granted the idea that jobs, housing, shopping, and recreation should be kept a safe drive apart. Community planning has largely become a process of carrying out "zoning" regulations, and planners take great care in creating "buffers" with walls

and landscaping when a grocery store is located too near a subdivision or an office building is built in view of an apartment building. Consumers have become accustomed to this idea of segregated uses, as have the institutions that finance new development projects: Banks now have their own criteria that both discourage mixing of different land uses and insist on designs that favor cars over pedestrians.

Recently, community planners and developers have begun to see that segregated use has much to do with traffic congestion, air pollution, and the lack of character in the suburban landscape. Segregated use has contributed to suburban sprawl and the need to drive for virtually all of life's necessities, while new single-use subdivisions, office parks, and shopping centers have taken on a depressing "sameness." Planners are now trying to move back toward true community planning—to creating places where daily activities are integrated rather than segregated and where neighborhoods develop their own unique character. Mixed use is part of the solution, but the barriers of auto-oriented planning, zoning and financing are slow to come down.

For the community wishing to move toward mixed use development, the first step is to remove some of these institutional obstacles. Planners and public officials must lead the way by re-evaluating local plans and zoning restrictions. Developers must be creative in dealing with conservative financial backers. As shown in the examples in this chapter (and hundreds of others around the Puget Sound region), the task is far from impossible. The following are some mixed use strategies working for communities and developers in the Puget Sound region.

## Overcoming Institutional Obstacles to Mixed Use

*The first requirement for having incremental mixed use development happen on a wide enough scale to affect neighborhood and community design and efficiency is to include opportunities for mixed uses in local plans and then simply allow them to happen.*

— The Urban Land Institute<sup>1</sup>

### Lowering the Zoning Hurdles

The above quote from the Urban Land Institute, a development-oriented think-tank, summarizes the zoning challenge with respect to mixed use. The following are some mixed use zoning techniques that not only allow, but in some cases promote, mixed use.

#### ■ Linking Separate Uses

Most zoning codes ensure that new developments have access to a road and adequate parking, but only recently have they begun to require the equivalent for pedestrians. Mixed use happens naturally when zoning codes promote:

- Sidewalks on both sides of every street;
- Pathways directly linking adjacent development sites;  
or
- Development in small, walkable blocks.

<sup>1</sup> ULI, *Mixed Use Development Handbook*, p. 9, 1989.

Downtown Edmonds shows how small blocks with sidewalks have the effect of mixing uses. Canyon Park Shopping Center, with its walkways and arcades shows how the foundation for mixed use can be built incrementally, even in a suburban, auto-scaled environment.

#### ■ "Spot" Zoning and Overlay Zones

In the past, when a small piece of land was zoned for commercial development within a larger residential zone (or vice versa), it was called "spot" zoning—considered a situation to be avoided. Yet, such "spots" are the makings of "Mom & Pop" stores like C & C Deli and popular neighborhood hubs like Honey Bear Bakery. Spots of neighborhood-oriented commercial zoning can be deliberately designated on the zoning map, or they can be allowed as a matter of policy and approved case-by-case at the request of land owners.

This technique is similar to a well-accepted zoning technique called "overlay zoning." Overlay zones maintain the original underlying zoning designation but modify the zone to allow additional types of development. Whether overlay zones, spot zones, or other flexible zoning techniques, the key is to make sure the development fits in with and complements the surrounding area. In this respect, compatibility is less a matter of land use than it is a matter of good project design. The mixed use checklist in the previous section provides the basic criteria for such design.

#### ■ Allowing Mixed Use Sites and Buildings

In commercial or multi-family residential zones, the zoning regulations can be made flexible enough to give the developer the option of developing a mixed use building or

## Overcoming Institutional Obstacles to Mixed Use

---

site, as long as attention to design preserves the basic character of the area. When such a mixed use option is added to the zoning code, it must be accompanied by design guidelines that ensure the mixed use development complements its surroundings. Again, the mixed use checklist is a starting point for such guidelines. Aside from design standards, mixed use development should not be penalized with extraordinary permit requirements.

### ■ Inclusionary Zoning

Many cities use "inclusionary" zoning to promote mixed use development, especially in and around their downtowns and neighborhood activity centers. In Edmonds, where market forces alone would tend to displace downtown businesses with condominiums, the City uses zoning to ensure that new development maintains the area's character by providing space for shops and offices as well. In Everett, ground-floor shops in Colby Crest are included because zoning requires retail shop-fronts along a City designated pedestrian corridor.

### ■ Flexible Formulas

Strict inclusionary zoning can pose problems for developers. As more communities move toward mixed use zoning, many developers find themselves facing zoning codes that require certain ratios of housing and commercial use in their projects. While the intent of such inclusionary zoning is desirable, rigid formulas may not be in step with project economics and can thwart a mixed use project. A more flexible approach would be to apply mixed use ratios on an area-wide basis. To do so may require an area-wide, or "sub-area" plan (as discussed later in this chapter and in detail in Chapter 1). In Seattle, the

city is moving away from rigid formulas and toward land use combinations and design standards tailored to a specific area.

### ■ Incentives

Rather than require mixed use, a city can give developers incentives to build mixed use projects or projects that bring complementary uses to an area. Incentives such as density bonuses, lower mitigation assessments, and faster processing of permit requests can be built into zoning codes. A city can also promote mixed use projects by offsetting some of the costs of public improvements such as roads and sidewalks.

### ■ Home Occupations

Most zoning codes allow people to run certain types of businesses out of their homes—perhaps the ultimate in mixed use. But "home occupations" are often over-regulated, with excessive permit fees, long waiting periods, and prohibitive criteria that fail to acknowledge today's computer-based, service-oriented economy. A simple way to allow mixed use is to update zoning codes to allow a wider range of home occupations and to make obtaining a home occupation permit a simple, one-stop process with a nominal fee.

### ■ Mixed Housing Densities

The idea that apartments and condominiums should be kept separate from houses emerged early in the 1900s, when local governments began to use zoning as a means of protecting and enhancing the property value of people who owned houses. Today, the notion that different types of housing are inherently incompatible is widely accepted, and apartments are often relegated to zones near highways and shopping centers to serve as "buffers" against noise and automobile



## Overcoming Institutional Obstacles to Mixed Use

fumes. The effect of segregated housing densities is a social segregation as well, with people sorted into different zones according to age, income, and housing preferences.

The perceived "incompatibility" between different types of housing is less a matter of density than design. Too often apartment projects live up to their stigma by being poorly designed and shoddily built. Apartments and houses can co-exist in the same neighborhood and even on the same street—when they are compatibly designed. As with commercial zoning, multi-family spot-zoning can be used to mix housing and generally raise housing densities, so long as the city insists on high quality, compatible design.

### ■ Accessory Dwellings

In the Puget Sound area, affordable housing is rapidly becoming a top priority. A simple way of creating affordable housing is to change zoning to allow homeowners to build "accessory units" or apartments, either within the existing house or in a smaller building on the same lot. In most cases, the owner must live on-site. Again, with appropriate design guidelines, accessory units can provide affordable housing while giving homeowners additional income for mortgages and property improvements.

A good example is the Kitsilano neighborhood in Vancouver, British Columbia, where zoning was changed to allow houses to be subdivided into apartments and accessory units added behind the main houses. Adding an accessory dwelling is subject to a careful design review by the City. The result has been a mixed-density neighborhood that looks much as it did before, except most of the houses now have fresh paint and other renovations. As with other types of mixed use,

accessory dwellings can be thwarted by excessively complicated regulations.

*When an area is designated on the land use map as residential or commercial, that is the time to plan the general layout of the local streets—the pedestrian's transportation system.*

### **Planning on a Pedestrian Scale**

Zoning and other land use regulations are generally based on a comprehensive plan adopted by the city or county. The key element in such a plan is a land use map—typically a very general diagram that divides an area into large zones labeled "residential," "commercial," "industrial," or "agricultural." On the map these zones are bounded by freeways or major arterial roads, with the local road system left up to the individual developer. This is planning on an *automobile scale*, the assumption being that if the zones are linked by highways, transportation has been adequately planned.

This scheme precludes mixed use in two ways: first, the zones on the map are drawn too large, creating distances between housing, shopping, schools and job sites that can only be covered by car. Second, while the plan prescribes development, it fails to prescribe the local road alignments

## Overcoming Institutional Obstacles to Mixed Use

that give that development order and create linkages on a scale suitable to walking, cycling, and transit. Each developer builds roads that serve his or her own project without thought to how individual developments might be tied together. Lacking a basic "skeleton," development takes the amorphous, disconnected form of suburban sprawl. Neighborhoods are isolated from shopping centers, schools from parks, employment centers from services. Dependence on the automobile is preordained, and mixed use on a significant scale is impossible.

The solution is planning on a *pedestrian scale*, planning that zooms in at the neighborhood level, where the *people* are. When an area is designated on the land use map as residential or commercial, that's the time to plan the general layout of the local streets—the pedestrian's transportation system. Pedestrian-scaled planning means mapping out zones based on small blocks rather than vast, shapeless tracts bound by freeways. Local street alignments and zones may be refined when a development project is proposed, but pedestrian-scaled, mixed use planning means that development must be based on an actual plan rather than simply a land use classification.

Such neighborhood-level planning is not uncommon. In the planning profession it is known as sub-area planning. Chapter 1 in this book describes this type of planning and lays out a process for creating a community-based vision of an area's development, converting that vision into a detailed plan, and actively working to carry out that plan.

**The secret to financing mixed use projects, it appears, lies in the developer's age-old, stand-by tactics of perseverance and ingenuity.**

### ***Creative Approaches to Financing***

When asked what obstacles lie in the way of mixed use, developers invariably point to lending institutions that are hesitant to finance mixed use projects. This is especially true in recent years, they say, because lenders, particularly those that finance real estate development, are in a conservative mode after the excessive building of the '80s and the recession of the early '90s. To lenders, mixed use is a departure from tried and true formulas, and to many it's not worth the risk. Still, it is in the developer's nature to find a way around obstacles: Many new mixed use developments have opened in the past few years, and many more are under construction.

Interviews with these successful mixed use developers produced no magic formulas for obtaining financing. The secret, it appears, lies in the developer's age-old, stand-by tactics of perseverance and ingenuity. However, for the mixed use examples reviewed in the course of writing this chapter, success often hinged on one or more of the following techniques:

## ***Overcoming Institutional Obstacles to Mixed Use***

---

### ■ Pre-Leasing

A mixed use development, like any development project, will be more attractive to a lender if the project already has a commitment from tenants to occupy the space when the project is built. This is especially true for the office and retail space in projects that mix commercial use with residential use.

### ■ Flexible Tenant Space

In mixed use buildings that have ground floors reserved for commercial use, lenders may look more favorably on the project if the commercial spaces can easily be divided or combined to fit a variety of tenants' needs.

### ■ Local Lender

A local bank that is familiar with the developer's track record or has a commitment to the success of businesses in the community may be willing to finance a mixed use project more readily than other lenders. A partner with a proven local track record of successful development projects can open the door to financing.

### ■ Public Partner

Having a government agency as a partner or tenant can give a project added credibility. In Everett, a developer wanted to renovate the Monte Cristo hotel into apartments and ground floor commercial space. The project gained momentum when the City of Everett Arts Commission agreed to lease a large portion of the commercial space. The renovation is nearly complete.

### ■ Innovative Funding Sources

Mixed use developers are finding new funding sources, including insurance companies, pension funds, partnerships with financial institutions, and affordable housing subsidies. The developer of Colby Crest and the Monte Cristo has tapped a federal tax subsidy source by building affordable housing. The Washington Community Reinvestment Association represents a group of lenders who have pooled their resources to help fund these types of projects.

### ■ Transit as a Substitute for Parking

In urban areas, and especially in affordable housing aimed at students and older people, a developer can save money by building less parking. But a lender will likely be concerned that inadequate parking will keep people from leasing apartments and retail space in the project. In the case of Colby Crest in a downtown Everett location, having a variety of services within walking distance and a location on a major transit route helped sell the project despite the fact that there are only 32 parking spaces for 69 apartments. Two years after opening, the project has extra parking space and a waiting-list of people wanting to rent apartments.

### ■ Splitting the Uses

Mixed use doesn't always have to be in the same building, or even on the same site. Two individually financed projects, side-by-side and linked by walkways, might easily be financed where the same uses on a single parcel would make a lender balk. Splitting one development project into two projects can also allow the developer to seek two different sources of financing.

## ***Overcoming Institutional Obstacles to Mixed Use***

---

### ■ Mutually Supportive Mix

A lender may be less likely to balk at a mixed use project if it is apparent that the uses support each other economically. Higher density housing, both in the mixed use project itself and in the neighborhood, for example, can help "sell" the retail portion of a mixed use building. A small, neighborhood-oriented commercial use may look better in an economic feasibility study if the neighborhood is reasonably dense.

### ■ Phased Development

For a mixed use development site, it may be possible to finance and build the source of assured income (usually the residential part of the project) first, then use the income stream to help finance the other use.

### ■ Self Financing

It goes without saying, but for the developer with financial resources, self-financing is always an option. In Everett, a local, civic-minded developer recently built a townhouse/office/retail building on a prominent downtown corner. The same developer is actively working to bring specialty retail uses that complement one another into neighboring buildings.

*So the first question, and I think by far the most important question - about planning cities is this, "how can cities generate enough mixture of uses?"*

*Jane Jacobs:  
The Death and Life of Great American Cities*

## ***Conclusion***

---

### ***Conclusion***

Mixed use is an old concept, in that building communities where people could live, work, shop, and have fun close to home was the norm before this century. Mixed use is a new concept, too, in that it has become apparent that segregated use, now part of our thinking, habits, and laws, is an auto-scaled pattern of development that takes a financial, environmental, and social toll. But mixed use is really a simple concept: Complementary uses, within easy walking distance of one another, linked by safe, direct walkways.

Mixed use is essential to creating communities where people don't have to depend on cars for all of their daily needs. The ability to walk to the store, to the park, to school, or even to work means one less car waiting at a congested intersection, a bit less gasoline burned, and one less sputtering exhaust pipe. For people who hesitate to try carpooling or taking the bus, mixed use means being able to do so and still be able to accomplish errands like banking, shopping, and eating out.

Accomplishing mixed use doesn't require a radical change in the way we plan and develop communities; it simply requires that we move toward planning at a pedestrian scale—at a neighborhood level. Mixed use can be achieved in a variety of ways: through sub-area planning and innovative zoning, a local government can create a regulatory environment that fosters links between different land uses and promotes mixed use development projects. And, through perseverance and creative financing, developers can build—and are building—successful mixed use projects of all types and sizes.



## ***Chapter 6: Barrier-Free Pedestrian Access***

---



- Introduction***

- Summary of Barrier-Free Requirements***

- Disabilities and Mobility***

- Barrier-Free Site Design***





## Introduction

*Planning and design that accommodate people with disabilities is good planning and design for everyone.*

### **ADA: Toward Barrier-Free Communities**

The automobile is a symbol of mobility for many Americans. Yet, in communities designed around automobiles, driving is not so much a choice as it is a necessity. Long distances between housing and jobs, barriers between neighborhoods and services, and a lack of sidewalks make walking impractical and make using public transit inconvenient. While only occasional nuisances for most people, these features of auto-oriented design severely limit the mobility of people for whom a trip to the store or to work already presents many challenges — elderly people, people with disabilities, and children.

Past efforts to help provide mobility for people with disabilities have been incremental: Over time, there have been requirements for wheelchair ramps, then special parking spaces, and now elevators and other aids that help people with disabilities travel. Still, parts of the transportation system have yet to be addressed. A bus stop, for example, may be barrier-free, and a nearby office building may be as well, but the lack of a single curb ramp or a sidewalk between the two can mean the difference between a simple, everyday trip and an exercise in frustration.

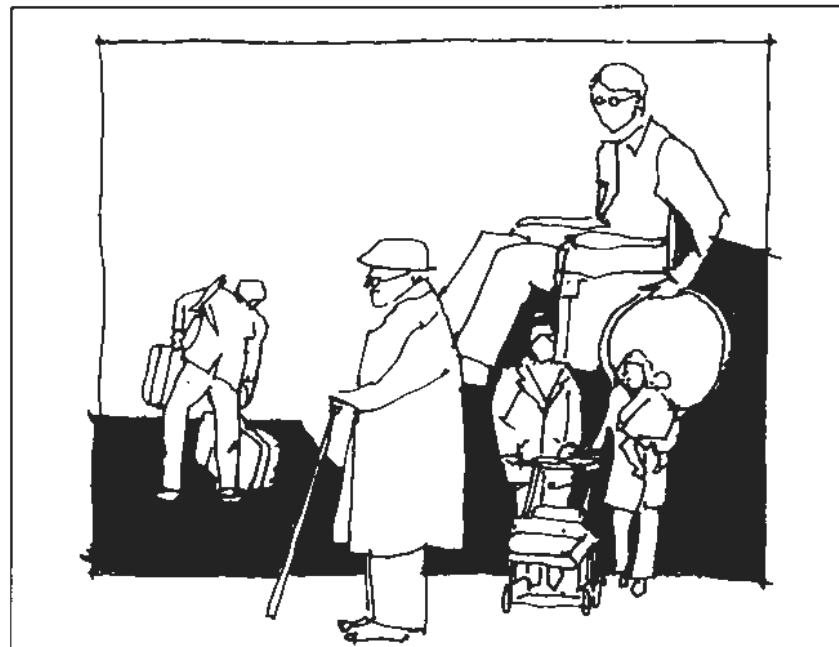

*Most people will experience a disability that makes travel difficult.*

With the passage of the landmark Americans with Disabilities Act (ADA) of 1990, government and business are taking greater interest and a more systematic approach to barrier-free design. ADA is a sweeping federal law intended to give people with disabilities better access to employment, services, and transportation. ADA is aimed at eliminating barriers for people with disabilities, but the benefits of barrier-free design go further: Places that are accessible for people with disabilities are accessible for everyone. In a community where pedestrian travel is safe, easy and convenient and transit is easily accessible, everyone gains choices about how and where they go.

## ***Introduction***

---

Barrier-free design is not only about people who use wheelchairs, but people who have sight and hearing impairments, people who use crutches, canes, or walkers, and people who have problems with coordination, strength, stability, or stamina. People with mental disabilities also must be considered. Approximately 43 million Americans today are disabled in some way. Seventy percent of Americans will, at some time in their lives, have a disability that makes walking or climbing stairs impossible. Barrier-free design is important to everyone.

This chapter is an introduction to barrier-free design. It provides:

- An overview of parts of ADA and Washington State barrier-free requirements that apply to transit-supportive site planning;
- An understanding of the barrier-free needs of people with disabilities; and
- Some specific barrier-free site design guidelines.

## Summary of Barrier-Free Requirements

---

### **AOA - An Overview**

ADA sets new accessibility standards for land development projects as well as programs and services. The new standards apply to transit facilities, job sites, public and commercial buildings, and public places and services. ADA is aimed at ensuring that people with physical or mental disabilities have access to basic "life activities," especially to transportation. The Act provides:

- A national mandate to eliminate discrimination against people with disabilities;
- Consistent standards for barrier-free access;
- A central role for the federal government in protecting people with disabilities; and
- Congressional authority behind all of these efforts.

### **Title I. Employment**

By July 26, 1994, employers with 15 or more employees must reasonably accommodate the disabilities of qualified job applicants or employees.<sup>1</sup> This may mean providing on-site access, including access from bus stops, through parking and landscaped areas to the work place.

### **Title II. A. Public Services**

New or altered public buildings, streets, parks and other facilities must be made accessible, along with any new government services, programs, and activities. Resurfacing a public street, for example, is an alteration that can trigger an obligation to install curb ramps. Public agencies must also make a "good faith effort" to make their existing facilities and programs accessible.

---

<sup>1</sup> Employers with 25 or more employees are already required to comply.

### **Title II. B. Public Transportation**

ADA lays out a timeline by which new buses, rail vehicles, and vans must be made accessible to people with disabilities. Transit facilities undergoing alterations after January 1992 must have an accessible route of travel linking the site's activities and services if the cost of making the route accessible does not exceed 20% of the facility alteration cost.<sup>2</sup>

### **Title III. Public Accommodations**

Restaurants, hotels, stores, theaters, museums, or other such "places of public accommodation" may not discriminate against people with disabilities. To the extent practical, existing physical barriers must be removed, and all new or altered facilities must be accessible.

### **Title IV. Telecommunications**

Telephone companies must provide communications services for people with speech or hearing disabilities.

### **Washington Administrative Code**

In Washington State, the national Uniform Building Code (UBC) is used as the State Building Code. Following passage of the ADA, Chapter 31 of the UBC was amended to incorporate the ADA and relevant federal housing regulations. The Washington Administrative Code<sup>3</sup>, implementing the UBC, has also been amended and should be used in reviewing barrier-free aspects of building and site plans before permits are issued.

---

<sup>2</sup> Federal Register, Vol. 56, No. 144, July 26, 1991.

<sup>3</sup> Washington Administrative Code, Ch. 51-20, 21, & 31.

## Disabilities and Mobility

*ADA is a new and complex set of requirements that will undergo many tests and interpretations in the next few years. Public officials, developers and business owners need to keep up as state and federal regulations evolve.*

### **Understanding Mobility Needs of People with Disabilities**

Over time, building and site planning standards have been refined to ensure easy access for people who rely primarily on their cars for transportation. Local zoning codes, for example, contain detailed specifications concerning driveways and the number and size of parking spaces, but often fail to adequately address sidewalks and internal pedestrian circulation. For people with disabilities, auto-scaled and auto-oriented design standards can block rather than facilitate mobility.

Because of ADA, planners, builders, and business owners must learn to spot and avoid typical barriers. Part of the learning process will be to gain an understanding of the basic mobility needs created by various kinds of disabilities. The following are a few key considerations.

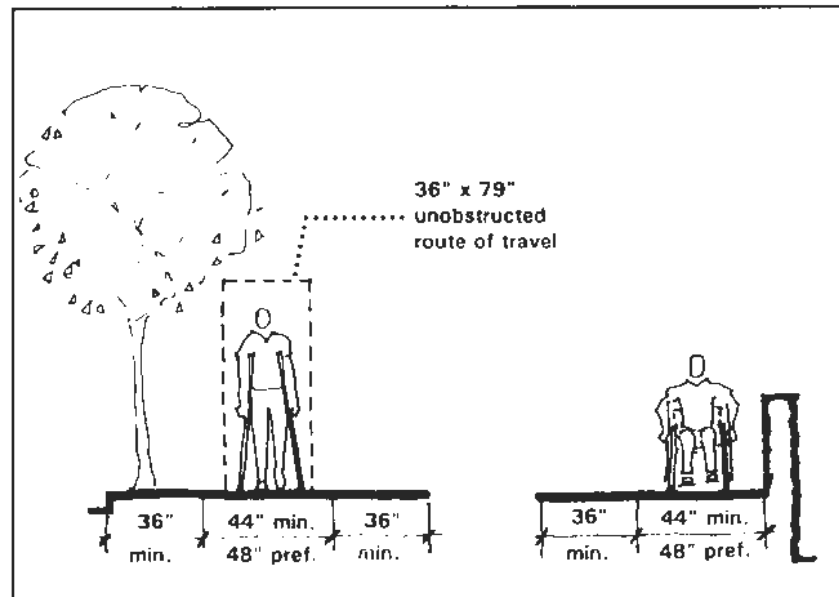

*Adequate space is essential for people with disabilities to maneuver.  
(Source: Federal Register, Vol. 56, No. 173, Sept. 6, 1991.)*

### **Space and Maneuverability**

How much space a person needs for maneuvering depends on both physical ability and on use of any special aids such as canes, walkers, or wheelchairs. Spaces designed to accommodate people using wheelchairs are generally adequate for people with other disabilities. Assuring adequate space means:

- Providing adequate clearance and width in passageways, doorways and turning spaces;
- Eliminating anything that partially obstructs a walkway; and

## Disabilities and Mobility

- Assuring adequate room to turn a wheelchair where a ramp meets a walkway (a 60-inch diameter space is standard).

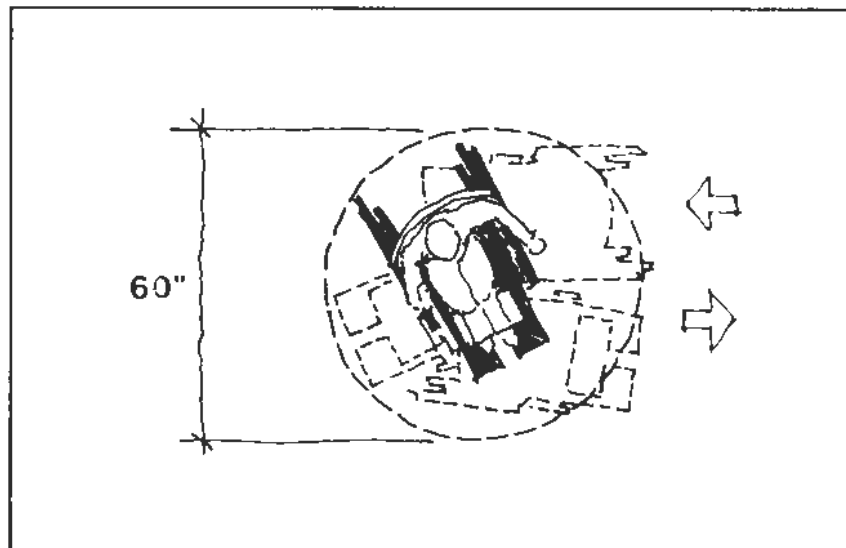

Wheelchair maneuverability is a good gauge for tight spaces.

Source: *Accessibility Design for All, An Illustrated Handbook*, Allan, Barbara et al.

### Reach and Manipulation

Many people have limited use of their hands and arms, which affects their ability to reach and grasp or twist. Door openers, ticket machines and other devices that require reaching or turning need to be designed to be used by everybody. These design considerations include:

- Using lever-type controls instead of buttons, knobs or other controls that require turning movements;
- Placing these controls at or below 48 inches from the floor to meet most peoples' needs;

- Assuring that the maximum pressure required to open a door is eight pounds;
- Using levers, large, easy-to-push buttons or movement activated controls, especially to open doors or dispense tickets; and
- Assuring that the location and design of these devices also work for people with vision and other impairments.

### Sight and Sound

Most people with sight impairments can travel independently as long as paths of travel are free of obstructions. Visually-impaired pedestrians who use canes to sense their routes of travel need to have tactile cues both to orient them to their location and to alert them to hazards and barriers. Designing for people with vision impairments includes:

- Placing benches, low-hanging or low-posted signs, overhanging stairways, light standards, utility poles, trash receptacles and other street furniture where they won't interfere with or block a walkway;
- Providing easily recognized (standardized) "textural cues" to alert people to steps, curbs, or drop-offs or other hazards; and
- Assuring that vertical barriers (walls, fences, barricades) used for safety or to guide pedestrians through an area are "cane-detectable" -- at least 27 inches high from the ground.

People with hearing impairments need visual warnings and directions. Good design for these people includes:

- Providing signs that are clear, easily recognized, and well-located; and
- Where there are special hazards, providing flashing warning lights.

## Disabilities and Mobility

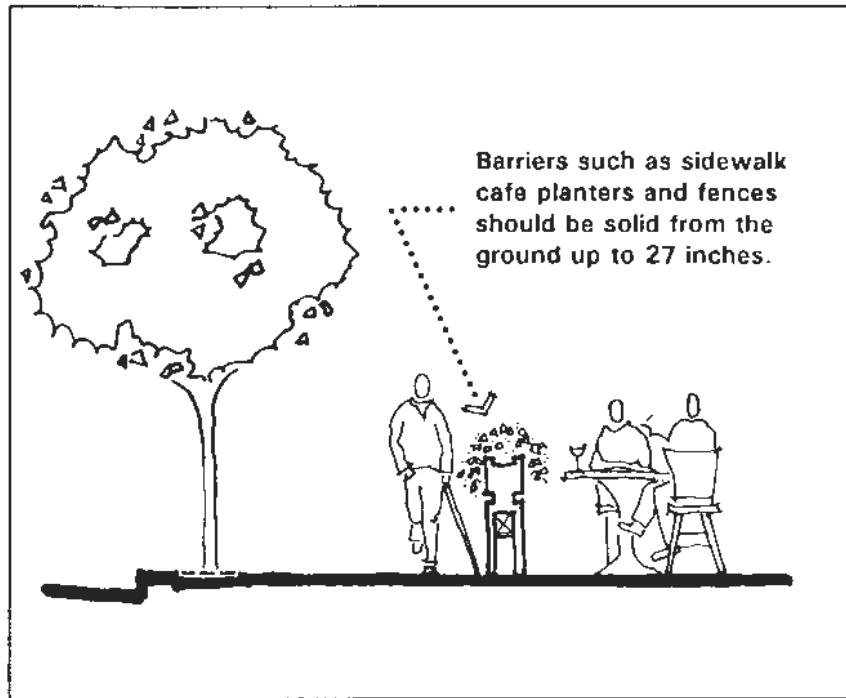

People with sight limitations need cane-detectable warnings of hazards.

### Strength and Stamina

Many people have problems with coordination, strength, stability or stamina which slow or restrict their movement. For these people, trips over 100 feet even on level ground can be exhausting. Distance, slope, weather protection, and rest areas are all important considerations in barrier-free site design. Design details include:

- Planning travel routes to minimize slope and distance;
- Providing resting places with benches along the route of travel, especially if there is a slope or flight of stairs;
- Providing weather protection at bus stops and other waiting places;
- Providing weather protection along sidewalks with arcades or canopies;
- Creating firm, well-surfaced walkways;
- Limiting the use of steps and other grade changes; and
- Locating building entrances close to one another and to transportation facilities to limit travel distance.

## Disabilities and Mobility

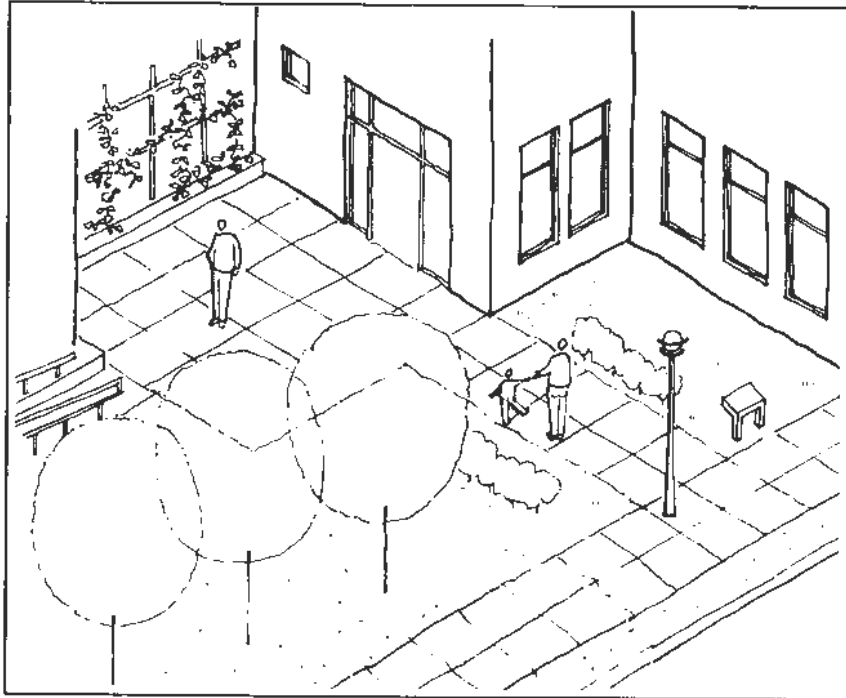

*Direct routes and simple signs help guide the pedestrian to common destinations.*

### ***Understanding and Recognition***

Pedestrian routes that are easily followed help people with mental disabilities (as well as tourists and people who don't speak a lot of English) get to their destinations safely. Complex, indirect routes can confuse and disorient anyone and discourage them from taking the trip. Good design to encourage understanding and recognition includes:

- Using simple signs with consistent symbols and colors and most importantly, high contrast (light/dark) design;
- Using clear, simple, non-serif lettering;
- Using the International Symbol of Access as appropriate to designate the barrier-free route of travel; and
- Sizing and locating signs to take into account viewing distance, changes in route direction, and the particular characteristics of the site.

## Barrier-Free Site Design

*The accessibility of a place depends on a continuous barrier-free path of travel - both within the site and between the site and adjacent activities. Planning for accessibility means thinking through the disabled person's trip from beginning to end.*

### Barrier-Free Site Design

Truly barrier-free site design goes beyond accessible parking spaces and building entrances. The accessibility of a place depends on a continuous barrier-free path of travel — both within the site and between the site and adjacent activities. Accessible buildings need to be linked together as well as to bus stops and other transportation facilities via accessible walkways. Planning for accessibility means thinking through the trip a person with a disability makes from beginning to end (a technique that makes for good, pedestrian-friendly site planning in general).

This section highlights some key design considerations, focusing mainly on the area between buildings and public transportation facilities. More complete information can be found in the ADA Accessibility Guidelines and Washington State Building Code (WAC 51.20). These and other sources are listed in the bibliography.

### Location

Often overlooked is the issue of location: A site located where a large number of people live and work is more accessible than a remote site; likewise, a site located on flat terrain requires fewer special access features such as long ramps, which can be expensive. A site in an outlying area may be less expensive, but making such a site accessible and providing accessible transportation services to it is likely to cost more in the long run. Location is especially important for public services such as schools, government offices, parks, and hospitals.



*Access is better when a site is near where many people live and work.*



## Barrier-Free Site Design

### Site Access

A basic element for a barrier-free site is an accessible route from where people walk onto the site to the door of each building. If a building is set back in a parking lot, a barrier-free path should connect the building entrance to sidewalks at the perimeter. Where possible, setbacks should be minimized, placing the building entrance closer to the sidewalk on the street. Buildings or activities on a single site or on sites adjacent to one another should be connected by an accessible route that is short and direct.

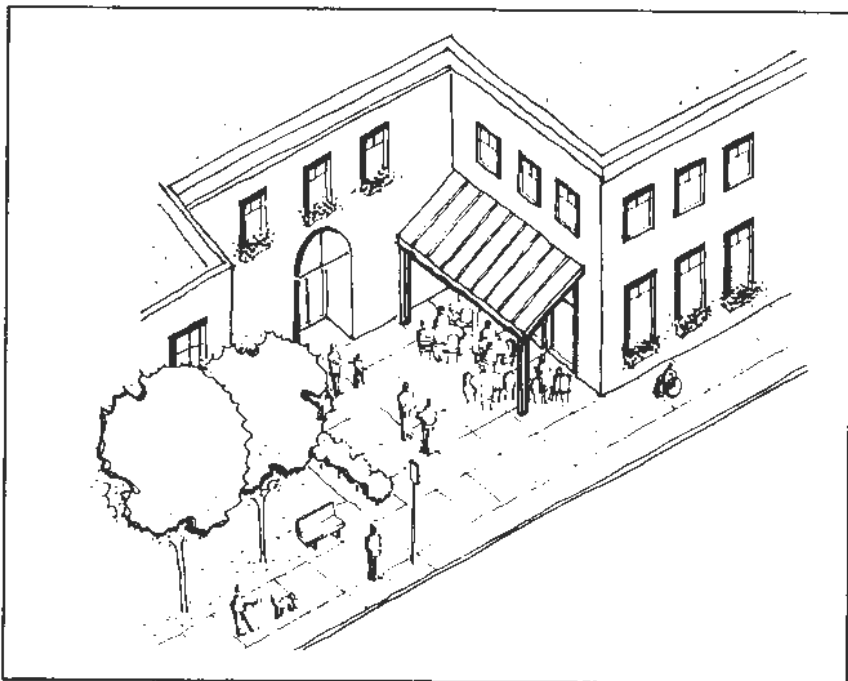

Accessible building entrances are key points along an accessible route.

Source: *Accessibility Design for All, An Illustrated Handbook*, Allan, Barbara et al.

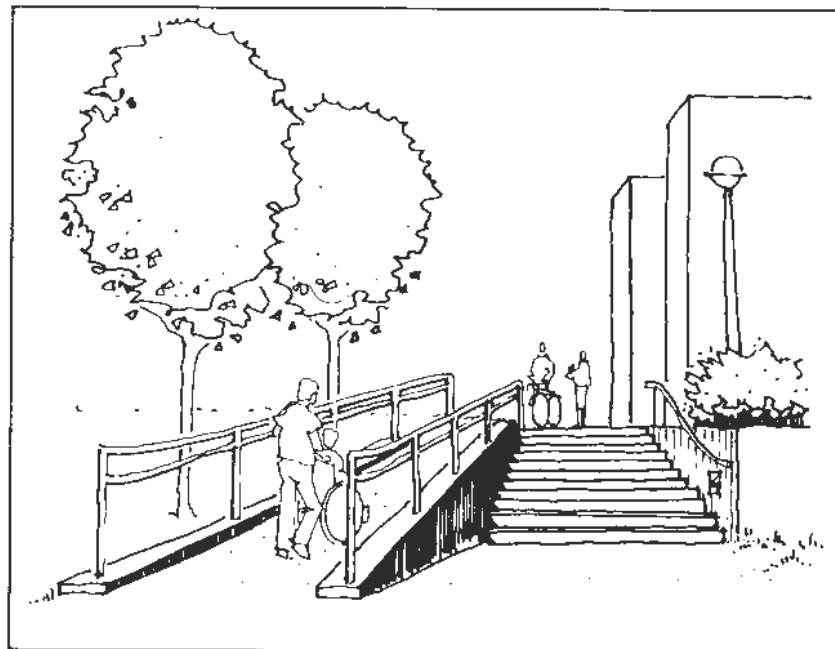

Ramps, rather than stairs, allow easy access for everyone.

Locating parking for disabled drivers and passenger loading zones in convenient places near barrier-free building entrances is essential for disabled people who drive or rely on dial-a-ride services. The pathway between these facilities and building entrances needs to be well-surfaced and free of barriers and obstructions. It does no good to have an accessible building connected to the path of travel if there is no access from the parking lot to the sidewalk. Putting in a ramp, instead of stairs, is an inexpensive way to connect accessible facilities and provides universal access.

## Barrier-Free Site Design

Accessible walkways on neighboring sites need to be linked together to form an accessible network of routes between adjacent activities and buildings.

### Accessible Routes

ADA requires at least one clearly-defined, accessible route leading from nearby bus stops, accessible parking spaces, and public streets or sidewalks to an accessible building entrance. The accessible route must be the most practical, direct route leading to a building entrance, rather than one that obligates people with disabilities to take long, circuitous routes to remote entrances. A route that is shared with vehicle traffic, such as a paved driveway, is not considered an accessible route.

Accessible walkways on neighboring sites should be linked together to form an accessible network of routes between adjacent activities and buildings. An accessible network not only provides access for people with disabilities, but greatly reduces walking distances for pedestrians in general. Without such connections, people must take long routes, traveling out to the public-street and then back into the adjacent development. Short, direct routes between activities makes a site more accessible and encourages walking.

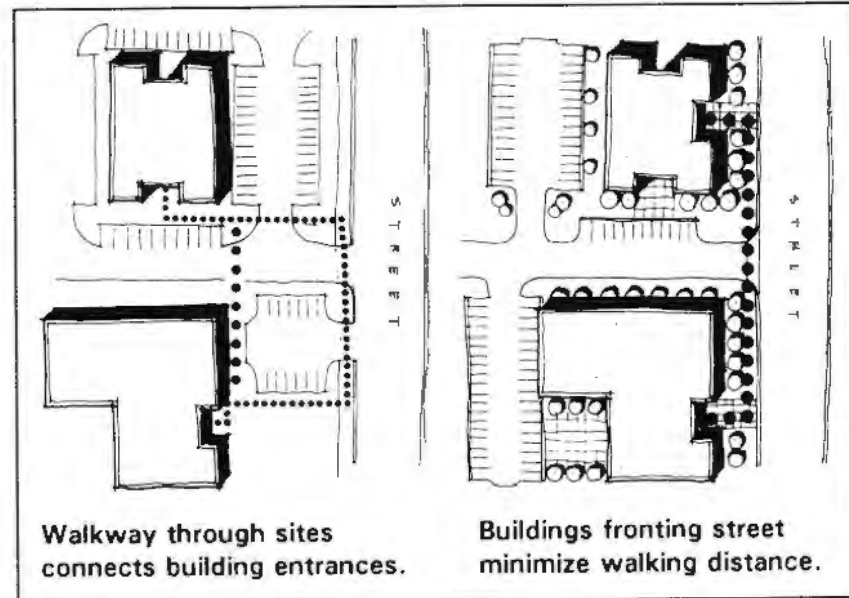

Accessibility means a direct, continuous route to and through the site.

Source: *Accessibility Design for All, An Illustrated Handbook*, Allan, Barbara et al.

Physical guides that people can feel will help direct a person with impaired vision safely along a walkway. A consistent pavement and edging is especially helpful in open areas such as plazas or courtyards. Abrupt changes in elevation should be avoided, and hazards or obstructions should be kept at least three feet outside the edge of an accessible route. Overhanging stairways, tree branches, or signs are especially hazardous to visually impaired people. Pavement "lips," grates, drains, and swales should be kept out of walkways whenever possible.

Proper maintenance is essential: Cracks in pavement, depressions, ridges, and potholes are hazards that can undermine an accessible route.

## Barrier-Free Site Design

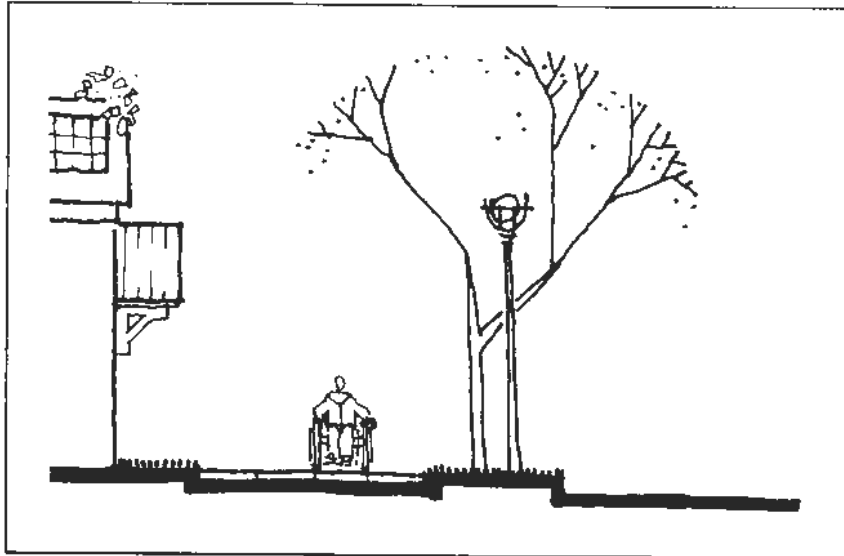

*A wide, firm, and unobstructed surface makes a route accessible.*

### Characteristics of an accessible route:

- Pavement at least 44 inches wide;
- Unobstructed overhead clearance to at least 79 inches;
- Slopes no greater than 1:12 (any slope greater than 1:20 is considered a ramp) with cross-slopes less than 1:48;
- Firm and stable surfaces (concrete, asphalt, etc.);
- A surface that doesn't become slippery when wet;
- Protection provided at any hazardous edge;
- Minimal use of expansion joints (and joints kept as narrow as possible, preferably under 1/2 inch in width);
- Rest areas adjacent to the traveled path;
- Lighting along walkways; and
- No objects protruding into the accessible route.

### Accessible Entrances

Parking, site entrances, and waiting areas should be as close as possible to building entrances. Locating buildings or activities as close as possible to a street and a bus stop makes the activities convenient to bus patrons, people with disabilities, and other pedestrians. Accessible building entrances should be located within 300 feet of adjacent bus stops, public sidewalks or streets, and a maximum of 100 feet from reserved parking or passenger loading zones. At least half of all public entrances should be accessible, including the primary public entrance.

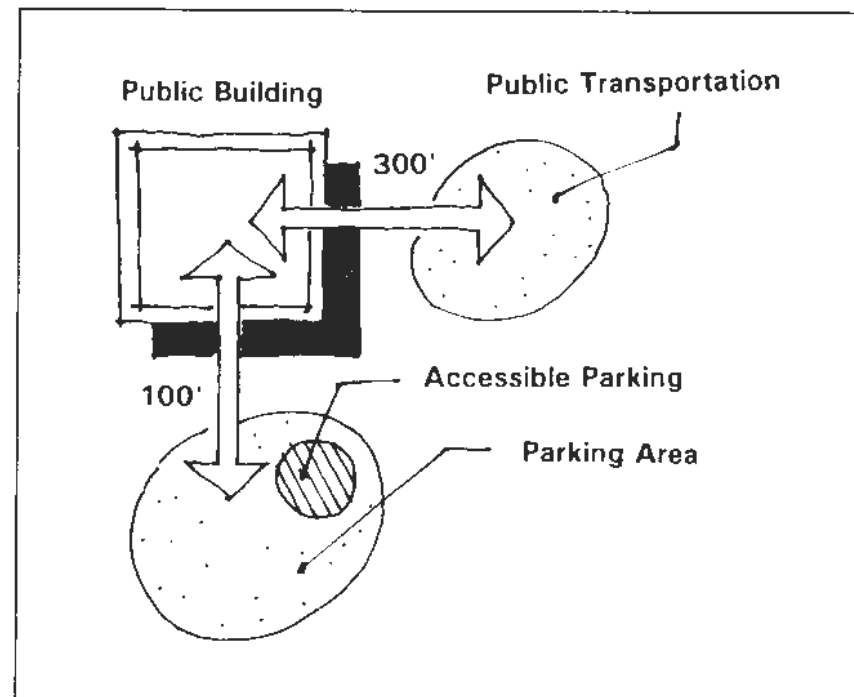

*Transit accessible parking must be near building entrances.*

## Barrier-Free Site Design

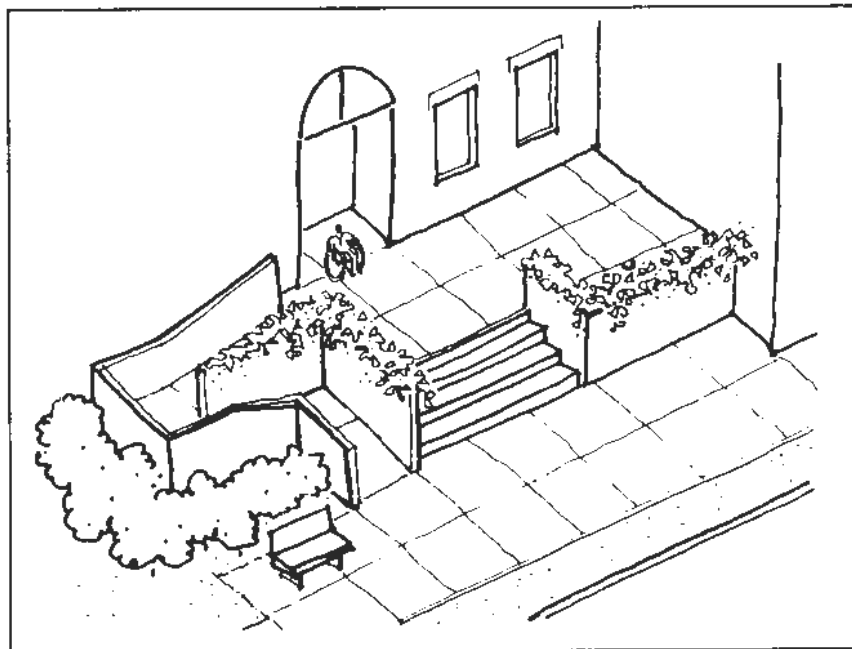

*A landing in front of entrances provides space for maneuvering.*

*Source: Accessible Design for All: An Illustrated Handbook, Allen, Barbara, et al.*

### Characteristics of accessible entrances:

- Located at ground level (at grade);
- The main entry (not loading or service entries);
- Marked by the International Symbol of Access (unless all entrances are accessible);
- Doors require a maximum of 8 pounds of pressure to open (automatic opening devices are desirable); and
- A five-foot wide, level landing in front of the entrance.

### Waiting and Rest Areas

Many people with disabilities lack stamina, as do many elderly people. While not required by ADA, accessible waiting and rest areas along paths and walkways provide welcome relief and make a site more attractive and enjoyable. There bus stops or dial-a-ride stops are located at a site, waiting areas can be provided in cooperation with the transit service provider.

Characteristics of accessible waiting and rest areas:

- Located to the side of pathways;
- Accessed without significant change of grade or use of stairs;
- Equipped with benches that have arm rests; and
- Provide space for wheelchairs adjacent to the benches.

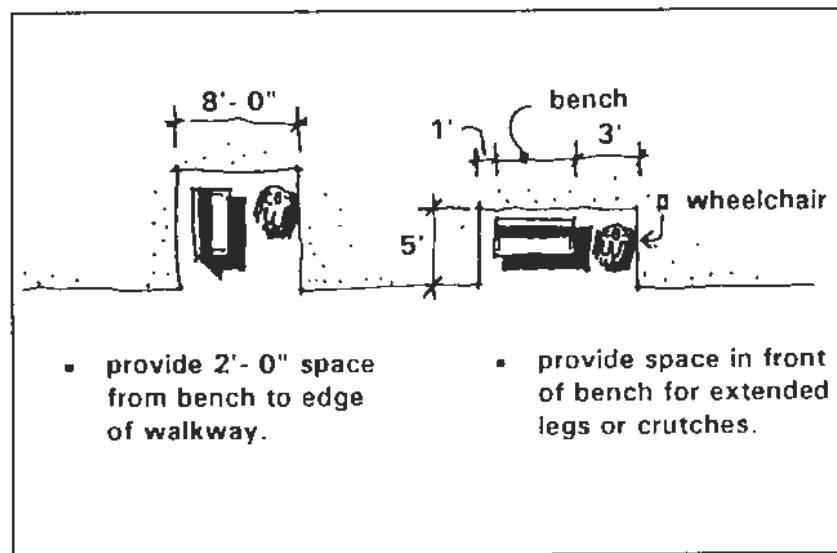

- provide 2'- 0" space from bench to edge of walkway.
- provide space in front of bench for extended legs or crutches.

*Rest areas along walkways make a route accessible and attractive.*

## Barrier-Free Site Design

### Accessible Parking Spaces

Accessible parking must be located in the lot nearest to the accessible building entrance. Barrier-free parking requirements now include spaces for both cars and vans. Accessible parking spaces for cars require a 5-foot wide access aisle which allows a person to transfer independently from a wheelchair to an auto. For vans an 8-foot aisle provides adequate space to operate a wheelchair lift. Accessible parking spaces should be marked by the International Access Symbol on the pavement and a sign indicating that the spaces are reserved for use by people with disabilities.

The accessible parking space must have direct access to a walkway so that the person with a disability can avoid the hazard of entering a vehicle traffic lane. If a curb or stairs lie between the access aisle and the walkway to the door, a ramp or "curb-cut" must be provided. Curb ramps must not project into the parking space or the access aisle, and the curb ramp must be aligned with the access aisle to prevent it from being blocked by the car or van. Where the ramp meets the walkway, there should be adequate space to turn a wheelchair. In addition, if there is a fire lane between the accessible parking spaces and an accessible entrance, a marked walkway must connect the two.

### Characteristics of accessible parking spaces:

- Car-accessible spaces (8 feet wide with a 5-foot wide access aisle);
- Van-accessible parking spaces (8 feet wide with an 8-foot-wide access aisle and a vertical clearance of 114 inches);
- Each space identified by a sign using the International Symbol of Access and "State Disabled Parking Permit Required" must be on the sign;
- A surface slope no greater than 1:48; and
- Firm, smooth, and slip-resistant surfaces.

<u>Total parking spaces in lot</u>	<u>Required minimum # of accessible spaces</u>
1 - 25	1
26 - 50	2
51 - 75	3
76 - 100	4
101 - 150	5
151 - 200	6
201 - 300	7
301 - 400	8
401 - 500	9
501 - 1000	2% of total
1001 and over	20 plus 1 for each 100 over.

*Accessible Parking Space Requirements*  
 (Source: Federal Register, Vol. 56, No. 173, Sept. 6, 1991.)

## Barrier-Free Site Design

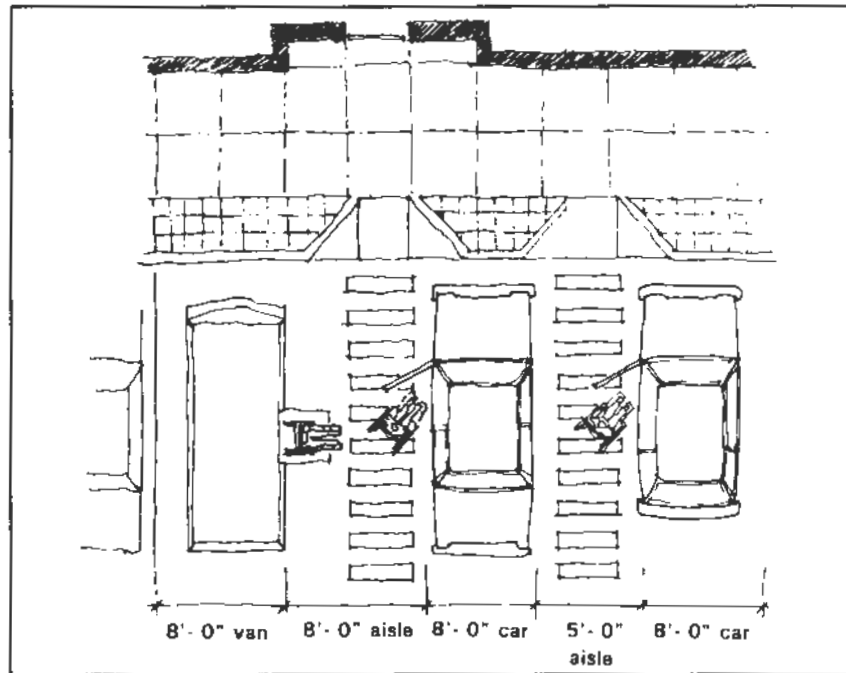

Accessible parking spaces must be connected to an accessible route.

Source: *Accessibility Design for All: An Illustrated Handbook*, Allan, Barbara et al.

### Drop-off and Loading Zones

Passenger drop-off and loading zones are not required by ADA but are recommended for hospitals, medical offices, restaurants, theaters, and other large, service-oriented land uses. Passenger loading zones provide space for people to get into and out of vehicles without interfering with traffic on the street. Properly designed passenger loading zones include sufficient space to transfer from a vehicle to a wheelchair without interfering with pedestrian movement on the sidewalk. Access to the walkway must be provided by curb cut or level transition.

### Signs

The International Symbol of Access must be used to identify accessible facilities and routes, and to give people direction to these facilities. Signs that rely on simple pictures and color are most effective. For people who are blind or have limited vision, raised symbols and Braille annotations and "tactile cues," usually in the form of a change of texture in the walkway surface, are essential in providing clear, continuous direction. Tactile cues can also help warn blind people of hazards: The grid pattern on wheelchair ramps, for example, signals the ramp's presence. Signs must be placed where they can be easily seen, but not in the path of travel. Sandwich board signs and other temporary signs are special problems for people who cannot see them.

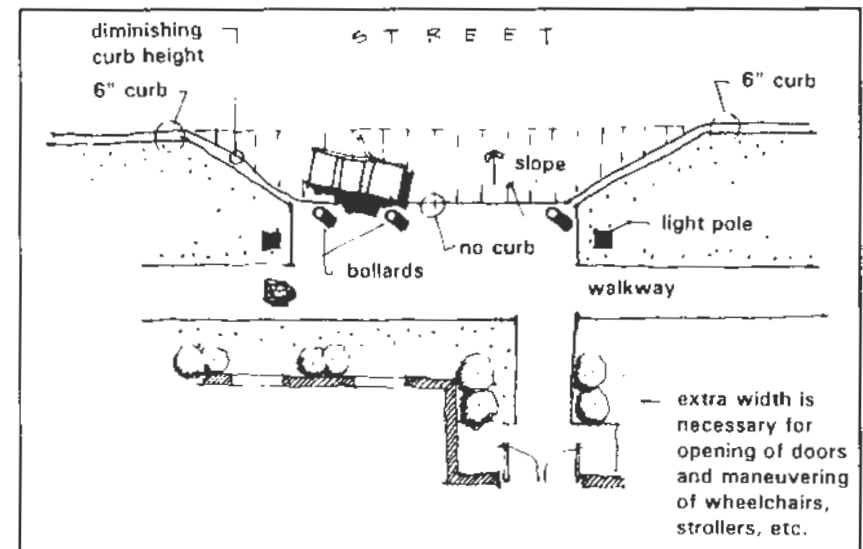

Passenger loading zones must be linked to buildings by accessible routes.

Source: *Accessibility Design for All: An Illustrated Handbook*, Allan, Barbara et al.

## Barrier-Free Site Design

### Sidewalks

Under ADA, all new sidewalks must be accessible and all existing sidewalks must be made accessible with either curb cuts or ramps by January 26, 1995<sup>4</sup>. Accessible walkways must be free of obstructions (such as the all-too-common utility pole in the middle of the sidewalk). A barrier-free sidewalk must have unobstructed clearance of a minimum of 36 inches wide. Curb cuts/ramps must be provided on *both* sides of the intersection.

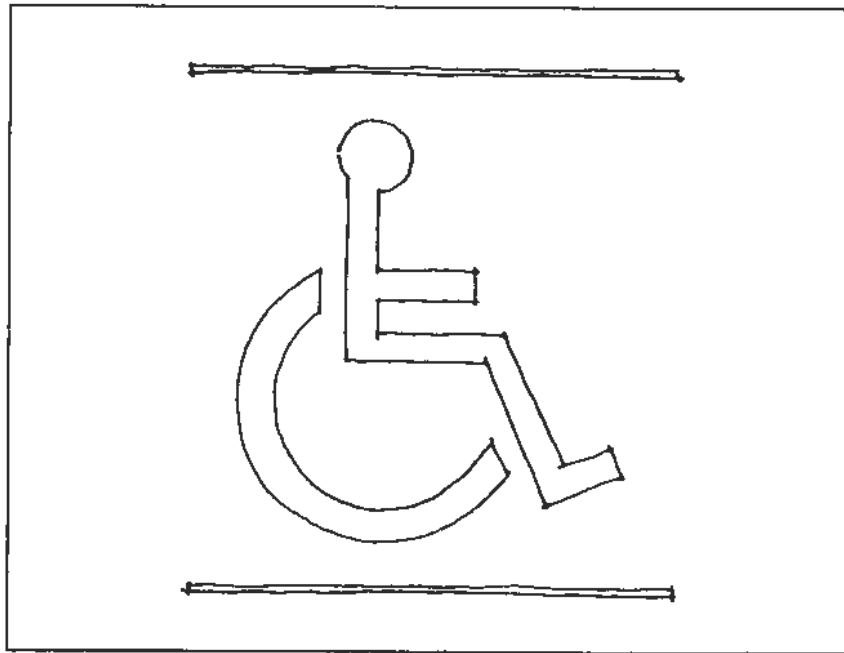

*The International Symbol of Access should mark barrier-free facilities and routes.*

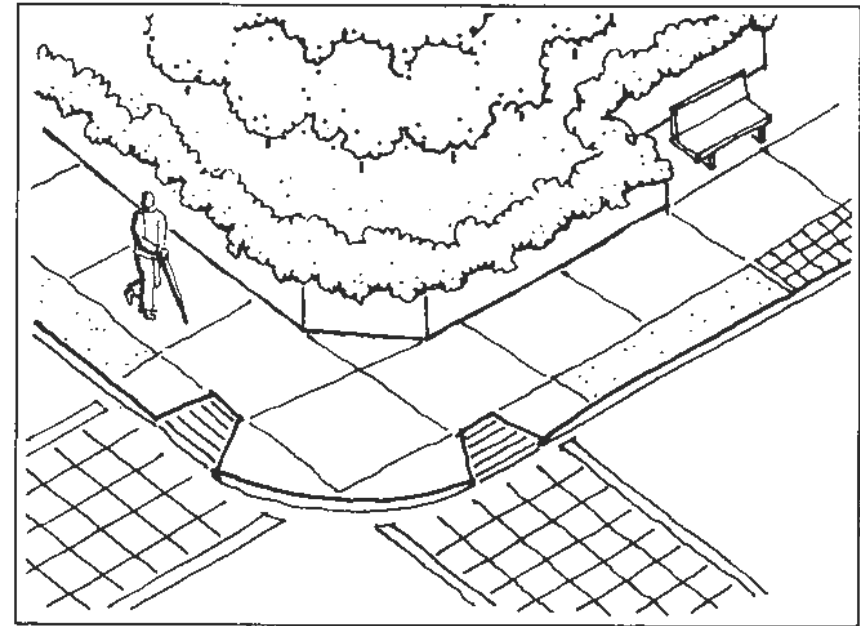

*Textures and patterns are used as markers and warnings .  
Source: Federal Register, Vol. 56, No. 173, Sept. 6, 1991.*

Curb cuts/ramps must be designed properly or they can be hazardous: A steep ramp, for example, can overturn a wheelchair. If a crosswalk is present, curb cuts/ramps must be located within it. Washington State code (WAC 51.20, Sec. 3106d) has complete information on curb ramp design.

The curb cut/ramp must have a detectable, textured surface and should have contrasting colors (light on dark or dark on light) that can be used to alert visually impaired pedestrians to the change in the walkway. The standard way of providing a detectable textured surface is to use a tactile grid. Such detectable surfaces are also required in street crossings where there are no curbs. In addition, curb cuts/ramps must be located within any crosswalk markings.

<sup>4</sup> ITE Journal, p. 21, January, 1993.

## Barrier-Free Site Design

Standards for accessible curb cuts/ramps:

- Thirty-six inches wide minimum;
- Maximum slope of 8.33%;
- Maximum side slopes of 10%;
- No raised "lip" or gap where ramp meets street or sidewalk; and
- Warning patterns detectable by visually impaired people.

### Accessible Bus Stops

ADA calls for bus stops to have a large, firm-surfaced waiting area where the wheelchair lifts on buses can be operated. Ideally, bus stops should be sited where the street is level, where there is a barrier-free sidewalk, and where there is space to build a firm-surfaced pad that can accommodate a wheelchair as well as standing passengers. A shelter or canopy to provide weather protection and lighting make waiting for a bus more safe and comfortable. Street drains, utility poles, and other obstructions should be avoided.

Standards for an accessible bus stop (where wheelchairs will be used):

- A firm surface at least 96 inches long and 60 inches wide;
- A pad sloped to the same degree as the road (to the extent practical); 2% maximum slope perpendicular to the road;
- Bus stop connected to an accessible route;
- Bus stop connected to curb;
- A maximum cross slope of 1:50;
- Avoid utility poles and guide wires; and
- Avoid drainage inlets at curbs.

Where bus shelters are provided, they should have a clear floor area at least 30 inches by 40 inches. Bus shelters should have barrier-free entrances from the sidewalk.



Accessible bus stops are a key link in barrier-free transportation.

Source: ADA Transportation Accessibility, KRW Inc.



## ***Barrier-Free Site Design***

---

### ***Creating a Barrier-Free Transportation System***

Barrier-free transportation not only allows people with disabilities to move about independently, it creates an environment that is friendly to all pedestrians. But a barrier-free environment will come about only as all parts of the transportation system — from buildings to public transit to the pedestrian environment — are made accessible. The benefits of barrier-free buses are lost if there are no barrier-free sidewalks to the bus stop; barrier-free parking or loading zones help little when they are located a great distance from buildings. The key to barrier-free design is to keep in mind the transportation network as a whole and to seek to make complete, barrier-free connections from origins to destinations. Barrier-free site design starts at the door of a barrier-free building and continues uninterrupted to accessible parking, to the public sidewalk, or to the accessible bus stop.

#### **Organizations that can help with barrier-free design:**

- The Easter Seals Society of Washington, (206) 281-5700 or 1-800-678-5708
- The State Building Code Advisory Council, (206) 753-4978
- The Northwest Disability Business Technical Assistance Center, 1-800-949-4ADA



## ***Chapter 7: Transit-Friendly Planning for Small Communities***

---

- Introduction***
- Small Community Design:***
  - ***Setting, Foundation, and Building Blocks***
  - ***The Setting***
  - ***The Foundation***
  - ***Town Centers and Main Streets***
  - ***Neighborhoods***
  - ***Putting it All Together***
- Mobility Options for Small Communities***
  - ***An Example***
  - Adding Transit***
  - Small Community Resources***



## Introduction

*Pedestrian and transit-friendly design goes hand in hand with managing growth and maintaining a vibrant, small town character.*

### ***Transit and Small Towns: Common Objectives***

In certain ways, the smaller, older communities of Snohomish County are models of transit-friendly land use and pedestrian-oriented design. Many of these towns grew up along train or trolley lines at a time when few people owned cars and when commuting twenty miles was the rare exception rather than the rule. Small blocks, wide sidewalks, neighborhood stores, and alleys were natural, common sense design back when most trips included some travel by foot. Today, these places are the small town "Main Streets" and the "Old Town Centers" which, because of their liveliness and pedestrian-friendly design, are sought out by county residents when they want to shop, walk and get a taste of the days when people were as much a part of the street scene as cars.

Paradoxically, citizens and officials in smaller communities often feel that pedestrian-friendly design, mixed use, and density are "big city" issues, even a threat to their small town identity. In fact, a close look at Snohomish County's small towns suggests that pedestrian and transit-friendly design go

hand in hand with managing growth and maintaining a vibrant, small town character.

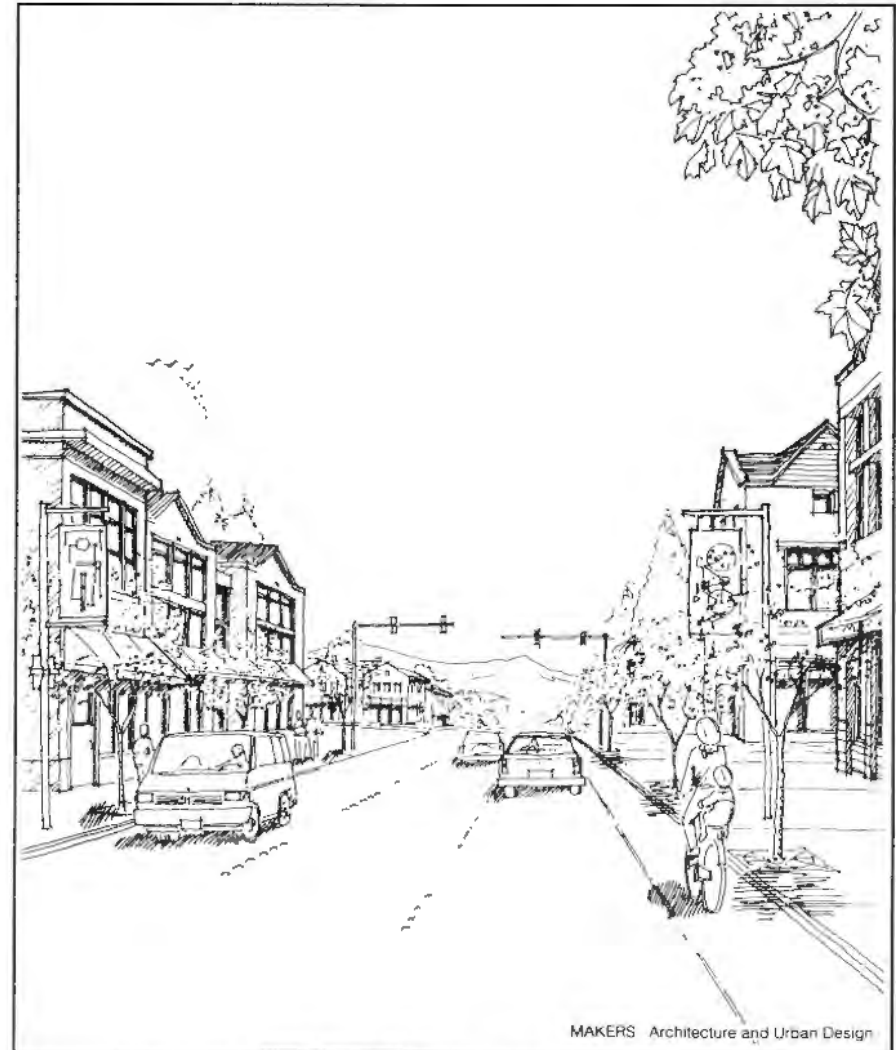

*Pedestrian-friendly design gives small towns their unique character.*

## Introduction

### *The Small Town as its Own Model*

With greater dependence on the automobile, many small communities have adopted more auto-oriented community plans and zoning standards. These plans are beginning to materialize in the form of strip malls, parking lots, and nondescript subdivisions, which not only look nothing like the older parts of town, but virtually make it necessary to drive rather than walk or share a ride. To avoid this type of development—to retain a small town character and create new transportation options—small communities need only follow their own examples.

The historic small town is a full-scale model demonstrating many pedestrian-friendly design techniques that can easily be applied today. This chapter looks at these older communities and suggests ways to apply their lessons to new development so that a town can grow without losing its people-friendly character. Newer small communities (including those emerging outside actual cities or towns) can use these lessons as well, creating their own “small town” identity and laying the groundwork for new transportation choices.

This chapter looks at how the traditional elements of small town design can be used to expand and enhance community mobility. The elements are:

- **The Setting:** natural and built features, like rivers and transportation corridors, help frame and define how a town develops.
- **The Foundation:** the way streets, sidewalks, blocks, and open space fit together also shapes development patterns.

- **Town Centers and Main Streets:** the building blocks of small town business districts can define local and regional travel options.
- **Neighborhoods:** the way residential areas are laid out, specifically affects mobility choices.
- **Mobility Options:** the variety of transportation alternatives is defined in part by the other design elements.

Within each of these design elements there are special details of features - we’re calling them “building blocks” that are the keys to pedestrian and transit-friendly design.

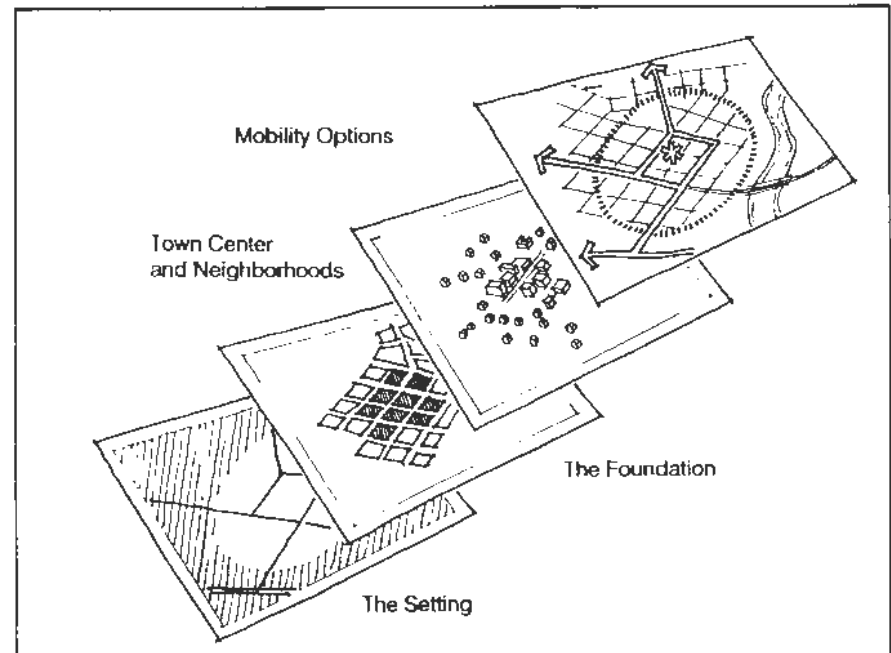

*This chapter shows how the elements of small town character can foster public transportation choices.*

## Small Community Design: Setting, Foundation, Building Blocks

*“The alternative to sprawl is simple and timely: neighborhoods...parks, and schools placed within walking distance of shops, civic service, jobs, and transit-- a modern version of the traditional town.”*

*Peter Calthorpe: The Next American Metropolis*

### **Setting, Foundation, Building Blocks**

When planning for community development, the community leaders in smaller towns and cities should consider building on the assets in place already. This concept can be used both for renewal of existing business districts, neighborhoods, and areas in transition, as well as for newly developing commercial and residential areas.

The sections that follow build on this theme. Rather than forgetting the good town planning that makes small towns work well for pedestrians, transit, and auto users alike, community leaders can use the setting, foundation, and building block concepts set out by the town's original founders to maintain the lively, people-oriented places communities need.

While this may seem out of step with today's markets, we know that auto-oriented suburban design is very difficult to serve with anything but cars. The way suburban development spreads over large areas and the distances between activities means that walking or cycling are usually out of the question. People are spread so thinly in these areas that buses can't find enough passengers to make routes cost-effective.

A growing understanding of environmental, economic, and social costs of auto-oriented design suggests we change how development is designed and think in terms of what made sense before autos dictated how towns were laid out. Experts around the country agree that the building blocks of traditional small communities can be used in this new planning process.

The idea of using small community design is being explored nationally and locally. In some areas, the results are very fancy and costly. That is not the product sought here. By focusing on overall pedestrian-friendly town structure and town center and neighborhood design, solutions can be crafted at lower cost than conventional suburban design. These savings can come from not having to provide inefficient transportation facilities and services over the long term. Best of all, if areas are developed or redeveloped to be pedestrian friendly, residents automatically will have more travel options than cars alone can provide.

## Small Community Design: The Setting

### The Setting and its Building Blocks

Snohomish County's small communities were sited to take advantage of transportation corridors and land features that made natural growth boundaries and encouraged a compact form. Communities, looking to keep or develop people- and transit-oriented design need to use these setting building blocks.

#### ■ Edges

One thing that makes small towns special is the way the town stops and countryside begins. Natural or built edges foster the compact form that makes it easy to walk, cycle or drive from place to place. Unlike walls around many subdivisions, these are natural edges that do not isolate the town from its surroundings. Farms form Arlington's western edge. Snohomish's downtown is bounded by the river, two highways, and an established residential area.

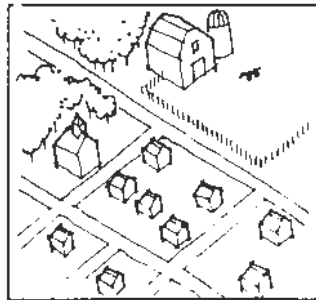

#### ■ Central places

These are activity centers that attract people and can serve as the local hub for new development and transportation services. Mill Creek is creating a mixed-use town center to create a gathering place with a sense of community focus.

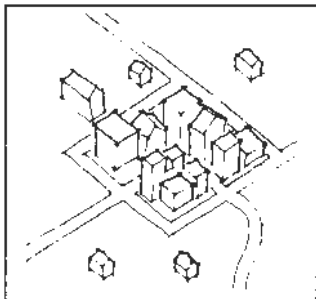

#### ■ Natural features or landmarks

Natural or built landmarks can provide a focus for community activity and reinforce community identity. Lake Stevens has developed its downtown next to a large park on the lake shore. The park is a natural gathering place and people can also take advantage of shops, services and city offices clustered there.

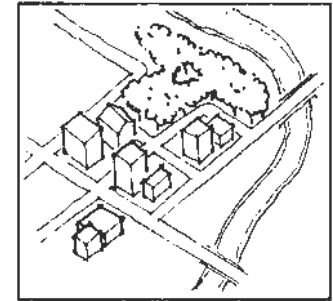

#### ■ Transportation corridors

Highways, rail lines, and trails can be used to connect the community to its neighbors. They can also destroy a community's image and vitality if they become the focus of development to the detriment of existing activity centers. Every effort should be made to use such corridors to promote pedestrian and transit opportunities. Arlington plans to extend the Centennial Trail to its downtown to provide walking and cycling access to nearby towns. Mukilteo is planning to tie several corridors together with a multi-modal transportation center in its downtown. Residents will be able to take commuter rail, buses, and ferries to many destinations.

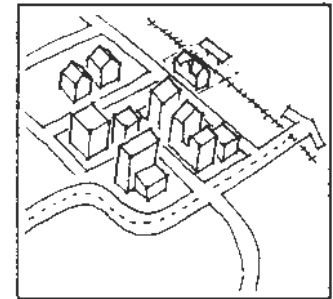



## Small Community Design: The Setting

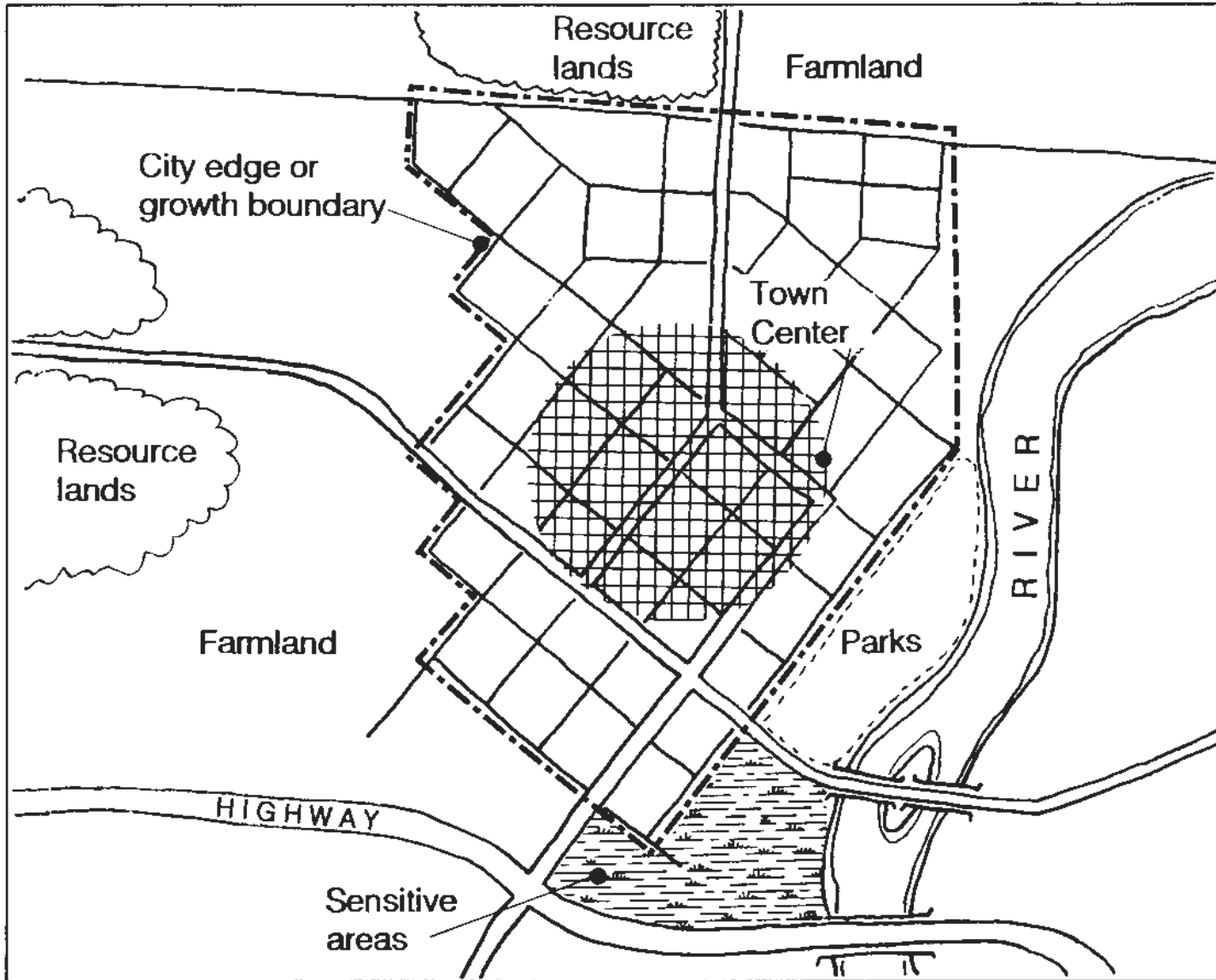

A town's setting can establish the basis for town design and transportation opportunities. Natural edges, central places, landmarks, and transportation corridors can help shape new development in the same way it shaped the original town.

## Small Community Design: The Foundation

### The Foundation and its Building Blocks

A close look at older pedestrian-friendly communities reveals a “foundation” made up of the following building blocks:

- **A grid of interconnected streets**

The grid is essential for pedestrians and cyclists giving them short, direct routes to get from place to place.

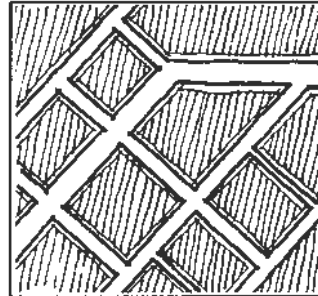

- **Pedestrian-scaled blocks**

No more than 300 feet long, short blocks make walking more interesting and provide better access to activities on neighboring streets.

- **Parks and open space**

A part of small town design, open space can be a place for recreational activities or to honor a town’s famous residents and history. Mountlake Terrace’s Veteran’s Memorial Park has green space that complements the neighboring library and city hall.

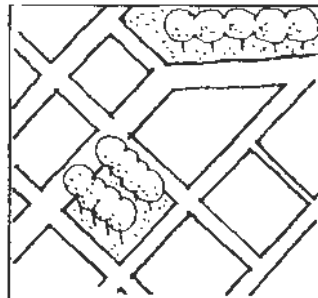

- **Alleys**

Alleys give trucks access to the backs of commercial buildings and cars access to parking behind houses and keep driveways and garages from dominating the streetscape.

- **Paved sidewalks**

Sidewalks should be 8- to 16-foot wide in commercial areas and no less than 5-foot wide in residential areas.

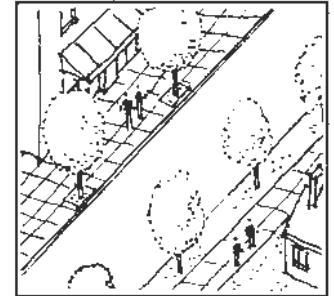

- **Narrow streets**

These streets have one 10- to 12-foot wide traffic lane and one parking lane in each direction and can accommodate motorized traffic as well as bicycles and remain safe for pedestrians to cross. Residential streets can be even narrower with a single lane to serve both directions.

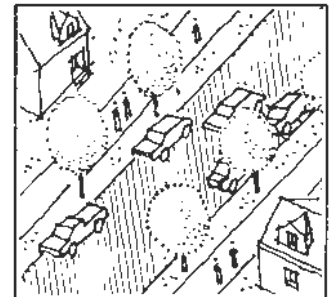

## Small Community Design: The Foundation

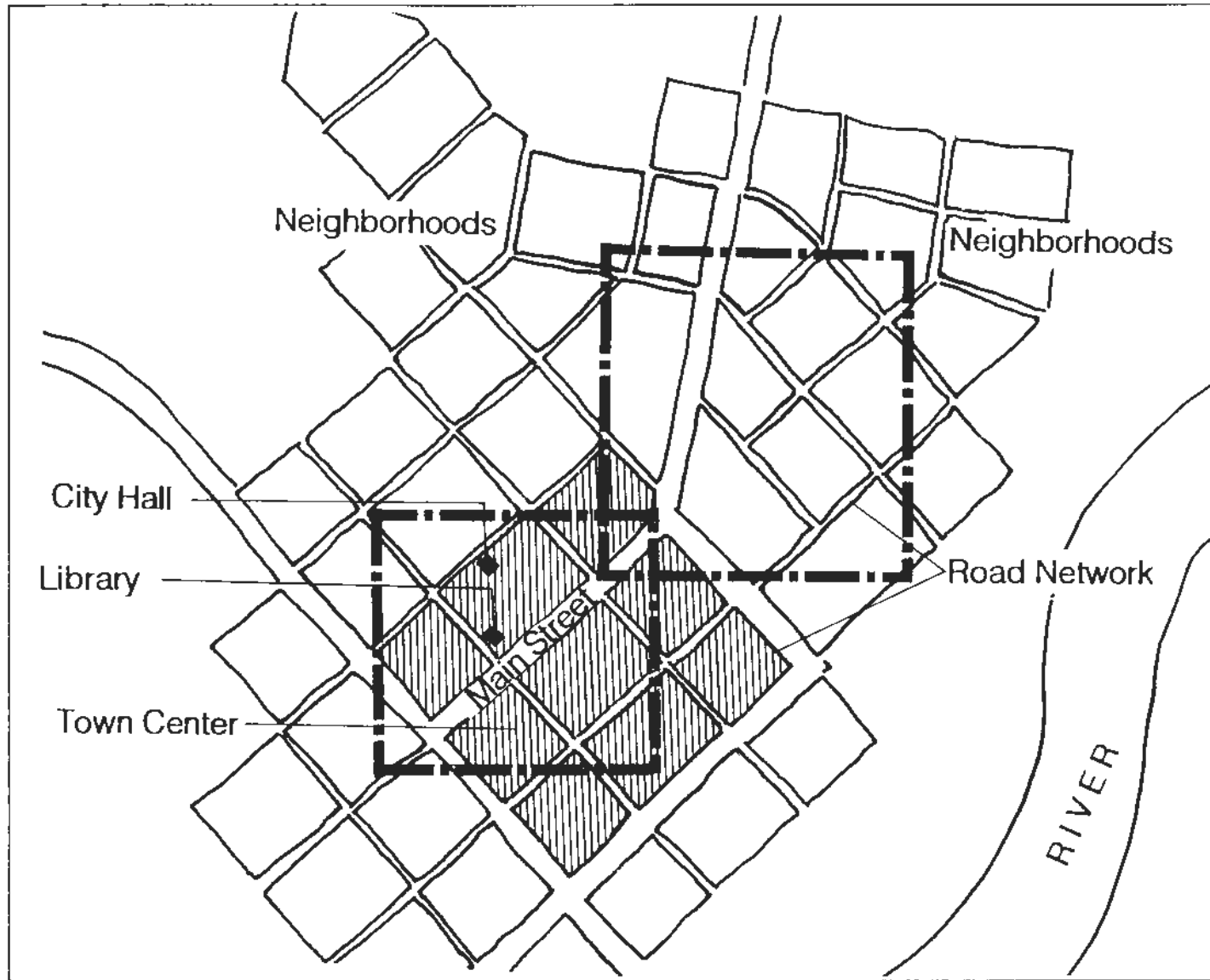

*A town's foundation of narrow streets and short blocks, sidewalks, alleys, public spaces, and buildings establishes the framework for all transportation options from walking to using regional transit services or cars.*

## Small Community Design: Town Centers and Main Streets

### Town Centers and Main Streets

From Edmonds in the south to Stanwood in the north, Snohomish County's small cities have lively, transit and pedestrian-friendly town centers or main streets. These are *people places*. Cars are there, but they move slowly and parking isn't allowed to be overwhelming.

The town center is built on a foundation of a compact grid of streets and small blocks. The main street is often the original transportation corridor that linked the town to its neighbors. The building blocks of a healthy town center or main street include:

#### ■ A compact mix of uses

These are activities that attract people throughout the day and, ideally, every day of the week:

- Housing such as apartments over stores or small apartment houses just off Main Street;
- Public spaces for people to use for art shows, public events, eating lunch, or just sitting and people watching;
- Commercial uses including offices, shops, and services; and
- Civic facilities such as city halls, libraries, post offices, senior centers, and museums.



■ A mix of parking  
Parking should support local businesses and downtown activities, but doesn't dominate the street:

- Curbside parking that creates a buffer from passing traffic, and is directly adjacent to the uses it serves;
- Pocket lots for small numbers of cars, set off to the sides and backs of buildings; and
- Under-building parking.

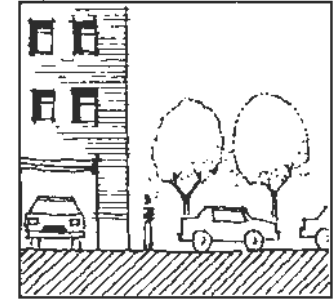

#### ■ Walking Streets

Pedestrian-friendly streets are designed to make walking efficient, safe, and enjoyable:

- Sidewalks 8- to 16-feet wide with textured paving and street trees; and buildings built right up to the sidewalk (to shorten walking distances);
- Lively building faces with awnings, display windows, and sidewalk cafes;
- A landmark, a fountain or piece of art, that gives this street or center a special identity;
- Street trees to lend continuity and greenery to the street and provide shade; and
- Slower traffic speeds (15-25 mph max.) to make pedestrians feel safer.

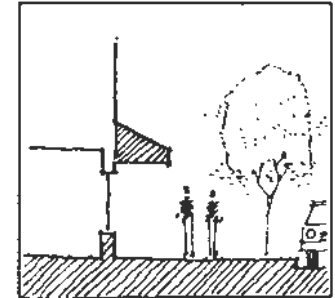

## Small Community Design: Town Centers and Main Streets

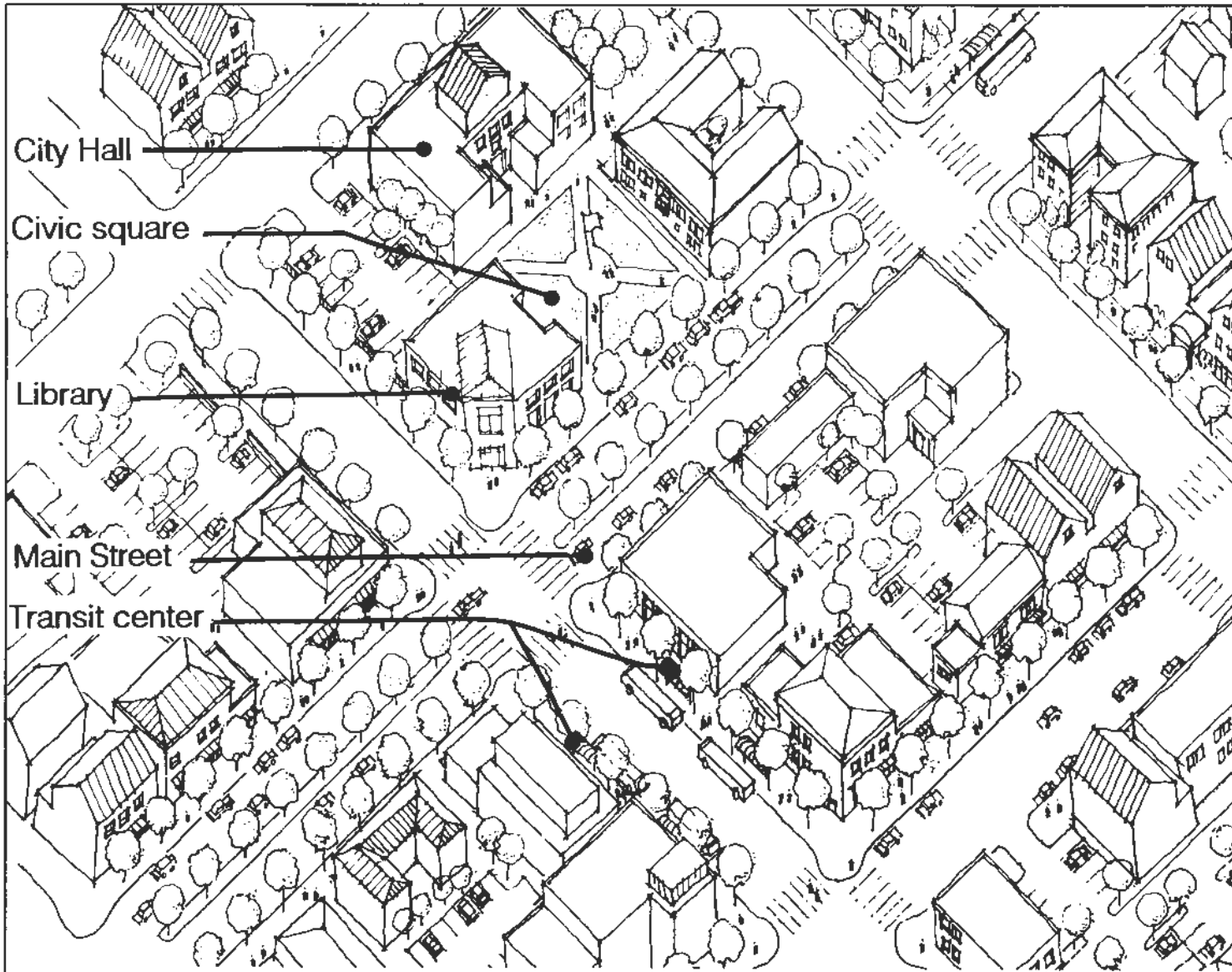

*Town centers and Main Streets combine many activities in a compact area that lends itself to walking. These areas, and new areas patterned after them, can help support bus, dial-a-ride van services, and ride sharing.*

## Small Community Design: Town Centers and Main Streets

### Town Centers: An Example

The town center in Lake Stevens is developing as a transit and people place because the city is interested in making it work that way. By clustering city government offices, shopping, the city park and housing within a few blocks of each other and linking everything with sidewalks and crosswalks, what was once a crossroads for cars is now becoming an activity center for people.

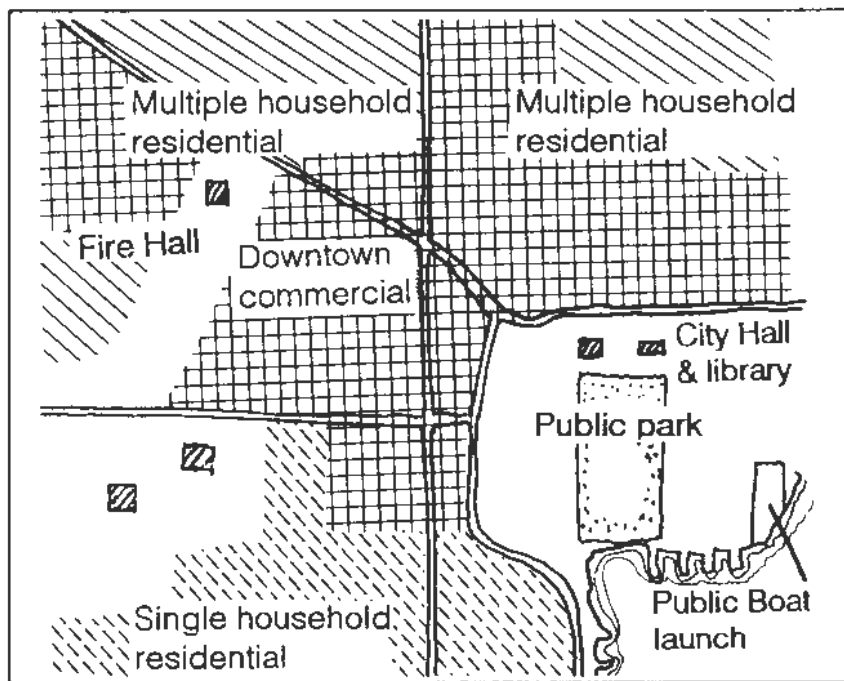

Lake Stevens' town center proposed plan shows how activities will be clustered.

### Main Streets: An Example

A successful main street can be found in the City of Snohomish. Located a block from the through street (Second Street), Snohomish's four-block long First Street has changed with the times. Unable to compete with auto-oriented uses (along Second Street), First is now lined with shops that serve tourists interested in antiques and an old town flavor. Whether other communities' main streets can be redeveloped to meet a specific market niche remains to be seen, but creating a street for people has worked for Snohomish.

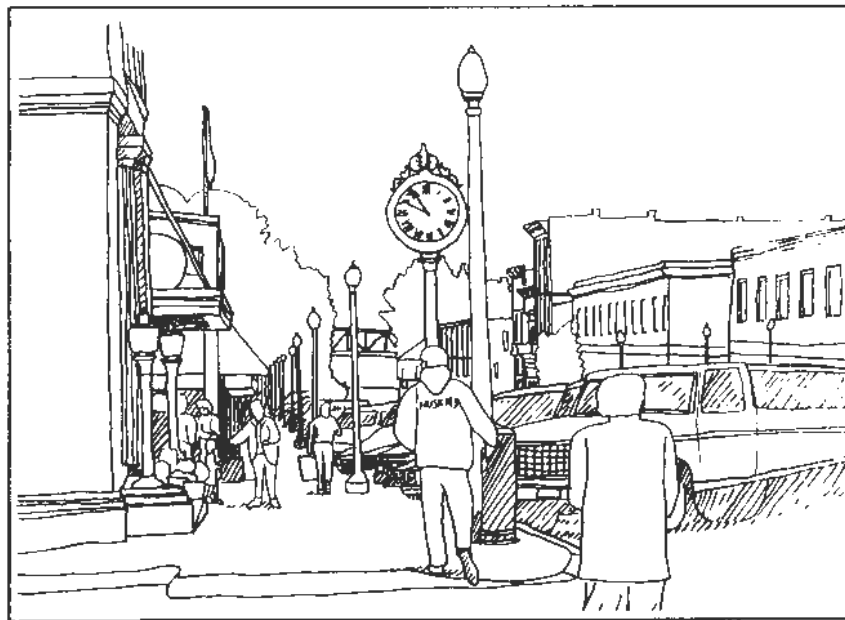

Snohomish's "main street" building blocks make First Street a place where people want to walk.

## Small Community Design: Town Centers and Main Streets

The building blocks for town centers and main streets don't just belong in traditional downtowns. Using these building blocks in new commercial areas -- even shopping centers, can effectively recreate the pedestrian environment found on Main Street. Parking, a key ingredient in today's commercial areas, needs to be located conveniently behind or under buildings or on the street. Big paved parking lots do not work in a pedestrian-oriented area. Making a comfortable place to shop and do business can be achieved by placing storefronts/building fronts right on wide sidewalks with pedestrian amenities such as sitting places, signs, awnings, landscaping, and bike racks. All of these invite people to use the street, to shop, to walk, to gather, to sit on the edge and watch, and to participate in a feeling of community

Mill Creek's new town center plan calls for a central plaza where buildings line the walking area and street trees, small-scale buildings, decorative paving, and benches make the space attractive to people walking and biking.

### ***Traffic Calming: A Tool for Pedestrian-Friendly Streets***

Whether they are located downtown or in residential areas, streets designed for people combine good sidewalk design with pedestrian- and bicycle-oriented street treatments. Pedestrian safety and comfort can be improved if vehicular traffic is "calmed" by taking the following steps:

- Reducing speed limits -- 25 miles per hour should be the maximum speed if there is pedestrian activity on the street.
- Reducing roadway widths by widening sidewalks, adding bike lanes, or reintroducing parallel or diagonal parking (depending on space availability) -- the ideal is one traffic lane in each direction where pedestrians are desired (on quiet, residential streets, one traffic lane can serve both directions).
- Reducing the perception of roadway width by using street trees and landscaping to define a pedestrian area where vehicles must slow down.
- Using boulevard treatments that add a landscaped street median to serve as a pedestrian "refuge."
- Adding crosswalk "bulbs" that narrow the street at corners, slowing traffic and shortening the pedestrian crossing distance.

## Small Community Design: Neighborhoods

### Neighborhood Building Blocks

The best of Snohomish County's small towns have pleasant neighborhoods adjacent to downtown. They have tree-lined streets, sidewalks, and a compact layout that makes it easy to walk from place to place.

These neighborhoods share the following building blocks:

- **A grid of interconnecting streets and small blocks**

Connecting streets giving residents a variety of routes to destinations. Often alleys bisect the blocks and add access to the backs of lots.

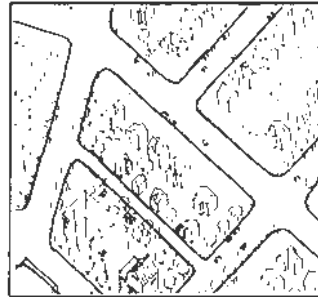

- **Smaller lot sizes**

Small lots allow seven to ten houses per acre. Accessory dwelling units ("mother-in-law apartments") allowed in basements or over garages give even higher densities. Where there are duplexes and other multiple-family dwellings, densities can reach 15 or more units per acre. Compact, higher density neighborhoods offer better markets for transit services than do low density, spreading subdivisions.

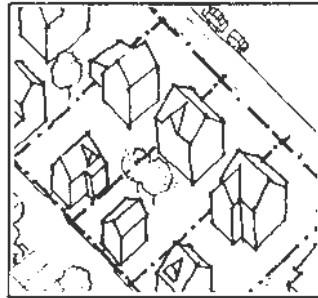

- **Complementary uses**

A variety of neighborhood services can be clustered on neighborhood corners in easy reach by foot:

- Neighborhood stores ("Mom and Pop" convenience stores);
- Neighborhood parks where people can walk dogs or children can play;
- Schools, childcare centers, retirement homes; and
- Home offices for dentists, architects, artists, etc.

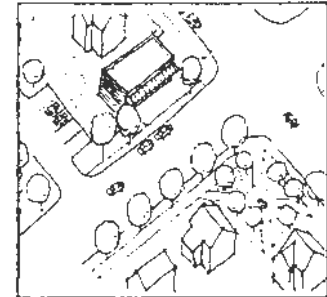

- **A harmonious streetscape**

Neighborhood streets that encourage walking include:

- Common setbacks and common building sizes, forms, and materials;
- Street trees, front porches, fences, and similar "finishings;" and
- Sidewalks that provide safe places to stroll or play and easy routes to nearby shops or activities.

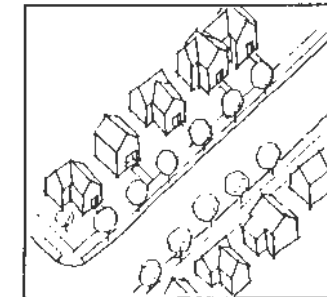



## Small Community Design: Neighborhoods

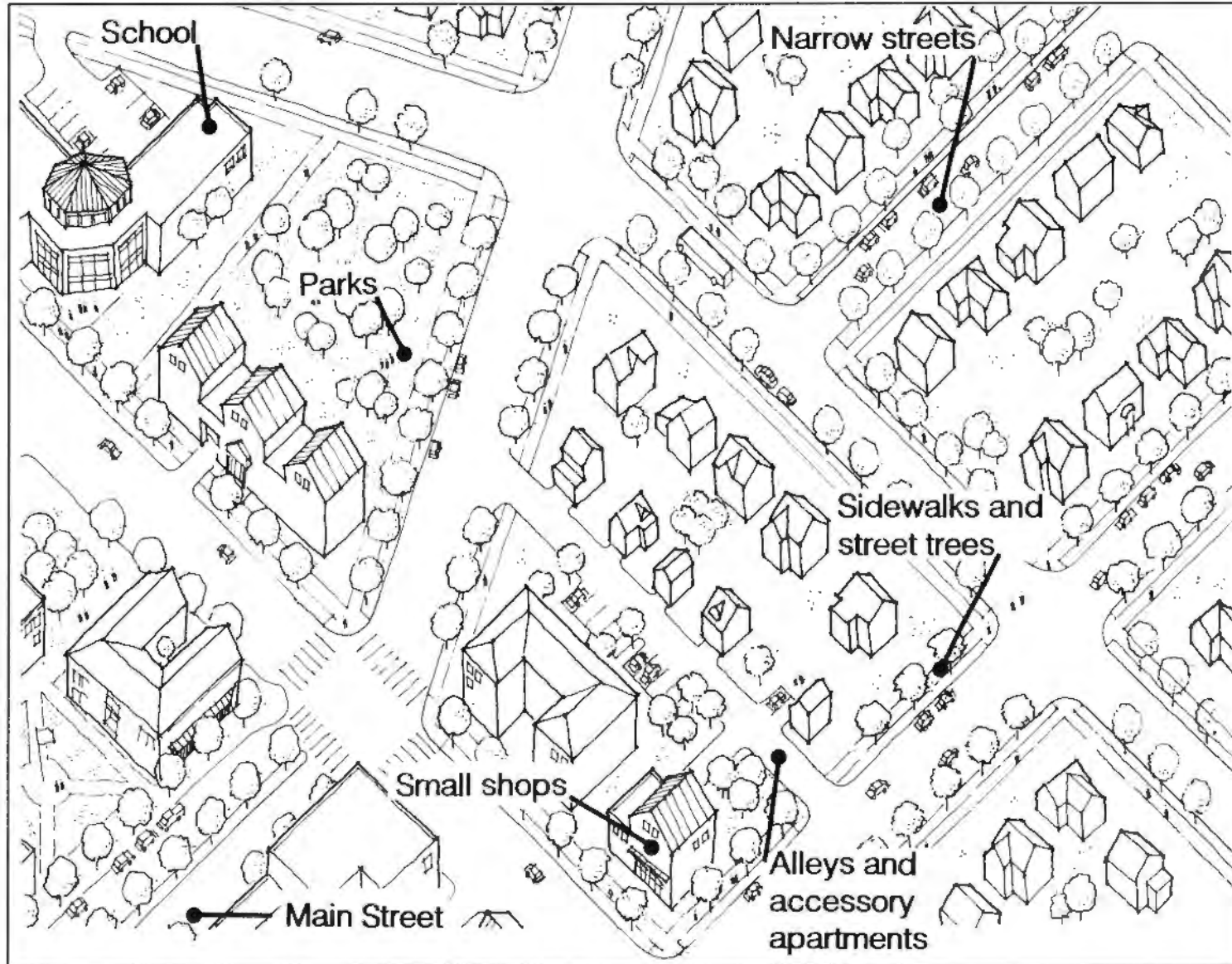

*Pedestrian-friendly neighborhoods have interconnecting streets and small blocks, pleasant sidewalks with street trees, garages on alleys or behind the houses, neighborhood shops, and other activities. Residential densities are over 7 units/acre.*

## Small Community Design: Neighborhoods

The small town neighborhood “model” does not belong to the past. Developers nationally have discovered a solid market for residential developments designed on the traditional compact grid instead of the auto-oriented loop roads and cul-de-sac layout. Alleys, sidewalks, street trees, playgrounds, and community stores are popular features, regardless of the community’s population or age.

### ***Neighborhoods: an Example***

Monroe’s residential area lying between Main Street and the parks along the river is a good example of pedestrian and transit-friendly neighborhood design. Built on a fairly regular grid of streets and “lanes” (paved alleys), the half-mile square area is an easy walk from the city center with its transit facilities, local schools, the public library and many other services. Most of the streets have paved sidewalks and those on collector streets are connected with painted crosswalks at intersections.

Monroe also has integrated small apartments and condominiums into this area with considerable success. An attractive six-unit apartment, tucked into a quiet street of bungalows, fits the scale and character of the street. Several clusters of one and two-story, small townhouses and apartments can be found on the edges of the area.

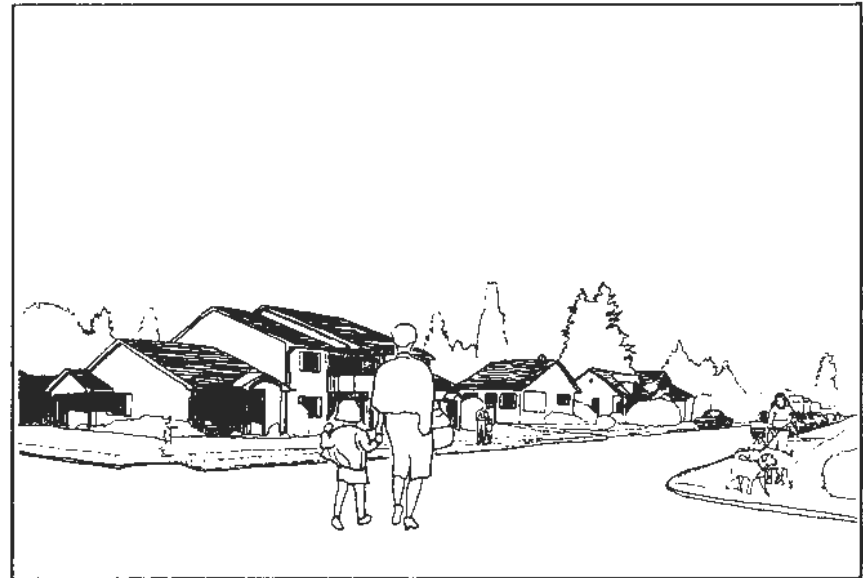

*In Monroe, small apartments fit nicely into the town's older, pedestrian-friendly neighborhoods.*

## Putting it All Together

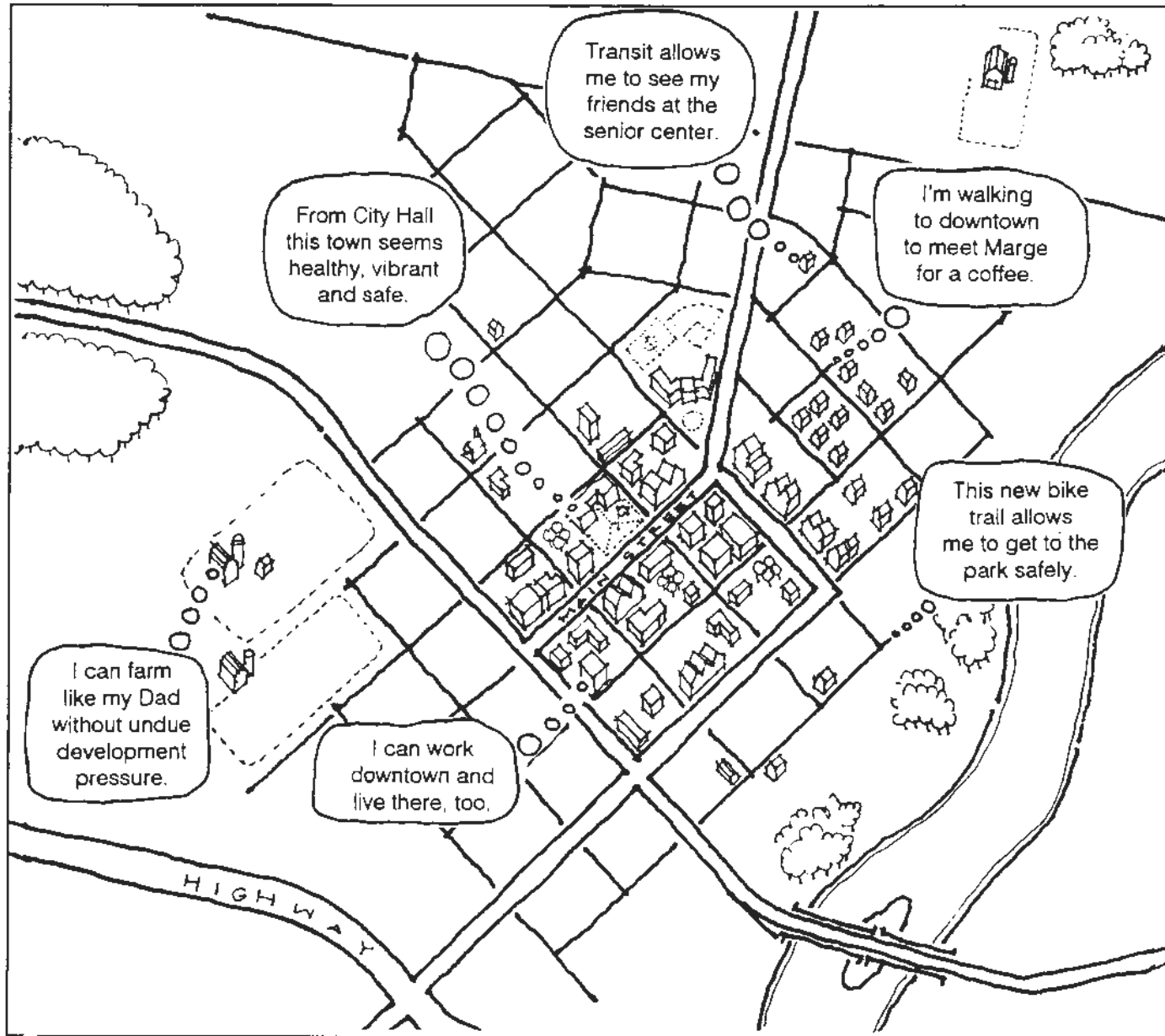

The community can build on the traditional elements of site, foundation, and building blocks to pattern new development after its transit and pedestrian-friendly town center, Main Street, and neighborhoods. This sets the stage for building new or improving existing transportation service options.

## Mobility Options for the Small Community

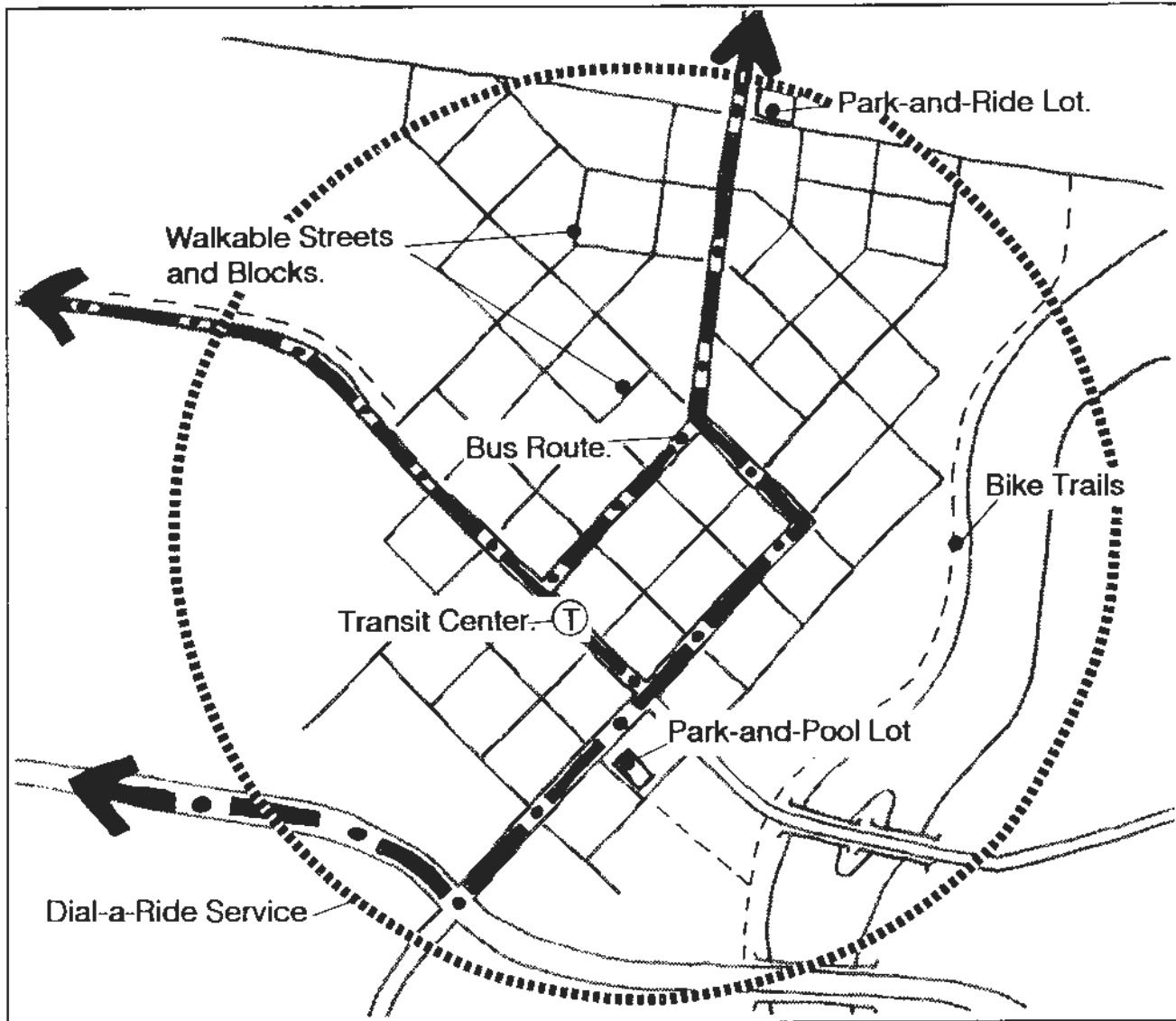

A pedestrian and transit-friendly community can add to and improve the quality of a range of transportation options including:

- **Fixed Route Bus**  
For regional connections and limited local circulation.
- **Walking and Cycling**  
For local circulation and connection to transit facilities.
- **Ridesharing**  
For commutes to employment centers.
- **Dial-a-Ride**  
For people with limited mobility.

## Mobility Options for the Small Community

*Using public transportation as a community building block simply requires that land use plans and regulations look out for the needs of pedestrians, cyclists, and bus riders, just as they ensure adequate roads and parking for cars.*

### **Making Transit Part of the Community Vision**

Public transportation—including buses, ridesharing, walking and cycling—can be an important community building block. Today, most small towns in Snohomish County have a bus route connecting them to larger cities, as well as “dial-a-ride” services for people dependent upon public transportation. New transit service options can be developed as the community grows, but only if development patterns are pedestrian and transit friendly. In turn, new transit services and pedestrian activity will allow communities to grow while avoiding total dependence on cars.

Using public transportation as a community building block requires that the community take a long-term view, but it doesn’t mean a great departure from business as usual. It simply requires that land use plans and regulations look out for the needs of pedestrians, cyclists, and bus riders, just as they ensure adequate roads and parking for cars. Public transportation must be made a part of the community vision,

as it was when those special, people-friendly small towns were first laid out.

### **Public Transportation Options and What Makes Them Work**

Public transportation in small communities can take many forms, but each type of service requires certain conditions to make it work.

#### ■ Regional Bus Service

*Fixed route service*, or buses running on a certain route and timetable, can connect the town to other communities, to other bus routes, to job centers, and to regional transportation facilities such as airports or ferry terminals. In most small communities, the bus comes through on the main street or an adjacent highway, makes a few stops, and goes on to the next town.

Community Transit’s Route 210, which connects the towns of Arlington and Marysville with the City of Everett (and the Everett Transit Center) is a good example of this type of service. What makes this type of inter-city route work are:

- A network of connecting roads making it easy for people to walk to a bus stop;
- Central collection points – bus stops people can easily get to;
- Enough people living and working close to the route to warrant bus services; and
- Convenient and reliable bus service.

## Mobility Options for the Small Community

### ■ Local Bus Service

In some communities, an inter-city bus will make a short loop through residential areas adjacent to the main street. This not only makes catching the bus more convenient, but allows people to make short, local hops as the bus collects passengers bound for job centers or neighboring towns. The towns of Sultan and Gold Bar each have routes that loop through town. The City of Monroe has two routes -- one serving State Highway 2; the other serving Main Street.

If fixed-route service is to be effective, service must be fairly frequent. Most people would like to have a bus circulating around town all day. Unfortunately, "local circulators" haven't worked very well in small communities.

A bus driving in a short loop connecting to a major through route may work in a small downtown, but longer loops into residential areas or rural areas force passengers to travel a long distance out of their way. Even in downtown areas, walking may be more convenient, unless the bus comes very frequently. Providing this type of service can be very expensive. The City of Edmonds, with a fairly dense population, pedestrian-scaled blocks, sidewalks and attractive streets, tried a circulator and found that people preferred to walk or drive for their "around town" trips.

The transit industry is experimenting with smaller vehicles and more customized options for local trips. The prospect for these new services are better in a community where:

- A variety of land uses and activities are clustered;
- Sidewalks exist so people can easily get to stops;

- A grid of connecting streets gives transit vehicles a choice of routes; and
- Transit-services are well publicized and used by the community.

### ■ Demand-Responsive Service

A popular public transit option in small communities is "demand-response," a taxi-like service provided primarily for elderly people or people with disabilities who are unable to use regular bus services. Dial-a-Ride Transit (DART) service is available throughout most of Snohomish County. The Americans with Disabilities Act (ADA) requires that such service be provided for eligible, disabled customers within  $\frac{3}{4}$  mile of a bus route.

This type of service can be expanded to include the general public. Where such services are provided, a person can call the transit agency from 1 to 14 days in advance to reserve a ride. DART service works especially well where there are:

- Roads are reasonably well connected so vans can take the most direct routes possible;
- Clusters of trip origins and destinations that people can easily get to;
- Small, mixed-use centers where van passengers can shop or use services in one place; and
- Community services and other activities on fixed schedules and in convenient locations so that DART services can be planned in advance. (For example, senior center lunches are at a fixed time each week.)

## Mobility Options for the Small Community

The original dial-a-ride was provided by the taxi. In many communities the taxi can provide the kinds of community-wide services that are inefficient for transit to provide. For taxis to be economically viable, the community needs to recognize their importance and use the services. Too often the value of this transportation option is forgotten.

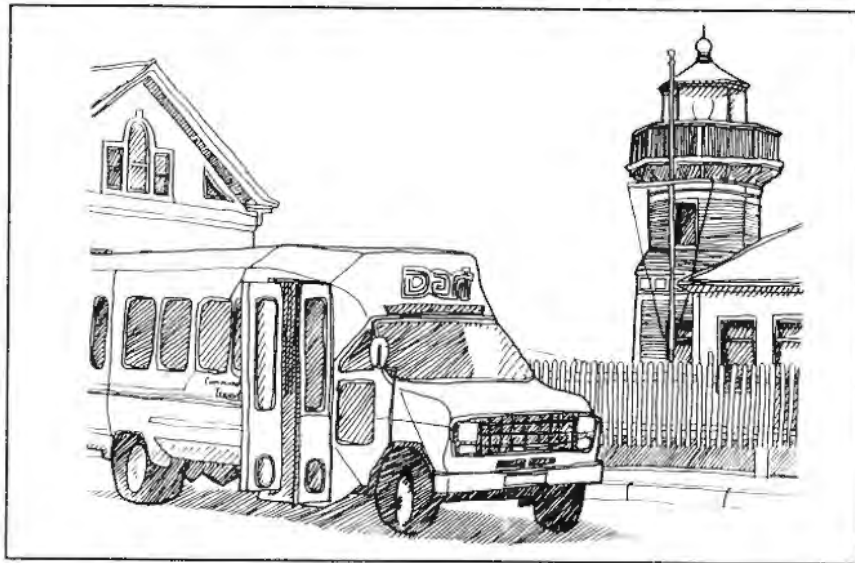

*Dial -A-Ride Transit (DART) serves people with limited mobility.*

### ■ Ridesharing

Ridesharing is an efficient and flexible transportation option, and is especially well-suited to smaller, outlying communities where there may not be enough riders to justify a bus route. This type of service includes carpools and vanpools using transit company or employer-provided vans, neither of which requires the most expensive part of a bus operation—a paid, professional driver. Ridesharing works well for commuters who make daily trips from a small community to a common

employment center.<sup>1</sup> People sharing a ride can arrange for the designated driver to pick them up if convenient, or they can meet at a park-and-ride lot.

Community Transit (CT) arranges many carpools and vanpools each year. Demand for these services has grown 30% per year and CT now has 95 vans in its fleet. Ridesharing works especially well if the community has:

- A convenient rideshare rendezvous point near a main highway;
- Parking in a safe and secure location;
- A local program to promote ridesharing;
- Clustered trip origins (homes) and destinations (work sites); and
- Restaurants and other commercial services at employment centers so people don't have to drive to do day-time errands.

### ■ Park-and-Ride Lots

In an ideal world, everyone would be able to walk from their homes to a bus stop. In the real world, housing is often far from where a bus can safely or economically be routed, and many people must drive to a park-and-ride lot to link up with transit. Park-and-ride lots work a bit like suburban train stations: People drive (or bicycle) to the station, park, and transfer to a bus or carpool that takes them to work or other destinations. Snohomish County has 13 park-and-ride lots

<sup>1</sup> Under the State's Commute Trip Reduction Act of 1990, local governments and businesses are jointly promoting ridesharing to reduce commuter trips. Major employers are now providing ridesharing incentives to their employees. The transit companies offer computerized ride matching services. Cities and counties are charged with monitoring and coordinating these efforts.

## Mobility Options for the Small Community

providing about 3,000 spaces, most of which are occupied daily. The City of Snohomish has a good example of a park-and-ride lot. Located along the State highway, at the edge of town, the lot serves town residents as well as commuters from farther out. The lot is:

- Adjacent to the main highway;
- Located “upstream” from town (so it keeps some traffic from coming through town);
- Well lit and visible from surrounding areas; and
- Served by local and commuter routes.

### ■ Park-and-Pool Lots

Even where bus service isn't available at all, commuters wishing to carpool need a place to meet and park their cars. A *park-and-pool lot*, which can be established on just about any vacant piece of land, serves this purpose. Community Transit has agreements with churches in some communities which allow commuters to park in church lots on weekdays.

### ■ Transit Centers

A transit center is a hub where bus routes come together, allowing people to transfer from one bus to another. In big cities, transit centers add vitality to downtowns and other activity centers while keeping traffic to a minimum. In a small community, a transit center may simply be a bus stop with space for more than one bus and a comfortable sitting area. If bus routes currently interconnect in a town, or if there is a potential for them to in the future, a small town can

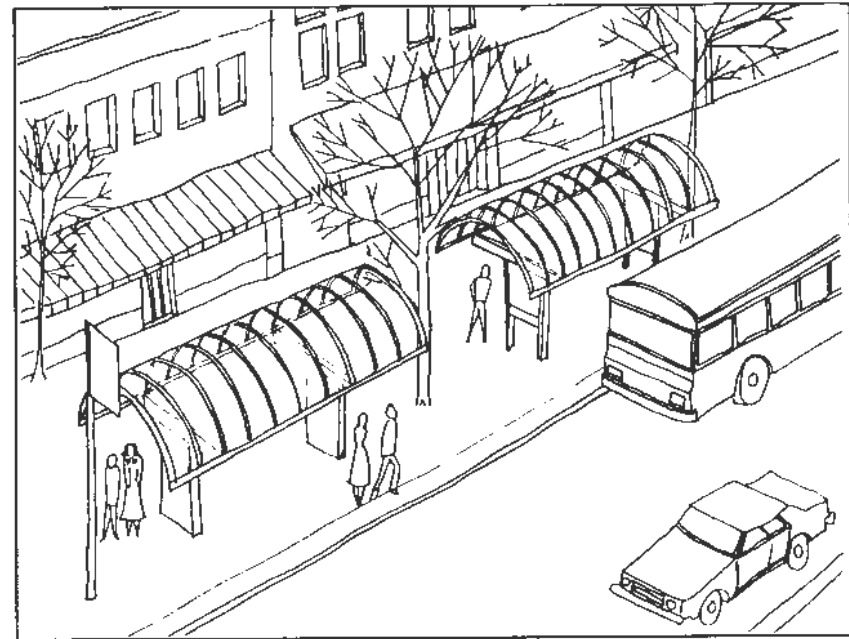

*A transit center can support an activity center in a community.*

work with the transit agency to plan a small transit center for its downtown. Not only can a transit center give the town better access to bus routes, it can make the town center more attractive and pedestrian-friendly. The City of Arlington is planning a downtown transit center in hopes of bringing more shoppers into town. Features that make a town a potentially good location for a transit center include:

- A major crossroads, with more than one bus route;
- A fairly compact, pedestrian-friendly town center, or the ability to develop one; and
- A network of walkways connecting neighborhoods to the town center.



## Mobility Options for the Small Community

### ■ Walkways and Bikeways

The simplest and most effective strategy a small community can use to create transportation options, particularly for local trips within town, is to make sure streets have sidewalks as well as shoulders adequate for bicycling. This may seem obvious, but new shopping centers and subdivisions in smaller communities often omit these fundamental building blocks of pedestrian-friendly small towns. A complete network of walkways and bikeways lets people walk or cycle from their homes to the store, the park, school, and sometimes work. Equally important, this network is a critical link to bus stops, a transit center, a park-and-ride lot, and public transportation in general.

### **Building for Buses**

People often ask if buses can really fit on pedestrian-friendly streets. Buses, like fire engines, can go most everywhere where there are paved roads that have lanes wide enough to accommodate them and intersections in which they can safely turn. Generally, bus routes are planned to use arterials and collector streets and most of these are wide enough for even articulated buses. In small communities, 30- and 40-foot buses are generally the largest used although some 60-foot articulated buses are used on inter-city commuter routes. Use of smaller vehicles such as minibuses or vans is being studied. Heavily used bus stops may need specially designed pads to handle the heavy weight loads, but in most small communities such pads would only be required where there is a transit center or a park-and-ride lot.

The most important part of building for buses is being sure passengers can safely and comfortably get to bus stops. Paved walkways, crosswalks and amenities such as bus shelters and benches really help. The transit company can work with the community to help develop these facilities.

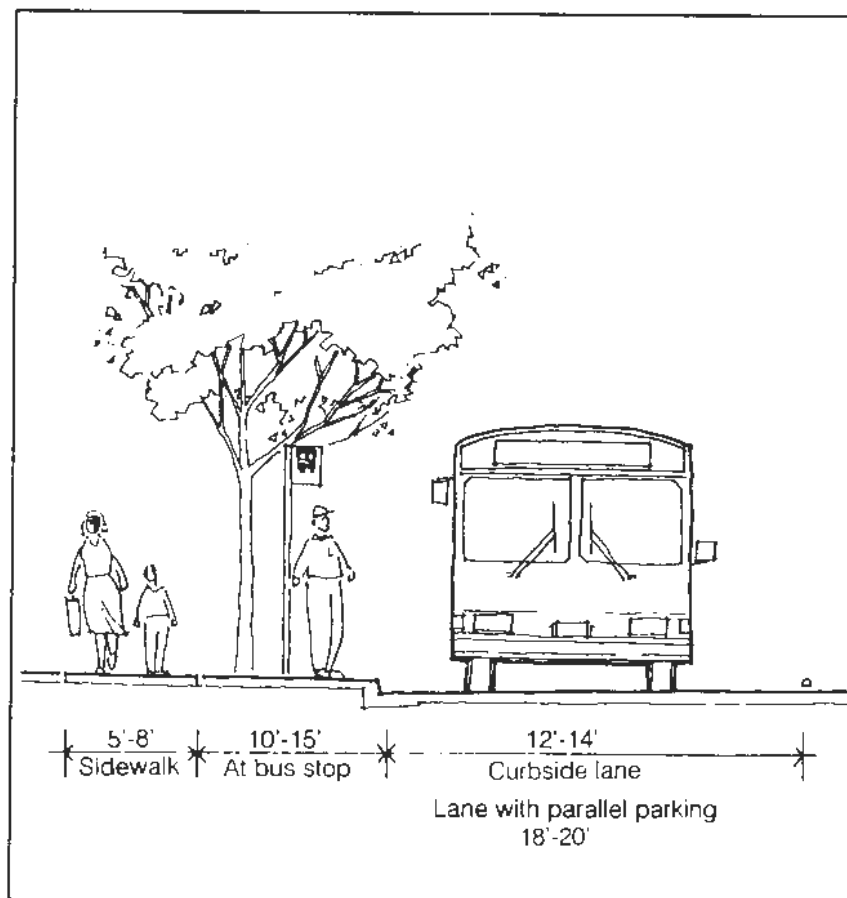

*A street can have relatively narrow lanes and still accommodate a bus.*

## Adding Transit

### ***Arlington: How One City is Assembling its Transit-Friendly Building Blocks***

The City of Arlington is one example of a town planning for pedestrian and transit access. Recognizing that new, auto-oriented development (such as strip malls and large-lot subdivisions) was making people auto dependent, the City used its new comprehensive plan to increase transit, pedestrian and bicycle options over the next twenty years.

The community began by developing a vision plan for development. Residents agreed that the city should retain its small town and rural character even with anticipated growth in both jobs and population. Planners, city leaders and citizens use that vision as they review new project proposals. Arlington has employed the building blocks described in this chapter in its comprehensive plan.

#### ■ Town Center and Main Street

Arlington has a compact center built on a grid of streets and well-maintained sidewalks. A wide range of activities is available including restaurants, public buildings, shops and services. The comprehensive plan calls for maintaining the "civic" focus downtown by keeping City Hall on the main street and locating public services in its vicinity. The City recognizes that City Hall and public services help bring people downtown and keep the area lively.

Arlington's main street, Olympic Avenue, is classic America with its wide sidewalks with awnings and a scale that invites walking. There are 80 lower-income apartments upstairs, above the stores, all along Olympic Avenue. Several clusters of small, affordable apartment houses can be found adjacent to the downtown and more are planned.

#### ■ Pedestrian-Scaled Streets

Arlington's pedestrian friendliness extends beyond downtown. Pleasant streets connect downtown and the "Old Town" residential area with paved sidewalks, most of which have wheelchair ramps at the corners.

To better connect residential areas north of downtown with the rest of the city, the plan is to relocate the main highway (SR 530) one block north and turn the current route into a boulevard, designed to narrow the street to make it easier for pedestrians to cross to get to downtown.

#### ■ Sidewalks, Walkways, Paths

Arlington has a wonderful network of sidewalks and bike and walking pathways linking large areas of the town. In addition, it is planning to bring the regional Centennial Trail to the western edge of downtown on an abandoned railroad right-of-way. Bicycles and pedestrian trails along the entire length of Portage Creek will connect downtown, the old neighborhoods, and the Airport Industrial Area. Unfortunately, the City is not requiring sidewalks throughout new residential areas, a departure from the pedestrian-friendly foundation that gives Arlington its character.

#### ■ Density and Compactness

Arlington covers a large area, but the City is trying to maintain compactness as it grows. Its minimum residential density is 4-6 units per acre, which, if other conditions are right (such as a network of sidewalks, properly located bus stops and sufficient numbers of people) may be able to be served by fixed-route transit. The comprehensive plan encourages "mother-in-law" apartments in certain neighborhoods. Adjacent to downtown, apartments and

## Adding Transit

condominiums are planned precisely to give residents easy access to transit, shopping, the local and regional trail system, and city services and amenities.

Arlington is considering adding "village centers" to some of its neighborhoods as a way to encourage residents to walk or cycle to pick up a paper or a quart of milk. These village centers fit with the city's vision in that they copy the "corner stores" that supported neighborhoods the past. These centers, which would be located at main intersections in these neighborhoods would include small shops and perhaps community services such as branch libraries or contract post offices.

### ■ Transit

A park-and-ride lot at the west edge of town is served by three bus routes. An additional park-and-ride lot is planned at the airport and a transit center downtown. Buses serve major activities now, and more services could be added as population increases.

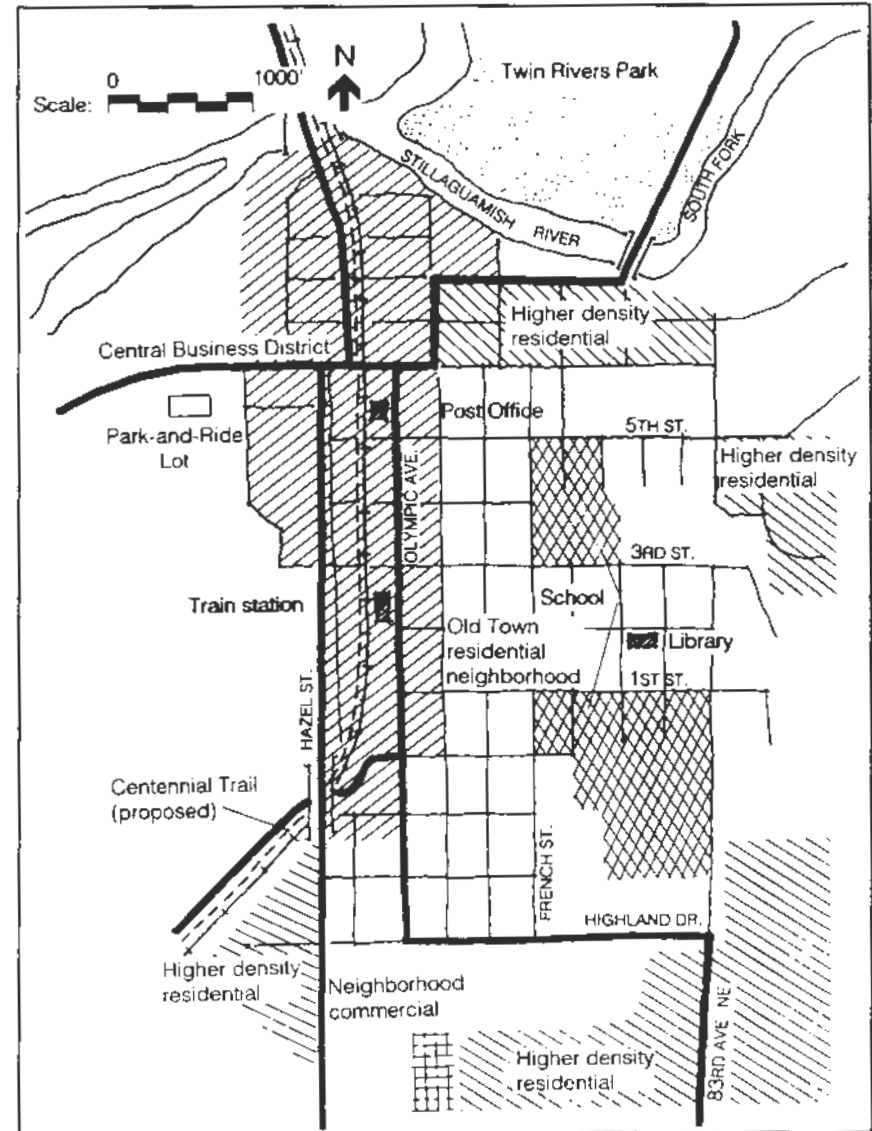

*Arlington's Comprehensive Plan provides options to auto dependency.*

## Adding Transit

---

### ***Creating the Transit-Friendly Community***

Communities around Snohomish County are recognizing that even if transit isn't a big part of the picture today, providing alternatives to the private car will be important in the near future. Land use and urban design decisions made today can help determine whether transit can even be considered tomorrow.

A community interested in expanding transit services in the short run or planning for future transit services needs to create a partnership with the transit agency: A community can help make the partnership work by building pedestrian and transit-supportive design into its comprehensive plan, zoning code and other regulations.

Changes will come gradually. As the community considers revisions to its plans and codes, it should keep in mind the features of the community that make it work: the setting, foundation, town center, neighborhoods, and mobility options.

### ***Building in Transit-Friendly Design***

The chart on the next page is a checklist that can be used to keep the building blocks of the small community in mind during all community development stages from comprehensive plan revision to zoning code and design code adoption.

Transit needs to be part of this process from start to finish. The Growth Management Act requires inclusion of transit at the policy and zoning code stages and good community design calls for it all the way through the process.

- **The Comprehensive Plan** sets overall policy, directing pedestrian and transit-friendly program direction;
- **The Zoning Code** provides the standards that development must follow;
- **Subdivision Ordinances** also provide standards -- these for creating parcels that should be developed to support the community's transit-supportive policies;
- **The State Environmental Protection Act (SEPA)** ordinance can be used to provide development incentives in the form of mitigation fee relief tied to transit-supportive development; and
- **Design Guidelines** are used as guidance to reinforce comprehensive plan policies to assure that pedestrian- and transit-friendly building blocks are used to their greatest effect.

## Adding Transit

Transit-Friendly Planning Check List

	Comprehensive Plan [Policy]	Zoning Code [Standards]	Subdivision Ordinance [Standards]	SEPA Ordinance [Incentives]	Design Guidelines [Guidance]
<b>The Setting</b>					
• Edges	✓			✓	
• Central Places	✓	✓			✓
• Landmarks	✓				✓
• Transport Corridors	✓				
<b>The Foundation</b>					
• Street Grid	✓	✓	✓		✓
• Small Blocks	✓	✓	✓		✓
• Paved Sidewalks	✓	✓	✓		✓
• Narrow Streets, Alleys	✓	✓	✓		✓
• Parks & Open Space	✓	✓		✓	✓
<b>Town Center/Main Street</b>					
• Mix of Uses	✓	✓		✓	✓
• Mix of Parking	✓	✓		✓	✓
• Walking Streets	✓	✓		✓	✓
<b>Neighborhoods</b>					
• Grid of Small Blocks	✓	✓	✓		✓
• Small Lot Sizes	✓	✓	✓		✓
• Complementary Uses	✓	✓		✓	✓
• Harmonious Streetscape		✓			✓
<b>Mobility Options</b>					
• Regional Bus Service	✓				
• Demand Responsive	✓				
• Ridesharing	✓			✓	
• Park-and-Ride Lots	✓	✓			✓
• Transit Centers	✓	✓			✓
• Walkways & Bikeways	✓	✓		✓	✓

## Small Community Resources

---

### Resources for Small Communities

In addition to books and magazine articles (see Appendix B to this volume), small communities can use each other as resources. For example:

- **Bicycles:** Chelan, Washington, has a city-wide bicycle program. The downtown has bike racks in front of stores, restaurants, and even banks. Streets are wide enough to handle cyclists. The city parks have bike racks located near rest rooms, picnic areas, and beaches. Buses serving Chelan and surrounding communities also have bike racks. The availability of public restrooms, benches, bikeways, and a bike trail map make Chelan very bicycle-friendly.
- **Sidewalks:** Ellensburg, Washington, has created a pedestrian-friendly downtown with brick sidewalks that widen at crosswalks so as to narrow the streets to an easy two lanes. An active historic preservation program and attractive plantings of flowers and trees makes the downtown a pleasant pedestrian destination.
- **Pedestrian Walkways:** Mt. Vernon, Washington, has used attractive paving, street trees and plantings to turn spaces between downtown buildings into pedestrian walkways, connecting streets midblock.
- **Main Streets:** The National Main Street Center uses a four point program to address problems of main street revitalization: organization, promotion, design and economic diversification.

The National Main Street Center  
1785 Massachusetts Avenue N.W.  
Washington, D.C. 20036

- **Historic Preservation:** Both the National Trust for Historic Preservation and the state have resources tailored for small communities.

The National Trust for Historic Preservation  
1785 Massachusetts Avenue N.W.  
Washington, D.C. 20036

Washington State Department of Community Trade  
and Economic Development  
Office of Archeology and Historic Preservation  
111 - 21st Avenue S.W.  
P.O. Box 48343  
Olympia, WA 98504-8343  
(206) 586-6125

The Small Towns Institute is located in Ellensburg, Washington, and is a "a nonprofit corporation dedicated to collecting and disseminating information on new and innovative ideas concerning the issues and problems facing small towns and non-urban areas." For more information:

Small Towns Institute  
Third Avenue & Poplar Street  
Post Office Box 517  
Ellensburg, WA 98926  
(509) 925-1830

## ***Chapter 8: Model Goals and Policies for Effective Public Transportation***

---

- Introduction: A Policy Foundation for Local Action***
- Goals and Policies***
  - ***County-Wide Planning Policies***
  - ***Local Comprehensive Plan Policies***
  - ***Transit Service Policies***

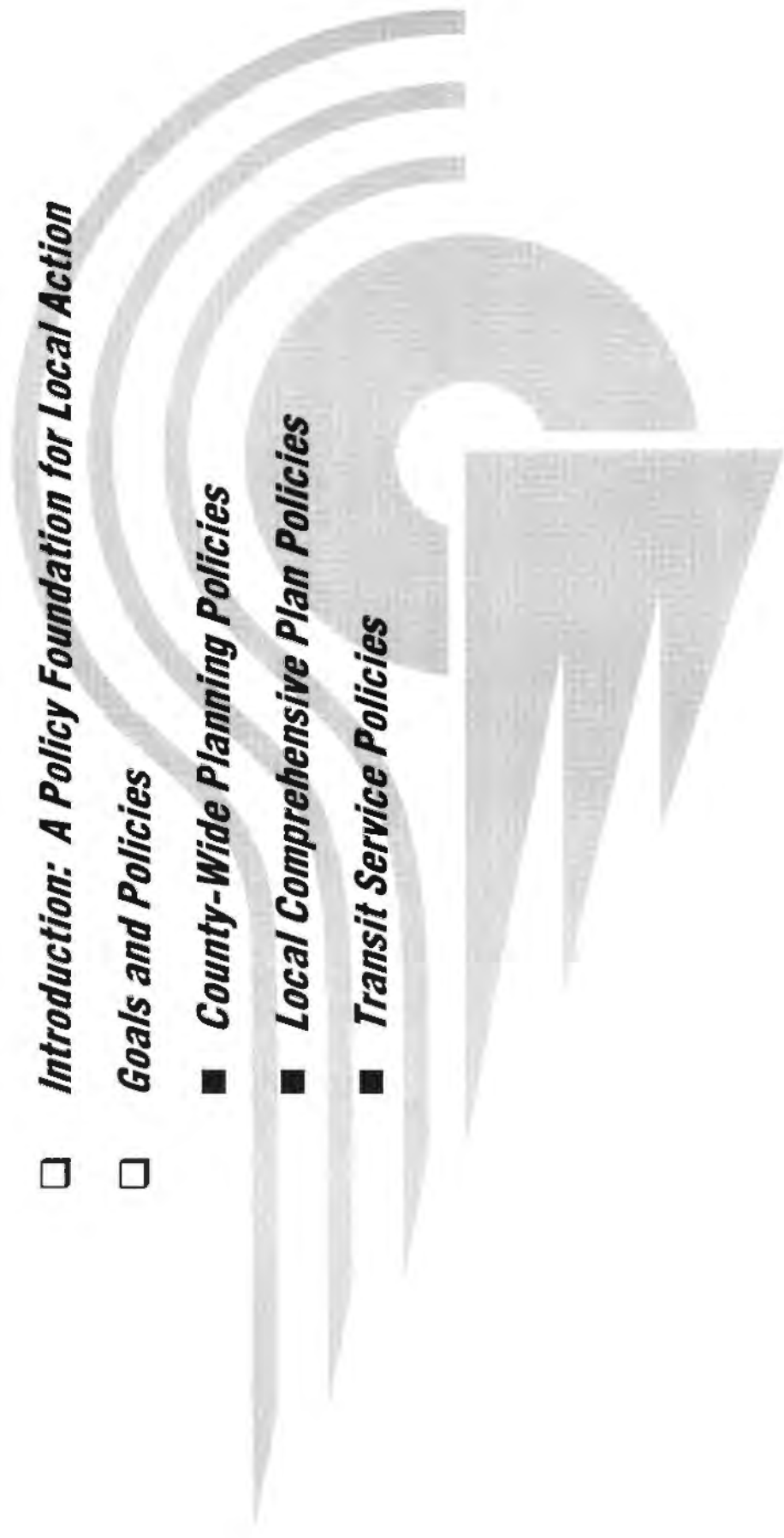





## A Policy Foundation for Local Action

### Land Use and Transportation: Battle-Cry for the 1990's

Over the past ten years the Puget Sound region of Washington State has experienced rapid growth and suburbanization. New subdivisions, shopping centers and office parks have scattered across the landscapes of the five central counties, bringing new opportunities, new jobs, and new faces. But with this growth and prosperity have come growing pains—traffic congestion, air and water pollution, and a loss of farmlands and forests. These problems have awakened the region's leaders to the need for better management of growth and stronger community planning. The result has been a flurry of legislation over the last few years, producing such milestones as:

- *The State Growth Management Act, 1990*
- *The Regional Plan, Vision 2020, 1990*
- *The State High Capacity Transit Act, 1990*
- *The State Commute Trip Reduction Act, 1991*

This chapter briefly reviews these state and regional initiatives and examines them in the context of a common tenet—the need to more effectively match land development with adequate transportation systems. Then the chapter provides model goals and policies aimed at helping counties, cities, and transit companies synchronize their planning efforts to forge strong links between land use and transportation.

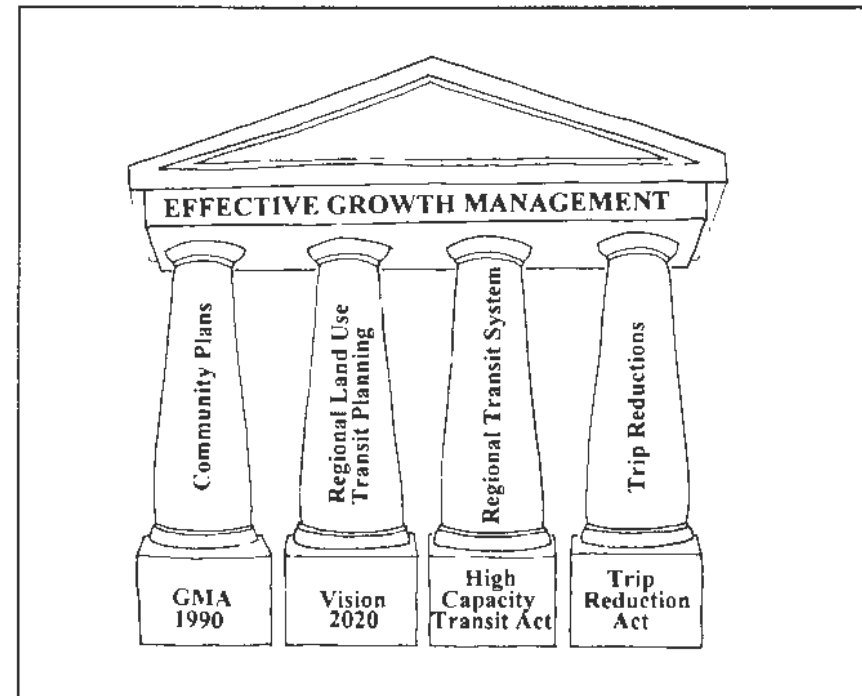

*Recent laws & plans form the foundation for better planning.*

## ***A Policy Foundation for Local Action***

### ***GMA - A New Era in Comprehensive Planning***

At the center of Washington's effort to get a handle on Puget Sound growth is the Growth Management Act (GMA), a landmark 1990 law setting new standards for regional and community planning. The GMA requires cities and counties to devise detailed, long-range plans and draw urban growth boundaries to curb suburban sprawl. Within these urban growth boundaries, more compact cities and towns are to be planned so that services, such as public transportation, can be provided more efficiently.

The first three of the GMA's 13 goals are:

- *Growth in urban areas;*
- *Less suburban sprawl; and*
- *Efficient, integrated transportation systems.*

Under GMA, cities and counties must:

- Adopt a comprehensive plan that addresses land use, transportation, housing, capital facilities, and rural land;
- Ensure that all elements of the plan are consistent;
- Coordinate planning with neighboring areas;
- Contain new development inside urban growth boundaries, and focus growth into urban centers; and

- Ensure that new development comes with needed transportation systems, including public transportation.

Under GMA, the policies and maps of the community plan will closely guide land use regulations, including zoning. The land use and transportation elements in each community's plan must be consistent, which means a community may no longer plan new housing, shopping centers, or other urban development without also planning—and securing the means to build—the needed roads and transportation services. The comprehensive plan of the GMA era will shape community development more directly than ever before and will be the key to creating a transit compatible environment.

*Land use and transportation elements must be consistent, which means a community may no longer plan new housing, shopping centers, or other urban development without also planning needed roads and transportation services.*

## A Policy Foundation for Local Action

**U**nder GMA, transit plans must be consistent with city and county comprehensive plans.

### **Transit & Land Use: A Partnership In the Making**

Communities with aspiring development plans will find themselves needing new transportation resources and more efficient transportation systems. If a city wishes to grow or a suburb to urbanize without traffic gridlock, public transportation could become an essential tool. Growing communities will need to work closely with transit companies to plan future development that fosters transit use, cycling, and walking and to help target transit services where they will be most effective. For transit companies, comprehensive community planning means predictability—knowing where and when public transportation will be needed—and this will help ensure transit services that help achieve community development and growth management goals.

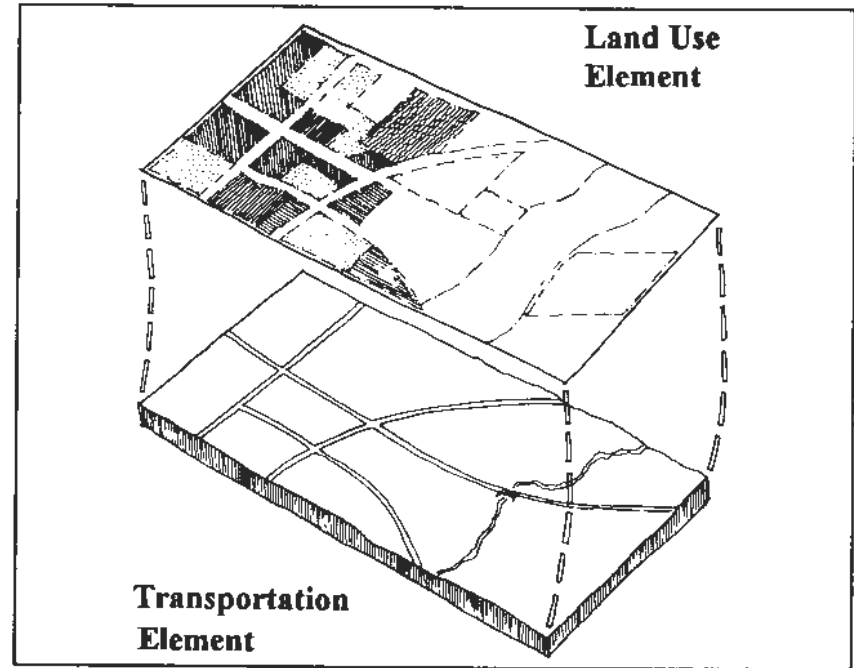

*GMA: Matching land development with transportation systems.*

### **GMA and Transit Planning—What's New?**

Washington State law requires public transit companies to prepare and annually review a plan for the capital facilities and services they expect to build over the next six years.<sup>1</sup>

<sup>1</sup> Some transit companies, depending on the laws under which they are formed, must also adopt a comprehensive plan. Public Transportation Benefit Authorities (PTBA's) and County Transportation Authorities (CTA's) fall under such laws (RCW 36.57.070 and 36.57A. 060, respectively.)

## A Policy Foundation for Local Action

Under GMA, transit plans and local comprehensive plans must be consistent with one another.<sup>2</sup> This means that transit facilities and services identified in a city or county comprehensive plan should also appear in the transit company's plans. Conversely, the transit company's long range service plan should include and be based on land use assumptions that match those in local comprehensive plans. Clearly this requires transit companies to work closely with cities and counties in their planning.

Transit companies are the source for information on existing and planned facilities and services—information that GMA requires be shown in the transportation and capital facilities elements of local comprehensive plans. As cities and counties are putting these elements together, transit planners must be involved to ensure that local plans reflect the transit company's goals and capacities. Likewise, city and county planners need to participate in transit planning to ensure that planned transit services will meet local needs.

2 GMA: Sec. 6 (6).b.i & ii;6.c.ii; Sec 60 (1). "Consistent" is not defined in the GMA. However, local comprehensive plans must include an inventory of transit routes and must establish level of service standards for transit routes. GMA requires that transit company 6-year plans and comprehensive plans conform to local comprehensive plans.

### The Regional Vision

*With growth management and better transportation, scattered suburbs can grow into more compact communities where people have easy access to housing, businesses, parks, cultural attractions, and services.*

The GMA calls for strong regional coordination of transportation systems. The act provides for the formation of Regional Transportation Planning Organizations (RTPO's) to develop regional transportation plans and to coordinate local transportation planning. In the Central Puget Sound region, the Puget Sound Regional Council has assumed the RTPO role, and the Council's plan, Vision 2020, has been endorsed region-wide. The PSRC is the federally-recognized Metropolitan Planning Organization (MPO) and maintains a regional plan. The GMA requires that, where an MPO exists, it must be the Regional Transportation Planning Organization.

Adopted in 1990, Vision 2020 takes a major step toward public transportation compatible development. The 30-year plan calls for an increasing reliance on public transportation and for transit compatible land use on a regional scale. Vision 2020 sees a region of lively and attractive urban centers linked

## ***A Policy Foundation for Local Action***

together by diamond lanes, expanded bus service, rail systems, and new roads. With growth management and better transportation, scattered suburbs can grow into more compact communities where people have easy access to a mix of housing, businesses, parks, open space, and cultural attractions. In these higher-density, mixed-use communities, public transportation would be more efficient and more people could work and shop within walking or bicycling distance of their homes.

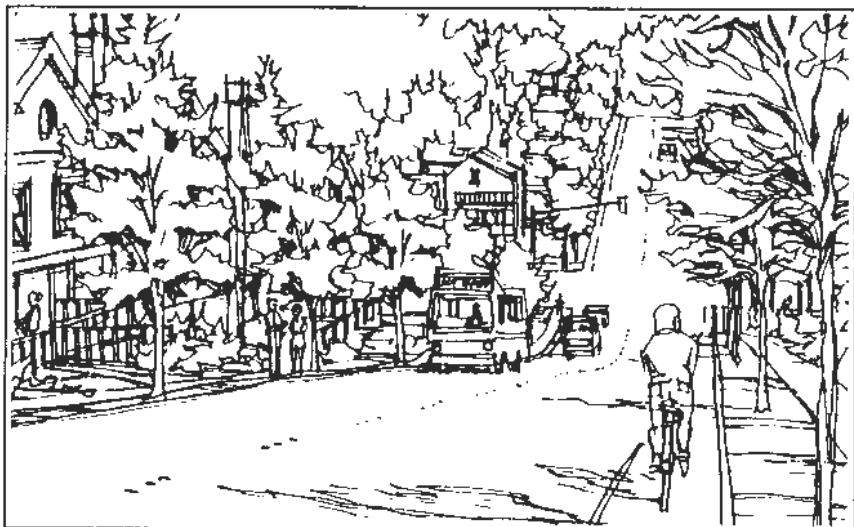

*Vision 2020 centers range from small town to metropolis.*

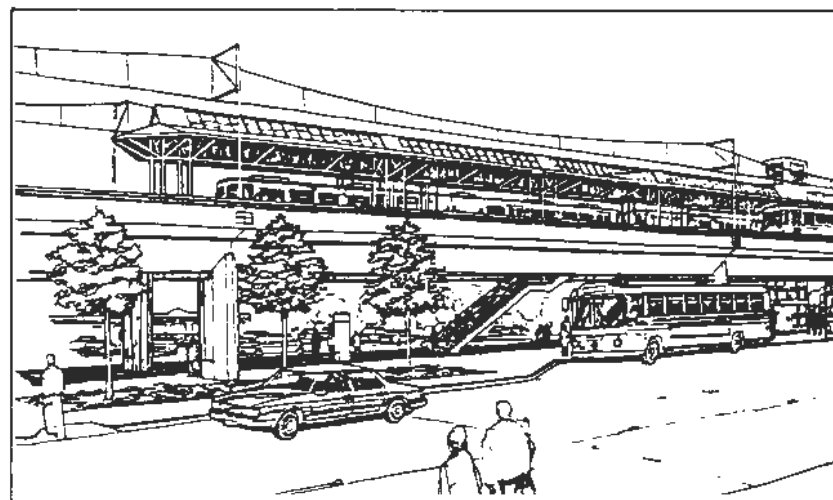

*New investments in transit are an essential part of the vision.*

### ***New Investments in Transit***

As communities begin to take on a transit-compatible form and transit services are aligned with community development plans, residents will find transit more convenient and accessible, giving people more confidence that transit is a good investment. This is especially important in the central Puget Sound region, where the regional plan calls for unprecedented investments in public transportation over the next 30 years.

## A Policy Foundation for Local Action

The largest component of the transportation system envisioned in the regional plan is high capacity transit, or rapid transit. Rapid transit means railways or exclusive busways linking major cities—the trunk of the region's transit network. The 1990 State High Capacity Transit Act authorizes transit agencies in the region to plan such a system and seek approval to build it from the region's voters. Recognizing the importance of land use to making the system work, the act requires that the rapid transit plan include a program for achieving transit-compatible development on a regional scale.

### **Commuter Trip Reduction**

Another key law of 1991 was the state Commuter Trip Reduction Act. This law requires certain businesses with more than 100 employees to adopt programs to reduce how far and how often their employees drive to work.<sup>3</sup> These *commuter trip reduction programs* can include incentives, such as subsidized bus passes and easy access to ridesharing, or disincentives, such as parking fees. City and county governments administering the trip reduction law must adopt a commuter trip reduction plan that sets goals for reducing auto trips generated by employers. They must also develop a trip reduction program for their own employees.

<sup>3</sup> The law applies only to businesses meeting a number of specific criteria. These businesses are asked to reduce their employee travel, ultimately cutting 35% of employee commute mileage by 1997.

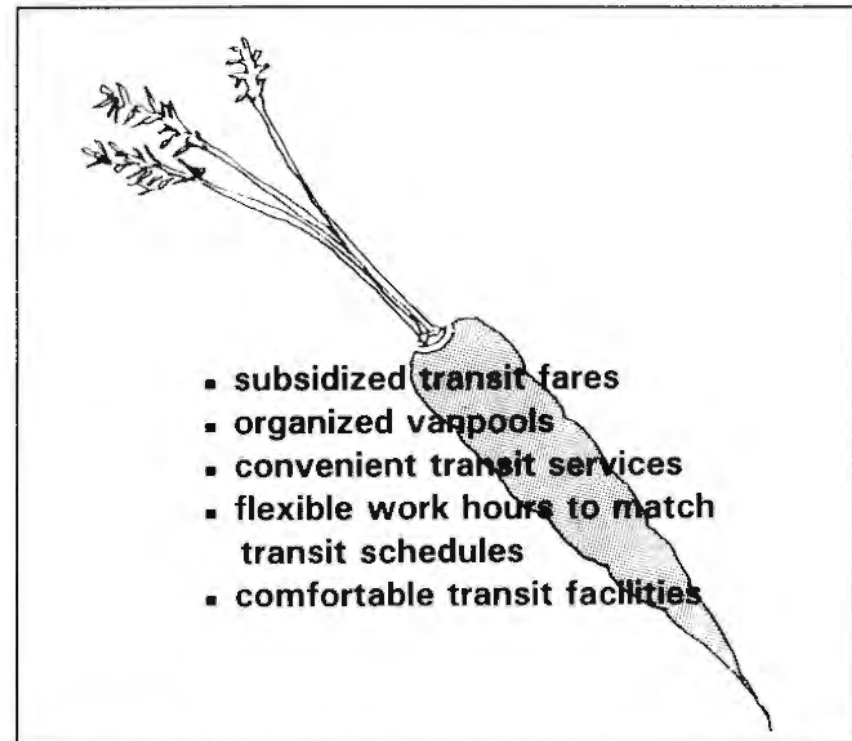

*Incentives are essential to trip reduction.*

## A Policy Foundation for Local Action

**D**iscouraging people from driving creates a need for alternatives that can compete with the speed and convenience of car travel.

Discouraging people from driving creates a need for alternatives that can compete with the speed and convenience of car travel. Transit companies will be challenged to provide new transportation services and better access to existing services—and to make these services competitive with the automobile. But again, for public transportation to be competitive, communities must lay the foundation through transit-supportive land use planning.

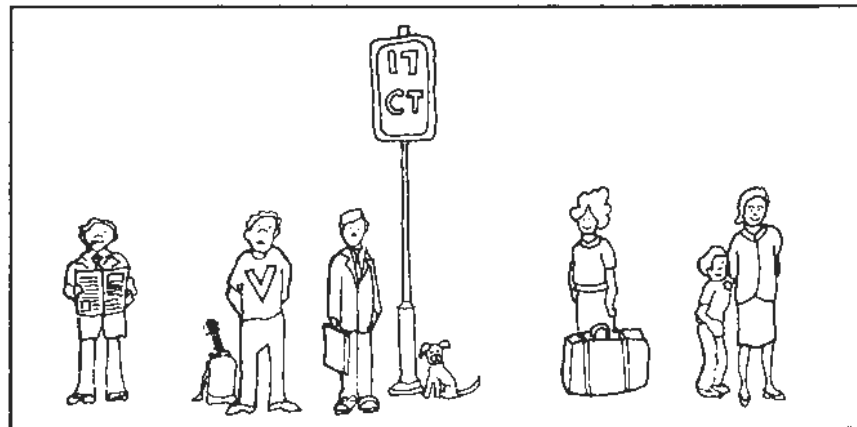

Public transportation should be convenient for all communities.

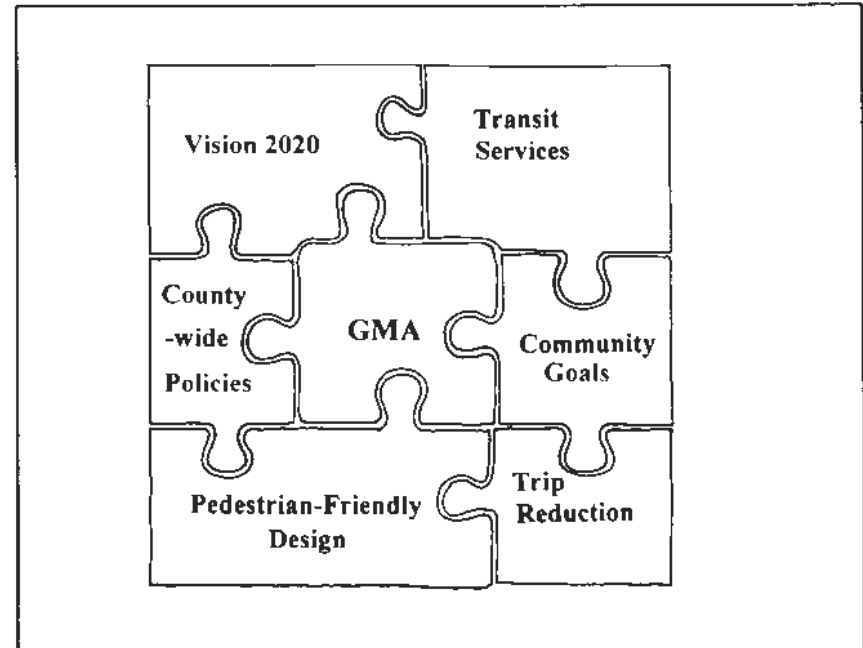

The growth management challenge: putting it all together.

### The Growth Management Puzzle

The Growth Management Act, Vision 2020, regional rapid transit, county-wide planning, commute trip reduction—suddenly there are many more pieces to the community development puzzle. Sorting through all of these new planning tools is a large and complicated job, and one that will take a concerted and coordinated effort by counties, cities, transit companies, and all public agencies.

## Goals and Policies

### *Local Implementation—A Three-Level Approach*

Under GMA, county government, in cooperation with cities, must adopt a set of framework policies to guide and coordinate community planning. Together, the County and cities are required to lay out common methods and objectives—a unifying framework into which each community's comprehensive plan must fit. Transit companies, too, are required to develop long range plans, and GMA says these transit service plans must be consistent with local comprehensive plans. Such consistency starts with a strong county-wide planning framework and is then carried out through cooperative planning by communities and transit companies.

This section offers model goals and policies to help link land use and transit at the three key levels of planning: county-wide, community, and transit service. These goals and policies are offered as ideas—a starting point—and are aimed at helping counties, cities, and transit companies synchronize their planning to forge strong links between land use and transportation in their respective plans. The policies are not all-inclusive, but are intended to supplement the wider range of land use, transportation, and related policies that guide community development.

### **Preamble:**

*We, the citizens of Snohomish County, facing traffic congestion, air and water pollution, and loss of land to parking and roads, find it necessary to reduce our reliance on automobile travel. We intend to develop cleaner, more efficient modes of transportation - modes such as public transit, ride-sharing, bicycling, and walking. And to make these alternatives successful, we shall guide our community planning with goals and policies aimed at creating an environment in which public transportation can be efficient, convenient and easy to use.*



## Goals and Policies - Goal I: Efficient Transportation

*Goal I: An efficient transportation system that meets regional, county-wide and local travel needs.*

### ➤ *Rationale*

*Over the past forty years we've designed and built communities based on the assumption that everyone will travel by car. The vast majority of our transportation resources have gone to roads, and we've let their design be dictated by the needs of the automobile over those of pedestrians and transit riders. Road planning, especially in the suburbs, has moved away from the traditional, pedestrian and transit-friendly grid of small blocks and toward self-contained developments with cul-de-sacs, loops and dead ends. Without local connections, such developments are linked together only via a few overburdened and ever-widening arterial roads. The result is long, roundabout routes which are manageable by car but make transit service inefficient and make cycling or walking slow and often dangerous. Add a lack of bus pull-outs, bike lanes, and even sidewalks, and it's clear that we've left public transportation out of our planning.*



*An efficient transportation system leads to successful communities.*

## Goals and Policies - Goal I: Efficient Transportation

**Objective A: Actively coordinate transportation planning among all levels of government.**

### County-Wide Planning Policies

1. **Jointly Plan Transportation.** The County and the cities shall work jointly with state and regional governments and the transit agencies to plan and develop a coordinated county-wide transportation system.
2. **Support Transportation Funding.** The County and cities shall develop and support measures to raise additional revenues for carrying out transportation plans and policies.

### County-Wide Actions

- Jointly develop a framework county-wide plan, addressing land use, transportation, and capital improvements, which will guide the county, cities, and transit companies in preparing their comprehensive plans.<sup>4</sup>

<sup>4</sup> In Snohomish County, a cooperative transportation planning effort was begun by Snohomish County Tomorrow, an assembly of elected officials formed to oversee growth management. Each local jurisdiction, along with the State DOT, the Puget Sound Regional Council, and the transit companies, provides staff to a Transportation Technical Advisory Committee (TRANTEC), whose responsibility it is to come up with a county-wide transportation plan. This process achieves some of the actions under Objective A.

- Agree to participate in county-wide transportation planning and to adhere to jointly adopted plans.

### Local Comprehensive Plan Policies

1. **Coordinate Transportation Planning.** The community<sup>5</sup> shall work actively and cooperatively with the State Department of Transportation, the Metropolitan Planning Organization (MPO)<sup>6</sup>, neighboring jurisdictions and the transit companies to help achieve regional and local transportation objectives.
2. **Adhere to Joint Plans.** The community shall actively participate in a county-wide transportation planning process and shall base its comprehensive planning on a framework county-wide transportation plan.
3. **Support Transportation Funding.** The community shall develop and support measures to raise additional revenues for carrying out transportation plans and policies.

<sup>5</sup> "Community" means either city or county. The local policies are intended for both county and city comprehensive plans.

<sup>6</sup> The PSRC is the federally-recognized Metropolitan Planning Organization (MPO) and maintains a regional plan. The GMA requires that, where an MPO exists, it must be the Regional Transportation Planning Organization.

## **Goals and Policies - Goal I: Efficient Transportation**

---

### **Local Actions**

- Commit staff to a county-wide transportation planning task force.
- Ensure that the local comprehensive plan is consistent with jointly adopted policies and plans.
- Circulate new transportation plans and proposals to all affected agencies, and actively solicit their comments.
- Ensure that all elements of the local comprehensive plan are coordinated and working toward common objectives.

### **Transit Service Planning Policies**

1. **Coordinate Transportation Planning.** The transit company shall work actively and cooperatively with the State Department of Transportation, the MPO, the County and cities to help achieve regional and local transportation objectives.
2. **Adhere to Joint Plans.** The transit company shall actively participate in a county-wide transportation planning process and shall base its service plans on a framework county-wide transportation plan.

### **Transit Service Actions**

- Commit planning staff to a county-wide transportation planning task force.
- Ensure that transit system plans are consistent with jointly adopted transportation policies and plans.
- Circulate transit plans and proposals to all affected agencies, and actively solicit their comments.

## Goals and Policies - Goal I: Efficient Transportation

**Objective B: Develop a road system that facilitates transit, cycling, and walking as well as driving.**

### County-Wide Planning Policies

1. **Develop an Interconnected Road Network.** The County and cities shall work with the State DOT, the MPO, and the transit companies to plan and build a county-wide grid of interconnected arterial, collector, and local roads to serve existing and planned land uses.
2. **Lay Out Roads to Link Land Uses.** The County and cities shall seek to establish through-roads that link neighborhoods, shopping, employment sites, parks, recreational activities, schools and public services.
3. **Improve traffic flows at major bottlenecks.** The County and cities shall work with the transit companies to mitigate key bottlenecks in the county-wide transportation system.

### County-Wide Actions

- ☑ Jointly develop and adopt a set of basic standards for the layout and design of roads.
- ☑ In the county-wide transportation plan, prioritize transportation projects according to their ability to link housing, businesses, shopping, recreation, and other complementary land uses.

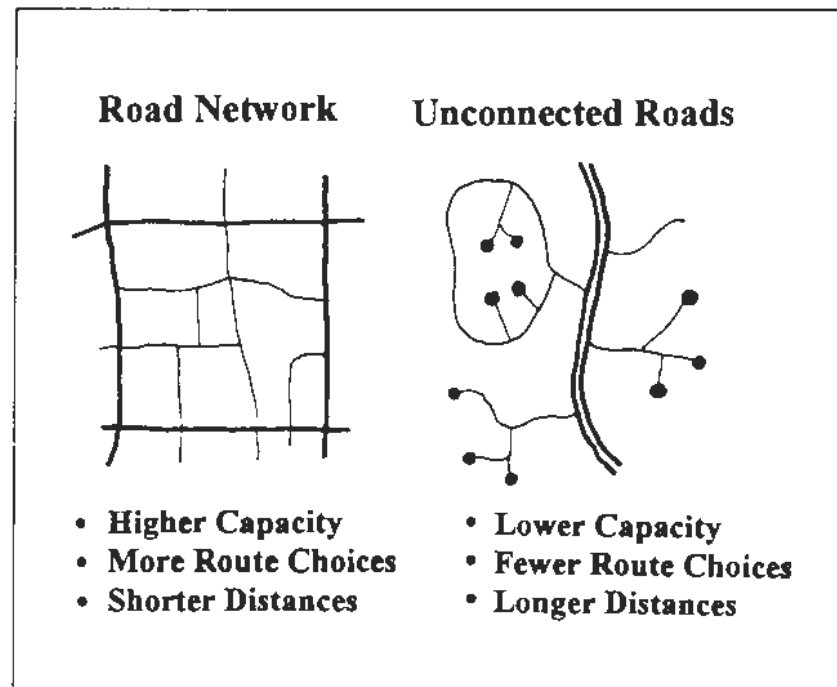

Interconnected roads make all modes of travel more efficient.

## **Goals and Policies - Goal I: Efficient Transportation**

---

### **Local Comprehensive Plan Policies**

1. **Help Develop an Interconnected Road Network.** The community shall work with the County, State DOT, and transit companies to plan a local network of interconnected arterial, collector, and local roads needed to serve both existing and planned land uses.
2. **Lay Out Roads to Link Land Uses.** Through both comprehensive planning and development project review, the community shall seek to establish through-roads that directly link neighborhoods, shopping, employment sites, parks, recreational activities, schools and public services.

### **Local Actions**

- Participate in a county-wide effort to develop basic standards for the layout and design of roads.
- Adopt local road plans and design standards that are consistent with county-wide standards.
- Develop local transportation plans and programs consistent with the county-wide transportation plan and its policies.
- In the transportation element of the local comprehensive plan, include a map showing how existing roads combined with planned roads will form a well-connected transportation network.
- Amend zoning and subdivision regulations to require connected streets and discourage cul-de-sacs, dead-ends, and loops.

### **Transit Service Planning Policies**

1. **Help Foster an Interconnected Road Network.** The transit company shall work with the State DOT, the County, and the cities to plan a network of interconnected arterial, collector, and local roads to serve existing and planned land uses.

### **Transit Company Actions**

- Provide planning staff to help develop transit and pedestrian-friendly standards for laying out roads.
- In county-wide transportation planning, identify key segments in the road network which need to be built for effective transit routing.
- Contribute money to help build key road segments needed to enhance transit service.

## Goals and Policies - Goal I: Efficient Transportation

**Objective C: Make roads in the county safe and convenient for bicyclists and pedestrians.**

### County-Wide Planning Policies

1. **Develop a Network of Sidewalks.** The County and cities shall actively promote development of a complete network of sidewalks throughout the urban growth area.
2. **Develop Walkways and Shoulders.** Outside the urban area, the County and cities shall promote, at minimum, shoulders safe for walking on all roads except freeways and shall encourage paths and walkways connecting neighborhoods with shopping areas, jobs, parks, and other complementary land uses.
3. **Plan a Network of Bikeways.** The County and cities shall work with the State DOT and the transit companies to jointly plan a network of bike lanes serving, at minimum, all parts of the urban growth area.

### County-Wide Actions:

- Include a bikeways element in the County-Wide Transportation Plan.
- Include a walkways element in the County-Wide Transportation Plan.

- Jointly develop and adopt basic standards for the layout and design of bikeways and walkways.
- Jointly agree to include in each local transportation element a bikeways map showing where bike paths or bike lanes exist and where they will be built, consistent with the County-Wide plan.
- Pool resources to develop programs promoting pedestrian and bicycle programs.

### Local Comprehensive Plan Policies

1. **Require Sidewalks.** All public and private development projects in the urban growth area shall include sidewalks on both sides of roads (except freeways). Outside the urban growth area, shoulders wide enough for walking shall be the minimum requirement.
2. **Fill Gaps in the Sidewalk Network.** In already-developed areas that lack sidewalks, the community shall identify the most critical gaps in the sidewalk network and develop programs to fill them.
3. **Link Complementary Uses.** The community shall prioritize publicly-funded walkways according to their ability to connect housing, shopping, business, recreation, and other complementary land uses.

## Goals and Policies - Goal I: Efficient Transportation

4. **Build Bikeways.** The community shall plan and develop a network of bike lanes, consistent with the County-Wide Transportation Plan and the plans of adjacent jurisdictions, serving at least all parts of the urban growth area.
5. **Use Consistent Standards.** Use jointly-developed standards for sidewalks, walkways and bikeways.

### **Local Actions:**

- Develop a bikeway plan as part of the community plan's transportation element, including a map of existing and planned bikeways and a strategy for phasing bikeways into the capital improvement element.*
- Identify key gaps in the walkway network. Include the most critical walkways in the capital improvements element of the community plan.*
- Encourage local improvement districts (LIDs) to build sidewalks where they are lacking.*
- Amend local zoning and subdivision codes to require sidewalks and bikeways for new development.*
- Amend local State Environmental Policy Act (SEPA) regulations to require walkway and bikeway construction as development mitigation, including off-site improvements when needed to connect adjacent complementary land uses.*
- Adopt local design standards consistent with jointly-developed standards for the layout and design of bikeways and walkways.*

### **Transit Service Planning Policies**

1. **Build Walkways and Bikeways.** In planning and building new transit facilities, the transit company shall ensure that sidewalks and bikeways meet or exceed local plans and standards.
2. **Fill Walkway and Bikeway Gaps.** The transit company shall help fund the building of sidewalks and bikeways that will connect transit facilities with adjacent land uses.
3. **Set a Community Example.** The transit company shall set an example of pedestrian-friendly design for the community in all transit company projects.

### **Transit Company Actions**

- Include in the scope of work of all transit construction, acquisition, or leasing projects a provision that facilities be made pedestrian friendly, with transit-oriented design and exemplary sidewalks and bikeways.*
- Examine existing transit facilities for potential retrofitting with sidewalks and bikeways, and program these projects into capital improvement plans.*
- Provide secure bicycle parking at all major transit facilities and buildings.*
- Allow bicycles on buses.*

## Goals and Policies - Goal I: Efficient Transportation

**Objective D: Develop a public transportation system that allows people to conveniently travel between and within regional and local activity centers.**

### County-Wide Planning Policies

1. **Plan for Public Transportation.** The County and cities shall work with the transit agencies, the State DOT, and the MPO to identify needed transit routes, facilities and services based on regional, county-wide, and local land use plans.
2. **Establish Primary Corridors.** The County and cities shall work with the State DOT, MPO, and transit companies to jointly plan and build a network of primary corridors<sup>7</sup> which will emphasize transit, ridesharing, and cycling to move people between activity centers.
3. **Design Roads With Features That Make Transit Efficient.** The County and cities shall work with the State DOT and the transit companies to plan and build transit-friendly road treatments (such as diamond lanes, priority signals for buses at selected intersections, bus

<sup>7</sup> Primary corridors are routes designed for a high level of transit, cycling, and other alternative modes of travel between activity centers. Pedestrian and transit-friendly design are key features. Some segments of certain corridors may also be designated for higher density housing and mixed use.

stops, and park-and-ride lots) along primary corridors and selected transit routes.

4. **Build Roads that Accommodate Buses.** The County and cities shall work with the State DOT and the transit companies to design major roads and transit routes with adequate weight capacities, turning radii, and other features needed to operate buses.<sup>8</sup>

### County-Wide Actions:

- ☑ In the County-Wide Transportation Plan, include a public transportation element that identifies needed transit services and facilities as well as costs and funding sources.
- ☑ In the County-Wide Transportation Plan, identify HOV treatments needed to ensure efficient transit service in and between activity centers.
- ☑ In the County-Wide Transportation Plan, map out a network of primary corridors linking activity centers.
- ☑ Jointly develop standards for HOV treatments on local roads.

<sup>8</sup> The Washington State Department of Transportation Design Manual contains a chapter on transit-compatible design. Communities are encouraged to use the manual for consistency.



## Goals and Policies - Goal I: Efficient Transportation

### Local Comprehensive Plan Policies

1. **Plan for Public Transportation.** Based on the County-Wide Transportation Plan and adopted transit plans, the community shall incorporate local parts of the public transportation system into the local comprehensive plan.
2. **Jointly Develop Transit Services to Meet Community Needs.** The community shall work with the transit company to plan and develop public transportation services that link local activity centers and provide convenient circulation in the urban growth area.
3. **Establish Primary Corridors.** The community shall work with the State DOT, the County, and the transit companies to jointly plan and build a network of primary corridors that emphasize transit, ridesharing, and cycling to efficiently move people between activity centers.
4. **Build Roads that Accommodate Buses.** The community shall design major roads with adequate weight capacities, turning radii, and other features needed to operate buses.

### Local Actions

- ☑ In the local comprehensive plan, include a public transportation facilities and services plan that addresses primary corridors, bus routes and stops, and rideshare services and facilities.

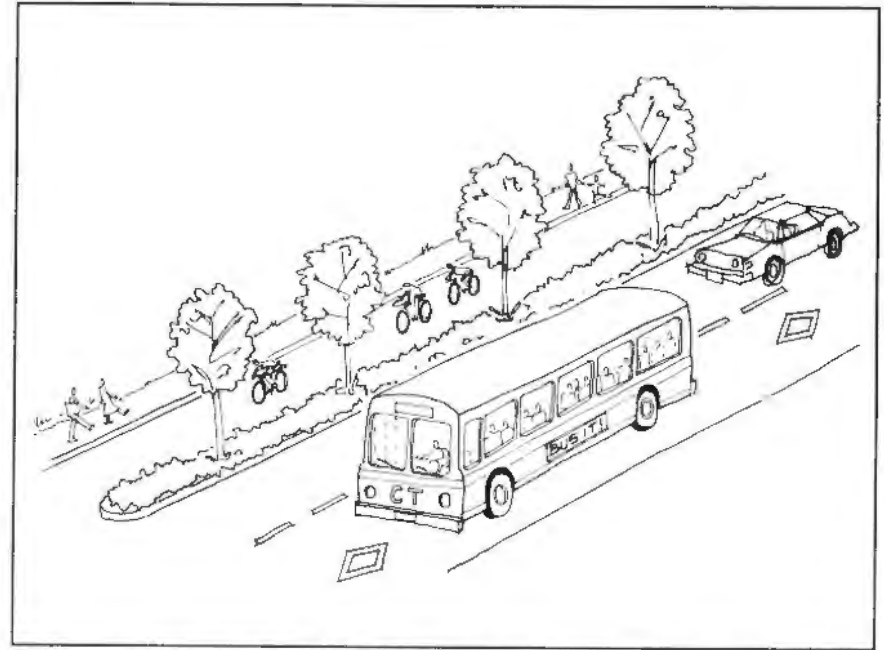

Primary corridors: Highly efficient roads linking activity centers.

- ☑ In the comprehensive plan, include an assessment of how well each element will help make public transportation more effective in meeting county-wide and community needs.
- ☑ Modify local road design standards so they reflect county-wide standards for HOV treatments.
- ☑ Support local and regional efforts to fund public transportation facilities and services.

## ***Goals and Policies - Goal I: Efficient Transportation***

---

### ***Transit Service Planning Policies***

1. ***Support Development of Centers.*** The transit company shall work with the MPO, the County and the cities to develop public transportation services that make it easy for people to travel between and within cities, towns, and urban activity centers.
2. ***Emphasize Urban Services.*** The transit company shall work toward providing a quick, convenient, and reliable alternative for traveling within the urban growth area.
3. ***Support Compatible Land Use Planning.*** In planning new services and facilities, the transit company shall give priority to communities that have adopted plans for urban, transit-compatible development.
4. ***Utilize Primary Corridors.*** The transit company shall ensure convenient and frequent transit service along primary corridors.
5. ***Link Service to Land Use.*** The transit company shall develop its service plans based on locally adopted land use plans and shall provide service commensurate with land use intensity (i.e., higher density/intensity receives greater service.)

### ***Transit Company Actions***

- ☑ *Develop a long range service plan with a land use element that reflects regional and local plans and serves as a basis for planning future services.*
- ☑ *In the land use element of the transit plan, indicate regional and local activity centers and primary corridors and show how planned services support them.*
- ☑ *In the transit service element of the transit plan, allocate higher levels of service to areas with higher density, mixed use, and pedestrian-friendly design.*
- ☑ *Help fund construction of HOV treatments in local communities.*
- ☑ *Enter into agreements to assure local governments of services needed to support higher density land uses.*
- ☑ *Work with transit companies serving neighboring areas to coordinate services, including facilitating service into each other's districts.*

## Goals and Policies - Goal I: Efficient Transportation

**Objective E: Develop high quality transportation facilities and services quickly.**

### County-Wide Policies

1. **Plan for Public Transportation Needs.** The County and cities shall work actively and cooperatively with the State DOT, the MPO, and the transit companies in planning regional and county-wide transportation systems and locating sites for public transportation facilities.

### County-Wide Actions

- ☑ Identify existing and planned regional and local transit facilities in the County-Wide Transportation Plan.

### Local Comprehensive Plan Policies

1. **Provide for Transit Facilities.** The community shall provide for planned park-and-ride lots, transit stations, HOV lanes and similar components of the county-wide or regional transit system in local comprehensive plans and zoning.

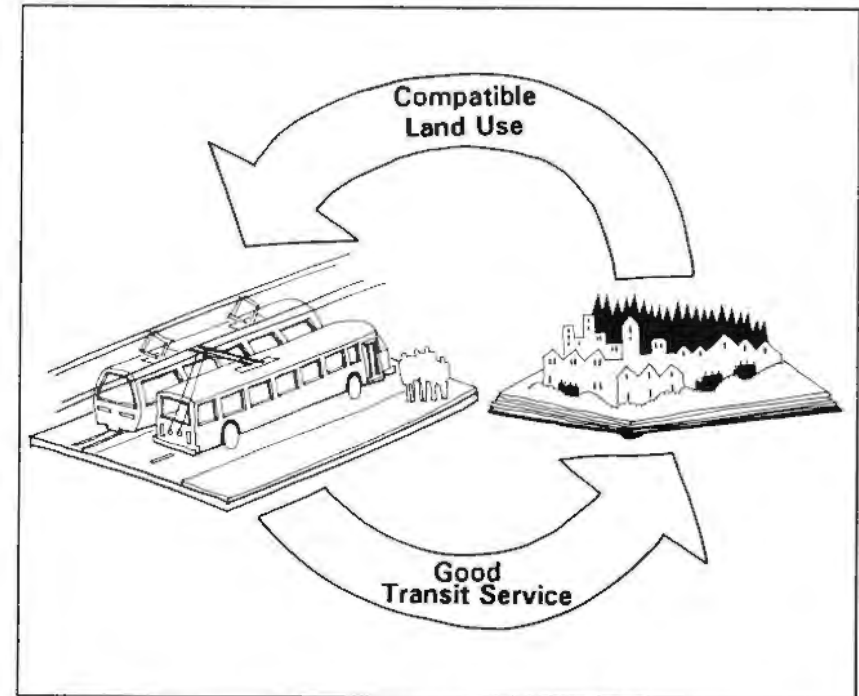

*Efficient transportation supports community development.*

## Goals and Policies - Goal 1: Efficient Transportation

### Local Actions

- ☑ Amend the local comprehensive plan, zoning, and other codes to allow transit facilities and to establish a quick and reasonable process for issuing permits for them.

### Transit Service Planning Policies

1. **Distribute Transit Facilities Equitably.** When planning new transit facilities, the transit company shall consider locations that would help distribute the impacts and benefits of such facilities as equitably as possible.
2. **Design Facilities to Benefit Local Communities.** When designing transit facilities, the transit company shall adhere to local design criteria, reflect neighborhood character, and, where feasible, provide local improvements such as sidewalks, bikeways, and open space.

### Transit Company Actions

- ☑ Educate local planners and officials about the transit system, future plans, and specific facilities that may impact their communities.

- ☑ Review local comprehensive plans and ordinances and point out to local officials specific parts that might interfere with development of the public transportation system.
- ☑ When planning a specific facility, invite local planners and citizens to help with the siting and design.
- ☑ Make sure that all transit facilities are attractively and safely designed.

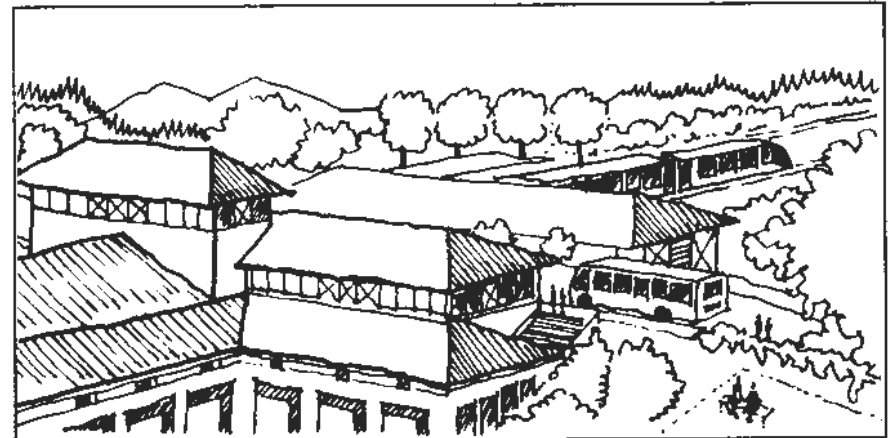

Commercial services at transit facilities are convenient for riders.

## Goals and Policies - Goal II: Transit-Compatible Land Use

**Goal II: Land use and urban design that make public transportation an attractive alternative to driving.**

### ➤ Rationale

To make transit, cycling, and walking realistic options, communities need transit-friendly patterns of land use. At the county-wide level, this means identifying urban activity centers<sup>9</sup> and making those centers the focus for investment and development. Activity centers are natural markets for public transportation because they bring together a wide variety of activities, allowing people to work, shop, and take care of daily business without a car. At the community level, specific areas need to be identified where higher density, mixed land uses can be promoted—preferably along existing transit routes. By identifying such local activity centers in their plans, communities show the transit company where transit services will be most effective. In turn, the transit company must support these activity

<sup>9</sup> An activity center may be a large downtown, a small-town main street, or a neighborhood where a variety of activities draw people together.

centers with transportation services that make it easy to travel between and within them.

Creating a pedestrian and transit-friendly environment requires planning and designing land uses on a pedestrian scale. This essentially means putting housing and shopping and workplaces close enough together so that people can conveniently walk between them, then linking these uses together with local streets and sidewalks (rather than isolating or "buffering" them from one another with walls and landscaping). Covered walkways, lighting and street-level amenities are needed to make walking both safe and inviting. Land use policies requiring such pedestrian-friendly design not only support transit, but help create attractive, vibrant communities.

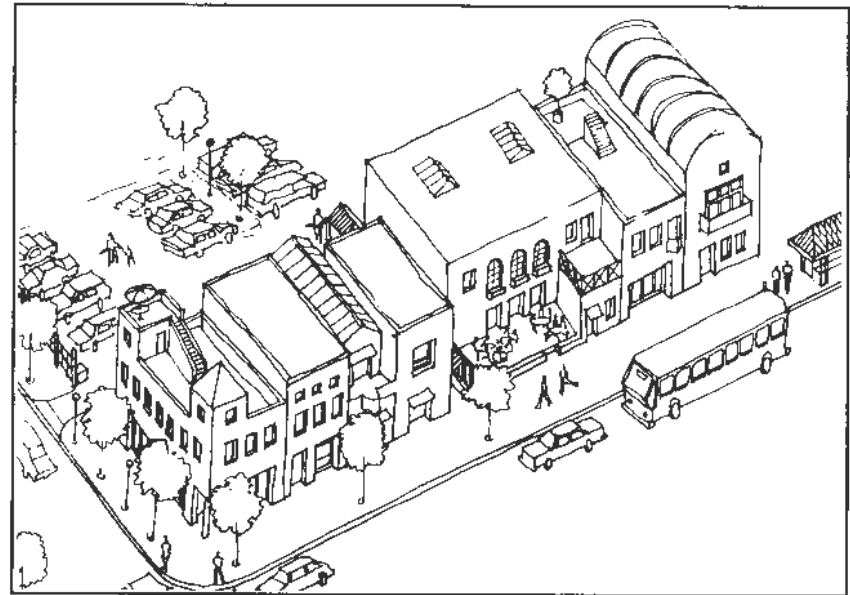

*Pedestrian-oriented design is an essential part of creating successful communities.*

## Goals and Policies - Goal II: Transit-Compatible Land Use

**Objective A: Develop compact, attractive city and town centers that can be linked by a variety of transportation modes.**

### County-Wide Policies

1. **Plan Transit-Friendly Activity Centers.** The County and cities shall jointly identify activity centers within major transit corridors and shall support investment and development in these centers. Transit companies and local governments shall work together to link and provide circulation within these centers.
2. **Direct Growth to Urban Areas.** The County and cities shall jointly promote growth in urban activity centers while discouraging growth outside the urban growth area.
3. **Provide Incentives for Urban Development.** The County and cities shall provide developers with incentives to develop in designated urban activity centers.

4. **Plan for Transit-Supportive Density.** The County and cities shall plan residential and commercial land uses at densities that support existing and planned public transportation services.<sup>10</sup>
5. **Encourage In-Fill Development.** The County and cities shall encourage redevelopment and in-fill of underdeveloped land in the urban growth area.

### County-Wide Actions

- ☑ Jointly devise level-of-service<sup>11</sup> and concurrency standards that promote growth in urban areas, especially in designated activity centers, while discouraging growth outside the urban growth area.
- ☑ Jointly develop transit and pedestrian-friendly design standards that can be incorporated into local development regulations.

<sup>10</sup> Communities can use the standards in Chapter 3 to match specific housing and employment densities with the types of transit services available or planned.

<sup>11</sup> Level of service (LOS) is a measure of how well a utility or service is performing. For a road, LOS is a measure of how efficiently traffic flows. For transit it might be a measure of how frequently service is provided or how many people are riding in each vehicle on a particular transit route.

## Goals and Policies - Goal II: Transit-Compatible Land Use

### Local Comprehensive Plan Policies

1. **Create Local Activity Centers.** In town centers and other local activity centers, encourage a pedestrian-oriented mix of housing, business, commercial services, open space and cultural attractions.
2. **Encourage Transit-Compatible Densities.** In existing and planned activity centers, encourage development densities that will support existing and planned levels of transit service.
3. **Encourage In-Fill Development.** The community shall encourage redevelopment and in-fill of underdeveloped land in the urban growth area.

### Local Actions

- ☑ Develop a package of incentives such as lower parking standards, less stringent concurrency requirements, streamlined permitting and environmental review, and better transit services to promote growth in activity centers.
- ☑ In devising local level-of-service standards, ensure that traffic standards do not prohibit development in designated activity centers.
- ☑ Build or lease any new public offices or other large employment centers only in designated activity centers.
- ☑ Encourage in-fill and redevelopment by designating underdeveloped or declining neighborhoods for public investment.

- ☑ Adopt development regulations and standards that encourage attractive, higher density, mixed use development in local activity centers.

### Transit Service Planning Policies

1. **Serve Activity Centers.** The transit company shall ensure that activity centers designated in county-wide and community plans are linked by transit service.
2. **Activity Centers as Transit Hubs.** The transit company shall make activity centers the hubs for local services.
3. **Integrate Commercial Services With Transit.** The transit company shall promote clustering of housing, shops, and commuter-oriented commercial services near transit hubs.<sup>12</sup>

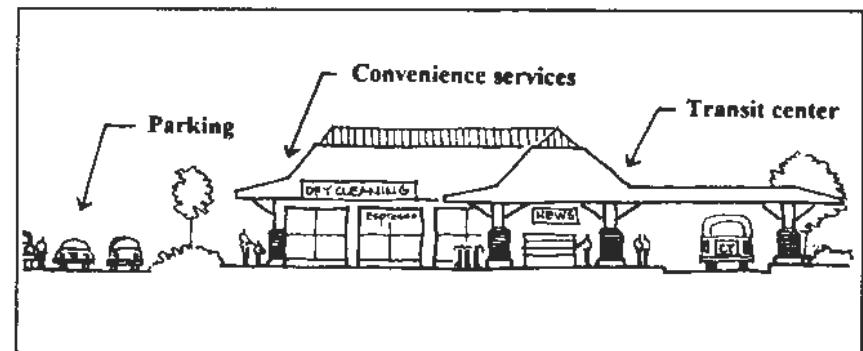

Transit facilities can be attractive additions to a community.

12 Transit centers, rail stations, park-and-ride lots, ferry terminals, etc.

## Goals and Policies - Goal II: Transit-Compatible Land Use

4. **Support Activity Centers.** The transit company shall support the development of urban activity centers when making fiscal and land development decisions.

### **Transit Company Actions**

- ☑ *As a first priority in planning new services, ensure that activity centers are linked together by public transportation and that people can use public transportation to travel within activity centers.*
- ☑ *Build or lease any new transit company offices or other large, non-industrial employment centers only in designated activity centers.*
- ☑ *In planning transit facilities, consider adjacent land uses and how they might be integrated with the facility.*

**Objective B: Design communities so that walking is a safe, convenient, and attractive way to travel.**

### **County-Wide Policies**

1. **Pedestrian-Friendly Neighborhoods.** The County and cities shall promote interconnected local streets, short blocks, and a mix of housing types and neighborhood commercial services in residential areas.
2. **Land Use Patterns on a Pedestrian Scale.** The County and cities shall encourage projects that place residential, commercial, and recreational uses within walking distance of one another and shall promote the development of neighborhood stores and parks in residential areas.

### **County-Wide Actions**

- ☑ *Adopt appropriate parts of Snohomish County Tomorrow's Residential Development Handbook for Snohomish County Communities<sup>13</sup> in updating local plans and development codes.*

---

13 *The Handbook provides a variety of strategies for designing attractive higher density housing.*



## **Goals and Policies - Goal II: Transit-Compatible Land Use**

- ☑ *Jointly devise incentives, such as density bonuses or reduced parking requirements, for developers who design pedestrian-friendly projects.*

### **Local Comprehensive Plan Policies**

1. **Build a Walkway Network.** The community shall establish a complete network of walkways including sidewalks on the street and internal walkways that make it easy for pedestrians to walk into, around and, where appropriate, through a site. New developments shall provide ways through or over barriers like landscaping, walls, swales, and long buildings.
2. **Require Pedestrian-Transit Links.** The community shall require that new transit facilities and adjacent development projects be linked by convenient walkways.
3. **Promote Pedestrian-Scaled Land Use Patterns.** The community shall plan communities and neighborhoods so that distances between neighborhood stores, parks, and other complementary land uses are short enough to conveniently walk.
4. **Eliminate Pedestrian Barriers.** The community shall ensure that local plans, codes, and development review processes result in linked and integrated neighborhoods, shopping, parks, and businesses rather than isolated land uses entirely separated by walls, landscaping and other barriers.

5. **Encourage Pedestrian Amenities.** The community shall promote landscaping, weather protection, public art, street furniture, and other amenities for the pedestrian in public and private development projects.

### **Local Actions**

- ☑ *In developing the land use element of the comprehensive plan, ensure that residential neighborhoods are within walking distance of parks, neighborhood shopping, schools, and other essential services.*
- ☑ *Revise zoning and other development regulations to require walkways and pedestrian amenities and to discourage pedestrian barriers.*
- ☑ *Revise local development regulations to offer incentives, including density bonuses, lower parking requirements, and narrower streets, for developers of pedestrian-friendly projects.*

### **Transit Service Planning Policies**

1. **Design for Pedestrian Access.** The transit company shall site and design its facilities to promote and encourage walking.
2. **Help Make Communities Pedestrian-Friendly.** The transit company shall, in designing all of its facilities, seek to make communities more pedestrian and transit-friendly.

## Goals and Policies - Goal II: Transit-Compatible Land Use

### Transit Company Actions

- ☑ In long range plans, include an assessment of how each major facility might be linked by walkways with surrounding land uses.
- ☑ When choosing sites for transit facilities, use pedestrian accessibility as a major criteria.
- ☑ Include a pedestrian circulation plan with all transit facility site plans.
- ☑ Use every transit development project as a "demonstration project" for pedestrian-friendly design.
- ☑ Make bus stops safe and attractive through high quality design and construction and pedestrian amenities such as lighting, seating, and weather protection.

**Objective C: Plan and design public and private development projects to be accessible to all citizens and by many different modes of travel.**

### County-Wide Policies

1. **Provide for Transit-Oriented Design.** The County and cities shall, in their plans and development codes, provide for transit and pedestrian-oriented design.<sup>14</sup>
2. **Accommodate Transit Facilities.** The County and cities shall, in reviewing and issuing permits for planned developments, ensure that the need for transit facilities has been considered in the site design.
3. **Address Special Needs.** The County and cities shall address in their plans the special transportation needs of people who are elderly, young, disabled, poor, or otherwise face difficulties traveling.

### County-Wide Actions

- ☑ Jointly develop model transit and pedestrian-compatible design standards for local plans and codes.

---

<sup>14</sup> Chapters 7 and 8 explain transit-friendly design. Chapter 5 shows how these concepts can be worked into local zoning and environmental regulations.

## Goals and Policies - Goal II: Transit-Compatible Land Use

- ☑ *Jointly develop model site-planning standards for meeting the needs of special populations with difficulties traveling.*

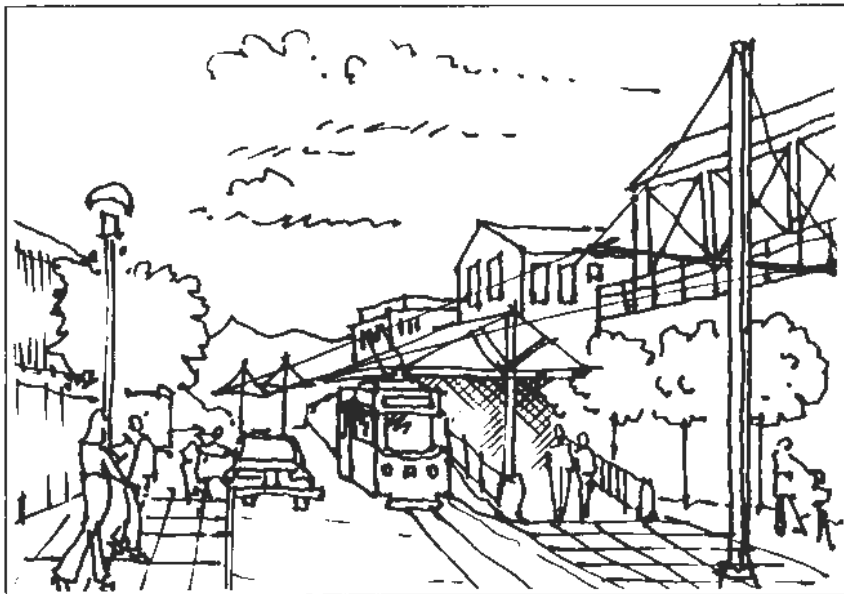

*Mixed uses serve the needs of pedestrian and transit users.*

### **Local Comprehensive Plan Policies**

1. **Require Transit-Oriented Design.** The community shall require transit and pedestrian-oriented design, including parking areas located to the side, rear, or beneath buildings, minimal front setbacks, and main building entrances facing transit routes and sidewalks (rather than parking areas), especially in local activity centers and along transit routes.

2. **Address Special Needs.** The community shall address in its plans and ordinances the special transportation needs of people who are elderly, young, disabled, poor, or otherwise face difficulties traveling.
3. **Involve the Transit Company.** The community shall actively involve the transit company in review of community plans and development permit applications.

### **Local Actions**

- ☑ *Amend the comprehensive plan, zoning, SEPA and other development regulations to require transit and pedestrian-friendly design in local activity centers and to allow such design throughout the urban growth area.*
- ☑ *Incorporate barrier free access standards into zoning and other development regulations.*
- ☑ *Ensure that federal and state regulations for barrier-free access are followed in development projects.<sup>15</sup>*
- ☑ *Work with the local transit company to get their comments on development projects early in the review process.*
- ☑ *Designate a staff planner as transit liaison who will ensure that access to transit is addressed in community planning and development review.*

<sup>15</sup> Most prominent among these regulations are the Americans with Disabilities Act (ADA) and the Washington State Regulations for Barrier Free Facilities

## Goals and Policies - Goal II: Transit-Compatible Land Use

- ☑ Work jointly with the transit company to establish a citizens' committee to recommend ways to improve access to transportation services.

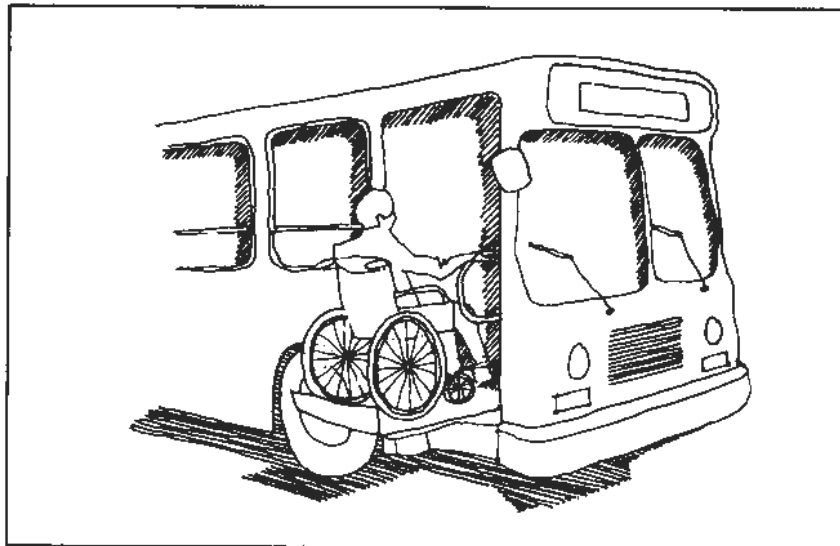

*Barrier-free access serves everyone's needs.*

### **Transit Service Planning Policies**

1. **Serve Special Populations.** Make transit services and facilities accessible to people who are disabled, elderly, poor, or who otherwise face difficulties traveling.
2. **Promote Transit-Compatible Design.** Encourage communities and developers to design projects for transit and pedestrian access.

3. **Design for Access.** Design all transit company facilities and services to give pedestrians, cyclists, elderly and disabled people safe and easy access.

### **Transit Company Actions**

- ☑ Sponsor community education programs to explain the importance of public transportation and the need for transit-supportive land use.
- ☑ Designate a staff person as a community planning liaison who will respond to community requests for information on transit plans or development project review.
- ☑ Develop all transit company facilities as models for showing communities and developers how to comply with the access needs of people with special transportation needs.
- ☑ Offer local community planners and developers the help of transit company staff trained in transit compatible planning and design techniques.
- ☑ Recognize transit-friendly planning and design by sponsoring an annual awards program.

## Goals and Policies - Goal III: Transit Instead of Driving

Goal III: Greater use of transit, ridesharing, bicycling and walking instead of driving.

### ➤ Rationale

For many people, using public transportation instead of driving a car isn't very convenient. Especially in the suburbs, driving is generally quicker, more flexible, and if not cheaper, cheap enough. This is true mainly because we've designed things that way: We've deliberately created communities where businesses, shopping, and homes are kept away from one another. Neighborhoods and shopping centers are designed for easy access by car, often at the expense of pedestrians and transit users. As drivers, we pay only indirectly for an excellent road system (and, in fact, most drivers receive a direct subsidy from employers and businesses in the form of free parking), while we pay a fare to use thinly-stretched transit services. Clearly, for many of the trips we take, the scale is tipped toward the automobile over public transportation.

But government and industry can help tip that scale back. They can offer incentives for people to use public transportation—such things as a monthly transit allowance offered by an employer, or a flexible work schedule to make carpooling easier. They can also make people pay more of the costs of driving. Studies show that many people will find transit a reasonable choice when they are no longer provided free

parking. Such "trip reduction" techniques are one way to get more people into fewer vehicles and make our transportation system more efficient<sup>16</sup>. Ultimately, however, the success of this goal depends on a combination of trip reduction, convenient transit service, easy access, and transit-compatible land use.

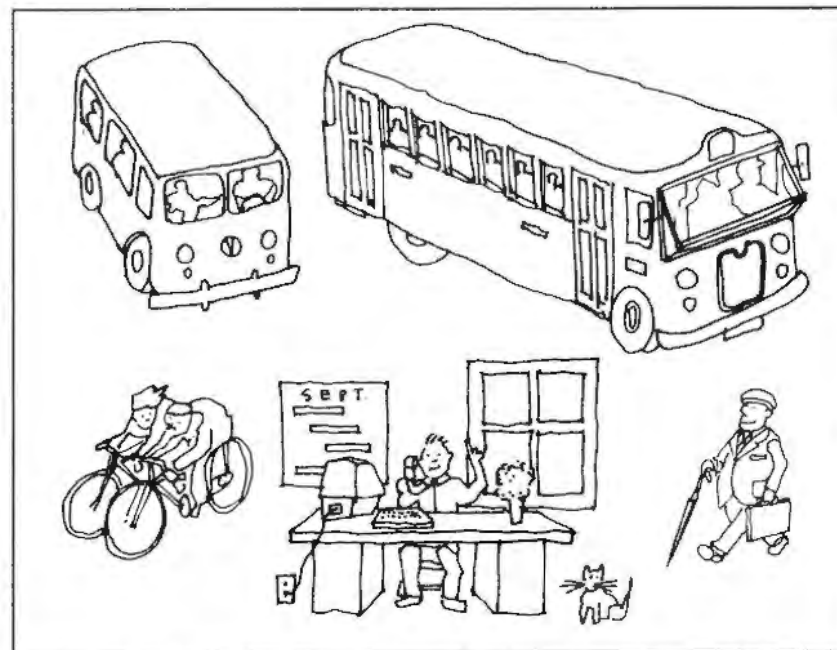

Effective trip reduction requires effective alternatives to driving.

16 Trip reduction programs are required by state law in the Central Puget Sound region for certain businesses with 100 or more employees. Cities and counties where such businesses are located must adopt trip reduction plans and ordinances, including programs for their own employees. The State Energy Office can provide complete guidelines for such programs.

## Goals and Policies - Goal III: Transit Instead of Driving

**Objective A: Develop employer and community-based programs to encourage people to use public transportation more and drive less.**

### County-Wide Policies

1. **Promote Alternatives.** The County and cities shall work with the State Energy Office, the MPO, and the transit companies to promote alternatives to driving (and especially to driving alone).
2. **Support Trip Reduction.** The County and cities shall support public and private trip reduction programs.

### County-Wide Actions

- ☑ Pool resources by establishing county-wide policy and technical committees to coordinate trip reduction education programs and services.

### Local Comprehensive Plan Policies

1. **Adopt a Trip Reduction Plan.** The community shall adopt a trip reduction plan and a trip reduction ordinance.

2. **Reduce Parking.** The community shall discourage driving by reducing the amount of free parking available in public and private developments.
3. **Promote Ridesharing, Transit, and Telecommuting.** The community shall promote ridesharing, public transportation, and telecommuting as alternatives to driving, and especially to driving alone.
4. **Require Transportation Management.** The community shall, as a condition of development project approval, require developers to take all reasonable steps to reduce the amount of car traffic generated by their project.<sup>17</sup>
5. **Offer Incentives for Trip Reduction.** The community shall provide incentives such as lower parking requirements and additional density for developers and employers who actively support the use of public transportation and other alternatives to driving.
6. **Encourage Private Demand Management.** Encourage businesses in the community to form private transportation management associations.

---

<sup>17</sup> For some types of development, a subdivision for example, the developer may have little or no control over the site or its tenants once the project is built and occupied. However, parking and land use are key issues that can and must be addressed by the developer. The developer can also distribute information on transportation alternatives to the initial tenants of the site.

## **Goals and Policies - Goal III: Transit Instead of Driving**

---

### **Local Comprehensive Plan Actions**

- ☑ *Establish a committee of citizens and business people to spearhead a community education program promoting public transportation and trip reduction.*
- ☑ *Develop trip reduction programs for community employees, then help employers to develop similar programs.*
- ☑ *Jointly staff a task force to research and develop a model parking code that would encourage people to use transit and other alternatives to driving.*
- ☑ *Amend local comprehensive plans and zoning to require as few parking spaces as possible for housing, offices, stores and employment centers. Set maximum (rather than minimum) parking space requirements, especially where transit and other alternative modes of transportation are available.*
- ☑ *Amend local regulations to allow people to work or operate reasonable businesses in their homes.*
- ☑ *Contact business leaders in the community and offer community help in setting up transportation management associations and developing trip reduction plans.*
- ☑ *Recognize businesses with effective trip reduction programs through a community awards program.*

### **Transit Service Policies**

1. **Support Local Trip Reduction Efforts.** The transit company shall support community and employer efforts to reduce car trips.
2. **Commit Resources to Trip Reduction.** The transit company shall commit staff and money to providing services needed to make trip reduction work.

### **Transit Service Actions**

- ☑ *Sponsor workshops to educate local officials, developers, and citizens about transit services and trip reduction strategies.*
- ☑ *Offer rideshare coordination services and vanpool programs.*
- ☑ *Provide staff to help local communities and employers develop trip reduction plans and programs.*
- ☑ *Establish computerized ride matching services and a guaranteed ride home program.*

## **Goals and Policies - Goal III: Transit Instead of Driving**

**Objective B: Reduce people's need to drive by making public transportation services more convenient and competitive.**

### **County-Wide Policies**

1. **Limit Road Expansion.** The County and cities shall shift resources from expanding the road network into undeveloped lands to in-filling, completing, and maintaining the existing road network in the urban growth area.
2. **Support Transit Funding.** The County and cities shall support local and regional efforts to fund parts of the planned public transportation system.

### **County-Wide Actions**

- In the County-Wide Transportation Plan prioritize new road projects based on how well they serve in-filling, completing, and maintaining the existing road network in the urban growth area.
- Seriously consider bike lanes, HOV lanes, or sidewalks as alternatives to adding automobile capacity to congested roads.

### **Local Comprehensive Plan Policies**

1. **Limit Road Expansion.** The community shall shift resources from expanding the road network into undeveloped lands to in-filling, completing, and maintaining the existing road network in the urban growth area.
2. **Support Transit Funding.** The community shall support local and regional efforts to fund parts of the planned public transportation system.

### **Local Comprehensive Plan Actions**

- Educate the community to the benefits of transit and the need to support transit projects.
- Lobby for greater transit funding.
- In the community plan, prioritize new road projects based on how well they serve in-filling, completing, and maintaining the existing road network in the urban growth area.
- Seriously consider bike lanes, HOV lanes, or sidewalks as alternatives to adding automobile capacity to congested roads.



## Goals and Policies - Goal III: Transit Instead of Driving

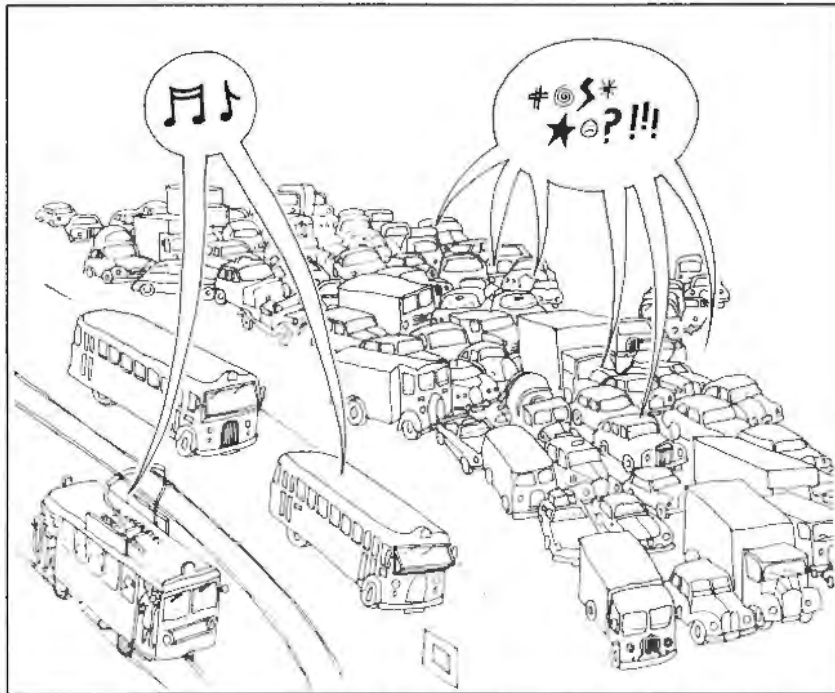

Good transit service is the way to keep the region moving.

### Transit Service Policies

1. **Provide Convenient Service.** Offer transit services with sufficient frequency and route connections to provide a quick, reliable, and flexible travel alternative, especially between and within activity centers.
2. **Respond to Urban Travel Needs.** Focus transit services into existing and planned urban activity centers and ensure that these areas have frequent and convenient service.

3. **Use All Available Resources.** Use all available resources to increase service in urban and suburban areas lacking adequate service.

### Transit Service Actions

- Utilize all available taxing authority and lobby for additional revenue sources.
- Consider fare changes, including free fare zones in activity centers and easy transfers to neighboring transit systems, to make taking the bus simple and convenient.
- Actively promote transit services to the community.
- Offer to help fund transportation improvement projects in local communities which will help improve transit service.

**R**Real alternatives to driving require complete information, competitive service, and safe, convenient access.

## Goals and Policies - Conclusion

*With effective public transportation, urban places can continue to grow without being overwhelmed by traffic. Conversely, suburban communities can steer urban growth away from farmlands, forests, and open space by investing transportation resources in areas better suited to development.*

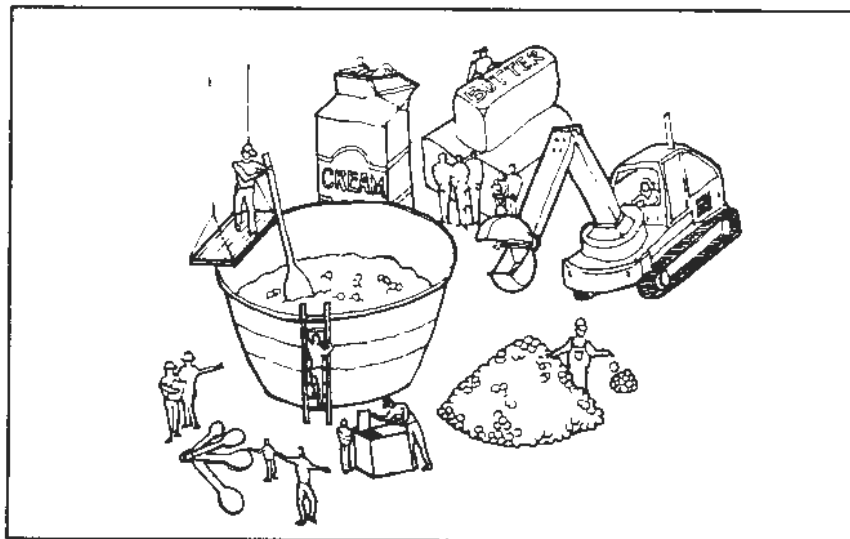

*If we all cooperate together.....*

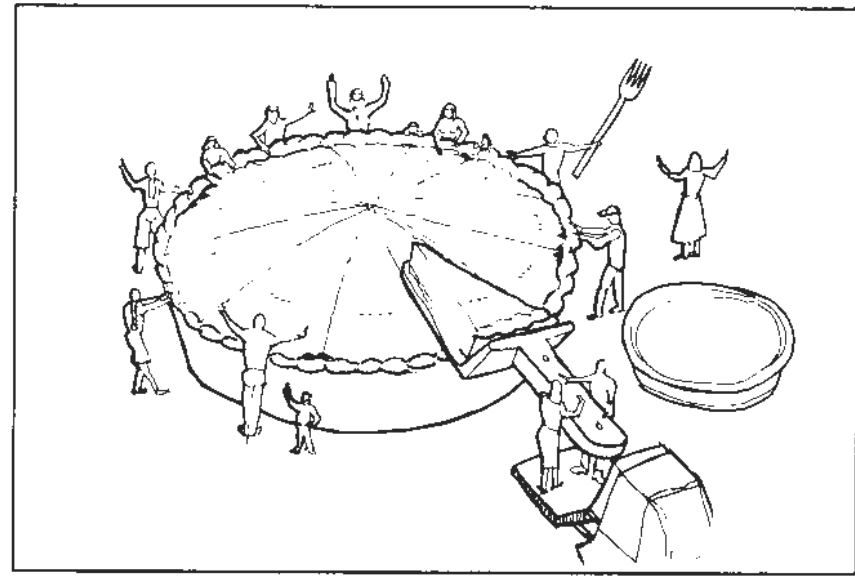

*We can all share in the benefits of growth management.*

### **Conclusion - Putting It All Together**

Local officials can use transportation services and facilities to help shape land use, manage growth, and achieve community goals. With effective public transportation, urban places can continue to grow without being overwhelmed by automobile traffic. Conversely, suburban communities can steer urban growth away from farmlands, forests, and open space by investing transportation resources in areas better suited to development. But for public transportation to have an impact on community development, cities, counties, and transit companies need to work together, under coordinated goals and policies, to match land use and transportation systems.

# **Appendix**

---

***Appendix A: Public Transportation Terms***

***Appendix B: Sources***





## ***Appendix A: Land Use and Public Transportation Terms***

---

**Access Aisle** A 5- to 8-foot wide space between parking stalls that permits a person to transfer from a vehicle to a wheelchair and travel to the sidewalk or building entrance.

**Accessible** Approachable and usable by people with disabilities.

**Accessible Exit/Entrance** An exit/entrance which does not contain stairs, steps, or escalators.

**Accessible Route of Travel** A continuous, unobstructed path connecting all accessible building entrances or public spaces that can be negotiated by a person using a wheelchair and that is usable by people with other disabilities.

**Americans With Disabilities Act (ADA)** The 1990 federal law mandating barrier-free access for people with disabilities to transportation and other services. [See Chapter 6, this volume.]

**Barrier-Free** Services and facilities without obstacles that would preclude use by people with disabilities.

**Cane-Detectable** Safety barriers that can be felt by people with vision impairments using canes. The standard is 27 inches above the ground. [See Chapter 6, this volume.]

**Car/Vanpool** A group of people who share the use and costs of a van or car for transportation to and from a destination on a regular basis.

**Charette** An intensive workshop in which designers, planners, citizens, public officials and other interests evaluate a variety of approaches to a specific planning problem or design issue. [See Chapter 1, this volume.]

**Commute Trip Reduction Act** A 1991 Washington State law that mandates employers reduce single-occupant vehicle commuting by developing plans to shift employee trips to transit, carpools, and non-motorized modes.

**Commuter Rail** A rail service, usually using existing tracks, connecting the outlying suburbs with a central business district. Service is generally limited to longer distances (15 or more miles) and peak period, home-based work trips.

**Commuter Service** Generally peak-period bus or rail transportation provided on a regularly scheduled basis for work and school trips.

**Comprehensive Plan** A city or county's plan for land use, housing, transportation, capital facilities, open space and other issues affecting the physical development of a community.

**County Transportation Authorities** In Washington, County Transportation Authorities are authorized by state law (Ch. 36.57 RCW). CTAs serve Snohomish and Grays Harbor counties. SNO-TRAN is a CTA.

**Curb Ramp/Curb Cut** A short ramp between the street and the sidewalk allowing wheelchairs and other wheeled devices to move from sidewalk to street.

## **Appendix A: Land Use and Public Transportation Terms**

---

**Demand Management** Programs to reduce auto trips through the management and pricing of single occupant auto parking, access, and congestion and provision of alternative forms of transportation.

**Demand-Responsive Service** Transportation service designed to carry passengers from their origins to specific destinations (often door-to-door) by immediate request or by prior reservation.

**Density Bonuses** Provisions in development regulations that exchange greater floor space or more housing per acre for certain public amenities.

**Detectable Warning** A texture or other surface feature usually applied to walking surfaces to warn visually impaired persons of hazards.

**Development Agreements** A covenant or contract between the local government and a developer or property owner that requires specific design elements or public benefits in exchange for development permits.

**Development Impact Fees** Fees collected from developers which are used for public improvements and services needed to accommodate new development.

**Eminent Domain** The right of a government to "take" private lands at their fair market value..

**Express Service** Transit service designed to make a limited number of stops along a route and generally provided during peak hours by express buses or trains operating at higher speeds than conventional service.

**Federal Transit Administration (FTA)** The division of the U.S. Department of Transportation responsible for funding and regulating public transportation. FTA administers the Intermodal Surface Transportation Efficiency Act (ISTEA) (see ISTEA).

**Feeder Service** Bus or van service providing connections generally to main bus or rail transit stations.

**Fixed-Route Service** Bus service operated over a set route on a regular schedule.

**Floor Area Ratio (FAR)** A measure of development density expressed as the amount of building floor area divided by the size of the development site.

**Growth Management Act (GMA)** A 1990 Washington State law that mandates managing population growth through comprehensive plans, regionally coordinated plan implementation, and creation of urban growth areas. [See Chapter 8 in this volume].

**Headway** The frequency of transit service along a given route.

**High Capacity Transit (HCT)** Transit services designed to carry more people at faster speeds than conventional transit. Express bus, passenger ferries, and rail transit are HCT modes.

## Appendix A: Land Use and Public Transportation Terms

---

**High Occupancy Vehicle (HOV)** A bus, car, or van carrying a minimum number of people (usually 2 to 4) which allows the vehicle to use special HOV lanes and priority parking. Ferries are also considered HOVs.

**Integrated Transportation System** A concept to expand mobility and provide transportation choices by integrating transportation facilities and services appropriate to the land uses in an area; e.g., putting HOV lanes on transit-accessible roads serving high density developments.

**Interlocal Agreements** Contracts between governments in Washington, governed by the Washington Interlocal Cooperation Act (Ch. 39.34 RCW).

**Intermodal Surface Transportation Efficiency Act (ISTEA) 1990** federal legislation combining all major transportation funding sources into a single program including transit funding. ISTEA is managed by the FTA through MPOs (in the Puget Sound region, the Puget Sound Regional Council).

**International Symbol of Access** The stylized drawing of a person in a wheelchair identifying a barrier-free route of travel or facilities accessible to people with disabilities.

**Joint Development** Projects financed and developed jointly by public agencies and private developers.

**Land Use** The type of buildings and/or activities that occupy a given piece of land. Usually classified as residential, commercial, industrial, public, or open space.

**Latte** An alternative fuel of the Pacific Northwest. Available in decaf or regular.

**Level of Service (LOS)** A measure of how well a public service or facility is meeting the demands placed upon it. LOS is used to assess how population growth is impacting traffic, parks, and other public services. **Traffic LOS** Operational conditions within a traffic stream measured in speed and travel time, freedom to maneuver, traffic interruptions, comfort and convenience, and safety. Level A denotes the best traffic conditions while Level F indicates gridlock.

**Light Rail Transit (LRT)** A rail system that can operate on a variety of rights-of-way, ranging from on-street to grade-separated.

**Local Bus Service** Community-based transit services provided to the residents of a defined area.

**Local Improvement District (LID)** A special district in which a tax is assessed to pay for a specific public improvement (such as a new road).

**Local Transportation Act (LTA)** This 1987 Washington State law established tools to collect and distribute development impact fees and public funds to pay for road improvements.

**Mass Transit** The general term used to identify bus, rail, or other types of transportation service which move large numbers of people at one time.

## **Appendix A: Land Use and Public Transportation Terms**

---

**Metropolitan Planning Organization (MPO)** A federally recognized agency that maintains a regional plan. The Washington State GMA requires that where an MPO exists, it must also be the RTPO. The Puget Sound Regional Council is both MPO and RTPO for this region.

**Mini Bus** Buses smaller than the 40-foot standard with varying seating capacities.

**Mitigation Assessments** Fees paid by developers for the impacts of their projects on the community.

**Mixed Use** Complementary land uses within walking distance of one another and connected by safe, direct walkways.

**Modal Split** The proportion of total person trips on various modes.

**Mode** The types of transportation available for use such as rail, bus, vanpool, single-occupant auto, or bicycle.

**Multi-Modal** Transportation facilities designed for joint use and connections between different modes.

**NIMBY** The acronym for “Not In My Backyard,” a reference to neighborhood groups opposed to new development.

**Non-Motorized Modes** Any method of travel provided by a non-motorized mode such as walking and cycling.

**Paratransit** Flexible transit services using vans or mini-buses to serve special groups or areas.

**Park-and-Ride Lot** A parking lot where commuters can park and catch a bus, carpool, or train.

**Parking Management** Actions taken to alter the supply, operation, and/or parking demand in an area.

**Parking Pockets** Small parking lots at the sides or backs of buildings, generally with fewer than 25 spaces.

**Peak Periods** The hours when traffic is greatest. Generally, there is a morning peak (6:30-9:00 a.m.) and an afternoon peak period (3:30-6:30 p.m.) during the work week.

**Pedestrian Friendly** Designed to accommodate pedestrians’ (and sometimes cyclists’) priorities of safety, minimized walking distance, comfort and interesting surroundings.

**Pedestrian Scaled** Land uses characterized by narrow streets, small blocks, and an absence of large parking lots and arranged so that walking distances are short.

**People With Disabilities** People who have physical or mental impairments which limit their access to and use of a facility or service.

**Plat** A subdivision of one piece of land into two or more pieces that can be individually sold or leased.

**Preferential Parking** Parking spaces reserved exclusively for car/vanpools in parking lots. These parking spaces are generally located closer to building entrances or have other positive features which make them very desirable. Such parking spaces are used as incentives to encourage ridesharing.



## **Appendix A: Land Use and Public Transportation Terms**

---

**Preferential Signals** Traffic signals designed to give an advantage to HOVs.

**Primary Corridors** The major travel routes identified for additional development to increase the people-carrying capacity (as opposed to vehicle-carrying) of those corridors.

**Primary Entry** The principal entrance through which most people enter the building. A building may have more than one primary entry.

**Public Development Authority** In Washington State, various types of public agencies with authority and financial resources to organize and carryout large-scale development programs. (Ch. 35.21 RCW).

**Public Transportation** A system of passenger transportation services which may include buses, ferries, rideshare, paratransit, and rail transit.

**Public Transportation Benefit Authority (PTBA)** Public Transportation Benefit Authorities are authorized by Ch. 36.57A RCW to provide public transportation to areas which vote to create them. Community Transit is a PTBA.

**Rail-Compatible** Facilities designed for buses or other uses that are, or can be made, compatible with rail facilities; e.g., park-and-ride lots.

**Rail-Convertible** Facilities designed for buses or other uses that can be converted to rail facilities at a later time; e.g., the Seattle bus tunnel can be converted to rail.

**Ramp** As defined by ADA, any walking surface having a running slope exceeding 1 inch vertical in 20 inches horizontal.

**Rapid Transit** Any form of all-day, high capacity transit service usually provided by some form of rail.

**Regional Mall** A very large shopping center with over 400,000 square feet of floor space that includes at least two anchor stores. Usually located near a major freeway interchange and surrounded by parking.

**Regional Transit Authority (RTA)** In the Puget Sound region, the 18-member board responsible for planning, building and operating the Regional Transit System for King, Pierce and Snohomish counties.

**Regional Transit System** The rail and bus transit system proposed for King, Pierce, and Snohomish counties. This system would be built over the next 30 years, following approval by the region's voters.

**Regional Transportation Planning Organization (RTPO)** Voluntary associations of local governments within a county or contiguous counties responsible, under the GMA, for certifying transportation elements of local comprehensive plans; developing and adopting a regional plan; and regional plan coordination. The RTPO for Snohomish, King, Pierce and Kitsap counties is the Puget Sound Regional Council.

**Reverse Commute** Travel during the peak period that flows in the direction opposite the peak direction.

## Appendix A: Land Use and Public Transportation Terms

---

**Ridership** The number of people using a transportation system in a given period of time.

**Ridesharing Programs** Programs sponsored by public agencies or the private sector to promote the use of carpools, vanpools, or buspools.

**Right-of-Way** Land used (or reserved for future use) for transportation purposes.

**Route** A fixed path of travel followed by a bus or other mode.

**Section 9** The major federal funding source within the ISTEA for public transportation.

**Service Area** A geographic area where transit service is provided.

**Setback** The distance from the property line to a building.

**Setback, Front** The distance from a property boundary, along a street front, to a building.

**Shopping Center** Several stores, each sharing a side wall with another, with at least one major store that acts as an anchor. Parking is usually located between the building and the street.

**Single-Occupant Vehicle (SOV)** Vehicles carrying one occupant, usually a private auto. (See HOV.)

**Site** A defined piece of land designated for a specific use.

**Site Plan** A developer-designed plan showing where on a specific parcel buildings, roads, utilities, etc., will be located.

**Special Transportation** Publicly or privately provided transportation services to elderly people and people with disabilities or other "special" populations.

**Specific Plan** A detailed master plan for development or redevelopment of multiple parcels of land. [See Chapter 1 of this volume.]

**Station Area** An area surrounding a rapid transit station containing transit-related activities and designed to accommodate large numbers of people using the rapid transit service. Station areas are generally defined as the area within a 1/4 mile radius of the station.

**Strip Mall** Any single-story, auto-oriented shopping center located along a major arterial road. Strip malls are characterized by large amounts of parking in front of the buildings.

**Sub-Area Plan** A detailed plan for a specific part of a community that builds on the comprehensive plan. See also "Specific Plan."

**Tax Increment Financing** A technique allowing new tax revenues, generated by new development, to be retained and put to public use in and around the area where the development has taken place. [See Chapter 1, Appendix A of this volume.]

**Timed Transfer** A set of bus routes and schedules coordinated so that transfers between all lines, destined for a particular transit center, are synchronized to facilitate transfers.

## ***Appendix A: Land Use and Public Transportation Terms***

---

**Transfer of Development Rights** A program in which the owner of environmentally sensitive land can sell the land's development potential to an owner of land where higher density development is desirable.

**Transit** A general term applied to passenger rail and bus service available for use by the public and generally operated on fixed-routes with fixed-schedules although flexible routing and scheduling (see Demand Responsive and Paratransit) services may also be included.

**Transit Center** A facility providing connections between buses serving different routes or between different transportation modes such as between ferries and buses.

**Transit-Compatible/Supportive Land Use** Areas with adequate development density, mix of uses, and design to allow pedestrian travel, transit access and efficient transit service.

**Transit Corridor** A major right-of-way that carries high volumes of transit and other HOV vehicles.

**Transit Dependent** People who rely on public transit.

**Transportation Benefit Districts (TBDs)** Development districts in which taxes can be assessed to finance transportation improvements benefiting an area larger than one jurisdiction.

**Transportation Demand Management (TDM)** Programs to reduce reliance on single-occupant vehicles through transit use, ridesharing, parking management, and employer-offered incentives.

**Transportation System Management (TSM)** Programs of relatively inexpensive actions to increase the efficiency of the existing transportation system; usually a combination of physical improvements and TDM.

**Urban Centers** Downtowns, town centers and higher density neighborhoods designed and scaled for walking and for high levels of public transportation service.

**Urban Growth Areas** In Washington State, counties covered by the Growth Management Act must designate urban growth areas within urban growth boundaries. Each city in the county must be in an urban growth area which must accommodate urban growth projected for the next 20 years.

**Vision 2020** The Central Puget Sound region's plan for 2020 designed to foster development of urban centers to meet Washington State growth management requirements. The Puget Sound Regional Council manages Vision 2020 planning.

**Visioning** A process that allows people to create a picture (vision) of what they would like a place to look like at a set point in the future. [See Chapter 1 of this volume.]

**WSDOT** The Washington State Department of Transportation, responsible for planning, building, and maintaining the state highways, the freeway HOV network and ferry system.



## Appendix B: Sources

---

- Each chapter in this volume was based in part on material found in the first volume of SNO-TRAN's Guide to Land Use and Public Transportation (1989). The reader is encouraged to review the first volume for basic information on transit operations, land use linkages, and transit-supportive planning.

### **Chapter 1: Developing an Urban Center**

#### ■ **Urban Design and Its History**

- Abbett, Robert M. et al. "Mixed-use Developments: New Ways of Land Use." Technical Bulletin 71. The Urban Land Institute, Washington, D.C., (1976).
- Carlson, Dan and Van Nostrand, Maren. In-City Planned Development: Case Studies of Selected North American Cities. A Report to the Committee for the Seattle Commons. Institute for Public Policy and Management, Graduate School of Public Affairs and the Growth Management Planning and Research Clearinghouse, College of Architecture and Urban Planning, University of Washington, (December 1992).
- Calthorpe, Peter. The New American Metropolis: Ecology and the American Dream. Princeton Architectural Press, New York, (1993).
- Duany, Andres and Plater-Zyberk, Elizabeth. Town and Town-Making Principles. Rizzoli, New York, (1991).
- Jacobs, Jane. The Death and Life of Great American Cities. Vintage Books, New York (1961).
- Kelbaugh, Doug, ed. The Pedestrian Pocket Book: A New Suburban Design Strategy. Princeton Architectural Press, (1989).

Spreiregen, Paul D. Urban Design: The Architecture of Towns and Cities. McGraw-Hill Book Co., New York, (1965).

#### ■ **State of Suburbia**

- Garreau, Joel. Edge City: Life on the New Frontier. Anchor Books Doubleday, New York, (1991).
- Kunstler, James H. The Geography of Nowhere: The Rise and Decline of America's Man-Made Landscape. Simon & Schuster, New York, (1993).
- Peirce, Neal. "The Peirce Report." A Seattle Times Special, reprinted from October 1-8, 1989.

#### ■ **Visioning**

City of Lynnwood Collaborative Planning Demonstration Project. Lynnwood Legacy: Making the Vision a Reality. Lynnwood, Washington, (June 1993).

#### ■ **Specific Plans**

- Dahlin, Doug. "The Evergreen Specific Plan: Proactive Public Planning." Urban Land, (March 1992).
- Ferguson, John M and Rivasplata, Antero. Specific Plans in the Golden State. Governor's Office of Planning and Research, Sacramento, California, (August 1988, Rev. March 1989).

## Appendix B: Sources

---

Musbach, James R. "Financing Multiple-Owner Master Plans." Urban Land, (July 1993).

### ■ *Joint Development*

Bernick, Michael. "The Bay Area's Emerging Transit-Based Housing." Urban Land, (July 1993).

Friedan, Bernard and Sagalyn, Lynn B. Downtown, Inc.: How America Rebuilds Cities. The MIT Press, Cambridge, Massachusetts, (1992).

Gilson, James R and Francis, F. Michael. "Planning for Joint Development in Los Angeles." Urban Land, (June 1993).

Miller, M. Richard. "Joint Development at Ballston Metro Center." Urban Land, (June 1992).

Washington Metropolitan Area Transit Authority. Joint Development Policies and Procedures Manual. WMATA Office of Planning, Washington, D.C., (1988).

### ■ *Retail Economics*

Schwanke, Dean. "Navigating the Value Retail Marketplace." Urban Land, (May 1993).

### **Chapter 2: Transit Compatible Site Plans**

SNO-TRAN's Public Transportation Plan Technical Advisory Committee used actual site plans and guidelines, set out in the first volume of SNO-TRAN's Guide to Land Use and Public Transportation (1989), as the basis for this chapter.

### **Chapter 3: Transit Friendly Shopping Centers**

SNO-TRAN's Public Transportation Plan Technical Advisory Committee used actual site plans and guidelines, set out in

the first volume of SNO-TRAN's Guide to Land Use and Public Transportation (1989), as the basis for this chapter.

### **Chapter 4: Redesign of a Strip-Commercial Area**

A subcommittee of SNO-TRAN's Public Transportation Plan Technical Advisory Committee based this chapter on field work and guidelines set out in the first volume of SNO-TRAN's Guide to Land Use and Public Transportation (1989).

### **Chapter 5: Mixed Use**

Alexander, Christopher. A Pattern Language. Oxford University Press, New York, (1977).

Calthorpe, Peter. The Next American Metropolis: Ecology, Community and the American Dream. Princeton Architectural Press, New York, (1993).

Citizens Advocating Responsible Transportation (CART). Traffic Calming: The Solution to Urban Traffic and a New Vision for Neighborhood Livability. Ashgrove, Queensland 4060, Australia; or in USA and Canada: Sensible Transportation Options for People (STOP), Tigard, Oregon 97224-2600, (1993).

City of Olympia, Municipal Code. Ordinance 5427, Residential Mixed Use Zone, Pedestrian Street Overlay District. Olympia, Washington, (December 1993).

City of Snohomish. Zoning Regulations. Snohomish, Washington, (1993).

Jacobs, Allan B. Great Streets. MIT Press, Cambridge, Massachusetts, (1993).

## Appendix B: Sources

---

- Loder and Bayly Consulting Group. "Greenhouse Neighbourhood Project - The Low Energy Suburb - Summary Report." prepared for the Government of Victoria, Australia, Department of Planning and Development, (July 1993).
- National Association of Industrial and Office Parks. How to Develop Successful Mixed-Use Business Parks. Arlington, Virginia., (1988).
- Staten, Peter. "Valley Revival" in Seattle Weekly, (April 8, 1992).
- The Urban Land Institute. Mixed-Use Development Handbook. Urban Land Institute, Washington D.C., (1987).
- The Urban Land Institute. Mixed-Use Development - Selected References. ULI InfoPacket No. 381, ULI Development Information Service, Washingtons, D.C., (October 1992).
- The Urban Land Institute, Project Reference File: Vol. 18, No.11 Princeton Forrestal Village, Plainsboro, New Jersey; Vol. 22, No. 8, Mizner Park, Boca Raton, Florida; Vol 21, No 11, Reston Town Center, Reston, Virginia; Vol. 18, No. 3, Riverplace, Portland Oregon.
- Thomas & Potter. "Mixed Use Development Standard Study." Prepared for the Seattle Department of Construction and Land Use, Seattle, Washington, (December 1993).
- Wentling, James W. and Lloyd W. Bookout, Editors. Density by Design. The Urban Land Institute, Washington, D.C., (1988).
- Woods, David W., AICP, Unpublished Technical Reports relating to Transportation/Land Use Linkages. City of Lynnwood, Washington, (1993).
- ### Interviews
- Rick Barr, CB Commercial, Bellevue, Washington. Financing mixed use, (November 1993).
- Mary Lou Block, Asstistant Planning Director, City of Everett, Washington. Edmonds Town Center, (September 1993).
- Mark Cappeloto, CB Commercial (Lending Arm), Seattle, Washington. Financing mixed use, (November 18,1993).
- Herb Carpenter, Senior Planner, Reid Middleton Engineering, Lynnwood, Washington. Mixed use, (October 1993).
- Rob Chave, Planning Manager, City of Edmonds, Washington. Edmonds Town Center, (September 1993).
- Susan Duren, Director, Washington Community Reinvestment Assoc. (WCRA), Seattle. Financing mixed use, (January 1994)
- Dave Earling, Edmonds Realty, Edmonds, Washington. Financing mixed use, (November 1993).
- Lindsey Echelbarger, Developer, Bothell, Washington. Canyon Park , (November 1993).
- Pete Friedman, Senior Planner, City of Mill Creek, Washington. Mill Creek Library Park, (December 1993).
- Wendell Johnson, Project Manager, Reid Middleton Engineering, Lynnwood, Washington. Mixed use, (October 1993).

## Appendix B: Sources

---

Jim Linsey, First Western Development, Edmonds, Washington. Project Financing, (January 1994).

Bruce Lorig, Lorig Associates, Inc., Seattle, Washington. Wallingford Center, (January 1994).

David Mandley, President, Lojjs Corporation, Everett, Washington. Colby Crest Apartments, (January 1994).

Pam Newton, Senior Planner, City of Everett, Washington. Colby Crest Apartments, (January 1994).

Art Skotdal, Developer, Everett. Financing mixed use, (December 1993).

David Sucher, Developer, Keystone Development, Seattle. Honey Bear complex, (January 1994).

Karen Wiggins, Vice Pres., Jack Wiggins Construction Co., Edmonds. Harbor View, Financing mixed use, (January 1994).

Carolyn Wolf, General Manager, Broadway Market, Seattle. Broadway Market (October 1993).

### **Chapter 6: Barrier-Free Pedestrian Access**

Adaptive Environments Center Inc. "The American with Disabilities Act, Checklist for Readily Achievable Barrier Removal." for the U.S. Department of Justice, Washington, D.C., (March 31,1992).

Allen, Barbara and Frank Moffett. Accessibility Design for All: An Illustrated Handbook, 1992 Washington State Regulations. American Institute of Architects, Washington Council, Olympia, Washington, (September 1992).

American Public Transit Association, Easter Seals and the Urban Mass Transportation Administration. Transportation Implications of the Americans with Disabilities Act: An Implementation Manual, (No date).

KRW Incorporated. ADA Transportation Accessibility, 2387 S. Dove Street, Alexandria VA, 22314, (No date).

King, Larry. "Americans with Disabilities Act and the Design of Highway-Related Facilities," in ITE Journal, pp. 20-25. (January 1993).

Moffett, Frank C. and Kermit C. Robinson. Housing and Building Accessibility: The Law in Washington - 1992 -- A Companion, U.W. Department of Housing and Urban Development, Region X, Seattle, Washington, (1993?).

U.S. Architectural and Transportation Barriers Compliance Board. "Americans with Disabilities Act Fact Sheet." Washington, D.C. (November 1990).

U.S. Department of Housing and Urban Development, Office of Policy Development and Research. Barrier Free Site Design. Washington, D.C. (No date).

U.S. Department of Justice, Civil Rights Division. The Americans With Disabilities Act: Title II Technical Assistance Manual, (1992) with Supplements. Washington, D.C. (January 1993).

U.S. Department of Justice. "Non-Discrimination on the Basis of Disability by Public Accommodations and in Commercial Facilities: Final Rule." Federal Register, Volume 56, No. 144, (July 26,1991). [See also



## Appendix B: Sources

---

- "Nondiscrimination on the Basis of Disability in State and Local Government Services" in same volume.]
- U.S. Department of Transportation, "Transportation for Individuals with Disabilities; Final Rule," Federal Register, Part IV. (Friday, September 6, 1991). [NOTE: *These are the ADA regulations for transportation.*]
- U.S. Department of Transportation. Federal Transit Administration, Accessibility Handbook for Transit Facilities. Washington, D.C. (July, 1992).
- U.S. House of Representatives. Americans With Disabilities Act of 1990. Superintendent of Documents, U.S. Government Printing Office, Washington, D.C. (June 26, 1990).
- University of Washington Law School Foundation. Advising Clients on the Steps Necessary to Comply with the American with Disabilities Act. Seattle, (April 13, 1991).
- Washington State Building Code Council. Washington State Building Code: Chapters 51-20 and 51-21 WAC. Department of Community Development, Olympia Washington, (July 1992).
- Chapter 7: Ideas for Small Communities**
- AASHTO Task Force on Geometric Design. Guide for the Development of Bicycle Facilities. American Association of State Highway and Transportation Officials. Washington, D.C. (August 1991).
- Calthorpe Associates. City of San Diego Land Use Guidance System: Transit-Oriented Development Design Guidelines. Prepared for the City of San Diego, California, (1992).
- Calthorpe, Peter. The Next American Metropolis: Ecology, Community and the American Dream. Princeton Architectural Press, New York, (1993).
- Daniels, Thomas L., et. al. The Small Town Planning Handbook. American Planning Association: Planners Press. Chicago, Illinois, (1988).
- Kelbaugh, Doug, Editor. The Pedestrian Pocket Book: A New Suburban Design Strategy. Princeton Architectural Press, New York, (1989).
- Lerner-Lam, Eva, et. al. "Neo-Traditional Neighborhood Design and Its Implications for Traffic Engineering" in ITE Journal, pp. 17-25, (January 1992).
- MAKERS Architecture and Urban Design. Residential Development Handbook for Snohomish County Communities. Prepared for Snohomish County Tomorrow. Everett, Washington, (March 1992).
- Pivo, Gary, et. al. "Rural Cluster Zoning: Survey and Guidelines" in Land Use Law; pp. 3 - 10, (September 1990).
- Puget Sound Regional Council and the Regional Transit Project. Resource Notebook for the Transit/Land Use Linkages: Making it Work Workshop. Seattle, (July 1993).
- San Diego Metropolitan Transit Development Board. Designing for Transit: A Manual for Integrating Public Transportation and Land Development in the San Diego Metropolitan Area, (July 1993).

## ***Appendix B: Sources***

---

Snohomish County Transportation Authority. "Public Transportation and Planning: Ideas for Cities and Counties." Unpublished paper. Lynnwood, Washington, (July 1991).

Stokes, Samuel N. & A. Elizabeth Watson. Saving America's Countryside: A Guide to Rural Conservation. Johns Hopkins University Press, Baltimore, Maryland.

Whyte, William H. The Last Landscape. Doubleday & Company, Inc., Garden City, New York, (1968).

### **Interview**

John W. Burkholder, Director, Business Development, Barrett Consulting Group, Bellevue, Washington, (December 1993).

### ***Chapter 8: Policies for Effective Public Transportation***

[This chapter builds on Chapter 4 of the first volume of SNO-TRAN's Guide to Land Use and Public Transportation (1989).]

Puget Sound Council of Governments/Puget Sound Regional Council. Vision 2020: Growth and Transportation Strategy for the Central Puget Sound Region. Seattle, Washington, (October 1990).

Puget Sound Regional Council. "Vision 2020: Multicounty Planning Policies for King, Kitsap, Pierce and Snohomish Counties," Seattle, Washington, (March 1993).

Washington Growth Management Acts of 1990 of 1991. (Chapter 17, Laws of 1990, First Extraordinary Session) and (Laws of 1991, First Extraordinary Session). Olympia, Washington, (1990 and 1991).

Washington State Department of Transportation. Land use and Transportation Linkages: Communities Planning for the Future: Growth Management & Transportation in Washington State. Materials for Workshop I. Olympia, Washington, (1992?).