

# **Implementation Report of the USDOT Grade Crossing Safety Task Force**

**Report to Secretary  
Rodney E. Slater**

**June 1, 1997**



**U.S. Department of Transportation**



# Executive Summary

On March 1, 1996, the U.S. Department of Transportation (USDOT) Grade Crossing Safety Task Force delivered a report entitled *Accidents That Shouldn't Happen* to Transportation Secretary Federico Peña. Secretary Peña had directed that the Task Force be convened to address factors that might have contributed to a fatal collision involving a commuter train and a school bus in Fox River Grove, Illinois, in October 1995.

In its report, the Task Force addressed safety problems that were not specifically covered in the Department's 1994 *Rail-Highway Crossing Safety Action Plan*: Interconnected Signals; Vehicle Storage Space; High-Profile Crossings; Light-Rail Transit Crossings; and Special Vehicle Operations. The report made 24 recommendations to remedy physical and procedural deficiencies in grade crossing construction, operation, maintenance, funding, enforcement, coordination, information, standards, and education.

The principal finding of the Task Force report was that "improved highway-rail grade crossing safety depends upon better cooperation, communication, and education among responsible parties if accidents and fatalities are to be reduced significantly." With this in mind, the report proposed a status update: "The Task Force will reconvene one year after issuance of this report to evaluate progress in implementation of its recommendations."

The Task Force fulfilled this recommendation on March 1, 1997, by delivering an interim report on the Department's progress to the Associate Deputy Secretary and Director of the Office of Intermodalism, Michael P. Huerta. The contents of this interim report have been incorporated as the first chapter of this document to give the reader a comprehensive overview of Departmental actions in implementing Task Force recommendations.

The Task Force report proposed that "The FHWA will meet with the FRA to develop the process for implementing the FHWA long-term recommendation to convene a technical working group to evaluate current standards and guidelines for a variety of grade crossing technical issues. Selection of working group members and development of an implementation schedule should be accomplished by June 1, 1996, with the group's product targeted for completion by June 1, 1997."

Among the noteworthy accomplishments of the USDOT Task Force are the convening of a Technical Working Group (TWG) that has made 35 recommendations for standards, guidelines and other grade crossing safety issues; the identification of focal points to coordinate railroad safety issues in each State; the initiation of regional State/railroad conferences; and the creation of an advance warning sign for motorists approaching high-profile crossings. All of the Task Force activities and accomplishments including the above are detailed in Chapter 1.

Chapter 2 focuses on the accomplishments of the TWG. Among the noteworthy accomplishments of the TWG are development of uniform terms for railroad and traffic engineers; development of an interconnected warning placard for controller cabinets; and recommendations in the areas of interconnected signals, vehicle storage, joint inspections, and high-profile crossings.

This report to Transportation Secretary Rodney E. Slater summarizes the technical working group's findings on improved standards and guidelines for railroad-highway grade crossing safety. In making this report, the Task Force reaffirms the Secretary's commitment to make transportation safety the Department's highest priority.

The Department intends to distribute this report to all who participated in the TWG. By distributing this report, the Department urges those agencies, organizations, and other professional societies that participated in its compilation to take steps to formally endorse this report and implement its recommendations. The Department further recommends that the report's terminology for railroad-highway grade crossings be adopted and used as soon as possible in correspondence, training initiatives, and in new or revised railroad-highway grade crossing publications.



# Table of Contents

	<i>Page</i>
<b>Executive Summary</b> . . . . .	iii
<b>Chapter 1—Grade Crossing Safety Task Force</b>	
I. Introduction . . . . .	1
II. Interconnected Signals and Storage . . . . .	1
A. Short-Term Recommendations . . . . .	1
B. Long-Term Recommendation . . . . .	3
III. High-Profile Crossings . . . . .	4
A. Short-Term Recommendations . . . . .	4
B. Long-Term Recommendations . . . . .	5
IV. Light-Rail Crossing Issues . . . . .	6
A. Short-Term Recommendations . . . . .	6
B. Long-Term Recommendations . . . . .	7
V. Special Vehicle Operations and Information . . . . .	7
A. Short-Term Recommendations . . . . .	7
B. Long-Term Recommendations . . . . .	8
<b>Chapter 2—Technical Working Group Findings and Recommendations</b>	
I. Introduction . . . . .	11
II. Terminology . . . . .	11
III. Interconnected Signals and Vehicle Storage . . . . .	12
A. Signals . . . . .	12
Twenty-Second Minimum Warning Time . . . . .	12
Interconnected Signals . . . . .	13
Types of Preemption . . . . .	13
Pre-Signals . . . . .	14
B. Vehicle Storage Distance . . . . .	14
Design Vehicle . . . . .	14
Storage Distance Signing . . . . .	15
Storage Distance Pavement Markings . . . . .	15
C. Other Pavement Markings . . . . .	15
D. Reducing Gate Running . . . . .	15
IV. High-Profile Crossings . . . . .	15
A. Crossing Identification Sign . . . . .	15
B. Identifying and Treating High-Profile Crossings . . . . .	16
V. Joint Inspections . . . . .	16
A. Periodic Joint Inspections . . . . .	16
B. Other Joint Coordination . . . . .	17
VI. Additional Topics Discussed by the TWG . . . . .	17

24611

HE  
1618  
.A2  
U53  
1997

DEC 01 1998

# Table of Contents

## APPENDIX

- A May 28, 1996, FHWA Memorandum to Field Offices
- B Railroad-Highway Grade Crossing State Focal Points
- C FRA Letter to Governors
- D Joint Inspection Form
- E Interconnect Warning Placard
- F Annotated Bibliography
- G Advance Warning Sign for High-Profile Crossings
- H Survey Form on Best Practices
- I DRAFT Recommendations for Barrier Medians for TCRP Project A-13,  
Light-Rail Service Pedestrian and Vehicular Safety
- J Special Vehicle Permit Pamphlet
- K List of TWG Participating Agencies and Organizations
- L List of TWG Recommendations
- M Pre-Signal Diagram
- N Advance and Simultaneous Preemption Timeline
- O Sample Cross-Hatch Pavement Markings
- P Sheriff's Dept. Railroad-Highway Grade Crossing Violation Brochure

# Chapter 1

## Grade Crossing Safety Task Force

### I. INTRODUCTION

Chapter 1 presents a status report on each of the recommendations made in the March 1996 USDOT publication, *Accidents That Shouldn't Happen*. The recommendations are divided into the four problem areas identified in the 1996 report. Activities of Departmental agencies participating on the Grade Crossing Safety Task Force and other parties that are working on the recommendations are briefly described. Continuing efforts and activities in the planning stages are also presented.

Shortly after the tragic collision of a commuter train with a school bus in Fox River Grove, Illinois, that resulted in seven deaths on October 25, 1995, then Secretary of Transportation Federico Peña asked Michael Huerta, the Associate Deputy Secretary and Director of the Office of Intermodalism, to head up a task force to look into grade crossing safety. The purpose of the task force was to review the decision making process for designing, constructing, maintaining, and operating railroad-highway grade crossings. The task force was to build upon the Department's 1994 Rail-Highway Crossing Safety Action Plan.

The USDOT Grade Crossing Safety Task Force was made up of representatives from four modal administrations within the Department—the Federal Highway Administration (FHWA), the Federal Railroad Administration (FRA), the Federal Transit Administration (FTA), and the National Highway Traffic Safety Administration (NHTSA)—and staff from the Office of Intermodalism.

In preparing its 1996 report to Secretary Peña, the Task Force utilized information from knowledgeable persons from the public and private sectors with expertise in the areas that the Task Force was to address. In addition, the National Transportation Safety Board (NTSB), which investigated the Fox River Grove collision, provided a resource person to work with the Task Force.

The Task Force report delivered to Secretary Peña on March 1, 1996, contained its evaluation of the decision-making process related to the Nation's grade crossings, as well as recommendations for improvement. The Task Force report, entitled *Accidents That Shouldn't Happen*, identified 24 long- and short-term recommendations divided into the following four specific problem areas:

- Interconnected Signals and Storage

- High-Profile Crossings
- Light-Rail Crossing Issues
- Special Vehicle Operations and Information

### II. INTERCONNECTED SIGNALS AND STORAGE

The Secretary's Grade Crossing Safety Task Force made four short-term recommendations and one long-term recommendation on interconnected signals and storage.

#### A. Short-Term Recommendations

- 1) *State transportation agencies (or other State agencies, if appropriate) should formally agree to be the focal point in the State to ensure proper coordination between highway authorities and railroads regarding the interconnection of grade crossing warning devices and highway traffic signals, and consideration of the storage distance between the track and the parallel highway. The responsibilities of the agency, as a focal point, would be to:*
  - a) *develop, distribute, and continually update a list of State and local highway authorities and railroad contacts who should be involved in the planning, design, construction, operation, and inspection of grade crossing warning devices interconnected with nearby highway traffic signals;*
  - b) *serve as a clearinghouse for collecting and disseminating to State and local highway authorities and railroads all pertinent information necessary for the planning, design, construction, and safe operation of grade crossings in close proximity to highway-highway intersections;*
  - c) *develop guidelines which recommend that, on at least an annual basis, State and local highway authorities and railroads and/or transit agencies conduct joint inspections of the timing and operation of highway traffic signals that are interconnected to nearby grade crossing warning devices; and,*
  - d) *coordinate with State/local school transportation officials, operators of public transit or intercity buses, and trucking organizations to help ensure that drivers are familiar with the operation of interconnected signals and are aware of any storage space limitations at grade crossings on their routes. This information exchange would be carried out in cooperation with Operation Lifesaver.*

**Status:** On May 28, 1996, FHWA Executive Director Tony Kane issued implementation guidance to FHWA field offices that addressed each of the short-term recommendations pertaining to interconnected signals and storage (see Appendix A). Mr. Kane urged that FHWA field staff visit their State and local counterparts to ensure that the recommendations were implemented to the maximum extent feasible. A summary of actions taken on the short-term recommendations is presented later in this section.

In response to FHWA's guidance, all States with operating railroads have informally designated a central focal point, and provided the designated name to FHWA and/or FRA. A listing by name, address, and phone number for the focal points is attached as Appendix B.

**Continuing Efforts:** The FHWA and FRA will send a joint letter to each State focal point providing suggested examples of their roles and responsibilities. The letter will identify the FHWA Division and FRA Region contact persons.

The FHWA and FRA will continue to canvass and share best practices with State-designated focal points on their railroad and highway coordination activities associated with the above short-term recommendations. This information, along with FRA-developed status on high profile crossing research and other information on grade crossing safety, will continue to be jointly sent to the focal points as it becomes available.

- 2) *State and local highway authorities should initiate engineering studies to determine if safety improvements are warranted at grade crossings near highway-highway intersections where there is no interconnection and where there is limited storage distance. Emphasis should be given to locations with STOP sign control at the highway-highway intersection, where storage space is less than required to accommodate the longest legal vehicle permitted to use the highway, and where accident potential is greater due to high volumes of highway and/or rail traffic.*

**Status:** The State responses to this recommendation have included developing databases, studying crossings where signal interconnects may be warranted, and inspecting all crossings with storage distances that may be problematic.

For example, the Florida DOT has evaluated all railroad-highway grade crossings within 250 feet of a highway-highway intersection, and is now studying all crossings within 500 feet of intersections to determine if a more thorough investigation is warranted. The Illinois DOT has surveyed all railroad-highway grade crossings with less than 75 feet storage on or adjacent to State-maintained highways. It has sent local jurisdictions a letter asking them to

conduct similar surveys for locations under their jurisdiction.

The FRA mailed letters to State Governors to bring to their attention the importance of initiating engineering studies to determine if safety improvements are warranted at railroad grade crossings near highway-highway intersections where there is no interconnection and where there is limited storage distance. See Appendix C for a copy of this letter.

**Continuing Efforts:** The FHWA and FRA will continue to encourage all States to comply with this recommendation, and will continue to follow activities in the several States that are currently addressing limited storage distance at non-interconnected sites.

- 3) *State and local highway authorities, through coordination with the railroads, should ensure that storage space is a significant consideration early in the planning and design processes where physical changes are being proposed to the highway or railroad at interconnected signal locations.*

**Status:** The May 28, 1996, implementation guidance emphasized that FHWA Division offices should ensure that procedures are in place so that storage space is routinely considered by planners and designers. States have taken a number of actions to carry out this recommendation. These include using newsletters and memoranda to advise parties responsible for railroad agreements, revising design manuals, alerting project review personnel, and assigning the crossing safety review function to one individual.

Additional follow-up will be initiated by further meetings with the American Association of State Highway and Transportation Officials (AASHTO) and with the American Railway Engineering Association.

- 4) *FHWA and FRA field staff should initiate regional conferences throughout the country for highway agencies and railroads to specifically discuss grade crossing safety issues, including interconnected signals and storage practices.*

**Status:** The memorandum of May 28, 1996, also directed FHWA Regional and Division Administrators to initiate regional conferences. All FHWA Regions with the exception of Regions 1 and 6 conducted a regional conference in 1996. Oklahoma sponsored a State Highway/Railroad Conference in 1996 and will host a Region 6 conference in October 1997. Region 1 is planning to hold a conference, but no date has been set. A number of individual States routinely conduct annual Highway/Railroad Conferences to improve coordination and jointly discuss grade crossing safety issues, including interconnected signals and storage practices.



## B. Long-Term Recommendation

- 1) *The FHWA should convene a technical working group that includes representatives of rail crossing safety organizations to review existing standards and guidelines and develop new ones, if appropriate, on grade crossing safety including the following issues: when interconnected signals should be used, minimum clearance green time, the existing 20-second minimum warning time, critical storage distance, use of near side traffic signals, and stopping on tracks. One of the outputs of this group could be recommended additions and/or changes to the Manual on Uniform Traffic Control Devices (MUTCD), the Railroad-Highway Grade Crossing Handbook, or other appropriate guidance documents. The group should be established and hold its initial organizational meeting by June 1, 1996, and submit proposed standards/guidelines within a year.*

**Status:** The FHWA and FRA established the Technical Work Group in June 1996, assisted by the Institute of Transportation Engineers. Meetings of the Technical Work Group were held on July 1–2, 1996, September 18–19, 1996, and January 15–16, 1997. The TWG has completed the review of existing standards and guidelines and developed new guidance on railroad-highway grade crossings. The results of this group's findings, recommendations, and other accomplishments are presented in Chapter 2.

A significant accomplishment by the TWG has been the development of a common glossary of terms (terminology.) These newly defined terms should enhance the understanding of issues by all parties and result in improved consistency in designing, operating, and maintaining interconnected systems. The list of terms and their definitions are included in Chapter 2, Part II.

Since the January 15–16, 1997 meeting, when consensus was reached on the definitions for the terms, many of the agencies, associations, and organizations represented on TWG have informally begun using the terminology in preparing their new and revised publications, training programs, and correspondence. The newly revised Institute of Transportation Engineers Recommended Practice on "Preemption of Traffic Signals At or Near Railroad Grade Crossings with Active Warning Devices" has incorporated the terms.

The TWG deliberations resulted in 35 recommendations to the Task Force, including 10 recommendations for the FHWA on standards/guidelines for interconnection and vehicle storage. There are eight TWG recommendations addressing the need for further research, evaluation, and/or experimentation. The remaining recommendations are on activities and actions that practitioners, State focal

points, and other parties could implement that would improve railroad-highway grade crossing safety.

The general consensus reached by the TWG regarding the existing 200 feet guidance as criteria for considering preemption is, at best, only a "rule of thumb." The TWG has recommended that the need for preemption should be based on a thorough engineering study of the site specific conditions. If preemption is necessary, additional analysis must be done to determine what type of preemption, either simultaneous or advance. Also, if clear storage distance is an issue a decision on using pre-signals should be analyzed. The TWG made no recommendation for changing the guidance on the use of the DO NOT STOP ON TRACKS sign.

The TWG recommends annual joint inspections of the timing and operation of highway traffic signals interconnected to nearby grade crossing active warning devices. The TWG drafted examples of a form for use in conducting joint inspections (Appendix D) and an interconnect warning placards for use in highway and railroad control cabinets (Appendix E).

Discussions were held regarding the 20-second minimum warning time for active railroad-highway grade crossing warning devices. Based on the research information currently available, and the experience and observations of the TWG members, no changes in the minimum warning time was recommended. However, the basic 20-second minimum warning time may be insufficient at interconnected locations, so an engineering analysis must be undertaken based on site-specific criteria to determine if additional warning time is needed for simultaneous preemption. If problems with too much warning time (gate running) are anticipated for simultaneous operations, then advance preemption or pre-signals need to be considered.

Significant amounts of state-of-the-practice, state-of-the-science, and new research studies have been accumulated by the TWG and other groups as a result of this long-term recommendation. Articles and papers have been written and prepared for engineering journals and conferences on these subjects. Some of these are included in the Annotated Bibliography in Appendix F.

**Continuing Efforts:** The Department will use the new terminology in future publications and correspondence.

The FHWA will review the TWG recommendations on proposed standards and/or guidelines and incorporate the state-of-the-practice design and operation guidance on preempted grade crossings into the revised *Railroad-Highway Grade Crossing Handbook* and the *MUTCD*. The FHWA is

currently revising both of these documents. The FHWA will begin research to establish a new traffic signal preemption warrant, and revise signing requirements when pre-signals are used, as modifications to the MUTCD.

The FRA will print and distribute warning placards for use in highway and railroad control cabinets. The distribution will be made to the State focal points and railroad public projects engineers.

### III. HIGH-PROFILE CROSSINGS

The Grade Crossing Task Force reviewed the high-profile crossing issue as an acknowledged, multi-modal problem and because it is multi-modal, deemed well suited for review by the multi-modal, diverse representation on the Task Force. The March 1996 report made five short-term and two long-term recommendations that have been addressed by actions of the Technical Working Group and the Headquarters staff of FRA and FHWA. The long-term recommendations are covered in Chapter 2.

#### A. Short-Term Recommendations

- 1) *The FHWA should approve a standard advance warning sign for high-profile crossings and amend the Manual on Uniform Traffic Control Devices accordingly.*

**Status:** On January 9, 1997, revisions to the MUTCD, which included an advance warning sign for high-profile crossings (Appendix G), were published in the *Federal Register*. A sign similar to that already in use in New York, North Carolina, and Florida was adopted. Road authorities may now use the new standard warning symbol sign in advance of any crossing location that is known or perceived to be a high-profile crossing.

- 2) *FRA, working with FHWA, States, and the rail industry, should define the information needed by the operator in the event of a vehicle hang-up, which should be included on a crossing identification sign.*

**Status:** After a review of current practices and signing, and discussions with industry contacts, a word-message sign was proposed to, and reviewed by, the TWG in September and in January. The discussion and input by the TWG are covered in Chapter 2. An example of a word-message is as follows:

REPORT EMERGENCY  
TO 1-800-555-1234  
CROSSING #123-456G  
ON STREETNAME ROAD

It has been determined by the FHWA that these types of signs should be made as simple as possible and do not need to be included in the MUTCD.

**Continuing Efforts:** The FHWA will add guidance on the use of emergency notification signs into the revised *Railroad-Highway Grade Crossing Handbook*.

The FRA and FHWA will jointly encourage States and railroads to install emergency signs at known high-profile crossings. This will be done by letter to the State focal points and by disseminating information at State, regional, and national meetings.

- 3) *State and local highway agencies, working with railroads, should identify problem high-profile crossings (i.e., crossings with a history of, or evidence of, vehicle hang-ups), by reviewing accident data and consulting with highway engineers, local railroad officials, truckers, and public officials. Once identified:*

- a) *Standard advance warning signs and a crossing identification sign (see previous recommendations) should be conspicuously installed.*
- b) *As States identify high-profile crossings, the FRA should retain the information in the USDOT/Association of American Railways (AAR) National Highway-Rail Crossing Inventory.*
- c) *States and/or FRA should enable State special permit offices to electronically access rail crossing databases and develop maps that identify problematic rail crossings to delineate routes for special permit vehicles.*

**Status:** Discussions with State and local road authorities and with railroad officials indicate that many "problem" crossings are known locally, either from direct collision experience or from previous experience with vehicle hang-ups. State and local road authorities should establish a systematic procedure for gathering and applying this local knowledge. The FHWA and FRA will encourage road authorities and railroads, in coordination with the State focal points, to initiate a program to identify and sign, or correct, existing high-profile crossings that are known to pose a hazard.

The FRA has modified the Grade Crossing Inventory contract to enter the number of high-profile crossing signs located at each crossing. When modification is completed, States, railroads, and organizations representing the trucking industry will be instructed on the proper means to provide and access the new data.

Once these crossings are identified in the Inventory, it will be possible for State DOTs to provide such information to State special permit offices. FRA is also considering making this information available on the Internet. Some questions are as yet unanswered. For example, what information will be needed by special permit offices? Answering this question will influence by whom and how

data can be provided. FRA will review this requirement with FHWA and NTSB.

**Continuing Efforts:** The FHWA and the FRA will encourage focal points, road authorities, and railroads to identify and sign or correct existing high-profile crossings. The FRA will complete the modifications to the software and instructions for the National Grade Crossing Inventory. The States and railroads will be informed on how to submit new inventory data for high-profile crossing signs.

## B. Long-Term Recommendations

1) FRA, working with FHWA, should convene a Working Group composed of highway officials, manufacturers of low-clearance vehicles and the users of such vehicles, and the railroads to investigate the feasibility of developing a nationwide classification system that would assign compatibility codes to crossings and vehicles for the purpose of helping low-clearance vehicle operators avoid getting hung up on high-profile crossings. Within 1 year, the Working Group should present its findings for possible implementation. Examples of areas of focus for the Working Group include the following:

- a) Vehicle characteristics such as wheelbase, actual ground clearance at points between adjacent axles, and front and rear overhangs and heights above ground. Based on these, appropriate vehicle classification codes may be determined.
- b) The feasibility of inspecting highway-rail crossings to measure their road surface profiles.
- c) The feasibility of developing an appropriate and readily understandable classification code.

**Status:** The feasibility of a vehicle/crossing classification scheme was discussed and the need for a method to classify affirmed during Blue Ribbon Working Group meetings in January/February 1996 and during public meetings following the hearings in December/January. A presentation was made to the Truck-Trailer Manufacturers' Association in the fall of 1996. A representative of the Specialized Carriers and Rigging Association was also present.

The TWG was given an opportunity to review the FRA actions and provide input. Their deliberations are included in Chapter 2. The TWG endorsed the development of a simplified procedure to identify crossing profiles.

**Continuing Efforts:** To identify the problems that high profile crossings may pose for low-ground clearance vehicles, the FRA has initiated work on two projects. The first project will obtain measurements from approximately 25 crossings located throughout the United States where immobilization and collisions have occurred. The measure-

ments will be taken by professional land surveyors under contracts with the FRA.

The second project will refine and apply a computer-based predictive model for analyzing the interaction between road surface profiles and highway vehicles. The FRA has contracted with the University of West Virginia's Department of Civil Engineering to use its model and crossing measurement data for validating and incorporating some other changes to expand its capabilities. Ultimately the model will be made available to railroads, highway departments, vehicle designers, and vehicle operators to help them reduce or eliminate immobilizations at crossings. The model's most immediate application will be in identifying crossings where the road profiles have the potential for causing immobilization.

The Task Force anticipates that vehicle classifications and profile classifications can be defined, and all the agencies and organizations involved with this problem are progressing on that premise. Initial efforts are focusing on the crossings. Vehicle classifications—at least for negotiating high-profile crossings—are interdependent on crossing classifications. After data have been collected and classifications proposed for crossings, vehicle configurations will be tested in order to isolate conflicts, anomalies, and possible classifications. The process will probably be iterative and will probably not start until it has been determined that it is feasible to economically inspect large numbers of railroad-highway grade crossings to measure their road surface profiles.

Further decisions on feasibility and time frames will have to wait until the applicability of the software package is known and the difficulty of collecting and analyzing data has been assessed.

- 2) The FRA should work with FHWA, the railroad industry, and national/State transportation associations to develop guidelines for track and highway maintenance that establish maximum thresholds for post-maintenance vertical alignment.

**Status:** No universal maintenance "guidelines" exist. A meeting was held in November 1996 with FHWA, the American Railway Engineering Association (AREA) and AAR to determine how to proceed on this issue. It was agreed that AAR would canvas its members regarding perceptions and suggestions on existing standards, guidelines or agreements and their recommendations on how this issue might be approached. In January 1997 a video conference was hosted by AAR with chief engineers (or their representatives) of Class I railroads and with representatives from AREA, AASHTO, FHWA, and FRA to obtain information regarding the state-of-the-practice on what the

maintenance practices are now, the perceived effectiveness of these practices, and problems currently encountered in maintaining vertical alignments.

Follow-up meetings were held in February and April with the American Short Line Railroad Association (ASLRA), AREA, AASHTO, FHWA, and FRA. The participants tentatively agreed to survey highway authorities at State and local levels and railroad officials regarding perceptions, the need for, and content of "best practice" guidelines for the post-maintenance vertical alignment of crossings. A draft survey form to be sent to public agencies and railroads by AASHTO, ASLRA, AAR, the Institute of Transit Engineers (ITE), APWA, and AREA is attached as Appendix H. Such a guideline will probably address communications between highway authorities and railroad officials, a method for assessing a crossing's vertical alignment status, and the end-result post maintenance.

**Continuing Efforts:** Decisions on the development of a maintenance guideline will be made based on the results of the survey by the agencies and organizations involved. The Department will continue to advance these long-term recommendations through its ongoing work with Operation Lifesaver, AAR, AREA, and AASHTO to encourage State and local highway authorities and railroads to identify known or potential problem crossings. It will also encourage State and local highway authorities and railroads to ensure that post-maintenance crossing profiles will be improved (or not made worse) over pre-maintenance profiles.

#### IV. LIGHT-RAIL CROSSING ISSUES

A number of actions on light-rail crossing issues have concentrated on incorporating new standards and guidelines in the MUTCD to ensure that safety factors are adequately considered early in the planning process. Additional efforts to compile light-rail accident data to identify and mitigate safety problems have also been undertaken. A third area of focus has concentrated on enhanced enforcement to deter actions that would compromise safety.

##### A. Short-Term Recommendations

- 1) *The USDOT should endorse the new MUTCD chapter on "Traffic Controls for Light Rail-Highway Grade Crossings."*

**Status:** The Highway Grade Crossing Technical Committee of the National Committee on Uniform Traffic Control Devices (NCUTCD) met in January 1997 and subsequently, the NCUTCD Executive Committee voted unanimously to approve Part X, "Traffic Controls for Highway-Light Rail Transit Crossings," with only minor modifications. Part X was forwarded to FHWA, which will publish

a Notice of Proposed Rule in the *Federal Register* to incorporate Part X into the MUTCD. The anticipated publication date is July 1998. If adopted, the final rule is expected to be completed in 2000, when the entire revised MUTCD is approved by FHWA.

- 2) *Rail transit agencies should begin the process of communicating with public safety agencies as early in the planning process as possible to ensure that safety concerns are appropriately considered in the design and eventual operation of the transit system.*
  - a) *The FTA should instruct local transit planners to put considerations of crossing safety above the incorporation of attractive urban design elements. For example, areas at grade crossings where pedestrians can cross the tracks should be clearly identified even if that means applying markings on expensive design elements or foregoing aesthetic additions such as trees or landscaping.*

**Status:** The FTA is developing a Planning Emphasis Area (PEA) directive to metropolitan and statewide planning agencies that addresses, among other things, the development of standardized regional design criteria for traffic engineering at light-rail/highway interfaces. This PEA will be jointly issued with the FHWA. It is anticipated that the directive will be issued by September 1997. The FTA will monitor the progress and results of these recommendations through the regional planning certification process.

The FTA has designated a person in each regional office responsible for grade crossing safety coordination with the FRA Regional Grade Crossing Managers and FHWA's Regional and Divisional Safety Engineers, and with State and local agencies.

- 3) *In all Full Funding Grant Agreements involving light-rail design and construction, the FTA should include language that addresses priority for light-rail transit systems in interactions with other vehicles. The FTA should require the grantee to include elements in the project scope of work which, where appropriate, provide for the priority of the light-rail system in interactions with other vehicles. For transit systems that are locally funded, the FTA should recommend that local traffic engineers and transit planners address priority issues.*

**Status:** The FTA had previously addressed the issue of traffic signal priority for light-rail transit systems at street intersections through grant contract language. More recently, all Full Funding Grant Agreements for light-rail systems have required that signal interconnection be considered and evaluated in the preliminary engineering stage of system design. Those systems with contract scope of work requirements for light-rail priority as recommended in the Final Report include San Juan, PR; Hudson-Bergen,

NJ (New Jersey Transit Corporation); St. Louis, MO; Salt Lake City, UT; Denver, CO; and San Jose, CA.

### B. Long-Term Recommendations

1) *Through the Transit Cooperative Research Program, the FTA and the transit industry should develop a process to collect, analyze, and disseminate detailed light-rail accident data.*

**Status:** The FTA is currently reviewing light-rail accident information in an effort to develop a data base useful to the transit industry. The 1995 data from the Safety Management Information System (derived from the FTA's National Transit Database) will be available shortly and will provide a basis for future Transit Cooperative Research Program (TCRP) activity focused on light-rail safety.

2) *The FHWA, FRA, and FTA should review current grade crossing safety documents such as the Railroad-Highway Grade Crossing Handbook and the MUTCD to ensure that light-rail crossing issues are appropriately incorporated.*

**Status:** The FTA is reviewing light-rail system safety issues presented in the MUTCD and other technical documents to ensure appropriate guidance. The *Railroad-Highway Grade Crossing Handbook* is currently being revised by the FHWA. Efforts will be made to ensure that light-rail crossing safety issues are appropriately incorporated.

The ongoing collocation of elements of these three agencies as well as regional interagency agreements will provide a high level of staff attention and cooperation in the area of grade crossing safety.

A research project is currently under way on higher speed light-rail transit (LRT) grade crossing safety. The project is funded by the FTA through the TCRP. Recommendations for barrier medians and other delineation (currently in DRAFT form) can be found in Appendix I.

3) *In cooperation with the FTA, ITE should develop guidelines for priority of light-rail vehicles operating in city streets as part of its ongoing effort to identify recommended practices in this area.*

**Status:** ITE had a committee that was undertaking the development of guidelines to identify and recommend any needed changes to the MUTCD to provide for adequate traffic control devices at the various types of LRT at-grade crossings. When a consultant, who was also the chair of this ITE committee, was awarded a TCRP contract to explore this issue and more, the ITE committee was disbanded. The TCRP contract resulted in the report that developed guidelines for priority of light-rail vehicles operating in city streets, entitled "Integration of Light-Rail Tran-

sit into City Streets." This report, #17, was published by TCRP in January 1997.

4) *In cooperation with the National Conference of State Legislators and the National Governors' Association, States with light-rail systems should enact model legislation for penalties associated with light-rail crossing violations based on existing laws in Texas, California, Virginia, and other States. To encourage enforcement, the legislation should include provisions for citation revenues to be shared with the State, operating agency (transit authority or railroad), and the city/county of operation.*

**Status:** FTA's Office of Chief Counsel continues to review possible approaches to enactment of model legislation. At the suggestion of FHWA and FRA, the TRB, through the Highway Cooperative Research Program, has prepared a draft Compendium of State Laws relating to grade crossing traffic enforcement legislation. In California, for example, it was determined that legislation would be necessary to enable the photo enforcement technique at light-rail-highway crossings.

**Continuing Efforts:** FHWA will also work with the National Committee on Uniform Traffic Laws and Ordinances to determine if the committee can assist in the development of model legislation. The FTA is working with other DOT modal administrations—FHWA, FRA, and the National Highway Transit and Safety Administration (NHTSA)—to implement recommendations to improve grade crossing safety. This effort includes the initiatives in the DOT's Grade Crossing Safety Action Plan, the Grade Crossing Safety Task Force Report, and enhanced regional cooperation and coordination.

## V. SPECIAL VEHICLE OPERATIONS AND INFORMATION

States are responsible for determining the safety protocols for school bus operations, establishing provisions for the issuance of special operating permits for oversize/overweight vehicles, and selecting contents of commercial drivers' license tests. The Grade Crossing Task Force identified three short-term and two long-term recommendations in these areas, but recognized that the recommendations would be acted upon largely through the voluntary efforts of the States and local agencies and not as a result of prescriptive directions from the Department.

### A. Short-Term Recommendations

1) *State directors of pupil transportation should encourage local school boards and school bus contractors to include crossing emergency numbers and an identification number giving the crossing's exact geographic location in school bus dispatch books provided to drivers and substitutes.*

**Status:** In October 1996, Operation Lifesaver, in cooperation with the FHWA, FRA, and NHTSA, distributed a school bus driver awareness and training video and information package on Railroad-Highway Grade Crossing Safety.

In February 1997, NHTSA awarded a contract to develop a one-day, in-service program for school bus drivers. Working with a panel of experts, including representatives from FRA and FHWA, the contractor will prepare a program that will focus on current issues in school bus safety, including the railroad-highway grade crossing safety issue. It is anticipated that the training program will be available for implementation within school districts at the beginning of the 1998–1999 school year.

NHTSA and the National Association of State Directors of Pupil Transportation Services are working together to identify existing school bus routing and hazard marking systems and to evaluate their effectiveness. Based on the evaluation, an existing routing program will be adapted or a new program developed and promoted to school systems nationwide. A key component of the program will be its ability to route buses around railroad-highway grade crossings. However, if it is not possible to reroute buses, the crossings will be marked as hazardous, and all bus operators will be alerted to the hazard as well as the potential dangers. The anticipated project completion date is December 1997.

2) *State permit offices should list emergency telephone numbers on all special vehicle operating permits (i.e., the telephone numbers appropriate for the railroad(s) being crossed).*

**Status:** The National Transportation Safety Board (NTSB) has been most active in acting upon this recommendation. Several States have entered emergency contact numbers on special vehicle operating permits—a concept originally developed in Texas. Other States (e.g., Florida) have prepared and distribute pamphlets with special permits. The pamphlets provide emergency contact numbers, including those for railroads. See example in Appendix J.

3) *State permit offices should provide operators of “super-load” special permit vehicles with relevant telephone numbers so that they can notify railroads and arrange for flag protection when planning for or traversing any rail crossing. The vehicle operator and the railroad should confirm exactly (by crossing number or on-the-ground inspection) the identity of the highway-rail crossing(s) involved.*

**Status:** NTSB has pursued this recommendation through its contacts with State special permit offices.

4) *The Commercial Driver License (CDL) manual and CDL tests developed by States should contain expanded discussion of rail crossing safety. Currently, the CDL manual dis-*

*cusses grade crossing safety only for movements of hazardous materials.*

**Status:** Expanded discussion of railroad-highway grade crossing safety in the CDL manual and tests is one of the issues that FHWA’s Office of Motor Carriers is pursuing through a collaborative effort with FTA, FRA, and NHTSA.

In addition, the FHWA is progressing with three regulatory actions regarding railroad-highway grade crossings:

- A Notice of Proposed Rule Making (NPRM) is in clear-ance that would make it a violation to drive a commercial motor vehicle (CMV) onto a railroad-highway grade crossing without sufficient space on the other side of the crossing to drive completely through the crossing without stopping. This rule is mandated by the Hazardous Materials Transportation Authorization Act of 1994 (Public Law 103-311).
- A NPRM was published on January 27, 1997, that proposed to amend the requirement for CMVs carrying passengers, chlorine, or hazardous materials requiring placarding to stop at crossings with a warning device only when the device is activated. The comment period closed on May 12, 1997.
- Section 403 of the Interstate Commerce Commission (ICC) Termination Action of 1995 (Public Law 104-88) requires that regulations be established making the violation of a traffic safety law at a railroad-highway grade crossing a serious traffic violation for CDL holders. It is anticipated the rulemaking will be initiated later this year in the form of a Supplemental Notice of Proposed Rule-making; Request for Comments. FHWA Docket MC-90-10 has been established.

**Continuing Efforts:** The Department will contact each State focal point to complement NTSB’s effort to advance the second and third initiatives above.

## B. Long-Term Recommendations

1) *States should develop certification programs for escort vehicle drivers with training exercises in crossing safety.*

**Status:** NTSB has pursued this recommendation through its contacts with State special permit offices.

2) *State special permit offices should ensure that operators of both escort vehicles and special permit vehicles are required to maintain a “real time” communications link with their dispatcher or a central authority.*

**Status:** NTSB has pursued this recommendation through its contacts with State special permit offices.

3) *If high-profile crossing and commercial vehicle classifications are developed by the Working Group convened under*

*Long-Term Recommendation 1 in the High-Profile Crossings problem area, States should implement labeling and compliance procedures to carry out this classification process.*

**Status:** A crossing classification system, developed under the high-profile recommendations, would address this recommendation by identifying problematic crossings and by enjoining any party, highway or rail, from making changes

that would diminish a crossing's classification. This may be the ultimate solution to this potentially contentious issue.

**Continuing Efforts:** The Department will continue to advance these long-term recommendations through its ongoing work with Operation Lifesaver. The Department will also contact each State focal point to complement NTSB's efforts to encourage training of escort drivers and improved communications.





# Chapter 2

## Technical Working Group Findings and Recommendations

### I. INTRODUCTION

The USDOT Grade Crossing Safety Task Force made long-term recommendations that called for FHWA and FRA to convene a TWG to review existing standards and guidelines and develop new ones, if appropriate, on several grade crossing safety issues. The FHWA and FRA established the TWG in June 1996. To assist with facilitating the meetings and provide technical assistance, the FHWA contracted with ITE. The TWG consisted of representatives of agencies, professional organizations, and other groups that had knowledge and interest in assisting USDOT in improving railroad-highway grade crossing safety. A complete list of participating agencies is in Appendix K.

The Task Force recommendations, which the TWG was specifically requested to examine, included the following issues: when interconnected signals should be used; minimum clearance green time; the existing 20-second warning time; critical storage distance; use of near side traffic signals; stopping on tracks; and the feasibility of developing a nationwide classification system of crossings and vehicles to assist vehicle operators to avoid getting high-centered on high-profile crossings. To take advantage of the group's expertise, FHWA and FRA also called upon the TWG to provide input for the following Task Force recommendations the Department had already started action on but had not completed: defining emergency signing information needed by an operator in the event of a vehicle hang-up at a crossing, and developing guidelines for conducting inspections of timing and operation of interconnected signal systems. The Task Force recommended the following products: "The output of this group could be recommendations to add and/or make changes to the *Manual on Uniform Traffic Control Devices (MUTCD)*, the *Railroad-Highway Grade Crossing Handbook*, or other appropriate guidance documents."

One of the guidance documents reviewed by the TWG was ITE's revised Recommended Practice (RP), *Preemption of Traffic Signals at or Near Railroad Grade Crossings with Active Warning Devices*. This publication includes the TWG terminology and incorporates comments made by TWG members. In this report, we will refer to this publication as "ITE's revised RP on Preemption."

The TWG held three meetings: July 1–2, 1996, in Washington, DC; September 18–19, 1996, in Minneapolis, MN; and January 15–16, 1997, in Washington, DC. In addition, numerous subgroups met and/or corresponded over the past year to "close the gap" in design, construction, maintenance, and operation of railroad-highway grade crossings when located in proximity to highway intersections.

This chapter covers the findings and recommendations resulting from the TWG discussions. The discussions are grouped into the following sections:

- Terminology
- Interconnected Signals and Vehicle Storage
- High Profile Crossings
- Joint Inspections
- Additional Topics Discussed by the TWG

ITE produced an annotated bibliography to assist with ongoing railroad-highway grade crossing safety deliberations. The annotated bibliography is in Appendix F.

A list of the 35 TWG recommendations is in Appendix L.

### II. TERMINOLOGY

Through the joint inspections evaluating the safety of existing interconnected railroad and highway signal systems, a serious problem with terminology was identified. Terms that were commonly used by the railroad signal maintainers and highway signal electricians as part of their separate operations were either not understood by the other party, or in the case of the terms "interconnection" and "preemption," had meanings that referred to two entirely different concepts. Therefore, the TWG developed terms with common definitions that both railroad and highway industries could agree to use in their respective standards, guidance publications, and correspondence. In some cases these terms are new to both parties. The TWG believes these terms, as defined in this chapter, will result in a better understanding of the issues and improve consistency in design and operation of all interconnected signal systems.

The TWG recommends that the definitions for the following terms be used in all future standards, guidance publications, and correspondence:

**1. Minimum Track Clearance Distance (MTCD)**—For standard two-quadrant railroad warning devices, the minimum track clearance distance is the length along a highway at one or more railroad tracks, measured either from the railroad stop line, warning device, or 4 meters (12 feet) perpendicular to the track centerline, to 2 meters (6 feet) beyond the track(s) measured perpendicular to the far rail, along the centerline or edge line of the highway, as appropriate, to obtain the longer distance. (See Appendix M.)

**2. Clear Storage Distance**—The distance available for vehicle storage measured between 6 feet from the rail nearest the intersection to the intersection STOP BAR or the normal stopping point on the highway. At skewed crossings and intersections, the 6-foot distance shall be measured perpendicular to the nearest rail either along the centerline, or edge line of the highway as appropriate to obtain the shorter clear distance. (See Appendix M.)

**3. Preemption**—The transfer of normal operation of traffic signals to a special control mode.

**4. Interconnection**—The electrical connection between the railroad active warning system and the traffic signal controller assembly for the purpose of preemption.

**5. Monitored Interconnected Operation**—An interconnected operation that has the capability to be monitored by the railroad and/or highway authority at a location away from the railroad-highway grade crossing.

**6. Minimum Warning Time—Through Train Movements**—The least amount of time active warning devices shall operate prior to the arrival of a train at a railroad-highway grade crossing.

**7. Right-of-Way Transfer Time**—The maximum amount of time needed for the worst case condition, prior to display of the clear track green interval. This includes any railroad or traffic signal control equipment time to react to a preemption call, and any traffic signal green, pedestrian walk and clearance, yellow change, and red clearance intervals for opposing traffic.

**8. Queue Clearance Time**—The time required for the design vehicle stopped within the minimum track clearance distance to start up and move through the minimum track clearance distance. If pre-signals are present, this time should be long enough to allow the vehicle to move

through the intersection, or clear the tracks if there is sufficient clear storage distance.

**9. Separation Time**—The component of maximum preemption time during which the minimum track clearance distance is clear of vehicular traffic prior to the arrival of the train.

**10. Maximum Preemption Time**—The maximum amount of time needed following initiation of the preemption sequence for the highway traffic signals to complete the timing of the Right-of-Way Transfer Time, Queue Clearance Time, and Separation Time.

**11. Advance Preemption and Advance Preemption Time**—Notification of an approaching train is forwarded to the highway traffic signal controller unit or assembly by railroad equipment for a period of time prior to activating the railroad active warning devices. This period of time is the difference in the Maximum Preemption Time required for highway traffic signal operation and the Minimum Warning Time needed for railroad operations and is called the Advance Preemption Time.

**12. Simultaneous Preemption**—Notification of an approaching train is forwarded to the highway traffic signal controller unit or assembly and railroad active warning devices at the same time.

**13. Pre-Signal**—Supplemental highway traffic signal faces operated as part of the highway intersection traffic signals, located in a position that controls traffic approaching the railroad crossing and intersection.

**14. Cantilevered Signal Structure**—A cantilevered signal structure is a structure that is rigidly attached to a vertical pole and is used to provide overhead support of signal units.

**15. Design Vehicle**—The longest vehicle permitted by statute of the road authority (State or other) on that roadway.

### III. INTERCONNECTED SIGNALS AND VEHICLE STORAGE

#### A. Signals

##### *Twenty-Second Minimum Warning Time*

Since the 1920s, the Handbook of the AAR has used a minimum 20-second warning time at railroad-highway grade crossings. The origin of this 20-second warning time is based on 1920s' design criteria. The design criteria were

based on the time it takes a truck to engage into gear and cross the clear track distance. While this practice has remained in use, vehicle design characteristics have changed (longer and heavier, but more powerful and less likely to stall). Therefore, the appropriate minimum warning time for optimum safety, now and into the future, has been debated.

AAR has recognized some of the variables that affect minimum warning time calculations for specific sites. Its *Signal Manual* (Part 3.3.10) adds warning time for clear storage distance calculations, variations in equipment response time, gate operating time, motion detection or constant warning time response systems, and any discretionary time determined appropriate for the site.

Effective January 1, 1996, inspection, testing, and maintenance regulations for railroad-highway grade crossing warning devices confirmed a minimum warning time of 20 seconds. If the railroad-highway grade crossing warning devices do not provide at least 20 seconds, they have failed to activate properly. This regulation is described in 49 CFR 234.

Recent research and experience of practitioners find that excessive warning times encourages gate violations. On the other hand, a warning time that may be less than optimal imposes a serious safety hazard. A recent FHWA report, FHWA-SA-91-007—*Warning Time Requirements at Railroad-Highway Grade Crossings with Active Traffic Control*, suggests minimum warning time guidelines based on highway grade and clear track distance. ITE's revised RP on Preemption begins to address this issue.

- 1) *The TWG recommends practitioners continue to use the existing 20 second minimum warning time in accordance with 49 CFR 234 as a minimum plus additional time added as determined by AAR's Signal Manual, railroad company policies, FHWA's research, site specific studies and ITE's revised RP on Preemption.*
- 2) *The TWG recommends additional studies are warranted to provide a procedure to determine the optimum safe warning time for railroad-highway grade crossings. The procedure must take into consideration that excessive time could encourage gate runners.*

### **Interconnected Signals**

It has been a long-standing and desirable engineering practice to preempt highway intersection traffic signals in close proximity to railroad-highway grade crossings that have active warning devices. The purpose of the preemption is to allow sufficient time for any motor vehicle inadvertently stopped on a railroad-highway grade crossing to proceed off the track prior to the arrival of a train.

Currently the *MUTCD* provides general guidance for interconnecting railroad-highway grade crossing warning devices with traffic signal controllers when they are within 200 feet of each other. There is no known research on the origin of this 200-foot distance. However, recent research has revealed that greater distances between railroad tracks and highway intersections may warrant interconnection based on site conditions. Specifically, this is true when traffic queues extend back to the railroad track from the highway intersection during congestion. At existing locations, engineering studies can determine if interconnection is warranted. However, for new location design or planning studies, design guidelines were lacking. ITE's revised RP on Preemption begins to address this issue. More recent work published in the *ITE Journal* (February 1997), "Design Guidelines for Railroad Preemption at Signalized Intersections," provides guidance for possible interconnection of highway traffic signals.

At STOP sign-controlled intersections, the traffic queue length on a minor street approach can exceed the available clear storage distance to a nearby railroad-highway grade crossing. When trains approach the crossing, there is no safeguard to ensure that traffic within the track clearance distance will be able to clear the track before the arrival of the train. Typical situations that could be studied include minor roadways that connect to schools, truck terminals, and other locations where long vehicles are a high percentage of the traffic. The *MUTCD* does not contain a traffic signal warrant or interpretation that applies for the specific purpose of railroad preemption. Criteria that could be considered in the warrant include clear storage distance, frequency and adequacy of gaps on the major roadway, and vehicle classification on the minor street that crosses the railroad tracks.

- 1) *The TWG recommends practitioners use guidance found in ITE's revised RP on Preemption, or other current research findings, when planning and designing preemption systems.*
- 2) *The TWG recommends that practitioners consider interconnecting existing traffic signals to railroad-highway grade crossings when traffic queues routinely back up to the crossing during congested traffic periods, when railroad warning devices and highway traffic controls are added or revised, and when tracks are close to a parallel highway.*
- 3) *The TWG recommends that FHWA research a new MUTCD traffic signal warrant based on preemption requirements with nearby railroad-highway grade crossings.*

### **Types of Preemption**

In order to design a system that allows time for a stopped design vehicle to proceed off a railroad track, the maximum preemption time must be calculated for the intersection timing plan and anticipated traffic queue at a specific

site. If the maximum preemption time is the same as or less than the minimum warning time, then simultaneous preemption is typically used by most jurisdictions. When the maximum preemption time exceeds the minimum warning time for railroad crossing warning devices, advance preemption is the most desirable option. Appendix N shows timeline examples developed by the TWG that illustrate the difference between simultaneous and advance preemption.

For economic reasons, when additional preemption time is needed at a site, simultaneous preemption can be an acceptable option if the railroad crossing warning time is increased to equal the maximum preemption time. However, excessive railroad warning time above minimum requirements can be a factor in improper and unsafe driver responses, such as gate running. Therefore, some jurisdictions are now routinely using advance preemption for all railroad preemption systems because of the flexibility in modifying advance preemption time when conditions change at the site without affecting railroad warning time. Currently there are no national standards or guidelines for evaluating and designing cost-effective and safe preemption systems.

The MUTCD allows pedestrian intervals to be shortened for preemption. At several simultaneous preemption sites, the State of Illinois is experimenting with a sign for pedestrians at some railroad crossings that reads, "CAUTION, WALK TIME SHORTENED WHEN TRAIN APPROACHES." It should be noted that one of the benefits of advance preemption is that pedestrian clearances do not have to be abbreviated.

- 1) *The TWG recommends that FHWA provide additional detailed guidance in the revised Railroad-Highway Grade Crossing Handbook on how to evaluate and design a cost-effective and safe preemption system, based on site conditions.*
- 2) *The TWG recommends that FHWA add general guidance on the types and design of preemption to the MUTCD.*
- 3) *The TWG recommends that experimentation and evaluation be conducted to determine the effectiveness of a sign to warn pedestrians of shortened crossing times at locations where simultaneous preemption is used.*

### Pre-Signals

Pre-signals are operated as part of a highway intersection traffic signal system and are located in a position that controls traffic approaching the railroad-highway grade crossing and the intersection. The signals face vehicles approaching the railroad tracks, and their displays are integrated into the railroad preemption program. The signal faces may be located on either the near or far side of the

railroad tracks, including mounting on the same cantilever signal structure(s) as the railroad active warning devices.

See Appendix M for a sample diagram of a pre-signal and a cantilever signal structure. ITE's revised RP on Preemption also includes a pre-signal diagram example. A limited number of pre-signals have been installed nationwide. The State of Michigan has perhaps the most experience in this area, with approximately 150 pre-signals in use.

A pre-signal is the only known traffic signal solution for situations where the length of the design vehicle exceeds the clear storage distance. A storage distance warning sign is being used in some jurisdictions as an alternative signing solution.

- 1) *The TWG recommends that FHWA add the following wording to the MUTCD: "If a pre-signal is installed at an interconnected railroad-highway grade crossing near a signalized intersection with a storage problem, a NO TURN ON RED sign should be used." See Appendix M for the location of this sign with respect to the highway-highway intersection.*
- 2) *The TWG recommends that FHWA include detailed guidance in the revised Railroad-Highway Grade Crossing Handbook on how to evaluate the need and design of pre-signals.*
- 3) *The TWG recommends that FHWA include general guidance in the MUTCD describing pre-signal operation.*
- 4) *The TWG recommends that research be conducted to determine the effectiveness of gates when pre-signals are installed.*

## B. Vehicle Storage Distance

### Design Vehicle

Design criteria are required on the physical and operating characteristics of vehicles that are used in designing rail and highway profiles and geometry, sight distance requirements, and the passive and active warning devices used at crossings. Such examination should determine the desired and minimum design parameters for vehicle length, width, height, ground clearance, length between adjacent axles, and acceleration/deceleration rates and on how these rates will be affected by the grades that are commonly encountered at railroad crossings. From this examination, new standards and guidelines could be developed for the physical and operating elements of at-grade crossings which, if implemented, would result in reduced accidents and congestion at these crossings.

The *Railroad-Highway Grade Crossing Handbook* assumes a distance of 10 feet from driver to front of vehicle. It assumes a vehicle length of 65 feet and vehicle acceleration

in first gear of  $1.47 \text{ ft/s}^2$  with no grade. Acceleration rates may vary owing to site-specific grades and highway profiles. Any engineering study should include an examination to determine the design vehicle for the crossing and vehicle acceleration rates. See Appendix F for studies currently available.

- 1) *The TWG recommends research on current truck characteristics, because a gap in knowledge exists.*
- 2) *The TWG recommends that FHWA and other parties include updated design guidance on vehicle characteristics and acceleration to reflect current research in the revised Railroad-Highway Grade Crossing Handbook and other parties' handbooks.*

### Storage Distance Signing

To connote storage distance, some jurisdictions use a symbol or a word message sign to indicate the amount of storage distance between a railroad crossing and an adjacent highway intersection.

- 1) *The TWG recommends that practitioners use a storage distance warning sign as an interim measure prior to installation of a pre-signal or at any crossing where the clear storage distance is less than the design vehicle length regardless of the presence of signals or warning devices.*
- 2) *The TWG recommends that further research and evaluation be conducted to determine the most effective signs for active and passive crossings to warn or regulate motorists about clear storage distance at preempted intersections.*

### Storage Distance Pavement Markings

Cross hatch-type striping across the track clearance distance has been used successfully on several LRT systems. Appendix O shows an example of pavement markings being tried at a railroad-highway grade crossing. Although it could be proven effective, some concern was expressed about maintenance costs.

- 1) *The TWG recommends that further evaluation, research, and MUTCD-sanctioned experiments be conducted to determine the most effective pavement markings for active and passive crossings to warn or regulate motorists about the clear storage distance and the minimum track clearance distance at preempted intersections.*

### C. Other Pavement Markings

The current MUTCD, section 8B-4, covers standards and guidelines for railroad-highway grade crossing pavement markings. Among the issues is possible restricted sight distance down the railroad track when vehicles stop at locations currently prescribed in the MUTCD.

- 1) *The TWG recommends examinations and evaluations to determine whether other types of pavement marking colors,*

*patterns, areas of coverage, and stop bar placements can be applied at railroad-highway grade crossings.*

### D. Reducing Gate Running

While reducing gate running was not a task charged to the TWG by the USDOT Task Force, members of the TWG believed some recommendations on this item are warranted.

Recent North Carolina experience suggests that median barriers (stand-up, reflectorized flexible posts) with four quadrant gates are a very effective treatment for reducing grade crossing violations. At one railroad-highway grade crossing, violations went from 43 per week to 10 per week with the median barriers only, 6 per week with four quadrant gates only, and 1 per week when both four quadrant gates and median barriers were installed together.

- 1) *The TWG recommends that additional examinations and evaluations be done to determine the most effective treatment at railroad-highway grade crossings to reduce gate running, including median barriers, flexible delineators, four-quadrant gates, and others.*
- 2) *The TWG recommends that FHWA include general guidance on gate-running and preventive treatments in the MUTCD.*
- 3) *The TWG recommends that FHWA include detailed design guidance on the types of treatments available for reducing railroad-highway grade crossing violations in the revised Railroad-Grade Crossing Handbook.*

## IV. HIGH-PROFILE CROSSINGS

Approximately every 2 weeks a truck with low ground clearance is struck by a train after becoming stuck while attempting to traverse a high-profile (i.e., "humped") railroad-highway grade crossing. Empirical evidence indicates that the number of truck "hang-ups" is at least 10 times greater, but that trucks are extricated before a train happens to use the track.

### A. Crossing Identification Sign

One of the recommendations in the USDOT Task Force report, "Accidents That Shouldn't Happen," was that "FRA, working with FHWA, States and the rail industry, should define the information needed by the operator in the event of a vehicle hang-up, which should be included on a crossing identification sign."

After a review of current practices and signing and discussions with industry contacts, the FRA offered a word-message sign example to the TWG in September and January,

requesting their input and suggestions on alternative message content, sign placement criteria, and color. These signs would typically be located on railroad right-of-way. The originally proposed word-message example is as follows:

TO REPORT STALLED  
VEHICLE ON TRACKS  
OR OTHER EMERGENCY  
CALL 1-800-232-0144  
AND REFER TO  
CROSSING #140-883M  
ON HANOVER RD.

In the above example, the crossing number is for the CSX Transportation crossing located in Hanover, Maryland, and the telephone number is CSX's dispatch center. In the absence of a statewide 1-800 number for responding to railroad-highway grade crossing problems, a decision must be made by each State and/or local and railroad regarding where such a call will be directed for the specific crossing. Each railroad would specify its own number or, by agreement, the telephone number of local officials prepared to respond may be used. Another briefer version of the sign message that could be used is as follows:

REPORT EMERGENCY  
TO 1-800-555-1234  
CROSSING #123-456G  
ON STREETNAME ROAD

The TWG attempted to develop uniform sign message and placement criteria that could be applied nationwide. No consensus was reached on the wording for a standard sign message. It was concluded that in order for the sign to be effective, it should convey a clear, simple message and be visible by anyone who is stuck on the tracks. Therefore, it was generally concluded the sign does not necessarily have to be visible by motorists in advance or as they pass over the crossing. The desirable or most effective placement of the sign is highly dependent on site conditions.

- 1) *The TWG recommends that sign placement be decided cooperatively by the railroad and road authority based on specific site conditions.*

### **B. Identifying and Treating High-Profile Crossings**

The TWG was asked to provide input for developing a procedure to inspect and classify road surface profiles. As an example, the TWG recognized the importance of identifying high-profile locations so that motor carrier managers/supervisors can use the information when evaluating route selection for overdimension loads or spacing of semi-trailer landing gear. However, the TWG input confirmed that this is a highly technical issue with infinite possibilities

based on a number of changing variables (vehicle characteristics and road surface profiles).

Discussions by the TWG indicated that many high-profile crossings are known locally, either from direct collision experience, previous experience with vehicle hang-ups, or other physical damage to the pavement. FRA has contracted for modifying the National Highway-Rail Crossing Inventory to make provision for entering the number of high-profile crossing signs located at each crossing. More information on this database can be found in Chapter 1 of this report. The TWG endorses the FRA actions under way and its plans to identify, inventory, and classify high-profile crossings.

- 1) *The TWG recommends that local practitioners identify and sign known high-profile locations as an interim solution.*
- 2) *The TWG recommends that the State focal point (see Chapter 1 of this report) foster the effort of identifying, placing in the national inventory, signing, and prioritizing the elimination of the high-profile geometrics of the crossings.*

## **V. JOINT INSPECTIONS**

In the aftermath of the Fox River Grove crash, the National Transportation Safety Board recommended the joint inspection of all existing interconnected railroad-highway grade crossings. The initial effort resulted in more than 3,400 inspections nationwide. The inspectors concluded that there are no formal standards available to review interconnected signals; only limited informal guidance was available. The Task Force asked the TWG to develop guidelines on inspecting interconnected crossings.

### **A. Periodic Joint Inspections**

The TWG deliberated on the frequency of joint inspections. The TWG discussed the current lack of coordination and communication between railroads and traffic engineering departments and the serious problems that could go unnoticed by unilateral inspection alone.

An example of an inspection form that could be used to inspect intersections that are preempted by railroads is shown in Appendix D. Practitioners may modify this inspection form to add other inspection tasks or information, such as sight distance, and sign inventories.

An interconnect warning placard, shown in Appendix E, was developed for placement in traffic signal controller cabinets and railroad bungalows to remind operations and maintenance personnel about the need for coordination

prior to any modification that would affect the safe operation of the preemption system.

- 1) *The TWG recommends that the State focal points encourage highway, railroad, and light-rail practitioners to conduct joint annual on-site inspections.*
- 2) *The TWG recommends that joint inspections include, but not be limited to:*
  - a) *review of circuit and timing plans to determine compliance with the mutually approved interconnection design; and*
  - b) *activation of the active railroad warning system while observing the highway traffic signal(s) to confirm the maximum preemption time for the traffic signal operation for through train movements.*
- 3) *The TWG recommends that practitioners post a warning placard (or other similar form mutually agreed upon by the highway agency and railroad/transit agency) in all highway traffic signal controller cases and railroad bungalows.*

## **B. Other Joint Coordination**

The TWG discussed the need for railroad and highway authorities to routinely communicate and coordinate normal operational modifications to ensure continuous safe operation of the entire interconnected railroad-highway grade crossing system.

- 1) *The TWG recommends that practitioners review changes affecting the interconnection of traffic signals to the active railroad warning system (i.e., required minimum warning time and maximum preemption time) during the planning and design of new or upgraded hardware and software improvements.*
- 2) *The TWG recommends that practitioners notify other party(ies) and, if necessary, schedule a meeting before modifying any operation that connects to or controls the timing of an active railroad warning system and/or timing and phasing of a traffic signal.*
- 3) *The TWG recommends that the State focal point foster improving communication and coordination, including periodic meetings between parties.*
- 4) *The TWG recommends that practitioners include the maximum preemption time on new or revised railroad circuit plans and traffic signal timing plans.*

## **VI. ADDITIONAL TOPICS DISCUSSED BY THE TWG**

The USDOT Task Force did not ask the TWG to review the subjects of training, partnering, and Intelligent Transportation Systems (ITS) in relation to railroad-highway grade crossing safety. However these subjects came up dur-

ing discussions, and the TWG developed recommendations.

Numerous organizations and agencies have training programs in place that include courses on railroad-highway grade crossings. Design and operation of railroad-highway grade crossing preemption have not been adequately covered. However, organizations are trying to respond to this need. Recent examples of new curriculum presented in Minnesota and Oklahoma include fundamental operation of traffic signals and railroad grade crossing warning system circuits and operation, preemption elements, and the factors to be considered when interconnecting the two systems.

To reduce near-collision situations, jurisdictions should consider partnering with traffic engineers, law enforcement, and railroad companies and crews. Many times near collisions are the result of gate running, a violation of the active warning devices at the crossings. Some railroad companies have agreed to try to identify license plates on offenders or allow law enforcement officers on the train. Operation Lifesaver has been a leader in promoting this effort.

Partnering with the judiciary to educate the judges on the hazards of grade crossing violations is necessary to ensure penalties are imposed. A key issue in grade crossing enforcement is the amount of the fine imposed upon the motorist committing the violation. California, Florida, Illinois, and several other States have passed legislation to increase fines for grade crossing violations.

Special brochures could be disseminated to law enforcement and judiciary personnel to raise the importance of enforcing and adjudicating railroad-highway grade crossing violations. The Los Angeles Sheriff's Department has developed a brochure for the law enforcement community, shown in Appendix P.

The ITS-based technology of photo enforcement is a tool that communities can use to enforce the law and eventually reduce the number of grade crossing violations, which could reduce the number of grade crossing crashes.

The TWG discussed the problem of how to improve detection when problems occur with the interconnection. Various methodologies were discussed, including the use of an indicator light on a traffic signal controller cabinet or applying ITS technology for monitored interconnected operations.

- 1) *The TWG recommends that organizations and agencies responsible for developing and conducting training incorpo-*

*rate the TWG recommendations into their curriculum on railroad-highway grade crossings.*

*2) The TWG recommends that practitioners consider the benefits partnering can play in improving safety at their rail-*

*road-highway grade crossings and use Operation Lifesaver resources and programs.*

*3) The TWG recommends that ITS technology be developed and evaluated for improved monitored interconnected operations.*



# **Appendix A**

**May 28, 1996, FHWA  
Memorandum to Field Offices**





U.S. Department  
of Transportation

**Federal Highway  
Administration**

# Memorandum

Subject: **ACTION: Rail-Highway Grade  
Crossing Safety**

Date: May 28, 1996

From: **Executive Director**

Reply to  
Attn. of: **HHS-20**

To: **Regional Administrators  
Division Administrators**

My March 8 memorandum distributed the report prepared by the DOT Grade Crossing Safety Task Force that Secretary Peña convened following the collision between a train and a school bus last October in Fox River Grove, Illinois.

The Task Force evaluated the processes covering a number of rail-highway grade crossing safety issues and offered in its report 24 recommendations that should help improve safety at grade crossings. The Secretary has adopted the Task Force's report and, in an April 9 memorandum (copy attached), requested that involved modal administrations aggressively follow up on those action items under their purview.

In Section VI of the report (Interconnected Signals and Storage), there are four short-term recommendations that require significant implementation activity by FHWA field offices. Guidance for implementation of these recommendations is attached.

The Office of Highway Safety will assume the lead for implementing other recommendations in the report for which FHWA is responsible. Headquarters offices are also assisting other modes and, if your support is requested, field offices should assist representatives of other DOT agencies in implementing recommendations for which those agencies have the lead.

The Secretary has requested the field staff of each involved DOT modal administration to work with each other as well as with State and local highway agencies and other State agencies to help implement the Task Force's recommendations. I urge each of you to personally visit with your State and local counterparts to ensure that the recommendations are implemented to the maximum extent feasible.

For further information on the implementing the Task Force's recommendations, please contact Mr. Fred Small in the Office of Highway Safety (202-366-9212) or Mr. Robert Winans in the Office of Engineering (202-366-4656).

A handwritten signature in black ink that reads "Tony Kane". The signature is written in a cursive style with a horizontal line above the name.

Anthony R. Kane

Attachments



U.S. Department of  
Transportation  
Office of the Secretary  
of Transportation

# Memorandum

Subject **Grade Crossing Safety Task  
Force Report of March 1, 1996**

Date **April 9, 1996**

From **Federico Peña** *Federico Peña*

Reply to  
Attn of

To **Rodney Slater  
Jolene Molitoris  
Ricardo Martinez  
Gordon Linton**

I would like to thank the members of your staff for their work on the Grade Crossing Safety Task Force. The Task Force developed 24 common sense recommendations which could go a long way toward improving highway-rail crossing safety. I support these recommendations, and ask that each of you aggressively follow up on action items under your purview.

The Task Force investigation clearly pointed to the need for a higher level of communication, education and coordination among Federal, State, local governments, and the private sector in preventing highway-rail accidents. The recommendations address both physical and procedural deficiencies that, if quickly acted upon and corrected, will strengthen our ability to reduce crossing accidents and fatalities.

You are aware grade crossing safety is of great concern to me, and I know I can rely on your implementation of the Task Force recommendations in a timely manner. Please ensure that your field staffs work closely with the States, railroads and other authorities to follow up.

DOT GRADE CROSSING TASK FORCE RECOMMENDATIONS  
FHWA FIELD IMPLEMENTATION GUIDANCE

Short-Term Recommendation No. 1

State transportation agencies (or other State agencies, if appropriate) should formally agree to be the focal point in the State to ensure proper coordination between highway authorities and railroads regarding the interconnection of grade crossing warning devices and highway traffic signals, and consideration of the storage distance between the tracks and the parallel highway. The responsibilities of the agency, as a focal point, would be to:

- (a) develop, distribute, and continually update a list of State and local highway authorities and railroad contacts who should be involved in the planning, design, construction, operation, and inspection of grade crossing warning devices interconnected with nearby highway traffic signals;
- (b) serve as a clearinghouse for collecting and disseminating to State and local highway authorities and railroads all pertinent information necessary for the planning, design, construction, and safe operation of grade crossings in close proximity to highway-highway intersections;
- (c) develop guidelines which recommend that, on at least an annual basis, State and local highway authorities and railroads and/or transit agencies conduct joint inspections of the timing and operation of highway traffic signals that are interconnected to nearby grade crossing warning devices; and,
- (d) coordinate with State/local school transportation officials, operators of public transit intercity buses, and trucking organizations to help ensure that drivers are familiar with the operation of interconnected signals and are aware of any storage space limitations at grade crossings on their routes. This information exchange would be carried out in cooperation with Operation Lifesaver.

Implementation Guidance

The key to the successful implementation of the Task Force's recommendations pertaining to interconnected signals and storage distance between grade crossings and nearby highway-highway intersections is the establishment of a focal point in the State to ensure proper coordination between highway authorities and the railroads. The unit or individual that could most effectively assume the role of the focal point will likely vary from state to state. In many states, it will be appropriate that the focal point be in the State DOT, while in others, it may be more logical for the focal point to rest in a State regulatory agency or other public body.

We suggest that each FHWA division office coordinate with the FRA regional safety program manager, and jointly meet with

appropriate State and local officials to encourage the designation of a focal point to facilitate an implementation strategy for this recommendation. For the meeting, you may want to involve, in addition to the obvious State DOT and/or regulatory agency officials, the Governor's Highway Safety Representative, the focal point for the State's Safety Management System, the Local Technical Assistance Program (LTAP) Center, and others you deem appropriate in your state. The responsibilities for the focal point suggested in (a) through (d) above are clearly stated and should be carefully considered when designating this position.

#### Short-Term Recommendation No. 2

*State and local highway authorities should initiate engineering studies to determine if safety improvements are warranted at grade crossings near highway-highway intersections where there is no interconnection and where there is limited storage distance. Emphasis should be given to locations with STOP sign control at the highway-highway intersection, where storage space is less than that required to accommodate the longest legal vehicle permitted to use the highway, and where accident potential is greater due to high volumes of highway and/or rail traffic.*

#### Implementation Guidance

Following the Fox River Grove incident, the NTSB recommended that State and local highway agencies review all crossings with interconnected signals to determine if they exhibited the same problems which apparently existed in Fox River Grove, and take corrective action where necessary. During these reviews, States discovered that there are numerous locations with limited storage space between the railroad tracks and nearby highway intersections. At many of these locations, the longest legal vehicle using the road crossing the tracks cannot be accommodated in the storage space without encroaching on the tracks. This situation is especially hazardous if there is a STOP or YIELD sign rather than a signal at the intersection.

Crossings with inadequate storage space should be identified--especially on school bus and hazardous materials carrier routes--and an engineering study undertaken by highway and railroad authorities to determine if improvements should be made. Priority should be given to those locations where there are high volumes of train traffic and/or heavy vehicular traffic on the crossroad and the parallel highway.

Implementing this recommendation will require a significant commitment of resources. However, due to the significance of the potential safety problem, we strongly encourage that this effort be undertaken. (One State has considered adding a "storage pad" on the shoulder of the road that runs parallel to the tracks. This would provide a possible escape area for a

vehicle stopped at the STOP sign if a train should approach the crossing before the vehicle could enter the main highway.)

Short-Term Recommendation No. 3

*State and local highway authorities, through coordination with the railroads, should ensure that storage space is a significant consideration early in the planning and design processes where physical changes are being proposed to the highway or railroad at interconnected signal locations.*

Implementation Guidance

As development flourishes and traffic volumes increase, especially in suburban areas, proposals are often made to widen roads that run parallel to a railroad. Many times, right-of-way constraints may dictate that all the widening be done on the railroad side of the road. When a highway improvement or railroad improvement is being considered in the vicinity of a grade crossing(s) that will result in a decreased storage distance between railroad tracks and a parallel highway, the consequences of this construction must be addressed in the planning and design processes. Division office personnel should ensure that procedures are in place so that this issue is routinely considered by planners and designers.

Short-Term Recommendation No. 4

*FHWA and FRA field staff should initiate regional conferences throughout the country for highway agencies and railroads to specifically discuss grade crossing safety issues, including interconnected signals and storage practices.*

Implementation Guidance

For a number of years, safety and engineering issues and funding matters relating to grade crossing improvements have been discussed in annual meetings held in Regions 3 and 4 and in joint Regions 5/7 meetings. Federal, State/local highway officials, railroads, and materials suppliers who attend these meetings all indicate that presentations on new technology and the exchange of information and ideas is valuable to the improved conduct of the grade crossing safety program.

We encourage that FHWA safety personnel in the regions not currently holding meetings, in coordination with your FRA counterparts, initiate regional meetings in FY 1997 similar to those currently held in Regions 3, 4, 5, and 7. You may want to contact your counterparts in those regions now holding meetings regarding meeting agendas, regional surveys, and meeting summaries. We believe the conduct of such meetings has the potential to significantly improve grade crossing safety, including the implementation of the Task Force's recommendations.



# **Appendix B**

## **Railroad-Highway Grade Crossing State Focal Points**



# DOT RAIL-HIGHWAY GRADE CROSSING

## STATE RR FOCAL POINTS

	Name	Title	Office	Address	Telephone
<b>Alabama</b>	Cecil W. Colson, Jr.		Alabama Department of Transportation	1409 Coliseum Boulevard Montgomery, AL 361230-3050	334-242-6450
<b>Alaska</b>	Gary Hogans	Chief	Engineering and Operations Department of Transportation and Public Facilities	3132 Channel Drive Juneau, AK 99801-7898	607-465-2960
<b>Arizona</b>	Dave Olivares		Traffic Operations Section Arizona Department of Transportation	1841 W. Buchanan Phoenix, AZ 85007	602-255-7751
<b>Arkansas***</b>	Bill Ryan	Railroad Crossing Coordinator	Arkansas State Highway and Transportation Department	P.O. Box 2261 Little Rock, AR 72203	501-569-2639
<b>California</b>	Kevin Elcock	Agreements Engineer	Caltrans Division of Structures	P.O. Box 942874 Sacramento, CA 94274-0001	916-227-8031
<b>Colorado</b>	Jack Baier	Transportation Engineer	Public Utilities Commission Department of Regulatory Agencies	Logan Tower, Office Level 3 1580 Logan Street Denver, CO 80203	303-894-2000 Ext. 350
<b>Connecticut</b>	Raymond Godcher		Connecticut Department of Transportation	2800 Berlin Trunpike P.O. Box 317546 Newington, CT 06131-7546	203-594-2710 Fax: 203-594-2714
<b>Delaware</b>	Joe Walder	Rail Specialist	Delaware Transit Cooperation Delaware Department of Transportation	P.O. Box 778 Dover, DE 19903	302-577-3278 Ext. 3452
<b>Dist. of Col.</b>	Rashid Sleenii	Chief	Traffic Safety and Data Analysis Branch Bureau of Traffic Services DC Department of Public Works	2000 14th St., N.W. Washington, DC 20007	202-939-8098
<b>Florida</b>	Fred Wise	Manager	Rail Office Florida Department of Transportation	605 Suwannee Street Tallahassee, FL 32399-0450	904-488-5704
<b>Georgia</b>	Bayne Smith	State Traffic Signal Engineer	Georgia Department of Transportation	525 Plasters Avenue Atlanta, GA 30324	404-894-9128
<b>Hawaii</b>	N.A.				

<b>Idaho</b>	E. Lee Wilson	Transportation Staff Engineer	Idaho Transportation Department	P.O. Box 7129 Boise, ID 83707	208-334-8561
<b>Illinois**</b>	Bernard L. Morris	Railroad Safety Program Coordinator	Railroad Safety Section Illinois Commerce Commission	527 East Capitol Avenue P. O. Box 19280 Springfield, IL 62794-9280	217-782-7660 Fax:217-785-7404
<b>Indiana**</b>	Steve Hull	Engineering Services Manager	Division of Design Indiana Department of Transportation	Indiana Government Center Room N 642 Indianapolis , IN 46204	317-232-5340 Fax:317-233-4929 E:USIDT119@IB MMAIL.COM
<b>Iowa</b>	Richard D. Brown		Maintenance Division Iowa Department of Transportation	800 Lincolnway Ames, Iowa 50010	512-239-1511
<b>Kansas</b>	Al Cathcart	Coordinator Engineer	Bureau of Design Kansas Department of Transportation	Docking State Office Building Topeka, KS 66612-1568	913-296-3431
<b>Kentucky</b>	Mal Baird	Asst. Director of Operations	Tennessee Department of Transportation	James K. Polk building 505 Deaderick Street, Suite 700 Nashville, TN 37243-0349	615-741-4838 Fax: 615-741-2508
<b>Louisiana**</b>	Bill Shrewsberry	Railroad Grade Crossing Programs Engineer	Louisiana Department of Transportation	P.O. Box 94245 Baton Rouge, LA 70804-9245	504-379-1543
<b>Maine</b>	Gerry Audibert	Safety Managment Coordinator	Bureau of Planning Maine Department of Transportation	State House Station 16 Augusta, Maine 04333	207-289-2841
<b>Maryland</b>	Robert Herstein	Team Leader Statewide Study Team	Office of Traffic Maryland Department of Transportation	P.O. Box 8755, Elm Road Baltimore-Washington International Airport, MD 21240	410-787-5867
<b>Massachusetts</b>	Richard Gardener	Rail-Highway Grade Crossing Program Engineer	Traffic Design and Operations Massachusetts Highway Department	10 Park Plaza Boston, MA 02116-3973	617-973-7369
<b>Michigan**</b>	Jerry Becker	Section Manager	Rail Safety Section Michigan Department of Transportation	State Transportation Building 425 W. Ottawa Street P. O. Box 30050 Lansing, MI 48909	517-335-2592 Fax:(517)373-0856

<b>Minnesota**</b>	Bob Swanson	Director of Railroad Administration	Minnesota Department of Transportation	Kelly Annex Transportation Building 395 John Ireland Boulevard, MS 470 St. Paul, MN 55155	612-296-2472 Fax:(612)297-1887 E:Robert.Swanson@dot.state.mn.us
<b>Mississippi</b>	Robert Merry	State Rail Engineer	Mississippi Department of Transportation	P.O. Box 1850 Jackson, MS 39215-1850	601-359-7910
<b>Missouri</b>	Rick Mooney		Division of Motor Carrier and Railroad Safety Department of Economic Development	Truman Building, Room 230 P.O. Box 1216 Jefferson City, MO 65102-0236	573-751-4040
<b>Montana</b>	Don Dusek	Traffic Engineer	Montana Department of Transportation	2701 Prospect Avenue Helena, MT 59620	406-444-6217
<b>Nebraska</b>	Steve Andersen	Intermodal Project Manager	Nebraska Department of Transportation	P.O. Box 94759 1500 Nebraska Highway 2 Lincoln, NE 68509-4759	402-479-3862
<b>Nevada</b>	Anita Boucher		Nevada Department of Transportation	1263 S. Stewart Street Carlson City, NV 89712	702-888-7462
<b>New Hampshire</b>	John V. Amrol	Railroad Coordinator	Utilities Section New Hampshire Department of Transportation	John O. Morton Building Hazen Drive, P.O. Box 483 Concord, NH 03302-0483	609-530-5683
<b>New Jersey</b>	William A. Fanelle	Manager	Bureau of Utilities New Jersey Department of Transportation	1035 Parkway Avenue Trenton, New Jersey 08625	609-530-5683
<b>New Mexico*</b>	Lester R. Cisneros	Railroad Utility Supervisor	New Mexico State Highway & Transportation Department	P.O. Box 1149 Santa Fe, NM 87503	505-872-5357
<b>New York</b>	John Bell	Director	Grade Crossing Program Commercial Transport Division New York Department of Transportation	1220 Washington Avenue State Campus Albany, New York 12232	518-457-1046
<b>North Carolina</b>	Drew Thomas		Traffic Engineering North Carolina Department of Transportation	P.O. Box 25201 Raleigh, NC 27611-5201	919-733-5564
<b>North Dakota</b>	Donald Laschewitsch	Rail Program Manager	Planning Division North Dakota Department of Transportation	608 E. Boulevard Avenue Bismarck, ND 58505-0700	701-328-4409

<b>Ohio</b>	Susan Kirkland	Supervisor, Rail Highway Safety Section	Division of Rail Ohio rail Development Commission	500 Broad Street, Room 1520 Columbus, Ohio 43215	614-644-0310
<b>Oklahoma*</b>	Joe R. Kyle, Jr.	Intermodal Division	Oklahoma Department of Transportation	200 NE 21st Street Oklahoma City, OK 73105-3204	405-521-2861
<b>Oregon</b>	Howard Fegles	Railroad & Utility Engineer	Oregon Department of Transportation	Transportation Bldg., Room 417 Salem, OR 97310	503-986-4094
<b>Pennsylvania</b>	Tom Bryon		Safety Division Department of Transportation	Traffic Safety Building 1220 Commonwealth and Foster Street Harrisburg, PA 17120	717-787-5574
<b>Puerto Rico</b>	N.A.				
<b>Rhode Island#</b>	J. Michael Bennett	Chief	Civil Engineer/Road Design Rhode Island Department of Transportation	State Office Building Providence, RI 02903	401-277-2023 Ext. 4021
<b>South Carolina</b>	Richard Jenkins	State Traffic Safety and Systems Engineer	South Carolina Department of Transportation	P.O. Box 191 Columbus, SC 29202	803-737-1454
<b>South Dakota</b>	Susan Tracy	Railroad Project Engineer	South Dakota Department of Transportation	700 East Broadway Avenue Pierre, SD 57501-3567	605-773-3567
<b>Tennessee</b>	Mal Baird	Asst. Director of Operations	Tennessee Department of Transportation	James K. Polk building 505 Deaderick Street, Suite 700 Nashville, TN 37243-0349	615-741-4838 F 615-741-2508
<b>Texas***</b>	Daren Kosmak	Railroad Liaison Engineer	Traffic Operations Division Texas Department of Transportation	125 East 11th Street Austin, TX 78701	512-416-2200
<b>Utah</b>	Lillian Witkowski		Utah Department of Transportation	4501 South 2700 West Salt Lake City, Utah	801-965-4286
<b>Vermont</b>	Boynton R. Saia	Rail/Highway Crossing Program Manager	Vermont Agency of Transportation	State Administration Building 133 State Street Montpelier, Vermont 05633	802-828-2087
<b>Virginia</b>	J. Linwood Butner		Traffic Engineering Virginia Department of Transportation	1221 East Broad Street Richmond, VA 23219	804-786-2702
<b>Washington</b>	Kevin Dayton	Utility/Railroad Engineer	Washington State Department of Transportation	Transportation Building Olympia, WA 98504	206-705-7375

<b>West Virginia</b>	Butch Gray		West Virginia Department of Transportation	1900 Kanahwa boulevard East Capitol Complex Bldg. 5 Charleston , WV 25305	304-558-3656
<b>Wisconsin**</b>	Joe Dresser	Director	Bureau of Railroads and Harbors	Hill Farm State Office Building 4802 Sheboygan Avenue Room 651 Madison, WI 53707	608-266-2941 Fax:608-267-3567
<b>Wyoming</b>	David R. Bryden	Utilities Manager	Wyoming Department of Transportation	P.O. Box 1708 Cheyenne, WY 82003-1708	307-777-4133

 = RR Focal Points Submitted

\* = Information from FRA

\*\* = Confirmed by FHWA

\*\*\* = Differences from FHWA

N.A. = Not Applicable

Info from FHWA: Eric Phillips  
Arkansas State Highway & Transportation Department (AHTD)  
10324 Interstate 30  
Little Rock, AR 72209  
or  
P.O. Box 2261  
Little Rock, AR 72203-2261  
Tel. # (501)569-2566

Mr. Tom Newbern, Director, Traffic Operation Division  
Texas Department of Transportation  
125 E. 11th Street  
Austin, Texas 78701-2483  
Phone:(512)416-3200  
Fax:(512)416-3214

5/12/97





# **Appendix C**

## **FRA Letter to Governors**





U.S. Department  
of Transportation  
**Federal Railroad  
Administration**

**Administrator**

**400 Seventh St., S.W.  
Washington, D.C. 20590**

APR 11 1997

The Honorable George W. Bush  
Governor of Texas  
State Capitol  
P.O. Box 12428  
Austin, Texas 78711

Dear Governor Bush:

At hearings before the U.S. House of Representatives Subcommittee on Transportation, Chairman Frank Wolf and I discussed contacting each State Governor regarding highway-rail crossing safety, in particular about the identification of crossings similar to the Fox River Grove, Illinois, site where a school bus and commuter train collided fatally injuring seven students.

The presence of a highway parallel to a railroad right-of-way should be of critical concern when planning, installing and maintaining signs and signals which regulate highway traffic over railroad tracks. At the highway-rail crossing in Fox River Grove, the stop line at the T-intersection with the parallel highway was just 30 feet from the railroad track. This is an untenable situation in that many legal highway vehicles, including school buses, exceed this available space and yet must stop for the intersection, either in compliance with highway signals (as was the case in Fox River Grove) or a STOP sign in order to await an opening in traffic on the parallel road. Similar crossings abound throughout our Nation. The report of the Department of Transportation's Grade Crossing Safety Task Force, Accidents That Shouldn't Happen (copy enclosed), recommends that:

State and local highway authorities should initiate engineering studies to determine if safety improvements are warranted at grade crossings near highway-highway intersections where there is no interconnection and *where there is limited storage distance*. Emphasis should be given to locations with STOP sign control at the highway-highway intersection, where storage space is less than that required to accommodate the longest legal vehicle permitted to use the highway, and where accident potential is greater due to high volumes of highway and/or rail traffic.

I am particularly concerned that crossings in rural areas, which may be off the State's highway system, may be overlooked. Whatever you can personally do to ensure that all such crossings in Texas are identified and reviewed will certainly aid in our efforts to reduce the toll which

highway-rail crossing collisions exact. Federal Railroad Administration (FRA) staff is eager to assist and can be reached by contacting FRA Regional Manager for Crossing Safety Programs David Visney in Hurst, Texas, on (817) 284-8142.

There were fewer collisions and casualties at highway-rail crossings in this country in 1996 than any previous year for which we have records. This is the second consecutive year significantly lower levels have been reported. This accomplishment was brought about in part by the commitments of former Secretary of Transportation Federico Pena and his modal Administrators, including then-Federal Highway Administrator and now Secretary, Rodney E. Slater, to make highway-rail crossing safety a national priority. This priority will not change. Four DOT modal Administrations are implementing the 55-point initiative to attack this tragic and preventable loss of life. I have enclosed a copy of this Action Plan for your review. While accident rates are declining, our goal is zero tolerance for any hazard resulting in injury or death. By working together with you and other Governors (as outlined in the enclosed reports), we believe we can continue to improve safety at highway-rail crossings. I look forward to your active participation in this crucial safety partnership.

Sincerely,

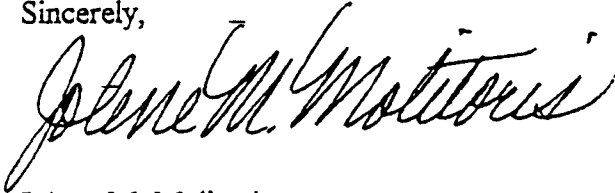
A handwritten signature in cursive script that reads "Jolene M. Molitoris". The signature is written in dark ink and is positioned above the printed name and title.

Jolene M. Molitoris  
Administrator

Enclosures

# **Appendix D**

## **Joint Inspection Form**



RAILROAD DEVICES - HIGHWAY TRAFFIC SIGNALS  
ANNUAL INTERCONNECT INSPECTION FORM

Date: \_\_\_\_\_

Inspection Team:

1. State agency having jurisdiction over interconnected systems.
2. Railroad responsible for maintenance of railroad warning devices.
3. Highway agency, and their contractor if applicable, responsible for maintenance of highway traffic signals.
4. Highway agency responsible for maintenance of roadway over track(s).
5. FRA grade crossing signal inspector or State certified grade crossing signal inspector.

Location: \_\_\_\_\_  
(street across tracks) <sup>e</sup> (parallel street)

\_\_\_\_\_ <sup>e</sup> \_\_\_\_\_  
(in/near, city) (county)

Railroad: \_\_\_\_\_ Line Name: \_\_\_\_\_

AAR/DOT#: \_\_\_\_\_ No. & Type of Tracks: \_\_\_\_\_

\_\_\_\_\_  
(main, siding, etc.)

Type Warning Devices: \_\_\_\_\_

Type Control Circuitry \_\_\_\_\_  
For Each Track:

\_\_\_\_\_  
(d.c., motion, cwt, etc.)

Railroad Controller \_\_\_\_\_ Standby Units: \_\_\_\_\_  
Make/Model Name: \_\_\_\_\_ (yes/no)

\_\_\_\_\_  
(list for each track)

Simultaneous Preempt: \_\_\_\_\_ Advance Preempt: \_\_\_\_\_ @ \_\_\_\_\_ sec.  
(yes/no) (yes/no)

Interconnected Line Circuit Normally Energized & Thru Closed  
Relay: \_\_\_\_\_  
(yes/no)

Circuit Length For Each \_\_\_\_\_  
Train Direction Per \_\_\_\_\_  
Track: \_\_\_\_\_

Do Trains Stop, Accelerate, or Decelerate Within Approach  
Circuits: \_\_\_\_\_ IF Yes Explain Reason(s): \_\_\_\_\_ (e.g. block/  
(yes/no) \_\_\_\_\_  
CTC/Cab signals, passenger stations, interlocking plants, etc.) \_\_\_\_\_  
\_\_\_\_\_  
\_\_\_\_\_  
\_\_\_\_\_

Max. Train Speeds: \_\_\_\_\_  
(for each track & train direction if different)

Minimum Warning Time Per System Design: \_\_\_\_\_

Warning Time Witnessed (if train present): \_\_\_\_\_

Are Near-Side Traffic Signals Present: \_\_\_\_\_  
(yes/no)

Do Pedestrian Signals Exist: \_\_\_\_\_ If Yes, Which Legs and  
(yes/no) \_\_\_\_\_  
Length of Crosswalk(s): \_\_\_\_\_  
\_\_\_\_\_  
\_\_\_\_\_

And

Is Ped. Walk Time Shortened To Design Time When RR Preemption  
Occurs: \_\_\_\_\_  
(yes/no)



Hwy. Controller (make/model): \_\_\_\_\_

Does Hwy. Controller Have New Software Which Allows Controller to Acknowledge Consecutive RR Preempts Calls At Any Time During Traffic Signal Preemption Cycle.: \_\_\_\_\_  
(yes/no)

Are Traffic Signals Part of a Traffic Signal System: \_\_\_\_\_  
(yes/no)

Verify Preemption Phase Sequence Settings Against Approved Design Timings.

	Field Setting	Approved Design
Delay:	_____sec.	_____sec.
Ped Clear (if included):	_____sec.	_____sec.
Min. Green:	_____sec.	_____sec.
Yellow Interval:	_____sec.	_____sec.
All Red Interval:	_____sec.	_____sec.
Track Clear Green:	_____sec.	_____sec.

Does Emergency Vehicle Priority System (EVPS) Exist: \_\_\_\_\_  
(yes/no)

Does RR Preempt Have Priority Over EVPS: \_\_\_\_\_  
(yes/no)

Are Preemption Blank-Out Signs Operational: \_\_\_\_\_  
(yes/no) or (n/a)

Distance From Intersection To Near Rail Of Crossing: \_\_\_\_\_

Distance From Intersection To Hwp. Traffic Signa Stop Bar: \_\_\_\_\_

Distance Between Tracks (far rail to far rail): \_\_\_\_\_

Distance From RR Stop Line To Near Rail: \_\_\_\_\_

(Note for skewed crossings measure the above distances 1) along center line and 2) along edge of outermost lane.)

Is RR Stop Line At Optimum Location For Motorists' Visibility Of

Approaching Trains:\_\_\_\_\_

(yes/no)

Has RR Stop Line Been Moved Further From Track(s), Compared To  
Design Location, Since Last Inspection:\_\_\_\_\_

(yes/no)

OPERATIONAL TEST

1) Activate RR Devices And Determine:

Advance Preempt Call Starts: \_\_\_\_\_sec. Before RR Flashing Signal Operation.

Or

Simultaneous Preempt Call Starts When Flashing Signals Begin To Operate: \_\_\_\_\_  
(yes/no)

Flashing Signals Operate \_\_\_\_\_sec. before Gates Begin To Lower.

Flashing Signals Operate \_\_\_\_\_sec. before Gates are Horizontal.

Preempt Call Ends After: Gates Begin To Raise: \_\_\_\_\_  
(yes/no)

or

Gates Reach Vertical: \_\_\_\_\_  
(yes/no)

2) Activate RR Devices At Start Of Longest Traffic Signal Phase To Get To Track Clear Green. Verify Observed Traffic Signal Preemption Sequence Timings Against Approved Design Timings.

	OBSERVED	APPROVED DESIGN
Delay:	_____sec.	_____sec.
Ped Clear (if included)	_____sec.	_____sec.
Yellow Interval:	_____sec.	_____sec.
All Red Interval:	_____sec.	_____sec.
Max. Time To Green:	_____sec.	_____sec.
Track Clear Green:	_____sec.	_____sec.

3) Terminate Preempt Call after Traffic Signals Are in Track Hold Phase And Then Reactivate RR Devices Approx. 2-3 Seconds Later And Test System For Second Train Scenario.

	OBSERVED	APPROVED DESIGN
Delay:	_____sec.	_____sec.
Ped Clear (if included)	_____sec.	_____sec.
Yellow Interval:	_____sec.	_____sec.
All Red Interval:	_____sec.	_____sec.
Max. Time To Green:	_____sec.	_____sec.
Track Clear Green:	_____sec.	_____sec.

If applicable:

- a) verify railroad and highway traffic contacts and telephone numbers are current as posted in the traffic signal controller cabinet and railroad bungalow.
- b) verify if indicator light(s) are operational when railroad preemption circuit is activated.
- c) verify remote monitoring of railroad crossing warning devices or traffic signals is operational.

Comments (Regarding deficiencies found or changes/improvements warranted): \_\_\_\_\_

---

---

---

---

---

---

---

---

# **Appendix E**

## **Interconnect Warning Placard**



# WARNING!

Highway-Rail Grade Crossing  
Warning System and Highway  
Traffic Signals are  
Interconnected.

**BEFORE MODIFICATION** is made to any operation which connects to or controls the timing of an active railroad warning system and/or timing and phasing of a traffic signal the appropriate party(ies) shall be notified and, if necessary, a joint inspection conducted.

U.S. DOT/AAR Crossing Number: \_\_\_\_\_

1. Highway Agency: \_\_\_\_\_

Phone Number: \_\_\_\_\_

2.. Railroad: \_\_\_\_\_

Phone Number: \_\_\_\_\_

3. Other: \_\_\_\_\_

Phone Number: \_\_\_\_\_



U.S. Department of Transportation  
Federal Railroad Administration  
Federal Highway Administration  
Federal Transit Administration  
National Highway Traffic Safety Administration

# WARNING!

Highway-Rail Grade Crossing  
Warning System and Highway  
Traffic Signals are  
Interconnected.

**BEFORE MODIFICATION** is made to any operation which connects to or controls the timing of an active railroad warning system and/or timing and phasing of a traffic signal the appropriate party(ies) shall be notified and, if necessary, a joint inspection conducted.

U.S. DOT/AAR Crossing Number: \_\_\_\_\_

1. Highway Agency: \_\_\_\_\_

Phone Number: \_\_\_\_\_

2. Railroad: \_\_\_\_\_

Phone Number: \_\_\_\_\_

3. Other: \_\_\_\_\_

Phone Number: \_\_\_\_\_



U.S. Department of Transportation  
Federal Railroad Administration  
Federal Highway Administration  
Federal Transit Administration  
National Highway Traffic Safety Administration





# **Appendix F**

## **Annotated Bibliography**



## **Annotated Bibliography on Railroad Grade Crossing Design and Safety Related Literature**

This bibliography was developed in conjunction with the final report of the technical working group. Four primary subject areas considered by the technical working group were interconnected traffic signals near highway-rail crossings, high profile crossings, light-rail crossing issues and special vehicle operations and related information. Other issues discussed included coordination efforts between various parties involved with identifying and maintaining equipment at the highway-rail crossing. The bibliography is segmented into various subjects listed below. The individual citations are listed chronologically within each subject group. There may be an overlap of discussion in some of the references.

- I. GENERAL**
- II. INTERCONNECTED TRAFFIC SIGNAL DESIGN AND PREEMPTION**
- III. HIGH PROFILE CROSSINGS (GEOMETRIC DESIGN)**
- IV. LIGHT RAIL TRANSIT (LRT)**
- V. SPECIAL VEHICLE OPERATIONS (Trucks, Buses, Hazardous-Material Vehicles)**
- VI. MAINTENANCE, MALFUNCTIONS, AGENCY COORDINATION and CROSSING IDENTIFICATION**
- VII. WARNING TIME**
- VIII. CROSSING CONTROL DEVICES (Signs, Markings, Use of Traffic Signals in lieu of Flashers, Barrier Medians, 4 Quadrant Gates)**
- IX. INTELLIGENT TRANSPORTATION SYSTEMS (ITS) and FUTURE TRAFFIC CONTROL**

The literature search has focused on primary reports of research or topic material. Some references are included as companion reports to the main document. References that merely announce the publication or availability of specific base research papers and documents were not included, unless the paper could not be located within the time frame imposed by development of this bibliography and the subject material was considered appropriate to note.

Where abstracts or summaries were known to be provided by the authors, these have been included as published. Sources of the abstracts are coded as follows: AUTHOR - from the paper; TRIS - Transportation Information Services Database, Transportation Research Board; ITE - Institute of Transportation Engineers; RICHARDS - Hoy A. Richards and Associates, Transportation Specialists, Library; ANNOTATION - developed by the TWG.

## I. GENERAL

1. Miller, L.S., Editor. *GRADE CROSSING SAFETY: LESSONS FROM FOX RIVER GROVE*. Railroad Age. March 1997. pp 47-50.

ANNOTATION: By raising the level of public awareness, and encouraging harsh penalties for crossing-safety violations, a tragic school bus accident reduced crossing incidence locally, and possibly nation wide. Crossing accidents, injuries, fatalities have been on a downward trend for several reasons: twenty-five years of operation life saver program, railroads and their suppliers developing increasingly effective warning systems, Crossing safety initiatives of the FRA and FHWA, and \$115 million a year funding from Section 130 of the Intermodal Surface Transportation Efficiency Act (ISTEA) provided warning systems. One demonstration project highlighted in the article concerned a "sealed corridor" project in North Carolina. Four-quadrant gates and median barriers were tested. A 'violator' camera system recorded violations. The baseline average of 40 violations per week during a 20 week before period was reduced to 10 violations per week when median barriers were installed, six violations per week with four-quadrant gates, and one violation per week with the combination of four-quadrant gates and median barriers. The NTSB Fox River Grove accident report findings were summarized, with most recommendations concerning better communication, among the multitude of highway and railroad personnel.

2. *ACCIDENTS THAT SHOULDN'T HAPPEN: A REPORT OF THE GRADE CROSSINGS SAFETY TASK FORCE TO SECRETARY FEDERICO PENA*. Grade Crossing Safety Task Force, Department of Transportation. Washington, D. C.: March 1996. 17p.

TRIS Abstract: This final report of the Grade Crossing Safety Task Force was developed following the tragic accident of October 25, 1995, in Fox River Grove, Illinois. Seven students lost their lives when the school bus they were riding in was struck by a commuter train. Representatives of the Federal Railroad Administration, the FHWA, the FTA, and the National Highway Traffic Safety Administration collectively took up the task to examine grade crossing safety and to formulate recommendations to help prevent tragedies such as occurred at Fox River Grove from happening again. The findings and recommendations are documented in this report.

The report explains how a lack of information and/or guidelines in the design, construction, operation, maintenance, and inspection of grade crossings led the task force to identify the following 5 safety problem areas for detailed examination: interconnected signals; vehicle storage space; high-profile crossings; light rail transit crossings; and special vehicle operations. Each of the 5 problem areas is discussed separately along with the lessons learned. The report recommends 24 specific follow-on actions to address both physical and procedural deficiencies. Reliance on existing opportunities is emphasized by recommendations that encourage grade crossing safety through coordinated inspections, law enforcement, and driver education. To implement these recommendations the task force has identified immediate steps that the Department will take to work with their constituents in defining a cooperative strategy for improving grade crossing safety. Overall, the principal finding of this report is consistent with and fully supports that of the Rail-Highway Crossing Safety Action Plan announced by the Secretary in 1994, namely: improved highway-rail grade crossing safety depends upon better

cooperation, communication, and education among responsible parties if accidents and fatalities are to be reduced significantly.

3. AAR Communication and Signal Division. *HIGHWAY GRADE CROSSING WARNING SYSTEMS, IN SIGNAL MANUAL, SECTION 3*. Association of American Railroads. Washington, D. C.: 1996.

ANNOTATION: Part 3.3.10 provides recommendations with instructions to calculate the approach warning time for railroad activated warning devices at highway grade crossings. Minimum Warning Time (MWT), Clearance Time (CT) Adjustment Time (AT), Buffer Time (BT) are explained.

Supplemental Note: This publication is available in four printed volumes and also on CD ROM from the Association of American Railroads, 50 F Street, NW, 7th Floor, Washington, D. C. 20001; Price \$200 - Member, \$400 - Non-Member, as of 1 May 1997.

4. Bartoskewitz, R.T., Fambro, D.B. and Richards, H.A. *TEXAS HIGHWAY-RAIL INTERSECTION FIELD REFERENCE GUIDE, FINAL REPORT*. Report No. FHWA/TX-94/1273-2F, Federal Highway Administration. Washington, D. C.: May 1994. 164p.

TRIS Abstract: The design, construction, operation, and maintenance of highway-rail intersections present unique challenges to both highway and railroad engineers. The railroad grade crossing represents the physical intersection of two distinctly different modes of transportation, each of which varies considerably in terms of their equipment, traveled ways, and methods of control and operation. Safety at highway-rail intersections has been a national priority for over two decades. Substantial reductions in crashes, injuries, and fatalities have been realized as a result of grade crossing improvement programs. Grade crossing safety has reached a point where further safety improvements will likely require the development of new approaches and innovative technologies. Proper design and construction of new grade crossings ensures safe and efficient operation. Proper maintenance of existing crossings helps to achieve continued safety and efficiency. The field guide has been developed to assist agencies responsible for the design, construction, operation, and maintenance of highway-rail intersections in the performance of these responsibilities. It is a reference source for city, county and state personnel that must address these issues as part of their official duties. Railroad personnel will find the reference guide helpful in obtaining a basic understanding of highway and traffic engineering concerns with regard to highway-rail intersections. The guide includes information on special programs and activities, and key reference documents.

5. *HIGHWAY-RAIL SIGNAL TERMINOLOGY*. The Highway and Rail Safety Newsletter, Richards & Associates. College Station, TX.: October 1993. pp 9-10.

ANNOTATION: Selected terms of railroad signal circuits are defined and explained. Some of the terminology are patented names. A brief synopsis is included in this annotation: (1) Audio Frequency Track Circuit -- Alternating current electrical energy in the audio frequency range; (2) Constant Warning Time (CWT) -- audio frequency track circuit systems used to sense train

movement in the vicinity of a grade crossing; (3) Motion Sensor -- An audio frequency track circuit system used to sense train movement toward a grade crossing; (4) ESR - WSR Circuits -- An interlocking logic circuit utilizing conventional track circuits through and adjacent to a crossing; (5) Insulated Joint -- Where two rails are joined together, end-to-end, by bolts with insulation placed between the rails and joining bars to prevent the flow of electrical energy from one rail to the next; (6) Broad Band Shunt (wide band shunt) -- A selective circuit element designed to present low impedance to all frequencies of alternating current energy and a high impedance to direct current energy; (7) Narrow Band Shunt -- A selective circuit element designed to present low impedance to a selected narrow band of alternating current frequencies and a high impedance to direct current and all other alternating current frequencies; (8) Uni-Directional Application -- The use of two separate motion sensing units attached to the track on opposite sides of a pair of insulated joints at a crossing; each unit senses motion in one direction only from the crossing; (9) Bi-Directional Application -- The use of one motion sensing unit at a crossing to sense motion in both directions from the crossing; (10) XR Relay -- Standard signal nomenclature applied to the relay at a crossing which, when de-energized, applies energy to warning devices indicating the approach of a train. Reference to the article is encouraged for further explanation of these terms.

6. *RAIL-HIGHWAY CROSSINGS STUDY. REPORT OF THE SECRETARY OF TRANSPORTATION TO THE UNITED STATES CONGRESS.* Report No. FHWA-SA-89-001, Federal Highway Administration. Washington, D. C.: April 1989.

TRIS Abstract: The last report to Congress on rail-highway crossing safety was in 1971-72. Since then, several actions and changes have occurred. These are discussed in the Executive Summary which is included in this report. This discussion is followed by 8 chapters. Chapter 1 first outlines the legislative requirements of the report and discusses the consultations that took place in carrying out the study. It then offers an overview of the history of the rail-highway crossing, from the beginning of the railroads to the current situation. Chapter 2 examines the rail-highway crossing today. Among the issues discussed are the basic railroad and highway networks, the characteristics of rail-highway crossings, and the accidents occurring at crossings. In addition, highlights of rail-highway crossing research conducted since 1972 are presented. Chapter 3 looks at the responsibilities of varying levels of government and the railroads at the crossing, and what the different responsible entities are doing to ensure that today's crossing is safe. Included are discussions of funds expended for crossing improvements and the division of improvement and maintenance costs between Federal, State, and local governments, and railroads. Chapter 4 looks at crossing safety in terms of warning systems, the correlation of crossing conditions with accidents, the effectiveness of devices, and alternative solutions (including addressing needs on a corridor basis). Chapter 5 examines how the roadway user's behavior plays a significant role in crossing safety. Chapter 6 reviews other impacts of the crossing, such as its impact on highway mobility, the community, and special systems, as well as other areas related to crossings. Chapter 7 estimates the financial needs necessary for a safe and efficient physical environment at crossings. Needs estimates include the initial and continuing costs of effectively maintaining the current systems and assessments of potential benefits and costs of major safety improvements in terms of national goals. The final chapter summarizes the findings of this study on each of nine identified issues, as well as other issues identified during

the course of the study.

7. *MANUAL ON UNIFORM TRAFFIC CONTROL DEVICES FOR STREETS AND HIGHWAYS--PART VIII-TRAFFIC CONTROL SYSTEMS FOR RAILROAD-HIGHWAY GRADE CROSSINGS*. Federal Highway Administration. Washington, D. C.: 1988.

TRIS Abstract: This section of the complete MUTCD includes all authorized traffic control devices and systems which regulate, warn or guide highway traffic at highway-railroad grade crossings. This National Standard covers the following topics relative to Traffic Control Systems at such locations and is divided in four main sections: 1) General: Functions; Use of Standard Devices; Uniform Provisions; Crossing Closure; Traffic Controls During Construction and Maintenance. 2) Signs and Markings: Purpose; Railroad crossing Signs; Railroad Advance Warning Sign; Pavement Markings; Illumination at Grade Crossings; Exempt Crossing Signs; Turn Restrictions; DO NOT STOP ON TRACKS Sign; STOP signs at Grade Crossings; TRACKS OUT OF SERVICE sign. 3) Signals and Gates: Purpose and Meaning; Flashing Light Signal--Post Mounted; Flashing Light Signal--Cantilever Supported; Automatic Gate; Train Detection; Traffic Signals at or Near Grade Crossings; Component Details. 4) Systems and Devices: Selection of Systems and Devices.

Supplemental note: This document is available from the U.S. Government Printing Office, P. O. Box 371954, Pittsburgh, PA 15250-7954; Stock number 650-001-00001-0; price \$44, as of 1 May 1997.

8. Tustin, B.H., Richards, H., McGee, H. and Patterson, R. *RAILROAD-HIGHWAY GRADE CROSSING HANDBOOK-2ND EDITION*. Report No. FHWA TS-86-215, Federal Highway Administration. Washington, D. C.: September 1986. 273p.

AUTHOR Abstract: Rail-Highway grade crossing safety and operational problems involve two components--the highway and the railroad. The highway component involves drivers, pedestrians, vehicles and roadway segments in the vicinity of the crossing. The railroad component involves the trains and the tracks at the crossing. The element of risk present at a given location is a function of the characteristics of the two components and their corresponding elements. Several formulas are described which seek to quantify the degree of risk, identify the locations most urgently in need of improvement, and prioritize the hazardous locations which have been isolated. Various types of at-grade crossing improvements described include active warning devices, passive warning devices, sight distance improvements, operational improvements and crossing surface improvements. Grade separations, or crossing closures are suggested as improvement solutions where either extremely high or low demand for the crossing exists. The ultimate choice for a crossing improvement is determined by balancing the benefits in accident reduction and reduced user costs against costs for the improvement. Procedures, models and computer programs which will assist making these selections are described.

Supplemental Note: This document is available from the National Technical Information Service, 5285 Port Royal Road, Springfield, VA. 22161; publication No. PB87137527, Domestic Price - \$55, microfiche-\$12.50, as of 1 May 1997. A contract has been awarded to develop an updated,

3rd edition.

9. *TRAFFIC CONTROL DEVICES HANDBOOK--PART VIII-TRAFFIC CONTROL SYSTEMS FOR RAILROAD-HIGHWAY GRADE CROSSINGS*. Federal Highway Administration. Washington, D. C.: 1983.

ANNOTATION: The Traffic Control Devices Handbook was primarily intended to augment the MUTCD, interpret its function and link MUTCD standards and warrants with activities related to compliance with the national uniform standards. The Handbook did not establish Federal Highway Administration (FHWA) policies or standards, and indicated standard textbooks should be used to detail basic engineering and design techniques. The Handbook offered guidelines for implementing the standards and applications contained in the Manual. Part VIII topics included: 1) General: Introduction; Types and Purposes of Devices; Driver Behavior and Needs -- Approaching the Crossing, Within the Critical Stopping Distance Zone, and Crossing the Tracks; Driver Detection of an Approaching Train; Pedestrian Behavior and Needs; Railroad Operations -- Types of Train Movements, Train Speed; Grade Crossing Responsibility -- Jurisdiction, Legal Considerations. 2) Application: Passive Devices -- Signs, Pavement Markings; Active Devices -- Flashing Light Signals, Automatic Gate, Signal Bells, Active Advance Warning Sign, Flagging, Traffic Signal At or Near Grade Crossings, Special Situations, Train Detection; Improvement Choices -- Hazard Identification, Improvement Alternatives, Diagnostic Team, Program Development and Implementation. 3) Operations and Maintenance: Sight Distance -- Minimum Sight Triangle, Obstructions; Drainage; Illumination; Barriers; Crossing Surfaces; Driver Education; Enforcement. 4) References.

Supplemental Note: This document is out of print and no longer available.

10. Coleman, J.A. and George, B.F. *NATIONAL RAILROAD-HIGHWAY CROSSING INVENTORY*. Public Roads. September 1983. pp 66-68.

ANNOTATION: The article provided background and status information on the National Railroad-Highway Crossing Inventory and attempted to encourage states and railroad companies to continue participation in the program. Directed by Association of American Railroads and American Short Line Association, railroads were responsible for obtaining site specific inventory information, installing and maintaining a unique identification number plate at each crossing, and updating railroad information. Assisted by FHWA, state highway agencies provided site specific highway information for each public crossing and were responsible for updating highway inventory information. Other state and local agencies were encouraged to participate. The computer based file was conceived and completed in a time period of 1972-1975. Over 400,000 public and private at-grade and grade-separated railroad-highway crossing sites were numbered and inventoried. The inventory file is used extensively by Federal, State, Railroad company program managers, public and private researchers, consulting engineers, industry, and private litigants. The file is a key input to USDOT railroad-highway crossing research allocation procedures and accident prediction formulas. In 1978, the National Highway Traffic Safety Administration added the Railroad-Highway Crossing and Identification Number to its fatal accident reporting system (FARS). The credibility of inventory file should be maintained since it



is crucial to the continuance of railroad-highway crossing safety programs. Inventory files are valuable tool in safety research and federal, state, and railroad planning efforts.

## **II. INTERCONNECTED TRAFFIC SIGNAL DESIGN AND PREEMPTION**

1. ITE Technical Committee 4M-35. *PREEMPTION OF TRAFFIC SIGNALS AT OR NEAR RAILROAD GRADE CROSSINGS with ACTIVE WARNING DEVICES*. Institute of Transportation Engineers, Recommended Practice. Washington, D. C.: June 1997.

ANNOTATION: Technology advances, MUTCD and Railroad-Highway Grade Crossing Handbook revisions, publication of the Traffic Control Devices Handbook all prompted review and update of the original 1979 recommended practice. Preempting traffic signals for railroad crossings on both public and private highways is complex and often unique. The traffic engineer designing a preemption system must understand how the traffic controller unit operates, and consult with railroad personnel to ensure that appropriate equipment is specified so both installations operate properly, with full compatibility. Continuous cooperation between highway and railroad personnel is essential for safe operation. Light rail transit operating on semi-exclusive right-of-way at high speeds at grade crossings should also be include. Important recommendations include: (1) Develop a cooperative design process and operating procedure that includes notifying other parties of anticipated or proposed traffic or geometric changes, and maintain continuous, joint reviews among participating parties to ensure satisfactory operation; (2) Distance separating tracks from the signalized intersection must be carefully evaluated, and traffic and geometric conditions must be reviewed and analyzed; (3) Total time required to complete the preemption sequence and the railroad warning time must be analyzed, and traffic control equipment for both highway and railroad must be properly utilized. These recommendations provide guidelines to be applied to the design, operation and maintenance of each traffic control system. Tables and Figures illustrate traffic signal sequence examples and comparative times for railroad active warning operation and highway traffic signal preemption.

Supplemental Note: This publication is available from the Institute of Transportation Engineers, 525 School Street, S.W., Suite 410, Washington, D. C. 20024-2797; publication No. RP-025A, Price \$15-Members, \$20- Non-Members, as of June 1997.

2. DuVivier, C.L., Rogers, L.M., Sheffield, W. and Foster, H.J. *POTENTIAL MEANS OF COST REDUCTION IN GRADE CROSSING MOTORIST-WARNING CONTROL EQUIPMENT. VOLUME I. OVERVIEW, TECHNOLOGY SURVEY AND RELAY ALTERNATIVES*. Report No. HS-022 691 FRA/ORD-77/45-I, Federal Railroad Administration, Office of Research and Development. Washington, D.C.: December 1977. 178 p.

TRIS Abstract: The results of a recent study of railroad-highway grade crossing warning system technology are presented. Emphasis in the investigation was placed on the determination of the potential for significant reduction in equipment, installation and maintenance costs through improvements sought within a framework of the basic (track circuit) system concepts now prevalent. This study comprises a comprehensive survey of current practices and hardware, an

analysis of all major cost elements, and a consideration of potentially beneficial technical changes. The effort is concentrated on the equipment involved in train detection and the activation of warning devices. Special attention is given to European practices. The applicability of European signal relays and of mercury-wetted reed relays to the North American situation is analyzed.

3. Marshall, P.S. and Berg, W.D. *DESIGN GUIDELINES FOR RAILROAD PREEMPTION AT SIGNALIZED INTERSECTIONS*. ITE Journal, Institute of Transportation Engineers. February 1997. pp 20-25.

AUTHOR Abstract: Preemption of traffic signal controllers near railroad grade crossings equipped with active warning devices is often required because queues from the intersection can extend back over the tracks, thereby creating the potential for a serious vehicle-train accident. Current textbooks, manuals and other references contain minimal information regarding preemption timing and design. The purpose of this article is to present guidelines for determining when a preemption capability is required at isolated intersections, and for calculating the duration of the preemption timing intervals.

4. Heathington, K.W. *INTERCONNECTING ACTIVE TRAFFIC CONTROL DEVICES AT RAILROAD-HIGHWAY GRADE CROSSINGS WITH HIGHWAY SIGNALS AT INTERSECTIONS*. Proceedings: Third International Symposium on Railroad-Highway Grade Crossing Research and Safety. Knoxville, TN. 24-26 October 1994. pp 9-38.

ANNOTATION: When a railroad-highway grade crossing is located close to a highway intersection, some operating characteristics of the two types of intersections can have a negative impact upon the level of safety provided to the traveling public. Two situations are described that can reduce the level of safety when the railroad-highway grade crossing and the intersection are close together. One is when a vehicle becomes trapped on a track due to the length of the queue of vehicles stopped at a highway intersection traffic signal. The other situation can occur when a vehicle has the right-of-way through a highway intersection (i.e., a green phase), and upon exiting the intersection, does not have sufficient time and distance to bring the vehicle to a safe stop before reaching the crossing. The amount of time and distance needed is a function of the speed of the roadway. When the railroad-highway grade crossing and highway intersection are too close together to permit adequate stopping distance, the result can be a train-vehicle collision. The paper addresses the latter safety issue but does not intend to minimize the safety issue of becoming trapped on a crossing due to vehicles queued for a stopped condition at a highway intersection.

5. Wu, J. and McDonald, M. *TRGMSM: THE SIMULATION MODEL FOR LIGHT RAIL TRANSIT (LRT) AT-GRADE CROSSING DESIGN*. Proceedings: Third International Symposium on Railroad-Highway Grade Crossing Research and Safety. Knoxville, TN. 24-26 October 1994. pp 61-72.

AUTHOR Abstract: This paper describes the characteristics and applications of simulation model, TRGMSM which has been developed to study the at-grade operation of Light Rail

Transit (LRT) at signalized intersections. TRGMSM is an object oriented microscopic simulation model, which has been specifically developed to study the interactions between at-grade LRT and normal road traffic, and has been calibrated against UK data. Each road vehicle is modeled using traditional microscopic modeling techniques that incorporate both driver behaviors and vehicle characteristics with a total of more than 30 attributes such as car following, lane changing, gap acceptance, brake reaction time, amber reaction behavior, etc.. The integrated microscopic modeling of LRT includes the various elements uniquely associated with at-grade operation LRT, such as different station locations and various priority measures and detections, which normally cannot be fully considered by existing network models. The on-line screen presentation of the simulated processes can help model users to understand the simulation and programmers to calibrate and validate the model. The simulation results indicate that giving LRT high priority does not necessarily cause significant extra vehicle delay, but can substantially reduce total person delay. Also, variations in the location of LRT stations were found to effect delay, particularly in person delay.

6. Marshall, P.S. and Berg, W.D. *EVALUATION OF RAILROAD PREEMPTION CAPABILITIES OF TRAFFIC SIGNAL CONTROLLERS*. Transportation Research Record 1254, Transportation Research Board. Washington, D.C.: 1990. pp 44-49.

AUTHOR Abstract: The subject of railroad preemption has historically not received much attention in professional literature. All aspects of preemption need to be studied and reported on in greater detail. This research examined and compared the preemption capabilities of a number of currently marketed actuated traffic signal controllers based on the National Electrical Manufacturers Association standard. Shortcomings in their preemption logic were identified, and preemption issues were discussed in terms of their operations. The evaluation was conducted from a pragmatic point of view to determine whether modern controllers allow practical and reasonable preemption design in conformance with accepted traffic engineering practice. Recommendations are offered with respect to minimum desirable operational capabilities, as well as railroad preemption nomenclature and user documentation.

7. *CREDIBILITY AND RELIABILITY OF GRADE CROSSING WARNING DEVICES*. Highway and Rail Safety Newsletter. Richards & Associates. College Station, TX.: July 1984. pp 3-4.

ANNOTATION: The newsletter presents a summary of a paper entitled "Credibility and Reliability through Engineering" presented by D.F. Remaley, Vice President of Safetran Systems Corp., at a Florida DOT Secretary's Railroad Conference. The article reports the paper deals mainly with railroad control equipment and the impact of this equipment upon the operation of railroad warning equipment (devices). From the railroad perspective, the author explains that grade crossing signals are advisory, whereas highway traffic signals are control signals. The author divides the railroad warning system into two basic parts -- control equipment and warning equipment, and then focuses on credibility and reliability for each part of the system. From the railroad signal engineer's view, this is the most important aspect of the system, because if train detection and control logic are not properly designed, installed and maintained, the control equipment will not provide the creditability and reliability expected of the system. The

newsletter editor points out important differences in the perspective of terms. While the railroad signal engineer refers to the control aspects of the system when evaluating the performance of a grade crossing device, the highway traffic engineer generally refers to the warning aspects of the system. The editor comments that the conflicting opinions result from the fact that the grade crossing warning equipment provided for the highway user, are subject to control equipment necessary for railroad signal operations. He further comments that until such time that research and development produces an integrated control and warning equipment system that meet the requirements of both railroads and highways, the conflicting opinions of definitions of credibility and reliability will continue to exist.

### **III. HIGH PROFILE CROSSINGS (GEOMETRIC DESIGN)**

1. *HIGHWAY ACCIDENT REPORT: HIGHWAY/RAIL GRADE CROSSING COLLISION NEAR SYCAMORE, SOUTH CAROLINA, MAY 2, 1995.* NTSB/HAR-96/01, Notation 6596A, National Transportation Safety Board. Washington, D. C.: 11 March 1996, 102 p.

TRIS Abstract: On May 2, 1995, a truck consisting of a tractor and a lowbed semitrailer became lodged on a high-profile (hump) railroad grade crossing near Sycamore, South Carolina. About 35 minutes later, the truck was struck by southbound Amtrak train No. 81 en route from New York City to Tampa, Florida. No deaths resulted from the accident, but 33 persons sustained minor injuries. Combined property damage to the truck and train exceeded \$1 million. The following issues in grade crossing safety are discussed in this report: identification and warnings of hump crossings, emergency notifications at grade crossings, and adequacy of training for commercial drivers. As a result of its investigation, the National Transportation Safety Board issued recommendations to the Secretary of Transportation; the Federal Highway Administration; the American Public Transit Association; the American Association of Motor Vehicle Administrators; the American Trucking Associations, Inc.; the American Short Line Railroad Association; Operation Lifesaver, Inc.; all Class I railroads and railroad systems; and O&J Gordon Trucking Company.

2. Lee, J., Movassaghi, K.K. and Kumat, A. *DECISION SUPPORT RULES FOR PROFILE DESIGN AT INTERSECTIONS.* Journal of Transportation Engineering, American Society of Civil Engineers. New York, NY. September-October 1995. pp 391-396.

ITE Abstract: To the aid of highway designers that design intersection profiles, this research offers heuristic decision support rules that reduce the degree of roughness in the design. Six heuristic rules are developed for six common at-grade intersections. Given the elevation difference between the secondary roadway and the main highway for intersection construction, the heuristic rules provide values of curve parameters that can yield a feasible profile design with acceptable level of roughness, and generate the elevation points representing the profile. Real-life examples are used to validate the roughness computation method employed in the heuristic rules. In addition, profiles generated by the proposed heuristics are compared with randomly generated feasible designs. Using t-tests to compare data, the heuristic rules can generate profiles with significantly lower roughness than the randomly generated feasible profiles.

3. Eck, R.W. and Kang, S.K. *LOW-CLEARANCE VEHICLES AT RAIL-HIGHWAY GRADE CROSSINGS: AN OVERVIEW OF THE PROBLEM AND POTENTIAL SOLUTIONS*. Transportation Research Record 1327, Transportation Research Board. Washington, D. C.: 1992. pp 27-35.

AUTHOR Abstract: There are no readily available highway design standards aimed at providing adequate ground clearance at rail-highway grade crossings that have hump like profiles. As a result, low-clearance vehicles -- such as low-bed equipment trailers, automobile transporters, and car-and truck-trailer combinations -- can become lodged or hung up at a crossing. A number of accidents of this type have been reported in recent years, but a literature search indicated that there is very little quantitative data on the magnitude of the problem. Traffic count data from West Virginia indicate that low-clearance vehicles make up about 2 percent of the traffic stream. Such vehicles are highly variable in their physical dimensions: ground clearances as low as 2 inches for a variety of wheelbases have been reported. A literature review is presented summarizing approaches to this problem that have been taken. These include specifying crossing physical characteristics and developing advance warning signs. In response to an identified need, the researchers developed microcomputer software that incorporates graphics and animation capabilities to simulate the movement of trucks over grade crossings and to predict where hang ups will occur for a given crossing geometry. The software is described and its use demonstrated in a sample application.

4. Eck, R.W. and Kang, S.K. *ROADWAY DESIGN STANDARDS TO ACCOMMODATE LOW-CLEARANCE VEHICLES (WITH DISCUSSION AND CLOSURE)*. Transportation Research Report 1356, Transportation Research Board. Washington, D.C.: 1992. pp 80-89.

AUTHOR Abstract: It has been attempted to develop geometric design standards to accommodate low-ground-clearance vehicles using computer software. Low-clearance vehicles include lowboy equipment trailers, car carriers, single- and double-drop van trailers, and cars and trucks with trailers. Hang ups and overhang dragging on high-profile roadways are causes of concern for low-ground-clearance vehicles. The objective was achieved through the development and application of the HANGUP software package and the analysis of the design standards of several agencies. Although a few agencies have developed geometric design standards for low-clearance vehicles at rail-highway grade crossings, they are not commonly used by highway engineers. The American Railway Engineering Association (AREA) grade crossing and ITE driveway design standards were evaluated with HANGUP using a vehicle with a 36-ft wheelbase and 5 in. of ground clearance. This can be considered as the standard or "design" low-clearance vehicle. On the basis of limited field data collection, such vehicles represented 85th-percentile values for ground clearance and wheelbase. The results indicate that the AREA design standards accommodate low-clearance vehicles but the ITE standards do not. Grade changes of more than 2.3% on each side of railroad grade crossings have the potential for causing low-clearance vehicles to become stuck. Grade changes at intersections should be less than or equal to 4.6%, which is the maximum slope rate for the standard low-clearance vehicle.

5. *NTSB ISSUES RECOMMENDATIONS PERTAINING TO LOWBOY TRUCKS*. Highway

and Rail Safety Newsletter. Richards & Associates. College Station, TX.: December 1984. pp 3-5.

ANNOTATION: The article reports on the NTSB investigation of two trucks becoming lodged on "humped" crossings. The NTSB made the following recommendations to the Association of American Railroads: (1) establish the specifications stated in Section 1.2, "Profile and Alignment of Crossings and Approaches" of the "*Manual for Railway Engineering*" of the American Railway Engineering Association as the minimal acceptable specifications for Railroad/Highway Grade Crossings; (2) encourage all member railroads to coordinate activity related to track maintenance with local and state governments to preserve the integrity of the profiles at Railroad/Highway Grade Crossings. An editorial comment to the article included the observation that rail-highway crossing design, including maximum grades, should be related to functional classification based upon the appropriate design vehicle.

6. Transport and Road Research Laboratory. *LEVEL CROSSING PROTECTION ON BRITISH RAIL*. Modern Railways. October 1978. pp 454-455.

TRIS Abstract: Details are given of the report "Level crossing protection" (HMSO). The report is the work of a committee which has been studying ways of simplifying design and construction techniques of automatic level crossings to reduce installation, operating and maintenance costs in the light of modern experience of mainland European railways. The Committee examined the level crossing practice records and accident statistics of various European railway administrations and visited installations in France, Holland, Germany and Switzerland. Recommendations are made concerning the time cycle of automatic half barrier crossings (AHB's), modifications to the AHB time cycle in the second train situation. Standards for road surfaces and profiles are discussed and the types of road freight vehicle that would fall into various categories which with minimum under clearances could pass over a hump crossing without risk of grounding, are considered.

#### IV. LIGHT RAIL TRANSIT (LRT)

1. Colquhoun, D., Morrall, J. and Hubbell, J. *CALGARY LIGHT RAIL TRANSIT SURFACE OPERATIONS AND GRADE-LEVEL CROSSINGS*, Transportation Research Record 1503, Transportation Research Board. Washington, D. C.: 1995. pp 127-136.

AUTHOR Abstract: This paper presents an overview of Calgary light rail transit (LRT) surface operations and grade-level crossings. At present, the LRT system incorporates approximately 30 km (18.6 mi) of double track and 31 stations. Approximately 87% of the LRT system is composed of surface operation in a shared right-of-way. Outside of the downtown area, the LRT operates adjacent to and in the median of arterial roadways and in an existing rail corridor. In this environment, the LRT has priority over street traffic, preempting the traffic signals at intersecting roadways. Downtown, three LRT lines merge and run under line-of-site operation along the 7th Avenue Transit Mall along with transit buses and emergency vehicles. Although trains are not given special priority along 7th Avenue, traffic signal phasing provides progression

to minimize delays as the LRT travels between stations. Based on experiences documented in this paper, it is demonstrated that LRT can operate harmoniously with private vehicles, pedestrians, and bicycles in the right-of-way of city streets. Strategies developed maintain an acceptable level of traffic operations at intersecting streets while giving priority to LRT operation through traffic signal preemption. Existing traffic signal and railway crossing equipment and control techniques have also been adapted to manage the interaction between LRT operations and private vehicle, pedestrian, and bicycle traffic at intersecting streets and LRT stations, and to accommodate nonstandard crossing configurations such as skewed intersections.

2. Carter, D.N. *INTEGRATION OF LIGHT RAIL OPERATIONS AND ROADWAY TRAFFIC CONTROL--THE DALLAS AREA RAPID TRANSIT SYSTEM APPROACH*. ITE Compendium of Papers, Institute of Transportation Engineers. Washington, D. C.: September 1994. pp 283-287.

ANNOTATION: Dallas Area Rapid Transit (DART) is constructing a 20 mile double track light rail transit starter system. Much of this system will operate at-grade, crossing 66 roadways. These crossings will occur in median-running, side-running, mid-block, and transitway mall environments. Each condition requires special traffic control, coordination, and safety features. Two basic strategies will be used to control LRT vehicles, motor vehicles, and pedestrians on the Light Rail Starter System; modified traffic signals and railroad gates. This paper discusses the approach used to control and coordinate light rail and motor vehicle traffic in each operating environment.

3. Committee 6Y-37. *GUIDELINES FOR DESIGN OF LIGHT RAIL GRADE CROSSINGS*. An Informational Report prepared by ITE Technical Council. Institute of Transportation Engineers. Washington, D. C.: February 1992. 92p.

TRIS Abstract: The information in this report has been obtained from experiences of transportation engineering professionals and research. The objective of the study was to review traffic engineering experiences and procedures for light rail transit (LRT) systems throughout North America, and develop guidelines for the design of at-grade light rail crossings. The main conclusions of the study focus on traffic controls and are as follows: (1) Direct control of motor vehicle traffic is more effective than warning or advisory signs. An exception may be where low-volume, private roadways interface with low-speed LRT operations. In these situations, wayside warning devices in concert with audible warning devices may be sufficient. (2) Signal priority or preemption can facilitate and enhance safety of LRT operations. Priority and preemption systems are further enhanced when integrated with traffic signal coordination and other measures. (3) Side-of-street LRT alignments create excessive operating conflicts where there are frequent crossings. (4) Direct traffic control and/or improved geometric design of minor crossings and driveways, particularly for side-of-street running, is highly beneficial. Elimination or minimization of "on-line" mid-block alleys, driveways, and minor street access is an effective means to reduce conflicts. (5) "Mixed-flow", light rail vehicle and autos sharing the street, reduces the efficiency of both modes. (6) Where employed, gates or traffic signals should be installed following such design guidelines as the AREA Manual of Railway Engineering and relevant local guidelines (e.g., California Public Utilities Commission General Order 143-A Draft Revision 6/89). Additional conclusions are presented in the report.

4. Boorse, J.W. *SPECIAL SOLUTIONS FOR SPECIAL CROSSINGS ON BALTIMORE'S CENTRAL LIGHT RAIL*. Proceedings: International Symposium on Railroad-Highway Grade Crossing Research and Safety. Knoxville, TN.: 31 October - 3 November 1990. pp 307-328.

ANNOTATION: This paper reports on three special and unique crossings of the proposed Baltimore's Central Light Rail Line (CLRL). One of the situations involved cross street traffic queuing across the tracks, intersecting and passing through signals on streets parallel to the tracks on either side. Instead of developing an elaborate phasing scheme to accommodate the two-way traffic flow on the cross street, traffic was directed one-way on the subject street and relocated on an adjacent parallel street one-way in the opposite direction. This eliminated the queuing dilemma at this crossing. The geometry of the alternate intersection allowed use of a pre-signal, which alleviated the queuing problem at that location. The other locations involved signalized crossings or non-exclusive LRT operation on city streets.

5. Hoey, W.F. and Levinson, H.S. *SIGNAL PREEMPTION BY LIGHT RAIL TRANSIT: WHERE DOES IT WORK?*. ITE Compendium of Technical Papers, Institute of Transportation Engineers. Washington, D. C.: September 1989. pp 330-334.

AUTHOR Abstract: Light rail transit (LRT) allows medium-sized metropolitan areas to realize many benefits of rapid transit at much lower capital and operating costs. Traffic preferences, including signal preemption, are necessary if the LRT mode is to operate reliably and to provide an acceptable alternative to auto travel. This paper is intended to set forth principles which can be used in planning LRT lines so as to take advantage of signal preemption.

6. Lancaster, T.R. *LIGHT RAIL TRANSIT PREEMPTION OF ACTUATED SIGNALS*. ITE Compendium of Technical Papers, Institute of Transportation Engineers. Washington, D. C.: September 1989. pp 335-337.

ANNOTATION: The 15-mile light rail line in Portland, Oregon, named MAX (Metropolitan Area Express), connects downtown Portland with the east Portland suburb of Gresham. Five miles of the route is located within the median of Burnside Street. Burnside is a collector with an ADT of about 5,000, and speed limit of 35 MPH. Sixteen streets cross Burnside and the LRT tracks. All are signalized with fully-actuated type-170 traffic signal controllers. All left turn lanes on Burnside which cross the tracks have protected signal phases. Each traffic signal is preempted by MAX trains. At one location a skewed intersection required installation of a "pedestrian suppression" detector installed upstream of the station. This prevented any cross-street pedestrian intervals from being served for a fixed period of time while the train is stopped at the station. At each intersection, the safe stopping distance for trains was calculated on the approaching track and if a train operator did not receive a preemption indication by the time the train reached the decision point, the operator must assume there would be no preemption and initiate braking action. Other features and conditions were reported.

7. Fehon, K.J., Tighe, W.A. and Coffey, P.L. *OPERATIONAL ANALYSIS OF AT-GRADE LIGHT RAIL TRANSIT*. Transportation Research Board Special Report 221, Transportation



Research Board. Washington, D. C.: 1989. pp 593-605.

AUTHOR Abstract: At-grade operation of light rail transit (LRT) presents many analytical problems not normally encountered in traffic engineering analysis. In particular the non-cyclical and directional nature of LRT arrivals renders traditional intersection and network analysis techniques inappropriate. In planning or designing an LRT system, the information often required by decision-makers includes delay to LRT due to street traffic, delay to street traffic due to LRT, length of queues when LRT affects traffic signals or at-grade crossings, short-term and long-term levels of congestion at-grade crossings, and the impacts of combined events such as back-to-back rail vehicle arrivals. Computer-based tools have been developed to provide this information in both the planning and design stages of LRT system projects, including estimating average degree of saturation at a traffic signal during an hour of LRT operation, estimating cycle-by-cycle delays and queue length at a preempted fixed-time signal with LRT arrivals at preset headways, and estimating LRT delay in a fixed-time coordinated signal system with partial or no LRT priority. A new general purpose network simulator has been created that will realistically model light rail vehicles in a street environment with vehicle-actuated and coordinated traffic signals and other controls.

8. Taylor, P.C., Lee, L.K. and Tighe, W.A. *OPERATIONAL ENHANCEMENTS: MAKING THE MOST OF LIGHT RAIL*. Transportation Research Board Special Report 221, Transportation Research Board. Washington, D. C.: 1989. pp 578-592.

AUTHOR Abstract: The at-grade light rail system between Long Beach and Los Angeles, a 22-mi double-track line, crosses 85 streets at grade. The five local jurisdictions involved in the system were understandably concerned about the traffic impact of light rail vehicles (LRVs) arriving at a peak headway of 6 min. The problems facing the designers were compounded by the adjacent Southern Pacific at-grade freight train operation, and by the proximity of major signalized intersections. The solution involved an assortment of integrated light rail and street traffic operational enhancements. In the exclusive right-of-way segments LRVs were given full priority over street traffic at all times at most major crossings. In the median alignment segments, special traffic signal software was designed to provide integrated LRV priority without the disruption of full preemption. All stations were designed with high-level platforms to minimize passenger loading times and to make handicapped access easier. Automatic overrun protection implemented via cab signaling allowed at-grade crossing gates to remain in the up position while LRVs dwell at near side station platforms. At several locations streets were closed, turn movements prohibited, or streets converted to or from one-way operation to allow more efficient operation of automobiles or LRVs. The result of these operational features is an economical at-grade light rail system that meets the objectives of a reasonable LRV travel time and an acceptable level of service and safety for automobile traffic.

9. Kloos, W.C. *TRAFFIC CONTROL AND LRT: HOW WE DO IT IN PORTLAND*. ITE Compendium of Technical Papers, Institute of Transportation Engineers. Washington, D. C.: September 1988. pp 185-187.

AUTHOR Abstract: Portland's new light rail system began revenue service on September 7,

1986. The single 15.1 mile line runs from downtown Portland to the suburban City of Grasham and has 25 stations. Current ridership is approximately 20,000 riders per weekday and 22,000 riders per day on the weekend. The service provided is 15 minute headway during off peak periods with 7 minute headway during peak periods. The line has 83 at-grade crossings. This paper describes the operation of the LRT system at these crossings and presents some of the operational theory behind the traffic operations design of Portland's system.

10. Hoey, W.F. *TRAFFIC CONTROLS FOR LIGHT RAIL TRANSIT*. Institute of Transportation Engineers, Proceeds, District 6, 41st Meeting. 17-20 July 1988. pp 57-67.

ITE Abstract: The current Manual on Uniform Traffic Control Devices (MUTCD) has no specific provision for light rail transit within street right of way, although conventional railroad crossings are treated. This paper compares the traffic engineering techniques used in San Diego, Portland, Sacramento, and San Jose to provide for light rail movements at intersections. These techniques include conventional railroad style crossing gates, and pavement marking. They are compared in terms of their ability to be understood and their relation to current MUTCD provisions.

11. Schulte, W.R. and Joe, T.S. *TRAFFIC CONTROL AND LIGHT RAIL TRANSIT: HOW IT IS REGULATED IN CALIFORNIA*. ITE Compendium of Technical Papers, Institute of Transportation Engineers. Washington, D. C.: September 1988. pp 188-191.

ITE Abstract: In California, local government, independent transit agencies and the state are all attempting to work together to develop a safe, efficient rail transit system while still maintaining maximum traffic operational efficiency. Efforts in the transit/traffic interface area are currently under way to: (1) Revise existing state regulations of overall transit design, construction and operation of transit system; (2) Revise existing state regulations of railroad warning and traffic control devices to account for the multitude of transit operational schemes and their individual characteristics; (3) Standardize the use of traffic control devices including signals, signs and pavement markings; (4) Develop non-standard approaches to respond to traffic delays at transit "near-side" stations.

## **V. SPECIAL VEHICLE OPERATIONS (Trucks, Buses, Hazardous-Material Vehicles)**

1. Proctor, II, C.L., Grimes, W.D., Fourier, Jr., D.J., Rigol, Jr., J. and Sunseri, M.G. *ANALYSIS OF ACCELERATION IN PASSENGER CARS AND HEAVY TRUCKS*. SAE Technical Paper 950136, SAE International Congress and Exposition. Detroit, MI.: February 27 - 2 March 1995. pp 39-79.

AUTHOR Abstract: When analyzing the time/distance performance of vehicles accelerating from a stopped position, a constant acceleration rate is often assumed. Acceleration profiles as a function of time are examined in this paper in order to identify errors associated with the constant acceleration assumption for a passenger car and a large truck. The paper also includes acceleration data collected from 219 large trucks measured over distance of 50 and 100 feet. For

passenger cars, the assumption of constant acceleration is appropriate when evaluating velocity/distance scenarios with displacements of interest greater than 10 ft. For 5 ft or less, variable acceleration is recommended. When time factors are of special interest, attention must be given to the lag times associated with variable acceleration. The lag time does little to affect the velocity/distance relationship; however, it alters time/distance/velocity relationship by as much as 2 seconds. For heavy trucks, a speed surge is seen immediately before shifting from 2nd to 3rd gear, but due to the low acceleration values, little impact is seen in the time/distance profile. The constant acceleration assumption for heavy trucks appears valid for situations where the driver is shifting. In these tests the approximate constant acceleration was 0.07 g's. When the driver of a heavy truck does not shift, the transmission gearing as well as the weight of the load is important in determining the acceleration of the vehicle. When a heavy truck is not shifted, using constant acceleration 0.05 g's usually under-estimates the distance traveled in the 4-8 second range and over-estimates the distance traveled after 8 seconds. Based on the time and distance measurements for 219 trucks, calculated average accelerations were 0.085, 0.106, and 0.138 g's over the first 50 ft for flatbed, box and bobtail configurations, respectively. Over a distance of 100 ft, the average accelerations were somewhat lower: 0.064, 0.073, and 0.118 g's for the flatbed, box and bobtail configurations, respectively.

2. Ryan, T.A. and Carter, E.C. *MODEL OF THE EFFECTS OF RAIL-HIGHWAY GRADE CROSSINGS ON EMERGENCY ACCESS*. Transportation Research Record 1254, Transportation Research Board. Washington, D. C.: 1990. pp 85-90.

AUTHOR Abstract: The purpose of this research was to develop a simple model describing the impacts of rail-highway grade crossings (RHGCs) on emergency access. Linear cities and two-dimensional cities with square grid roadway networks are considered. For the purposes of the model, maximum response time from the emergency services base stations to the most distant point in the service area was minimized. The model indicates that the introduction of an RHGC into an optimized condition requires each base station to be relocated toward the RHGC, to again achieve optimal conditions. It also reveals that the impacts of a rail line through a city vary greatly with the orientation of a rail line relative to the roadway grid. Suggestions for further model extension are presented.

3. Lamkin, J.T. *THE IMPACT OF LONGER AND HEAVIER TRUCKS ON HIGHWAY-RAIL CROSSING SAFETY IMPROVEMENT PROJECTS*. Proceedings: 1989 National Conference on Rail-Highway safety. San Diego, CA.: 9-12 July 1989. pp 95-113.

RICHARDS Abstract: The 1982 Surface Transportation Assistance Act authorized longer, wider, and heavier trucks to use interstate highways and certain designated access routes. The subsequent increase in the use of these larger trucks has greatly increased the productivity and efficiency of the trucking industry. Yet, many safety concerns have also arisen due to the growing number of larger and heavier trucks. The particular issue addressed in this study is the safety affects of the larger trucks at highway-rail crossings. Therefore, the purpose of this technical paper was to determine what impact increased truck size and weight may have upon highway-rail crossing safety improvement projects.

4. *NO TIME TO PLAY CHICKEN*. School Bus Fleet. April/May 1989. pp 36-39.

ANNOTATION: Railroad crossings may be the most dangerous hazard to a school bus driver will encounter on the daily run. Understanding the danger is common, and the consequences can be deadly. Various judgment errors are listed including stopping too close to the tracks, not opening doors or windows to listen in addition to watching for approaching train, respective and ability to judge moving objects, and crossing against active signals. Operation Life Saver works with school districts to promote awareness through its three "E's" program; Education to promote awareness of crossing dangers, Enforcement of driving safety laws, and Engineering for improved warning signs and signals.

5. Fitzpatrick, K., Mason, Jr., J.M. and Glennon, J.C. *SIGHT DISTANCE REQUIREMENTS FOR TRUCKS AT RAILROAD-HIGHWAY GRADE CROSSINGS*. Transportation Research Record 1208, Transportation Research Board. Washington, D. C.: 1989. pp 70-79.

AUTHOR Abstract: The sight distance requirements for large trucks at railroad-highway grade crossings are compared with current AASHTO policy. The key elements affecting sight distance requirements include driver characteristics such as perception-reaction time and vehicle characteristics such as vehicle speed, length, acceleration, and braking distances. The results from sensitivity analysis are compared with current policy and are summarized for each sight distance consideration. The findings imply that current criteria for sight distance along the highway and along the tracks for a moving highway vehicle may not be adequate for large trucks. In contrast, the current AASHTO values for sight distance along the tracks for a stopped highway vehicle adequately reflect current truck performance capabilities.

6. Mason, Jr., J.M., Fitzpatrick, K and Harwood, D.W. *INTERSECTION SIGHT DISTANCE REQUIREMENTS FOR LARGE TRUCKS*. Transportation Research Record 1208, Transportation Research Board. Washington, D. C.: 1989. pp 47-56.

AUTHOR Abstract: An analysis has been conducted to determine the sight distance requirements of large trucks at intersections. AASHTO policy is briefly reviewed and related vehicle characteristics are identified. Truck characteristics are updated based on permitted 1982 Surface Transportation Assistance Act design vehicles and published truck acceleration models. The results of sensitivity analysis are compared with current policy and are summarized for each of the intersection sight distance cases considered by AASHTO. The findings imply that current intersection sight distance criteria may not be adequate for trucks when the current AASHTO models are exercised for the representative truck characteristics. Nevertheless, the findings, particularly for Case III intersection sight distance, result in impracticably long sight distance requirements. Therefore, the development of alternative approaches for establishing realistic sight distance values is advocated. In particular, a truck driver gap-acceptance concept is proposed for further study. The gap lengths that truck drivers safely accept would be determined through field studies, and sight distance criteria would then be established to ensure that truck drivers on a side road approach would have sight distance at least equal to acceptable gap length.

7. Draskoczy, M. *BUS BEHAVIOR AT RAIL-HIGHWAY GRADE CROSSINGS -- ROAD*

*USER BEHAVIOR. THEORY AND RESEARCH.* Transport and Road Research Laboratory. 1988.

RICHARDS Abstract: Driver behavior at rail-highway grade crossings is influenced by the fact that there is a low probability of a bus meeting a train, but if it happens, it will have especially serious consequences. In an attempt to formulate countermeasures for these types of accidents, bus driver behavior at different kinds of railroad-highway grade crossings was studied. Crossings were of different quality, either protected by flashing light or without any active protection except for a traffic sign. The speed of the bus and the activity as well as the heart rate of the driver were registered on a longer test road which contained some railroad-highway grade crossings too. Driver behavior could be characterized first of all by visual searching activity and speed choice at these places. Bus driver behavior at railroad-highway grade crossings did not prove to be adequately adapted to the means of protection; i.e., to a traffic signal indicating when the train was imminent, or the driver himself having to look for the oncoming train. Precaution, visual searching activity, and the speed choice of the drivers were much more determined by the drivers' knowledge about the visibility at the crossing, or whether there was active protection or not. It was pointed out that the buses' speed was lessened if the pavement was worse in the crossing, but that it was not changed significantly. The lower the road quality, the greater the deviation from a safe speed at the crossings.

8. Bowman, B.L., McCarthy, K. and Hughes, G. *THE SAFETY, ECONOMIC, AND ENVIRONMENTAL CONSEQUENCES OF REQUIRING STOPS AT RAILROAD-HIGHWAY CROSSINGS.* Transportation Research Record 1069, Transportation Research Board. Washington, D.C.: 1986. pp 117-125.

AUTHOR Abstract: The purpose of this study was to determine the safety, economic, operational, and environmental consequences of requiring hazardous materials transporters, school buses, and passenger buses to stop at railroad crossings with active warning devices when the devices are not activated. The study included an assessment of the positive and negative impacts on accidents involving trains and those in which trains are not involved, traffic operations, fuel consumption, delay, pullout-lane construction and maintenance costs, and environmental degradation. Results indicate that not mandating stops at railroad crossings with active devices when the devices are not activated would reduce both train and non-train accidents annually for all three classes of vehicles; the net annual decrease in train-involved accidents would be 2.6, 10.8, and 17.4 percent for hazardous materials transporters, school buses, and passenger buses, respectively. The annual economic savings resulting from not requiring stops were estimated as \$328,000 in accident costs; \$1,241,000 in pullout-lane construction and maintenance costs; \$12,267,000 in excess fuel consumption; and \$1,510,000 in delay.

9. Gillespie, T.D. *START-UP ACCELERATIONS OF HEAVY TRUCKS ON GRADES.* Transportation Research Record 1052, Transportation Research Board. Washington, D. C.: 1986. pp 107-112.

AUTHOR Abstract: The acceleration performance of heavy trucks starting on grades represents an important boundary consideration in highway design. Trucks generally possess the lowest

levels of acceleration performance. This, in combination with their length, makes them the highway vehicle class that requires the greatest time to proceed across intersections. Especially at railroad-highway grade crossings, truck performance establishes bounds on the timing requirements for warning devices. Guidelines on truck acceleration performance on level grades have been established in the past for use on highway design. However, the new size and weight allowances warrant review of these guidelines and present the opportunity to consider the influence of grade on performance. The performance bounds for truck acceleration depend on both the truck properties and the driving techniques used by the driver. The application of some "rules of thumb" for driving and knowledge of truck power train design provide a basis for a first-order estimate of the start-up performance range expected on various grades. The analysis is applied to the problem of clearance times at rail-highway grade crossings where regulations mandate travel in the start-up gear and the time-distance relationships are thus determined by the gear required for starting on the grade. The analysis finds that attainable speed decreases with increasing grade and affects the clearance times that should be allowed.

10. *NTSB CHAIRMAN TALKS ABOUT SCHOOL BUSES AND TRUCKS*. Highway and Rail Safety Newsletter, Richards & Associates. College Station, TX.: September 1985. pp 9.

ANNOTATION: The article reports on chairman Jim Burnett's speech before the 1985 National Conference on Highway-Rail Safety. His talk included the following recommendations: (1) State directors of pupil transportation should assure that bus drivers comply with grade crossing stopping requirements; (2) increase monitoring of drivers involving both parents and students; (3) where possible, school buses should avoid grade crossings without train activated warning devices even if it means a longer bus route; (4) safety stickers and in-service training for drivers. Burnett recommended drivers of hazardous materials trucks should have the same standards. To reduce potential train-truck accidents involving hazardous materials, the following activities are encouraged: 1) FHWA initiate formation of state level advisory groups to monitor and respond to hazardous material transportation problems; 2) National Safety Council assume greater leadership in education of hazardous materials truck drivers; 3) NTSB advocate special licensing and certification for drivers of hazardous materials trucks. He also pointed out that most motor vehicle operators involved in crossing accidents are inattentive, careless, and ignorant of the hazards at grade crossings. Drivers' bad habits can be changed through education and enforcement.

11. Darmstadter, N. *STATEMENT OF AMERICAN TRUCKING ASSOCIATION, INC., SPECIAL SAFETY INQUIRY, RAIL-HIGHWAY GRADE CROSSING SAFETY*. Before the FRA, DOT, Docket No. RSSI-84-3; Notice No. 2. Federal Register [49FED.REG.49961]. Washington, D. C.: 23 January 1985. 8 p.

RICHARDS Abstract: In a statement prepared for the Federal Railroad Administration Special Safety Inquiry, Neill Darmstadter, Senior Safety Engineer for the American Trucking Association, voiced ATA's concerns for the highway-rail grade crossing safety improvements. The paper focused on the following four issues: (1) Better control of train speeds in relation to weather, frequency of crossings, sight distances, and warning time to highway users; (2) improvements of sight distances at crossings; (3) improving the side visibility of trains at night;

(4) the need to avoid additional restrictions on highway users at-grade crossings.

## **VI. MAINTENANCE, MALFUNCTIONS AGENCY COORDINATION and CROSSING IDENTIFICATION**

1. Faghri, A. and Panchanathan, S. *APPLICATION OF GEOGRAPHIC INFORMATION SYSTEMS TO RAIL-HIGHWAY GRADE CROSSING SAFETY*. Transportation Research Record 1495, Transportation Research Board. 1995. pp 156-165.

AUTHOR Abstract: The application of geographic information systems (GIS) is especially relevant to transportation-related fields because of the spatially distributed nature of transportation-related data. The application of GIS to the management of transportation data can result in reduced costs and time savings. The development of a GIS application for management of safety-related data for public at-grade rail-highway crossings in the state of Delaware is discussed. The objective was to develop a GIS application that would enable better management of safety-related data for rail-highway grade crossings by integrating data from various sources and referencing data to their actual spatial location on the base map. The GIS application enables analysis and interpretation capabilities such as visual access and display, spatial analysis, query, thematic mapping and classification, and statistical and network-level analysis. The work was a continuation of an ongoing project that resulted in the integration of rail-highway grade crossing safety data from various sources, such as the Federal Railroad Administration and the Delaware Department of Transportation into a data base management system and the selection and implementation of the U.S. Department of Transportation (USDOT) accident prediction model into the system. The development of the rail-highway grade crossing safety GIS application is described and the creation of the spatial base map; conversion of existing rail-highway crossings attribute data into GIS acceptable format; the interface with the USDOT model; and the prioritization, query, manipulation, analysis and editing features of the GIS application are presented.

2. Jennings, B. *A REVIEW OF THE NEWLY ISSUED GRADE CROSSING REGULATIONS FOR RAILROADS*. Proceedings: Third International Symposium on Railroad-Highway Grade Crossing Research and Safety. Knoxville, TN.: October 24-26 1994. pp 39-60.

RICHARDS Abstract: Since the Symposium 2 years ago, much of the collected data has been examined and a series of new signal system rules will become effective 1-1-95. To quote the regulations, the "FRA is issuing a final rule requiring that railroads comply with specific maintenance, inspection, and testing requirements for active highway-rail grade crossing warning systems. FRA is also requiring that railroads take specific and timely actions to protect the traveling public and railroad employees from the hazards posed by malfunctioning highway-rail grade crossing warning systems. "The main direction of these regulations appears to be developing a minimum level of uniform maintenance and maintenance documentation among the railroads to ensure a safer system of warning devices.

3. Bartoskewitz, R.T., Fambro, D.B. and Richards, H.A. *TEXAS HIGHWAY-RAIL*

*INTERSECTION FIELD REFERENCE GUIDE. FINAL REPORT.* Report No. FHWA/TX-94/1273-2F, Texas Transportation Institute. College Station, Texas. May 1994. 164p.

TRIS Abstract: The design, construction, operation, and maintenance of highway-rail intersections present unique challenges to both highway and railroad engineers. The railroad grade crossing represents the physical intersection of two distinctly different modes of transportation, each of which varies considerably in terms of their equipment, traveled ways, and methods of control and operation. Safety at highway-rail intersections has been a national priority for over two decades. Substantial reductions in crashes, injuries, and fatalities have been realized as a result of grade crossing improvement programs. Grade crossing safety has reached a point where further safety improvements will likely require the development of new approaches and innovative technologies. Proper design and construction of new grade crossings ensures safe and efficient operation. Proper maintenance of existing crossings helps to achieve continued safety and efficiency. The field guide has been developed to assist agencies responsible for the design, construction, operation, and maintenance of highway-rail intersections in the performance of these responsibilities. It is a reference source for city, county, and state personnel that must address these issues as part of their official duties. Railroad personnel will find the reference guide helpful in obtaining a basic understanding of highway and traffic engineering concerns with regard to highway-rail intersections. The guide includes information on problem identification and engineering studies, improvement alternatives, special programs and activities, and key reference documents.

4. Richards & Associates. *GRADE CROSSING SIGNAL SYSTEM SAFETY*. Federal Register, 49 CFR Parts 212 and 234, FRA Docket No. RSGC-5; Notice No. 6: Highway & Rail Safety Newsletter. College Station, TX.: March 1994.

RICHARDS Abstract: On June 29, 1992, the Federal Railroad Administration published a Notice of Proposed Rulemaking (NPRM) on Timely Response to Grade Crossing Signal System Malfunctions. In that NPRM, FRA proposed to require specific responses by railroads to signal system malfunctions. A public hearing was held on September 15, 1992, at which a number of interested parties, including those submitting this statement, presented testimony and comments. In response to the comments received at the hearing, FRA conducted an open meeting and expanded the scope of the rulemaking to include the subject of federal standards for the maintenance, inspection and testing of signal systems at highway-rail crossings. The Association of American Railroads (AAR), the American Short Line Railroad Association (ASLRA), and the Brotherhood of Railroad Signalmen (BRS) participated in the open meeting and initiated a joint effort to address the expanded scope of the proceeding. On February 12, 1993, the parties submitted comments on Timely Response to Grade Crossing Signal System Malfunctions and on Maintenance, Inspection and Testing of Grade Crossing Signal Systems, with specific recommendations for amending 49 CFR, Part 234. On January 20, 1994, FRA published a revised NPRM on Grade Crossing Signal System Safety, in which FRA proposed specific maintenance, inspection and testing requirements for active warning systems at highway-rail crossings and requirements for action by railroads in response to malfunctions of those systems.

5. Bowman, B.L. and Colson, C. *CURRENT STATE PRACTICES AND*



*RECOMMENDATIONS FOR IMPROVING RAIL-HIGHWAY GRADE CROSSING PROGRAM.*  
Transportation Research Record 1456, Transportation Research Board. 1994. pp 139-145.

AUTHOR Abstract: The rail-highway crossing safety program is one of the most successful traffic safety initiatives in the United States. Since passage of the Highway Safety Act of 1973 it is estimated that 7,200 fatalities and 31,000 injuries have been prevented. Managing and conducting the rail-highway safety program within each state are more complex than managing and conducting typical traffic safety initiatives. This is primarily because of the diversity of expertise and agencies involved in conducting a successful program including the state, local roadway agency, FHWA, FRA, railroad companies, equipment suppliers, and private contractors. The complexity of effecting grade crossing improvements often results in a large amount of time between the identification of deficient crossings and the actual installation of the physical improvements. As state agencies gained experience with their programs many developed enhancements to increase program efficiency. These enhancements included different methods of identifying deficient crossings, corridor improvement programs, funding initiatives for off-system crossings, administrative enhancements, and improved cooperation and coordination with railroad agencies. The results of an effort conducted for the Alabama Highway Department to determine the structure, practices, and successful components of the rail-highway program of other states are summarized. This was accomplished by forwarding a survey to the rail-highway program coordinator of each state with the exception of Hawaii. A total of 41 responses were received. The results of that survey are summarized.

6. *WHO HAS THE RESPONSIBILITY FOR WARNING DEVICES AT PRIVATE CROSSINGS.*  
Highway and Rail Safety Newsletter, Richards & Associates. College Station, TX.: February 1993.

ANNOTATION: George Reid, Traffic Engineer/Attorney presented a paper at the 1992 TRB meeting. The newsletter provided this following summary: "Now that the Federal Railroad Administration has issued preliminary guidelines for safety at private crossings (see the January issue of this newsletter) the discussion as to who has responsibility and jurisdiction over some 114,000 roadway-rail intersections will intensify. The railroads will probably argue that the holder of the property has responsibility. The states will probably argue that, except through their railroad regulatory authority, they have no jurisdiction. Local governmental entities will argue that they sometimes assist the holder with materials for use at the crossing but have no jurisdiction. And the holders will probably argue that it is either the railroads responsibility or that the public should take jurisdiction over safety at the crossings."

7. Hinton, J.S. *GRADE CROSSING INFORMATION--WHERE AND HOW TO LOCATE IT.*  
Proceedings: Second International Symposium on Railroad-Highway Grade Crossing Research and Safety. Knoxville, TN.: 8-10 December 1992. pp 219-225.

ANNOTATION: The paper describes highway grade crossing information that is available to individuals, the railroad industry, trucking companies and legal counsel. Best sources are the FRA; Information Networks (a holding company); state police; DOTs; Railroad-Highway Grade Crossing Handbook, MUTCD, AASHTO Policy on Geometric Designs of Highways and Streets,

Code of Federal Regulations, Sections 23 and 49; and proper discovery written for legal counsel.

8. *MALFUNCTION IN A CROSSING WARNING SYSTEM*. Highway and Rail Safety Newsletter, Richards & Associates. College Station, TX.: 23 July 1991.

ANNOTATION: Newsletter article reports on information from the *Federal Register*, N141, 23 July 1991, pp 33722-33728. A significant part of the FRA document supporting the final rule governing maintenance, testing and inspection of grade crossing train activated warning devices addressed device "malfunction". The FRA suggested that "false activation" should be researched as to frequency of occurrence and how often the condition may contribute to grade crossing accidents. The FRA believed these unique occurrences were the result of design errors, or errors in installation or repair rather than component failure. Before imposing a "regulatory fix" on the problem, the report recommended the extent and cause of false activation's be determined. The FRA was considering the possibility of issuing a near future rulemaking which would propose rules requiring railroads to respond in a timely manner to reports of malfunctioning warning systems and to inspect and test the systems at the time of the reported malfunction. Rules would also require the railroad to assure safety at the rail-highway intersection until such time as the warning device has been repaired.

9. Gouty, P.L. *AUTOMATIC GRADE CROSSING WARNING SYSTEMS FAILURE TO FUNCTION AND FALSE WARNING*. Proceedings: International Symposium on Railroad-Highway Grade Crossings Research and Safety. Knoxville, TN.: 31 October-3 November 1990. pp 113-119.

ANNOTATION: Failure to function and false warnings of three systems are discussed: (1) The relay system; (2) the modified relay system that uses audio frequency overlay track circuits in place of the direct current track circuits used in the relay system; and (3) the electronic system which may be either a motion detector or grade crossing predictor. Common types of failures for each type of system are described. Relay systems are subject to mechanical failure such as loose wire connections, defective insulated rail joints, defective insulated switch rods and switch gage plates, and lockout. With a modified system using audio frequency, a potential problem occurs if the frequency used for energizing the track circuits are not compatible with other electronic track circuits operating in the area. Motion detector and grade crossing systems are described. Failures involving motion detector and grade crossing predictor systems include interfering shunts such as a wire across the tracks, faulty insulated rail joint at a turn out or insulated switch rod. If such an interfering shunt condition existed close to the crossing, it is possible that a zero warning time would be experienced for the approaching train. A discussion of closed circuit versus open circuits system design is also provided. Other failure elements common to all systems should include lockout (where a departing train properly fails to deactivate the system so that a train approaching in the opposite direction will not activate until it reaches the island circuit near the intersection crossing).

10. George, B. *SMALL RAILROADS: A SPECIAL CASE IN CROSSING SAFETY*. Proceedings: 1989 National Conference on Rail-Highway Safety. San Diego, CA.: 9-12 July 1989. pp 129-139.

ANNOTATION: Small railroads (short lines) are defined. Two classes of small railroads were included in six categories of railroads inventoried. Observations reported from the inventory were: (1) the total number of public at-grade crossings has decreased by 15%; (2) the number of railroads in categories A and B, (large railroads) declined from 27% to 15%; (3) railroads in categories C, D and E (mid-sized and small) increased by 47%; (4) category B -- crossings decreased by about 50,000, all other category crossings increased. Data included in the analysis were train speeds, highway volumes, warning devices and fatal accidents, The following conclusions were presented: (1) crossings on small railroads are different; (2) the number of small railroads is increasing; (3) on average, train traffic is less which results in lower accident rates; (4) speeds are lower, and result in less severe accidents; (5) more than half of rail-highway crossing accidents involving passenger trains occur on mid-sized railroads; (6) passenger train accidents are more severe, probably because operating speeds are much higher; (7) for reasons not fully understood, the percentage of accidents occurring at crossings equipped with automatic warning devices is higher on smaller railroads; (8) on average, warning device installation and maintenance cost per crossing are lower on small railroads even though this work is often accomplished by contract forces; (9) anyone considering acquisition of a small railroad should study and learn from experiences of those who have gone before.

11. Lamkin, J.T. and Richards, H.A. *AN EVALUATION OF THE TEXAS 1-800 PROGRAM*. Texas A&M Research Foundation. College Station, TX. June 1989. 1519p.

RICHARDS Abstract: The objective of this report is to document the activities, findings, and recommendations of a research study which focused on the Texas Railroad Crossing Safety Information Act and the railroad notification program (1-800 Program) mandated by this Act. The report presents information on: (1) The Act and the workings of the notification program; (2) data collected; (3) uses of the data; (4) current status of the program; (5) costs and benefits of the program; and (6) the Act/program's effectiveness, transferability, and the contribution to rail-highway crossing safety. Several recommendations are presented that are formulated to improve the operation of the program and make it more effective in crossing safety and maintenance. The report contains information and suggested guidelines and recommendations for states considering adopting and implementing a program similar to the Texas 1-800 Program.

12. *CROSSING SAFETY ON SHORT LINES*. The Signalman's Journal. June 1989. pp 24-29.

ANNOTATION: This article illustrates case studies in Texas where highway-railroad active warning devices were found to be in disrepair, and in some cases, not operative. The article points out the need for federal regulations, since some short lines do not apply necessary resources for maintenance to provide for public safety at grade crossings.

13. *DELAWARE STARTS 1-800 PROGRAM*. Highway and Rail Safety Newsletter. Richards & Associates. College Station, TX.: June 1989. pp 10.

ANNOTATION: New railroad crossing signs being installed in Delaware display a toll free number people may call if crossing lights are malfunctioning. This is part of a shared-cost

crossing repair program between Delaware DOT and Conrail. The Delaware program is the first of its kind, although Texas had a toll free hot line program for reporting malfunctioning crossing equipment since 1984.

14. *CLOSE COORDINATION BETWEEN ENGINEERS SAVES MONEY AND EMBARRASMENT*. Highway and Rail Safety Newsletter. Richards & Associates. College Station, TX.: August 1987.

ANNOTATION: The article relates a newsletter subscriber report of construction of a new railroad-highway crossing wherein the approach roadway was three inches higher on each side of the track: another instance of lack of communication between highway and railroad engineers. The report responded to an article published in the *American Public Works Association Magazine*.

15. *DIAGNOSTIC TEAM APPROACH TO HIGHWAY-RAIL GRADE CROSSING EVALUATION*. Highway and Rail Safety Newsletter. Richards & Associates, College Station, TX.: March 1986.

ANNOTATION: The article reports the FHWA cooping with several states to adopt a diagnostic study team to evaluate deficiencies of individual highway-rail crossings. The team is comprised of experienced individuals representing various agencies and disciplines involved in highway-rail safety. The objective of the team evaluation is to consider operational and physical characteristics of crossings. Team members must have responsibility for highway and rail operations, warning devices, and program administration. Most states that have adopted the diagnostic study team approach have developed specific techniques for evaluating the crossing and recording deficiencies; usually on a prepared questionnaire. Typical items included in the evaluation are: (1) Driver awareness of the crossing; (2) Visibility of the crossing; (3) effectiveness of advance warning signs and signals; (4) geometric features of the highway; (5) driver awareness of approaching trains; (6) driver dependence on crossing signals; (7) obstruction of view; (8) roadway geometrics diverting driver attention; (9) location of standing railroad cars or trains; (10) pavement markings; (11) conditions conducive to vehicle becoming stalled or stopped on the crossing; (12) operation of vehicles required by law to stop at the crossing; (13) signs and signals as fixed object hazards; and (14) opportunity for drivers to take evasive action.

16. Hutton, B.J. *RAIL-HIGHWAY GRADE CROSSING WARNING DEVICES MAINTENANCE*. Proceedings: 1985 National Conference on Rail-Highway Safety. Kansas City, MO.: 16-18 July 1985.

RICHARDS Abstract: This paper describes in detail the grade crossing signal maintenance procedures of a major railroad. Rules covering these procedures are identified and explained as are training and education practices. Maintenance of the components of various types of signals are described, microprocessors, and other highly sophisticated controls.

17. Mather, R.A. *INSPECTION OF AUTOMATIC GRADE CROSSING SIGNALS IN*

OREGON. Proceedings: 1985 National Conference on Highway-Rail Safety. Kansas City, MO.: 16-18 July 1985. pp 105-111.

RICHARDS Abstract: This paper describes the program of the State of Oregon to inspect automated signal devices. Covered are inspection procedures, computerized status report system, and component modification recommendations.

18. *GRADE CROSSING SAFETY--TODAY'S NEEDS: MORE COORDINATION, COOPERATION--AND MONEY*. Railway Age, August 1980. 32p.

TRIS Abstract: Federal funding of grade crossing improvements, currently threatened with cutbacks, is probably the most cost effective highway safety program in terms of casualty reduction. A lack of uniformity in state government support, project appraisal methods, standards for crossing warning devices and responsibility for crossing maintenance complicate the problems. Possibilities are national standardization or improved coordination between governments and the industry. A listing of grade crossing surfaces and comments on warning devices appears separately.

19. Hopkins, J.B. *TECHNOLOGICAL ASPECTS OF PUBLIC RESPONSIBILITY FOR GRADE CROSSING PROTECTION*. Transportation Research Record 514, Transportation Research Board. Washington, D. C.: 1974. pp 33-43.

AUTHOR Abstract: Recent interest in improvement of safety at railroad-highway grade crossings has been accompanied by a growing involvement of government at all levels. Public responsibility typically has been confined to providing funding, developing information, planning, and regulating; the design, installation, and maintenance of automatic protection has been exclusively a railroad activity. This paper examines the technical limitations that constrain public authorities from taking total responsibility for crossing protection devices, which are the only highway traffic control devices that are not the responsibility of highway officials. Research directed toward removal of those limitations is described. A review of the legal history and current role of governmental units precedes a description of conventional technology in terms of impact on a wider public role. Means of train detection and motorist warnings are discussed; the conclusion drawn is that the principal technological impediment to non-railroad responsibility for crossing protection is the present dependence on track circuit techniques for determination of train presence. Recent research directed at removing this constraint is presented. Analysis of system requirements and available technology has identified a discrete train detector-microwave communication link concept, and the results of field testing indicate a number of attractive features and general feasibility.

## VII. WARNING TIME

1. Richards, S.H., Margiotta, R.A. and Evans, GA. *WARNING TIME REQUIREMENTS AT RAILROAD-HIGHWAY GRADE CROSSINGS WITH ACTIVE TRAFFIC CONTROL*. Report No. FHWA-SA-91-007, Federal Highway Administration. Washington, D. C.: February 1991. 99 p.

AUTHOR Abstract: Research was conducted to assess the effects of warning time on driver behavior and safety at rail-highway grade crossings with active traffic control. Warning time is defined as the time between traffic control device activation and train arrival. As part of the research, detailed driver response data from two crossings with flashing light signals and one with gates and flashing light signals were analyzed. In addition, a laboratory assessment of drivers' warning time expectancies and tolerance levels at active crossings was conducted, and relevant warning time practices in six foreign countries were surveyed. The results of the studies and survey were used to develop suggested guidelines for minimum, maximum, and desirable warning times at grade crossings with active traffic control. A computer simulation model was also developed to predict the effects of excessive warning times on crossing violations and motorist delay.

2. Richards, S.H. and Heathington, K.W. *ASSESSMENT OF WARNING TIME NEEDS AT RAILROAD-HIGHWAY GRADE CROSSINGS WITH ACTIVE TRAFFIC CONTROL*. Transportation Research Record 1254, Transportation Research Board. Washington, D. C.: 1990. pp 72-84.

AUTHOR Abstract: Research was conducted to assess the effects of warning time on driver behavior and safety at railroad-highway grade crossings with active traffic control, i.e., flashing light signals with and without automatic gates. The research included (a) an evaluation of driver response data gathered at three grade crossings in the Knoxville, Tennessee, area; and (b) a human factors laboratory study of drivers' warning time expectations and tolerance levels. In the field studies, the actions of over 3,500 motorists were evaluated during 445 train events. Based on the study results, warning times in excess of 30-40 seconds caused many more drivers to engage in risky crossing behavior. The studies also revealed that the large majority of drivers who cross the tracks during the warning period do so within 5 seconds from the time they arrive at the crossing. The human factors studies expanded the findings of the field evaluation. Specifically, the studies revealed that most drivers expect a train to arrive within 20 seconds from the moment when the traffic control devices are activated. Drivers begin to lose confidence in the traffic control system if the warning time exceeds approximately 40 seconds at crossings with flashing light signals and 60 seconds at gated crossings. Based on the research, guidelines for minimum, maximum, and desirable warning times are presented. These guidelines are designed to minimize vehicles crossing during the warning period and promote driver credibility for the active control devices.

3. Richards, S.H., Heathington, K.W., and Fambro, D.B. *EVALUATION OF CONSTANT WARNING TIME USING TRAIN PREDICTORS AT A GRADE CROSSING WITH FLASHING LIGHT SIGNALS*. Transportation Research Record 1254, Transportation Research Board. Washington, D. C.: 1990. pp 60-71.

AUTHOR Abstract: This paper documents the results of field studies conducted to evaluate the effects of train predictors and constant warning time (CWT) on crossing safety and driver response measures. The studies were conducted at a single-track urban crossing controlled by flashing light signals. The test crossing is frequented by variable-speed trains. Before train

predictors were installed, highly variable and long warning times were observed. The studies involved comparing data gathered before and after installation of train predictors at the test crossing. The data included warning times, vehicle clearance times (relative to a train's arrival), vehicles crossing, and vehicles speed and deceleration profiles. These data were collected using video camera-recorder systems that were activated automatically whenever a train approached the test crossing. Data were collected for a 2 month period before the train predictors were installed, and for a 2 month period after installation. A total of 139 train movements were observed -- 89 train movements during the before study and 50 movements during the after study. On the basis of the results of the field studies, the predictor hardware proved to be operationally reliable. Installation of the predictors resulted in more CWTs, a lower mean warning time, and fewer excessively long warning times at the study crossing. Installation of predictors (and the CWT they provide) also improved the overall safety of the study crossing and enhanced driver respect for the flashing light signals. Vehicle clearance times were significantly increased, and risky driver behavior was reduced. Speeds, driver reaction times, and deceleration levels were not influenced adversely.

4. Bowman, B.L. *THE EFFECTIVENESS OF RAILROAD CONSTANT TIME SYSTEMS*. Transportation Research Record 1114, Transportation Research Board. Washington, D.C.: 1989. pp 111-122.

AUTHOR Abstract: Presented in this paper are the results of two tasks of a study sponsored by the Federal Highway Administration. The purpose of these tasks was to determine the effectiveness of railroad constant warning time (CWT) systems in (a) reducing motorists violation of activated at-grade warning systems, and (b) reducing vehicle-train accidents. CWT systems have the capability of measuring train motion, direction of movement, and distance from the crossing. These parameters are interpreted by the control logic to provide estimates of train speed and arrival time. When the estimated arrival time achieves a pre-selected minimum, such as 20 seconds, the warning displays at the crossing are activated. Analysis of operational data indicated that CWT systems are effective in providing both a uniform amount of advance warning and in reducing motorist violation of the warning system. A comparative analysis of vehicle-train accidents occurring from 1980 through 1984 was also performed. This analysis indicted that, in the majority cases, crossings with CWT systems have a lower accident rate than crossings without CWT. Nevertheless, this difference was not large enough to be statistically significant at the 95 percent confidence level.

5. Bowman, B.L. and McCarthy, K.P. *THE USE OF CONSTANT WARNING TIME SYSTEMS AT RAIL-HIGHWAY GRADE CROSSINGS*. Transportation Research Record 1069, Transportation Research Board. Washington, D. C.: 1986. pp 110-117.

AUTHOR Abstract: The results are presented of one task of a study sponsored by FHWA to determine the use and installation criteria of railroad constant warning time (CWT) systems. These systems measure train speed, direction, and distance from the crossing and estimated train arrival time. When a pre-selected minimum estimated arrival time is reached, the warning displays at the crossing are activated. The result is a more uniform warning time until train arrival for motorists than that provided by traditional train detection systems. Results of task

activities indicate that no quantitative guidelines have been established by either the states or the railroads as to when CWT systems should be installed. Switching activity, annual average daily traffic maximum speed, and train speed variation were found to be variables, however, that were inherently considered when the need for CWT installations was determined. The necessary limits on each of these variables or their combinations that justify installation are apparently judgmental and performed on a crossing-by-crossing basis. Using information from the U.S. Department of Transportation (DOT)/ Association of American Railroad (AAR) National Railroad-Highway Crossing Inventory along with the purchasing information supplied by CWT manufacturers, it was estimated that 6,300 crossings already have CWT installations. discriminate analysis indicated that all crossings, 19,400 may require CWT systems, which indicates that an additional 13,100 crossings have the physical and operational characteristics that may require CWT systems.

6. Halkias, J.A. and Eck, R.W. *EFFECTIVENESS OF CONSTANT-WARNING-TIME VERSUS FIXED-DISTANCE WARNING SYSTEMS AT RAIL-HIGHWAY GRADE CROSSINGS*. Transportation Research Record 1010, Transportation Research Board. Washington, D. C.: 1985. pp 101-116.

AUTHOR Abstract: The study objective was to determine the influence of road classification, angle of crossing, and train speed on the effectiveness of fixed-distance and constant-warning-time systems at public rail-highway grade crossings. Data were acquired from the U.S. Department of Transportation-Association of American Railroads Crossing Inventory File and the FRA Accident/Incident Reporting Systems for the period January 1, 1975, through December 31, 1982. Fixed-distance and constant-warning-time systems revealed similar effectiveness values (82 and 85 percent, respectively) when changed from passive devices. For changes from fixed-distance to constant-warning-time systems, the effectiveness value was 26 percent. This result tended to confirm the hypothesis that constant-warning-time systems have greater credibility with motorist than do fixed-distance systems. Functional class of road had no apparent influence on the effectiveness of warning systems for upgrades to fixed-distance systems and constant-warning-time systems. The effectiveness of upgrades in the fixed-distance-to-constant-warning-time class was greatest for the angle-of-crossing category of 0 to 29 degrees (68 percent). For passive-to-fixed-distance and passive-to-constant-warning-time upgrades, effectiveness values in the 60-to-90 degree-angle category were essentially equal to those in the oblique-angle categories (82 percent). For constant-warning-time systems, effectiveness increased with increase in variation of train speed. Train speed, as measured by the concepts of speed ratio and speed difference, had no apparent influence on warning systems effectiveness for either system.

## **VIII. CROSSING CONTROL DEVICES**

1. Coleman, F.,III and Moon, Y.J. *DESIGN OF GATE DELAY AND GATE INTERVAL TIME FOR FOUR-QUADRANT GATE SYSTEM AT RAILROAD-HIGHWAY GRADE CROSSINGS*. Transportation Research Record 1553, Transportation Research Board. Washington, D. C.: 1996. pp 124-131.



AUTHOR Abstract: A design methodology for gate relay and gate interval time for at-grade crossings using four-quadrant gates is developed. The design approach is based on the concept of dilemma zones related to signal change intervals at signalized intersections. The design approach is validated based on data from six sites in Illinois on a proposed high-speed rail corridor. Gate delay and gate interval times are determined that provide an optimal safe decision point to allow a driver to stop before the crossing or to proceed through the crossing without becoming trapped by the exit gates.

2. Gattis, J.L. and Iqbal, Z. *EFFECTIVENESS OF DO NOT BLOCK INTERSECTION SIGNS*. Transportation Research Record 1456, Transportation Research Board. Washington, D. C.: 1994. pp 27-33.

AUTHOR Abstract: On higher-volume streets the traffic queues that form at signalized intersections may back up and block access into or out of side streets and driveways. Owners of abutting businesses and residents whose access is repeatedly denied by these blockages sometimes complain to municipal officials and request police action or a sign prohibiting blocking the intersection. In response to a request from city officials, research was conducted to evaluate the effectiveness of Do Not Block Intersection/Drive signs at four sites. The signs were installed not at signalized intersections, as mentioned in the *Manual on Uniform Traffic Control Devices*, but at unsignalized intersections located in advance of signalized intersections. The number of blockages caused by arterial street traffic was observed at two street intersections and at two commercial driveway intersections. Then, Do Not Block Intersection/Drive signs were installed, and the number of blockages was again recorded. The data indicated that at three of the four sites the sign had no effect on driver behavior; the proportion of blockages did not decrease after the signs were installed. At the fourth site, a higher-volume shopping center driveway, a minimal impact was associated with the installation of the sign. These findings may help officials faced with intersection blockages and citizen complaints avoid unproductive and ineffective remedial actions.

3. *DO NOT STOP ON TRACKS*. Highway and Rail Safety Newsletter, Richards & Associates. College Station, TX.: August 1993.

ANNOTATION: The article describes the need for the sign as a result of traffic control devices installed at nearby highway-highway intersections. The sign could also be useful in construction areas encompassing highway-rail intersections. Reference to the MUTCD includes mention of an alternate installation on the near or far side of an intersection (whichever provides best visibility to the motorist). On multi-lane roadways or one-lane roadways a second sign could be installed on the left side of the road.

4. Curry, J.P. *METRO BLUE LINE FOUR QUADRANT CROSSING GATE DEMONSTRATION PROJECT*. Proceedings: 1993 National Conference on Highway-Rail Safety, St. Louis, MO.: 11-14 July 1993.

RICHARDS Edited Abstract: A project consultant assembled information on four quadrant gate

systems currently operational in the U.S. and Canada. Four quadrant systems are currently in use at three locations. Two of the three locations are at crossings on rail transit lines. Note that none of the three locations have gate systems which operate in the same manner being considered for the MBL demonstration project. In particular, it is proposed for the demonstration project that a vehicle detection system would function to prevent the exit gates from lowering when a vehicle is detected in the track area. This memorandum provides a description of the three locations where four quadrant gates are operational.

5. Mathieu, R. *RAISED MEDIANS AND GRADE CROSSING SAFETY*. Proceedings: 1993 National Conference on Highway-Rail Safety. St. Louis, MO. 11-14 July 1993.

RICHARDS Abstract: The concept of adding medians to existing crossings should become standard practice on the diagnostic reviews made of all crossings. Federal funding could be made available for the low-cost crossing safety enhancements, demonstrating cost-effective applications of simple technology that has a high return on investment value. Finally, it is important to reiterate that in California about 44% of grade crossing accidents in 1991 occurred from cars going around the gates. If this statistic is typical in following years and in other states, it would seem logical that some kind of physical barrier or deterrent, such as raised medians, concrete berms or other similar devices be placed, where feasible, on the streets to significantly reduce at-grade crossing accidents on a nationwide basis.

6. Parnell, S. *THE USE OF HIGHWAY TRAFFIC SIGNALS AT RAILROAD-HIGHWAY GRADE CROSSINGS IN TENNESSEE*. Proceedings: International Symposium on Railroad-Highway Grade Crossing Research and Safety. Knoxville, TN.: 31 October - 3 November 1990. pp 28-31.

RICHARDS Abstract: A study done in Knoxville is discussed in this publication. The study took place on Cedar Lane which is a two-lane arterial in the City of Knoxville. It has an average daily traffic (ADT) volume of approximately 15,000. One of the main lines of the Southern crosses Cedar Lane. Highway traffic signals were field tested for approximately four months at the Cedar Lane crossings. The performance of the highway traffic signals was compared to that of standard flashing light signals which had been in regular use at the crossing. The highway traffic signals proved to be both feasible and effective as a grade crossing traffic control device. Driver response to the highway traffic signals was excellent. The highway signals outperformed standard flashing light signals on key safety measures. Both systems had predictors installed. The report goes on to recommend more testing of traffic signals at additional crossing sites under varying conditions throughout the country.

7. *THE USE OF MEDIAN ISLANDS AT RAIL-HIGHWAY GRADE CROSSINGS*. Highway and Rail Safety Newsletter, Richards & Associates. February 1990. 10p.

ANNOTATION: The article reports the New York DOT provided the only complete response to the FHWA request to furnish information on this subject, and authored a technical note entitled, "Use of Traffic Divisional Islands at Railroad Grade Crossings". The DOT found only two states, Illinois and Georgia, installed traffic median islands at rail-highway grade crossings for

the purpose of preventing motorists from driving around lowered gate arms. NYDOT specifies design situations where such islands may be used, and points out that both the NY state design manual and AASHTO design books contained guidelines and detailed information for traffic lanes. Among the technical note recommendations are 1) need for the divisional barriers should be determined by comprehensive investigation of accident history, volumes, possible need for upgraded track circuits and crossing approach geometry, with consideration given to increased hazard created by the barrier itself; 2) all conventional methods of improving crossing safety should be exhausted before such divisional islands are considered as a viable counter measure.

8. Tignor, S.C. "*A TRAIN IS COMING!*". TR News, Transportation Research Board. Washington, D.C.: March 1990. 5 p.

TRIS Abstract: This article comments briefly on early railroad-highway grade crossing traffic control in the United States, then provides an overview of a research study conducted in 1988 by the Federal Highway Administration and the University of Tennessee on ways to improve safety at grade crossings that are equipped with active warning devices, particularly gate-type systems. One of the objectives of the FHWA study was to evaluate in the field the effectiveness of full barrier or four-quadrant gate systems in which the crossing was closed during the passage of the train. Four-quadrant gates with skirts were installed and evaluated at the Cherry Street grade crossing in Knoxville, Tennessee. The two main measures used to assess the effectiveness of the gate system were the number of violations and clearance time. The operational performance of the four-quadrant gates with skirts was found to be consistent with that for two-quadrant systems. No motorists were trapped on the tracks, and the four-quadrant gates with skirts did not interfere with the operation of emergency vehicles. The estimated added cost of installing four-quadrant gates with skirts, compared with the cost of a standard two-quadrant gate system, is approximately \$32,750, using standard railroad pricing. The additional maintenance cost is about \$740 per year. The study identified five categories for the use of four-quadrant gates with skirts: (1) crossings on four-lane divided roads; (2) multi-track crossings where the distance between tracks is greater than the length of a motor vehicle; (3) crossings without train predictors where train warning times are long and variable; (4) crossings where there are school buses, trucks transporting hazardous materials, or high-speed passenger trains; and (5) crossings with recurring accidents or gate violations.

9. Heathington, K.W., Richards, S.H., and Fambro, D.B. *GUIDELINES FOR THE USE OF SELECTED ACTIVE TRAFFIC CONTROL DEVICES AT RAILROAD-HIGHWAY GRADE CROSSINGS*. Transportation Research Record 1254, Transportation Research Board. Washington, D. C.: 1990. pp 50-59.

AUTHOR Abstract: Guidelines for selecting and installing active traffic devices are beneficial to the practicing engineer who has responsibility for field installation and operation. This paper reports on a portion of the field installation and evaluation of two active traffic control devices for use at railroad-highway grade crossings. As a result, guidelines were developed for the use of a four-quadrant gate system and a highway traffic signal system for use at selected railroad-highway crossings. The characteristics of crossings that would be conducive to the use of a four-quadrant gate system and a highway traffic signal system were defined, with the objective of

improving safety for the traveling public at the crossings. A four-quadrant gate system should be viewed as being between a standard gate system and a grade-separated crossing in terms of providing a level of safety to the traveling public. There are railroad-highway grade crossings that would not be economically feasible to grade separate, but a four-quadrant gate system would be cost-effective. Similarly, there are specific types of crossings that would receive a higher level of safety with the use of a highway traffic signal system and the upgrade would be cost-effective. The guidelines presented address the characteristics of the different types of crossings that would be appropriately served by these two active traffic control systems.

10. Richards, S.H. *DRIVER RESPONSE TO INNOVATIVE RAIL-HIGHWAY WARNING DEVICES*. 1989 National Conference on Rail-Highway Safety. San Diego, CA.: July 9-12, 1989. pp 53-67.

AUTHOR Abstract: In 1986, over 50 percent of all car-train accidents occurred at grade crossings with standard active warning devices, i.e., flashing light signals with and without automatic gates. This percentage is disproportionately high since less than 30 percent of all crossings are equipped with active traffic control. It is recognized that this high number of accidents may be a result of higher vehicle and train volumes and/or more complex railroad-highway geometric at active crossings; however, it is likely that some of the accidents are caused by motorists either not seeing or not understanding the standard active warning devices. Therefore, it seems that these active traffic control devices could be improved. Recognizing the need to fully address the issues and problems concerning active warning devices at railroad-highway grade crossings, the Federal Highway Administration sponsored a research project to identify and evaluate innovative active warning devices with potential for improving safety at grade crossings. As part of the research, two most promising candidate devices were developed and evaluated in the field at actual crossings. One of the innovative active warning devices was a four-quadrant gate and flashing light signal system with skirts. The second was a "modified" highway traffic signal. This paper describes the field studies used to evaluate these two innovative systems and presents the results and major findings of these studies.

11. Fambro, D.B., Heathington, K.W., and Richards, S.H. *EVALUATION OF TWO ACTIVE TRAFFIC CONTROL DEVICES FOR USE AT RAILROAD-HIGHWAY GRADE CROSSINGS*. Transportation Research Record 1244, Transportation Research Board. Washington, D. C.. 1989. pp 52-62.

AUTHOR Abstract: Two active traffic control devices with the potential for improving safety at railroad-highway grade crossings were identified by a detailed laboratory evaluation as candidates for field testing under normal traffic conditions at actual crossings. Two crossings with active warning devices already in place were identified as potential study sites, and train and driver behavior data were collected both before and after the experimental traffic control devices were installed. The two devices evaluated for use at railroad-highway grade crossings were four-quadrant flashing light signals. Based on the results of the field equation, there were no measurable differences in driver behavior between four-quadrant flashing light signals with overhead strobes and the standard two-quadrant flashing light signals. The warning system itself was operationally feasible and may have some limited application. The highway traffic signal

proved to be both feasible and effective as a grade crossing traffic control device. Driver response to the highway traffic signal was excellent, with the traffic signal outperforming standard flashing light signals on several key safety and driver behavior measures of effectiveness. Additional testing of this system is recommended.

12. Heathington, K.W., Fambro, D.B. and Richards, SH. *FIELD EVALUATION OF A FOUR-QUADRANT GATE SYSTEM FOR USE AT RAILROAD-HIGHWAY GRADE CROSSINGS*. Transportation Research Record 1244, Transportation Research Board. Washington, D. C.: 1989. pp 39-51.

AUTHOR Abstract: As part of research to identify and evaluate innovative warning devices with the potential for improving safety at railroad-highway grade crossings, candidate devices were identified and developed, and the most promising devices were evaluated in detailed laboratory studies. Based on the results of the laboratory evaluation, three devices were evaluated in the field at actual crossings. One of the innovative active warning devices evaluated in the field was a four-quadrant gate and flashing light signal system with skirts. A before-and-after study approach was used to evaluate the four-quadrant gate system. Data were collected on measures of effectiveness (MOEs) at the existing crossing with the standard two-quadrant gate system and then again at the same crossing after the four-quadrant gate system had been installed to allow a direct comparison of the impact on the MOEs. With the installation of the four-quadrant gate system, MOEs such as speeds, perception-brake reaction times, and deceleration levels did not indicate a change in driver behavior. There were no measurable safety disadvantages to the four-quadrant gate system as measured by these MOEs. The four-quadrant gate system had no effect on the level of service at the crossing but had a positive effect on driver behavior at the crossing but had a positive effect on driver behavior at the crossing by eliminating risky and illegal behavior as well as violations at the crossing, thus producing superb improvements in safety MOEs. Such benefits are especially important at crossings with limit sight distance, high-speed trains, and multiple tracks.

13. Arens, J.B. *FIELD EVALUATION OF INNOVATIVE ACTIVE WARNING DEVICES FOR USE AT RAILROAD-HIGHWAY GRADE CROSSINGS*. Report No. FHWA/RD-88/135, Turner-Fairbank Highway Research Center. McLean, VA.: January 1988.

RICHARDS Abstract: Research was conducted to identify and evaluate innovative active warning devices with potential for improving safety at railroad-highway grade crossings. Candidate devices were identified and/or developed, and the most promising devices were evaluated in a detailed laboratory study. Three of the devices were chosen for field evaluation: (1) four-quadrant gates with skirts and flashing light signals; (2) four-quadrant flashing light signals with overhead strobes; (3) highway traffic signals with white bar strobes in all red lenses. The report documents the methodology and results of the field evaluations, presents a summary of the research leading up to the field evaluations, and presents the results of benefit-cost analysis for the innovative devices and guidelines for their implementation. All three of the innovative devices proved to be technically feasible and practical, and all three devices were accepted and understood by the driving public. Two of the systems, the four-quadrant gate with skirts and the highway traffic signals, significantly improved crossing safety at the test crossings. The third

system, four-quadrant flashing light signals with strobes, did not produce measurable improvements in safety at the test crossing. Train predictors (and the constant warning time they provide) can have significant positive effects on safety at crossings where flashing light signals or highway traffic signals are used.

14. Baier, J. *THE DESIGN AND SELECTION OF ACTIVE WARNING SYSTEMS FOR RAIL-HIGHWAY CROSSINGS*. Proceedings: 1987 National Conference on Highway-Rail Safety. Denver, CO.: 14-17 September 1987. pp 34-38.

ANNOTATION: A general methodology for selection of crossing warning systems and application of this methodology to specific grade crossing locations in Colorado is discussed. The procedure involves data collection, establishment of general guidelines for component selection, data analysis, consideration of alternatives, and consideration of special factors. A brief background of the legal setting for grade crossing responsibility in Colorado is provided to understand the application of the methodology. General guidelines are followed: (1) Install gates on all main line crossings; (2) use a raised median and for signal placement in urban areas whenever possible for four-lane, or more, roadways; (3) use cantilevers for all four-lane or wider roadways where raised median is impractical; (4) use train activated standard highway traffic signals in place of standard railroad flashing lights when high volume roadways cross industrial spur tracks or leads; (5) interconnect traffic signals to railroad warning signals whenever the traffic queues cross the adjacent crossing; (6) use side lights to supplement warning for adjacent side road traffic; (7) use special additional warning devices to assist in drawing motorists attention to the basic warning system; (8) design for worst case scenario. Special factors are considered including use of constant warning devices, raised medians at urban crossings including four-quadrant gates.

15. *HIGHWAY CROSSING-RUGGED SURFACE AND "SIGN"*. Railway Track and Structures. May 1986. pp 54.

ANNOTATION: High density polyethylene modules are used on Portland, Oregon TRI-MET light rail system grade crossings. The red color of the surface was selected as a warning feature, intended to alert drivers to the crossing.

16. Heathington, K.W., Fambro, D.B. and Rochelle, R.W. *EVALUATION OF SIX ACTIVE WARNING DEVICES FOR USE AT RAILROAD-HIGHWAY GRADE CROSSINGS*. Transportation Research Record 956, Transportation Research Board. Washington, D. C.: 1984. pp 1-4.

AUTHOR Abstract: Six new active railroad-highway grade crossing warning devices were evaluated under controlled laboratory testing conditions. The six devices included two alternatives for each of three basic systems -- four-quadrant gates (with and without skirts), four-quadrant flashing light signals (with and without strobes), and highway traffic signals (with one and with three white bar strobes). The evaluation involved testing the performance of each of the six devices in a near real world environment to identify the three most desirable devices for subsequent field testing. Thirty-two test subjects drove an instrumented vehicle repeatedly over

a private two-lane highway. On each trip down the highway, the test driver encountered three full-scale active warning devices, any one of which may or may not have been actuated as the vehicle approached. The experimental design included different actuation distances as well as day and night conditions. In addition to driver behavior data, attitudinal data on the effectiveness of the six devices were obtained from each subject. All six active warning devices tested were perceived to be superior to standard active warning devices currently in use at railroad-highway grade crossings. Generally speaking, alternative B of each system (i.e., with skirts, with overhead strobes, and with three white bar strobes) was more effective. Four-quadrant gates with skirts tended to be a superior system in all categories of analysis. The relative effectiveness of flashing light signals and highway traffic signals tended to alternate depending on the category of analysis; there was not a consistent ordering of effectiveness of these two systems.

## **IX. INTELLIGENT TRANSPORTATION SYSTEMS (ITS) and FUTURE TRAFFIC CONTROL**

1. Carroll, A.A. and Helser, J.L. *SAFETY OF HIGHWAY-RAILROAD GRADE CROSSINGS RESEARCH NEEDS WORKSHOP, VOLUME I*. Report No. DOT-VNTSC-FRA-95-12.1, U.S. Department of Transportation, Research and Special Programs Administration. John A. Volpe National Transportation Center. Kendall Square. Cambridge, MA. January 1996. 142p.

AUTHOR Abstract: The Federal Railroad Administration (FRA) recently developed the U.S. Department of Transportation's (U.S. DOT) Action Plan for Rail-Highway Grade Crossing Safety. The objective is to achieve at least a fifty-percent reduction in accidents and fatalities at grade crossings over the next ten years. The Action Plan identifies the need for a workshop to develop an intermodal consensus on projected research needs. The John A. Volpe National Transportation System Center hosted and conducted the Highway-Railroad Grade Crossing Safety Research Needs Workshop on April 10-13, 1995. Seventy-five delegates participated in the workshop and identified ninety-two (92) crossing safety related research needs. This document contains results of analysis of the research needs. The results suggest that cost-effective research can be conducted without large expenditures of public funds. Results also indicate most research needs apply to high speed rail and the area of human response to grade crossing applications should receive increased emphasis in the future. Results address relationships among the identified research needs, the Action Plan and current research being conducted. The workshop delegates' consensus is that the workshop was a worthwhile first step in developing an intermodal approach to improving highway-railroad grade crossing safety and the process should continue.

2. Bartoskewitz, R.T. and Richards, H.A. *INTEGRATION OF GRADE CROSSING SAFETY DEVICES AND IVHS ADVANCED TRAFFIC MANAGEMENT SYSTEMS*. The 74th Annual Meeting Transportation Research Board, Paper No. 950273. January 1995. 18p.

AUTHOR Abstract: Increasing railroad traffic levels and the prospects for high-speed rail passenger service on many rail lines require a continued emphasis on highway-railroad grade crossing safety. The United States Department of Transportation's 1994 Plan for rail-highway

safety emphasizes the importance of certain advanced technologies for collision avoidance and traffic law enforcement at highway-railroad grade crossings. Both the highway and railroad industries are studying the use of sophisticated technologies for monitoring and controlling operations. Current investigations into advanced railroad technologies, including Advance Train Control Systems (ATCS), Positive Train Separation (PTS), Automatic Equipment Identification (AEI) automatic grade crossing health and status monitoring, and automated enforcement of grade crossing regulations suggest opportunities for new, innovative practices for highway-railroad safety. The use of computers, sensors, satellite technology, and state-of-the-art communications may produce significant safety benefits at highway-railroad grade crossings.

3. Bartoskewitz, R.T. and Richards, H.A. *CONCEPT FOR AN INTELLIGENT RAILROAD-HIGHWAY GRADE CROSSING TRAFFIC CONTROL SYSTEM*. Texas Transportation Institute. College Station, TX.: March 1995. 1588p.

RICHARDS Abstract: Application of advanced technologies to improve safety at railroad-highway grade crossings is receiving increasing attention in the railroad-highway safety community. The intermodal Surface Transportation Efficiency Act (ISTEA) of 1991 brought new attention to methods of warning drivers in-vehicles of the impending presence of a train. Since that time, a host of IVHS technologies have been suggested which may improve not only safety at the crossing, but traffic operations on the adjacent street and highway network. The key to these systems is the integration of information from the railroad "traffic control system" into advanced traffic management systems and advanced driver information systems. This paper explores the concept of integrating railroad and highway traffic control systems to improve operations and safety at grade crossings, and describes the current status of ongoing research. A basic overview of traffic control technology for railroad-highway grade crossings is presented. Passive and active traffic control systems, train detection technologies, and traffic signal operation on adjacent roadway facilities are discussed. The justification for an intelligent grade crossing traffic control system is based upon inadequacies in how motorists are warned of trains and informed of their responsibilities at passive and active grade crossings, the fail-safe requirements of grade crossing safety systems and the use of track circuit to activate the systems, and the poor degree of coordination between traffic control systems at highway-highway and railroad-highway intersections. Recent developments in Advanced Train Control Systems, Advanced Railroad Electronics Systems, and Positive Train Control and Separation are described. Train positional data extracted from these systems might be used as an input to the intelligent grade crossing. The data would be processed to derive train speed and direction of travel. Given the fixed position of the grade crossing, this information could be used to support many potential safety and operational improvements. These improvements include integration with advanced traffic management systems, automated warnings at the crossing, illumination of the crossing, in-vehicle warning systems, remote monitoring, intrusion detection, and dynamic signing. This information will be useful to persons engaged in transportation safety, traffic operations, and intermodal applications of IVHS technologies.

4. Miyachi, M. *OBSTRUCTION DETECTOR ON A ROAD-RAILWAY CROSSING USING ULTRASONIC WAVE*. Railway Technical Research Institute, Quarterly Reports, Vol. 33, No.3. August 1992.



RICHARDS Abstract: Future level crossing protection measures from a standpoint of enhancing safety should include not only intensification and improvement of the current level crossing equipment but also measures such as, in particular, installation of obstruction detectors. This paper reviews the problems with level crossings in Japan and the countermeasures; the relations between level crossing obstruction detection and accident prevention; and current systems for crossing obstruction detection. Lastly, all-weather crossing obstruction detector using ultrasonic waves is described. This detector can be installed even at level crossings in snowy regions.

5. Boutry, F., Postaire, J.G. and Viern, C. *IMAGE PROCESSING APPLIED TO THE DETECTION OF OBSTACLES AT INTERSECTIONS*. INRETS Center of Research, Transport Security (French Publication). Lille, France: June 1989. 1485p.

RICHARDS Abstract: The obstacle detection system presented in this paper, when used with other sensors, should make it possible for automatic surface transportation systems to be used in general purpose traffic infrastructure (streets). As a result of the research presented in this paper there is now a laboratory system for traffic detection and vehicle control using image analysis with performance levels that approach that of a human driver, as far as the certainty of detection and the reaction time are concerned.

6. Hopkins, J.B., Hazel, M.E. *TECHNOLOGICAL INNOVATION IN GRADE CROSSING PROTECTIVE SYSTEMS*. DOT-TSC-FRA-71-3 Tech Rpt. Transportation Systems Center. Cambridge, MA, June 1971, 89p.

AUTHOR Abstract: The constraints on innovative grade crossing protective systems are delineated and guidelines for development indicated. Inventory data has been arranged to permit an estimate of the classes of systems needed, the allowable costs, and contribution of various types of crossings to accidents. A number of approaches are discussed for the intermediate cost classes, based on use of conventional signals with low-cost activation systems. Use of similar elements, singly or in combination, is suggested to improve effectiveness of more expensive systems. The very high cost locations may well benefit from interconnection of train and vehicle detectors and small computers. Extensive analysis and laboratory investigation has been carried out relating to a microwave telemetry alternative to conventional track circuits and possible crossing-located radar and impedance train detection systems.



# **Appendix G**

## **Advance Warning Sign for High-Profile Crossings**



Advance Warning Sign  
for High-Profile Crossings

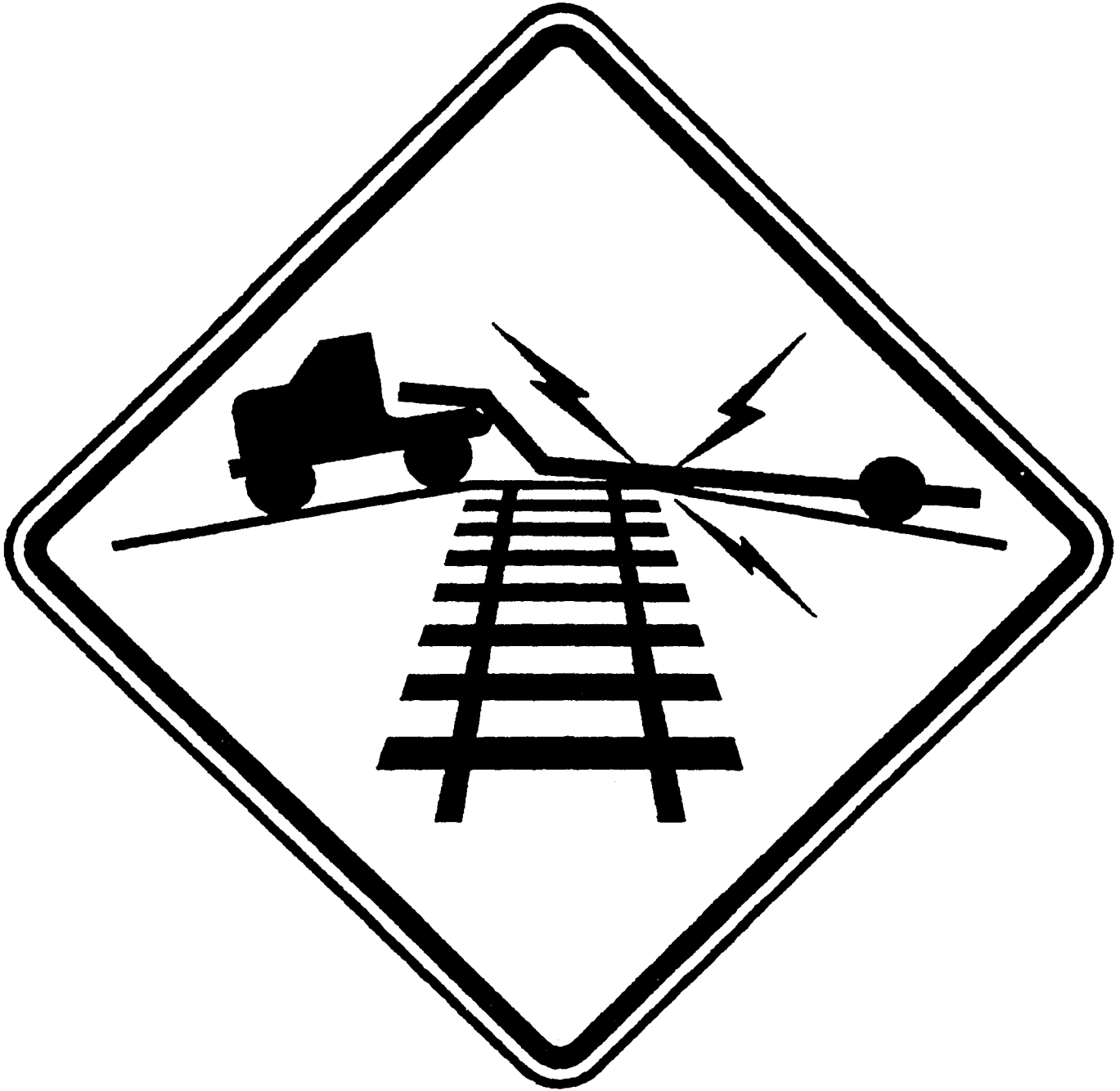

W10-5

The January 9, 1997, Vol. 62, No. 6 Federal Register published final amendments to the Manual on Uniform Traffic Control Devices (MUTCD). This included Request II-120 (C) -- "Standard Warning Signs for Substandard Vertical Curves Over Railroad Crossing (W10-5)."

"The FHWA is adopting a new advance symbol sign for railroad grade crossings where conditions are sufficiently abrupt to create a hang-up of long wheelbase vehicles or trailers with low ground clearance. The MUTCD already contains provisions for the placement of special word message signs where there is a need to give advance notice of special hazardous conditions at railroad grade crossings. Based on conducted research, the FHWA amends the MUTCD to also include the following new warning symbol sign for 'Low Ground Clearances' (W10-5) which may be used at these special locations.

This symbol is used by the New York State Department of Transportation (NYSDOT) and is similar to the research symbol tested and found to be acceptable with the truck driver population. Sometimes a change from word messages to symbols requires time for public education and transition. New warning and regulatory symbol signs such as this that may not be readily recognizable by the public, shall be accompanied by an educational plaque which is to remain in place for at least 3 years after initial installation. Advisory messages and speed plates may also be used to supplement these signs. The appropriate color is yellow background with black symbol and border. This information is included as a new section 8B-11 to the MUTCD.

Since the decision for a State or local highway jurisdiction to use this sign is optional, no additional costs are imposed."

Text Changes to the 1988 Edition of the MUTCD as Discussed in Docket No. 95-8, Final Rule -  
- Adds the following new section: 8B-11 Low Ground Clearance Crossings (W10-5)

"Rail-highway grade crossings with a sharp rise or depression in the profile of the road near the rails may require additional signing. Whenever conditions are sufficiently abrupt to create a hang-up of long wheelbase vehicles or trailers with low ground clearance, the 'Low Ground Clearance' (W10-5) warning symbol sign shall be installed in advance of the crossing. New warning symbol signs such as this which may not be readily recognizable by the public, shall be accompanied by an educational plaque which is to remain in place for at least 3 years after initial installation (see section 2A-13). The appropriate color of this sign is yellow background with black symbol and border. A supplemental message such as 'Ahead,' 'Next Crossing,' or 'Use Next Crossing' (with appropriate arrows) should be placed at the nearest intersecting road where a vehicle can detour or at a point on the roadway wide enough to permit a U-Turn.

There are some rail-highway grade crossings where engineering investigation of roadway geometric and operating conditions confirm that vehicle speeds across the railroad tracks should be at least 10 mph below the posted speed limit. To insure that the vehicle driver does not lose control while using the crossing, word message signs such as 'Bump,' 'Dip,' or 'Rough Crossing' with an advisory speed plate is an appropriate installation treatment. Information on railroad ground clearance requirements is also available in the American Railway Engineering Association Section 8.1.2 or the American Association of State Highway and Transportation Official's Policy on Geometric Design of Highway and Streets."

# **Appendix H**

## **Survey Form on Best Practices**





Dear Respondent:

Following the tragic highway-rail crossing accident involving a school bus and a commuter train in Fox River Grove, Illinois in October of 1995, a Grade Crossing Safety Task Force was formed within the United States Department of Transportation (USDOT) to review the decisionmaking process for the design, construction, maintenance and operation of highway-rail crossings. A report was issued on March 1, 1996.

One of the identified problems was that of so-called high-profile crossings; highway-rail crossings at which there is an abrupt change in the level of the road's surface as it crosses the tracks, thus posing the risk of a vehicle becoming stuck on the tracks. A recommendation was that the Federal Railroad Administration (FRA) should work with the Federal Highway Administration (FHWA), the railroad industry and national/State transportation associations to develop guidelines that establish maximum thresholds for post-maintenance vertical alignment of highway-rail crossings.

To facilitate work on this recommendation, a task group has been formed with representation from the American Association of State Highway Transportation Officials (AASHTO), the Association of American Railroads (AAR), the American Railway Engineering Association (AREA), the American Short Line Railroad Association (ASLRA), and representatives from FHWA and FRA. In order to assist the task group, it is extremely important that we develop baseline information on issues affecting the vertical alignment of highway-rail crossings following railroad or highway maintenance. To accomplish this, a check-off survey form has been designed which addresses specific points of interaction and understanding between railroad and highway authorities.

We appreciate that not every question applies specifically to your jurisdiction. We ask, however, that you attempt to answer all questions to the best of your ability. Please complete the attached form and return to [ ] by July 1, 1997. If you believe that your jurisdiction, or local/State laws, provides good working guidelines for the problem of high-profile crossings, please feel free to so indicate on the survey form and include them with your response. If you would like to be contacted to provide further advice on this matter, please place your name and telephone number on the questionnaire.

Your cooperation in this important aspect of highway-rail crossing safety is greatly appreciated.

**RESPONDING RAILROAD**

- Class 1       Class 2       Class 3

This questionnaire is designed to gather information from railroads on issues which affect the vertical alignment of highway-rail crossings following railroad or highway maintenance at these locations. For purposes of this questionnaire the following definitions will apply:

*Railroad maintenance is defined as: "The change in profile and/or alignment of the track within the highway-rail crossing due to replacement of crossties, changing the rail, and/or resurfacing."*

*Highway maintenance is defined as: "The resurfacing of the highway approaches to the highway-rail crossing."*

- 1.) Which issues inhibit your ability to effectively work with the highway authority to obtain the best possible vertical alignment following maintenance? Check each issue which applies in your case.  
 Communications       Scheduling       Budget       Lack of Engineering Guidelines       No Problem
- 2.) How much advance notice would generally be required to properly prepare and schedule work required to be done by the railroad as a result of highway initiated maintenance to the highway-rail crossing?  
 1 Day       1 Week       1 Month       Other \_\_\_\_\_
- 3.) How much advance notice is generally given to the highway in order to prepare and schedule any work required as a result of railroad initiated maintenance which affects the approach grade to a highway-rail crossing?  
 1 Day       1 Week       1 Month       Other \_\_\_\_\_
- 4.) Does the railroad which you represent have an effective line of communication established with the highway authorities within your jurisdiction?  
 Yes       No       With Some Only
- 5.) Would an established line of communications between the railroad and the highway authority facilitate improved post-maintenance vertical alignment at highway-rail crossings?  
 Yes       No
- 6.) Presently, which location best represents your understanding of where railroad maintenance responsibility ends and highway authority maintenance responsibility begins at highway-rail crossings?  
 End of Tie       30 Feet from Rail       Highway Stop Line       RR ROW Line
- 7.) Would the establishment of recommended practice guidelines for post-maintenance vertical alignment serve to lessen the creation of crossings which pose a hazard to low-clearance vehicles?  
 Yes       No       Possibly       Most Likely
- 8.) For the post-maintenance recommended practice guideline referenced in Question No. 7 to be effective, would it be necessary for the highway authority and the railroad to jointly evaluate existing conditions of vertical alignment prior to the commencement of any maintenance work?  
 Yes       No       Possibly       Most Likely
- 9.) For any post-maintenance recommended practice guidelines which may be developed, should there also be a recommended procedure(s) which identifies how the vertical alignment of highway-rail crossings should be measured?  
 Yes       No       Possibly       Most Likely

**[OPTIONAL]** Please contact me for further advice on this matter:

Name \_\_\_\_\_ Railroad \_\_\_\_\_ Telephone No. \_\_\_\_\_

**[OPTIONAL]** If you would like to receive a copy of the survey results, please provide your mailing address below:

**RESPONDING HIGHWAY AUTHORITY**

State       County       City       Village/Town       Other \_\_\_\_\_

This questionnaire is designed to gather information from highway authorities on issues which affect the vertical alignment of highway-rail crossings following railroad or highway maintenance at these locations. For purposes of this questionnaire the following definitions will apply:

**Railroad maintenance is defined as:** "The change in profile and/or alignment of the track within the highway-rail crossing due to replacement of cross-ties, changing the rail, and/or resurfacing."

**Highway maintenance is defined as:** "The resurfacing of the highway approaches to the highway-rail crossing."

- 1.) Which issues inhibit your ability to effectively work with the railroad to obtain the best possible vertical alignment following maintenance? Check each issue which applies in your case.  
 Communications       Scheduling       Budget       Lack of Engineering Guidelines       No Problem
- 2.) How much advance notice would generally be required to properly prepare and schedule work required to be done by the highway authority as a result of railroad initiated maintenance to the highway-rail crossing?  
 1 Day       1 Week       1 Month       Other \_\_\_\_\_
- 3.) How much advance notice is generally given to the railroad in order to prepare and schedule any work required as a result of highway initiated maintenance which affects the approach grade to a highway-rail crossing?  
 1 Day       1 Week       1 Month       Other \_\_\_\_\_
- 4.) Does the highway authority which you represent have an effective line of communication established with the railroads within your jurisdiction?  
 Yes       No       With Some Only
- 5.) Would an established line of communications between the railroad and the highway authority facilitate improved post-maintenance vertical alignment at highway-rail crossings?  
 Yes       No
- 6.) In cases where the highway authority is unable to commit funds or resources to make adjustments to the highway approach grade following crossing maintenance, and this work is performed by the railroad or its contractor, would the highway authority provide supervisory oversight to this work?  
 Yes       No       Possibly       Most Likely
- 7.) Presently, which location best represents your understanding of where highway authority maintenance responsibility ends and railroad maintenance responsibility begins at highway-rail crossings?  
 End of Tie       30 Feet from Rail       Highway Stop Line       RR ROW Line
- 8.) Would the establishment of recommended practice guidelines for post-maintenance vertical alignment serve to lessen the creation of crossings which pose a hazard to low-clearance vehicles?  
 Yes       No       Possibly       Most Likely
- 9.) For the post-maintenance recommended practice guideline referenced in Question No. 8 to be effective, would it be necessary for the highway authority and the railroad to jointly evaluate existing conditions of vertical alignment prior to the commencement of any maintenance work?  
 Yes       No       Possibly       Most Likely
- 10.) For any post-maintenance recommended practice guidelines which may be developed, should there also be a recommended procedure(s) which identifies how the vertical alignment of highway-rail crossings should be measured?  
 Yes       No       Possibly       Most Likely

**[OPTIONAL]** Please contact me for further advice on this matter:  
Name \_\_\_\_\_ Agency \_\_\_\_\_ Telephone No. \_\_\_\_\_

**[OPTIONAL]** If you would like to receive a copy of the survey results, please provide your mailing address below:



# **Appendix I**

**DRAFT Recommendations for  
Barrier Medians for TCRP  
Project A-13, Light-Rail Service  
Pedestrian and Vehicular Safety**



## **DRAFT Recommendations from a FTA Funded TCRP Project (A-13) Light-Rail Service Pedestrian and Vehicular Safety**

On roadway approaches to LRT grade crossings, use raised medians with barrier (non-mountable) curbs where roadway geometry and widths allow. Where raised medians are installed, bollards (typically steel posts about 1000-mm (40-in.) tall with a diameter of about 200-mm (8-in.)) may be necessary between a double set of LRT tracks to discourage motorists from turning through the break in the raised median at the crossing. Most collisions between LRVs and motor vehicles occur because motorists choose to drive around lowered (horizontal) automatic gate arms. However, in some cases it may not be physically possible to install raised roadway medians, such as on roadway approaches that are not wide enough to accommodate a raised median\* or on roadway approaches that intersect with another roadway immediately before the LRT grade crossing.

\*According to the MUTCD, 1988 ed., Section 5B-2, raised median islands should be no less than 4 feet wide and 20 feet long. In special cases where space is limited, elongated islands may be as narrow as 2 feet, except where used as pedestrian refuge areas, and as short as 12 feet. Thus, if installing a raised median island on an approach to an LRT grade crossing, the roadway must accommodate a minimum of 2 feet extra width from face of curb to face of curb.

For those approaches to LRT crossings where the roadway is not physically wide enough to construct a raised median with barrier curbs, other traffic channelization devices should be considered. For example, 100-mm (4-inch) tall traffic dots or 900-mm (36-in) tall flexible posts mounted along the double yellow striping in the middle of a narrow roadway also discourage motorists from driving around lowered automatic gate arms, even though they are more easily defeated than a raised median with barrier curbs. Raised channelization devices, especially traffic dots, should be used with caution in environments where snow or ice is likely, as the dots would be easily removed or destroyed by snow plow equipment (flexible posts are more appropriate for this type of environment). At those crossings with an immediately adjacent parallel roadway and a high occurrence of vehicles driving around lowered automatic arms, photo enforcement\*\* could significantly reduce grade crossing violations and improve accident experience.

\*\*Photo enforcement at grade crossings uses vehicle presence monitoring (e.g. loop detectors or video imaging) to detect if a vehicle drives around the tip of a lowered automatic gate arm. If a vehicle is detected by the system, an image of the vehicle's license plate and driver are captured and sent to the state's department of motor vehicles for processing. A traffic citation is then issued in the mail.

Moreover, because raised medians are not possible with an immediately adjacent parallel roadway, traffic turning right or left from this parallel roadway and through an LRT crossing should be controlled by one or more of the following devices: 1) protected (arrow) traffic signal indications, 2) LRV-activated No Right/Left Turn signs (R3-1, 2), 3) automatic gate placement on the crossing roadway (this is only applicable if the crossing roadway is at an angle other than 90 degrees relative to the LRT tracks), 4) special right/left turn automatic gates (on the parallel roadway), and/or 5) flashing light signals aligned for motorists approaching the LRT crossing on the parallel roadway.

Left turns from a parallel roadway through an LRT crossing are especially critical to control. Because motorists on the parallel roadway essentially look down the length of the gate arm that blocks traffic approaching on the crossing roadway, one or more of the devices listed above should be installed. Without appropriate control, motorists may unintentionally drive around the tip of the lowered automatic gate arm in the crossing quadrant not blocked by an automatic gate. At angled crossings (i.e., those crossings where the roadway and LRT tracks are not perpendicular), it may be possible to adjust the angle of the automatic gates on the crossing roadway to more effectively block these left turns (automatic gates parallel to the LRT tracks). If the left turns cannot be effectively blocked using this technique and for LRT crossings at 90 degrees with respect to the roadway, left turn automatic gates should be considered for installation.



# **Appendix J**

## **Special Vehicle Permit Pamphlet**



**Important Telephone Numbers**

( for notification purposes or to assist in meeting the requirements of F.S. 316.170 )

AMTRAK ..... (800) 232-0144

THE BAY LINE RAILROAD, LLC  
..... (904) 785-4609

APALACHICOLA NORTHERN RAILROAD  
COMPANY ..... 8a-5p (904) 229-7411  
..... 5p-8a (904) 648-4412

BURLINGTON NORTHERN SANTA FE  
RAILWAY COMPANY ..... (800) 832-5452

CSX TRANSPORTATION, INC. ....  
..... (800) 232-0144

FLORIDA DEPARTMENT OF  
TRANSPORTATION- RAIL OFFICE  
..... (904) 488-5704

FLORIDA MIDLAND, CENTRAL, and  
NORTHERN RAILROADS  
..... 8a-5p (407) 880-8500  
..... 5p-8a (407) 849-7898

FLORIDA EAST COAST RAILWAY  
COMPANY ..... (800) 342-1131 ext.2302

FLORIDA WEST COAST RAILROAD  
COMPANY ..... 8a-5p (352) 463-1103

GEORGIA and FLORIDA RAILROAD  
COMPANY ..... 6a-midnight (912) 435-6629

NORFOLK SOUTHERN RAILWAY  
CORPORATION..... (800) 946-4744

SEMINOLE GULF RAILWAY  
..... (941) 275-6060

SOUTH CENTRAL FLORIDA EXPRESS  
..... 6a-10p (941) 983-3163  
..... 10p-6a (941) 983-3348

TRI-COUNTY COMMUTER RAIL  
AUTHORITY ..... (800) 232-0144

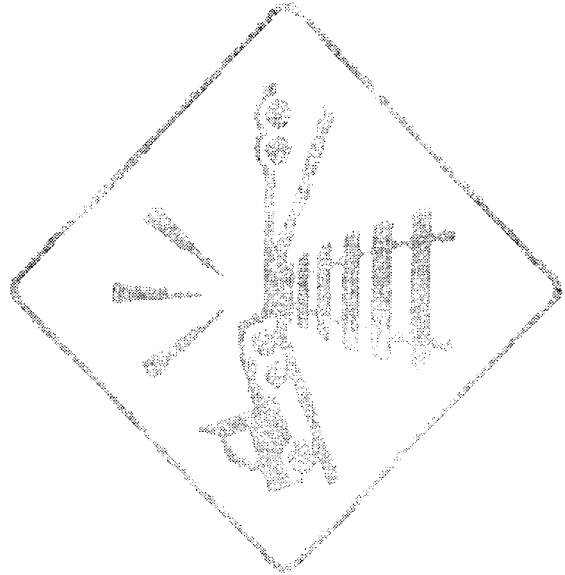

Florida Department of Transportation  
605 Suwannee Street, MS-25  
Tallahassee, FL 32399-0450  
(904) 488-5704 Suncom: 278-5704  
Fax: (904) 922-4942 Suncom: 292-4942

Page J-1

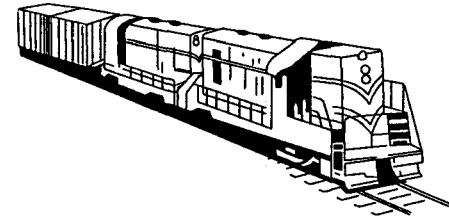
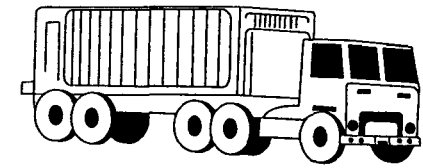

# Florida DOT Low Clearance Information

*Don't get hung up  
on the tracks!!!!*

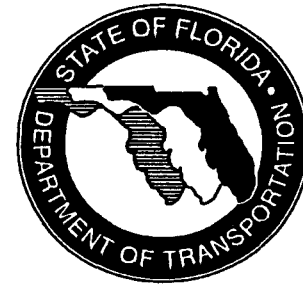

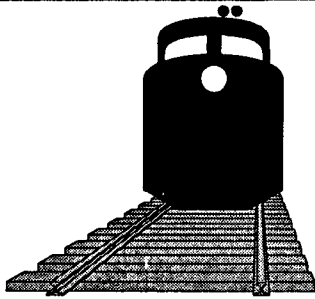

The most important information you can provide to response personnel is the AARDOT crossing identification number which should be located on the crossbuck sign post, the signal mast, or the control box. Here is an example of an identification number:

**CSXT  
624789N**

U.S. DOT - AAR CROSSING INVENTORY NUMBER

If you are unable to find the AARDOT crossing identification number, please remember to provide as much information as you can about the location of the crossing.

Page J-2

**You need to know that:**

- + Trains may appear from either direction at any time.
- + Trains may take a mile (5280 feet) or more to stop.
- + You should not step on or walk along the rails.
- + Every 90 minutes a car/train crash occurs in the U.S.
- +Source: National Operation Lifesaver, Inc.

Florida law allows for \$100 in fines for violations at highway-rail grade crossings.

If your vehicle stalls or gets hung up on the railroad tracks or stalls within 15 feet of the tracks, you should get out of your vehicle and call for help immediately. **If a train is coming** and your vehicle gets hung up on the tracks or stalls within 15 feet of the tracks, you should get out of your vehicle **immediately** and run away from the track toward the direction from which the train is coming. This will help you avoid flying glass and debris which can be extremely hazardous in the event of a collision.

*Remember . . .*

*only the driver can prevent crossing hang ups on low clearance vehicles.*



**For Emergencies Call:**

- (1) Local Police ..... 911
- (2) Florida Highway Patrol  
Primary {cellular phones} ..... \*FHP  
Alternate ..... (800) 525-5555
- (3) Florida Division of Emergency Management ..... (800) 320-0519

**Florida Statute 316.170:**

**Moving heavy equipment at railroad grade crossings.**

(1) No person shall operate or move any crawler-type tractor, steam shovel, derrick, or roller or any equipment or structure having a normal operating speed of 10 or less MPH or a vertical body or load clearance of less than 1/2 inch per foot of the distance between any two adjacent axles or in any event of less than 9 inches, measured above the level surface of a roadway, upon or across any tracks at a railroad grade crossing without first complying with this section.

(2) Notice of any such intended crossing shall be given to a station agent or other proper authority of the railroad, and a reasonable time shall be given to the railroad to provide proper protection at the crossing.

(3) Before making any such crossing the person operating or moving any such vehicle or equipment shall first stop the same not less than 15 feet nor more than 50 feet from the nearest rail of the railroad and while so stopped shall listen and look in both directions along the track for any approaching train and for signals indicating the approach of a train, and shall not proceed until the crossing can be made safely.

(4) No such crossing shall be made when warning is being given by automatic signal or crossing gates or a flagger or otherwise of the immediate approach of a railroad train or car. If a flagger is provided by the railroad, movement over the crossing shall be under his or her direction.

# **Appendix K**

## **List of TWG Participating Agencies and Organizations**



## **List of TWG Participating Agencies and Organizations**

United States Department of Transportation, USDOT  
Federal Highway Administration, FHWA  
Federal Railroad Administration, FRA  
Federal Transit Administration, FTA  
National Highway Transportation Safety Administration, NHTSA

American Association of State Highway and Transportation Officials, AASHTO  
American Association of Motor Vehicle Administrators, AAMVA  
Association of American Railroads, AAR  
American Public Works Association, APWA  
American Railway Engineering Association AREA  
American Short Line Railroad Association, ASLRA  
American Traffic Safety Services Association, ATSSA  
American Trucking Association, ATA  
Brotherhood of Locomotive Engineers, BLE  
Brotherhood of Railroad Signalmen, BRS  
Illinois Commerce Commission  
Institute of Transportation Engineers, ITE  
International Association of Chiefs of Police, IACP  
National Association of County Engineers, NACE  
National Committee on Uniform Traffic Control Devices, NCUTCD  
National School Transportation Association NSTA  
National Sheriffs Association  
National Transportation Safety Board  
Operation Lifesaver, Inc., OLI  
Railway Progress Institute, RPI  
Truck Trailer Manufacturers Association  
Volpe Center





# **Appendix L**

## **List of TWG Recommendations**



# Recommendations Made by TWG

## Terminology

1. The TWG recommends the Department and other parties use the definitions for the following fifteen terms in all future standards (including MUTCD) guidance publications (including the revised Railroad-Highway Grade Crossing Handbook) and correspondence:

- *Minimum Track Clearance Distance*
- *Clear Storage Distance*
- *Preemption*
- *Interconnection*
- *Monitored Interconnected Operation*
- *Minimum Warning Time - Through Train Movements*
- *Right-of-Way Transfer Time*
- *Queue Clearance Time*
- *Separation Time*
- *Maximum Preemption Time*
- *Advance Preemption and Advance Preemption Time*
- *Simultaneous Preemption*
- *Pre-Signal*
- *Cantilevered Signal Structure*
- *Design Vehicle*

## Twenty Second Minimum Warning Time

2. The TWG recommends practitioners continue to use the existing 20 second minimum warning time as a minimum plus additional time added as determined by AAR's Signal Manual, FHWA's research, and site specific studies.

3. The TWG recommends additional studies are warranted to provide a procedure to determine the optimum safe warning time for railroad-highway grade crossings. The procedure must take into consideration that excessive time could encourage gate runners.

## Interconnected Signals

4. The TWG recommends practitioners use guidance found in ITE's RP, *Preemption of Traffic Signals at or Near Railroad Grade Crossings with Active Warning Devices*, or other current research findings, when planning and designing preemption systems.

5. *The TWG recommends practitioners consider interconnecting existing traffic signals to railroad-highway grade crossings: when traffic queues routinely back up to the crossing during congested traffic periods; when railroad warning devices and highway traffic controls are added or revised; and when tracks are close to a parallel highway.*

6. *The TWG recommends the FHWA examine and evaluate a new MUTCD traffic signal warrant based on preemption requirements with nearby railroad warning devices.*

### **Types of Preemption**

7. *The TWG recommends the FHWA provide additional detailed guidance in the revised Railroad-Highway Grade Crossing Handbook on how to evaluate and design a cost-effective and safe preemption system, based on site conditions.*

8. *The TWG recommends FHWA add general guidance on the types and design of preemption to the MUTCD.*

9. *The TWG recommends experimentation and evaluation be conducted to determine the effectiveness of a sign to warn pedestrians of shortened crossing times at locations where simultaneous preemption is used.*

### **Pre-Signals**

10. *The TWG recommends the FHWA add the following wording to the MUTCD: "If a pre-signal is installed at an interconnected railroad-highway grade crossing near a signalized intersection with a storage problem, a NO TURN ON RED sign should be used."*

11. *The TWG recommends the FHWA include detailed guidance in the revised Railroad-Highway Grade Crossing Handbook on how to evaluate the need and design of pre-signals.*

12. *The TWG recommends the FHWA include general guidance in the MUTCD describing pre-signal operation.*

13. *The TWG recommends research be conducted to determine the effectiveness of gates when pre-signals are installed.*

### **Design Vehicle**

14. *The TWG recommends research is warranted on current truck characteristics because a gap in knowledge exists.*

15. *The TWG recommends the FHWA and other parties include updated design guidance on vehicle characteristics and acceleration to reflect current research in the revised Railroad-Highway Grade Crossing Handbook and other parties' handbooks.*

### **Storage Distance Signing**

16. *The TWG recommends practitioners use a storage distance warning sign as an interim measure prior to installation of a pre-signal.*

17. *The TWG recommends further evaluation and MUTCD sanctioned experiments should be conducted to determine the most effective signs for active and passive crossings to warn or regulate motorists about clear storage distance at preempted intersections.*

### **Storage Distance Pavement Markings**

18. *The TWG recommends further evaluation and MUTCD sanctioned experiments be conducted to determine the most effective pavement markings for active and passive crossings to warn or regulate motorists about the clear storage distance and the minimum track clearance distance at preempted intersections.*

### **Pavement Markings**

19. *The TWG recommends examinations and evaluations be done to determine if other types of pavement marking colors, patterns, areas of coverage, and stop bar placements can be applied at railroad-highway grade crossings.*

### **Reducing Gate Running**

20. *The TWG recommends additional examinations and evaluations be done to determine the most effective treatment at railroad-highway grade crossings to reduce gate running including: median barriers; flexible delineators; 4 quadrant gates; and others.*

21. *The TWG recommends the FHWA include general guidance on gate-running and preventive treatments in the MUTCD.*

22. *The TWG recommends the FHWA include detailed design guidance on the types of treatments available for reducing railroad-highway grade crossings violations in the revised Railroad-Grade Crossing Handbook.*

### **Crossing Identification Sign**

23. *The TWG recommends the sign placement should be decided cooperatively by the railroad and road authority based on the specific site conditions.*

## **Identifying & Treating High-Profile Crossings**

*24. The TWG recommends local practitioners identify and sign known high-profile locations as an interim solution.*

*25. The TWG recommends the State Focal Point should foster the effort of identifying, placing in the national inventory, signing and prioritizing the elimination of high-profile crossings.*

## **Periodic Joint Inspections**

*26. The TWG recommends that highway-railroad/light-rail practitioners conduct joint annual on-site inspections.*

*27. The TWG recommends joint inspections should include, but not limited to:*

- review of circuit and timing plans to determine compliance with the mutually approved interconnection design; and*
- activation of the active railroad warning system while observing the highway traffic signal(s) to confirm the maximum preemption time for the traffic signal operation for through train movements.*

*28. The TWG recommends practitioners post a warning placard (or other similar form mutually agreed upon by the highway agency and railroad/transit agency) in all highway traffic signal controller cases and bungalows.*

## **Other Joint Coordination**

*29. The TWG recommends practitioners review changes affecting the interconnection of traffic signals to the active railroad warning system, i.e., required minimum warning time and maximum preemption time, during the planning and design of new or upgraded hardware and software improvements.*

*30. The TWG recommends practitioners notify other party(ies) and, if necessary, schedule a meeting before modifying any operation which connects to or controls the timing of an active railroad warning system and/or timing and phasing of a traffic signal.*

*31. The TWG recommends the State Focal Point should foster improving communication and coordination, including periodic meetings between parties.*

*32. The TWG recommends practitioners include the maximum preemption time on new or revised railroad circuit plans and traffic signal timing plans.*

### **Additional Topics Discussed by the TWG**

*33. The TWG recommends organizations and agencies responsible for developing and conducting training incorporate the TWG recommendations into their curriculum on railroad-highway grade crossings.*

*34. The TWG recommends practitioners consider the benefits partnering can play in improving safety at their railroad-highway grade crossings and use Operation Lifesaver resources and programs.*

*35. The TWG recommends ITS technology should be developed and evaluated for improved monitored interconnected operations.*





# **Appendix M**

## **Pre-Signal Diagram**



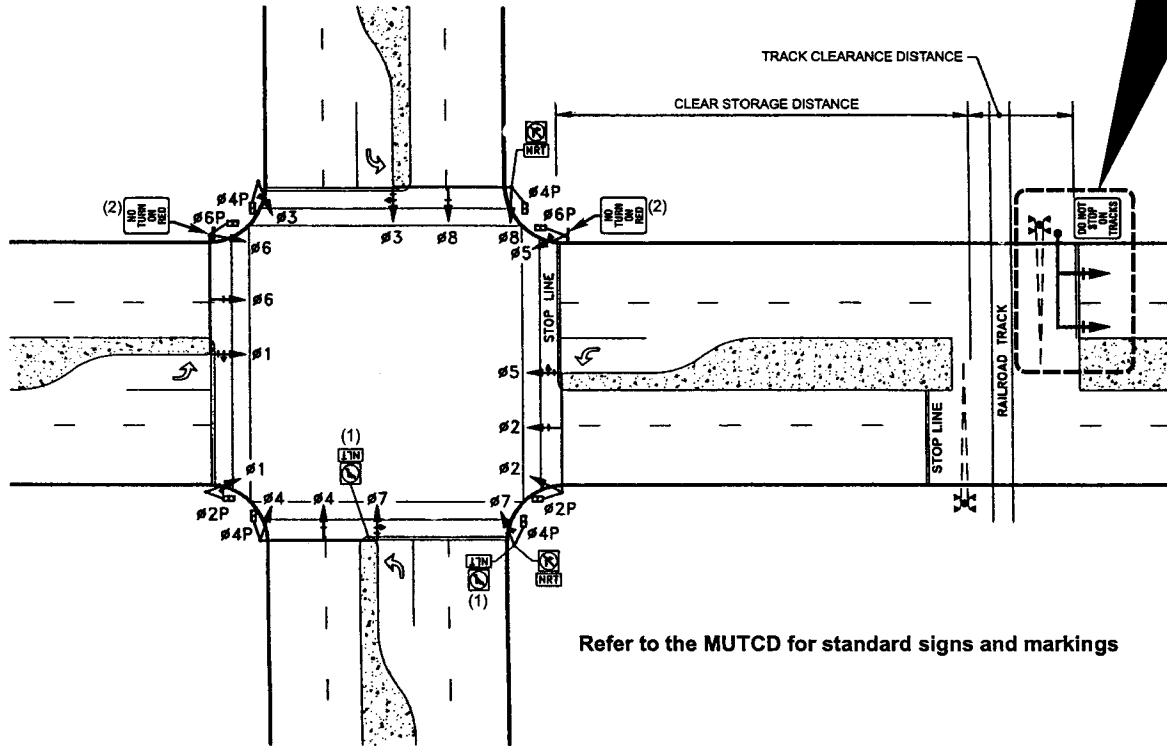
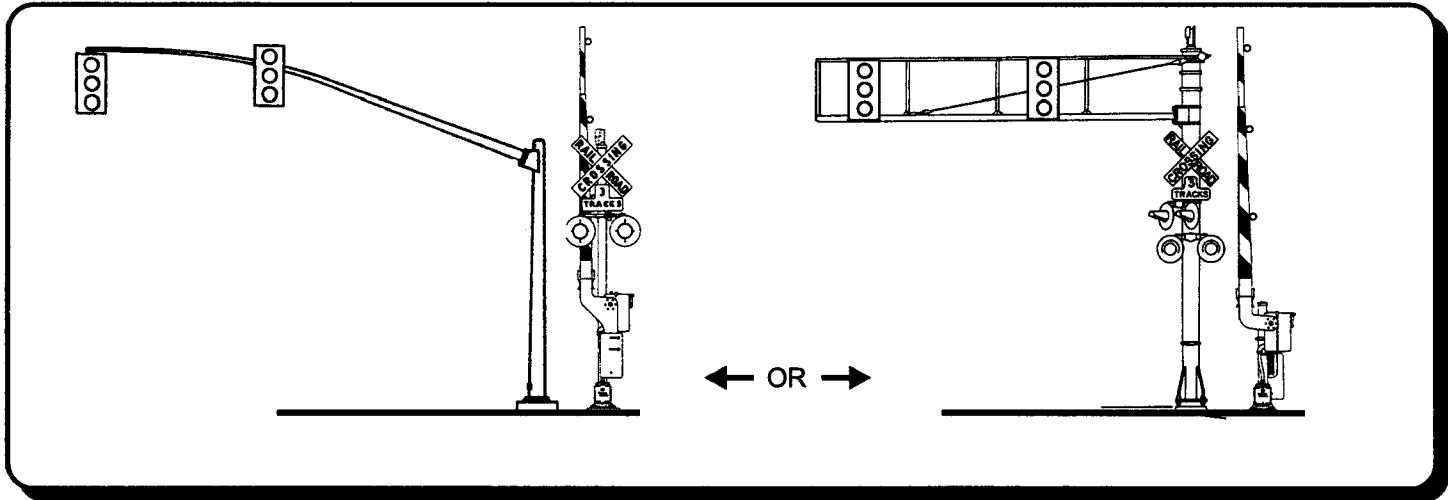

Refer to the MUTCD for standard signs and markings

**LEGEND**

- 5 Section Signal Face with Arrow Indications
- Signal Face
- Pedestrian Signal Face
- Standard with Traffic Signal Mast Arm
- "NO RIGHT TURN" symbol sign\*
- "NO LEFT TURN" symbol sign\*
- R.R. Flashing Light Signals & Automobile Gate (Optional)

\* Variable message type; black if no train present

**NOTES**

- (1) "NO LEFT TURN" symbol signs are only required if left turns are permissive (no ø7 arrow indications).
- (2) "NO TURN ON RED" signs may be necessary if the Clear Storage Distance is not long enough to accommodate motor vehicles turning right on red without encroaching into the Track Clearance Distance. The need for the far side sign should be based on site conditions.

**PRE-SIGNAL DIAGRAM**

which also depicts Clear Storage Distance, Track Clearance Distance, and NO TURN ON RED Sign



# **Appendix N**

## **Advance and Simultaneous Preemption Timeline**



## TYPICAL TABULAR PREEMPTION TIMELINE EXAMPLES

### SIMULTANEOUS

<u>Railroad</u>		<u>Traffic Signal</u>	
Train activates track circuit	0 sec. <sup>1</sup>	- - - - -	0 sec.
Begin Flashing Light Signals	6 sec	Receive RR signal via interconnect	6 sec.
Continue Flashing Lights		Begin Preemption Minimum Green interval	7 sec <sup>2</sup>
"	↓	Begin right-of-way (R/W) transfer - Y interval	9 sec
Begin Gate Lowering	10 sec	Continue Yellow Change interval timing	↓
Continue Gate Lowering		Begin R/W transfer - Red Clearance interval	12 sec
"	↓	Begin Clear Track Green interval	13 sec
Complete Gate Lowering	17 sec	Continue Clear Track Green interval timing	↓
Gates Down		Begin Clear Track Yellow Change interval	21 sec
"	↓	Begin Clear Track Red Clearance interval	25 sec
Train Arrives	26 sec	Begin Preemption Hold Phase Green	26 sec

### ADVANCE

<u>Railroad</u>		<u>Traffic Signal</u>	
Train activates track circuit	0 sec. <sup>1</sup>	- - - - -	0 sec.
RR active warning device delay		Recieve RR signal via interconnect	6 sec.
"		Begin R/W transfer - Ped. Clearance interval	7 sec <sup>2</sup>
"		Begin R/W transfer - Yellow Change interval	19 sec
"		Begin R/W transfer - Red Clearance interval	22 sec
"	↓	Begin Clear Track Green interval	23 sec
Begin Flashing Light Signals	30 sec	Continue Clear Track Green interval timing	
Begin Gate Lowering	34 sec	"	↓
Continue Gate Lowering	↓	Begin Clear Track Yellow Change interval	40 sec
Complete Gate Lowering	41 sec	"	↓
Gates Down		Begin Clear Track Red Clearance interval	44 sec
"	↓	Begin Separation Time (Optional)	45 sec <sup>3</sup>
Train Arrives	50 sec	Begin Preemption Hold Phase Green	50 sec

<sup>1</sup> Varies with controller equipment, track condition, etc. (up to 6 seconds)

<sup>2</sup> Varies with controller equipment (up to 1 second)

<sup>3</sup> Optional separation time shown with advance example. This time could also be used with a simultaneous situation, if conditions warrant.

# TYPICAL GRAPHIC PREEMPTION TIMELINE EXAMPLE

ADVANCE

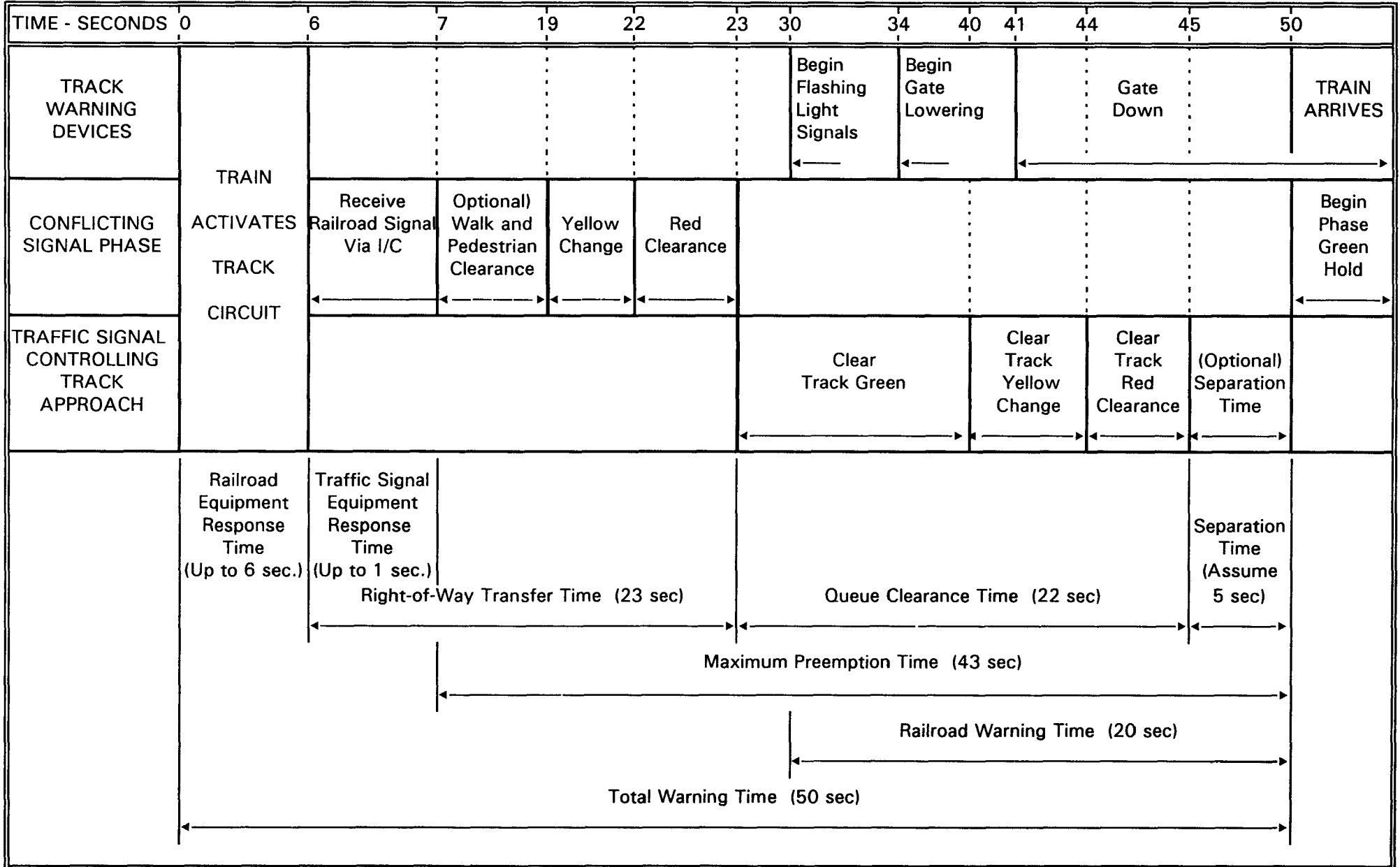



TYPICAL GRAPHIC PREEMPTION TIMELINE EXAMPLE

SIMULTANEOUS

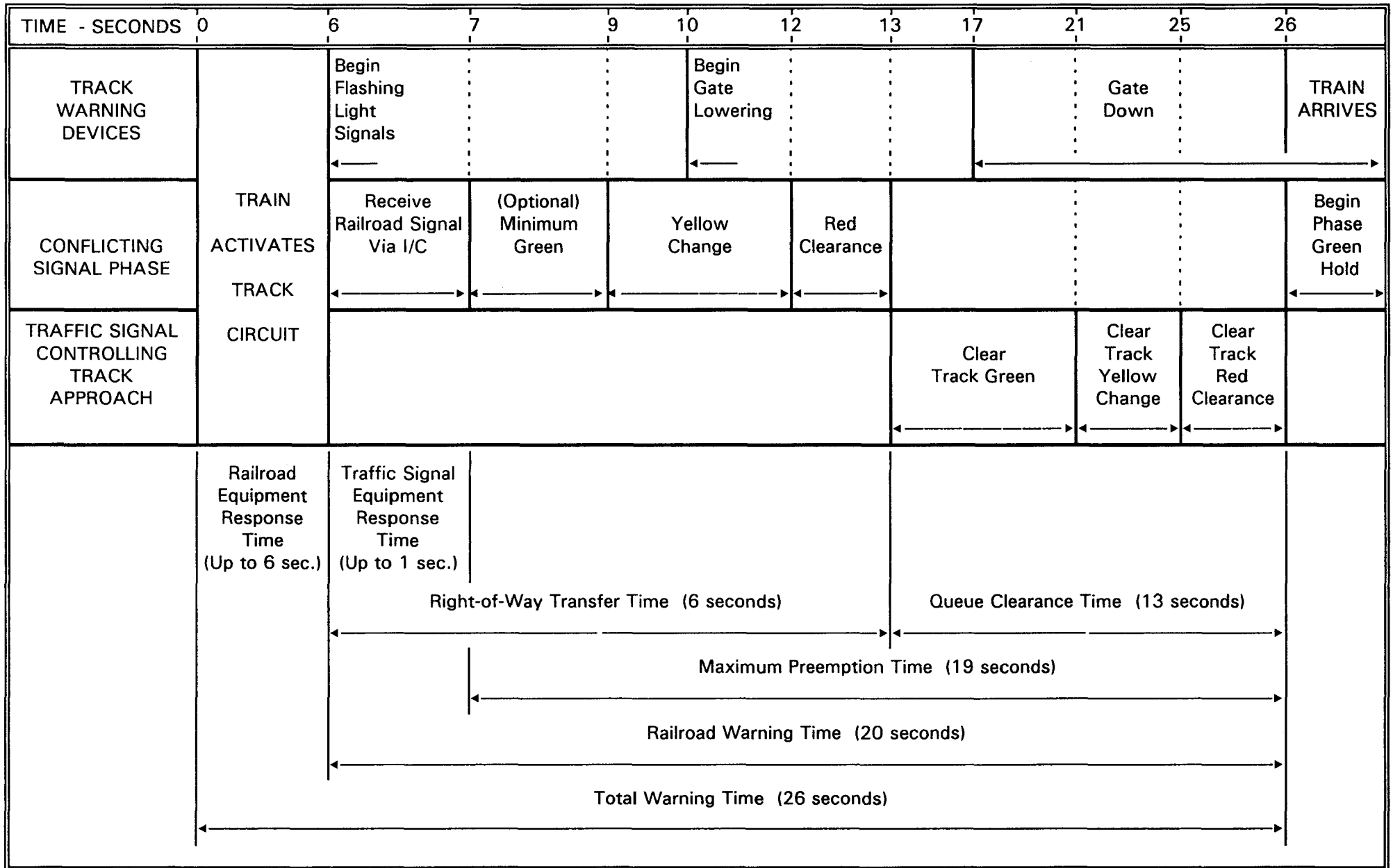



# **Appendix 0**

## **Sample Cross-Hatch Pavement Markings**



(A)

(B)

Page O-1

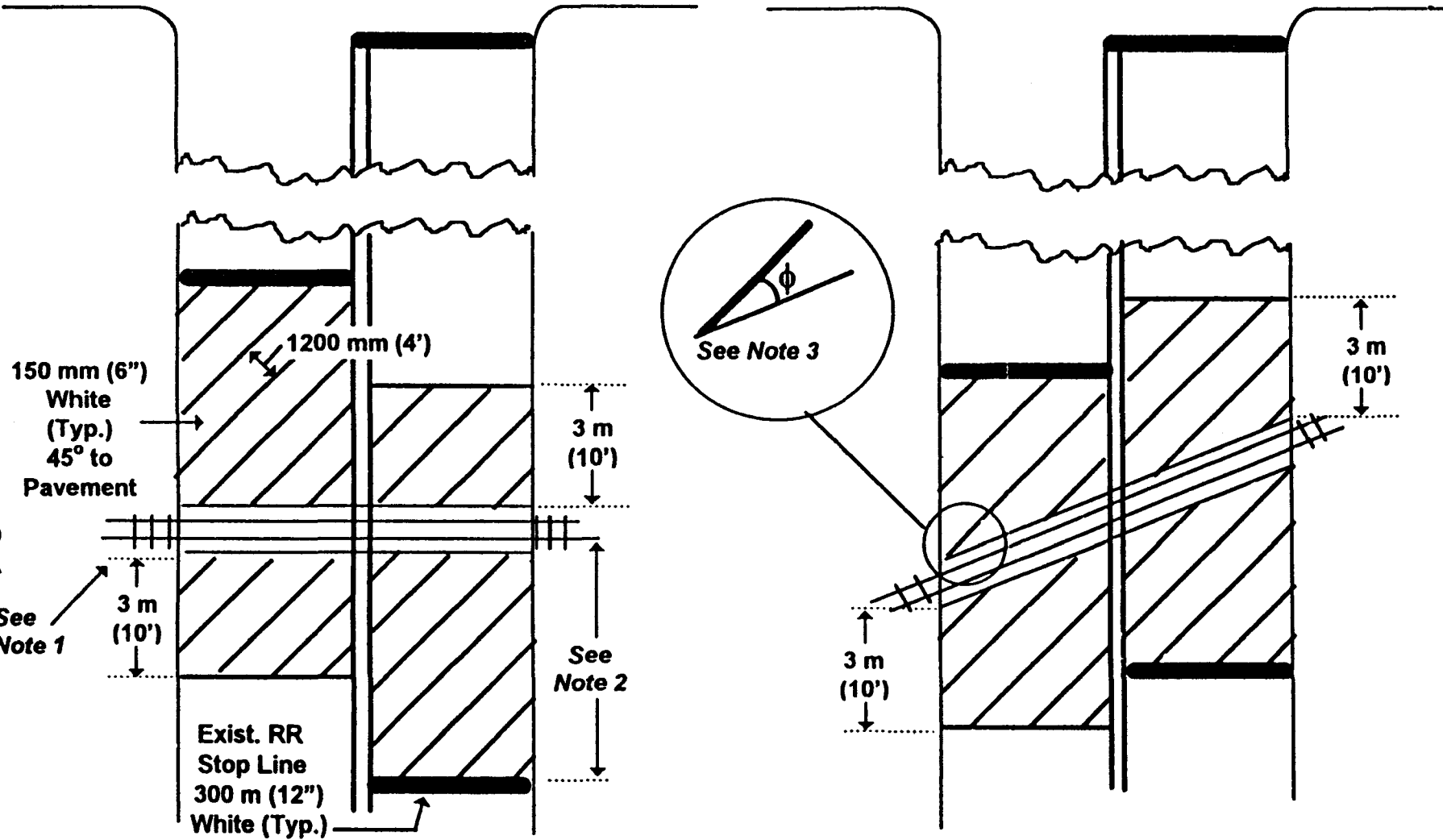

**Note: 1.** Measure the 3 m (10 ft) from the edge of the crossing surface.  
**Note: 2.** Where there is no stop line, establish one 4.5 m (15 ft) from track or 2.4 m (8 ft) from gate (where present).  
**Note: 3.** Where the angle between the diagonal stripes and the track ( $\phi$ ) would be less than approximately 20°, the stripes should be sloped in the opposite direction from that shown.

**TYPICAL SUPPLEMENTAL PAVEMENT MARKING TREATMENT  
 FOR RAILROAD CROSSINGS  
 (Sheet 1 of 2)**

(C)

(D)

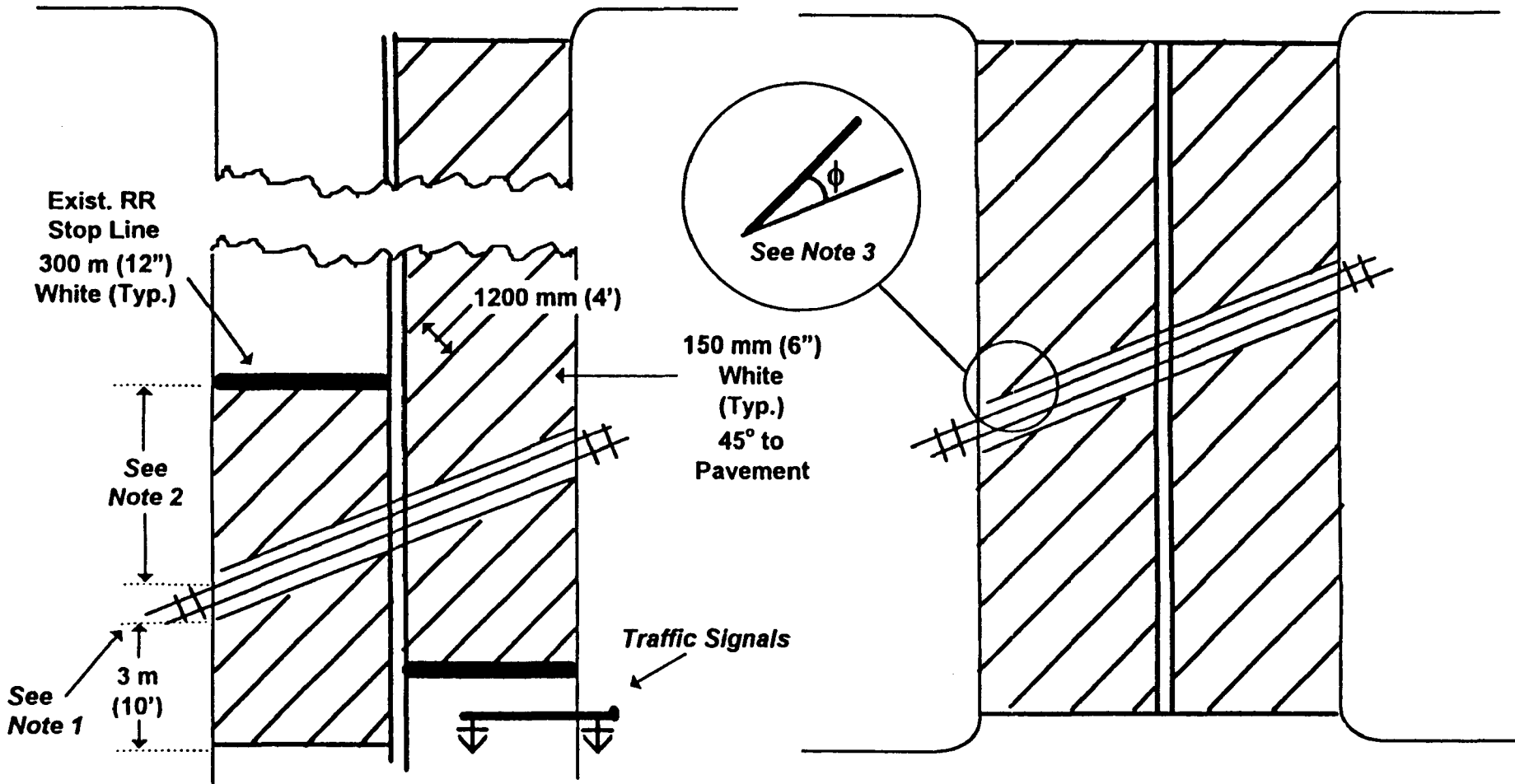

Page O-2

- Note: 1.** Measure the 3 m (10 ft) from the edge of the crossing surface.  
**Note: 2.** Where there is no stop line, establish one 4.5 m (15 ft) from track or 2.4 m (8 ft) from gate (where present).  
**Note: 3.** Where the angle between the diagonal stripes and the track ( $\phi$ ) would be less than approximately 20°, the stripes should be sloped in the opposite direction from that shown.

**TYPICAL SUPPLEMENTAL PAVEMENT MARKING TREATMENT  
 FOR RAILROAD CROSSINGS  
 (Sheet 2 of 2)**

# **Appendix P**

**Sheriff's Dept.  
Railroad-Highway Grade  
Crossing Violation Brochure**





**\*STOPPING OF TRAINS**

1. **GENERAL.** These procedures apply whenever railway traffic is exposed to any situation where continued train movement would be hazardous to persons or property.

a. Stopping distances for trains vary with the train type (e.g., light-rail commuter, freight), speed, weight, and the percent of grade. According to the Department of Transportation, Division of Rail, an average freight train traveling 30 mph on level ground requires a minimum distance of one-half mile to stop. An average freight train traveling 60 mph on level ground requires a minimum distance of one and one-half miles to stop.

b. Employees should not attempt to actuate railroad block signals to stop trains in an emergency.

c. All employees must be cognizant of the inherent dangers associated with stopping trains, and shall ensure that their actions are consistent with sound personal safety practices.

2. **PROCEDURE.**

a. **Notification.** When it is necessary to stop railway traffic (if time permits) advise the appropriate communications center of: the name of railroad, nature of the problem, and location. Upon receiving the aforementioned information, communication center personnel are to immediately notify the appropriate railroad dispatcher.

b. **Signals.**

(1) **Universal Hand Signals/Normal Stop.** To stop a train, slowly swing a visible object (e.g., flag, handkerchief, emergency yellow blanket, lighted fusee) horizontally, in a back and forth motion at knee to hip height, at a right angle to the track. In addition, the person giving the signal can be observed more readily by moving about rather than remaining stationary. The locomotive engineer will acknowledge this signal with two whistle blasts and stop the train as quickly as practical. During hours of darkness, the hand signal should be given with a fusee, flashlight, or other lighted object.

(2) **Universal Hand Signals Full/Emergency Stop.** This signal is the same as that for a normal stop, except that it is given with a more rapid movement. Use a full emergency stop only when a train cannot be signaled at a sufficient distance from the hazard to permit a normal stop. Be aware that full emergency stops may endanger passengers, train crews, property, and equipment.

(3) **Unattended Fusee.** If time and access allows, place one thirty-minute lighted fusee, between the rails, but not directly on a wooden railroad tie, in advance of the rail-highway grade crossing or hazard in both directions of travel. The lighted fusee should be placed 2,000 feet (minimum) to over two miles in advance of the hazard. If a train approaches a lighted fusee burning on or near its track, the locomotive engineer is required to stop the train at or near the fusee.

(a) If an unattended lighted fusee is placed beyond the closest rail of an adjacent track, the fusee does not apply to the track on which the train is moving.

c. Immediately after the train comes to a stop, contact a train employee, preferably the conductor, and advise him/her of the hazard. Report stopping of trains as required by GO 100.80, Report of Unusual Occurrences.

**EMERGENCY CONTACT NUMBERS**

Major Freight Railroads

<b>Burlington Northern Railroad</b>	
Assets Protection .....	1-800-832-5452
<b>California Northern Railroad</b>	
Operating Department .....	1-800-254-9244
	1-707-254-9245
<b>San Joaquin Valley Railroad</b>	
Operating Department .....	1-800-524-0578
<b>Santa Fe Railroad</b>	
Police Department .....	1-800-333-2383
Train Dispatchers .....	1-800-285-2164
<b>Southern Pacific Railroad</b>	
Police Department .....	1-800-892-1283
Train Dispatchers .....	1-800-767-3846
Malfunctioning Gates .....	1-800-767-3884
<b>Union Pacific Railroad</b>	
Police Department .....	1-800-877-0509
Train Dispatchers .....	1-800-877-0509
Hazardous Materials .....	1-800-877-0511
Broken Gates .....	1-800-636-7429

Passenger/Transit Railroads

<b>Amtrak</b>	
<i>Contact railroad responsible for right-of-way in use.</i>	
<b>CalTrain</b> .....	1-800-660-4287
<b>Los Angeles Blueline/Redline/Greenline</b>	
Dispatch .....	1-213-563-5015
<b>Los Angeles Metrolink</b>	
Dispatch .....	1-800-404-9464
<b>Sacramento Regional Transit</b>	
Dispatch .....	1-916-648-8415
<b>San Diego Trolley</b>	
Controller .....	1-619-595-4960
<b>San Francisco Muni</b>	
Central Control .....	1-415-759-4361
<b>Santa Clara County Transit</b>	
Dispatch .....	1-408-321-2300



*In Association with the  
L. A. County Sheriff's Dept.*

**Law Enforcement Guide To:**

Rail and Transit  
Violations

Grade Crossing  
Collision Investigation

Stopping of Trains

Emergency Notification  
Phone Numbers

GUIDES MAY BE OBTAINED BY CONTACTING  
ERIC JACOBSEN, STATE COORDINATOR  
CALIFORNIA OPERATION LIFESAVER.  
(916) 367-3918  
FAX(916)367-3053

(\*Excerpts from GO 100.31, December 1994)

**RAIL-RELATED VEHICLE CODE VIOLATIONS**

- 21453(a) VC Failure to stop behind limit line for red traffic signal.
- 21456(b) VC Pedestrian crossing against a "don't walk" or "wait" signal.
- 21461(a) VC Failure to obey signs and signals, provisions of the vehicle code or local traffic ordinance.
- 21461.5 VC Pedestrian failing to stop for railroad crossing signal.
- 21651(a).1 VC Driving vehicle over or upon center divider.
- 21752(c) VC Passing at grade crossing.
- 21950(a) VC Failure to yield right-of-way to pedestrian in crosswalk.
- 21955 VC Pedestrian crossing between controlled intersections.
- 22101(d) VC Failure to obey street sign - no left turn.
- 22450 VC Failure to stop at limit line of stop sign at entrance or within railroad crossing.
- 22451(a) VC Failure to stop at railroad crossing signal.
- 22451(b) VC Driving around closed railroad crossing gate.
- 22452(b) VC Special vehicles; failing to stop more than 15 feet from tracks before crossing.
- 22521 VC Parking within 7 1/2 feet of railroad track.

**RAIL-RELATED PENAL CODE VIOLATIONS**

- 148.1(a) PC False bomb report - felony.
- 212.5(a) PC Robbery of transit passenger - felony.
- 214 PC Train robbery - felony.
- 218 PC Train wrecking (attempt) - felony.
- 219 PC Wrecking/derailing train - felony.
- 219.1 PC Throw object (missiles) at common carrier vehicle with intent to wreck or cause bodily harm - felony.
- 219.2 PC Shoot missile or throw hard object at train - misd./felony.
- 241.3 PC Assault on transit personnel or passenger - misd.
- 243.3 PC Battery on transit personnel or passenger - misd./felony.
- 245.2 PC Assault with deadly weapon on transit personnel or passenger - felony.
- 369(g) PC Drive vehicle on railroad track/right-of-way - misd.
- 369(i) PC Interfere with railroad operations - trespassing - misd.
- 374.3(a) PC Illegal dumping - misd.
- 374.8(b) PC Dumping hazardous substance - misd./felony.
- 481.1(a) PC Fare media; counterfeit, forge or alter - felony.
- 481.1(b) PC Possess counterfeit/altered fare media - misd.
- 483 PC Common carrier tickets, etc: Sale to person not entitled to use - misd.

- 555 PC Trespass on posted (every 600 feet) railroad/transit property - misd.
- 587 PC Injure/obstruct railroad - felony.
- 587(a) PC Tamper with air brakes or safety equipment - misd.
- 587(b) PC Trespass on railroad train - misd.
- 587(c) PC Evade railroad fare - misd.
- 587.1(a) PC Move locomotive without authorization - misd.
- 587.1(b) PC Move locomotive without authorization creating likelihood of injury - felony.
- 590 PC Tamper with mile post marker - misd.
- 594 PC Vandalism - misd./felony.
- 594.1(e) PC Minor possess aerosol paint can - misd.
- 594.2 PC Possess etching devices with intent to deface - misd.
- 602.7 PC Peddling without permission of transit authority. (see code).
- 640(b)(1) PC Evade fare.
- 640(b)(2) PC Misuse fare media.
- 640(b)(3) PC Play sound equipment.
- 640(b)(4) PC Smoke/eat/drink.
- 640(b)(5) PC Spit on system.
- 640(b)(6) PC Boisterous/unruly.
- 640(b)(11)(A) PC Unauthorized use of a discount ticket.
- 374.4(a) PC Littering.

**PUBLIC UTILITY CODE**

- GO #135 PUC Train blocking crossings without moving for over 10 minutes - misd.
- 7676 PUC Freight car behind passenger car - misd./felony.
- 7678 PUC Fail to operate signal at crossing - misd.
- 7679 PUC Train crew - intoxicated on duty - misd./felony.
- 7680 PUC Collision causing death - felony.
- 7681 PUC Dereliction of duty; endangering human life or safety - misd.

**REFERENCE/AUTHORITY SECTIONS**

- 7656 PUC Passenger display ticket on request; failure to do so may result in ejection.
- 2188 Civ. Code Ejection authorized for violation of system rules.
- 22656 VC Storage authority. Veh. parked on or within 7 1/2 ft. of RR track.

All subsections not specified as Misdemeanor (misd.) or felony violations, are infractions.

**GRADE CROSSING COLLISION INVESTIGATION CHECKLIST**

**ENGINEER INFORMATION:**

- Name (full name no initials)
- Address
- DOB
- Phone
- Time of Collision
- Train Speed Estimate at Collision (Operator's license number not permitted on accident report per 12953 CVC.)

**CONDUCTOR INFORMATION:**

- Name (full name no initials)
- Address
- DOB
- Phone
- (Operator's license number not permitted on accident report per 12953 CVC.)

**TRAIN INFORMATION:**

- Lead engine number (total no. of engines)
- Preservation/disposition of event recorder
- Train ID number (from Conductor)
- Number of cars in train (tonnage/loads/empties)
- Railroad Co. name/address (owns tracks)
- Name of Railroad Co. operating train
- Additional crew members

**ENGINE INFORMATION:**

- Headlight working?
- Horn working?
- Bell working?

**MISCELLANEOUS INFORMATION:**

- RR Car number on crossing?
- Distance to last RR car from POI?
- Witnesses

At this point, if no further information is required, consider releasing the train.

**CROSSING SIGNALS:**

- Light/gate bell combination?
- Light/bell combination?
- Passive warning (crossbucks)?
- Wig-wag type?
- Lights flashing/bells ringing your arrival?
- Crossing gates down? (If devices not working upon your arrival, explain.)
- Signal event recorder information available?

**OTHER CROSSING CHARACTERISTICS:**

- Advance warning signs in place? "Distance from this sign to nearest rail?"
- Crossing surface (rubber, asphalt, etc.)
- Pavement markings?
- DOT/AAR crossing ID number?
- Width of right-of-way (ft)?
- Visual obstructions on driver approach?
- Citation given if warranted (FTY, FTS, etc.)?

**OTHER INVOLVED VEHICLE:**

- Ignition key position?
- Radio volume position?
- Other distractions, vision obstructions?

24611

HE 1618 .A2 U53 1997

United States. Dept. of  
Transportation. Grade

Implementation report of the  
USDOT Grade Crossing Safety

Acc.no.  
24611

# 37848946  
M19602  
I18769

**MTA LIBRARY**  
ONE GATEWAY PLAZA, 15th Floor  
LOS ANGELES, CA 90012

MTA DOROTHY GRAY LIBRARY & ARCHIVE  
Implementation report of the USDOT Gr  
HE1618.A2 U53 1997



100000187474

Publication No. FHWA-SA-97-085  
US 20/7 07/4M5