
Pedestrian Facilities Users Guide —

Providing Safety and Mobility

Publication No. FHWA-RD-01-102



U.S. Department of Transportation
Federal Highway Administration
Research and Development
Turner-Fairbank Highway Research Center
6300 Georgetown Pike
McLean, VA 22101-2296

March 2002



Foreword

The FHWA's Pedestrian and Bicycle Safety Research Program's overall goal is to increase pedestrian and bicycle safety and mobility. From better crosswalks, sidewalks, and pedestrian technologies to expanding public educational and safety programs, the FHWA's Pedestrian and Bicycle Safety Research Program strives to pave the way for a more walkable future.

The *Pedestrian Facilities Users Guide* was part of a large FHWA study entitled "Evaluation of Pedestrian Facilities." The guide is the culmination of results from the research conducted as part of the large study. The guide provides useful information regarding walkable environments, pedestrian crashes and their countermeasures, and engineering improvements for pedestrians.

This guide will be useful for transportation engineers, planners, and safety professionals who are involved in increasing pedestrian safety and mobility. Citizens may also use this guide for identifying tools to improve the safety and mobility of all who walk.

Michael F. Trentacoste, Director
Office of Safety Research
and Development

Notice

This document is disseminated under the sponsorship of the Department of Transportation in the interest of information exchange. The United States Government assumes no liability for its contents or use thereof. This report does not constitute a standard, specification or regulation.

The United States Government does not endorse products or manufacturers. Trade and manufacturers' names appear in this report only because they are considered essential to the object of the document.

1. Report No. FHWA-RD-01-102		2. Government Accession No.		3. Recipient's Catalog No.	
4. Title and Subtitle PEDESTRIAN FACILITIES USERS GUIDE — PROVIDING SAFETY AND MOBILITY				5. Report Date	
				6. Performing Organization Code	
7. Author(s) Charles V. Zegeer, Cara Seiderman, Peter Lagerwey, Mike Cynecki, Michael Ronkin, and Robert Schneider				8. Performing Organization Report No.	
9. Performing Organization Name and Address Highway Safety Research Center University of North Carolina 730 Airport Rd., CB# 3430 Chapel Hill, NC 27599-3430				10. Work Unit No. (TRAIS)	
				11. Contract or Grant No. DTFH61-92-C-00138	
12. Sponsoring Agency Name and Address Office of Safety Research and Development Federal Highway Administration 6300 Georgetown Pike McLean, VA 22101-2296				13. Type of Report and Period Covered Users Guide 1999 - 2001	
				14. Sponsoring Agency Code	
15. Supplementary Notes This report is part of a larger study for FHWA entitled "Evaluation of Pedestrian Facilities." Carol Tan Esse and Ann Do were the FHWA Contract Managers. Report layout and design was done by Katie Hanburger, Barbara Gray, Lisa Bell, and A.J. Silva.					
16. Abstract The purpose of the <i>Pedestrian Facilities Users Guide — Providing Safety and Mobility</i> is to provide useful information on how to identify the safety and mobility needs of pedestrians within roadway rights-of-way. Chapter 1 gives an overview of the creation of a walkable environment. Chapter 2 describes basic pedestrian crash trends and the examination and classification of crash types to determine appropriate countermeasures. Chapter 3 defines 13 pedestrian crash-type groupings and factors important in selecting the best countermeasures. These crash groupings are then presented in terms of how to select pedestrian safety improvements to address specific crash problems. Chapter 4 contains the details of 47 different engineering improvements for pedestrians. These improvements relate to the walking environment, roadway design, intersection treatments, traffic calming, traffic management, and signals and signs. Chapter 4 also provides a simplified list of improvements to address certain broad objectives (e.g., reducing speeds on a street, reducing pedestrian exposure) without the need for pedestrian crash data. This guide is intended primarily for engineers, planners, safety professionals, and decisionmakers, but it may also be used by citizens for identifying pedestrian tools to improve the safety and mobility of those who walk.					
17. Key Words Pedestrian crashes, traffic calming, pedestrian facilities.			18. Distribution Statement No restrictions. This document is available to the public through the National Technical Information Service, Springfield, VA 22161.		
19. Security Classification (of this report) Unclassified		20. Security Classification (of this page) Unclassified		21. No. of Pages 162	22. Price

SI* (MODERN METRIC) CONVERSION FACTORS

APPROXIMATE CONVERSIONS TO SI UNITS					APPROXIMATE CONVERSIONS FROM SI UNITS				
Symbol	When You Know	Multiply By	To Find	Symbol	Symbol	When You Know	Multiply By	To Find	Symbol
LENGTH									
ft	feet	0.304	millimeters	mm	mm	millimeters	0.000	feet	ft
in	inches	0.0254	meters	m	m	meters	3.28	feet	ft
yd	yards	0.914	meters	m	yd	meters	1.09	yards	yd
mi	miles	1.61	kilometers	km	km	kilometers	0.621	miles	mi
AREA									
sq ft	square feet	0.0929	square meters	m ²	sq m	square meters	0.0016	square feet	sq ft
sq yd	square yards	0.836	square meters	m ²	sq m	square meters	1.196	square yards	sq yd
ac	acres	0.405	hectares	ha	ha	hectares	2.47	acres	ac
mi ²	square miles	2.59	square kilometers	km ²	km ²	square kilometers	0.386	square miles	mi ²
VOLUME									
gal	gallons	3.785	liters	l	l	liters	0.264	gallons	gal
cu ft	cubic feet	0.0283	cubic meters	m ³	m ³	cubic meters	35.31	cubic feet	cu ft
yd ³	cubic yards	0.765	cubic meters	m ³	m ³	cubic meters	1.357	cubic yards	yd ³
NOTE: Volume greater than 1000 l should be shown in m ³ .									
MASS									
kg	kilograms	2.205	pounds	lb	g	grams	0.001	kilograms	kg
lb	pounds	0.454	kilograms	kg	mg	milligrams	2.205	pounds	lb
ton	short tons (2000 lb)	0.907	metric tons (or "metric ton")	t (or "t")	Mg	megagrams (or "metric ton")	1.102	short tons (2000 lb)	T
TEMPERATURE (exact)									
°F	Fahrenheit temperature	5(F-32)/9 or (F-32)/1.8	Celsius temperature	°C	°C	Celsius temperature	1.8C + 32	Fahrenheit temperature	°F
ILLUMINATION									
lx	lux	10.76	foot-candle	fc	lx	lux	0.0929	foot-candle	fc
ft-cd	foot-candle	0.0929	candela/m ²	cd/m ²	cd/m ²	candela/m ²	0.2919	foot-candle	ft-cd
FORCE and PRESSURE or STRESS									
lbf	pounds-force	4.45	newtons	N	N	newtons	0.225	pounds-force	lbf
psi	pounds-force per square inch	6.89	kilopascals	kPa	kPa	kilopascals	0.145	pounds-force per square inch	psi

* SI is the symbol for the International System of Units. Appropriate rounding should be made to comply with Section 4 of ASTM E488.

Table of Contents

	Introduction	1
Chapter 1:	The Big Picture	3
Chapter 2:	Pedestrian Crash Factors	11
Chapter 3:	Selecting Pedestrian Safety Improvements	17
Chapter 4:	The Tools	41
	A. Pedestrian Facility Design	42
	1. Sidewalks or Walkways	43
	2. Curb Ramps	44
	3. Marked Crosswalks and Enhancements	45
	4. Transit Stop Treatments	47
	5. Roadway Lighting Improvements	48
	6. Pedestrian Overpasses/Underpasses	49
	7. Street Furniture/Walking Environment	50
	B. Roadway Design	51
	8. Bicycle Lanes	52
	9. Roadway Narrowing	53
	10. Reducing Number of Lanes	54
	11. Driveway Improvements	55
	12. Raised Medians	56
	13. One-Way/Two-Way Street Conversions	57
	14. Curb Radius Reduction	58
	15. Improved Right-Turn Slip-Lane Design	59
	C. Intersection Design	61
	16. Roundabouts	62
	17. Modified T-Intersections	63
	18. Intersection Median Barriers	64
	D. Traffic Calming	65
	Roadway Narrowing	69
	19. Curb Extensions	69
	20. Chokers	71
	21. Crossing Islands	72
	Lateral/Horizontal Shifts in the Roadway	73
	22. Chicanes	73
	23. Mini-Circles	74

Raised Devices	75
24. Speed Humps	75
25. Speed Tables	75
26. Raised Intersections	76
27. Raised Pedestrian Crossings	76
Complementary Tools	77
28. Gateways	77
29. Landscaping	78
30. Specific Paving Treatments	79
Whole Street Designs	80
31. Serpentine Design	80
32. Woonerf	81
E. Traffic Management	83
33. Diverters	85
34. Full Street Closure	86
35. Partial Street Closure	87
36. Pedestrian Streets/Malls	88
F. Signals and Signs	89
37. Traffic Signals	90
38. Pedestrian Signals	91
39. Upgrade/Modify Pedestrian Signal Timing	92
40. Traffic Signal Enhancements	94
41. Right-Turn-on-Red Restrictions	95
42. Advanced Stop Lines	96
43. Add/Modify Signing	97
G. Other Measures	99
44. School Zone Improvements	100
45. Identify Neighborhood	102
46. Speed-Monitoring Trailer	103
47. On-Street Parking Enhancements	104
Problem-Solving Methods	105

Chapter 5: Implementation and Resources	109
--	------------

Appendix A: Pedestrian Facility Case Studies	129
---	------------

Appendix B: Recommended Guidelines/Priorities for Sidewalks and Walkways	141
---	------------

Appendix C: Recommended Guidelines for Crosswalk Installation	155
--	------------



Photo by Dan Burden

Introduction

Walking is such a basic human activity that it has frequently been overlooked in the quest to build sophisticated transportation systems. Now people want to change that. They want to live in places that are welcoming, safe, and enjoyable. They want livable communities where they can walk, bicycle, recreate, and socialize.

Creating a pedestrian environment involves more than laying down a sidewalk or installing a signal. A truly viable pedestrian system involves both the big picture and the smallest details — from how a city is built to what materials are under our feet. Facilities should be accessible to all pedestrians, including those with disabilities. Accessible design is the foundation for all pedestrian design and facilities need to be planned, designed, operated, and maintained to be usable by all people.

Because most of the work that will be done involves retrofitting existing places, improving the pedestrian environment will probably be done on a street-by-street, neighborhood-by-neighborhood basis.

How to Use This Guide

Pedestrian Facilities Users Guide — Providing Safety and Mobility is intended primarily for engineers, planners, safety professionals, and decisionmakers, but it may also be used by citizens for identifying pedestrian tools to improve the safety and mobility of those who walk.

The purpose of this guide is to provide useful information on how to identify safety and mobility needs and improve conditions for pedestrians within the roadway right-of-way. *Chapter 1: The Big Picture* gives an overview on how to create a safe, walkable environment.

Chapter 2: Pedestrian Crash Factors describes basic pedestrian crash trends and the examination and classification of crash types to determine appropriate countermeasures. *Chapter 3: Selecting Pedestrian Safety Improvements* defines 13 pedestrian crash-type groupings and factors important in selecting the best countermeasures. These crash groupings are then presented in terms of how to select pedestrian safety improvements to address specific crash problems.

Chapter 4: The Tools contains the details of 47 different engineering improvements for pedestrians. These improvements relate to pedestrian facility design, roadway design, intersection design, traffic calming, traffic management, and signals and signs. Chapter 4 also provides a simplified list of improvements to address certain broad objectives (e.g., reducing speeds on a street, reducing pedestrian exposure) without the need for pedestrian crash data.

Further resources are listed in *Chapter 5: Implementation and Resources*, including a section on involving the community in developing priorities, strategies for construction, and raising funds for pedestrian improvements. A bibliography of suggested readings and useful web site addresses are also provided.

The *Appendices* contain additional information regarding Pedestrian Facility Case Studies (success stories, Appendix A), Recommended Guidelines/Priorities for Sidewalks and Walkways (Appendix B), and Recommended Guidelines for Crosswalk Installation (Appendix C).

Chapter 1

The Big Picture



Photo by Michael Ronkin

Land Use

Assume That People Will Walk

Transit

Streets: The Arteries of Life

**How Pedestrians Are Affected by Traffic:
Traffic Volume and Speed**

ADA Design Guidelines

Land Use

Creating a walkable community starts with the very nature of the built environment: having destinations close to each other; siting schools, parks, and public spaces appropriately; allowing mixed-use developments; having sufficient densities to support transit; creating commercial districts that people can access by foot and wheelchair; and so on. Most walking trips are less than 0.8 km (0.5 mi).⁽¹⁾ While mixed-use developments with sufficient density to support transit and neighborhood commercial businesses can make walking a viable option for residents, single-use, low-density residential land-use patterns discourage walking. When residents are segregated from sites such as parks, offices, and stores, there will be fewer pedestrian trips because destinations are not close enough for walking. The connection between land-use planning and transportation planning is critical, but all too often ignored.

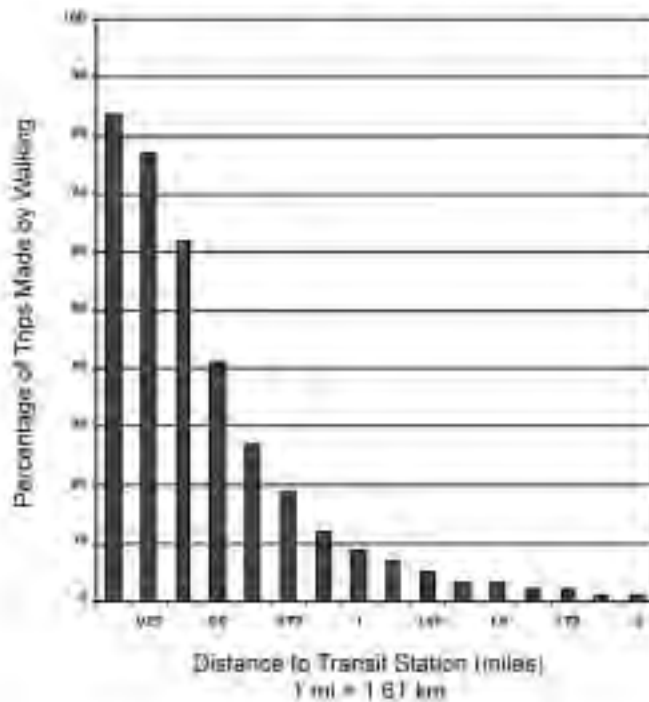
Integrating land-use and transportation planning allows new developments to implement these strategies from the onset. Communities that support balanced transportation make walking and public transit attractive options.



Photo by Cara Seiderman

Design streets for people to use them.
Assume people will walk.

The Relationship Between Trip Distance and Pedestrian Mode Choice



Source: Federal Transit Administration, Transit Cooperative Research Program, Transit and Urban Form, TCRP Report 16, 1996. Chart adapted from Figure 19.

In established communities, many of these goals can be met with "in-fill development" to increase density and community viability. Changes in zoning laws and sidewalk warrants to allow mixed-use development and pedestrian connections, such as sidewalks, easy-to-access crosswalks, and shared-use paths, can also increase pedestrian safety and mobility.

Assume That People Will Walk

Whether building new infrastructure or renovating existing places, it should always be assumed that people will walk and plans should be made to accommodate pedestrians. People will want to walk everywhere they can, and a comfortable, inviting, and safe environment should be provided for them. There are many reasons that people walk: to run errands, to visit neighbors, to go to local stores, to take their children to the local park, for exercise, or even for the sheer enjoyment of being a pedestrian. Children should be able to walk to school or to their friends' houses. All of these activities constitute a significant number of trips. About four-fifths of all trips are non-work-related.⁽¹⁾

If people aren't walking, it is probably because they are prevented from doing so. Either the infrastructure is insufficient or has serious gaps. Are there continuous walkways? Are there physical barriers such as rivers, drainage ways, walls, or freeways that prevent convenient walking access in a community? Do bridges for automobiles also provide a safe walking area for pedestrians? Does the lack of curb ramps or the existence of steep grades or steps prevent access for the elderly or people in wheelchairs? Are there information barriers preventing people with visual disabilities from crossing the street? Is there a major road that separates the residential neighborhood from the commercial district? Are there places for people to cross roads safely?

Walking rates in different neighborhoods within the same city are directly related to the quality of the system. In other words, in high-quality pedestrian environments, lots of people walk. Where the system fails — missing sidewalks, major barriers, no safe crossings — people walk less, and those who do are at greater risk.

People also want to walk in an environment where they can feel safe, not only safe from motor vehicle traffic, but safe from crime or other concerns that can affect personal security. Areas need to be well lit to encourage walking during evening hours. If the pedestrian system is not accessible, it is often not safe. For example, lack of access may cause wheelchair users to use the street rather than a poorly maintained sidewalk. Some populations may be at a higher risk of pedestrian crashes. Children under age 15 are the most overrepresented group in pedestrian crashes and people over age 65 have the most pedestrian fatalities. Therefore, it is especially important to provide adequate facilities in the vicinity of land uses such as retirement homes and school zones.



Photo by Cara Seiderman

A busy commercial street in Ann Arbor, Michigan emphasizes pedestrian use and provides attractive areas for people to sit, stroll, and meet.

The walking environment should be open and inviting, but not sterile and vacant. Pedestrians need more than sidewalks and crosswalks. In addition to protecting pedestrians from motor vehicle traffic, it is important to have a secure, pleasant, and interesting walking environment to encourage people to walk.

Traditionally, safety problems have been addressed by analyzing police crash reports and improvements have been made only after they are warranted by crash numbers. However, planners and engineers should consider problem-identification methods such as interactive public workshops, surveying pedestrians and drivers, and talking with police to identify safety problems in an area before crashes occur. This may help proactively identify locations for pedestrian safety improvements and will involve citizens in the process of improving safety and mobility in their own communities.

Transit

Walking and transit are complementary. Good walking conditions for pedestrians are important inducements to using public transportation, since most public transit trips include a pedestrian trip at one or both ends. People should be able to walk to a bus stop or a train station from their homes and to jobs, shopping, and other activities.

Conversely, good public transportation, with buses, subways, and paratransit vehicles that run frequently and are reliable, is essential to achieving a walkable city. The trip should be as seamless as possible and transit stops should be friendly, comfortable places. When development occurs around a transit stop, more transit can be supported, and people will have more options for how to travel there. Special attention should be paid to how people will get from the transit stop to their destinations. No matter how convenient the trip is otherwise, if pedestrians don't feel safe for even a short distance, they will choose not to go, or to go by another mode (usually driving — and the more people who drive, the less pedestrian-friendly a place becomes).

Streets: The Arteries of Life

Streets serve many functions, including:

- **Linkage.** They connect parts of cities to each other, one town to another, and activities and places.
- **Transportation.** They provide the surface and structure for a variety of modes. All modes and users should be provided for: pedestrians, bicyclists, transit, motor vehicles, emergency services, maintenance services, etc.
- **Access.** They provide public access to destinations.



Pedestrian injuries are less severe on lower speed roadways. The street pictured above is a heavily traveled arterial in one of Seattle, Washington's thriving residential neighborhoods. High speed and concerns about pedestrian safety resulted in the redesign shown in the "after" picture. Bike lanes and a median strip have encouraged slower traffic speeds. Speeds were reduced by about 4.8 km/h (3 mi/h), while average daily traffic remained about the same.

- **Public right-of-way.** Space for utilities and other underground infrastructure is usually a hidden function of the street.
- **Sense of place.** The street is a definable place, a place for people to interact, the heart of a community. A street can serve this role by being a venue for parties, fairs, parades, and community celebrations, or by simply being a place where neighbors stop to chat.

Streets are often designed to emphasize some functions over others. At one extreme is a limited-access highway that serves as a corridor for motor vehicle travel. At the other extreme is a private cul-de-sac, which has no linkage and has limited access. Many streets are designed so that certain desirable functions are not provided. Examples include commercial streets where access to destinations is difficult, and strip development along high-speed roads where no sidewalks or pedestrian crossings exist.

When streets and roads are evaluated for improvements, it is helpful to consider whether the design effectively meets all the desired functions of the roadway. If not, the street should be redesigned to adequately meet those functions.

How Pedestrians Are Affected by Traffic: Traffic Volume and Speed

High volumes of traffic can inhibit a person's feeling of safety and comfort and create a "fence effect" where the street is almost an impenetrable barrier. The effect of traffic volumes on community life has been measured. In his seminal 1980 study, Donald Appleyard looked at how traffic volumes on comparable streets in San Francisco affected community life. People living on a street with light traffic (2,000 vehicles per day) had three times as many friends and twice as many acquaintances on the street as did people living on a street with heavy traffic (16,000 vehicles a day).⁽²⁾

Traffic speed is usually the more critical aspect to walkability and safety. Though pedestrians may feel comfortable on streets that carry a significant amount of traffic at low speeds, faster speeds increase the likelihood of pedestrians being hit. At higher speeds, motorists are less likely to see a pedestrian, and even less likely to actually stop in time to avoid a crash. At a mere 49.9 km/h (31 mi/h), a driver will need about 61.0 m (200 ft) to stop, which may exceed available sight distance; that number is halved at 30.6 km/h (19 mi/h).⁽³⁾

Unfortunately, most of our streets are designed to encourage higher traffic speeds. Fortunately, we do have tools that can change this, primarily by redesigning streets through traffic calming or by designing new streets with lower design speeds. Speed reductions can increase pedestrian safety considerably. The safety benefits of reduced speeds

extend to motorists and cyclists as well, although the advantage to pedestrians is the most substantial.



Photo by Dan Burden

This roadway may act as a barrier to pedestrians. Those who are walking along the waterfront may find it difficult to cross to the commercial establishments and those on the commercial side may be reluctant to cross to the waterfront.

ADA Design Guidelines

The Americans with Disabilities Act (ADA) was passed to ensure that all people, including those with disabilities, have equal access to transportation. People with disabilities may have limited visual and cognitive ability, or a combination of disabilities, which is more common as a person grows older. A person may experience a disability on a permanent or temporary basis. Without accessible pedestrian facilities, people with disabilities will have less opportunities to engage in employment, school, shopping, recreation, and other everyday activities. New or altered facilities must provide access for all pedestrians. This also needs to occur when implementing all the tools and treatments that are presented in this guide.

While improvements for persons with disabilities were mandated by the Federal Government to ensure access and mobility for physically-challenged pedestrians, most of these improvements benefit all pedestrians. Some of the items that will be presented in this guide, such as adequate time to cross streets, well-designed curb ramps, limited driveways, and sidewalks that are wide and clear of obstructions and have minimal cross-slope, are examples of design features that will accommodate pedestrians with disabilities, persons using strollers, and indeed, all pedestrians.⁽⁴⁾



Photo by Kristen P. Oguntoyinbo

Street designs that accommodate people with disabilities create a better walking environment for all pedestrians.

All new construction or retrofit projects must include curb ramps that comply with ADA requirements. Agencies should review their street system to identify other barriers to accessibility and prioritize the needed improvements. Examples of barriers that are often overlooked include poles and signs in the middle of a sidewalk, steeply sloped driveways, and interruptions such as broken or missing sidewalk sections. An adequate level of surveillance and maintenance can also be important to providing accessibility, especially in winter months in areas where snow accumulates. While all streets should be upgraded to be accessible, public agencies should set priorities for high-use areas, such as commercial districts, schools, parks, transit facilities, etc., and retrofit as rapidly as possible.

Chapter 2

Pedestrian Crash Factors



Pedestrian Crash Statistics

Pedestrians Most at Risk

Alcohol Impairment

Speeding

Times of Occurrence

Area Type

Location Type

Crash Types and Countermeasures

Typing Pedestrian Crashes

Chapter 1 provided an overview of the need to provide a more pedestrian-friendly environment along and near streets and highways. Chapter 2 addresses the pedestrian crash problem and related factors that must be understood to select appropriate facilities to improve pedestrian safety and mobility. A brief discussion of the pedestrian crash problem in the United States is given below and is also reported by Zegeer and Seiderman in a related publication.⁽¹⁾

Pedestrian Crash Statistics

Pedestrian/motor vehicle crashes are a serious problem throughout the world and the United States has a particular problem with pedestrian deaths and injuries.

Specifically, 4,906 pedestrians were reported to have been killed in motor vehicle crashes in the United States in 1999.⁽²⁾ These deaths accounted for 11.8 percent of the 41,611 motor vehicle deaths nationwide that year. An estimated 85,000 pedestrians were injured or killed in motor vehicle collisions, which represents 2.6 percent of the 3.2 million total persons injured in traffic crashes.⁽²⁾ A drop in pedestrian fatalities in recent years may reflect the fact that people are walking less, as evidenced by the U.S. Census and the Nationwide Personal Transportation Survey (NPTS). The need to reduce pedestrian deaths and injuries while promoting increased walking continues to be an important goal for the engineering profession.

Pedestrians Most at Risk

Crash involvement rates (crashes per 100,000 people) are the highest for 5- to 9-year-old males, who tend to dart out into the street. This problem may be compounded by the fact that speeds are frequently a problem in areas where children are walking and playing.

In general, males are more likely to be involved in a crash than females; in 1999, more than 70 percent of pedestrian fatalities were male and the male pedestrian injury rate was a third higher than for females.⁽²⁾

Rates for older persons (age 65 and over) are lower than for most age groups, which may reflect greater caution by older pedestrians (e.g., less walking at night, fewer dart-outs) and a reduced amount of walking near traffic. However, older adult pedestrians are much more vulnerable to serious injury or death when struck by a motor vehicle than younger pedestrians. For example, the percentage of pedestrian crashes resulting in death exceeds 20 percent for pedestrians over age 75, compared to less than 8 percent for pedestrians under age 14.⁽³⁻⁴⁾



Photos by Dan Burden

Alcohol Impairment

Alcohol impairment is a serious problem for pedestrians as well as drivers of motor vehicles, although there is evidence that the picture is improving. From 1980 through 1989, 37 percent to 44 percent of fatally injured pedestrians had a blood alcohol concentration (BAC) of .10 or greater. In 1997, that figure was 29.5 percent and the intoxication rate for drivers was 12.5 percent. In 1989, of all adult pedestrians killed in nighttime collisions with motor vehicles, 59 percent had a BAC of .10 or greater, while only 31 percent had no alcohol in their blood.⁽⁴⁻⁵⁾ From 1987 to 1997, the intoxication rates for pedestrian fatalities in all age groups decreased, with the highest decrease, 19 percent, for those 55 to 64 years old and the least decrease, 3 percent, for those 35 to 44 years old.^(2,6)



Speeding

Speeding is a major contributing factor in crashes of all types. In 1997, speeding was a contributing factor in 30 percent of all fatal crashes.⁽²⁾ Speeding has serious consequences when a pedestrian is involved. A pedestrian hit at 64.4 km/h (40 mi/h) has an 85 percent chance of being killed; at 48.3 km/h (30 mi/h), the likelihood goes down to 45 percent, while at 32.2 km/h (20 mi/h), the fatality rate is only 5 percent.⁽⁷⁾ Faster speeds increase the likelihood of a pedestrian being hit. At higher speeds, motorists are less likely to see a pedestrian, and are even less likely to be able to stop in time to avoid hitting one.



Photos by Dan Burden

Times of Occurrence

Pedestrian crashes are most prevalent during morning and afternoon peak periods, when the traffic levels are highest. Fatal pedestrian crashes typically peak later in the day, between 5 and 11 p.m., where darkness and alcohol use are factors.⁽⁶⁾ In 1997, nearly one-half of all pedestrian fatalities occurred on Friday, Saturday, or Sunday (17 percent, 18 percent, and 13 percent, respectively).^(2,9) Crashes where older pedestrians are hit are more evenly distributed throughout the days of the week than those for younger pedestrians. Older pedestrians are more likely to be struck during daylight hours, when they are most likely to be exposed to traffic.⁽³⁾ September through January have the highest number of nationwide pedestrian fatalities, with typically fewer daylight hours and more inclement weather.^(4,8) Child pedestrian fatalities are greatest in May, June, and July, perhaps due to an increase in outside activity.⁽⁸⁾



Photo by Dan Burden

Area Type

Pedestrian crashes occur most frequently in urban areas where pedestrian activity and traffic volumes are greater compared to rural areas. The National Safety Council estimates that 85.7 percent of all non-fatal pedestrian crashes in the United States occur in urban areas and 14.3 percent occur in rural areas. However, 25 percent of pedestrian fatalities occur in rural areas, where vehicle speeds are higher than on city streets.^(8,10) In addition, many rural areas have no sidewalks, paths, or shoulders to serve as separated pedestrian facilities.

Location Type

In terms of crash location, 65 percent of crashes involving pedestrians occur at non-intersections. This is particularly true for pedestrians under age 9, primarily because of dart-outs into the street. For ages 45 to 65, pedestrian crashes are approximately equal for intersections and non-intersections. Pedestrians age 65 and older are more likely to be struck at intersections (60 percent) compared to non-intersections (40 percent), since older pedestrians tend to cross at intersections more often than younger ones.⁽⁹⁾ Moreover, some older pedestrians have physical and vision disabilities that place greater demand on intersection design.⁽⁸⁻⁹⁾ Studies have shown that older pedestrians are particularly overrepresented in crashes at intersections involving left-turning and right-turning vehicles.⁽³⁾

Crash Types and Countermeasures

Close examination of pedestrian crashes can suggest corrective measures to lessen the likelihood of some of these crashes. In the 1970s, methods for typing pedestrian and bicycle crashes were developed by the National Highway Traffic Safety Administration (NHTSA) to better define the sequence of events and precipitating actions leading to pedestrian/motor vehicle crashes.⁽¹¹⁻¹³⁾ These methodologies were applied by Hunter in a 1996 study to more than 8,000 pedestrian and bicycle crashes from 6 States.⁽¹⁴⁾ The results provided a representative summary of the distribution of crash types experienced by pedestrians and bicyclists. Some of the most frequently occurring types, include dart-out first half (i.e., the pedestrian is struck in the first half of the street being crossed) (24 percent), intersection dash (13 percent), dart-out second half (10 percent), midblock dart (8 percent), and turning-vehicle crashes (5 percent).⁽¹¹⁻¹³⁾

Typing Pedestrian Crashes

The development of effective roadway design and operation, education, and enforcement measures to accommodate pedestrians and prevent crashes is hindered by insufficient detail in computerized State and local crash files. Analysis of these databases can provide information on where pedestrian crashes occur (city, street, intersection, two-lane road, etc.), when they occur (time of day, day of week, etc.), and characteristics of the victims involved (age, gender, injury severity, etc.). Current crash files cannot provide a sufficient level of detail regarding the sequence of events leading to the crash.

The crash-typing methodology described above has evolved over time and has been refined as part of a software package known as the Pedestrian and Bicycle Crash Analysis Tool (PBCAT). The development of PBCAT was sponsored by the Federal Highway Administration (FHWA) and NHTSA through the University of North Carolina Highway Safety Research Center.

PBCAT is a software product intended to assist State and local pedestrian and bicycle coordinators, planners, and engineers with the problem of lack of data regarding the sequence of events leading to a crash. PBCAT accomplishes this goal through the development and analysis of a database containing details associated with crashes between motor vehicles and pedestrians or bicyclists. One of these details is the crash type, which describes the pre-crash actions of the parties involved. Of the more than 60 specific pedestrian crash types used for PBCAT, there are 13 general classifications useful for grouping pedestrian crashes. They are defined in Chapter 3. With the database developed, the software can then be used to produce reports and select countermeasures to address the problems identified. Those interested may reg-

ister for the PBCAT software and user's manual from the Pedestrian and Bicycle Information Center website at: www.walkinginfo.org/pbcats.

Chapter 3

Selecting Pedestrian Safety Improvements



Photo by Dan Burden

Methods to Identify High-Crash/High-Risk Locations

Methods to Improve Pedestrian Safety

Crash-Related Countermeasures

Definitions of Pedestrian Crash Types

This chapter is divided into three sections. The first section discusses the process of identifying locations for safety treatments where pedestrian crashes have occurred in the past and may occur in the future. The second section of this chapter is a general discussion of methods to improve pedestrian safety. The chapter concludes by providing a matrix of pedestrian engineering and operational improvements that might be used to address 13 pedestrian crash groups.



Photo by Robert Schneider

Methods to Identify High-Crash/High-Risk Locations

A first step in the process of improving pedestrian safety is to identify locations or areas where pedestrian crash problems exist and where engineering, education, and enforcement measures will be most beneficial. Mapping the locations of reported pedestrian crashes in a neighborhood, campus, or city is a simple method of identifying sites for improving walking safety. One method of analyzing crash locations includes using computerized Geographic Information Systems (GIS) software, as shown by the density map of reported pedestrian crashes on a college campus pictured on the next page.

This type of map can help transportation engineers and planners focus safety improvements on intersections, street sections, or neighborhoods where pedestrian crashes have occurred.

Several issues should be considered when creating GIS maps of reported crash locations. First, the total number of pedestrians and vehicles that use each location will affect reported crash density.

Reported Pedestrian Crash Density

Campus Area, 1994 to 1999



Pedestrian Crash Density



- Reported Pedestrian Crash
- Area of Campus Influence
- Street
- Location identified for safety treatments

Source: NC DOT Crash Reports, 10/1/94 to 9/30/99
Total Campus Area Pedestrian Crashes: 57
Kernel Density Search Radius: 500 feet

Kernel Estimator: UNIG-HDRC
November 2000

Second, pedestrian crashes may not be reported frequently enough to establish a pattern of unsafe walking locations. In either case, performing a conflict analysis, noting pedestrian and driver behavior or examining roadway and walkway characteristics at specific sites, or mapping locations known to have a high potential for pedestrian crashes in an area may improve the identification of unsafe locations for walking. Other methods for identifying locations with pedestrian problems include using walkability checklists and calculating a pedestrian level of service.

Methods to Improve Pedestrian Safety

Some pedestrian crashes are associated with deficient roadway designs. Pedestrians and motorists often contribute to pedestrian crashes through a disregard or lack of understanding of laws and safe driving or walking behavior.⁽¹⁾ Because most crashes are a result of human error, crashes will not be completely eliminated as long as pedestrians and vehicles share the same space. Yet, the consequences of these crashes are exacerbated by speeding, failing to yield, or failing to check both directions for traffic, so new education, enforcement,

and engineering tools are needed to manage the conflict between pedestrians and drivers.

A complete program of pedestrian safety improvements includes:⁽¹⁻²⁾

- Provision of pedestrian facilities, such as sidewalks and crosswalks.
- Roadway and engineering measures, such as traffic control devices, lighting, and roadway design strategies implemented on streets and highways for both pedestrian and vehicular movements.
- Programs to enforce existing traffic laws and ordinances for motorists (e.g., obeying speed limits, yielding to pedestrians when turning, traffic signal compliance, obeying drunk-driving laws) and pedestrians (e.g., crossing the street at legal crossings, obeying traffic and pedestrian signals).
- Forgiving vehicle designs that minimize pedestrian injury from vehicle impact.
- Wearing of reflective clothing and materials by pedestrians, and/or using a flashlight when walking at night.
- Education programs provided to motorists and pedestrians.

Roadway improvements can often reduce the likelihood of a pedestrian crash. Physical improvements are most effective when tailored to an individual location and traffic problem. Factors to consider when choosing an improvement include: location characteristics, pedestrian and vehicle volume and types, vehicle speed, design of a given location, city laws and ordinances, and financial constraints.^(1,3)

It is important to remember that overuse or unjustified use of any traffic control measure is not recommended, since this may breed disrespect for such devices.⁽⁴⁾ Although facilities for pedestrians can, in many cases, reduce the risk of pedestrian collisions, crash reduction is not the only reason for providing such facilities. Other benefits of pedestrian facilities include improved access to destinations by walking, better air quality due to less dependence on driving, and improved personal health. Traffic and transportation engineers have the responsibility for providing facilities for all modes of travel, including walking.⁽¹⁾

Crash-Related Countermeasures

A total of 47 different pedestrian measures are presented in this guide that address various types of roadway situations. However, engineers and planners may want further guidance on which pedestrian measures are appropriate to address certain types of pedestrian crashes.

Pages 22-25 contain a matrix of 12 pedestrian crash groupings, with a list of 49 possible countermeasures. The final two countermeasures, education and enforcement, are essential complements to each of the 47 engineering treatments. Although they are not discussed in detail in this guide, they are addressed in several education and enforcement references. The dots in the matrix suggest the countermeasures that

may be primary candidates to address a given crash type, which takes into account whether the crash type occurs at an intersection or mid-block location. The secondary benefits are not included in the matrix. For example, the primary purpose of a pedestrian street is to address midblock crash types (e.g., dartout, dash). Although a pedestrian may have the secondary benefit of eliminating a "through vehicle at intersection" crash type, it is not a suggested treatment for this crash type. Instead, such countermeasures as mini-circles, intersection diverters, etc., are suggested in the matrix to address "through vehicle at intersection" crashes.

To illustrate how to use the table, consider the second crash type on the table ("Multiple Threat"). This is a crash involving an unsignalized crossing on a multi-lane road, where one vehicle stops to let a pedestrian cross the street. The pedestrian steps into the street in front of the stopped vehicle and then continues into the adjacent lane in front of an oncoming vehicle and is struck. The driver of the second vehicle may not see the pedestrian, since the sight distance is typically blocked by the first (stopped) vehicle.

The chart shows that there are 20 potential countermeasures that may reduce the probability of this type of crash, depending on the site conditions. These countermeasures include curb extensions (which improve sight distance between pedestrians and motorists), pedestrian crossing islands (which provide places of refuge in the middle of the street), crosswalk enhancements, and other possible countermeasures.

After the four-page countermeasure matrix, a more detailed listing is given for each crash type that shows potential countermeasures for various possible causes or problems. For example, for Crash Group 2 (Multiple Threat), three possible causes or problems contributing to this crash type include:

- Motorist's view of pedestrian is blocked so motorist fails to yield.
- Pedestrian tries to cross high-speed and/or high-volume arterial street.
- Pedestrian does not have adequate time to cross multi-lane road way.

A different list of countermeasures is given for each of these three possible contributing factors.

These charts are intended to give general information on candidate measures that should be considered when trying to reduce a pattern of pedestrian crashes at a location or roadway section. Many pedestrian crashes are the direct result of careless or illegal driver behavior and/or unsafe pedestrian behavior. Many of these crashes cannot necessarily be prevented by roadway improvements alone. In such cases, pedestrian and/or motorist education and enforcement activities may be helpful.

The next chapter provides details on the 47 engineering improvements to enhance pedestrian safety and mobility.

CRASH GROUP	Midblock Dart/Dash	Multiple Threat	Midblock Mailbox Etc.	Failure to Yield (Unsignalized)	Bus- Related
--------------------	-----------------------	--------------------	-----------------------------	---------------------------------------	-----------------

COUNTERMEASURES

1. Sidewalk/Walkway					•
2. Curb Ramp				•	•
3. Crosswalk Enhancements	•	•		•	•
4. Transit Stop Treatments	•	•		•	•
5. Roadway Lighting	•	•	•	•	•
6. Overpass/Underpass	•	•		•	
7. Street Furniture	•				•
8. Bike Lane/Shoulder	•	•	•	•	•
9. Road/Lane Narrowing	•	•	•	•	
10. Fewer Lanes		•		•	•
11. Driveway Improvement					
12. Raised Median	•	•	•	•	
13. One-Way Street					
14. Smaller Curb Radius				•	
15. Right-Turn Slip Lane					
16. Modern Roundabout					
17. Modified T-Intersection					
18. Intersection Median Barrier		•		•	
19. Curb Extension	•	•		•	•
20. Choker	•			•	
21. Pedestrian Crossing Island	•	•		•	•
22. Chicane	•		•	•	
23. Mini-Circle					
24. Speed Humps	•		•	•	
25. Speed Table	•	•	•	•	
26. Raised Intersection				•	

Turning Vehicle At Intersection	Through Vehicle At Intersection	Walking Along Roadway	Working/Playing in Road	Not in Road	Backing Vehicle	Crossing Expressway
---------------------------------	---------------------------------	-----------------------	-------------------------	-------------	-----------------	---------------------

		•	•	•	•	
•	•	•				
•	•					
•	•	•	•	•	•	•
•	•					•
		•				
		•	•	•		
		•	•			
		•				
•	•			•	•	
•	•					
•				•		
•	•					
•	•			•	•	
•	•					
			•			
•	•		•			
			•			
			•			
•	•					

CRASH GROUP	Midblock Dart/Dash	Multiple Threat	Midblock Mailbox Etc.	Failure to Yield (Unsignalized)	Bus- Related
--------------------	-----------------------	--------------------	-----------------------------	---------------------------------------	-----------------

COUNTERMEASURES

27. Raised Ped. Crossing	•	•		•	•
28. Gateway	•		•	•	
29. Landscape Options				•	
30. Paving Treatments				•	
31. Driveway Link/Serpentine	•			•	
32. Woonerf	•				
33. Diverter	•				
34. Full Street Closure	•				
35. Partial Street Closure	•				
36. Pedestrian Street	•			•	
37. Traffic Signal	•	•		•	•
38. Pedestrian Signal	•	•		•	•
39. Pedestrian Signal Timing					
40. Signal Enhancement	•				
41. RTOR Restriction					
42. Advanced Stop Lines		•			•
43. Sign Improvement	•	•	•	•	•
44. School Zone Improvement	•	•		•	•
45. Identify Neighborhood	•		•	•	
46. Speed-Monitoring Trailer	•		•	•	
47. Parking Enhancement	•		•	•	•
48. Ped./Driver Education	•	•	•	•	•
49. Police Enforcement	•	•	•	•	•

Turning Vehicle At Intersection	Through Vehicle At Intersection	Walking Along Roadway	Working/ Playing in Road	Not in Road	Backing Vehicle	Crossing Expressway
---------------------------------	---------------------------------	-----------------------	--------------------------	-------------	-----------------	---------------------

•

•

•

•

•

•

•

•

•

•

•

•

•

•

•

•

•

•

•

•

•

•

•

•

•

•

•

•

•

•

•

•

•

•

•

•

•

•

•

•

•

•

•

•

•

•

•

•

•

•

•

•

•

•

•

•

•

•

•

•

•

•

•

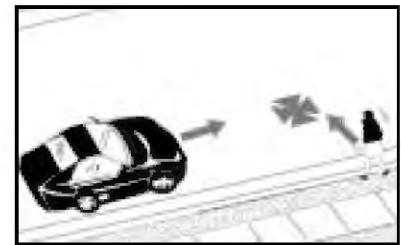
•

Of the more than 60 specific pedestrian crash types, there are 13 crash groupings (12 specific types and 1 miscellaneous type) that are most useful for identifying safety problems and corresponding countermeasures. They are defined below:

Definitions of Pedestrian Crash Types

1. Midblock: Dart/Dash

The pedestrian walked or ran into the roadway and was struck by a vehicle. The motorist's view of the pedestrian may have been blocked until an instant before the impact, and/or the motorist may have been speeding.



Possible Cause/Problem #1

Child runs into neighborhood/collector street.

General Countermeasures

- a. Implement traffic-calming measures such as speed humps, speed tables, or chicanes.
- b. Remove or restrict on-street parking.
- c. Provide adequate nighttime lighting.
- d. Provide curb extensions.
- e. Install spot street narrowing at high midblock-crossing locations.
- f. Narrow travel lanes.
- g. Install street closure/diagonal diverter at selected intersection(s).
- h. Provide adult crossing guard (in school zone).
- i. Educate children about safe crossing behavior and adults about speeding.
- j. Add on-street bike lanes.
- k. Convert street to woonerf, pedestrian street, or driveway link/serpentine.
- l. Design gateway to alert motorists that they are entering neighborhood with high level of pedestrian activity.
- m. Provide a raised pedestrian crossing.

Possible Cause/Problem #2

Pedestrian tries to cross high-speed and/or high-volume arterial street.

General Countermeasures

- a. Install medians or pedestrian crossing islands.
- b. Provide staggered crosswalk through the median (forcing pedestrians to walk and look to the right for oncoming traffic in the second half of street).
- c. Provide curb extensions at intersections or midblock to improve direct line of sight between vehicle and pedestrian.
- d. Improve/add nighttime lighting.
- e. Install midblock traffic signal with pedestrian signals, if warranted.
- f. Install standard warning sign (see *Manual on Uniform Traffic Control Devices* (MUTCD)) or yellow or fluorescent yellow/green signs to alert drivers to pedestrian crossing area.
- g. Install overpass or underpass.

- h. Enforce speed limits, pedestrian ordinances.
- i. Add traffic-calming measures.
- j. Bus young children across busy streets or adjust school district boundaries.
- k. Relocate bus stop.
- l. Use speed-monitoring trailer.

2. Multiple Threat

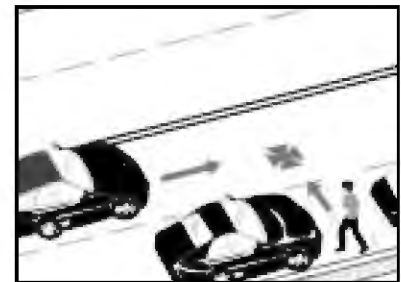
The pedestrian entered the traffic lane in front of stopped traffic and was struck by a vehicle traveling in the same direction as the stopped vehicle. The stopped vehicle may have blocked the visibility between the pedestrian and the striking vehicle, and/or the motorist may have been speeding.

Possible Cause/Problem #1

Motorist's view of pedestrian is blocked and motorist fails to yield.

General Countermeasures

- a. Recess stop lines 9.1 m (30 ft) in advance of crosswalk.
- b. Install traffic signals with pedestrian Hand/Man or WALK/DON'T WALK signals, if warranted.
- c. Provide midblock or intersection curb extensions.
- d. Install traffic-calming devices such as speed tables or raised pedestrian crossings on local or other neighborhood streets.
- e. Install barriers or signs to prohibit crossings and direct pedestrians to safer crossing locations nearby.
- f. Provide raised crosswalks to improve pedestrian visibility.
- g. Install advance warning signs or flashers.
- h. Relocate bus stop to far side of crossing area.
- i. Improve roadway lighting.
- j. Enforce crosswalk laws.



Possible Cause/Problem #2

Pedestrian tries to cross high-speed and/or high-volume arterial street.

General Countermeasures

- a. Narrow travel lanes (e.g., add bike lanes) to slow vehicle speeds and reduce crossing distance.
- b. Reduce roadway width. For example, modify four-lane undivided roadways to two through lanes with sidewalks and bike lanes, plus a center two-way left-turn lane (or raised median).
- c. Increase police enforcement of speed limit.
- d. Construct overpass or underpass.
- e. Install raised median or pedestrian crossing island.

Possible Cause/Problem #3

Pedestrian does not have adequate time to cross multi-lane roadway.

General Countermeasures

- a. Install traffic signals with pedestrian WALK/DON'T WALK signals, if warranted.

- b. Adjust pedestrian signal timing.
- c. Provide raised crosswalk to improve pedestrian visibility.
- d. Provide midblock or intersection curb extensions.
- e. Install raised pedestrian crossing island.
- f. Enforce crosswalk laws.
- g. Reduce roadway width.

3. Mailbox or Other Midblock

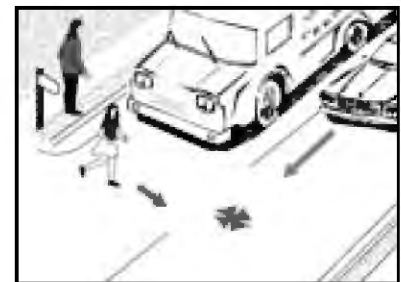
The pedestrian was struck while getting into or out of a stopped vehicle or while crossing the road to/from a mailbox, newspaper box, ice-cream truck, etc.

Possible Cause/Problem #1

Pedestrian struck while going to/from a private residence mailbox/newspaper box.

General Countermeasures

- a. Relocate mailboxes to safer crossing area or provide safer crossings at existing location.
- b. Improve lighting.
- c. Provide traffic-calming measures (e.g., chicanes or raised devices on residential streets).
- d. Add bike lanes and reduce total roadway and lane width.
- e. Install pedestrian warning signs (see MUTCD).
- f. Implement driver education program.
- g. Implement pedestrian education program.
- h. Provide raised median on multi-lane arterial street.
- i. Construct gateway or provide signs that identify neighborhood as an area with high levels of pedestrian activity.



Possible Cause/Problem #2

Pedestrian struck while going to/from an ice-cream vendor or similiar destination.

General Countermeasures

- a. Reduce lane or roadway width.
- b. Add pedestrian crossing islands to roadway.
- c. Provide traffic-calming measures on local streets.
- d. Create Public Service Announcements (PSAs) to educate parents, children, and drivers.
- e. Adopt an Ice-Cream Truck Ordinance. This ordinance would prohibit motorists from passing a stopped ice-cream truck. Trucks would be equipped with flashing lights and a "stop" arm that would extend when the truck stopped to serve children.

Possible Cause/Problem #3

Pedestrian struck while getting into/out of parked vehicle or by an emergency or speeding vehicle.

General Countermeasures

- a. Implement speed-reduction measures such as chicanes or speed tables.
- b. Implement traffic-calming measures on local/collector streets.
- c. Restrict on-street parking.
- d. Increase police enforcement of speed limit.

4. Failure to Yield at Unsignalized Location

At an unsignalized intersection or midblock location, a pedestrian stepped into the roadway and was struck by a vehicle. The motorist failed to yield to the pedestrian and/or the pedestrian stepped directly into the path of the oncoming vehicle.

Possible Cause/Problem #1

Motorist fails to yield to pedestrian at two-lane, low-speed road crosswalk (or unmarked crossing).

General Countermeasures

- a. Install raised intersection, raised crosswalk, speed table, or speed humps with truncated domes at both ends.
- b. Install overhead CROSSWALK, school zone, or other warning signs.
- c. Install curb extensions or choker.
- d. Construct raised pedestrian crossing island.
- e. Install traffic signal with pedestrian signals, if warranted.
- f. Add chicane, use serpentine design or use special paving treatments along street to slow traffic.
- g. Use landscaping that slows vehicle speeds without impeding sightlines.
- h. Reduce curb radius to slow vehicle speeds.

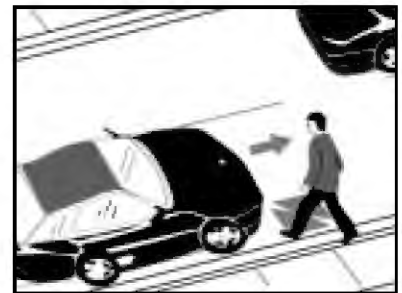


Possible Cause/Problem #2

Pedestrian has difficulty crossing multi-lane road.

General Countermeasures

- a. Install raised medians or pedestrian crossing islands.
- b. Install traffic signal with pedestrian signals, if warranted.
- c. Modify four-lane, undivided street to two lanes plus a two-way, left-turn lane (TWLTL) or median with turning pockets and bike lanes.
- d. Install nighttime lighting.
- e. Use police speed enforcement.
- f. Use far-side bus stops.
- g. Narrow lanes, reduce number of lanes, and/or install bike lanes.
- h. Construct overpass or underpass.
- i. Ensure that curb ramps are provided to make crossing easier for all pedestrians.



Possible Cause/Problem #3

Motorist unwilling to yield due to high motorist speeds or high traffic volumes.

General Countermeasures

- a. Implement traffic-calming measures.
- b. Narrow roadway by reducing number of lanes, reducing lane widths, and/or adding bicycle lanes.
- c. Provide gateway, identify neighborhood with signs, and/or create a pedestrian street.
- d. Increase police enforcement of speed limit.
- e. Construct pedestrian crossing islands.
- f. Install traffic signal with pedestrian signals, if necessary.
- g. Install signs or sidewalk barriers to guide pedestrians to safer crossing locations.
- h. Use speed-monitoring trailer.

5. Bus-Related

The pedestrian was struck by a vehicle either: (1) by crossing in front of a commercial bus stopped at a bus stop; (2) going to or from a school bus stop; or (3) going to or from, or waiting near, a commercial bus stop.

Possible Cause/Problem #1

Motorist fails to yield to pedestrian or pedestrian crosses during inadequate gap in traffic due to limited sight distance at intersection.



General Countermeasures

- a. Move bus stop to far side of intersection or crosswalk.
- b. Install curb extension.
- c. Consider an alternative bus stop location.
- d. Install pedestrian crossing islands or raised crosswalk.
- e. Install or improve roadway lighting.
- f. Install crosswalk markings to encourage pedestrians to cross in the crosswalk behind the bus.
- g. Mark bus stop area with pedestrian warning signs.
- h. Remove parking in areas that obstruct the vision of motorists and pedestrians.

Possible Cause/Problem #2

Pedestrian has difficulty walking along roadway and crossing at midblock location with high vehicle speeds and/or high volumes.

General Countermeasures

- a. Provide bus pull-off area.
- b. Consider an alternative bus stop location.
- c. Install midblock curb extensions.
- d. Provide curb ramps and an accessible sidewalk.
- e. Install sidewalk and/or sidewalk barriers to direct pedestrians to a nearby crossing location.
- f. Provide pedestrian education/training.
- g. Add bike lanes or painted shoulder.
- h. Add recessed stop lines.

- i. Increase police speed enforcement.
- j. Install or improve roadway lighting.
- k. Reduce number of roadway lanes.
- l. Install traffic and pedestrian signals, if warranted.

Possible Cause/Problem #3

Pedestrian has difficult time crossing, waiting, or walking in the vicinity of school bus stop.

General Countermeasures

- a. Select safer location for school bus stop.
- b. Implement pedestrian/driver education programs.
- c. Involve school, neighborhood groups, and PTA in promoting enforcement and education.
- d. Provide sidewalks.
- e. Provide street furniture or other amenities at bus stop.
- f. Install or improve roadway lighting.
- g. Enforce regulations against passing stopped school bus.
- h. Educate pedestrians to cross behind the bus.

6. Turning Vehicle at Intersection

The pedestrian was attempting to cross at an intersection and was struck by a vehicle that was turning right or left.

Possible Cause/Problem #1

Conflict between pedestrian and left-turning vehicle.

General Countermeasures

- a. Prohibit left turns.
- b. Provide separate left-turn and WALK/DON'T WALK signals.
- c. Add special pedestrian signal phasing (e.g., exclusive protected pedestrian signal or leading pedestrian interval).
- d. Convert to one-way street network (if justified by surrounding areawide pedestrian and traffic volume study).
- e. Install warning signs for pedestrians and/or motorists (see MUTCD).
- f. Develop/provide Public Safety Announcement (PSA) safety messages.
- g. Add curb extensions or curb ramps.
- h. Convert intersection to modern roundabout or mini-circle where all motorists turn right.
- i. Consider closing street or using modified T-intersection, diverter, or intersection median barrier.
- j. Construct overpass or underpass.
- k. Install pedestrian crossing island and raised median.
- l. Use traffic-calming devices, such as a raised intersection or raised pedestrian crossing, to reduce vehicle speeds.



Possible Cause/Problem #2

Conflict between pedestrian and right-turning vehicle.

General Countermeasures

- a. Prohibit Right Turn on Red (RTOR).
- b. Reduce right-turn radii.
- c. Add curb extensions or curb ramps.
- d. Improve right-turn slip-lane design.
- e. Install warning signs for pedestrians and/or motorists.
- f. Provide leading pedestrian interval.
- g. Remove intersection snow/clutter at the corner to improve visibility and give pedestrian space to stand outside of roadway.
- h. Improve intersection lighting to improve visibility.
- i. Provide advanced stop lines and marked crosswalks.
- j. Consider street closure.
- k. Move bus stop to far side of intersection.
- l. Construct overpass or underpass.
- m. Install pedestrian crossing island and raised median.
- n. Use a traffic-calming device, such as a raised intersection or raised pedestrian crossing, to reduce vehicle speeds.
- o. Remove on-street parking from the approaches to crosswalks.



Possible Cause/Problem #3

Substantial number of school children crossing and large turning vehicle movement.

General Countermeasures

- a. Provide adult crossing guards during school crossing periods, or two guards for wide streets.
- b. Provide police enforcement at the intersection.
- c. Educate children about safe crossing behavior.
- d. Install pedestrian crossing islands for wide two-way streets.
- e. Prohibit left turns.
- f. Add exclusive pedestrian phase or leading pedestrian interval.
- g. Improve intersection lighting.
- h. Consider closing street or using modified T-intersection, diverter, or intersection median barrier.

Possible Cause/Problem #4

Inadequate sight distance and/or intersection geometrics.

General Countermeasures

- a. Remove sight obstructions and/or roadside obstacles (e.g., trees/shrubs, mailboxes, poles, newsstands, trash cans).
- b. Provide special pedestrian signal phasing (e.g., exclusive protected pedestrian signal interval).
- c. Install pedestrian warning signs and/or motorist regulatory signs (see MUTCD).
- d. Prohibit left turns.

- e. Reduce turn radii.
- f. Install right-turn slip lane with pedestrian safety islands.
- g. Improve intersection lighting.
- h. Add paving treatments that improve visibility of pedestrian crossing areas.
- i. Prohibit Right Turn on Red (RTOR).

7. Through Vehicle at Intersection

The pedestrian was struck at a signalized or unsignalized intersection by a vehicle that was traveling straight ahead.

Possible Cause/Problem #1

Pedestrian could not see traffic signal.

General Countermeasures

- a. Install new or larger pedestrian WALK/DON'T WALK or automated pedestrian signals.
- b. Move bus stop to far side of intersection.



Possible Cause/Problem #2

Children crossing in school zones.

General Countermeasures

- a. Provide adult crossing guards, or two guards for wide streets.
- b. Install pedestrian overpass or underpass.
- c. Install pedestrian signals.
- d. Install school regulatory flashers (e.g., SPEED LIMIT 25 MPH WHEN FLASHING).
- e. Provide school zone signs and pavement markings.
- f. Provide pedestrian education to students and motorists.
- g. Increase police enforcement.
- h. Use traffic-calming devices such as raised intersection or mini-circle to reduce vehicle speeds.
- i. Consider closing street or using diverter or intersection median barrier.
- j. Provide advanced stop lines.
- k. Provide curb extensions to reduce crossing distance.
- l. Provide curb ramps to make crossing easier for all pedestrians.
- m. Provide a raised pedestrian crossing.
- n. Convert to one-way street network (if justified by surrounding areawide pedestrian and traffic volume study).

Possible Cause/Problem #3

Excessive delay to pedestrians prior to getting the WALK interval.

General Countermeasures

- a. Re-time signal to be more responsive to pedestrian needs (e.g., shorter cycle lengths or convert to fixed-time operation).
- b. Provide quick-response pedestrian push-buttons or automatic (e.g., microwave or infrared) detectors.



- c. Install pedestrian overpass or underpass (if justified based on high pedestrian volumes with high traffic speeds or volumes).
- d. Provide pedestrian crossing islands.

Possible Cause/Problem #4

Lack of pedestrian compliance with WALK phase due to other causes.

General Countermeasures

- a. Re-time signal to be more responsive to pedestrian needs (e.g., shorter cycle length).
- b. Provide adequate WALK and clearance intervals.
- c. Provide leading pedestrian interval.
- d. Provide pedestrian education to students and motorists.
- e. Provide adult crossing guard at school crossings.

Possible Cause/Problem #5

Motorist did not see pedestrian in time to stop.

General Countermeasures

- a. Remove sight obstructions such as mailboxes or parked vehicles.
- b. Add pedestrian crossing islands or raised crosswalk.
- c. Remove on-street parking near intersection (e.g., up to 30.5 m [100 ft]).
- d. Use traffic-calming devices, such as speed tables or a speed-monitoring trailer, on streets approaching the intersection if speed is an issue.
- e. Add curb extensions.
- f. Construct raised intersection.
- g. Improve nighttime lighting.
- h. Move bus stop to far side of intersection.
- i. Add paving treatments that improve visibility of pedestrian crossing areas.

Possible Cause/Problem #6

Motorist ran red light at signalized intersection.

General Countermeasures

- a. Increase police enforcement.
- b. Install camera enforcement.
- c. Add short all-red interval at signal.

8. Walking Along Roadway

The pedestrian was walking or running along the roadway and was struck from the front or from behind by a vehicle.

Possible Cause/Problem #1

Inadequate walking area.

General Countermeasures

- a. Provide a sidewalk on both sides of road.



- b. Provide an asphalt path or paved shoulder.
- c. Reduce number of lanes (e.g., four lanes to three lanes) and add sidewalk, planting strip, bike lanes, or painted shoulder.
- d. Construct and maintain sidewalks and curb ramps to be usable by people with disabilities.

Possible Cause/Problem #2

High vehicle speeds and/or volume.

General Countermeasures

- a. Add sidewalk or walkway.
- b. Provide nighttime lighting.
- c. Install "Walk on Left Facing Traffic" signs.
- d. Increase lateral separation between pedestrians and motor vehicles (e.g., bike lanes or landscape buffers).
- e. Increase police enforcement of speed limit.
- f. Construct and maintain sidewalks and curb ramps to be usable by people with disabilities.
- g. Use speed-monitoring trailers.
- h. Construct gateway or install signs to identify neighborhood as area with high pedestrian activity.

Possible Cause/Problem #3

Indequate route to school.

General Countermeasures

- a. Provide sidewalks.
- b. Involve school groups and PTA in evaluating safe routes to school and promoting education and enforcement.
- c. Provide adult crossing guards.
- d. Implement traffic-calming methods at selected sites.
- e. Construct and maintain sidewalks and curb ramps to be usable by people with disabilities.

Possible Cause/Problem #4

Sidewalks are not accessible to all pedestrians.

General Countermeasures

- a. Construct curb ramps.
- b. Remove obstacles in sidewalk.
- c. Build missing sidewalk segments.
- d. Relocate poles and street furniture to provide continuous passage in sidewalk area.
- e. Enforce parking laws to prevent cars from blocking sidewalks.

9. Working/Playing in Road

A vehicle struck a pedestrian who was: (1) standing or walking near a disabled vehicle, (2) riding a play vehicle that was not a bicycle (e.g., wagon, sled, tricycle, skates), (3) playing in the road, or (4) working in the road.

Possible Cause/Problem #1

Worker, policeman, etc. struck in roadway (arterial street).

General Countermeasures

- a. Provide better physical separation/protection from motor vehicles.
- b. Improve nighttime lighting and retroreflective materials on workers.
- c. Improve traffic control measures (e.g., signs, markings, cones, barricades, and flashers) warning motorists of workers' presence.
- d. Increase police enforcement of speed limits in work zones.
- e. Increase worker safety training.

Possible Cause/Problem #2

Pedestrian was struck playing on foot or on play vehicle (e.g., skateboard, wagon, sled, in-line skates) on local/collector street.

General Countermeasures

- a. Provide accessible sidewalks or walkways on both sides of street.
- b. Introduce traffic-calming measures (e.g., speed humps, street narrowing).
- c. Improve nighttime lighting.
- d. Implement pedestrian and motorist education programs.
- e. Provide community park/playground.
- f. Convert streets to a woonerf or use signs to identify neighborhood as area with high levels of pedestrian activity.
- g. Consider street closures (full or partial) or using diverters.

Possible Cause/Problem #3

Vehicle speeds are excessive on local street.

General Countermeasures

- a. Narrow streets and/or travel lanes.
- b. Install traffic-calming devices such as speed humps, speed tables, mini-circles, and/or chicanes.
- c. Convert to driveway link/serpentine street.
- d. Use speed-monitoring trailers in conjunction with police enforcement.

Possible Cause/Problem #4

Disabled vehicle-related (walking to/from disabled vehicle).

General Countermeasures

- a. Provide sidewalks, walkways, or paved shoulders.
- b. Implement pedestrian/driver education program.
- c. Provide adequate nighttime lighting.
- d. Provide motorist assistance program.



Possible Cause/Problem #5

Working on or standing by a disabled vehicle.

General Countermeasures

- a. Provide paved shoulders.
- b. Provide adequate nighttime lighting.
- c. Educate drivers about what to do if a vehicle becomes disabled.
- d. Provide a motorist assistance program.

10. Not in Road (Sidewalk, Driveway, Parking Lot, or Other)

The pedestrian was standing or walking near the roadway edge, on the sidewalk, in a driveway or alley, or in a parking lot, when struck by a vehicle.

Possible Cause/Problem #1

Pedestrian was struck while waiting to cross roadway, standing at or near curb.

General Countermeasures

- a. Provide accessible sidewalks/walkways and crosswalks.
- b. Install curb extensions for better line of sight between pedestrians and motor vehicles.
- c. Reduce curb radii to slow turning cars.
- d. Implement driver education program.
- e. Install sidewalk barriers.
- f. Improve nighttime lighting.
- g. Increase speed enforcement.
- h. Provide sidewalk buffer (landscape strip or bike lane).
- i. Use adult crossing guard.

Possible Cause/Problem #2

Pedestrian was struck in parking lot, driveway, private road, gas station, alley, etc.

General Countermeasures

- a. Redesign or re-stripe parking lot to provide pedestrian access.
- b. Maintain level sidewalk across driveway area.
- c. Implement pedestrian and motorist education programs.
- d. Move sidewalk farther back so that driver will have more time to stop for a pedestrian crossing a driveway.
- e. Improve nighttime lighting.
- f. Build/improve local parks for child activities.
- g. Provide clear pedestrian path across parking lot.
- h. Remove landscaping or other visual obstructions near driveways.

Possible Cause/Problem #3

Vehicle entered or exited a driveway or alley and struck pedestrian.



General Countermeasures

- a. Provide sidewalk or walkway.
- b. Add adequate planting strip or sidewalk separation.
- c. Remove sight obstructions (e.g., trim hedges or lower fencing).
- d. Maintain level sidewalks across driveways or alleys.
- e. Narrow driveways and reduce turning radii.
- f. Provide clear walking path across driveway.
- g. Remove unneeded driveways and alleys.
- h. Provide advance warning signs for drivers.

11. Backing Vehicle

The pedestrian was struck by a backing vehicle on a street, in a driveway, on a sidewalk, in a parking lot, or at another location.

Possible Cause/Problem #1

Pedestrian struck by backing vehicle.

General Countermeasures

- a. Enhance pedestrian education.
- b. Enhance motorist education.
- c. Provide auditory backing alert on vehicle.
- d. Eliminate, modify, or relocate parking if feasible.
- e. Remove unneeded driveways and alleys.
- f. Remove landscaping or other sight obstruction near driveways.
- g. Provide clearly delineated walkways for pedestrians in parking lots.
- h. Relocate pedestrian walkways.
- i. Improve nighttime lighting.
- j. Provide raised pedestrian crossings or curb extensions to improve the visibility of pedestrians to backing motorists.



12. Crossing on Expressway

The pedestrian was struck while crossing a limited-access expressway or expressway ramp.

Possible Cause/Problem #1

Disabled vehicle (pedestrian crosses expressway to seek help).

General Countermeasures

- a. Install/upgrade roadway lighting.
- b. Increase police surveillance.
- c. Provide motorist assistance program.
- d. Educate drivers on what to do if a vehicle is disabled.



Possible Cause/Problem #2

Pedestrians routinely cross section of expressway.

General Countermeasures

- a. Install large, visible pedestrian warning signs.
- b. Install/upgrade nighttime lighting.
- c. Provide pedestrian overpass/underpass.
- d. Install pedestrian fencing or barriers along roadway right-of-way
- e. Increase police surveillance.

13. Miscellaneous

This category includes all other pedestrian crash types, such as: intentional crashes, driverless vehicle, a secondary crash after a vehicle/vehicle collision, a pedestrian struck by falling cargo, emergency vehicle striking a pedestrian, a pedestrian standing or lying in the road, or other/unknown circumstances.

The information described above on pedestrian crash groups is referenced in the next chapter for selecting corresponding pedestrian safety improvements.



Possible Cause/Problem #1

Pedestrian lying in road.

General Countermeasures

- a. Install or upgrade nighttime lighting.
- b. Increase police enforcement and surveillance.
- c. Provide taxi rides home from bars.

Possible Cause/Problem #2

Emergency vehicle-related.

General Countermeasures

- a. Increase police surveillance.
- b. Install/upgrade lighting.
- c. Provide public education.

Possible Cause/Problem #3

Pedestrian falls from vehicle.

General Countermeasures

- a. Increase police enforcement of teens "vehicle surfing."
- b. Pass/enforce laws and provide education programs against riding in back of pickup trucks.

Possible Cause/Problem #4

Pedestrian standing in road prior to crash — action unknown.

General Countermeasures

- a. Provide accessible sidewalks/walkways and crosswalks.
- b. Install/upgrade roadway lighting.
- c. Provide raised median (multi-lane roads).
- d. Add pedestrian crossing islands.

- e. Enforce speed limit.
- f. Provide safe pedestrian crossings (e.g., traffic signal, if warranted).

Possible Cause/Problem #5

Pedestrian struck by driverless vehicle.

General Countermeasures

- a. Require mandatory statewide vehicle inspection.
- b. Address through State driver education program.

Chapter 4

The Tools



Photo by Dan Burden

A total of 47 roadway and engineering improvements are discussed in this chapter. The categories of improvements include:

- A. Pedestrian Facility Design**
- B. Roadway Design**
- C. Intersection Design**
- D. Traffic Calming**
- E. Traffic Management**
- F. Signals and Signs**
- G. Other Measures**

A. Pedestrian Facility Design



Photo by Dan Burden



Photo by Cara Seiderman

Walkways are the portion of the public right-of-way that provide a separated area for people traveling on foot. Walkways that are safe, accessible, and aesthetically pleasing attract pedestrians.

People walk for many reasons: to go to a neighbor's house, to run errands, for school, or to get to a business meeting. People also walk for recreation and health benefits or for the enjoyment of being outside. Some pedestrians must walk to transit or other destinations if they wish to travel independently. It is a public responsibility to provide a safe, secure, and comfortable system for all people who walk.

1. Sidewalks or Walkways

Sidewalks and walkways are “pedestrian lanes” that provide people with space to travel within the public right-of-way that is separated from roadway vehicles. They also provide places for children to walk, run, skate, ride bikes, and play. Sidewalks are associated with significant reductions in pedestrian collisions with motor vehicles.⁽¹⁾ Such facilities also improve mobility for pedestrians and provide access for all types of pedestrian travel: to and from home, work, parks, schools, shopping areas, transit stops, etc. Walkways should be part of every new and renovated facility and every effort should be made to retrofit streets that currently do not have sidewalks.

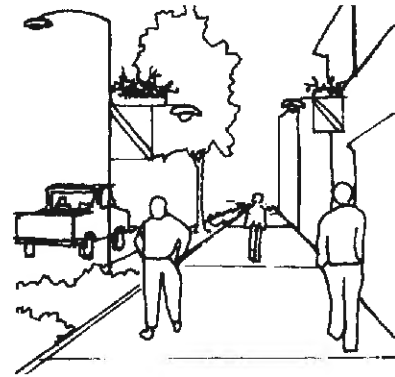
While sidewalks are typically made of concrete, less expensive walkways may be constructed of asphalt, crushed stone, or other materials if they are properly maintained and accessible (firm, stable, and slip-resistant). In more rural areas, in particular, a “side path” made of one of these materials may be suitable. The Institute of Transportation Engineers (ITE) guidelines recommend a minimum width of 1.5 m (5 ft) for a sidewalk or walkway, which allows two people to pass comfortably or to walk side-by-side. Wider sidewalks should be installed near schools, at transit stops, in downtown areas, or anywhere high concentrations of pedestrians exist. Sidewalks should be continuous along both sides of a street and sidewalks should be fully accessible to all pedestrians, including those in wheelchairs.⁽²⁾

A buffer zone of 1.2 to 1.8 m (4 to 6 ft) is desirable and should be provided to separate pedestrians from the street. The buffer zone will vary according to the street type. In downtown or commercial districts, a street furniture zone is usually appropriate. Parked cars and/or bicycle lanes can provide an acceptable buffer zone. In more suburban or rural areas, a landscape strip is generally most suitable. Careful planning of sidewalks and walkways is important in a neighborhood or area in order to provide adequate safety and mobility. For example, there should be a flat sidewalk provided in areas where driveways slope to the roadway.

Recommended guidelines and priorities for sidewalks and walkways are given in Appendix B.



This sidewalk and buffer zone provides a safe place for pedestrians to walk outside of the paths of vehicles in the street.



Making Streets That Work, Seattle, 1996

Purpose:

- Create the appropriate facility for the walking area of the public right-of-way.
- Improve pedestrian safety dramatically.

Considerations:

- While continuous walkways are the goal, retrofitting areas without them will usually occur in phases. Lack of a seamless system is no excuse not to provide parts of the system.
- In retrofitting streets that do not have a continuous or accessible system, locations near transit stops, schools, parks, public buildings, and other areas with high concentrations of pedestrians should be the highest priority.
- Street furniture placement should not restrict pedestrian flow.

Estimated Cost:

The cost for concrete curbs and sidewalks is approximately \$49/linear meter (\$15/linear foot) for curbing and \$118/square meter (\$11/square foot) for walkways. Asphalt curbs and walkways are less costly, but require more maintenance, and are somewhat more difficult to walk and roll on for pedestrians with mobility impairments.

Photo by Dan Burden

2. Curb Ramps

Curb ramps (wheelchair ramps) provide access between the sidewalk and roadway for people using wheelchairs, strollers, walkers, crutches, handcars, bicycles, and also for pedestrians with mobility impairments who have trouble stepping up and down high curbs. Curb ramps must be installed at all intersections and midblock locations where pedestrian crossings exist, as mandated by federal legislation (1973 Rehabilitation Act). Wheelchair ramps must have a slope of no more than 1:12 (must not exceed 25.4 mm/0.3 m (1 in/ft) or a maximum grade of 8.33 percent), with a maximum side slope of 1:10, and must be designed in accordance with the ADA guidelines.

Where feasible, separate curb ramps for each crosswalk at an intersection should be provided rather than having a single ramp at a corner for both crosswalks. This provides improved orientation for visually impaired pedestrians. Similarly, tactile warnings will alert pedestrians to the sidewalk/street edge. All newly constructed and altered roadway projects must include curb ramps. In addition, all agencies should upgrade existing facilities. They can begin by conducting audits of their pedestrian facilities to make sure transit services, schools, public buildings, and parks, etc. are accessible to pedestrians who use wheelchairs.

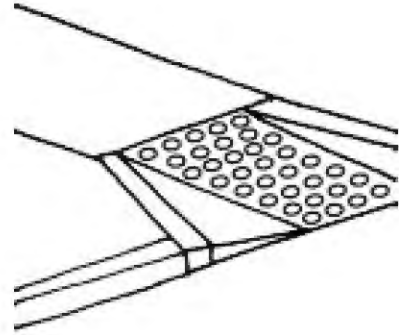
While curb ramps are needed for use on all types of streets, priority locations are in downtown areas and on streets near transit stops, schools, parks, medical facilities, shopping areas, and near residences with people who use wheelchairs.

For more information about curb ramp design, see *Designing Sidewalks and Trails for Access, Part I*, by the Federal Highway Administration, and *Accessible Rights-of-Way: A Design Guide*, by the U.S. Access Board and the Federal Highway Administration. The Access Board's right-of-way report can be found at www.access-board.gov.



Photo by Michael Ronkin

A curb ramp should be designed to provide direct access and should have the proper width and slope.



Adapted from *Making Streets That Work*, Seattle, 1996

Purpose:

- Provide access to street crossings.

Considerations:

- Follow Americans with Disabilities Act (ADA) design guidelines.
- Texture patterns must be detectable to blind pedestrians.

Estimated Cost:

The cost is approximately \$800 to \$1,500 per curb ramp (new or retrofitted).

3. Marked Crosswalks and Enhancements

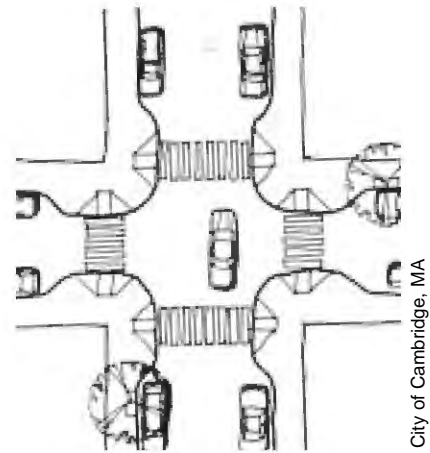
Marked crosswalks indicate optimal or preferred locations for pedestrians to cross and help designate right-of-way for motorists to yield to pedestrians. Crosswalks are often installed at signalized intersections and other selected locations. Various crosswalk marking patterns are given in the MUTCD.⁽³⁾ Marked crosswalks are desirable at some high pedestrian volume locations (often in conjunction with other measures) to guide pedestrians along a preferred walking path. In some cases, they can be raised and should often be installed in conjunction with other enhancements that physically reinforce crosswalks and reduce vehicle speeds. It is also sometimes useful to supplement crosswalk markings with warning signs for motorists. At some locations, signs can get "lost" in visual clutter, so care must be taken in placement.

Pedestrians are sensitive to out-of-the-way travel, and reasonable accommodation should be made to make crossings both convenient and safe at locations with adequate visibility.

Recommended guidelines and priorities for crosswalk installation at controlled locations are given in Appendix C. These guidelines are based on a major study of 1,000 marked crosswalks and 1,000 unmarked crossings in 30 U.S. cities. Recommendations are also given for providing other pedestrian crossing enhancements at uncontrolled locations with and without a marked crosswalk.⁽⁴⁾

Crosswalk Materials

It is important to ensure that crosswalk markings are visible to motorists, particularly at night. Crosswalks should not be slippery or create tripping hazards. Even though granite or cobblestones are aesthetically appealing materials, they are generally not appropriate for crosswalks. One of the best materials for marking crosswalks is inlay tape, which is installed on new or repaved streets. It is highly reflective, long-lasting, and slip-resistant, and does not require a high level of maintenance. Although initially more costly than paint, both inlay tape and thermoplastic are more cost-effective in the long run. Inlay tape is recommended for new and resurfaced pavement, while thermoplastic may be a better option on rougher pavement surfaces. Both inlay tape and thermoplastic are more visible and less slippery than paint when wet.



Purpose:

- Warn motorists to expect pedestrian crossings.
- Indicate preferred crossing locations.

Considerations:

- Crosswalk locations should be convenient for pedestrian access.
- Crosswalk markings alone are unlikely to benefit pedestrian safety. Ideally, crosswalks should be used in conjunction with other measures, such as curb extensions, to improve the safety of a pedestrian crossing, particularly on multi-lane roads with average daily traffic (ADT) above about 10,000.
- Marked crosswalks are important for pedestrians with vision loss.
- Crosswalk markings must be placed to include the ramp so that a wheelchair does not have to leave the crosswalk to access the ramp.

Estimated Cost:

\$100 for a regular striped crosswalk, \$300 for a ladder crosswalk, and \$3,000 for a patterned concrete crosswalk.



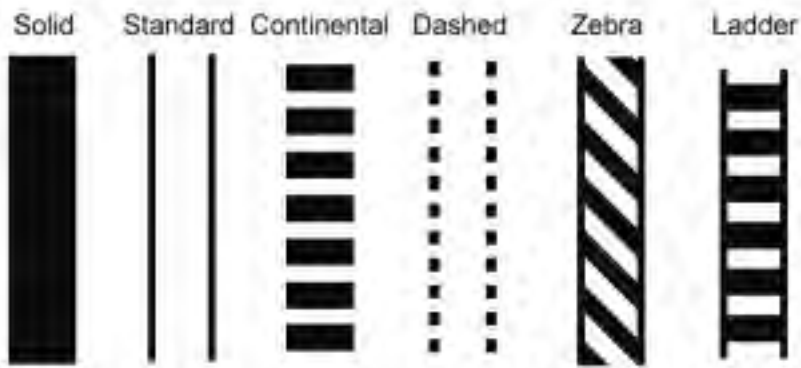
Photo by Peter Lagerwey

The "ladder" pattern shown above is more visible to motorists than parallel lines and requires less maintenance if painted to allow the tires of motor vehicles to track between the painted lines.



Photo by Dan Burden

Some crosswalks are angled to the right in the median. This is intended to facilitate a pedestrian's view of oncoming traffic before crossing the second half of the street.



Examples of different crosswalk marking patterns

4. Transit Stop Treatments

Good public transportation is as important to the quality of a community as good roads. Well-designed transit routes and accessible stops are essential to a usable system.

Bus stops should be located at intervals that are convenient for passengers. The stops should be designed to provide safe and convenient access and should be comfortable places for people to wait. Adequate bus stop signing, lighting, a bus shelter with seating, trash receptacles, and bicycle parking are also desirable features. Bus stops should be highly visible locations where pedestrians can reach them easily by means of accessible travel routes. Therefore, a complete sidewalk system is essential to support a public transportation system. Convenient crossings are also important.

Proper placement of bus stops is key to user safety. For example, placing the bus stops on the near side of intersections or crosswalks may block the pedestrians' view of approaching traffic, and the approaching drivers' view of pedestrians. Approaching motorists may be unable to stop in time when a pedestrian steps from in front of a stopped bus into the traffic lanes at the intersection.

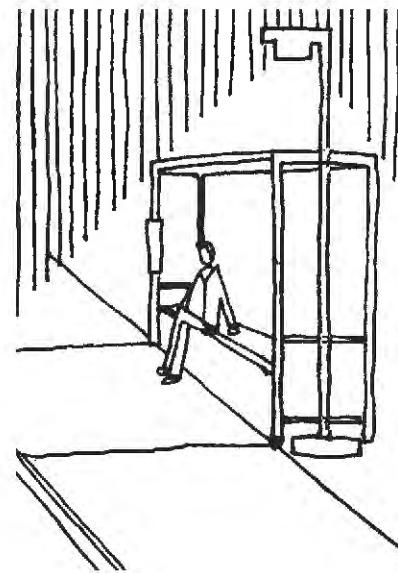
Far-side bus stops generally encourage pedestrians to cross behind the bus. Relocating the bus stop to the far side of the intersection can improve pedestrian safety since it eliminates the sight-distance restriction caused by the bus. Placing bus stops at the far side of intersections can also improve motor vehicle operation.

The bus stop location should be fully accessible to pedestrians in wheelchairs, should have paved connections to sidewalks where landscape buffers exist, and should not block pedestrian travel on the sidewalk. Adequate room should exist to operate wheelchair lifts. Yet, it is also useful to install curb ramps at bus stops so that a passenger can board from the street if bus-lift deployment is blocked.



Photo by Barbara Gray

The transit shelter above is in a lively commercial district. The shelter design reflects the surrounding architecture. Pedestrian-scale lighting and landscaping add visual interest and security.



Adapted from *Making Streets That Work*, Seattle, 1996

Purpose:

- Provide safe, convenient, and inviting access for transit users.

Considerations:

- Ensure that access to and from stops is provided when transit stops are created.
- Ensure adequate room to load wheelchairs.
- Ensure a clear and comfortable path for passing pedestrians when placing transit shelters.
- Locate transit stops on the far side of marked crosswalks.

Estimated Cost:

\$1,000 to \$10,000. Cost varies widely depending on type of improvements.

5. Roadway Lighting Improvements

Good quality and placement of lighting can enhance an environment as well as increase comfort and safety. Pedestrians often assume that motorists can see them at night; they are deceived by their own ability to see the oncoming headlights. Without sufficient overhead lighting, motorists may not be able to see pedestrians in time to stop.

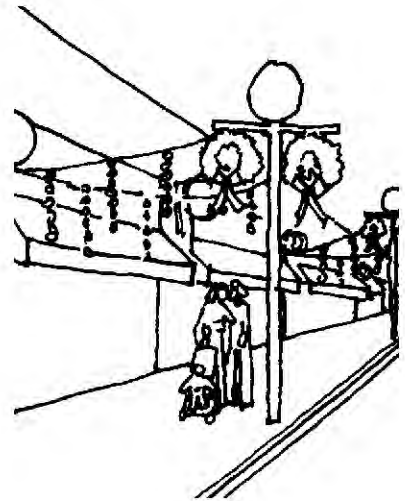
In commercial areas with nighttime pedestrian activity, streetlights and building lights can enhance the ambiance of the area and the visibility of pedestrians by motorists. It is best to place streetlights along both sides of arterial streets and to provide a consistent level of lighting along a roadway. Nighttime pedestrian crossing areas may be supplemented with brighter or additional lighting. This includes lighting pedestrian crosswalks and approaches to the crosswalks.

In commercial areas or in downtown areas, specialty pedestrian-level lighting may be placed over the sidewalks to improve pedestrian comfort, security, and safety. Mercury vapor, incandescent, or less expensive high-pressure sodium lighting is often preferred as pedestrian-level lighting. Low-pressure sodium lights are low energy, but have a high level of color distortion.



Photo by Dan Burden

This well-lit commercial district is an attractive place to shop in the evening. The combination of pedestrian-scaled street lighting, holiday lights in the trees, and light from shop windows enhances visibility and creates a secure and festive atmosphere.



Making Streets That Work, Seattle, 1996

Purpose:

- Enhance safety of all roadway users, particularly pedestrians.
- Enhance commercial districts.
- Improve nighttime security.

Considerations:

- Ensure that pedestrian walkways and crosswalks are well lit.
- Install lighting on both sides of wide streets and streets in commercial districts.
- Use uniform lighting levels.

Estimated Cost:

Varies depending on fixture type and service agreement with local utility.

6. Pedestrian Overpasses/Underpasses

Pedestrian overpasses and underpasses allow for the uninterrupted flow of pedestrian movement separate from the vehicle traffic. However, they should be a measure of last resort, and it is usually more appropriate to use traffic-calming measures or install a pedestrian-activated signal that is accessible to all pedestrians. This is also an extremely high-cost and visually intrusive measure.

Such a facility must accommodate all persons, as required by the ADA. These measures include ramps or elevators. Extensive ramping will accommodate wheelchairs and bicyclists, but results in long crossing distances and steep slopes that discourage use.

Studies have shown that many pedestrians will not use an overpass or underpass if they can cross at street level in about the same amount of time.⁽⁵⁻⁶⁾ Overpasses work best when the topography allows for a structure without ramps (e.g., overpass over a sunken freeway). Underpasses work best when designed to feel open and accessible. Grade separation is most feasible and appropriate in extreme cases where pedestrians must cross roadways such as freeways and high-speed, high-volume arterials.



Photo by Yan Jia

This pedestrian overpass takes advantage of existing topography and allows pedestrians to avoid conflicts with traffic at street level.

Purpose:

- Provide complete separation of pedestrians from motor vehicle traffic.
- Provide crossings where no other pedestrian facility is available.
- Connect off-road trails and paths across major barriers.

Considerations:

- Use sparingly and as a measure of last resort. Most appropriate over busy, high-speed highways, railroad tracks, or natural barriers.
- Pedestrians will not use if a more direct route is available.
- Lighting, drainage, graffiti removal, and security are also major concerns with underpasses.
- Must be wheelchair accessible, which generally results in long ramps on either end of the overpass.

Estimated Cost:

\$500,000 to \$4 million, depending on site characteristics.

7. Street Furniture/Walking Environment

Sidewalks should be continuous and should be part of a system that provides access to goods, services, transit, and homes. Well-designed walking environments are enhanced by urban design elements and street furniture, such as benches, bus shelters, trash receptacles, and water fountains.

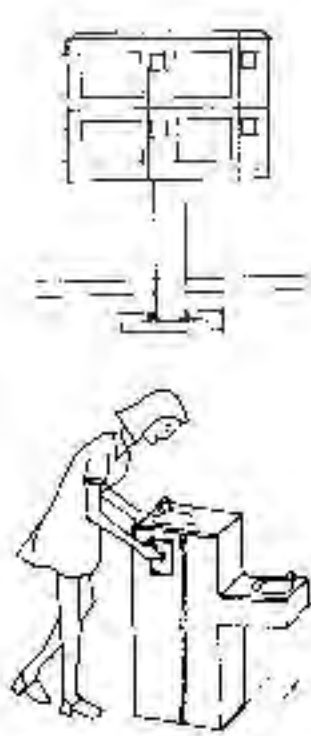
Sidewalks and walkways should be kept clear of poles, signposts, newspaper racks, and other obstacles that could block the path, obscure a driver's view or pedestrian visibility, or become a tripping hazard. Benches, water fountains, bicycle parking racks, and other street furniture should be carefully placed to create an unobstructed path for pedestrians. Such areas must also be properly maintained and kept clear of debris, overgrown landscaping, tripping hazards, or areas where water accumulates. Snow removal is also important for maintaining pedestrian safety and mobility. In most areas, local ordinances give property owners the responsibility of removing snow within 12 to 48 hours after a storm.

Walking areas should also be interesting for pedestrians and provide a secure environment. Storefronts should exist at street level and walking areas should be well lit and have good sightlines.



Photo by Michael Ronkin

This is a good example of a street furniture zone along the sidewalk on Portland, Oregon's light-rail transit line.



Making Streets That Work, Seattle, 1996

Purpose:

- Enhance the pedestrian environment.
- Enliven commercial districts by fostering community life.

Considerations:

- Good-quality street furniture will show that the community values its public spaces and is more cost-effective in the long run.
- Include plans for landscape irrigation and maintenance at the outset.
- Ensure proper placement of furniture; do not block pedestrian walkway or curb ramps or create sightline problems.
- Ensure adequacy of overhead clearances and detectability of protruding objects.

Estimated Cost:

Varies depending on the type of furniture, the material out of which it is constructed, and the amount of planting material used.

B. Roadway Design



Photo by Dan Burden

8. Bicycle Lanes

Bike lanes indicate a preferential or exclusive space for bicycle travel along an arterial street. Bike lanes have been found to provide more consistent separation between bicyclists and passing motorists. Marking bicycle lanes can also benefit pedestrians — as turning motorists slow and yield more to bicyclists, they will also be doing so for pedestrians.

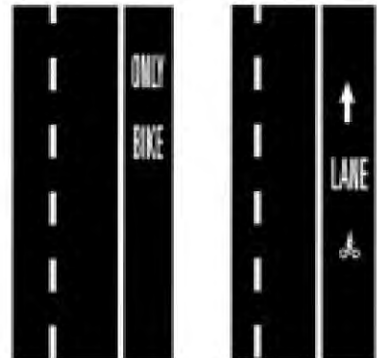
Bike lanes are typically designated by striping and/or signing, although colored pavement (e.g., blue or red bike lanes, though they are not an accepted MUTCD standard) has also been used in certain situations. As striping bike lanes reduces the space dedicated to motor vehicles, safety may be enhanced for pedestrians who wish to cross the street. Bicycle lanes also provide a buffer between motor vehicle traffic and pedestrians when sidewalks are immediately adjacent to the curb. On high-speed, high-volume roads, it may be more appropriate to provide a multi-use path to physically separate both bicyclists and pedestrians from motor vehicle traffic.



A well-marked bicycle lane and bicycle parking in Cambridge, Massachusetts.

Photo by Cara Seiderman

Typical Optional Word and Symbol Pavement Markings for Bicycle Lanes



Adapted from MUTCD

Purpose:

- Create on-street travel facilities for bicyclists.
- Narrow the roadway to encourage lower motor vehicle speeds.
- Provide additional separation between pedestrians and motor vehicles.
- Adding on-street bike lanes reduces the distance pedestrians must travel to cross automobile lanes.

Considerations:

- All roads should be evaluated for on-street bicycle facilities.
- Provide adequate space between the bike lane and parked cars so that open doors do not create a hazard for bicyclists.

Estimated Cost:

The cost of installing a bike lane is approximately \$3,100 to \$31,000 per kilometer (\$5,000 to \$50,000 per mile), depending on the condition of the pavement, the need to remove and repaint the lane lines, the need to adjust signalization, and other factors. It is most cost efficient to create bicycle lanes is during street reconstruction, street resurfacing, or at the time of original construction.

9. Roadway Narrowing

Roadway narrowing can be achieved in several different ways:

- Lane widths can be reduced (to 3.0 or 3.4 m [10 or 11 ft]) and excess asphalt striped with a bicycle lane or shoulder.
- Travel lanes can be removed (see #10).
- The street can be physically narrowed by extending sidewalks and landscaped areas, or by adding on-street parking within the former curb lines.

This can reduce vehicle speeds along a roadway section and enhance movement and safety for pedestrians. Bicycle travel will also be enhanced and bicyclist safety improved when bicycle lanes are added.



Before



After



Colored asphalt has been used to identify bike lanes on this street in Holland. The bike lanes visually narrow the street and help reduce speeds. Although the curb-to-curb width is more than 9.1 m (30 ft), the motorist only sees 3.4 m (11 ft) of driving space.

Purpose:

- Multiple benefits of lower vehicle speeds, increased safety, and redistributing space to other users.

Considerations:

- Bicyclists must be safely accommodated. Bike lanes or wide curb lanes are needed if motor vehicle volumes and/or speeds are high.
- Road narrowing must consider school bus and emergency service access, and truck volumes.
- Evaluate whether narrowing may encourage traffic to divert to other local streets in the neighborhood.

Estimated Cost:

Adding striped shoulders or on-street bike lanes can cost as little as \$620 per kilometer (\$1,000 per mile) if the old paint does not need to be changed. The cost for restriping a kilometer of street to bike lanes or reducing the number of lanes to add on-street parking is \$3,100 to \$6,200 (\$5,000 to \$10,000 per mile), depending on the number of old lane lines to be removed. Constructing a raised median or widening a sidewalk can cost \$62,000 or more per kilometer (\$100,000 or more per mile).

Sketches by Michael Kimelberg

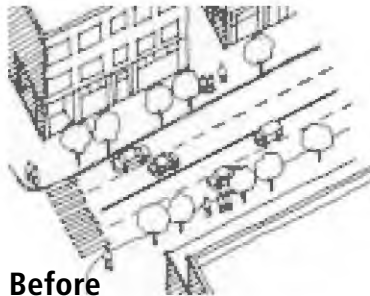
Photo by Dan Burden

10. Reducing Number of Lanes

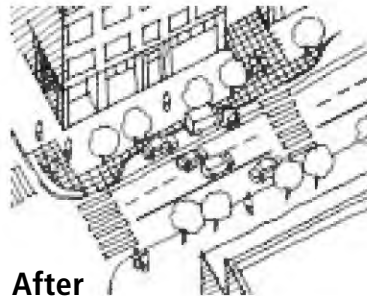
Some roads have more travel lanes than necessary and are difficult to cross because of their width. Reducing the number of lanes on a multi-lane roadway can reduce crossing distances for pedestrians and may slow vehicle speeds. A traffic analysis should be done to determine whether the number of lanes on a roadway (many of which were built without such an analysis) is appropriate. Level-of-service analysis for intersections should not dictate the design for the entire length of roadway. For example, a four-lane undivided road can be converted to one through lane in each direction, with a center left-turn lane or with a raised median, and turn pockets and bicycle lanes on both sides of the roadway. Turning pockets may be needed only at specific locations.

Depending on conditions, it may also be possible to add on-street parking while allowing for bicycle lanes on both sides of the street — instead of a center turn lane. If no sidewalks exist along the roadway, these should be added. If sidewalks exist, and there is adequate room, a landscaped buffer is desirable to separate pedestrians from the travel lane.

A typical three-lane configuration (two travel lanes and a center turn lane) also has advantages for motorists. Through traffic can maintain a fairly constant speed, while left-turning drivers can enter the center turn lane to wait.



Before



After



Photo by Cara Seiderman

This street in Cambridge, Massachusetts was reduced from four lanes to three. The conversion introduced wider sidewalks, additional space for landscaping, street furniture and cafes, and bicycle lanes.

Purpose:

- Remedy a situation where there is excess capacity.
- Provide space for pedestrians, bicyclists, and parked cars.
- Reduce crossing width and help optimize signal timing.
- Improve social interaction and neighborhood feel along the street.

Considerations:

- Roadway capacity operation and overall road safety need to be considered before reducing the number of lanes.
- Ensure street connections so major arterials can be crossed at controlled intersections.

Estimated Cost:

The cost for restriping a kilometer of four-lane street to one lane in each direction plus a two-way, left-turn lane and bike lanes is about \$3,100 to \$12,400 (\$5,000 to \$20,000 per mile), depending on the amount of lane lines that need to be repainted. The estimated cost of extending sidewalks or building a raised median is much higher and can cost \$62,000 per kilometer (\$100,000 per mile) or more.

If a reconfiguration is done after repaving or with an overlay, and curbs do not need to be changed, there is little or no cost for the change.

11. Driveway Improvements

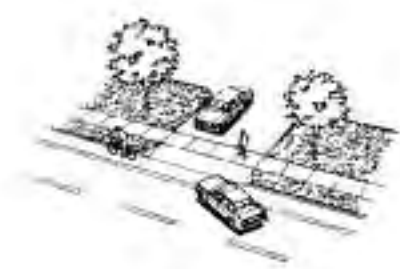
Several driveway designs may cause safety and access problems for pedestrians, including excessively wide and/or sloped driveways, driveways with large turning radii, multiple adjacent driveways, driveways that are not well defined, and driveways where motorist attention is focused on finding a gap in congested traffic. In addition, driveways without a level sidewalk landing may not comply with ADA standards.

Examples of driveway improvements include narrowing or closing driveways, tightening turning radii, converting driveways to right-in only or right-out only movements, and providing median dividers on wide driveways.

When driveways cross sidewalks, it is necessary to maintain a sidewalk level across the driveway of no more than 2 percent sideslope (see sketch). This is more usable for all pedestrians, especially those in wheelchairs and makes it clear to motorists that they must watch for pedestrians. It is important to minimize large signs and bushes at driveways to improve the visibility between motorists and pedestrians. The sidewalk material (usually concrete) should be maintained across the driveway as well.



The top example shows a driveway with a wide apron to accommodate two adjacent driveways and a landscaped planting strip. The driveway in the lower picture demonstrates how to provide driveway access across a sidewalk while maintaining a continuous, level walkway for pedestrians.



Pedestrian Facilities Guidebook,
Washington State, 1998

Purpose:

- Reduce pedestrian/motor vehicle conflicts.
- Improve access for people with disabilities.
- Improve visibility between cars and pedestrians at driveways.

Considerations:

- It is best to properly design and consolidate driveways at the outset. Local regulations can require appropriate design when driveways are created.

Estimated Cost:

No additional cost if part of original construction.

Photos by Peter Lagerwey

12. Raised Medians

Medians are raised barriers in the center portion of the street or roadway that can serve as a place of refuge for pedestrians who cross a street midblock or at an intersection location. They may provide space for trees and other landscaping that, in turn, can help change the character of a street and reduce speeds. They also have benefits for motorist safety when they replace center turn lanes. Desired turning movements need to be carefully provided so that motorists are not forced to travel on inappropriate routes, such as residential streets, or make unsafe U-turns.

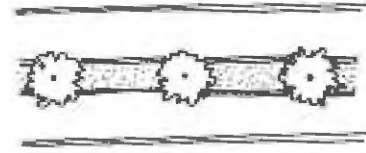
Continuous medians may not be the most appropriate treatment in every situation. In some cases, separating opposing traffic flow and eliminating left-turn friction can increase traffic speeds by decreasing the perceived friction of the roadway. They may also take up space that can be better used for wider sidewalks, bicycle lanes, landscaping buffer strips, or on-street parking and may cause problems for emergency vehicles. In some environments, medians can be constructed in sections, creating an intermittent rather than continuous median. Another good alternative device for two-, three- or four-lane roads is the crossing island, which provides a crossing refuge for pedestrians and, in some designs, aids in decreasing vehicle speeds.

Raised medians are most useful on high-volume, high-speed roads, and they should be designed to provide tactile cues for pedestrians with visual impairments to indicate the border between the pedestrian refuge area and the motorized vehicle roadway.



Photo by Dan Burden

This attractive median provides curb ramps and median openings for wheelchair users.



Adapted from *Making Streets That Work*, Seattle, 1996

Purpose:

- Manage motor vehicle traffic and provide comfortable left-hand turning pockets with fewer or narrower lanes.
- Provide a refuge for pedestrians crossing the street.
- Provide space for street trees and other landscaping.

Considerations:

- Ensure that there is enough room for wider sidewalks, bike lanes, and planting strips before proceeding with construction.
- Landscaping in medians should not obstruct the visibility between pedestrians and approaching motorists.
- Median crossings at midblock and intersection locations must be fully accessible by means of ramps or cut-throughs, with detectable warnings.

Estimated Cost:

The cost for adding a raised median is approximately \$15,000 to \$30,000 per 30 m (\$15,000 to \$30,000 per 100 ft), depending on the design, site conditions, and whether the median can be added as part of a utility improvement or other street construction project.

13. One-Way / Two-Way Street Conversions

One-way streets can simplify crossings for pedestrians, who must look for traffic in only one direction. While studies have shown that conversion of two-way streets to one-way generally reduces pedestrian crashes, one-way streets tend to have higher speeds, which creates new problems. If a street is converted to one-way, it should be evaluated to see if additional changes should be made, especially if the street or lanes are overly wide. Also, traffic circulation in the surrounding area must be carefully considered before conversion to one-way streets.

As a system, one-way streets can increase travel distances of motorists and bicyclists and can create confusion, especially for non-local residents. One-way streets operate best in pairs, separated by no more than 0.4 km (0.25 mi). Conversion costs can be quite high to build cross-overs where the one-way streets convert back to two-way streets, and to rebuild traffic signals and revise striping, signing, and parking meters.

One-way streets work best in downtown or very heavily congested areas. One-way streets can offer improved signal timing and accommodate odd-spaced signals; however, signal timing for arterials that cross a one-way street pair is difficult.

Conversions can go the other way as well: some places are returning one-way streets back to two-way to allow better local access to businesses and homes and to slow traffic. Two-way streets tend to be slower due to “friction,” especially on residential streets without a marked center line and they may also eliminate the potential for multiple-threat crashes that exists on multi-lane, one-way streets.



Photo by Cara Seiderman

Cars are forced to drive slowly on this two-way street with parking.

Purpose:

- Manage traffic patterns.
- Reduce conflicts.
- A one-way to two-way conversion will generally reduce speeds.

Considerations:

- Consider impacts on other streets.
- Be aware that one-way streets may decrease automobile accessibility to businesses.
- Be careful not to create speeding problems where a two-way street is changed to a one-way street. Redesign or traffic-calming measures may be required to address this.
- Will improve signal synchronization on the one-way streets, but will hinder synchronization on cross-streets.
- Generally requires a one-way pair, with two nearby streets being converted to one-way.

Estimated Cost:

\$12,400 to \$124,000 per kilometer (\$20,000 to \$200,000 per mile), depending on length of treatment and whether the conversion requires modification to signals. If crossovers are needed at the end points of the one-way streets, they may cost millions of dollars.

14. Curb Radius Reduction

One of the common pedestrian crash types involves a pedestrian who is struck by a right-turning vehicle at an intersection. A wide curb radius typically results in high-speed turning movements by motorists. Reconstructing the turning radius to a tighter turn will reduce turning speeds, shorten the crossing distance for pedestrians, and also improve sight distance between pedestrians and motorists.

Nearby land uses and types of road users should be considered when designing an intersection so that curb radii are sized appropriately. If a curb radius is made too small, large trucks or buses may ride over the curb, placing pedestrians in danger.

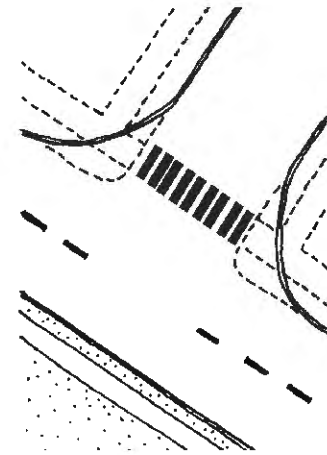
Where there is a parking and/or bicycle lane, curb radii can be even tighter, because the vehicles will have more room to negotiate the turn. Curb radii can, in fact, be tighter than any modern guide would allow: older cities in the Northeast and in Europe frequently have radii of 0.6 to 1.5 m (2 to 5 ft) without suffering any detrimental effects.

More typically, in new construction, the appropriate turning radius is about 4.6 m (15 ft) and about 7.6 m (25 ft) for arterial streets with a substantial volume of turning buses and/or trucks. Tighter turning radii are particularly important where streets intersect at a skew. While the corner characterized by an acute angle may require a slightly larger radius to accommodate the turn moves, the corner with an obtuse angle should be kept very tight, to prevent high-speed turns.



Photo by Peter Lagerwey

Tight corner radii keep turning vehicle speeds down and minimize crossing distances for pedestrians. This demonstration project uses inexpensive curbing to reduce the curb radius.



Making Streets That Work, Seattle, 1996

Purpose:

- Safer intersection design.
- Slow right-turning vehicles.
- Reduce crossing distances, improve visibility between drivers and pedestrians, and provide space for accessible curb ramps.
- Shorter crossing distances can lead to improved signal timing.

Considerations:

- Consider effective radii by taking into account parking and bicycle lanes.
- Make sure that public maintenance vehicles, school buses, and emergency vehicles are accommodated.
- Smaller radii reduce overall crossing distance and reduce time needed for the pedestrian phase.

Estimated Cost:

Construction costs for reconstructing a tighter turning radii are approximately \$2,000 to \$20,000 per corner, depending on site conditions (e.g., drainage and utilities may need to be relocated).

15. Improved Right-Turn Slip-Lane Design

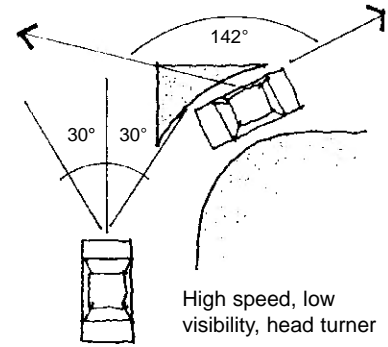
Intersections should be designed to accommodate safe pedestrian crossings using tight curb radii, shorter crossing distances, and other tools as described in this document. While right-turn slip lanes are generally a negative facility from the pedestrian perspective due to the emphasis on easy and fast motor vehicle travel, they can be designed to be less problematic. At many arterial street intersections, pedestrians have difficulty crossing due to right-turn movements and wide crossing distances. Well-designed right-turn slip lanes provide pedestrian crossing islands within the intersection and a right-turn lane that is designed to optimize the right-turning motorist's view of the pedestrian and of vehicles to their left. Pedestrians are able to cross the right-turn lane and wait on the refuge island for their walk signal.

The problem for pedestrians is that many slip lanes are designed for unimpeded vehicular movement. The design of corner islands, lane width, and curb radii of right-turn slip lanes should discourage high-speed turns, while accommodating large trucks and buses. The triangular "porkchop" corner island that results should have the "tail" pointing to approaching traffic. Since the traffic signal is timed based on a shorter crossing, the pedestrian crossing time has a much smaller influence on the timing of the signal. This design has an additional advantage for the pedestrian; the crosswalk is located in an area where the driver is still looking ahead. Older designs place the crosswalk too far down, where the driver is already looking left for a break in the traffic.

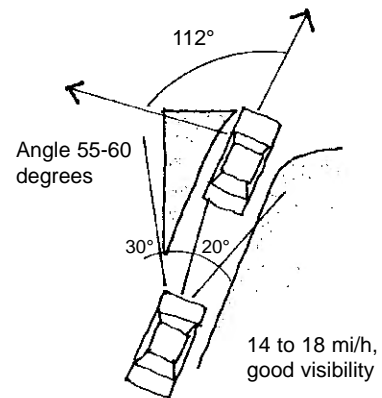


Photo by Dan Burden

A slip lane designed at the proper angle, as shown on the right side of intersection, provides the driver with greater visibility of pedestrians. The lane on the left creates a higher speed, lower visibility right turn.



Current AASHTO Standard



Recommended Design

1 mi/h = 1.61 km/h

Sketches by Michael Kimelberg

Purpose:

- Separate right-turning traffic.
- Slow turning-vehicle speeds and improve safety.
- Allow drivers to see approaching cross-street traffic more clearly.
- Reduce the crossing distance for pedestrians.

Considerations:

- Evaluate first whether a slip lane is really necessary.

Estimated Cost:

Approximately \$50,000 to \$200,000 to reconfigure roadway, add striping and constructing an island, assuming additional right-of-way is not required.

C. Intersection Design



Photo by Dan Burden

16. Roundabouts

A modern roundabout is built with a large, often circular, raised island located at the intersection of an arterial street with one or more crossing roadways and may take the place of a traffic signal. Traffic maneuvers around the circle in a counterclockwise direction, and then turns right onto the desired street. All traffic yields to motorists in the roundabout and left-turn movements are eliminated. Unlike a signalized intersection, vehicles generally flow and merge through the roundabout from each approaching street without having to stop.

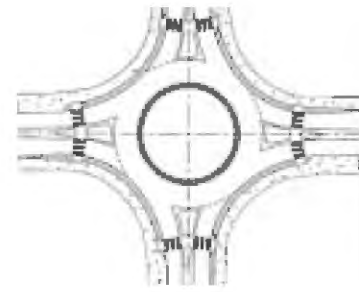
Roundabouts need to accommodate pedestrians and bicyclists. It is important that automobile traffic yields to pedestrians crossing the roundabout. Splitter islands at the approaches slow vehicles and allow pedestrians to cross one traffic lane at a time. Single-lane approaches can be designed to keep speeds down to safer levels and allow pedestrians to cross. Multi-lane approaches have higher speeds, create multiple threats for pedestrians, and are not recommended.

Pedestrians may need to travel out of their way to cross the intersection, but generally have a shorter wait than with a signal and have only one direction of approaching traffic to watch for. Wayfinding and gap-selection cues need to be adequately addressed in the design of roundabouts so that roundabouts are not a barrier to pedestrians with vision impairments. Accessible pedestrian signals and truncated domes placed at splitter islands are two possible solutions.

Bicyclists are also disadvantaged by roundabout design. Unless the road is narrow (one lane in each direction), speeds are slow, and traffic very light, bicyclists may not be able to share the road comfortably. Marking bicycle lanes through the roundabout has not been shown to be safer. In larger roundabouts, an off-road bicycle path may be necessary to allow cyclists to use the pedestrian route. This is inconvenient and takes longer but it will improve safety.



This Fort Pierce, Florida, roundabout is being constructed to reduce speeding, improve safety, and enhance the aesthetics of the community.



Sketch by Michael Kimelberg

Purpose:

- Provide good traffic management where the intersection is large, complex, and/or has more than four approach legs.
- Replace a traffic signal that is experiencing heavy traffic backup and congestion.
- Reduce speeds at intersection.
- Create a gateway into an area.

Considerations:

- Street widths and/or available right-of-way need to be sufficient to accommodate a properly designed roundabout.
- Roundabouts have a mixed record regarding pedestrian and bicyclist safety — a low design speed is required.
- Roundabouts are generally not appropriate for the intersections of multi-lane roads.
- Roundabouts often work best where there is a high percentage of left-turning traffic.
- Deflection on each leg of the intersection must be set to control speeds to 24-29 km/h (15-18 mi/h).

Estimated Cost:

The cost for a landscaped roundabout varies widely and can range from \$45,000 to \$150,000 for neighborhood intersections and up to \$250,000 for arterial street intersections, not including additional right-of-way acquisition. Yet, roundabouts have lower ongoing maintenance costs than traffic signals.

Photo by Dan Burden

17. Modified T-Intersections

This design treatment is intended for certain T-intersections on lower-volume streets in residential areas where there is a need to reduce the speeds of through traffic. It involves a gradual curb extension or bulb at the top of the T, such that vehicles are deflected slightly as they pass straight through the intersection (see diagram). This type of design can help to discourage cut-through traffic in a neighborhood and can reduce speeds at the intersection. If not properly designed, it can create confusion regarding priority of movement. Consider a mini-circle before installing this treatment.

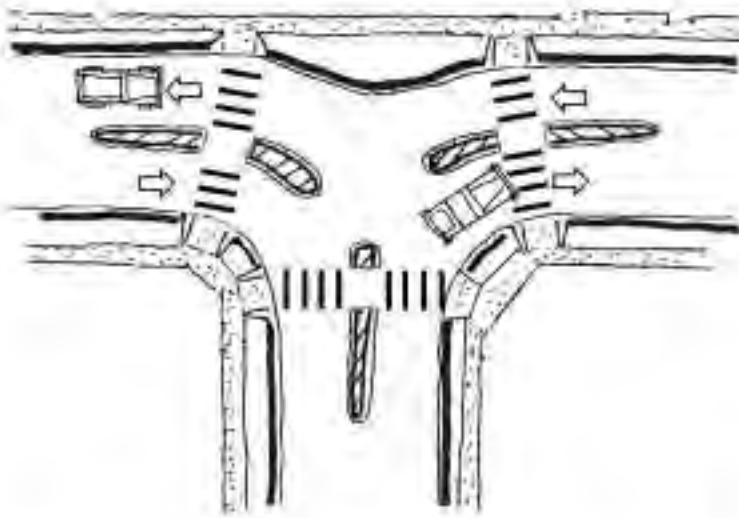


Photo by Dan Burden

This modified T-intersection in Portland, Oregon, is intended to reduce speeds of through traffic as well as restrict left-turning vehicles.

Purpose:

- Reduce vehicle speeds through a T-intersection on a low-volume street.

Considerations:

- Used when vehicle volumes are low to moderate.
- A mini-traffic circle may accomplish the same objective and may be less costly and confusing.
- If designed to eliminate some turning movements, the affected neighborhood residents should be consulted for input and an analysis of traffic patterns done to ensure that through traffic would not be diverted inappropriately.
- Pedestrian access must be accommodated through the island.

Estimated Cost:

\$20,000 to \$60,000, depending on the design and whether drainage and utilities need to be relocated.

18. Intersection Median Barriers

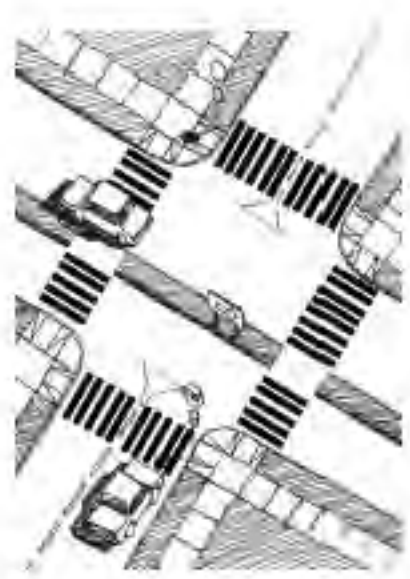
This shortened version of a raised curb median extends through the intersection to prevent cross-street through movements and left turning movements to cross-streets from the main street.

This treatment can benefit pedestrians who need to cross any leg of the intersection, but restricts vehicle entry into and out of neighborhoods and can therefore greatly reduce cut-through traffic. However, since this treatment can dramatically influence traffic patterns and have potentially negative consequences caused by shifting traffic, it should be used cautiously. Crossing islands can provide benefits to pedestrians if that is the desire. This is also a traffic management technique.

Cut-throughs must be incorporated into the design for pedestrian and bicyclist use.



Intersection median barriers need to keep walking and bicycling flowing freely through the neighborhood.



Purpose:

- Reduce cut-through traffic on a neighborhood street.

Considerations:

- Local residents need to be provided access so they do not have to drive excessive distances to their homes.
- An analysis of traffic patterns should be done to ensure that cut-through traffic would not be diverted to a nearby street.
- Design should ensure safe and convenient bicycle and pedestrian access.
- Ensure that emergency access is not negatively impacted. Some designs (e.g., high mountable curbs) may allow fire truck access, while inhibiting cars.

Estimated Cost:

\$10,000 to \$20,000

D. Traffic Calming



Photo by Dan Burden



Photo by Dan Burden



Photo by Cara Seiderman

Traffic calming is a way to design streets, using physical measures, to encourage people to drive more slowly. It creates physical and visual cues that induce drivers to travel at slower speeds. Traffic calming is self-enforcing. The design of the roadway results in the desired effect, without relying on compliance with traffic control devices such as signals, signs, and without enforcement. While elements such as landscaping and lighting do not force a change in driver behavior, they can provide the visual cues that encourage people to drive more slowly.

The reason traffic calming is such a powerful and compelling tool is that it has proven to be so effective. Some of the effects of traffic calming, such as fewer and less severe crashes, are clearly measurable. Others, such as supporting community livability, are less tangible, but equally important.

Experience throughout Europe, Australia, and North America has shown that traffic calming, if done correctly, reduces traffic speeds, the number and severity of crashes, and noise level. Research on traffic-calming projects in the United States supports their effectiveness at decreasing automobile speeds, reducing the numbers of crashes, and reducing noise levels for specific contexts. Looking at a sample of various speed studies shows that typical speed reductions of 5 to 15 percent at the 85th percentile speed can be realized by the use of traffic-calming measures — including speed tables, mini-circles, speed humps, and other standard traffic-calming devices.⁽¹⁾ Use of several of the traffic-calming measures have also resulted in substantial reductions in motor vehicle crashes. For example, the implementation of traffic mini-circles in Seattle has resulted in a reduction of approximately 80 percent of intersection accidents.⁽¹⁾

The Institute of Transportation Engineers has arrived at the following definition of “traffic calming,” which is often used in the United States:

“Traffic calming” is the combination of mainly physical measures that reduce the negative effects of motor vehicle use, alter driver behavior, and improve conditions for non-motorized street users.

There are certain overall considerations that are applicable to both traffic management and traffic calming:

- Vehicle speed is more critical than volume in terms of safety and should be addressed first where there are monetary constraints.
- Neighborhood involvement is important to successful implementation. Rationale for traffic-calming and management measures should be explained clearly to community residents and installation of these treatments should incorporate public input. Please see Chapter 5: Implementation and Resources for a discussion of public process.
- Traffic-calming and management measures should fit into, and preferably enhance, the street environment.
- Traffic-calming designs should be predictable and easy to understand by drivers and other users.



Photo by Peter Lagerwey

This midblock crossing is in Kalamazoo, Michigan. The landscaping and textured crosswalk are visually appealing and provide a clear message about where pedestrians can be expected to cross the street.

- Devices that meet multiple goals are usually more acceptable. For example, a raised crosswalk may be more understandable to motorists than a speed hump. The former has a clear goal, whereas the latter may be perceived as a nuisance.
- Treatments need to be well designed and based on current available information on their applications and effects. Information on U.S. experiences with various traffic-calming measures can be found in ITE's *Traffic Calming: State of the Practice*.⁽¹⁾
- Devices should accommodate emergency vehicles.
- Traffic-calming areas or facilities should be adequately signed, marked, and lit to be visible to motorists.
- Treatments need to be spaced appropriately to have the desired effect on speed — too far apart and they will have a limited effect, too close and they will be an unnecessary cost and annoyance. Devices usually need to be spaced about 91 to 152 m (300 to 500 ft) apart. If they are spaced too far apart, motorists may speed up between them. This is particularly the case where the devices are added onto the street (e.g., speed humps). Whole street designs are usually able to create an environment that supports slower speeds for the entire length.
- Facilities should not be underdesigned or they will not work. Keeping the slopes too gradual for a speed table or curves too gentle for a chicane will not solve the problem and will appear as a waste of money and may ruin chances for future projects.
- Traffic-calming measures should accommodate bicyclists and pedestrians with disabilities.
- If a measure is likely to divert traffic onto another local street, the areawide street system should be considered so as not to shift the problem from one place to another.
- Devices should be thought of as elements of a traffic-calming system and be placed to improve pedestrian conditions throughout an area.

Traffic-calming tools may be used in combination and are often most effective this way. The tools in this guide are organized into the following categories:

- Roadway narrowing.
- Lateral or horizontal shifts in the roadway.
- Raised devices (vertical devices).
- Complementary tools (landscaping and paving).
- Whole-street designs.

Some tools fall into multiple categories; however, for simplicity, they are listed only once.



Photo by Dan Burden

Traffic-calming improvements need to include input from and coordination with neighborhoods that are impacted.

Trials and Temporary Installations for Traffic Calming

In communities trying traffic calming for the first time, it may be useful to lay out a new design with cones or temporary markings to test it. This provides emergency vehicle drivers, residents, and others with an opportunity to test the design to ensure that they are comfortable with it. Some communities have constructed elaborate temporary devices with concrete or plastic ("jersey") barriers. These can instill a negative reaction in the community due to their unaesthetic appearance and they do not generally have any significant benefits over the simpler test devices. Another option is to install more aesthetic test devices, such as painted flexible curbs that are bolted into the pavement and can easily be adjusted or removed.

19. Curb Extensions

Curb extensions — also known as bulb-outs or neckdowns — extend the sidewalk or curb line out into the parking lane, which reduces the effective street width. Curb extensions significantly improve pedestrian crossings by reducing the pedestrian crossing distance, visually and physically narrowing the roadway, improving the ability of pedestrians and motorists to see each other, and reducing the time that pedestrians are in the street.

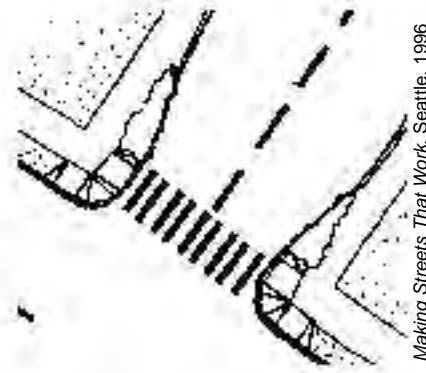
Curb extensions placed at an intersection essentially prevent motorists from parking in or too close to a crosswalk or from blocking a curb ramp or crosswalk. Motor vehicles parked too close to corners present a threat to pedestrian safety, since they block sightlines, obscure visibility of pedestrians and other vehicles, and make turning particularly difficult for emergency vehicles and trucks. Motorists are encouraged to travel more slowly at intersections or midblock locations with curb extensions, as the restricted street width sends a visual cue to motorists. Turning speeds at intersections can be reduced with curb extensions (curb radii should be as tight as is practicable). Curb extensions also provide additional space for curb ramps and for level sidewalks where existing space is limited.

Curb extensions are only appropriate where there is an on-street parking lane. Curb extensions must not extend into travel lanes, bicycle lanes, or shoulders (curb extensions should not extend more than 1.8 m (6 ft) from the curb). The turning needs of larger vehicles, such as school buses, need to be considered in curb extension design.



Photo by Dan Burden

This curb extension in Venice, Florida, reduced motorist turning speeds by 9.7 to 12.9 km/h (6 to 8 mi/h). Pedestrian crossing distance and time exposed to traffic was also reduced.



Making Streets That Work, Seattle, 1996

Purpose:

- Improve safety for pedestrians and motorists at intersections.
- Increase visibility and reduce speed of turning vehicles.
- Encourage pedestrians to cross at designated locations.
- Prevent motor vehicles from parking at corners.
- Shorten crossing distance and reduce pedestrian exposure.

Considerations:

- Curb extensions can provide adequate space on narrow sidewalks for curb ramps and landings.
- Curb extensions should only be used where there is a parking lane, and where transit and bicyclists would be traveling outside the curb edge for the length of the street.
- Midblock extensions provide an opportunity to enhance midblock crossings. Care should be taken to ensure that street furniture and landscaping do not block motorists' views of pedestrians.
- Where intersections are used by significant numbers of trucks or buses, the curb extensions need to be designed to accommodate them. However, it is important to take into consideration that those vehicles should not be going

19. Curb Extensions (continued)



Photo by Peter Lagerwey

A curb extension on an arterial street in Seattle, Washington. The crossing distance for pedestrians is substantially reduced by the installation of this device. The extension is limited to 1.8 m (6 ft) to allow bicyclists to pass safely.



Photo by Peter Lagerwey

A curb extension on a residential street in Seattle, Washington. In addition to improving pedestrian safety at this intersection, the extension provides additional sidewalk space for a bicycle rack and accessible curb ramp.

at high speeds, and most can make a tight turn at slow speeds.

- It is not necessary for a roadway to be designed so that a vehicle can turn from a curb lane to a curb lane. Vehicles can often encroach into adjacent lanes safely where volumes are low and/or speeds are slow. Speeds should be slower in a pedestrian environment.
- Emergency access is often improved through the use of curb extensions if intersections are kept clear of parked cars. Fire engines and other emergency vehicles can climb a curb where they would not be able to move a parked car. At midblock locations, curb extensions can keep fire hydrants clear of parked cars and make them more accessible.
- Curb extensions can create additional space for curb ramps, landscaping, and street furniture that are sensitive to motorist and pedestrian sightlines; this is especially beneficial where sidewalks are otherwise too narrow.
- Ensure that curb extension design facilitates adequate drainage.

Estimated Cost:

Curb extensions cost from \$2,000 to \$20,000 per corner, depending on design and site conditions. Drainage is usually the most significant determinant of cost. If the curb extension area is large and special pavement and street furnishings and planting are included, costs would also be higher. Costs can go up significantly if something major, such as a utility pole or controller box, is moved.

20. Chokers

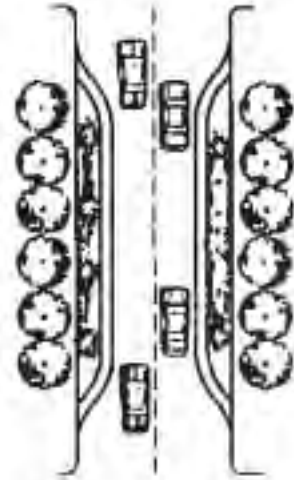
Chokers are curb extensions that narrow a street by widening the sidewalks or planting strips, effectively creating a pinch point along the street. Chokers can be created by bringing both curbs in, or they can be done by more dramatically widening one side at a midblock location. They can also be used at intersections, creating a gateway effect when entering a street.

Chokers can have a dramatic effect by reducing a two-lane street to one lane at the choker point (or two narrow lanes), requiring motorists to yield to each other or slow down. In order for this to function effectively, the width of the travelway cannot be wide enough for two cars to pass: 4.9 m (16 ft) is generally effective (and will allow emergency vehicles to pass unimpeded). This kind of design is usually only appropriate for low-volume, low-speed streets.



Photo by Dan Burden

This choker on a two-way roadway in Seattle, Washington, narrows the street from two lanes to one. Traffic is forced to slow down and, in some cases, wait for an approaching vehicle to pass before proceeding.



Adapted from *Making Streets That Work*, Seattle, 1996

Purpose:

- Slow vehicles at a mid-point along the street.
- Create a clear transition between a commercial and a residential area.
- Narrow overly wide intersections and midblock areas of streets.
- Add room along the sidewalk or planting strip for landscaping or street furniture.

Considerations:

- If two travel lanes are maintained on a two-way street and/or the travel-lane widths are unchanged (at the location of the choker), it will have a minimal effect on speed.
- Consult with local fire and sanitation departments before setting minimum width.
- Ensure that bicyclist safety and mobility are not diminished.

Estimated Cost:

\$5,000 to \$20,000, depending on site conditions and landscaping. Drainage may represent a significant cost.

21. Crossing Islands

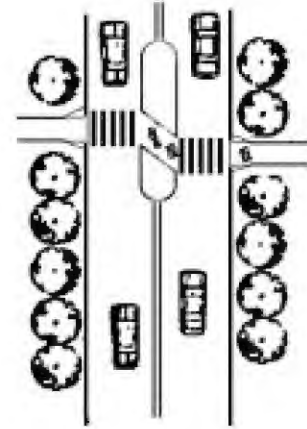
Crossing islands — also known as center islands, refuge islands, pedestrian islands, or median slow points — are raised islands placed in the center of the street at intersections or midblock to help protect crossing pedestrians from motor vehicles. Center crossing islands allow pedestrians to deal with only one direction of traffic at a time, and they enable them to stop partway across the street and wait for an adequate gap in traffic before crossing the second half of the street. Where midblock or intersection crosswalks are installed at uncontrolled locations (i.e., where no traffic signals or stop signs exist), crossing islands should be considered as a supplement to the crosswalk. They are also appropriate at signalized crossings. If there is enough width, center crossing islands and curb extensions can be used together to create a highly improved pedestrian crossing. Detectable warnings are needed at cut-throughs to identify the pedestrian refuge area.

This kind of facility has been demonstrated to significantly decrease the percentage of pedestrian crashes.⁽²⁾ The factors contributing to pedestrian safety include reduced conflicts, reduced vehicle speeds approaching the island (the approach can be designed to force a greater slowing of cars, depending on how dramatic the curvature is), greater attention called to the existence of a pedestrian crossing, opportunities for additional signage in the middle of the road, and reduced exposure time for pedestrians.

Curb extensions may be built in conjunction with center crossing islands where there is on-street parking. Care should be taken to maintain bicycle access. Bicycle lanes (or shoulders, or whatever space is being used for bicycle travel) must not be eliminated or squeezed in order to create the curb extensions or islands.



Crossing islands allow pedestrians to be concerned with one direction of traffic at a time. The roadway markings in the design shown here also help make motorists aware that a pedestrian may be crossing.



Adapted from *Making Streets That Work*,
Seattle, 1996

Purpose:

- Enhance pedestrian crossings, particularly at unsignalized crossing points.
- Reduce vehicle speeds approaching pedestrian crossings.
- Highlight pedestrian crossings.

Considerations:

- Do not squeeze bicycle access.
- Illuminate or highlight islands with street lights, signs, and/or reflectors to ensure that motorists see them.
- Design islands to accommodate pedestrians in wheelchairs. A cut-through design such as depicted in the diagram works best if the pedestrian refuge area is identified by detectable warnings.
- Crossing islands at intersections or near driveways may affect left-turn access.

Estimated Cost:

Costs range from \$4,000 to \$30,000. The cost for an asphalt island or one without landscaping is less than the cost of installing a raised concrete pedestrian island with landscaping.

Photo by Dan Burden

22. Chicanes

Chicanes create a horizontal diversion of traffic and can be gentler or more restrictive depending on the design.

Diverting the Path of Travel. Shifting a travel lane has an effect on speeds as long as the taper is not so gradual that motorists can maintain speeds. For traffic calming, the taper lengths may be as much as half of what is suggested in traditional highway engineering.

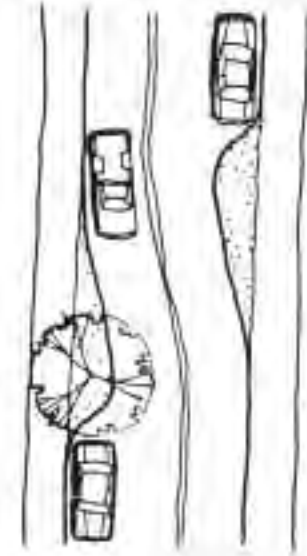
Shifts in travelways can be created by shifting parking from one side to the other (if there is only space for one side of parking) or by building landscaped islands (islands can also effectively supplement the parking shift).

Diversion Plus Restriction (Angled Slow Points). Diverting the path of travel plus restricting the lanes (as described under "Chokers") usually consists of a series of curb extensions, narrowing the street to two narrow lanes or one lane at selected points and forcing motorists to slow down to maneuver between them. Such treatments are intended for use only on residential streets with low traffic volumes.

If there is no restriction (i.e., the number of lanes is maintained), chicanes can be created on streets with higher volumes, such as collectors or minor arterials.



The chicanes pictured above narrow this residential street to one lane and require traffic to move slowly.



City of Cambridge, MA

Purpose:

- Reduce vehicle speeds.
- Add more green (landscaping) to a street.

Considerations:

- Chicanes may reduce on-street parking.
- Maintain good visibility by planting only low shrubs or trees with high canopies.
- Ensure that bicyclist safety and mobility are not diminished.

Estimated Cost:

Costs for landscaped chicanes are approximately \$10,000 (for a set of three chicanes) on an asphalt street and \$15,000 to \$30,000 on a concrete street. Drainage and utility relocation often represents the most significant cost consideration.

23. Mini-Circles

Mini-circles are raised circular islands constructed in the center of residential street intersections (generally not intended for use where one or both streets are arterial streets). They reduce vehicle speeds by forcing motorists to maneuver around them. Mini-circles have been found to reduce motor vehicle crashes by an average of 90 percent in Seattle, WA.⁽³⁾ Drivers making left turns are directed to go on the far side of the circle (see diagram at right) prior to making the turn. Signs should be installed directing motorists to proceed around the right side of the circle before passing through or making a left turn. Mini-circles are commonly landscaped (bushes, flowers, or grass), most often at locations where the neighborhood has agreed to maintain the plants. In locations where landscaping is not feasible, traffic circles can be enhanced through specific pavement materials.

Mini-circles are an intersection improvement as well as a traffic-calming device and can take the place of a signal or four-way stop sign. Many unwarranted four-way stop signs are installed because of the demand for action by the community.

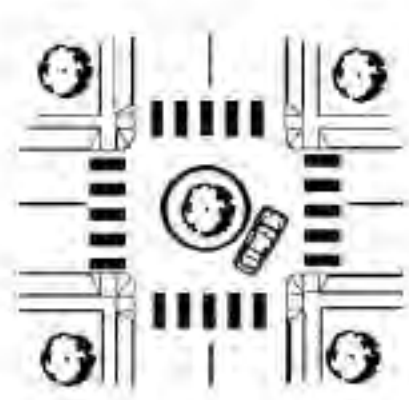
Mini-circles must be properly designed to slow vehicles and benefit pedestrians and bicyclists. Right-turning vehicles are not controlled at an intersection with a mini-circle, potentially putting pedestrians and bicyclists at risk. Therefore, short curb radii should complement this treatment to discourage fast right-turn maneuvers. Traffic circles with cuts in splitter islands make crossing easier for pedestrians, especially wheelchair users, and control vehicle movements entering the intersection, but require more space. Pedestrians with vision impairments will find fewer cues to identify a gap to cross when traffic does not stop.

The occasional larger vehicle going through an intersection with a traffic circle (e.g., a fire truck or moving van) can be accommodated by creating a mountable curb in the outer portion of the circle.



Photo by Dan Burden

A traffic mini-circle helps reduce vehicle speeds, but still allows cars and emergency vehicles to pass through the intersection with little difficulty.



Adapted from *Making Streets That Work*, Seattle, 1996

Purpose:

- Manage traffic at intersections where volumes do not warrant a stop sign or a signal.
- Reduce crash problems at the intersection of two local streets.
- Reduce vehicle speeds at the intersection.

Considerations:

- Do not make generous allowances for motor vehicles by increasing the turning radii — this compromises pedestrian and bicyclist safety.
- Larger vehicles that need access to streets (e.g., school buses and fire engines) may need to make lefthand turns in front of the circle.
- Use yield, not stop, controls.
- Mini-circle landscaping should not impede the sight distance.
- Treat a series of intersections along a local street as part of a neighborhood traffic improvement program.

Estimated Cost:

The cost is approximately \$6,000 for a landscaped traffic mini-circle on an asphalt street and about \$8,000 to \$12,000 for a landscaped mini-circle on a concrete street.

Raised Devices

24. Speed Humps

25. Speed Tables

Speed humps are paved (usually asphalt) and approximately 76 to 102 mm (3 to 4 in) high at their center, and extend the full width of the street with height tapering near the drain gutter to allow unimpeded bicycle travel. Speed humps should not be confused with the speed "bump" that is often found in mall parking lots. There are several designs for speed humps. The traditional 3.7-m (12-ft) hump has a design speed of 24 to 32 km/h (15 to 20 mi/h), a 4.3-m (14-ft) hump a few miles per hour higher, and a 6.7-m (22-ft) table has a design speed of 40 to 48 km/h (25 to 30 mi/h). The longer humps are much gentler for larger vehicles.

A "speed table" is a term used to describe a very long and broad speed hump, or a flat-topped speed hump, where sometimes a pedestrian crossing is provided in the flat portion of the speed table. The speed table can either be parabolic, making it more like a speed hump, or trapezoidal, which is used more frequently in Europe. Speed tables can be used in combination with curb extensions where parking exists.



Speed humps are frequently used on some residential streets to reduce speeds. However, they can create unwanted noise if they are too severe, or cause motorists to slow down more than is necessary.

Purpose:

- Reduce vehicle speeds. Raised measures tend to have the most predictable speed reduction impacts.
- Enhance the pedestrian environment at pedestrian crossings.

Considerations:

- Do not use if on a sharp curve or if the street is on a steep grade.
- If the street is a bus route or primary emergency route, the design must be coordinated with operators. Usually, some devices are acceptable if used prudently — one device may be appropriate and may serve the primary need (e.g., if there is a particular location along a street that is most in need of slowing traffic and improving pedestrian conditions).
- The aesthetics of speed humps and speed tables can be improved through the use of color and specialized paving materials.
- Noise may increase, particularly if trucks use the route regularly.
- May create drainage problems on some streets.
- Speed humps and tables should be properly designed to reduce the chance of back problems or other physical discomfort experienced by vehicle occupants.

Estimated Cost:

The cost for each speed hump is approximately \$1,000. Speed tables are \$2,000 to \$15,000, depending on drainage conditions and materials used.

26. Raised Intersections

25. Raised Pedestrian Crossings

A raised intersection is essentially a speed table (see photograph below) for the entire intersection. Construction involves providing ramps on each vehicle approach, which elevates the entire intersection to the level of the sidewalk. They can be built with a variety of materials, including asphalt, concrete, stamped concrete, or pavers. The crosswalks on each approach are also elevated as part of the treatment to enable pedestrians to cross the road at the same level as the sidewalk, eliminating the need for curb ramps. Use detectable warnings to mark the boundary between the sidewalk and the street.

A raised pedestrian crossing is also essentially a speed table, with a flat portion the width of a crosswalk, usually 3.0 to 4.6 m (10 to 15 ft). Raised intersections and crosswalks encourage motorists to yield. On one street in Cambridge, MA, motorists yielding to pedestrians crossing at the raised devices went from approximately 10 percent before installation of the project to 55 percent after installation.⁽⁴⁾



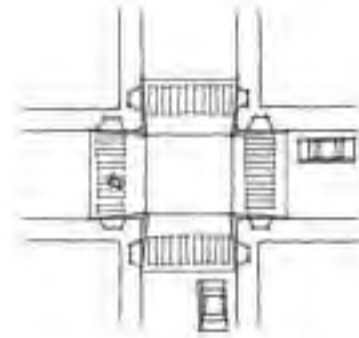
Photo by Cara Seiderman

A raised intersection slows all vehicular movements through the intersection and improves pedestrian crossings in all directions.



Photo by Cara Seiderman

A raised pedestrian crossing provides a continuous route for the pedestrian at the same level as the sidewalk. Pavement markings on the slope (inlay type) make the crossing visible to motorists.



Sketch by Michael Kimelberg

Purpose:

- Reduce vehicle speeds.
- Enhance the pedestrian environment at the crossings.

Considerations:

- Don't use if on a sharp curve or if the street is on a steep grade.
- May not be appropriate if the street is a bus route or emergency route. One device may be necessary and serve the primary need. Several raised devices may be disruptive, so other measures should be considered.
- Speed tables and raised crosswalks and intersections can be an urban design element through the use of special paving materials.
- Detectable warning strips at edges enable pedestrians with vision impairments to detect the crossing.
- Care must be taken to manage drainage.

Estimated Cost:

Raised crosswalks are approximately \$2,000 to \$15,000, depending on drainage conditions and material used. The cost of a raised intersection is highly dependent on the size of the roads. They can cost from \$25,000 to \$75,000.

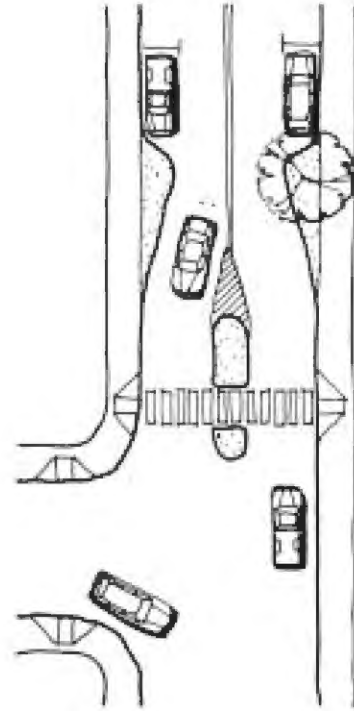
28. Gateways

A gateway is a physical or geometric landmark that indicates a change in environment from a higher speed arterial or collector road to a lower speed residential or commercial district. They often place a higher emphasis on aesthetics and are frequently used to identify neighborhood and commercial areas within a larger urban setting. Gateways may be a combination of street narrowing, medians, signing, archways, roundabouts, or other identifiable feature. Gateways should send a clear message to motorists that they have reached a specific place and must reduce speeds. This can help achieve the goal of meeting expectations and preparing motorists for a different driving environment. Gateways are only an introduction and slower speeds are not likely to be maintained unless the entire area has been redesigned or other traffic-calming features are used.



Photo by Dan Burden

The combination of landscaping and a short median create a gateway to this neighborhood.



City of Cambridge, MA

Purpose:

- Create an expectation for motorists to drive more slowly and watch for pedestrians when entering a commercial, business, or residential district from a higher speed roadway.
- Create a unique image for an area.

Considerations:

- Traffic-slowing effects will depend upon the device chosen and the overall traffic-calming plan for the area.

Estimated Cost:

Varies widely depending on the measures chosen.

29. Landscaping

The careful use of landscaping along a street can provide separation between motorists and pedestrians, reduce the visual width of the roadway (which can help to reduce vehicle speeds), and provide a more pleasant street environment for all. This can include a variety of trees, bushes, and/or flowerpots, which can be planted in the buffer area between the sidewalk or walkway and the street.

The most significant issue with any landscaping scheme is ongoing maintenance. Some communities have managed effectively by creating homeowners associations to pay for landscape maintenance or through the volunteer efforts of neighbors. Others have found them to be unreliable and budget for public maintenance instead. Consider adding irrigation systems in areas with extensive planting.

Choosing appropriate plants, providing adequate space for maturation, and preparing the ground can help ensure that they survive with minimal maintenance, and don't buckle the sidewalks as they mature. The following guidelines should be considered: plants should be adapted to the local climate and fit the character of the surrounding area — they should survive without protection or intensive irrigation; and plant's growth patterns should not obscure signs or pedestrians' and motorists' views of each other.



Photo by Dan Burden

Landscaping with low shrubs, ground cover, and mature trees that are properly pruned can add shade, color, and visual interest to a street.

Purpose:

- Enhance the street environment.
- Calm traffic by creating a visual narrowing of the roadway.

Considerations:

- Maintenance must be considered and agreed to up-front, whether it is the municipality or the neighborhood residents who will take responsibility for maintenance.
- Shrubs should be low-growing and trees should be trimmed up to at least 2.4 to 3.0 m (8 to 10 ft) to ensure that sight distances and head room are maintained and personal security is not compromised.
- Plants and trees should be chosen with care to match the character of the area; be easily maintained; and not create other problems, such as buckling sidewalks.

Estimated Cost:

Opportunities for funding landscaping are often more flexible than for major street changes. For example, the cost of the actual landscaping may be paid for by the corresponding neighborhood or business groups. Often, municipalities will pay for the initial installation and homeowners associations, neighborhood residents, or businesses agree to maintain anything more elaborate than basic tree landscaping.

30. Specific Paving Treatments

Paving materials are important to the function and look of a street, both in the road and on the sidewalk. Occasionally, paving materials in and of themselves act as a traffic-calming device (e.g., when the street is paved in brick or cobblestone). However, some of these materials may be noisy and unfriendly to bicyclists, pedestrians, wheelchairs, or snowplow blades. In particular, cobblestones should not be used in the expected pedestrian or bicycle path, although they may be used as aesthetic elements in a streetscape design. Smooth travel surfaces are best for all pedestrians.

The pedestrian walkway material should be firm, planar, and slip-resistant. Concrete is the preferred walking surface. A different look can be achieved by using stamped concrete or concrete pavers, which are available in a variety of colors and shapes; however, jointed surfaces may induce vibration, which can be painful to some pedestrians. They can also be used on the top of raised devices.

It is important to ensure crosswalk visibility. High visibility markings are often best. Textured crosswalks should be marked with reflective lines since these types of crosswalks are not as visible, especially at night or on rainy days.

Colored paving can often enhance the function of portions of the roadway, such as a colored bicycle lane. This can create the perception of street narrowing, in addition to enhancing the travel facility for bicyclists.



Photo by Cara Seiderman

Brick or cobblestone streets help slow traffic and create a feeling that the street is not a highway or fast-moving arterial.



Sketch by Michael Kimmelberg

Purpose:

- Send a visual cue about the function of a street.
- Create an aesthetic enhancement of a street.
- Delineate separate space for pedestrians or bicyclists.

Considerations:

- Slippery surfaces, such as smooth granite and paint, and uneven surfaces, such as cobblestones and brick, should not be used in the primary pedestrian or bicycle travel paths. Bumpy surfaces may be especially uncomfortable for wheelchair users and a tripping hazard for all pedestrians.
- Coordinate choice and placement of materials with maintenance agencies.
- Design and maintenance must ensure crosswalk visibility over time.
- Using materials such as bricks and cobblestones may increase the cost of construction and maintenance.

Estimated Cost:

Variable; materials requiring hand labor (cobblestones or pavers) have a higher cost.

31. Serpentine Design

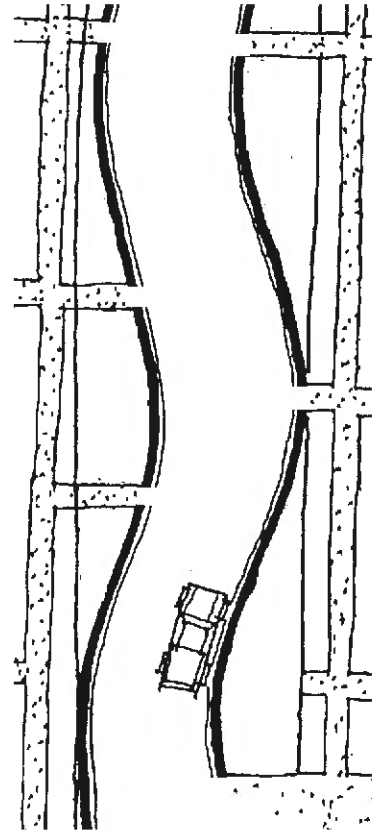
Serpentine design refers to the use of a winding street pattern with built-in visual enhancements through a neighborhood, which allow for through movement while forcing vehicles to slow. The opportunities for significant landscaping can be used to create a park-like atmosphere.

Such designs are usually implemented with construction of a new neighborhood street or during reconstruction of an existing street corridor. This type of design can be more expensive than other traffic-calming options and needs to be coordinated with driveway access.



Photo by Cara Seiderman

The serpentine street is a curving roadway that helps slow traffic through the use of curbs and landscaping.



Making Streets That Work, Seattle, 1995

Purpose:

- Change to the entire look of a street to send a message to drivers that the road is not for fast driving.

Considerations:

- Where costs are a concern, lower cost, equally effective traffic-calming strategies may be preferable.
- Most cost-effective to build as a new street or where a street will soon undergo major reconstruction for utility or other purposes.

Estimated Cost:

The cost can be high (\$60,000 to \$90,000 per block) to retrofit a street, but may be no extra to build a new street with this design if adequate right-of-way is available.

32. Woonerf

"Woonerf" ("Street for living") is a Dutch term for a common space created to be shared by pedestrians, bicyclists, and low-speed motor vehicles. They are typically narrow streets without curbs and sidewalks, and vehicles are slowed by placing trees, planters, parking areas, and other obstacles in the street. Motorists become the intruders and must travel at very low speeds below 16 km/h (10 mi/h). This makes a street available for public use that is essentially only intended for local residents. A woonerf identification sign is placed at each street entrance.

Consideration must be given to provide access by fire trucks, sanitation vehicles and other service vehicles (school buses and street sweepers), if needed.



Photo by Dan Burden

Motorists, bicyclists, and pedestrians share the space on this woonerf or "living street" in Asheville, North Carolina.

Purpose:

- Create a very low automobile volume, primarily on local access streets.
- Create a public space for social and possibly commercial activities and play by area children.

Considerations:

- A woonerf is generally not appropriate where there is a need to provide nonresident motorists with access to services or through travel.
- The design needs to keep vehicle speeds very low in order to make the streets safe for children.

Estimated Cost:

The cost to retrofit a woonerf may be quite high, but there would be no extra cost if designed into the original construction.

E. Traffic Management



Photo by Michael Cynecki

Although they are sometimes lumped together, traffic management and traffic calming are different tools and address different problems. Traffic management includes the use of traditional traffic control devices to manage volumes and routes of traffic. Traffic calming deals with what happens to traffic once it is on a street. For example, limiting access to a street (e.g., diverting traffic from entering a street on one end) may reduce the amount of traffic on that street, but will do nothing to affect the speed of the traffic that travels on that street or others. Traffic management and traffic calming are often complementary, and a plan to retrofit an area often includes a variety of tools.

Communities should think about the broader context of traffic. If there is too much traffic on any one street, it may be that there is too much traffic altogether. A more significant plan to reduce overall traffic volumes would be appropriate — encouraging and providing for alternate modes of travel by developing pedestrian and bicycling networks, implementing Transportation Demand Management, enhancing transit systems, improving land-use planning, etc. Comprehensive traffic reduction or mitigation strategies are important; however, these are beyond the scope of this guide. Resources that provide guidance on these issues are included in the reference section.

Traffic calming and traffic management should be assessed from an areawide perspective. The



Photo by Dan Burden

This street closure in Charlotte provides needed open space in an urban neighborhood.

problem should not just be shifted from one street to another. Although implementation usually occurs in stages, an overall plan can be developed up-front, involving a larger neighborhood or area of the city.

Traffic calming has also helped reduce motor vehicle traffic volumes and increase walking and bicycling. For example, on one traffic-calmed street in Berkeley, CA, the number of bicyclists and pedestrians more than doubled after the street was reconstructed with traffic-calming tools, and motor vehicle volumes decreased by about 20 percent (see Appendix A).

Traffic volume reduction raises the question: Where does the traffic go? In the Berkeley case, traffic volumes on parallel streets did not account for all of the traffic that disappeared from the traffic-calmed street. Ideally, the reduction in traffic means that some people chose a different mode of travel, such as transit, walking, or bicycling. This is only feasible if a system is in place to support those modes. What is often the case in selective street redesign is that traffic is routed onto other streets. It is desirable to keep traffic on collector and arterial streets and off residential streets. However, in many communities, arterials are already over capacity, and alternate routes may also involve other residential streets.

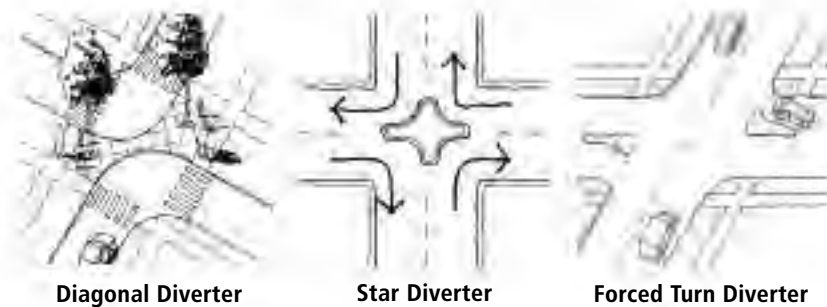
Traffic management and traffic calming should involve the community. Neighborhood participation and the community involvement process are discussed in Chapter 5.

33. Diverters

A diverter is an island built at a residential street intersection that prevents certain through and/or turning movements. Diverters affect people living in the neighborhood more than anyone else. Therefore, diverters should be considered only when less restrictive measures are not appropriate.

Four types of diverters are: diagonal, star, forced turn, and truncated. A diagonal diverter breaks up cut-through movements and forces right or left turns in certain directions. A star diverter consists of a star-shaped island placed at the intersection, which forces right turns from each approach. A truncated diagonal diverter is a diverter with one end open to allow additional turning movements. Other types of island diverters can be placed on one or more approach legs to prevent through and left-turn movements and force vehicles to turn right.

As with other traffic management tools, diverters must be used in conjunction with other traffic management tools within the neighborhood street network. Any of these diverters can be designed for bicycle and pedestrian access.



Traffic diverters restrict certain traffic movements and should only be considered when less restrictive measures are not appropriate.



Truncated Diverter

Sketch by Michael Kimmelberg

Purpose:

- Discourage or prevent traffic from cutting through a neighborhood.

Considerations:

- Impacts residents more than through traffic.
- Consider less restrictive measures first.
- Evaluate traffic patterns to determine whether other streets would be adversely affected.
- Design diverters to allow bicycle, pedestrian, and emergency vehicle access. If this cannot be done and the street is a major bicycle corridor, a diverter should not be used.
- Diverters generally do not effectively address midblock speeding problems.
- Diagonal diverters may be used in conjunction with other traffic management tools and are most effective when applied to the entire neighborhood street network.
- Diverters should have strong neighborhood support.
- The effect of diverters on service vehicles should be considered.

Estimated Cost:

\$15,000 to \$45,000 each, depending on the type of diverter and the need to accommodate drainage.

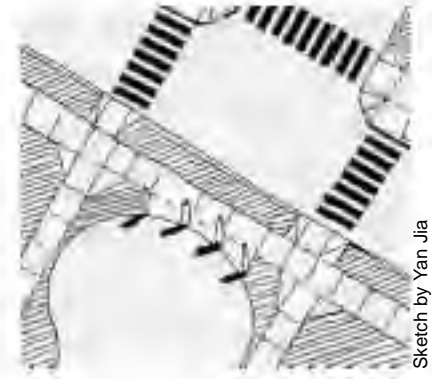
34. Full Street Closure

A full street closure is accomplished by installing a physical barrier that blocks a street to motor vehicle traffic and provides some means for vehicles to turn around. Full street closures should be used only in the rarest of circumstances. Neighborhoods with cul-de-sac streets require extensive out-of-the-way travel, which is not a mere convenience issue, but has serious implications for impacts on other streets. All traffic is forced to travel on feeder streets, which has negative consequences for the people who live on those streets and forces higher levels of control at critical intersections.

If a street closure is done, it should always allow for the free through movement of all pedestrians, including wheelchair users, and bicyclists. Emergency vehicles should also be able to access the street; this can be done with a type of barrier or gate that is electronically operated, permitting only large vehicles to traverse it. Examples are mountable curbs or an accessway with a raised element in the center that a low vehicle would hit, though those treatments may not be able to stop pickups or sport utility vehicles. This is usually only appropriate for places with no snow (otherwise the device would be covered with snow and the accessway could not be cleared).



Access is closed on this residential street.



Purpose:

- Ultimate limitation of motor vehicle traffic to certain streets.

Considerations:

- Part of an overall traffic management strategy.
- Analyze whether other streets would receive diverted traffic as a result of the street closure, and whether alternative streets exist for through traffic.
- Provide a turnaround area for motor vehicles, including service vehicles, and provide for surface drainage.
- Full street closures may be considered for local streets, but are not appropriate for collector streets.
- Do not use if the street is an emergency or school bus route.
- Do not adversely affect access to destinations in the community by pedestrians and bicyclists.
- Not an appropriate measure for addressing crime or other social problems.

Estimated Cost:

The cost for a full, landscaped street closure varies from approximately \$30,000 to \$100,000, depending on conditions.

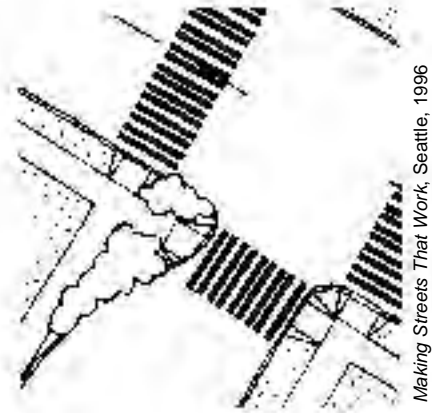
35. Partial Street Closure

A partial street closure uses a semi-diverter to physically close or block one direction of motor vehicle travel into or out of an intersection; it could also involve blocking one direction of a two-way street. Partial street closures at the entrance to a neighborhood or area should consider the traffic flow pattern of the surrounding streets as well. The design of this measure should allow for easy access by bicyclists and all pedestrians.

A partial closure provides better emergency access than a full closure. Since this design also allows motorists to easily violate the prohibitions, police enforcement may be required. If the partial closure only eliminates an entrance to a street, a turnaround is not needed; closing an exit will generally require a turnaround.



This partial street closure is found in Phoenix, AZ.



Purpose:

- Prevent turns from an arterial street onto a residential street.
- Reduce cut-through traffic.
- Restrict access to a street without creating one-way streets.

Considerations:

- Do not adversely affect access by service vehicles.
- Analyze whether less restrictive measures would work.
- Analyze whether other local streets will be adversely affected and/or access into or out of the neighborhood would not be adequate.
- Will create out-of-the-way travel for residents and put additional traffic on other streets.
- Consider impact on school bus routes, emergency access, and trash pickup.
- Will not solve speeding issues; speeds may increase on the new one-way street.

Estimated Cost:

A well-designed, landscaped partial street closure at an intersection typically costs approximately \$10,000 to \$25,000. They can be installed for less if there are no major drainage issues and landscaping is minimal.

36. Pedestrian Streets/Malls

There are two types of pedestrian streets/malls: (1) those that eliminate motor vehicle traffic (deliveries permitted during off-peak hours) and (2) those that allow some motor vehicle traffic at very low speeds. The second type can be thought of as a pedestrian street that allows some motor vehicles, as opposed to a motor vehicle street that allows some pedestrians.

Pedestrian streets have been successful in places that are thriving and have high volumes of pedestrians. Examples of successful pedestrian streets include Church Street in Burlington, VT; Downtown Crossing in Boston, MA; Maiden Lane in San Francisco, CA; Occidental Street in Seattle, WA; Third Street Promenade in Santa Monica, CA; and, Fremont Street in Las Vegas, NV.

Another option is to create a part-time pedestrian street, as is done, for example, in the French Quarter in New Orleans, LA, which uses removable barriers to close the street to motorists at night.



Photo by Cara Seiderman

Church Street in Burlington, Vermont, is a successful pedestrian street with market stalls, public art, landscaping, and cafes.

Purpose:

- Create a significant public space in a downtown district, a tourist district, or a special events or marketplace area.
- Enhance the experience for people in a commercial district.

Considerations:

- Pedestrian streets (those that eliminate motor vehicles) created with the notion of attracting people in areas that are on the decline have usually been unsuccessful.
- The pedestrian environment can often be enhanced through other measures, including street narrowing/sidewalk widening and the addition of landscaping.

Estimated Cost:

A pedestrian street can be created simply by blocking either end of an existing street with nothing more than a few signs. Temporary pedestrian streets can be created for weekends or holidays. If the street is going to be a permanent public space, care should be taken in the design. Depending on the extent of the treatment (one block or several blocks) and the quality of the materials used, a true pedestrian street can cost from \$100,000 to several million dollars.

F. Signals and Signs



Photo by Cara Seiderman

37. Traffic Signals

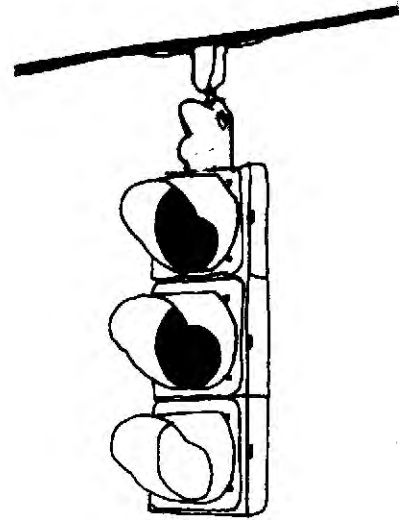
Traffic signals create gaps in the traffic flow, allowing pedestrians to cross the street. They should allow adequate crossing time for pedestrians and an adequate clearance interval based upon a maximum walking speed of 1.1 m/s (3.5 ft/s). In areas where there is a heavy concentration of the elderly or children, a lower speed of less than 1.1 m/s (3.5 ft/s) should be used in determining pedestrian clearance time. Signals are particularly important at high-use, mid-block crossings on higher speed roads, multi-lane roads, or at highly congested intersections. National warrants from the *Manual on Uniform Traffic Control Devices* are based on the number of pedestrians and vehicles crossing the intersection, among other factors.⁽¹⁾ However, judgment must also be used on a case-by-case basis. For example, a requirement for installing a traffic signal is that there are a certain number of pedestrians present. If a new facility is being built — a park or recreational path, for example — there will be a new demand, and the signal should be installed in conjunction with the new facility based on projected crossing demand. There may also be latent demand if a destination is not currently accessible, but could become so with new facilities or redesign.

In downtown areas, signals are often closely spaced, sometimes every block. Timed sequencing of signals may reduce the amount of time allotted per cycle for pedestrian crossing to unsafe lengths. Signals are usually spaced farther apart in suburban or outlying areas, but similar considerations for pedestrian phasing should be made. When high pedestrian traffic exists during a majority of the day, fixed-time signals should be used to consistently allow crossing opportunities. Pedestrian actuation should only be used when pedestrian crossings are intermittent, and should be made accessible to all pedestrians, including those with disabilities.



Photo by Barbara Gray

A traffic signal at a busy intersection with high volumes of pedestrians, bicyclists, and cars.



Making Streets That Work, Seattle, 1996

Purpose:

- Provide intervals in a traffic system where pedestrians can cross streets safely.

Considerations:

- Where pedestrian traffic is regular and frequent, pedestrian phases should come up automatically. Pedestrian actuation should only be used when pedestrian crossings are intermittent.
- Signal cycles should be kept short (ideally 90 seconds maximum) to reduce pedestrian delay. Pedestrians are very sensitive to delays.
- Marked crosswalks at signals encourage pedestrians to cross at the signal and discourage motorists from encroaching into the crossing area.

Estimated Cost:

\$30,000 to \$140,000

38. Pedestrian Signals

Pedestrian signal indications should be used at all traffic signals whenever warranted, according to the MUTCD. The use of WALK/DON'T WALK pedestrian signal indications at signal locations are important in many cases, including when vehicle signals are not visible to pedestrians, when signal timing is complex (e.g., there is a dedicated left-turn signal for motorists, at established school zone crossings, when an exclusive pedestrian interval is provided, and for wide streets where pedestrian clearance information is considered helpful.⁽¹⁾

The international pedestrian symbol signal is preferable and is recommended in the MUTCD; the WALK and DON'T WALK messages are allowable alternatives.⁽¹⁾ Pedestrian signals should be clearly visible to the pedestrian at all times when in the crosswalk or waiting on the far side of the street. Larger pedestrian signals can be beneficial in some circumstances (e.g., where the streets are wide). Signals may be supplemented with audible or other messages to make crossing information accessible for all pedestrians, including those with vision impairments. The decision to install audible pedestrian signals should consider the noise impact on the surrounding area. These should be used judiciously, because they can become a noise problem.



Photo by Robert Schneider

Pedestrian signals should always be clearly visible to the pedestrian while in the crosswalk and waiting on the far side of the street.



Pedestrian signals (MUTCD)

Purpose:

- Indicate appropriate time for pedestrians to cross.
- Provide pedestrian clearance interval.

Considerations:

- Ensure that signals are visible to pedestrians.
- When possible, provide a walk interval for every cycle.
- If pedestrian pushbuttons are used, they must be well-signed and visible, and within reach and operable from a flat surface for all crossing pedestrians.

Estimated Cost:

\$20,000 to \$40,000

39. Upgrade/Modify Pedestrian Signal Timing

There are several types of signal timing for pedestrian signals, including concurrent, exclusive, “leading pedestrian interval” (LPI), and all-red interval. In general, shorter cycle lengths and longer walk intervals generally provide better service to pedestrians and encourage better signal compliance. For optimal pedestrian service, fixed-time signal operation usually works best. Pedestrian pushbuttons may be installed at locations where pedestrians are expected intermittently. Quick response to the pushbutton or feedback to the pedestrian should be programmed into the system. When used, pushbuttons should be well-signed and within reach and operable from a flat surface for pedestrians in wheelchairs and with visual disabilities. They should be conveniently placed in the area where pedestrians wait to cross.

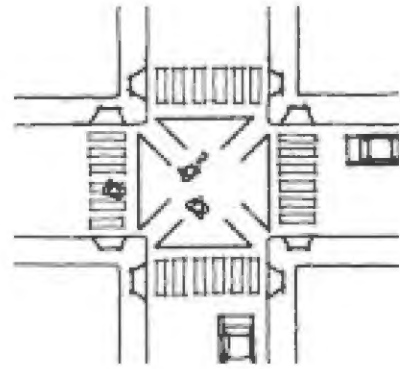
In addition to concurrent pedestrian signal timing (where motorists may turn left or right across pedestrians' paths after yielding to pedestrians), exclusive pedestrian intervals (see Traffic Signal Enhancements) stop traffic in all directions. Exclusive pedestrian timing has been shown to reduce pedestrian crashes by 50 percent in some downtown locations with heavy pedestrian volumes and low vehicle speeds and volumes.⁽²⁾ With concurrent signals, pedestrians usually have more crossing opportunities and have to wait less. Unless a system is willing to take more time from vehicular phases, pedestrians will often have to wait a long time for an exclusive signal. This is not very pedestrian-friendly, and many pedestrians will simply choose to ignore the signal and cross if and when there is a gap in traffic, negating the potential safety benefits of the exclusive signal.⁽³⁾

A simple, useful change is the LPI. An LPI gives pedestrians an advance walk signal before the motorists get a green light, giving the pedestrian several seconds to start in the crosswalk where there is a



Photo by Barbara Gray

With a leading pedestrian interval, pedestrians get an advance walk signal before motorists get a green. This gives the pedestrians several seconds to establish their presence in the crosswalk before motorists start to turn.



Sketch by Michael Kimelberg

Exclusive walk phase or
“Pedestrian Scramble”

Purpose:

- A “Pedestrian Scramble” provides an exclusive pedestrian crossing phase with no conflicting traffic.
- A short all-red clearance interval provides a better separation between cars and pedestrians.

Considerations:

- A “Pedestrian Scramble” usually creates a longer cycle length and a longer wait between crossings.
- The Scramble may eliminate the ability to synchronize timing at adjacent traffic signals.
- Scramble timing is most applicable to downtown areas with high pedestrian volumes (e.g., more than 1,200 pedestrian crossings per day).
- Scramble timing eliminates conflicts with turning vehicles if pedestrians and motorists obey their signals.
- The benefits of this treatment may not extend to vision-impaired pedestrians.
- Wider intersections require longer cycle lengths.
- Longer walk or pedestrian clearance intervals may also

39. Upgrade/Modify Pedestrian Signal Timing (continued)

concurrent signal. This makes pedestrians more visible to motorists and motorists more likely to yield to them. This advance crossing phase approach has been used successfully in several places, such as New York City, for two decades and studies have demonstrated reduced conflicts for pedestrians.⁽⁴⁾ The advance pedestrian phase is particularly effective where there is a two-lane turning movement. To be useful to pedestrians with vision impairments, an LPI needs to be accompanied by an audible signal to indicate the crossing interval.

There are some situations where an exclusive pedestrian phase may be preferable to an LPI. Exclusive phases are desirable where there are high-volume turning movements that conflict with the pedestrians crossing.

lead to longer cycle lengths.

- Use fixed-time operation unless pedestrian arrivals are intermittent.

Estimated Cost:

Adjusting signal timing is very low cost and requires a few hours of staff time to accomplish. New signal equipment ranges from \$20,000 to \$140,000.



Photo by Herman Huang

The pedestrian has a dedicated walk phase at this intersection of a busy street and a trail crossing.



Photo by Herman Huang

The pedestrian has a dedicated walk phase and is allowed to cross diagonally at this intersection.

40. Traffic Signal Enhancements

A variety of traffic signal enhancements that can benefit pedestrians and bicyclists are available. These include automatic pedestrian detectors, providing larger traffic signals to ensure visibility, placing signals so that motorists waiting at a red light can't see the other signals and anticipate the green, and installing countdown signals to provide pedestrians with information about the amount of time remaining in a crossing interval.

Countdown signals may be designed to begin counting down at the beginning of the walk phase or at the beginning of the clearance (flashing DON'T WALK) interval.

Since pedestrian pushbutton devices are not activated by about one-half of pedestrians (even fewer activate them where there are sufficient motor vehicle gaps), new "intelligent" microwave or infrared pedestrian detectors are now being installed and tested in some U.S. cities. These automatically activate the red traffic and WALK signals when pedestrians are detected. Detectors can also be used to extend the crossing time for slower moving pedestrians in the crosswalk. Automatic pedestrian detectors have been found to improve pedestrian signal compliance and also reduce pedestrian conflicts with motor vehicles. However, they are still considered experimental and their reliability may vary under different environmental conditions.⁽⁵⁾



Photo by Cara Seiderman

This countdown signal in Cambridge, Massachusetts, indicates to pedestrians the amount of time they have available to cross.



Illustration by Christian Vailulis

An automated pedestrian detection system.

Purpose:

- Improve pedestrian accommodation at signalized crossings.

Considerations:

- Pedestrian signals need to indicate the crossing interval by visual, audible, and/or tactile means if pedestrians with vision impairments are to take advantage of them.
- The effects of pedestrian countdown signals on pedestrian safety are not well known. Further research is needed to better understand their effects.

Estimated Cost:

About \$5,000 to add new pedestrian signals and mark crosswalks.

41. Right-Turn-on-Red Restrictions

A permissible Right Turn on Red (RTOR) was introduced in the 1970s as a fuel-saving measure and has sometimes had detrimental effects on pedestrians. While the law requires motorists to come to a full stop and yield to cross-street traffic and pedestrians prior to turning right on red, many motorists do not fully comply with the regulations, especially at intersections with wide turning radii. Motorists are so intent on looking for traffic approaching on their left that they may not be alert to pedestrians approaching on their right. In addition, motorists usually pull up into the crosswalk to wait for a gap in traffic, blocking pedestrian crossing movements. In some instances, motorists simply do not come to a full stop.

One concern that comes up when RTOR is prohibited is that this may lead to higher right-turn-on-green conflicts when there are concurrent signals. The use of the leading pedestrian interval (LPI) can usually best address this issue (see Tool #39). Where pedestrian volumes are very high, exclusive pedestrian signals should be considered.

Prohibiting RTOR should be considered where and/or when there are high pedestrian volumes. This can be done with a simple sign posting, although there are some options that are more effective than a standard sign. For example, one option is a larger 762-mm by 914-mm (30-in by 36-in) NO TURN ON RED sign, which is more conspicuous. For areas where a right turn is acceptable during certain times, time-of-day restrictions may be appropriate. A variable-message NO TURN ON RED sign is also an option.⁽⁶⁾



Prohibiting right turns can benefit pedestrian safety at some locations.

Purpose:

- Increase pedestrian safety and decrease crashes with right-turning vehicles.

Considerations:

- Prohibiting RTOR is a simple, low-cost measure. Together with a leading pedestrian interval, the signal changes can benefit pedestrians with minimal impact on traffic.
- Part-time RTOR prohibitions during the busiest times of the day may be sufficient to address the problem.
- Signs should be clearly visible to right-turning motorists stopped in the curb lane at the crosswalk.

Estimated Cost:

\$30 to \$150 per NO TURN ON RED sign plus installation at \$200 per sign. Electronic signs have higher costs.

42. Advanced Stop Lines

At signalized intersections and midblock crossings, the vehicle stop line can be moved farther back from the pedestrian crosswalk for an improved factor of safety and for improved visibility of pedestrians. In some places, the stop line has been moved back by 4.6 to 9.1 m (15 to 30 ft) relative to the marked crosswalk with considerable safety benefits for pedestrians. One study found that use of a “Stop Here For Pedestrians” sign alone reduced conflicts between drivers and pedestrians by 67 percent. With the addition of an advanced stop line, this type of conflict was reduced by 90 percent compared to baseline levels.⁽⁷⁾

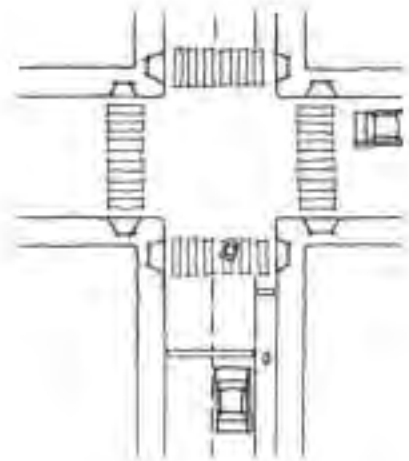
The advanced stop lines allow pedestrians and drivers to have a clearer view of each other and more time in which to assess each other’s intentions. The effectiveness of this tool depends upon whether motorists are likely to obey the stop line, which varies from place to place.

Advanced stop lines are also applicable for non-signalized crosswalks on multi-lane roads to ensure that drivers in all lanes have a clear view of a crossing pedestrian.



Photo by Cara Seiderman

Advanced stop lines are used at this signalized crossing to improve sight distances and to give the motorist who initially fails to see the crosswalk more time to stop. The bicyclist can advance ahead, which aids in bicyclist safety, particularly with right-turning motorists.



Sketch by Michael Kimelberg

Purpose:

- Improve visibility of pedestrians to motorists.
- Allow pedestrians to advance in a crosswalk before motor vehicles turn.

Considerations:

- Effectiveness depends on motorist compliance with the marked stop line.
- If placed too far in advance of the crosswalk, motorists may ignore the line.
- In some locations, a wider crosswalk may be an effective alternative.

Estimated Cost:

There is no extra cost when the recessed stop line is installed on new paving or as part of repaving projects. A STOP HERE sign can be used to supplement the recessed stop line.

43. Add/Modify Signage

Signs can provide important information that can improve road safety. By letting people know what to expect, there is a greater chance that they will react and behave appropriately. For example, giving motorists advance warning of an upcoming pedestrian crossing or that they are entering a traffic-calmed area will alert them to modify their speed. Sign use and movement should be done judiciously, as overuse breeds noncompliance and disrespect. Too many signs may also create visual clutter and signs can get lost.

Regulatory signs, such as STOP, YIELD, or turn restrictions require certain driver actions and can be enforced. Warning signs can provide helpful information, especially to motorists and pedestrians unfamiliar with an area. Some examples of signs that affect pedestrians include pedestrian warning signs, motorist warning signs, NO TURN ON RED signs, and guide signs.

Advance pedestrian warning signs should be used where pedestrian crossings may not be expected by motorists, especially if there are many motorists who are unfamiliar with the area. A new fluorescent yellow/green color is approved for pedestrian, bicycle, and school warning signs. This bright color attracts the attention of drivers because it is unique.

All signs should be periodically checked to make sure that they are in good condition, free from graffiti, reflective at night, and continue to serve a purpose. In unusual cases, signs may be used to prohibit pedestrian crossings at an undesirable location and re-route them to a safer crossing location, or warn pedestrians of unexpected driver maneuvers. It is preferable to create safe crossings where there are clear pedestrian destinations. If unexpected driving maneuvers occur at what is an otherwise legal pedestrian crossing, an evaluation should be done to find ways to remedy or prevent the unsafe motorist maneuvers.



This experimental sign instructs drivers to yield to pedestrians when turning at this intersection.



Manual on Uniform Traffic Control Devices (MUTCD)

Purpose:

- Provide regulation, warning, or information to road users as to what to expect and how to behave.

Considerations:

- Overuse of signs breeds non-compliance and disrespect. Too many signs can lead to visual clutter with the result that a driver is not likely to read or pay attention to any of the signs.
- Traffic signs used on public property must comply with the *Manual on Uniform Traffic Control Devices* (MUTCD).
- Signs should be checked to assure adequate nighttime reflectivity.

Estimated Cost:

\$50 to \$150 per sign plus installation costs.

G. Other Measures



Photo by Dan Burden

44. School Zone Improvements

A variety of roadway improvements may be used to enhance the safety or mobility of children in school zones. The use of well-trained adult crossing guards has been found to be one of the most effective measures for assisting children in crossing streets safely.⁽¹⁾ Sidewalks or separated walkways and paths are essential for a safe trip from home to school on foot or by bike. Adult crossing guards require training and monitoring and should be equipped with a bright and reflective safety vest and a STOP paddle. Police enforcement in school zones may be needed in situations where drivers are speeding or not yielding to children in crosswalks.

Other helpful measures include parking prohibitions near intersections and crosswalks near schools; increased child supervision; and the use of signs and markings, such as the school advance warning sign (which can be fluorescent yellow/green) and SPEED LIMIT 25 MPH WHEN FLASHING. Schools should develop "safe routes to school" plans and work with local agencies to identify and correct problem areas. Marked crosswalks can help guide children to the best routes to school. School administrators and parent-teacher organizations need to educate students and parents about school safety and access to and from school. Education, enforcement, and well-designed roads must all be in place to encourage motorists to drive appropriately.



Photo by Barbara Gray

Children leaving school in this Honolulu suburb walk their bikes to the intersection where a crossing guard controls movements.



Manual of Uniform Traffic Control Devices (MUTCD)

Purpose:

- Provide enhanced safety around schools.

Considerations:

- Safety must be a combined effort between local traffic officials, police, school officials, parents, and students.

Estimated Cost:

Costs would depend on the school zone treatment selected. For example, if signs were chosen, costs might include \$50 to \$150 per sign plus installation costs.

44. School Zone Improvements (continued)

One of the biggest safety hazards around schools is parents or caretakers dropping off and picking up their children. There are two immediate solutions: (1) there needs to be a clearly marked area where parents are permitted to drop off and pick up their children, and (2) drop-off/pick-up regulations must be provided to parents on the first day of school. Drop-off areas must be located away from where children on foot cross streets or access the school. Parent drop-off zones must also be separated from bus drop-off zones. If parents can be trained to do it right at the start of the school year, they are likely to continue good behavior throughout the year.

For a longer term solution, it is preferable to create an environment where children can walk or bicycle safely to school, provided they live within a suitable distance. One concept that has been successful in some communities is the concept of a "walking bus," where an adult accompanies children to school, starting at one location and picking children up along the way. Soon, a fairly sizeable group of children are walking in a regular formation, two by two, under the supervision of a responsible adult, who is mindful of street crossings. The presence of such groups affects drivers' behavior, as they tend to be more watchful of children walking. Parents take turns accompanying the "walking school bus" in ways that fit their schedules.



Photo by Dan Burden

Vehicles must slow down to enter the tight curve of this modern roundabout in a school zone in Montpelier, Vermont. The roundabout creates a safer interaction between vehicles and pedestrians.

45. Identify Neighborhood

Many neighborhoods or business districts want to be recognized for their unique character. This can enhance the walking environment and sense of community.

Examples of treatments include gateways, traffic calming, welcome signs, flower planters, banners, decorative street lighting, unique street name signs, and other details. Neighborhood identity treatments rarely provide any direct traffic improvements, but they help develop interest in enhancing the community.



An identity sign in Seattle's Wallingford neighborhood marks an entry to the area.

Photo by Peter Lagerwey



Making Streets That Work, Seattle, 1996

Purpose:

- Increase the visibility of a neighborhood or district and support community efforts to define their neighborhood.

Considerations:

- Supports community efforts, but has no direct traffic benefits.

Estimated Cost:

\$50 to \$150 per sign. Some signs may cost more because they are usually custom made.

46. Speed-Monitoring Trailer

Speed-monitoring trailers — sign boards on trailers that display the speed of passing vehicles — are used by police departments and transportation agencies as educational tools that can enhance enforcement efforts directed at speed compliance. Speed radar trailers are best used in residential areas and may be used in conjunction with Neighborhood Speed Watch or other neighborhood safety education programs. They can help raise residents' awareness of how they themselves are often those speeding, not just “outsiders.” Speed trailers are not substitutes for permanent actions, such as traffic-calming treatments, to address neighborhood speeding issues.

Speed-monitoring trailers can be used at several locations and should have occasional police monitoring and enforcement to maintain driver respect.



Speed-monitoring trailers let motorists know the speed limit and the speed they are traveling.

Photo by Dan Burden



Making Streets That Work, Seattle, 1996

Purpose:

- Enhance enforcement efforts through public education and awareness.

Considerations:

- Occasional enforcement is needed to supplement the speed-monitoring trailers.
- Speed-monitoring trailers are not a substitute for engineering measures.
- Should not obstruct pedestrian travelway or sightlines.

Estimated Cost:

\$10,000 to \$15,000 to purchase the speed-monitoring trailer, plus the cost to move the trailer to different locations and to monitor the trailer.

47. On-Street Parking Enhancements

On-street parking can be both a benefit and a detriment to pedestrians. On-street parking does increase positive “friction” along a street and can narrow the effective crossing width, both of which encourages slower speeds; parking can also provide a buffer between moving motor vehicle traffic and pedestrians along a sidewalk. In addition, businesses reliant on on-street parking as opposed to parking lots are more geared toward pedestrian access. This attention can foster a more vibrant pedestrian commercial environment.

On the other hand, parking creates a visual barrier between motor vehicle traffic and crossing pedestrians, especially children and people using wheelchairs. Therefore, where there is parking, curb extensions should be built where pedestrians cross. Parking needs to be removed on the approaches to crosswalks.

At least 6 m (20 ft) of parking should be removed on the approach to a marked or unmarked crosswalk and about 6 m of parking should be removed downstream from the crosswalk. Some agencies require that parking be removed 9 to 15 m (30 to 50 ft) from intersections for pedestrian safety reasons. Well-designed curb extensions can reduce these distances and maximize the number of on-street parking spaces.



On-street parking in Concord, Massachusetts, shields pedestrians from moving traffic.



Sketch by Michael Kimelberg

Purpose:

- Provide motorist access to destinations along a street.
- Aid in speed reduction by increasing friction along the street.
- Provide a buffer between sidewalk edge and moving traffic.

Considerations:

- Parking may take up space desired for other uses, such as wider sidewalks or bicycle lanes.
- Approaches to crosswalks and intersections should be cleared and curb extensions added at crossing locations for pedestrian safety.
- Parking meters should be used in downtown areas where there is a need for parking turnover. This can generate revenue for the community.

Estimated Cost:

\$30 to \$150 per sign. About \$300 per parking meter and installation. Curb paint and stall marks or striping costs are additional (optional).

Problem-Solving Methods

Deciding on the set of treatments that will provide the greatest benefits in terms of providing safety and mobility requires transportation and land-use planners and engineers and community leaders to engage in problem-solving.

Pedestrians face a variety of challenges when they walk along and across streets with motor vehicles. Communities are asking for help to "slow traffic down," "make it safer to cross the street," and "make the street more inviting to pedestrians."

The following is a list of requests (objectives) that transportation professionals are likely to face when working to provide pedestrian safety and mobility:

- Reduce speed of motor vehicles.
- Improve sight distance and visibility for motor vehicles and pedestrians.
- Reduce volume of motor vehicles.
- Reduce exposure time for pedestrians.
- Improve access and mobility for all pedestrians, especially those with disabilities.
- Encourage walking by improving aesthetics, safety, and security.
- Improve compliance with traffic laws (motorists and pedestrians).
- Eliminate behaviors that lead to crashes (motorists and pedestrians).

Each of these objectives can be accomplished through a variety of the individual treatments presented in this chapter. Yet, most treatments will work best when used at multiple locations and in combination with other treatments.

In addition, many of the treatments will accomplish two or more objectives. The key is to make sure that the right treatments are chosen to accomplish the desired effect.

The chart located on the following two pages is intended to summarize the uses of the tools presented in this chapter and to assist in the decision-making process. In using the chart, it is important to remember that it is simply a guide. In all cases, good engineering judgment should be applied when making decisions about what treatment will be best for a specific location.

Objective	A. Pedestrian Facility Design	B. Roadway Design	C. Intersection Design
1. Reduce Speed of Motor Vehicles		<ul style="list-style-type: none"> • Add Bike Lane/Shoulder • Road Narrowing • Reduce Number of Lanes • Driveway Improvements • Curb Radius Reduction • Right-Turn Slip Lane 	<ul style="list-style-type: none"> • Modern Roundabouts
Use in Conjunction With Other Treatments	<ul style="list-style-type: none"> • Street Furniture 		
2. Improve Sight Distance and Visibility for Motor Vehicles and Pedestrians	<ul style="list-style-type: none"> • Crosswalk Enhancements • Roadway Lighting • Move Poles/Newspaper Boxes at Street Corners 	<ul style="list-style-type: none"> • Add Bike Lane/Shoulder 	
3. Reduce Volume of Motor Vehicles		<ul style="list-style-type: none"> • Reduce Number of Lanes 	
4. Reduce Exposure for Pedestrians	<ul style="list-style-type: none"> • Overpasses/Underpasses 	<ul style="list-style-type: none"> • Road Narrowing • Reduce Number of Lanes • Raised Median • Pedestrian Crossing Island 	
5. Improve Pedestrian Access and Mobility	<ul style="list-style-type: none"> • Sidewalk/Walkway • Curb Ramps • Crosswalk Enhancements • Transit Stop Treatments • Overpasses/Underpasses 	<ul style="list-style-type: none"> • Raised Median 	
6. Encourage Walking by Improving Aesthetics	<ul style="list-style-type: none"> • Street Furniture • Roadway Lighting • Landscaping Options 	<ul style="list-style-type: none"> • Raised Median 	
7. Improve Compliance With Traffic Laws			<ul style="list-style-type: none"> • Red-Light Cameras
8. Eliminate Behaviors That Lead to Crashes			<ul style="list-style-type: none"> • Red-Light Cameras

D. Traffic Calming

- Curb Extension
- Choker
- Chicane
- Mini-Circle
- Speed Humps
- Speed Table
- Raised Pedestrian Crossing
- Raised Intersection
- Driveway Link/Serpentine
- Woonerf

- Landscaping Options
- Paving Treatments

- Curb Extension
- Speed Table
- Raised Pedestrian Crossing
- Raised Intersection
- Paving Treatments

- Woonerf

- Curb Extension
- Choker
- Pedestrian Crossing Island

- Choker
- Pedestrian Crossing Island

- Gateway
- Landscaping
- Paving Treatments

- Traffic Calming: Choker, Chicane, Mini-Circle, Speed Hump, Speed Table

- Traffic Calming: Choker, Chicane, Mini-Circle, Speed Hump, Speed Table

E. Traffic Management

- Diverters
- Full Street Closure
- Partial Street Closure
- Pedestrian Street

F. Signals and Signs

- Signal Enhancement (e.g., Adjust Signal Timing for Motor Vehicles)

- Sign Improvement

- Sign Improvement (e.g., Warning Sign)
- Advanced Stop Lines

- Pedestrian Signal Timing
- Accessible Pedestrian Signal

- Traffic Signal
- Signal Enhancement
- Accessible Pedestrian Signal
- Pedestrian Signal Timing

- Pedestrian Signal Timing

G. Other Measures

- Speed-Monitoring Trailer
- School Zone Improvement

- Identify Neighborhood

- Speed-Monitoring Trailer
- Pedestrian/Driver Education
- Police Enforcement

- Pedestrian/Driver Education
- Police Enforcement

Chapter 5

Implementation and Resources



Photo by Cara Seiderman

Communities are asking that motor vehicle speeds be reduced on their neighborhood streets, that streets be made accessible to persons with disabilities, and that streetscapes be improved to make them more inviting to pedestrians. Some of the most important issues to the public are safety, access, and aesthetics. This chapter discusses some of the issues related to setting priorities and implementing needed pedestrian improvements.

Implementation

A. Getting Started

"**Getting started**" can be daunting — the needs are overwhelming, resources are scarce, and staff time is limited. Every community is faced with the questions of "Where do I start?" and "How do I get going?" While it is not the intent of this guide to provide an exhaustive discussion of implementation strategies, some direction is useful.

Priorities: Since all pedestrian needs will not be able to be addressed immediately, project priorities need to be established. To create priorities requires several program objectives:

Safety — One objective should be to reduce the number and severity of crashes involving pedestrians. To accomplish this will require: (1) a good understanding of the types of crashes that are occurring in your community, and (2) application of appropriate countermeasures to address these crashes. The information provided in this guide is intended to help select the countermeasures that will be most effective in addressing selected types of crash problems.

Access — A second objective should be to create an accessible community where all pedestrians, including those with disabilities, can reach their desired destinations. Typically, this begins with being able to walk safely along streets (i.e., sidewalks) and across streets at intersections and other appropriate locations.

Aesthetics — It is not enough to simply have a safe, accessible community — it should also be an aesthetically pleasing place to live and work. Landscaping, lighting, and other pedestrian amenities help create a "livable community" and should be considered when making pedestrian improvements.

One Step at a Time: To create a safe, walkable community, take one step at a time. Sidewalks, curb bulbs, and other pedestrian improvements are installed intersection by intersection, block by block. Individually, they do not create a safe, livable community. Collectively, they create the infrastructure needed for a great place to work, play,



Photos by Dan Burden

and do business. In other words, the whole pedestrian system is greater than the sum of its parts.

Community Concerns: Be very sensitive to community concerns. Public participation will build community pride and ownership that is essential to long-term success. Some of the problems identified in this guide will not be an issue in your community and some of the tools may be perceived as too expensive (at least initially). There probably will be measures that your community puts on hold for a few years until a community consensus is reached. Conversely, there probably will be measures that your community would like to pursue that are not even mentioned in this planning guide.

Deliverables: It is very important to produce immediate deliverables that people can see. For example, a new section of sidewalk or a freshly painted crosswalk is visible, while a transportation plan is a paper document that may never be seen or appreciated by the public. To keep its momentum, a program needs some “quick wins.” They create the sense that something is happening and that government is responsive.

B. Construction Strategies

There are many ways to accomplish projects. Be creative, take advantage of opportunities as they present themselves. Here are some suggestions:

Regulation of New Development and Redevelopment: Developers can be required to install public infrastructure such as sidewalks, curb ramps, and traffic signals. In addition, zoning requirements can be written to allow for or require narrower streets, shorter blocks, and mixed-use development. Encouraging developers and community leaders to focus on basic pedestrian needs will benefit the community and increase the attractiveness of the developments themselves.

Annual Programs: Consider expanding/initiating annual programs to make small, visible improvements. Examples include sidewalk replacement programs, curb-ramp programs, annual tree-planting programs, etc. This creates momentum and community support. Several considerations should be made when developing these programs:

- Give priority to locations that are used by schoolchildren, the elderly, those with disabilities, and locations that provide access to transit.
- Consider giving preference to requests from neighborhood groups, especially those that meet other priorities, such as addressing a crash problem.
- Evaluate your construction options. Consider having city crews do work requested by citizens to provide fast customer service while bidding out some of the staff-generated projects.

Capital Projects: "Piggybacking" pedestrian improvements onto capital projects is one of the best ways to make major improvements in a community. Sidewalks, pedestrian ramps, landscaping, lighting, and other amenities can be included in road projects, utility projects, and private construction in public rights-of-way (e.g., cable television, high-speed fiber optics, etc.). To accomplish this, there are several things that can be done:

- Contact all State and regional agencies, and local public and private utilities that do work in public rights-of-way. Secure their 5-year project plans as well as their long-range plans. Then, work with them to make sure that the streets are restored in the way that works for your city.
- Look internally at all capital projects. Make sure that every opportunity to make improvements is taken advantage of at the time of construction.
- Consider combining small projects with larger capital projects as a way of saving money. Generally, bid prices drop as quantities increase.

Public/Private Partnerships: Increasingly, public improvements are realized through public/private partnerships. These partnerships can take many forms. Examples include: Community Development Corporations, neighborhood organizations, grants from foundations, direct industry support, and involvement of individual citizens. In fact, many public projects, whether they are traffic-calming improvements, street trees, or the restoration of historic buildings, are the result of individual people getting involved and deciding to make a difference. This involvement doesn't just happen, it needs to be encouraged and supported by local governmental authorities.

C. Funding

Pedestrian projects and programs can be funded by federal, State, local, private, or any combination of sources. A summary of federal pedestrian funding opportunities can be viewed at www.fhwa.dot.gov/environment/bikpedtr.htm. Communities that are most successful at securing funds often have the following ingredients of success:

Consensus on Priorities: Community consensus on what should be accomplished increases the likelihood of successfully funding a project. A divided or uninvolved community will find it more difficult to raise funds than a community that gives broad support to pedestrian improvement programs.

Dedication: Funding a project is hard work; usually, there are no shortcuts. It usually takes a great amount of effort by many people using multiple funding sources to complete a project successfully. Be aggressive, apply for many different community grants. While professional grant-writing specialists can help, they are no substitute for

community involvement and one-on-one contact (the "people part" of fund raising).

Spark Plugs (Change Agents): Successful projects typically have one or more "can do" people in the right place at the right time, who provide the energy and vision to see a project through. Many successful "can do" politicians get their start as successful neighborhood activists.

Leveraging: Funds, once secured, should always be used to leverage additional funds. For example, a grant from a local foundation could be used as the required match for a Transportation Equity Act for the 21st Century (TEA-21) Enhancement grant.

D. Other Resources

There are many other good resources on planning, funding, and implementing programs to increase pedestrian safety and mobility. Some of these resources are listed below:

American Association of State Highway and Transportation Officials (AASHTO), *Guide for the Development of Bicycle Facilities*, Washington, DC, 1999.

American Planning Association, *Bicycle Facility Planning*, Planning Advisory Service Report 459, Chicago, IL, 1995.

Appleyard, Donald, *Livable Streets*, University of California Press, Berkeley, 1981.

Bentzen, B.L. and L. Tabor, *Accessible Pedestrian Signals*, U.S. Architectural and Transportation Barriers Compliance Board (Access Board), Washington, DC, 1998.

Bentzen, B.L., J.M. Barlow, and L.S. Tabor, *Detectable Warnings: Synthesis of U.S. and International Practice*, U.S. Access Board, Washington, DC, 2000.

Brookline Transportation Department, *Neighborhood Traffic Calming Program for Residential Streets*, Town of Brookline, MA, 1996.

Burden, Dan, *Walkable and Bicycle-Friendly Communities*, Florida Dept. of Transportation, 1996.

Burrington, Stephen H., "Restoring the Rule of Law and Respect for Communities in Transportation," *Environmental Law Journal*, Volume 5, No. 3, New York University, 1996.

CART — Citizens Advocating Responsible Transportation, *Traffic Calming — The Solution to Urban Traffic and a New Vision for Neighborhood Livability*, Ashgrove, Australia, 1989 (reprinted by Sensible Transportation Options for People (STOP), Oregon, 1993).

Conservation Law Foundation, *City Routes, City Rights: Building Livable Neighborhoods and Environmental Justice by Fixing Transportation*, June 1998.

Conservation Law Foundation, *Road Kill: How Solo Driving Runs Down the Economy*, May 1994.

Conservation Law Foundation, *Take Back Your Streets: How to Protect Communities From Asphalt and Traffic*, May 1995.

County Surveyors Society, *Traffic Calming in Practice*, Landor Publishing Ltd., 1994.

Delft Ministry of Transport, Public Works and Water Management, *Cities Make Room for Cyclists*, Delft, The Netherlands, August 1995.

Denmark Ministry of Transport, *Bicycle Markings: Safety Effects at Signalized Intersections*, Traffic Safety and Environment, Road Directorate, 1996.

Denmark Ministry of Transport, *An Improved Traffic Environment: A Catalogue of Ideas*, Traffic Safety and Environment, Road Directorate, 1993.

Denmark Ministry of Transport, *Safety of Cyclists in Urban Areas: Danish Experiences*, Traffic Safety and Environment, Road Directorate, 1994.

Denmark Ministry of Transport, *Speed Management: National Practice and Experiences in Denmark, The Netherlands, and in the United Kingdom*, Report No. 167, Traffic Safety and Environment, Road Directorate, 1999.

Denmark Ministry of Transport, *The Traffic Safety Effects of Bicycle Lanes in Urban Areas*, Traffic Safety and Environment, Road Directorate, 1996.

Devon County Council Engineering and Planning, *Traffic-Calming Guidelines*, Great Britain, 1991.

Dutch Centre for Research and Contract Standardization in Civil and Traffic Engineering, *Sign Up for the Bike: Design Manual for a Cycle-Friendly Infrastructure*, The Netherlands, September 1994.

Engwicht, David, *Reclaiming Our Cities and Towns: Better Living With Less Traffic*, New Society Publishers, Philadelphia, PA, 1993.

Environmental Working Group, Bicycle Federation of American and Surface Transportation Policy Project, *Share the Road: Let's Make America Bicycle Friendly*, May 1997.

Federal Highway Administration, *Bicycle Safety-Related Research Synthesis*, Washington, DC, April 1995.

Federal Highway Administration, *Bicycling & Walking in the Nineties and Beyond: Applying the Scandinavian Experience to America's Challenge*, Washington, DC, November 1994.

Federal Highway Administration, *Flexibility in Highway Design*, Washington, DC, 1997.

Federal Highway Administration, *The National Bicycling and Walking Study: Transportation Choices for a Changing America, Final Report and 24 Case Studies*, Washington, DC, 1994. [Especially Case Study No. 19, "Traffic Calming, Auto-Restricted Zones and Other Traffic Management Techniques."]

Federal Highway Administration, *Safety Effectiveness of Highway Design Features, Volume VI: Pedestrians and Bicyclists*, Washington, DC, 1991.

Federal Highway Administration, *Study Tour Report for Pedestrian and Bicyclist Safety in England, Germany, and the Netherlands*, Washington, DC, October 1994.

Gehl, Jan, *Life Between Buildings*, Van Nostrand Reinhold Company, New York, 1987.

Institute of Transportation Engineers, *ITE Journal*, Volume 67, No. 7, July 1997.

Institute of Transportation Engineers, *ITE Journal*, Volume 67, No. 8, August 1997.

Institute of Transportation Engineers, *Residential Street Design and Traffic Control*, Wolfgang Hamburger et al., Washington, DC, 1989.

Institute of Transportation Engineers, *The Traffic Safety ToolBox: A Primer on Traffic Safety*, Washington, DC, 1994.

ITE Traffic Engineering Council Speed Humps Task Force, *Guidelines for the Design and Application of Speed Humps*, Washington, DC, 1997.

Institute of Transportation Engineers and the Federal Highway Administration, *Traffic Calming State of the Art*, Washington, DC, August 1999.

ITE Transportation Planning Council Committee, *Traditional Neighborhood Development: Street Design Guidelines*, Washington, DC, 1997.

Jacobs, Allan, *Great Streets*, MIT Press, Cambridge, MA, 1994.

National Highway Institute, U.S. Department of Transportation, Federal Highway Administration, and National Highway Traffic Safety Administration, *Pedestrian and Bicyclist Safety and Accommodation*, Publication No. FHWA-HI-96-028, May 1996.

National Highway Traffic Safety Administration, *Traffic Safety Facts*, updated yearly.

Oregon Department of Transportation, *Oregon Bicycle and Pedestrian Plan*, 1995.

Rodale Press, Inc., *Pathways for People*, June 1992.

Route 50 Corridor Coalition, *A Traffic-Calming Plan for Virginia's Rural Route 50 Corridor*, Middleburg, VA, 1996.

Seiderman, Cara, "Traveling at the Speed of Life," In *Conservation Matters* No. 4 (Autumn 1997) pp. 20-23.

Standards Association of Australia, *Australian Standard: Manual of Uniform Traffic Control Devices, Part 13: Local Area Traffic Management*, North Sydney, Australia, 1991.

Transportation Association of Canada and the Canadian Institute of Transportation Engineers, *Canadian Guide to Neighbourhood Traffic Calming*, December 1998.

U.S. Access Board, *Accessible Rights-of-Way: A Design Guide*, Washington, DC, 1998.

U.S. Department of Transportation and Rails to Trails Conservancy, *Improving Conditions for Bicycling and Walking: A Best Practices Report*, January 1998.

Whyte, William H., *City: Rediscovering the Center*, Anchor Books, Doubleday, 1988.

Resources on the World Wide Web

There are dozens of websites that contain information on pedestrian safety and mobility. About 75 of these sites (with hot links) may be found through the Pedestrian and Bicycle Information Center (PBIC) at the following address:

www.walkinginfo.org

The links on the PBIC website are organized by category (e.g., government agencies and offices, professional organizations), and are as follows:

Government Agencies and Offices

Danish Road Directorate
Federal Highway Administration (FHWA)
FHWA Office of Highway Safety
FHWA/NHTSA National Crash Analysis Center

House Committee on Transportation and Infrastructure
National Highway Traffic Safety Administration (NHTSA)
Transportation Association of Canada
U.S. Architectural and Transportation Barriers Compliance Board (Access Board)
U.S. Department of Transportation (U.S. DOT)

Government Programs and Initiatives

FHWA Bicycle and Pedestrian Program
FHWA Pedestrian and Bicycle Safety Research Page
NHTSA National Child Passenger Safety Week Walkability Checklist
NHTSA Pedestrians, Bicycles, and Motorcycles Page
Office of Highway Safety Pedestrian/Bicyclist Safety Program
Pedestrian Safety Roadshow
Transportation Equity Act for the 21st Century (TEA-21)

Professional Organizations

America Walks Checklist
American Association of State Highway and Transportation Officials (AASHTO)
American Planning Association (APA)
American Public Works Association
American Traffic Safety Services Association
Association of Pedestrian and Bicycle Professionals (APBP)
Bicycle Federation of America/National Center for Bicycling and Walking
Human-Powered Transportation Committee of the American Society of Civil Engineers
Institute of Transportation Engineers
League of American Bicyclists
National Bicycle and Pedestrian Clearinghouse
National Safety Council
National Safety Council Highway Traffic Division
National Safety Council Partnership for a Walkable America
Transportation Research Board

Other Organizations (Including Advocacy Organizations)

AAA Foundation for Traffic Safety
America WALKs
American Council of the Blind — Pedestrian Safety
Bicycle Helmet Safety Institute
Better Environmentally Sound Transportation
Chainguard — Bicycle Advocacy Online
Coalition for Alternative Transportation
Conservation Law Foundation
List of Pedestrian Associations
Massachusetts Bicycle Coalition
National Transportation Enhancements Clearinghouse
Partnership for a Walkable America
Pedestrians Educating Drivers on Safety, Inc. (PEDS)

Rails to Trails Conservancy
Roundabout Traffic Control Information Center
Surface Transportation Policy Project
Transportation Action Network (TransAct)
Transportation Alternatives Citizens Group (New York City Area)
Travis County (Austin, TX) SuperCyclist Project
Tri-State Transportation Campaign (New York/New Jersey/Connecticut)
Vermont Bicycle and Pedestrian Coalition
Victoria Policy Institute
WALK Austin
Walkable Communities, Inc.

Local/State Sites

City of Boulder, CO, Transportation Planning
City of Cambridge, MA, Environmental and Transportation Division
City of Portland, OR, Pedestrian Transportation Program
City of Tallahassee, FL, Bike and Pedestrian Program
Florida Department of Transportation Pedestrian and Bicycle Safety Program
Montgomery County, MD, Residential Traffic-Calming Program
New York City Department of Transportation Pedestrian Information
Oregon Department of Transportation Bicycle and Pedestrian Program
St. Louis Regional Bicycle and Pedestrian Advisory Committee
Wisconsin Department of Transportation Bicycle and Pedestrian Information

Pedestrian and Bicycle Link Pages

Bicycle advocacy websites provided by Chainguard
Bicycle education and safety sites provided by Chainguard
Bicycling organizations and resources provided by Bicycles, Inc.
Bicycling sites provided by Cyber Cyclery
Government sites for bicycle issues provided by Chainguard
Pedestrian and bicycle sites provided by TransAct
Pedestrian issues and organization provided by PEDS
State bicycle laws provided by Bicycle Coalition of Massachusetts

Pedestrian and Bicycle Studies and Statistics

Bike Plan Source Hot Topics provided by Tracy-Williams Consulting
BTS National Transportation Library Links to Pedestrian Transportation Research
BTS National Transportation Library Links to Bicycle Transportation Research
Bureau of Transportation Statistics
Consumer Product Safety Commission Recreational Safety Publications
National Bicycling and Walking Study Five-Year Status Report
Nationwide Personal Transportation Survey
Northwestern University Traffic Institute
PedSMART — Application ITS Technology to Pedestrian Safety
University of North Carolina Highway Safety Research Center

References

Chapter 1 — The Big Picture

1. United States Department of Transportation, Bureau of Transportation Statistics, *1995 Nationwide Personal Transportation Survey*.
2. Appleyard, Donald, *Livable Streets*, University of California Press, Berkeley, 1981.
3. American Association of State Highway and Transportation Officials, *Roadside Design Guide*, Washington, DC, October 1988.
4. Axelson, P. et al., *Designing Sidewalks and Trails for Access*, Federal Highway Administration, Washington, DC, July 1999.

Chapter 2 — Pedestrian Crash Factors

1. Zegeer, C.V. and C.B. Seiderman, "Designing for Pedestrians," Chapter 19, *Traffic Safety Toolbox – A Primer on Traffic Safety*, Institute of Transportation Engineers, 1999.
2. National Highway Traffic Safety Administration, *Traffic Safety Facts*, Washington, DC, 1999.
3. Zegeer, C., J. Stutts, H. Huang, M. Zhou, and E. Rodgman, *Analysis of Elderly Pedestrian Accidents and Recommended Countermeasures*, Transportation Research Board, Washington, DC, 1993.
4. Campbell, B., C. Zegeer, H. Huang, and M. Cynecki, *Pedestrian Safety Research in the U.S.*, Federal Highway Administration, Washington, DC, October 1999.
5. Williams, A. and A. Lund, "Alcohol Impaired Driving and Crashes Involving Alcohol in the United States During the 1970s and 1980s," Paper presented at the 11th International Conference on Alcohol, Drugs and Traffic Safety, Chicago, Illinois, National Safety Council, 1990.
6. National Highway Traffic Safety Administration, *Fatal Accident Reporting System 1989 — A Decade of Progress*, Washington, DC, 1990.
7. U.K. Department of Transportation, *Killing Speed and Saving Lives*, London, 1987.
8. Zegeer, C., J. Stutts, and W. Hunter, *Pedestrian and Bicycle, Volume VI: Safety Effectiveness of Highway Design Features*, Report No. FHWA-RD-91-049, Federal Highway Administration, Washington, DC, November 1992.
9. National Highway Traffic Safety Administration, *General Estimates System 1989 — A Review of Information on Police-Reported Traffic Crashes in the United States*, Washington, DC, 1990.
10. National Safety Council, *Accident Facts*, Washington, DC, 1988.
11. Snyder, M., and R. Knoblauch, *Pedestrian Safety: The Identification of Precipitating Factors and Possible Countermeasures* (2 Vols.), Report No. DOT-HS-800-403, NHTSA, Washington, DC, January 1971.
12. Knoblauch, R., W. Moore, Jr., and P. Schmitz, *Pedestrian Accidents Occurring on Freeways: An Investigation of Causative Factors, Accident Data*, Report No. FHWA-RD-78-159/171, Federal Highway Administration, Washington, DC, 1978.
13. Knoblauch, R., *Causative Factors and Countermeasures for Rural and Suburban Pedestrian Accidents: Accident Data Collection and Analyses*, Report No. DOT HS-802-266, NHTSA, Washington, DC, June 1977.
14. Hunter, W., J. Stutts, W. Pein, and C. Cox, *Pedestrians and Bicycle Crash Types of the Early 1990s*, Report No. FHWA-RD-95-163, Federal Highway Administration, Washington, DC, June 1996.

Chapter 3 – Selecting Pedestrian Safety Improvements

1. Zegeer, C. and C. Seiderman, "Designing for Pedestrians," Chapter 19, *The Traffic Safety Toolbox — A Primer on Traffic Safety*, Institute of Transportation Engineers, 1999.
2. Zegeer, C.V. and S.F. Zegeer, *Pedestrians and Traffic Control Measures*, NCHRP Synthesis of Highway Practice No. 139, Transportation Research Board, November 1988.
3. Zegeer, C., "Engineering and Physical Measures to Improve Pedestrian Safety," in *Effective Highway Accident Countermeasures*, U.S. Department of Transportation, Washington, DC, August 1990.
4. Zegeer, C. and S. Zegeer., "Engineering: Designing a Safer Walking Environment," *Traffic Safety*, Vol. 88, No. 1 (January/February 1988).

Chapter 4A – Pedestrian Facility Design

1. Campbell, B., C. Zegeer, H. Huang, and M. Cynecki, *Pedestrian Safety Research in the U.S.*, Federal Highway Administration, Washington, DC, October 1999.
 2. Institute of Transportation Engineers, *Design and Safety of Pedestrian Fatalities*, March 1998.
 3. Federal Highway Administration, *Manual on Uniform Traffic Control Devices for Streets and Highways*, Federal Highway Administration, Washington, DC, 1988.
 4. Zegeer, C., J. Stuart, and H. Huang, *Safety Effects of Marked vs. Unmarked Crosswalks at Uncontrolled Crossing Locations*, Federal Highway Administration, Washington, DC, 2001.
 5. Moore, R.I. and S.J. Older, "Pedestrians and Motorists Are Compatible in Today's World," *Traffic Engineering*, Institute of Transportation Engineers, Washington, DC, September 1965.
 6. Bowman, B.L., J.J. Fruin, and C.V. Zegeer, *Planning, Design, and Maintenance of Pedestrian Facilities*, Report No. FHWA-IP-88-019, Federal Highway Administration, October 1988.
- Allos, A.E., "Usage of Pedestrian Footbridges," *Traffic Engineering and Control*, Great Britain, May 1983.
- American Association of State Highway and Transportation Officials, *A Policy on Geometric Design of Highways and Streets*, Washington, DC, 1990.
- Axler, E.A., *Warrants for Pedestrian Over and Underpasses*, Report No. FHWA/RD-84-082, Federal Highway Administration, Washington, DC, July 1984.
- Berger, W.G., *Urban Pedestrian Accident Countermeasures Experimental Evaluation, Volume 1: Behavioral Evaluation Studies*, National Highway Traffic Safety Administration and Federal Highway Administration, February 1975.
- Bowman, B.L., J. Fruin, and C.V. Zegeer, *Handbook on Planning, Design and Maintenance of Pedestrian Facilities*, Federal Highway Administration, March 1989.
- Braun, R.R. and M.F. Roddin, *Quantifying the Benefits of Separating Pedestrians and Vehicles*, NCHRP No. 189, Transportation Research Board, Washington, DC, 1978.
- City of Long Beach Crosswalk and Pedestrian Safety Study Final Report*, Willdan and Associates, Industry, California, February 1986.
- Federal Register, Part IV*, Volume 58, No. 173, Department of Transportation, September 6, 1991.
- Fitzpatrick, K., K. Hall, D. Perkinson, R.L. Nowlin, and R. Koppa, *Guidelines for the Location and Design of Bus Stops*, TCRP Report 19, 1996.
- Florida Department of Transportation, *Recommended Design Standards for the Florida Pedestrian Design Standards Development Study: Policy Report*, March 1988.

- Hermes, B.F., *Pedestrian Crosswalk Study: Accidents in Painted and Unpainted Crosswalks*, (HRR 406), Highway Research Board, Washington, DC, 1972.
- Institute of Transportation Engineers, *Guidelines for Residential Subdivision Street Design* (ITE recommended practice), Washington, DC, 1993.
- Institute of Transportation Engineers, *Guidelines for Urban Major Street Design* (ITE recommended practice), Washington, DC, 1984.
- Institute of Transportation Engineers, *Pedestrian Overcrossings — Criteria and Priorities* (Technical Committee Report 4EA), October 1972.
- Institute of Transportation Engineers, *Traffic Engineering Handbook*, Prentice-Hall, Inc., Second Edition, 1982.
- Knoblauch, R.L., *Urban Pedestrian Accident Countermeasures Experimental Evaluation, Volume II: Accident Studies*, National Highway Traffic Safety Administration and Federal Highway Administration, February 1975.
- Knoblauch, R.L. and K.L. Crigler, *Model Pedestrian Safety Program User's Guide Supplement*, Federal Highway Administration, July 1987.
- Knoblauch, R.L., B.H. Tustin, S.A. Smith, and M.T. Pietrucha, *Investigation of Exposure-Based Pedestrian Areas: Crosswalks, Sidewalks, Local Streets and Major Arterials*, Report No. FHWA/RD-88/038, Federal Highway Administration, Washington, DC, September 1988.
- Lindley, J.A., *A Method for Evaluating the Feasibility of Grade-Separated Pedestrian Crossings*, 1986 Annual TRB Meeting, Transportation Research Board, Washington, DC.
- Prokopy, J.C., *A Manual for Planning Pedestrian Facilities*, Report No. DOT-FHWA-74-5, Federal Highway Administration, Washington, DC, June 1974.
- Richter, R.A. and C.L. King, *Guidelines for Making Crossing Structures Accessible — An Implementation Manual*, Report No. FHWA/IP-84/6, U.S. Department of Transportation, Washington, DC, August 1980.
- Rodding, M.F., *A Manual to Determine the Benefits of Separating Pedestrians and Vehicles*, NCHRP Report No. 240, Transportation Research Board, Washington, DC, November 1981.
- Smith, S.A. and R.L. Knoblauch, *Guidelines for the Installation of Crosswalk Markings*, (TRR 1141), Transportation Research Board, Washington, DC, 1987.
- Van Der Boordt, D.J., "Underpasses for Pedestrians and Cyclists — User Requirements and Implications for Design," *Transportation Planning and Technology*, Vol. 8, 1983.
- Zegeer, C.V. and S.F. Zegeer, *Pedestrians and Traffic Control Measures*, NCHRP Synthesis of Highway Practice No. 139, Transportation Research Board, November 1988.

Chapter 4B – Roadway Design

- American Association of State Highway and Transportation Officials (AASHTO), *Guide for the Development of Bicycle Facilities*, Washington, DC, 1999.
- American Association of State Highway and Transportation Officials, *A Policy on Geometric Design of Highways and Streets*, Washington, DC, 1994.
- Federal Highway Administration, *Designing Sidewalks and Trails for Access, Part I*, Washington, DC, 1999.
- Federal Highway Administration, *Older Pedestrian Characteristics for Use in Highway Design*, Report No. FHWA-RD-93-177, Washington, DC, 1993.

Federal Highway Administration, *Priorities and Guidelines for Providing Places for Pedestrian to Walk Along Streets and Highways*, Washington, DC, September 15, 1999 (draft).

Institute of Transportation Engineers, *Guidelines for Residential Subdivision Street Design: An ITE Recommended Practice*, Washington, DC, 1993.

Institute of Transportation Engineers, *Guidelines for Urban Major Street Design: An ITE Recommended Practice*, Washington, DC, 1984.

ITE Transportation Planning Council Committee, *Traditional Neighborhood Development: Street Design Guidelines*, 1997.

Oregon Department of Transportation, *Oregon Bicycle and Pedestrian Plan*, 1995.

Untermann, Richard K., *Accommodating the Pedestrian*, Van Nostrand Reinhold Company, Inc., New York, 1984.

U.S. Access Board and Federal Highway Administration, *Accessible Rights-of-Way: A Design Guide*, Washington, DC, November 1999.

U.S. Architectural and Transportation Barriers Compliance Board (The Access Board), *Accessible Rights-of-Way: A Design Guide* (draft), Washington, DC, May 1999.

Zegeer, C., J. Stutts, and W. Hunter, *Pedestrian and Bicyclists, Volume VI: Safety Effectiveness of Highway Design Features*, Report No. FHWA-RD-91-049, Federal Highway Administration, Washington, DC, November 1992.

Chapter 4C – Intersection Design

Bentzen, B. and L. Tabor, *Accessible Pedestrian Signals*, Publication A37, U.S. Architectural and Transportation Barriers Compliance Board, Washington, DC, August, 1998.

Bowman, B.L., J.J. Fruin, and C.V. Zegeer, *Handbook on Planning, Design, and Maintenance of Pedestrian Facilities*, Report No. FHWA-IP-88-019, Federal Highway Administration, Washington, DC, March 1989.

Zegeer, C.V. and M.J. Cynecki, *Methods of Increasing Pedestrian Safety at Right-Turn-on-Red Intersections*, Report No. FHWA/RD-85/047, Federal Highway Administration, Washington, DC, March 1985.

Zegeer, C.V., K.S. Opiela, and M.J. Cynecki, *Pedestrian Signalization Alternatives*, Report No. FHWA/RD-83-102, Federal Highway Administration, Washington, DC, 1983.

Van Houten, Ron et al., *Field Evaluation of a Leading Pedestrian Interval Signal Phase at Three Urban Intersections*, Insurance Institute for Highway Safety, Arlington, VA, April 1997.

Van Houten, Ron et al., *Use of Animation in LED Pedestrian Signals to Improve Pedestrian Safety*, Insurance Institute for Highway Safety, Arlington, VA, 1998.

Chapter 4D – Traffic Calming

1. Institute of Transportation Engineers, *Traffic Calming: State of the Practice*, August 1999.
2. Zegeer, C.V., J. Stuart, and H. Huang, *Safety Effects of Marked vs. Unmarked Crosswalks at Uncontrolled Crossing Locations*, Federal Highway Administration, Washington, DC, 1999.
3. Institute of Transportation Engineers and the Federal Highway Administration, *Traffic Calming State of the Art*, August 1999.
4. City of Cambridge, MA, *Preliminary Results: Effects of Columbia Street Traffic Calming Project on Driver*

Behavior, April 2000.

American Association of State Highway and Transportation Officials, *A Policy on the Geometric Design of Highways and Streets*, Washington, DC, 1990.

Appleyard, Donald, *Livable Streets*, University of California Press, Berkeley, 1981.

Beukers, B., P. Bosselmann, E. Deakin, W. Nomburger, and P. Smith, *Residential Street Design and Traffic Control*, Review Draft, Institute of Transportation Engineers, July 1986.

Bowman, B.L. and R.L. Vecellio, *Investigation of the Impact of Medians on Road Users*, Report No. FHWA-RD-93-130, Federal Highway Administration, Washington, DC, 1993.

CART – Citizens Advocating Responsible Transportation, *Traffic Calming – The Solution to Urban Traffic and a New Vision for Neighborhood Livability*, Ashgrove, Australia, 1989 (reprinted by Sensible Transportation Options for People (STOP), Oregon, 1993).

Clarke, A. and Dornfeld, M., *National Bicycle and Walking Study: Case Study 19: Traffic Calming*, Report No. PD-93-028, Federal Highway Administration, January 1994.

County Surveyors Society, *Traffic Calming in Practice*, Landor Publishing Ltd., 1994.

Denmark Ministry of Transport, Traffic Safety and Environment, Road Directorate, *Pedestrian Safety: Analyses and Safety Measures*, Report No. 148, 1998.

Devon County Council Engineering & Planning, *Traffic Calming Guidelines*, Great Britain, 1991.

Engwicht, David, *Reclaiming Our Cities and Towns: Better Living With Less Traffic*, New Society Publishers, Philadelphia, PA, 1993.

Ewing, R. and C. Kooshian, "U.S. Experience With Traffic Calming," *ITE Journal*, August 1997, pp. 28-33.

Federal Highway Administration, *Manual on Uniform Traffic Control Devices for Streets and Highways*, 1988.

Federal Highway Administration, *Traffic Calming, Auto-Restricted Zones and Other Traffic Management Techniques – Their Effect on Bicycling and Pedestrians, National Bicycling and Walking Study – Case Study No. 19*, 1994.

Hamburger, W. et al., *Residential Street Design and Traffic Control*, Institute of Transportation Engineers, 1989.

Institute of Transportation Engineers, *ITE Journal*, Volume 67, No. 8, August 1997.

Institute of Transportation Engineers, *ITE Journal*, Volume 67, No. 7, July 1997.

ITE Traffic Engineering Council Speed Humps Task Force, *Guidelines for the Design and Application of Speed Humps*, 1997.

Leonard, J. and J. Davis, "Urban Traffic Calming Treatments: Performance Measures and Design Conformance," *ITE Journal*, August 1997, pp. 34-39.

Portland Bureau of Traffic Management, *Reclaiming Our Streets: A Community Action Plan*, Portland, Oregon, February 1993.

Seattle Engineering Department, "Neighborhood Traffic Circles" (video), Seattle, WA, 1991.

Skene, M., G. Chartier, D. Erickson, G. Mack, and R. Drdul, "Developing a Canadian Guide to Traffic Calming," *ITE Journal*, July 1997, pp. 34-36.

Smith, D.T. and D. Appleyard, *State of the Art Report: Residential Traffic Management*, Report No. FHWA-RD-80/092, Federal Highway Administration, Washington, DC, December 1980.

Spielberg, P., *Traffic Engineering for Neo-Traditional Neighborhood Design*, ITE Technical Committee 5P-8, ITE, Washington, DC, February 1994.

Szplett, D. and L. Sale, "Some Challenges in Developing Neo-Traditional Neighborhood Designs," *ITE Journal*, July 1997, pp 42-45.

The Traffic Institute, Urban Street Design Workshop, Northwestern University, May 1988.

Transportation Association of Canada and the Canadian Institute of Transportation Engineers, *Canadian Guide to Neighborhood Traffic Calming*, December 1998.

Transportation Research Board, "*Planning and Implementing Pedestrian Facilities in Suburban and Developing Rural Areas*," National Cooperative Highway Research Program Report 294A, Washington, DC, June 1987.

Zein, Sany R. et al., "Safety Benefits of Traffic Calming," Transportation Research Board 76th Annual Meeting, January 1997.

Zegeer, C., M. Cynecki, J. Fegan, B. Gilleran, P. Lagerwey, C. Tan, and B. Works, *FHWA Study Tour for Pedestrian and Bicyclist Safety in England, Germany and the Netherlands*, Federal Highway Administration, Washington, DC, October 1994.

Chapter 4E – Traffic Management

Denmark Ministry of Transport, Traffic Safety and Environment, Road Directorate, *Speed Management: National Practice and Experiences in Denmark, the Netherlands and in the United Kingdom*, Report No. 167, 1999.

Smith, D. et al., *State-of-the-Art Residential Traffic Management*, Report No. FHWA-RD-80-092, Federal Highway Administration, Washington, DC, December 1980.

Chapter 4F – Signals and Signs

1. Federal Highway Administration, *Manual on Uniform Traffic Control Devices for Streets and Highways*, Washington, DC, 1988.
2. Zegeer, C.V., K.S. Opiela, and M.J. Cynecki, *Pedestrian Signalization Alternatives*, Report No. FHWA/RD-83-102, Federal Highway Safety Administration, Washington, DC, 1983.
3. Van Houten, Ron et al., *Field Evaluation of a Leading Pedestrian Interval Signal Phase at Three Urban Intersections*, Insurance Institute for Highway Safety, Arlington, VA, April 1997.
4. Van Houten, Ron et al., *Use of Animation in LED Pedestrian Signals to Improve Pedestrian Safety*, Insurance Institute for Highway Safety, Arlington, VA, 1998.
5. Hughes, Ronald, H. Huang, C.V. Zegeer, and M. Cynecki, *Evaluation of Automated Pedestrian Detection at Signalized Intersections*, Report No. FHWA/RD-00/097, Federal Highway Administration, Washington, DC, August 2000.
6. Zegeer, C.V. and M.J. Cynecki, *Methods of Increasing Pedestrian Safety at Right-Turn-on-Red Intersections*, Report No. FHWA/RD-85/047, Federal Highway Administration, Washington, DC, March 1985.
7. Van Houten, Ron and J.E. Louis Malenfant, *Canadian Research on Pedestrian Safety*, Report No. FHWA/RD-99/090, Federal Highway Administration, Washington, DC, 1999.

Abrams, C. and S. Smith, *Selection of Pedestrian Signal Phasing* (Transportation Research Record No. 629), Transportation Research Board, 1977.

American Association of State Highway and Transportation Officials, Task Force Right-Turn-on-Red, "Safety and Delay Impacts of Right-Turn-on-Red," Washington, DC, 1979.

Bentzen, Billie and Lee S. Tabor, "Accessible Pedestrian Signals," U.S. Access Board PD-97-0072, 1998,

available at www.access-board.gov/research&training/pedsignals/pedestrian.htm#ACCESSIBLE.

Bowman, B., J. Fruin, and C. Zegeer, *Handbook on Planning, Design and Maintenance of Pedestrian Facilities*, Federal Highway Administration, March 1989.

Federal Highway Administration, *Manual on Uniform Traffic Control Devices for Streets and Highways*, 1988.

Federal Highway Administration, *Traffic Control Devices Handbook*, 1983.

Institute of Transportation Engineers, "Guidelines for Prohibition of Turns On Red" (ITE informational report, ITE Committee 4A-17), *ITE Journal*, February 1984.

Knoblauch R.L. and K.L. Crigler, *Model Pedestrian Safety Program User's Guide Supplement*, Federal Highway Administration, July 1987.

Lalani, N. and B. Baranowski, "Reducing Public Confusion About the Use of Pedestrian Signals." *ITE Journal*, Institute of Transportation Engineers, January 1993.

McGee, H.W., "Accident Experience With Right-Turn-on-Red" (TRR 644), Transportation Research Board, 1976.

Robertson, H.D. "Pedestrian Preferences for Symbolic Signal Displays," *Transportation Engineering*, Volume 47, No. 6, Institute for Transportation Engineers, Washington, DC, June 1977.

Zegeer, C.V., *Feasibility of Roadway Countermeasures for Pedestrian Accident Experience*, (Report P-121), Society of Automotive Engineers, 1983.

Zegeer, C.V. and S.F. Zegeer, *Pedestrians and Traffic Control Measures*, NCHRP Synthesis of Highway Practice No. 139, Transportation Research Board, November 1988.

Chapter 4G — Other Measures

1. Zegeer, C.V. and S.F. Zegeer, *Pedestrians and Traffic Control Measures*, NCHRP Synthesis of Highway Practice No. 139, Transportation Research Board, November 1988.

American Association of State Highway and Transportation Officials, *A Policy of Geometric Design of Highways and Streets*, Washington, DC, 1990.

American Association of State Highway and Transportation Officials, *Roadside Design Guide*, Washington, DC, October 1988.

Bowman, B.L., J. Fruin, and C.V. Zegeer, *Handbook on Planning, Design and Maintenance of Pedestrian Facilities*, Report No. IP-88-019, Federal Highway Administration, March 1989.

Federal Highway Administration, *Manual on Uniform Traffic Control Devices for Streets and Highways*, 1988.

Humphries, J. and T. Darcy Sullivan, *Guidelines for the Use of Truck-Mounted Attenuators in Work Zones*, Record No. 1304, Transportation Research Board, National Research Council, 1991.

Institute of Transportation Engineers, "School Trip Safety Program Guidelines," *ITE Journal*, 1985.

National Cooperative Highway Research Program, *Recommended Procedures for the Safety Performance Evaluation of Highway Appurtenances*, Report No. 230, Transportation Research Board, National Research Council, March 1981.

Shinder, A., H. Robertson, and M. Reiss, *School Trip Safety and Urban Play Areas, Vol. V — Guidelines for the Development of Safe Walking Trips and School Maps*, Report No. FHWA-RD-75-108, Federal Highway Administration, 1975.

U.S. Equal Employment Opportunity Commission and U.S. Department of Justice, *Americans With Disabilities Act Handbook*, Washington, DC, October 1992.

Chapter 5 – Implementation and Resources

Getting Started

The Walkability Checklist can quickly identify some of the more obvious deficiencies in your community.

<http://www.nhtsa.dot.gov/people/injury/pedbimot/ped/walk1.html>

Another useful tool to get things started is to host a pedestrian roadshow or walkability audit in your community.

<http://safety.fhwa.dot.gov/roadshow/walk/overview.html>

<http://www.walkable.org/services/wcaudit.htm>

Access issues:

A good introduction to accessibility and universal design.

<http://www.fhwa.dot.gov/environment/bikeped/access-1.htm>

A more comprehensive set of guidelines for achieving full accessibility from the US Access Board:

<http://www.access-board.gov/news/prowaac.htm>

Aesthetics:

California's Local Government Commission has some great resources on street design and livability.

<http://www.lgc.org/transportation/street.html>

<http://www.lgc.org/center/index.html>

Construction Strategies

Cities such as Seattle, WA, Portland, OR, and Cambridge, MA, have adopted plans and procedures to ensure that pedestrian improvements become a routine activity in new development projects, reconstruction work, and retrofits.

City of Cambridge

<http://www.ci.cambridge.ma.us/~CDD/envirotrans/walking/index.html>

City of Portland

http://www.trans.ci.portland.or.us/Sidewalks_and_Pedestrians.html

City of Seattle

<http://www.ci.seattle.wa.us/td/stdtoc.asp>

Implementation

Federal funding sources are identified in FHWA's guidance on the Transportation Equity Act for the 21st Century.

<http://www.fhwa.dot.gov/environment/bikeped/BP-Broch.htm> (simple brochure)

<http://www.fhwa.dot.gov/environment/bikeped/BP-Guid.htm> (more detailed guidance)

America Walks, a national coalition of pedestrian advocacy groups, has developed a variety of resources that focus on results and implementation.

<http://www.americawalks.org/resources/index.htm>

Pedestrian User Guides and Handbooks

1. Federal Highway Administration, *Implementing Pedestrian Improvements at the Local Level*, Washington, DC, 1998.

2. Florida Department of Transportation, *Florida's Pedestrian Planning and Design Guidelines*, Tallahassee, FL, 1996.
3. Office of Transportation Engineering and Development, Pedestrian Program, *Pedestrian Design Guidelines Notebook*, Portland, OR, 1997.
4. Washington State Department of Transportation, Puget Sound Regional Council, Association of Washington Cities, and County Road Administration Board, *Pedestrian Facilities Guidebook: Incorporating Pedestrians Into Washington's Transportation System*, September 1997.
5. Maricopa Association of Governments, *Pedestrian Area Policies and Design Guidelines*, Phoenix, AZ, October 1995.
6. National Cooperative Highway Research Program, *Planning and Implementing Pedestrian Facilities in Suburban and Developing Rural Areas*, Report 294B, Washington, DC, June 1987.
7. Zegeer, C.V., *Portland Pedestrian Crossing Toolbox for Pedestrian Program*, Bureau of Transportation Engineering and Development, City of Portland, June 1995.
8. School Trip Safety Guidelines, *ITE Journal*, Institute of Transportation Engineers, Washington, DC, 1985.
9. U.S. Department of Justice, *The Americans With Disabilities Act Title II Technical Assistance Manual, Covering State and Local Governments*, November 1993.
10. Design Commission, Engineering Department and Strategic Planning Office, *Making Streets that Work*, Seattle, Washington, April 1995.
11. Public Rights-of-Way Access Advisory Committee, U.S. Access Board, *Building a True Community*, 2001, available at www.access-board.gov/prowac/commrept/index.htm.

International Research Pedestrian User Guides and Handbooks

1. Van Houten, Ron and J.E. Louis Malenfant, *Canadian Research on Pedestrian Safety*, Federal Highway Administration, Washington, DC, January 1999.
2. Cairney, Peter, *Pedestrian Safety in Australia*, Federal Highway Administration, Washington, DC, January 1999.
3. Davies, David G., *Research, Development, and Implementation of Pedestrian Safety Facilities in the United Kingdom*, Federal Highway Administration, Washington, DC, 1999.
4. Federal Highway Administration, *FHWA Study Tour for Pedestrian and Bicyclist Safety in England, Germany, and the Netherlands*, Report No. FHWA/PL-95/006, Washington, DC, 1994.
5. Gilleran, Brian F. and Greg Pates, *Bicycling and Walking in the Nineties and Beyond: Applying Scandinavian Experience to America's Challenges*, Federal Highway Administration, Washington, DC, January 1999.
6. Hummel, T., *Dutch Pedestrian Safety Research Review*, Federal Highway Administration, Washington, DC, January 1999.
7. Road Directorate, Denmark Ministry of Transport, Road Data Laboratory, Road Standard Division, *An Improved Traffic Environment — A Catalogue of Ideas*, Report 106, Copenhagen, Denmark, 1993.

General References

1. Federal Highway Administration, *Integrating Bicycle and Pedestrian Considerations Into State and Local Transportation Planning, Design, and Operations*, National Bicycling and Walking Study – Case Study No. 21, Washington, DC, 1994.

2. Jacobs, Allan B., *Great Streets*, MIT Press, Cambridge, MA, 1993.
3. Burrington, Stephen H., "Restoring the Rule of Law and Respect for Communities in Transportation," *Environmental Law Journal*, Volume 5, No. 3, New York University, 1996.
4. City of Portland, Offices of Transportation, Transportation Engineering and Development, Pedestrian Transportation Program, *Portland Pedestrian Master Plan*, Portland, OR, June 1998.
5. Conservation Law Foundation, *City Routes, City Rights: Building Livable Neighborhoods and Environmental Justice by Fixing Transportation*, June 1998.
6. Denmark Ministry of Transport, Road Directorate, *An Improved Traffic Environment: A Catalogue of Ideas, Traffic Safety and Environment*, 1993.
7. Federal Highway Administration, *Bicycling & Walking in the Nineties and Beyond: Applying the Scandinavian Experience to America's Challenge*, November 1994.
8. Federal Highway Administration, *Flexibility in Highway Design*, Washington, DC, 1997.
9. Federal Highway Administration, *Safety-Effectiveness of Highway Design Features, Volume VI: Pedestrians and Bicyclists*, 1991.
10. Federal Highway Administration, *Study Tour Report for Pedestrian and Bicyclist Safety in England, Germany and the Netherlands*, October 1994.
11. Institute of Transportation Engineers, *The Traffic Safety Toolbox: A Primer on Traffic Safety*, Washington, DC, 1999.
12. National Highway Institute, U.S. Department of Transportation, Federal Highway Administration, and National Highway Traffic Safety Administration, *Pedestrian and Bicyclist Safety and Accommodation*, Publication No. FHWA-HI-96-028, May 1996.
13. National Highway Traffic Safety Administration, *Traffic Safety Facts*, updated yearly.
14. Rodale Press, Inc., *Pathways for People*, June 1992.
15. Seiderman, Cara, "Traveling at the Speed of Life," in *Conservation Matters*, 4 (Autumn 1997), pp. 20-23.
16. U.S. Department of Transportation and Rails to Trails Conservancy, *Improving Conditions for Bicycling and Walking: A Best Practices Report*, January 1998.
17. Whyte, William H., *City: Rediscovering the Center*, Anchor Books, Doubleday, 1998.
18. U.S. Department of Transportation, National Highway Traffic Safety Administration, *Law Enforcement Pedestrian Safety*, DOT-HS-808-008, NTS-23.
19. Federal Highway Administration, *The National Bicycling and Walking Study*, Washington, DC, 1994.
20. Institute of Transportation Engineers, *Transportation Planning Handbook*, Prentice Hall, Englewood Cliffs, NJ, 1999 (Draft).
21. Institute of Transportation Engineers, *Traffic Engineering Handbook*, Prentice Hall, Englewood Cliffs, NJ, 1999 (Draft).
22. National Committee on Uniform Traffic Laws and Ordinances, *Uniform Vehicle Code*, 1992.
23. National Research Council, Transportation Research Board, *Highway Capacity Manual 2000*, Washington, DC, 1999 (Draft).
24. Federal Highway Administration, *A Review of Pedestrian Safety Research in the U.S. and Abroad*, Washington, DC, February 1999.
25. *Pedestrian Facilities for Transit Access Project, Evaluation of Needs and Constraints*, Cambridge Systematics, Inc., June 1996.
26. Reploge, M. and H. Parcells, *Linking Bicycle/Pedestrian Facilities With Transit*, October 1992.

27. Institute of Transportation Engineers, *Design and Safety of Pedestrian Facilities: A Recommended Practice of the Institute of Transportation Engineers*, Washington, DC, March 1998.
28. Knoblauch, R.L., B.H. Tustin, S.A. Smith, and M.T. Petrucha, *Investigation of Exposure-Based Pedestrian Accident Areas: Crosswalks, Sidewalks, Local Streets and Major Arterials*, Report No. FHWA/RD-87-038, Federal Highway Administration, Washington, DC, 1987.
29. Institute of Transportation Engineers, *Transportation and Traffic Engineering Handbook*, Washington, DC, 1990.
30. Smith, S. et al., *Planning and Implementing Pedestrian Facilities in Suburban and Developing Rural Areas*, National Cooperative Highway Research Program Report 294A, Transportation Research Board, Washington, DC, June 1987.
31. National Highway Traffic Safety Administration, *Fatal Accident Reporting System*, Washington, DC, 1992.
32. American Association of State Highway and Transportation Officials, *Standard Specifications for Highway Bridges*, Washington, DC, 1989.
33. American Association of State Highway and Transportation Officials, *Guide Specifications for Bridge Railings*, Washington, DC, 1989.
34. American Association of State Highway and Transportation Officials, *A Policy on Geometric Design of Highways and Streets*, Washington, DC, 1984.
35. American Association of State Highway and Transportation Officials, *Roadway Design Guide*, Washington, DC, 1989.

Appendix A

Pedestrian Facility Case Studies



Photo by Dan Burden

"Woonerfs" or Living Streets

A Retail Woonerf or "Living Street"

Wall Street — Asheville, North Carolina

Wall Street was originally an alley that ran behind downtown businesses in Asheville. The alley was opened to traffic in the 1940s, but vehicle speeds were low and volume was minor because of the narrow street design and a curve.

Over time, several businesses opened with their storefronts in the alley, and Wall Street became an underground arts district. In the 1970s, the street was redeveloped to change the street character into a tourist destination and improve pedestrian amenities. After a decade of decline during redevelopment, Wall Street is now a great place to be. It is home to several businesses, restaurants, a climbing wall, and a church. Although there are no raised sidewalks, the slow vehicle speeds make this street very pedestrian-friendly. The entire street was repaved using cobblestone-like pavers. Everything is at-grade and both sides of the street are separated from possible vehicle use by bollards and lampposts. Parking was added to one side of the street at the request of the merchants, only leaving room for one-way travel at very slow speeds. Wall Street attracts a lot of pedestrian traffic with most people walking in the street.



Asheville's redevelopment caters to pedestrians.

Residential Woonerfs or "Living Streets"

The Cottages and Bridgewalk — Boulder, Colorado

In the early and mid-1980s, two moderate-income housing projects were developed in Boulder based on the Dutch concept of the "woonerf," or living street. The Cottages consists of 40 owner-occupied condominiums, while Bridgewalk has 123 rental units. Each contains a single-loop street that curves through the complex, around bollards and landscaping, to create a space to be shared by pedestrians, bicyclists, and motor vehicles.



The Cottage's shared pedestrian and vehicle space.

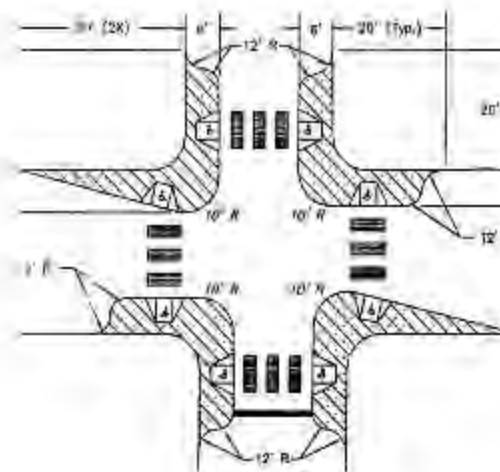
Photos by Dan Burden

Comprehensive Traffic-Calming Projects in Residential Neighborhoods

Raised Intersections, Curb Extensions, Chicanes, and More in a Residential Neighborhood

Cambridge, Massachusetts

Berkshire Street is in a mixed-use residential/commercial neighborhood, and is home to a school, a library, and a playing field. Heavy volumes of children and other pedestrians cross Berkshire Street daily. High speeds were a major problem as many drivers sped on Berkshire and ran stop signs. Several pedestrian collisions had occurred on Berkshire, mostly involving children. A variety of traffic-calming treatments were implemented in 1997, including a raised crosswalk, raised intersections, curb extensions, and a set of mid-block chicanes. Chokers and raised intersections were also installed along nearby streets to slow vehicles and discourage cut-through traffic. The traffic-calming measures were very effective; before the project, only 41 percent of the vehicles were traveling at or below the posted speed limit of 40 km/h (25 mi/h), while afterward, the compliance rate increased to 95 percent. The street improvements have also changed the entire atmosphere of the street, making it more livable and pedestrian-friendly.



City of Cambridge, MA

This set of curb extensions narrows the street width, which shortens the distance pedestrians have to cross; eliminates illegal parking at the intersection; tightens turning radii; and slows traffic, all without eliminating any lanes.

Textured Crosswalk, Median Barrier, and Other Improvements in a Mixed-Use Neighborhood

Portland, Oregon

SW Corbett cuts through a mixed single-family apartment and commercial neighborhood, but it also connects directly to downtown Portland and serves as a de facto collector and commuter route. The neighborhood traffic committee decided that it would be difficult to divert traffic and instead focused on improving the atmosphere for neighborhood pedestrians and bicyclists. Curb extensions, pedestrian refuge islands, a textured crosswalk, a median barrier, three speed humps, and raised pavement markers were installed, and the speed limit was dropped to 40 km/h (25 mi/h). The



Portland Traffic Calming Plan

A comprehensive traffic-calming plan transformed this Portland neighborhood into a more livable place.

improvements reduced speeds along the route and created a friendlier atmosphere for all modes of transportation.

Chicanes, Speed Humps, and Curb Extensions in a Neighborhood

Milvia "Slow" Street — Berkeley, California

In the mid-1980s, residents of Milvia Street in Berkeley were distressed by the all-too-frequent crashes on their street and they worried about the traffic impact of plans to build a new office building. Milvia is a residential street, but has several childcare centers, a preschool, two elementary schools, a junior high school, and a city park nearby. Residents worked with the City and office developer to locate funds for and to design a "slow street," with curb extensions and midblock planters, creating a curvature in the street and one or two speed humps per block over the six-block section. As a result, the street operates at slower speeds and attracts a significant amount of pedestrian and bicycle traffic.



A chicane slows the speed of cars.



Planted islands create safety and scenery.

Citizen Input Creates Solutions

Grand Junction, Colorado

Several years ago, First Street, a rural two-lane road with no curb, gutter, or sidewalks, was beginning to develop speed and congestion problems. After reviewing possible design solutions with the project engineer, the City Council decided that expanding the street to three lanes with medians was the best solution. However, the plans to redesign First Street by expanding the right-of-way were strongly opposed by many of the residents. After several public meetings, the residents convinced the City to make a number of changes to the design plan. In order to reduce the project's impact on people's lives and property, the final design involved the construction of a center turn lane with occasional medians to slow traffic and provide for safe pedestrian crossings. A 1.5-m- (5-ft-) wide sidewalk, cutting back 0.9 m (3 ft) at driveways to ensure a level-cross grade, was installed on both sides of the street, in addition to curbs and 1.5-m-wide gutters for use as bike lanes. In addition, all of the local utilities and irrigation systems were diverted underground and historic lighting fixtures were added.



Wider sidewalks, bike lanes, and raised crosswalks with a crossing island create a safer environment.

Photos by Dan Burden

Midtown Neighborhood Preservation Transportation Plan

Sacramento, California

Residents of the Midtown and East Sacramento neighborhoods were tired of drivers using their neighborhoods as a shortcut downtown. In response, the City Council brought in a consulting firm to work with the community to create a plan for traffic movement within the area. The plan was developed by the community members with guidance from the consultants and was then submitted to the City for approval. The Department of Public Works made a few minor adjustments, but the plan was essentially implemented as designed by the community. The improvements included conversion of two one-way streets with parking to two-lane, two-way streets with parking on each side; five new traffic signals; several additional stop signs; crosswalks; pedestrian crossing islands at intersections; traffic mini-circles; and half-closures. Almost all of the measures were completed by the summer of 1998 at a cost of just over \$1,200,000. The result has been a much more livable and safe neighborhood for these Sacramento residents.



Photo by Herman Huang

Pedestrian crossing islands were a key strategy for reclaiming neighborhood streets.

Neighborhoods Reconnect Along 55th Street

Boulder, Colorado

Fifty-Fifth Street was a busy collector street, providing a direct north/south link between two arterials, carrying a volume of approximately 9,500 vehicles each day. However, the residential neighborhoods on either side of the street were completely isolated due to the lack of pedestrian linkages across 55th Street. In order to reconnect the neighborhoods on both sides of 55th Street, the City installed several raised crosswalks, raised intersections, new sidewalks on either side, and pedestrian crossing islands in order to mitigate the speeding cars. Now, there is much safer pedestrian access on both sides of the street and the once isolated neighborhoods have been reconnected for pedestrian travelers.



City of Boulder, CO

A pedestrian underpass that filled a gap in Boulder's existing trail system.



City of Boulder, CO

A raised intersection reduced traffic speeds and facilitated pedestrian crossings.

Slower Auto Speeds Bring a Neighborhood Back to Life

Naples, Florida

Naples is an affluent coastal residential community that stretches 11.3 km (7 mi) along Florida beaches, but is only 1.6 km (1 mi) wide. Many beach-bound auto travelers cut through and sped through residential neighborhoods. In response, Naples decided to undertake numerous traffic-calming projects in order to slow down speeders and improve the appearance of the community. Seventh Avenue is a residential street that historically has had problems with high through-traffic volumes and speeders. In response, the City implemented a number of different treatments, including three medians to narrow the 1.6-km (1-m) streets and reduce their perceived width. A median was added at the streets' entrances, along with brick pavers to narrow the streets and indicate to drivers that they were entering a residential neighborhood. In addition, several roundabouts were added, an intersection was raised into a speed table and distinguished through brick paving, and extensive landscaping was added to make the street appear narrower and more attractive. As a result, speeds have dropped significantly and the street itself is a much more aesthetically pleasing place for residents and visitors.



Photo by Dan Burden

Bulb-outs and other street-narrowing measures have enhanced the pedestrian environment in Naples, Florida.

Traffic-Calming Strategies Promote Downtown Revitalization

Pedestrian Improvements That Turned Downtown Around

Climata and Narcissus Streets — West Palm Beach, Florida

Downtown West Palm Beach was a notorious area for crime. The wide streets of West Palm Beach were viewed as escape routes by drivers, rushing to get out of downtown, stopping as little as possible. As part of an overall downtown redevelopment strategy, the City of West Palm Beach redesigned its entire downtown with the pedestrian in mind. The Climata/Narcissus Street area became one of the first traffic-calming/redevelopment projects for the City. The streets were narrowed, shifted laterally, and visually calmed through trees, landscaping, and storefront improvements. At the intersections, curb extensions slowed turning traffic and



Photo by Dan Burden

Landscaping and curb extensions create an atmosphere that is friendly to pedestrians as well as cars.

offered improved pedestrian crossing. A public fountain and plaza were built at one intersection, attracting children and families. The pedestrians and shoppers returned, which helped to rejuvenate local business and act as an inspiration for other downtown improvement projects.

Downtown Revitalization Brings Back a Seaside Community

Fort Pierce, Florida

Fort Pierce is a seaside community located along the inter-coastal waterway on the Atlantic Coast of Florida. While Fort Pierce was one of Florida's earliest transportation and commercial hubs, the rapid suburbanization and malling of St. Lucie County in the 1970s helped foster its decline. In the mid-1990s, private and public leaders decided it was time to rebuild their community. Since one of the major stumbling blocks to downtown revitalization was an inhospitable pedestrian environment, a community charette (design workshop) was organized in January 1995 to produce a vision and plan for reconstructing the downtown. The charrette, sponsored jointly by the city of Fort Pierce, the Main Street Fort Pierce Program, and the regional planning agency, resulted in the construction of several major projects within 3 years, including the development of a downtown roundabout and streetscape on Second Street. The streetscape project included the repaving of Second Street, downtown's main road; expanding and retiling all the sidewalks with light colored brick; planting new palm trees; and installing decorative streetlights downtown. The next phase of the project reconfigured the street network of the waterfront area to improve traffic flow, improve the connection between the waterfront and downtown, and open the waterfront for redevelopment. All of the redevelopment improvements have generated significant new activity and interest in downtown.



Improved design and landscaping improve the livability of downtown Fort Pierce.

A Main Street Comes Back to Life

Hendersonville, North Carolina

Due to the construction of a regional shopping mall, the mountain town of Hendersonville, North Carolina, watched its old downtown lose its place as the commercial and social center of the community. At night, the wide and straight roadway became a car race track for local teenagers. Inspired by a trip to Grand Junction, Colorado, local town



Photo by Henry Renske

Curb extensions shorten pedestrian crossing distances and slow down cars.

leaders decided to reinvent Main Street as a specialty shopping center oriented toward out of town visitors. However, the new Main Street first needed to develop an environment that could entice travelers out of their cars. In order to enhance the street for pedestrians, the Main Street was narrowed from four lanes to two. Midblock curb extensions were added, with marked crosswalks at the peak of each extension. The curb extensions shorten pedestrian crossing distances at intersections, improve pedestrian visibility, force tighter/slower right turns onto Main Street, and reinforce the notion that the driver has entered a traffic-calmed area. The area has also been landscaped with signs, flowers, and trees. As a result, Main Street in Hendersonville is once again bustling with pedestrians and shoppers.



Photo by Henry Renske

Newly curved roads force motorists to drive slowly.

Old Town Revival

Eureka, California

In 1976, the Planning and Engineering Departments of Eureka, California, began to work together on the process of revitalizing the city's "Old Town" district. Over the next 2 years, a variety of streetscaping improvements were made to beautify the area and make it more friendly to pedestrians, shoppers, and tourists. This area included a wide variety of shops, historic Victorian houses, and the Carson Mansion. The City installed a variety of treatments along Second Street, including curb extensions; S curves; raised islands; and brick sidewalks, crosswalks, and intersections. In addition, parking was removed from each side of the street and sidewalks were expanded. The Second Street portion of Old Town is now a significant attraction for tourists, as well as for local residents, to visit, walk, and shop. The area has a variety of establishments with sidewalk seating and high pedestrian volumes.



Photo by Dan Burden

Part of Eureka's Second Street features a raised intersection, brick crosswalks, and Carter Mansion in the background.

Pedestrian Promenade Restores Civic Life

Santa Monica, California

The Third Street Promenade was a commercial district made into a pedestrian mall in the 1960s. Over the years, it was neglected and fell into disrepair. In 1989, the City decided to revitalize the area by creating a set of design guidelines that promoted the preservation of historic buildings along Third Street, mandated that new development be on a pedestrian scale, and encouraged the addition of pedestrian amenities by property owners. Even though a road was constructed with removable bollards at the end of each block as



Photo by Dan Burden

View of the Third Street Promenade.

part of the redevelopment project to appease the concerns of business owners, the bollards have never been removed because of the Promenade's overwhelming success as a pedestrian-only space.

School-Related Safety Improvements for Students

Modern Roundabout Near Middle School

Keck Circle — Montpelier, Vermont

At the beginning and ending of the school day, Main Street in Montpelier suffered from congestion as parents dropped off middle school students and drivers sped through a T-intersection crossed by students and senior center residents. To address this problem, the City chose to install a modern roundabout — Keck Circle. The roundabout's design requires that drivers slow to roughly 24 km/h (15 mi/h) when entering the circle, and drivers are warned to watch for pedestrians. In addition, the smooth flow through the roundabout reduced traffic congestion in front of the school.



Photo by Dan Burden

Vehicles must slow down to enter the tight curve of the roundabout, creating a safer interaction with pedestrians.

Pedestrian Refuge Island at Busy Crosswalk Between Park and Boys and Girls Club

Bellevue, Washington

The crosswalk on 100th Avenue in Bellevue links the Boys and Girls Club with Bellevue Downtown Park. In February 1997, a 6-year-old boy was struck while crossing this four-lane street at a crosswalk. Cars in three of the four lanes had stopped, but one had not. Following the crash, the Bellevue Transportation Department replaced one of the two south-bound lanes with a center turn lane. At the crosswalk, this turn lane now contains a pedestrian crossing island, narrowing the street and providing a safe haven for crossing pedestrians.



Photo by Dan Burden

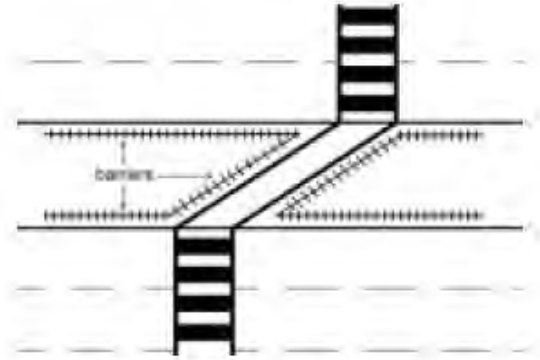
The crossing island allows children to cross the street in two short trips, instead of waiting for a clearing long enough to cross the entire street.

Gated Pedestrian Refuge Island Next to High School

12th Avenue — Tucson, Arizona

Twelfth Avenue is a very busy arterial street, adjacent to a high school. To enter/exit the school, students crossed against speeding traffic, resulting in many near crashes.

Students were also congregating in front of a restaurant directly across from the school entrance, upsetting the restaurant owner. An 26-m- (88-ft-) long median was installed in the center turn lane. The crosswalk was separated into two legs, the first connecting the school entrance with the island, the second connecting the far end of the island to a transit stop farther down the street than the restaurant. The island was gated so that entry and exit are possible only at the two far ends, and the crosswalks were marked with ladder striping and signed with overhead yellow flashers and several crossing signs. The median reduces potential pedestrian/vehicle conflicts by offering mid-street pedestrian refuge. The gated design is effective in channeling pedestrian crossings at the crosswalks and directing students away from the restaurant.



The gates on this pedestrian island require pedestrians to turn right on the island before crossing the second half of the street, which directs their attention to the oncoming traffic.

Sidewalks, Modern Roundabout, and Bike Path Near Several Schools

Grandview Drive — University Place, Washington

The City of University Place decided to begin their pedestrian improvement and traffic-calming program on Grandview Drive, a two-lane residential route that had schools at both ends of the project area, but no sidewalks or other pedestrian amenities. Sidewalks, street trees, curb and gutter, bike lanes, and landscaped medians were added, narrowing the roadway and providing a more attractive, pedestrian-oriented atmosphere. In addition, a roundabout was installed at the busiest intersection, adjacent to two schools. The project has reduced speeds by 8 km/h (5 mi/h) and changed the community's attitudes about traffic calming and pedestrian improvements.



The addition of bicycle lanes and sidewalks create space for pedestrians, while medians and landscaping narrow the street width and slow traffic.

Recycled Bridge Provides Pedestrian Access for Students

Aire Libre Elementary School — Phoenix, Arizona

In the early 1990s, two schools in Phoenix were both in the difficult position of needing a pedestrian bridge. An expressway near Mercury Mine Elementary School was being widened and its bridge would no longer be wide enough. At roughly the same time students at Aire Libre Elementary were running across the Greenway Parkway, which had been built along their route to school. The City opted to move the 65-megagram (72-ton) Mercury Mine bridge 9.7 km (6 mi) to a new site over the Greenway



A recycled bridge provides a safe pedestrian route for students in Phoenix.

Parkway. The new ramps and footings were designed with the help of a local artist to look as if the bridge had always belonged there. This "new" bridge is not only aesthetically pleasing, but reusing this resource was approximately \$500,000 cheaper than building a new bridge for the school.

Other Treatments

Covered Bike Parking That's More Than It Seems

Monroe Street — Corvallis, Oregon

The City of Corvallis determined that it needed to address the growing number of pedestrian injuries in its downtown area. There was also a demand for more bicycle parking on the main commercial corridor bordering Oregon State University. To resolve these problems, the City installed three curb extensions, each containing a covered bike parking structure. The curb extensions improved pedestrian safety by reducing the crossing width of the intersection and providing improved sightlines for pedestrians. Bicycle parking is being used extensively and the covered bicycle parking also serves as a protected bus stop for transit patrons. With strong support for the project from local businesses, there are already plans for several more curb extensions to be installed.



Photo by Dan Burden

Covered bike parking benefits pedestrians as well by creating a narrower crosswalk through curb extensions.

Speed Humps Create Safety on a Residential Street

Tucson, Arizona

Langley Avenue/Kingston Drive is a residential street that was used as a cut-through for commuters. Not only was the street a favorite shortcut for late-night drivers trying to avoid intersections and the police, but there were also several crashes involving speeding vehicles crashing into houses. Since the neighborhood streets had no sidewalks, neighborhood residents avoided walking or bicycling on their own streets due to the large number of speeding motorists. Instead of stop signs, the city engineering department recommended speed humps, and their construction was financed by the residents themselves. Six speed humps were installed, which led to a significant reduction in speeding vehicles, as well as traffic volume. As a result, people feel



Photo by Richard Nassi

Speed humps help prevent speeding in this residential neighborhood.

safe walking, pushing strollers, and letting children ride bikes in the street, even though the neighborhood still has no sidewalks.

Intersections Designed With Safety in Mind Along Springwater Corridor

Portland, Oregon

The Springwater Corridor is a 21-km- (13-mi-) long, 3-m- to 3.7-m- (10-ft- to 12-ft-) wide former railroad right-of-way converted by the City of Portland into a multi-use trail. Since the trail goes through three cities (Portland, Milwaukie, and Gresham) and two counties (Multnomah and Clackamas), it is heavily used by pedestrians, bicyclists, and equestrians for both transportation and recreation. Along the length of the trail, there are several road crossings, from small residential streets to four-lane arterials, so special care was taken to make the crossings as safe as possible for both motorists and non-motorized trail users. While some of the shortest crossings have no markings, others have ladder-style crosswalks, and the largest intersections have signals with pedestrian crossing islands. The signals at these intersections face both motorists and trail users, who can activate the signal by a variety of different methods. Pedestrians can use a traditional pushbutton, bicyclists activate a loop underneath the path, and equestrians can activate a higher pushbutton. The result is a much safer environment for all trail users.



Photo by Dan Burden

Marked crosswalks and signals make intersections safer for pedestrians, bicyclists, and motorists.

Appendix B

Recommended Guidelines/ Priorities for Sidewalks and Walkways



Photo by Dan Burden

I. Introduction

According to the American Association of State Highway and Transportation Officials' (AASHTO) *A Policy on Geometric Design of Highways and Streets* (also known as "the Green Book"): "Providing safe places for people to walk is an essential responsibility of all government entities involved in constructing or regulating the construction of public rights-of-way."

It is a basic principle that there be well-designed, safe places for people to walk along all public rights-of-way. How this will be accomplished will depend upon the type of road, whether it is new construction or a retrofitted area, and funding availability.

On February 24, 1999, Federal Highway Administration (FHWA) Administrator Kenneth R. Wykle, in a memorandum to FHWA field offices, stated, "We expect every transportation agency to make accommodations for bicycling and walking a routine part of their planning, design, construction, operations, and maintenance activities." Again, in February 28, 2000, Administrator Wykle sent a memorandum to the field offices in transmitting the new Design Guidance Language called for in the Transportation Equity Act for the 21st Century (TEA-21). The guidance, entitled "Accommodating Bicycle and Pedestrian Travel: A Recommended Approach – A U.S. DOT Policy Statement on Integrating Bicycling and Walking Into Transportation Infrastructure," states that bicycling and walking facilities will be incorporated into all transportation projects unless "exceptional circumstances" exist. The exceptional circumstances are spelled out, and he asked the division offices to work with State departments of transportation (DOTs) in the implementation of the guidance.

Government agencies at the State, regional, and local level are developing regulations for funding, installing, and retrofitting sidewalks. Because there is a great need to improve sidewalk facilities, it is important for these transportation agencies to direct funding to sidewalk improvement and installation projects that will be most beneficial to the safety and mobility of all citizens.

This document is intended to provide agencies at the State, regional, and local levels with tools they can use to develop guidelines for creating places for people to walk.

This document is limited to creating guidelines for sidewalks, which addresses only one major pedestrian need; other needs that merit further consideration include the ability to cross a street and intersection design.

II. Basic Principles

Many communities may wish to revisit their roadway planning and rehabilitation criteria. Policies, standard plans, subdivision regulations, and right-of-way requirements should be considered to make sure that sidewalks are included in new construction and rehabilitation projects.

A. Goals and Objectives

Typically, communities should focus on: (1) improving conditions for people who are currently walking (including improved accessibility to sidewalk facilities for pedestrians with disabilities), (2) increasing levels of walking, and (3) reducing the number of crashes involving pedestrians. Setting targets will help in the development of criteria for installing and retrofitting sidewalks.

B. Pedestrian Facilities

There are several ways in which pedestrians can be accommodated in the public right-of-way:

1. **Sidewalks.** Sidewalks, provided on both sides of a street, are generally the preferred pedestrian facility. They provide the greatest degree of comfort for pedestrians and the presence of sidewalks has been associated with increased safety for pedestrians. The Uniform Vehicle Code defines a sidewalk as that portion of a street between the curb lines, or the lateral lines of a roadway, and the adjacent property lines, intended for use by pedestrians. In most cases, sidewalks are paved, usually in concrete. To comply with Federal Americans with Disabilities Act (ADA) guidelines, newly constructed sidewalks must be accessible to people with disabilities.
2. **Off-Road Paths.** An off-road path — paved or unpaved — can be an appropriate facility in rural or low-density suburban areas. Paths are generally set back from the roads and separated by a green area or trees. Paths can be flexible in that they can deviate from the exact route of a road in order to provide more direct access for key destinations. Paths that generally follow the roadway alignment are sometimes known as "side paths."
3. **Shoulders.** Wide shoulders on both sides of a road are the minimum requirement for providing at least a possible place for people to walk. They are not as safe as paths or sidewalks, but they are better than nothing. Shoulders are also beneficial for motorists and bicyclists, and future sidewalks or paths should be created in addition to, not to replace the shoulders.
4. **Shared Streets.** In very limited unusual circumstances, it may be possible to allow shared use of a street for people walking and driving. These are usually specially designed spaces such as pedestrian streets or "woonerfs," and guidelines for developing these kinds of places can be found elsewhere in the FHWA's *Pedestrian Facilities Users Guide: Providing Safety and Mobility*.

C. New Construction and Retrofitting

Places for people to walk should be provided in all new construction. Retrofitting will require priorities to be set, and these guidelines are intended to help identify where the need is greatest for adding sidewalks and other facilities.

III. New Construction

A. New Sidewalk Installation

All new construction must include places for people to walk, on both sides of a street or roadway. New construction in urban and suburban areas should provide sidewalks. Recommended guidelines for new sidewalk and walkway installation are given in Table 1.

B. Phased Development of Sidewalks

In developing and rural areas, it may be acceptable — although less desirable — to start with shoulders and unpaved paths and then phase in sidewalks as development accelerates. Criteria for installing sidewalks along with new development should be implemented with the following in mind:

1. **Space for Future Sidewalks:** Space for future sidewalks must always be secured and/or reserved when a new right-of-way is being created or an existing one is being developed. If roadways are to be widened, additional right-of-way must be acquired; existing sidewalks should not be narrowed to accommodate a wider roadway.
2. **"Triggers" for Future Sidewalks:** In rural settings, if sidewalks are not installed at the time of development, guidelines are needed to determine when sidewalks will be required and how they will be funded. For example, sidewalks might be required on residential streets once an area has a density

of more than four dwelling units per acre and on arterial streets once they are within a school walking zone or have transit service.

- 3. Funding for Future Sidewalks:** If sidewalks are not installed at the time of development, there need to be clear regulations as to who (developer, property owners, or governmental agency) will pay for the sidewalks. Whoever is paying for the road must pay for the sidewalk. If there is money for a road, there is money for a sidewalk. Developer contributions to sidewalks must be set aside in an account at the time of development.

C. Retaining Rural Character

There is a desire in some residential developments to retain a rural atmosphere. Very often this occurs in places that are not truly rural, but rather suburban or exurban (they may have been rural before being developed). Frequently, it is in such places that pedestrian crashes occur that are directly attributable to pedestrians not having places to walk. To address both the goal of having safe places to walk and that of the community to retain a certain atmosphere, path systems can be developed that do not look like traditional sidewalks, but do meet walking needs. Even in rural areas, people do want to walk and such facilities should be provided.

Developers in outlying areas may argue that the land use will never fully develop into a pedestrian area. Given that people walk despite not having facilities — for exercise, going to friends' houses, accessing transit, etc. — it is neither rational nor acceptable to build places that do not have places for people to walk. Residential developments that were added in suburban areas, until recently, typically had sidewalks and functioned very well.

Sidewalks may not be needed on short residential cul-de-sacs (61 m [200 ft] or less), if there is a system of trails behind the houses and driveway aprons are properly constructed for pedestrians with disabilities. However, it is not a good practice to have an entire neighborhood without sidewalks.

D. Sidewalk Continuity

Sidewalks should be continuous; interruptions may require pedestrians to cross a busy arterial street mid-block or at an unsignalized location to continue walking. Sidewalks should also be fully accessible to side streets and adjacent sidewalks and buildings.

IV. Retrofitting Sidewalks

Many of the streets built in recent decades do not have sidewalks, and these streets need to be retrofitted. In other cases, existing sidewalks need to be replaced. Establishing priorities for installing sidewalks involves three steps: (1) develop a prioritized list of criteria, (2) develop a methodology for using the criteria to evaluate potential sites, and (3) create a prioritized list of sites for sidewalk improvements.

A. Criteria

The following are suggested criteria for establishing priorities. Select three or more of them when developing your own set of criteria. The key is to select criteria that produce the outcomes desired for your community:

- 1. Speed:** There is a direct relationship between speed and the number and severity of crashes; high-speed facilities may rank higher if speed is a criterion.
- 2. Street Classification:** Arterial streets should take precedence because they generally have higher pedestrian use (due to more commercial uses), have a greater need to separate pedestrians from motor

vehicles (due to higher traffic volumes and speeds), and are the main links in a community.

3. **Crash Data:** Pedestrian crashes seldom occur with high frequency at one location, but there are clearly locations where crashes occur due to a lack of sidewalks. Usually, there is a pattern of pedestrian crashes up and down a corridor, indicating a need to provide sidewalks throughout, not just at crash locations.
4. **School Walking Zones:** School walking zones typically extend from residential areas to an elementary school. Children are especially vulnerable, making streets (especially arterials) in these zones prime candidates for sidewalk retrofitting.
5. **Transit Routes:** Transit riders need sidewalks to access transit stops. Arterials used by transit are prime candidates for sidewalk retrofitting.
6. **Neighborhoods With Low Vehicle Ownership:** Twenty percent of the U.S. population has a disability and 30 percent of our population does not drive. Walking is the primary mode of transportation for many of the people in this country. People with disabilities live throughout the community. If they are not seen in the community, it may be due to the fact that adequate facilities are not provided. In addition, car ownership is lower and crash rates are often higher in low- and moderate-income neighborhoods with lots of children. Therefore, some locations with high pedestrian use (neighborhoods with more children and elderly persons and where vehicle ownership is low) should be given special consideration for sidewalks.
7. **Urban Centers/Neighborhood Commercial Areas:** Areas of high commercial activity generate high pedestrian use, even if they are primarily motorists who have parked their car. Sidewalks are needed to improve safety and enhance the economic viability of these areas.
8. **Other Pedestrian Generators:** Hospitals, community centers, libraries, sports arenas, and other public places are natural pedestrian generators where sidewalks should be given priority.
9. **Missing Links:** Installing sidewalks to connect pedestrian areas to each other creates continuous walking systems.
10. **Neighborhood Priorities:** Local residents may have a sense of where the most desirable walking routes exist. Neighborhood groups or homeowners associations can provide a prioritized list of locations where they see a need for sidewalks. Agencies should be cautious about using this criterion, as it is not desirable to let neighborhood pressure override addressing a key safety concern. However, it may be useful to monitor requests from pedestrians with disabilities.

B. Methodology

The two recommended methodologies for selecting locations for improvements are: (1) the overlapping priorities method, and (2) the points method. Establishing priorities should consume only a small percentage of a program budget — the level of effort put into prioritization should be proportionate to the size of the capital budget.

There is no single right way to select which criteria to use when developing priorities. The criteria and methodology should balance safety measures, such as vehicle speeds and pedestrian crash data; pedestrian usage measures, such as proximity to schools or commercial areas; continuity between origins and destinations; and accessibility for pedestrians with disabilities.

1. **Overlapping Priorities Method:** The easiest and cheapest way to identify overlapping priorities is through graphical representation; the intent is to identify locations that meet multiple criteria. This methodology is especially useful in cases where there is not a lot of staff time and funding for detailed analysis. It can be accomplished using a GIS system or it can be done by hand.

The best way to describe this methodology is by example. Assume that priorities are going to be developed based on transit routes, proximity to schools, people with disabilities, and neighborhood commercial areas. Start with a map of your jurisdiction. Using a color pen, identify those arterials

that have high transit use; draw a half-mile circle around every elementary school and around locations that attract people with disabilities; and color in the neighborhood commercial areas. This visual approach will make areas of overlapping priorities become immediately clear. The streets without side walks within the overlapping areas are the highest priority for retrofitting sidewalks.

- 2. Points Method:** A weighted points system can be used where staff time and funding are available for more detailed analysis, or if there is a large amount of capital available for sidewalk construction. If there are a lot of competing projects, a more sophisticated point system can be used to explain to the public why certain projects were funded and others were not.

A point system can be developed in many ways; the system should be simple and produce desired outcomes. Any and all of the criteria listed above can be assigned a range of numbers and then be used to analyze the need for improvement at given locations. For example, a corridor could be assigned points based on the number of "walking along roadway" crashes over a 5-year period, the number of buses that travel the corridor during peak times, and the proximity to elementary schools. This method is time-consuming because it will be necessary to analyze multiple locations with side walk needs to create a list of priority projects.

- 3. Prioritized List:** Both the overlapping priorities and the points methods will produce an initial list of prioritized projects. The next step is to refine the list so that it works, using common sense. One important consideration is that when roadways are resurfaced, rehabilitated, or replaced, curb ramps must be added if there are pedestrian walkways. In addition, the U.S. Department of Justice considers bus stops to be pedestrian walkways requiring access for people with disabilities, so areas near transit should be given priority accordingly. Improving pedestrian crossings, particularly on arterial streets, may also be an important part of some projects. Other important questions include: Are priority locations ones that might be expected? Are there many surprises? Are priority locations in line with community priorities and expectations? Are some priorities at locations with very low pedestrian use? If the answer to these questions is "yes," then the criteria or the methodology should be evaluated and possibly revised to create outcomes that better reflect expectations and desires. The methodologies should be used to prioritize known needs, not to create a new set of priorities that don't make sense.

The final step is to create packages of fundable projects. The prioritization process should result in reasonable packages that decision-makers can embrace and support. For example, it may be possible to install sidewalks on both sides of every arterial within a half-mile of every elementary school for \$5 million over a period of 5 years. Or, it may be possible to replace sidewalks in neighborhood commercial areas for \$2 million over a period of 3 years. The objective is to take what may appear to be an unsolvable problem (endless need for more funds) and to package it in such a way that it begins to address some of the most critical pedestrian needs in a community.

V. Sidewalk Design Guidelines

Sidewalk Placement in Large and Small Cities

Continuous sidewalks should be placed along both sides of all fully improved arterial, collector, and local streets in urban and suburban areas. Sidewalks should connect to side streets and adjacent buildings. Accessible crossings should be provided across median islands, frontage road medians, and other raised islands.

Seattle Example

Seattle recently completed an inventory of all sidewalks in the city using a three-step process:

1. An intern was hired to review aerial photographs to determine whether a sidewalk existed. This information was then recorded as a new layer on the existing GIS street database.
2. The intern field-checked all locations where there was some uncertainty regarding the presence of a sidewalk (about 10 percent of the aerial photographs were not clear).
3. Each of 13 neighborhood groups that cover the city were given a draft copy of the inventory and were asked to check for errors.

The total effort took the equivalent of one full-time person working for 6 months in a city of 530,000 population, 218.3 km² (84.3 mi²) of land use and 2,659 roadway kilometers (1,652 roadway miles) [1,934 residential street kilometers (1,202 residential street miles) and 724 arterial kilometers (450 arterial miles)]. Once the inventory was completed, the information was combined on a map with three other types of information:

- 1. School Walking Zones:** A colored circle identified a half-mile area around each school.
- 2. Pedestrian Generators:** A second color was used to identify a half-mile area around key pedestrian generators, such as hospitals, libraries, and community centers.
- 3. Neighborhood Commercial Areas:** A third color was used to identify the dozen neighborhood commercial areas in Seattle (about one for each of the major neighborhood areas).

Once the map was printed, it was very easy to see where the three colors overlapped, two colors overlapped, etc. The final step was to have the computer calculate the sidewalk deficiencies in the overlapping areas. They found, for example, that there were less than 3 km (2 mi) of arterial streets that were within school walking zones, a pedestrian generator area, and a neighborhood commercial area that did not have sidewalks on either side of the street.

There were nearly 4.8 km (3 mi) of arterial streets that were within school walking areas, but outside of neighborhood commercial areas and pedestrian generators that did not have sidewalks on either side of the street. This was compared to a citywide deficiency of more than 32 km (20 mi) of arterial streets that lacked sidewalks on both sides of the street.

By developing these and other numbers, the pedestrian program was able to put together packages of information that demonstrated what could be accomplished with additional funding. What everyone thought to be an unsolvable multi-million-dollar problem was reduced to a series of smaller, fundable projects that decisionmakers could endorse. The result was increased funding and a new optimism that meaningful progress could be made on solving Seattle's sidewalk deficiencies.

Sidewalks, Walkways, and Shoulders in Rural Areas

A safe walking area must be provided outside the motor vehicle traffic travelway. Sidewalks along rural roads should be well separated from the travelway. Isolated residential areas should have a pedestrian connection to the rest of the rural community for school access, shopping, and recreational trips.

An off-road path — also known as a "side path" — is a type of walkway used in some rural settings. This path may be paved or unpaved, and is separated from the roadway by a grass or landscaped strip without curbing. This maintains a rural look, but is safer and more comfortable than a shoulder.

A paved or unpaved shoulder should be provided as a minimum along the road. Paved shoulders are pre-

ferred to provide an all-weather walking surface, since they also serve bicyclists and improve the overall safety of the road. A 1.5-m- (5-ft-) wide shoulder is acceptable for pedestrians along low-volume rural highways. Greater width, up to 2.4 to 3.0 m (8 to 10 ft), is desirable along high-speed highways, particularly with a large number of trucks. An edgeline should be marked to separate the shoulder from the travelway.

Sidewalk Width

The width of a sidewalk depends primarily on the number of pedestrians who are expected to use the sidewalk at a given time — high-use sidewalks should be wider than low-use sidewalks. "Street furniture" and sidewalk cafes require extra width, too. A sidewalk width of 1.5 m (5 ft) is needed for two adult pedestrians to comfortably walk side-by-side, and all sidewalks should be constructed to be at least this width. The **minimum** sidewalk widths for cities large and small are:

- Local or collector streets..... 1.5 m (5 ft)
- Arterial or major streets..... 1.8 to 2.4 m (6 to 8 ft)
- CBD areas.....2.4 to 3.7 m (8 to 12 ft)*
- Along parks, schools, and other major pedestrian generators.....2.4 to 3.0 m (8 to 10 ft)

*2.4-m (8-ft) minimum in commercial areas with a planter strip, 3.7-m (12-ft) minimum in commercial areas with no planter strip.

These widths represent a clear or unobstructed width. Point obstructions may be acceptable as long as there is at least 914 mm (36 in) for wheelchair maneuvering (no less than 1,219 mm (48 in) wide as a whole); however, every attempt should be made to locate streetlights, utility poles, signposts, fire hydrants, mail boxes, parking meters, bus benches, and other street furniture out of the sidewalk. When that is not possible, sidewalk furnishings and other obstructions should be located consistently so that there is a clear travel zone for pedestrians with vision impairments and a wider sidewalk should be provided to accommodate this line of obstructions.

Similarly, when sidewalks abut storefronts, the sidewalk should be built 0.6 m (2 ft) wider to accommodate window-shoppers and to avoid conflicts with doors opening and pedestrians entering or leaving the buildings.

Many 1.2-m (4-ft) sidewalks were built in the past. This width does not provide adequate clearance room or mobility for pedestrians passing in opposite directions. All new and retrofitted sidewalks should be 1.5 m (5 ft) feet or wider.

Sidewalk Buffer Width

Buffers between pedestrians and motor vehicle traffic are important to provide greater levels of comfort, security, and safety to pedestrians. Landscaped buffers provide a space for poles, signs, and other obstructions; they serve as a snow storage area; and they protect pedestrians from splash. The ideal width of a planting strip is 1.8 m (6 ft). Minimum allowable landscape buffer widths are:

- Local or collector streets..... 0.6 to 1.2 m (2 to 4 ft)
- Arterial or major streets..... 1.2 to 1.8 m (4 to 6 ft)

With a landscaped buffer between the sidewalk and the street, care must be taken to ensure that the bus stops are fully accessible to wheelchair users and have connections to the sidewalk. Irrigation may be needed in areas of low precipitation.

Buffers also provide the added space to make curb ramps and landings accessible. When the ramps and landings are designed properly, they are also better utilized by those pushing strollers or pulling carts and luggage.

If a planting strip is not provided between the sidewalk and roadway, then the sidewalk width should be a minimum of 1.8 m (6 ft).

Where landscaped sidewalk buffers cannot be provided due to constraints, on-street parking, a shoulder, or a bike lane can serve to buffer pedestrians from motor vehicle traffic lanes.

Sidewalk Surface

Concrete is the preferred sidewalk surface, providing the longest service life and requiring the least amount of maintenance. Asphalt is an acceptable walkway surface in rural areas and in park settings, and crushed granite may also be an acceptable all-weather material in parks or rural areas, but they generally require higher levels of maintenance and are less desirable for wheelchair users.

Sidewalks may be constructed with bricks and pavers if they are constructed to avoid settling; bricks should be easy to reset or replace if they cause a tripping hazard. Also, bricks and/or pavers can cause vibrations that are painful for pedestrians who use mobility aids and, therefore, it may be appropriate to use bricks or pavers only for sidewalk borders in certain situations. There are stamping molds that create the visual appearance of bricks and pavers; these have the advantages of traditional concrete without some of the maintenance issues and roughness associated with bricks and pavers. There are commercially available products that produce a variety of aesthetically pleasing surfaces that are almost impossible to distinguish from real bricks and pavers. However, stamped materials can also have maintenance issues, since, for example, the sidewalk may never look the same again after repairs are made.

It is also possible to enhance sidewalks aesthetics while still providing a smooth walking surface by combining a concrete main walking area with brick edging where street furniture (lights, trees, poles, etc.) can be placed. For example, in a CBD, a 4.6-m (15-ft) total sidewalk width might include a 2.4-m (8-ft) clear concrete sidewalk with a 2.1-m (7-ft) edge.

Sidewalk Grade and Cross-Slopes

Sidewalks should be built to accommodate all pedestrians and should be as flat as practical. Sidewalks should be held to a running grade of 5 percent or less, if possible. However, sidewalks that follow the grade of a street in hilly terrain cannot meet this requirement, for obvious reasons, and may follow the grade of the street. The maximum grade for a curb ramp is 1:12 (8.3 percent).

The maximum sidewalk cross-slope is 1:50 (2 percent) to minimize travel effort for wheelchair users and still provide drainage. At least 0.9 m (3 ft) of flat sidewalk area is required at the top of a sloped driveway to accommodate wheelchair use. In some cases, it may be necessary to bend the sidewalk around the back of the driveway to achieve a level surface of 0.9 m (3 ft).

Curb Ramps

Curb ramps must be provided at all intersection crossings (marked or unmarked) and midblock crosswalks for wheelchair access. These ramps also accommodate strollers, carts, the elderly, and pedestrians with mobility limitations. Curb ramps should be as flat as possible, but must have a slope no greater than 1:12

(8.3 percent). Abrupt changes in elevation at the top or bottom should be avoided. The minimum curb ramp width is 914 mm (36 in); however, 1,219 mm (48 in) is the desirable minimum. If a curb ramp is located where pedestrians must walk across the ramp, the ramp must have flared sides of no more than 1:10 (10 percent) slope. These flares are not needed where ramps are placed in a landscaped area. Curb ramps also require a minimum of 914 mm (36 in) of level and clear passage (1,219 mm (48 in) or more are desirable) at the top.

Two separate curb ramps, one for each crosswalk, should be provided at each corner of an intersection. Diagonal curb ramps provide no directional guidance to vision-impaired pedestrians, and force wheelchair users to maneuver in the crosswalk. Raised islands in a crossing must have at least a 1,219-mm (48-in) cut-through that is level with the street; this is generally preferable to curb ramps, which force wheelchair users to go up and down.

Obstacles Along the Sidewalk

The distance to the bottom of signs placed in or right next to a sidewalk should be at least 2 m (7 ft) above the sidewalk surface to avoid injury to pedestrians. Bushes, trees, and other landscaping should be maintained to prevent encroachment into the sidewalk. Jurisdictions should adopt ordinances requiring local property owners to trim the landscaping they place along their frontage to maintain clear and unobstructed sidewalks. The jurisdictions should provide an inspection procedure or a system of responding to sidewalk encroachment and maintenance complaints.

Guy wires and utility tie-downs should not be located in or across sidewalks at heights below 2 m (7 ft). When placed adjacent to sidewalks or pedestrian walkways, the guy wires should be covered with a bright yellow (or other high-visibility) plastic guard to make the wire more visible to pedestrians. Guy wires of any color will not be visible to blind pedestrians and must not be located within the pedestrian route. Other obstacles include signal controller boxes, awnings, temporary signage, newspaper racks, fire hydrants, and similar items.

Accessibility

The easiest way to visualize accessibility requirements (grade, cross-slope, and clear width) is with the concept of a "continuous passage." Sidewalks must provide a continuous route at a 2 percent maximum cross-slope at a minimum width of 0.9 m (3 ft). This does not mean that 0.9 m (3 ft) is an acceptable sidewalk width, just that at no point shall the level area be less than 0.9 m (3 ft) wide; this applies mainly at obstructions, driveways, and curb ramps.

Snow

Municipalities that do not remove snow on sidewalks should have an ordinance requiring property owners to clear the snow and keep the sidewalks accessible to pedestrians. When the latter is the case, municipalities should educate property owners as to why this is important and have enforcement efforts in place to ensure compliance.

Bus Stops and Shelters

It is generally preferable to place bus shelters between the sidewalk and the street, or between the sidewalk

and adjacent property, so that waiting passengers do not obstruct the flow of pedestrians along the sidewalk. Benches and other street furniture should be placed outside the walking paths to maintain the accessibility of the walkway and to provide good pedestrian service. In addition, curb ramps should be provided at bus stops because it is not always possible for the bus to pull close enough to the curb to deploy a lift.

Lighting

Good street lighting improves the visibility, comfort, and security of pedestrians. In urban areas, it is important to light at least the intersections and other pedestrian crossing areas. Lighting is also recommended in areas where there is a high concentration of nighttime pedestrian activity, such as churches, schools, and community centers. Where continuous lighting is provided along wide arterial streets, it is desirable to place the lights along both sides of the street. Continuous streetlights should be spaced to provide a relatively uniform level of light. In shopping districts or in downtown areas with high concentrations of pedestrians, it is desirable to provide pedestrian-level lighting in addition to the street lighting to improve the comfort and security of pedestrians. The preferred pedestrian-level lights are mercury vapor or incandescent. Low-pressure sodium lights may be more energy-efficient; however, they are undesirable because they create considerable color distortion. Pedestrian-level lighting may also be installed in selected areas of pedestrian activity to create a sense of intimacy and place.

Other Design Considerations

Sidewalks should be built within the public right-of-way or in a sidewalk easement along the right-of-way. This will provide access to the sidewalk for maintenance activities and will prevent the adjacent property owners from obstructing or removing the sidewalk in the future.

Care must be taken to avoid planting trees or large bushes in the landscape buffer area that will obscure the visibility between a pedestrian attempting to cross or enter a street and an approaching motorist. Trees with large canopies planted between the sidewalk and street should be generally trimmed up to at least 2.4 m (8 ft) high and bushes should be kept to about 762 to 914 mm (30 to 36 in) in height. Trees with large caliper trunks may not be appropriate near intersections and in other situations where they may block visual sight triangles.

Meandering sidewalks are sometimes used where a wide right-of-way is available and there is a desire to provide a high level of landscaping, such as in a park or along a waterway or other natural feature. It is often believed that meandering sidewalks create a more pleasant walking environment. The reality is that they unnecessarily create a longer walking distance and are inappropriate for sidewalks along a street.

Sidewalks should be built along both sides of bridges. Pedestrian rails or guard rail are required along the outside of the bridge. On bridges with high speeds, concrete barriers between the travelway and the sidewalk may be considered to shield pedestrians from errant vehicles. However, this adds cost, weight, and width to the bridge, and the transition from barrier to guard rail or curb at each end often creates an awkward transition for pedestrians, who must detour around the barrier to access the bridge sidewalk.

Rollover curbs should not be used next to sidewalks as they encourage motorists to park on planting strips or sidewalks. They may be problematic for some visually impaired people, since they don't create a definitive edge between the street and adjacent uses.

Sidewalk Depth: Concrete sidewalks should be built to a minimum depth of 101.6 mm (4 in), and to a minimum depth of 152.4 mm (6 in) at driveways.

VI. Sidewalk Cost Considerations

The actual cost of providing sidewalks will be different for each region of the country and varies with the season. Actual bid prices are also influenced by how busy contractors are at the time of construction.

The cost of constructing sidewalks alone is relatively low; typical bids run between \$24 and \$36 per meters squared (\$20 to \$30 a square yard), which roughly translates to \$43 to \$64 per lineal meter (\$12 to \$20 per lineal foot) for 1.8-m- (6-ft-) wide sidewalks. Therefore, sidewalks on both sides of the roadway can run roughly between \$93,000 and \$155,000 per kilometer (\$150,000 and \$250,000 per mile) (costs from Oregon DOT, 1999).

Factors to consider when calculating the cost of sidewalks:

- 1. Presence of curb and gutter:** The costs of providing curb and gutter, which presumes the need to also provide a street drainage system, run much higher than the cost of sidewalk alone. A standard perpendicular curb ramp and top landing need a minimum border width of almost 3.7 m (12 ft) at intersections if there is a 152.4-mm (6-in) curb. A 152.4-mm (6-in) curb reduces the minimum border width to 3 m (10 ft). Yet, on many urban streets, this work must be performed prior to installing sidewalks. If this is the case, only the cost of sidewalks and curb ramps should be attributed to expenditures for pedestrians – catch basins are provided to drain the roadway surface used by motor vehicle traffic.
- 2. Number of driveways:** To comply with ADA, many existing driveways must be replaced with ones that provide a level passage at least 0.9 (3 ft) wide. It can also be advantageous to inventory all existing driveways to see if any can be closed, resulting in a cost-savings.
- 3. Number of intersections:** While intersections represent a reduction in the sidewalk, curb ramps are required where sidewalks cross intersections and the cost of providing additional traffic control at each intersection should be considered.
- 4. Obstacles to be removed:** The cost for moving or removing obstacles such as utility poles, signposts, and fire hydrants vary too much to be itemized here; however, they are required to be moved if they obstruct access. These costs must be calculated individually for each project.
- 5. Structures:** While minor sidewalk projects rarely involve new structures such as a bridge, many projects with significant cuts and fills may require retaining walls and/or culvert extensions. The costs of retaining walls must be calculated individually for each project.
- 6. Right-of-way:** While most sidewalk projects can be built within existing rights-of-way (especially infill projects), some may require some right-of-way easement. An alternative to acquiring right-of-way is to narrow the roadway, which should consider the needs of bicyclists (e.g., through bike lanes or shoulders, at a minimum of 1.5 m (5 ft)).
- 7. Miscellaneous factors:** Planters, irrigation, benches, decorative lampposts, and other aesthetic improvements cost money, but they are usually well worth it if the impetus for the project is to create a more pleasant and inviting walking environment.

When project costs appear to be escalating due to one or more of the above-listed items, especially retaining walls or acquiring right-of-way, consideration may be given to narrowing the sidewalk in constrained areas as a last resort. The full sidewalk width should be resumed in non-constrained areas — this is preferable to providing a narrow sidewalk throughout, or dropping the project because of one difficult section.

Tips to Reduce Total Costs:

- 1. Stand-alone vs. integrated within another project:** Sidewalks should always be included in road construction projects. Stand-alone sidewalk projects cost more than the same work performed as part of a larger project. Sidewalks can be piggybacked to projects such as surface preservation, water or sewer

lines, or placing utilities underground. Besides the monetary savings, the political fallout is reduced, since the public doesn't perceive an agency as being inefficient (it is very noticeable if an agency works on a road, then comes back to do more work later). The reduced impacts on traffic are a bonus to integration.

- 2. Combining Projects:** A cost-savings can be achieved by combining several small sidewalk projects into one big one. This can occur even if the sidewalks are under different jurisdictions, or even in different localities, if they are close to each other. The basic principle is that bid prices drop as quantities increase.

VII. Bibliography and List of References

American Association of State Highway and Transportation Officials, *A Policy on Geometric Designs of Highways and Streets*, 1984.

Axelson, P. et al., *Designing Sidewalks and Trails for Access*, Federal Highway Administration, Washington, DC, July 1999.

Institute of Transportation Engineers, *Design of Pedestrian Facilities — Recommended Practices: Providing Safety and Mobility*, 2001.

Table 1. Recommended Guidelines for New Sidewalk/Walkway Installation.

Roadway Classification and Land Use	Sidewalk/Walkway Requirements	Future Phasing
Rural Highways (< 400 ADT)	Shoulders preferred, with minimum of 0.9 m (3 ft)	Secure/preserve right-of-way (ROW) for future sidewalks.
Rural Highways (400 to 2000 ADT)	1.5-m (5-ft) shoulders preferred, minimum of 1.2 m (4 ft) required.	Secure/preserve ROW for future sidewalks.
Rural/Suburban Highway (ADT > 2,000 and less than 1 dwelling unit (d.u.) / .4 hectares (ha) [1 d.u. / acre])	Sidewalks or side paths preferred. Minimum of 1.8-m (6-ft) shoulders required.	Secure/preserve ROW for future sidewalks.
Suburban Highway (1 to 4 d.u. / .4 ha [1 to 4 d.u. / acre])	Sidewalks on both sides required.	
Major Arterial (residential)	Sidewalks on both sides required.	
Urban Collector and Minor Arterial (residential)	Sidewalks on both sides required.	
Urban Local Street (residential — less than 1 d.u./ .4 ha [1 d.u. / acre])	Sidewalks on both sides preferred. Minimum of 1.5-m (5-ft) shoulders required.	Secure/preserve ROW for future sidewalks.
Urban Local Street (residential — 1 to 4 d.u. / .4 ha [1 to 4 d.u. / acre])	Both sides preferred.	Second side required if density becomes greater than 4 d.u. / .4 ha (4 d.u. / acre) or if schools, bus stops, etc. are added.
Local Street (residential — more than 4 d.u. / .4 ha [4 d.u. / acre])	Sidewalks on both sides required.	
All Commercial Urban Streets	Sidewalks on both sides required.	
All Streets in Industrial Areas	Sidewalks on both sides preferred. Minimum of 1.5-m (5-ft) shoulders required.	

1 acre = 0.4 hectares (ha)

Appendix C

Recommended Guidelines for Crosswalk Installation



Photo by Cara Seidermann

Marked crosswalks serve two purposes: (1) they tell the pedestrian the best place to cross, and (2) they clarify that a legal crosswalk exists at a particular location.

Marked crosswalks are one tool to get pedestrians safely across the street. When considering marked crosswalks at uncontrolled locations, the question should not simply be: "Should I provide a marked crosswalk or not?" Instead, the question should be: "Is this an appropriate tool for getting pedestrians across the street?" Regardless of whether marked crosswalks are used, there remains the fundamental objective of getting pedestrians safely across the street.

In most cases, marked crosswalks are best used in combination with other treatments (e.g., curb extensions, raised crossing islands, traffic signals, roadway narrowing, enhanced overhead lighting, traffic-calming measures, etc.). Think of marked crosswalks as one of a progression of design treatments. If one treatment does not adequately accomplish the task, then move on to the next one. The failure of one particular treatment is not a license to give up and do nothing. In all cases, the final design must address the goal of getting pedestrians across the road safely.

Marked pedestrian crosswalks may be used to delineate preferred pedestrian paths across roadways under the following conditions:

1. At locations with stop signs or traffic signals. Vehicular traffic might block pedestrian traffic when stopping for a stop sign or red light; marking crosswalks may help to reduce this occurrence.
2. At non-signalized street crossing locations in designated school zones. Use of adult crossing guards, school signs and markings, and/or traffic signals with pedestrian signals (when warranted) should be used in conjunction with the marked crosswalk, as needed.
3. At non-signalized locations where engineering judgment dictates that the number of motor vehicle lanes, pedestrian exposure, average daily traffic (ADT), posted speed limit, and geometry of the location would make the use of specially designated crosswalks desirable for traffic/pedestrian safety and mobility. This must consider the conditions listed below.

Marked crosswalks alone are insufficient (i.e., without traffic-calming treatments, traffic signals, and pedestrian signals when warranted, or other substantial crossing improvement) and should not be used under the following conditions:

1. Where the speed limit exceeds 64.4 km/h (40 mi/h).
2. On a roadway with four or more lanes without a raised median or crossing island that has (or will soon have) an ADT of 12,000 or greater.
3. On a roadway with four or more lanes with a raised median or crossing island that has (or will soon have) an ADT of 15,000 or greater.

Street crossing locations should be routinely reviewed to consider the following available options:

- Option 1 — No special provisions needed.
- Option 2 — Provide a marked crosswalk alone.
- Option 3 — Install other crossing improvements (with or without a marked crosswalk) to reduce vehicle speeds, shorten crossing distances, increase the likelihood of motorists stopping and yielding, and/or other outcome.

The spacing of marked crosswalks should also be considered so that they are not placed too close together.

A more conservative use of crosswalks is generally preferred. Thus, it is recommended that in situations where marked crosswalks alone are acceptable that a higher priority be placed on their use at locations having a minimum of 20 pedestrian crossings per peak hour (or 15 or more elderly and/or child pedestrians per peak hour). In all cases, good engineering judgment must be applied.

Other Factors

Distance of Marked Crosswalks From Signalized Intersections

Marked crosswalks should not be installed in close proximity to traffic signals, since pedestrians should be encouraged to cross at the signal in most situations. The minimum distance from a signal for installing a marked crosswalk should be determined by local traffic engineers based on pedestrian crossing demand, type of roadway, traffic volume, and other factors. The objective of adding a marked crosswalk is to channel pedestrians to safer crossing points. It should be understood, however, that pedestrian crossing behavior may be difficult to control merely by the addition of marked crosswalks. The new marked crosswalk should not unduly restrict platooned traffic, and should also be consistent with marked crosswalks at other unsignalized locations in the area.

Other Treatments

In addition to installing marked crosswalks (or, in some cases, instead of installing marked crosswalks), there are other treatments that should be considered to provide safer and easier crossings for pedestrians at problem locations. Examples of these pedestrian improvements include:

- Providing raised medians (or raised crossing islands) on multi-lane roads.
- Installing traffic signals and pedestrian signals where warranted, and where serious pedestrian crossing problems exist.
- Reducing the exposure distance for pedestrians by:
 - Providing curb extensions.
 - Providing pedestrian islands.
 - Reducing four-lane undivided road sections to two through lanes with a left-turn bay (or a two-way left-turn lane), sidewalks, and bicycle lanes.
- When marked crosswalks are used on uncontrolled multi-lane roads, consideration should be given to installing advance stop lines as much as 9.1 m (30 ft) prior to the crosswalk (with a STOP HERE FOR CROSSWALK sign) in each direction to reduce the likelihood of a multiple-threat pedestrian collision.
- Bus stops should be located on the far side of uncontrolled marked crosswalks.
- Installing traffic-calming measures to slow vehicle speeds and/or reduce cut-through traffic. Such measures may include:
 - Raised crossings (raised crosswalks, raised intersections).
 - Street-narrowing measures (chicanes, slow points, "skinny street" designs).
 - Intersection designs (traffic mini-circles, diagonal diverters).
 - Others (see *ITE Traffic-Calming Guide* for further details).⁽¹⁾

Some of these traffic-calming measures are better suited to local or neighborhood streets than to arterial streets:

- Providing adequate nighttime street lighting for pedestrians in areas with nighttime pedestrian activity where illumination is inadequate.
- Designing safer intersections and driveways for pedestrians (e.g., crossing islands, tighter turn radii), which take into consideration the needs of pedestrians.

These guidelines were developed in an FHWA report entitled *Safety Effects of Marked vs. Unmarked Crosswalks at Uncontrolled Locations*.⁽¹⁾ This report may be found at: www.walkinginfo.org/rd/devices.htm. In developing these proposed U.S. guidelines for marked crosswalks and other pedestrian measures, consideration was given not only to the research results in this study, but also to crosswalk guidelines and related pedestrian safety research in Australia, Canada, Germany, Great Britain, Hungary, The Netherlands, Norway, and Sweden (see references 2-8).

References

1. Zegeer, C., J. Stewart, and H. Huang, *Safety Effects of Marked vs. Unmarked Crosswalks at Uncontrolled Locations*, Report No. FHWA-RD-01-142, FHWA, Washington, DC, May 2001.
2. *Safety of Vulnerable Road Users*, Organisation for Economic Co-operation and Development (OECD), August 1998.
3. Ekman, L., *Pedestrian Safety in Sweden*, Report No. FHWA-RD-99-091, FHWA, Washington, DC, December 1999.
4. Hummel, T., *Dutch Pedestrian Safety Research Review*, Report No. FHWA-RD-99-092, FHWA, Washington, DC, December 1999.
5. *Pedestrian Safety: Analyses and Safety Measures*, Danish Road Directorate, Division of Traffic Safety and Environment, Copenhagen, June 1998.
6. Van Houten, R., *Canadian Research on Pedestrian Safety*, Report No. FHWA-RD-99-090, FHWA, Washington, DC, December 1999.
7. Cairney, P., *Pedestrian Safety in Australia*, Report No. FHWA-RD-99-093, FHWA, Washington, DC, December 1999.
8. Davies, D., *Research, Development, and Implementation of Pedestrian Safety Facilities in the United Kingdom*, Report No. FHWA-RD-99-089, FHWA, Washington, DC, December 1999.