

# Long-Term Plan for Concrete Pavement Research and Technology—The Concrete Pavement Road Map: Volume I, Background and Summary

FHWA PUBLICATION NUMBER: FHWA-HRT-05-052

SEPTEMBER 2005



U.S. Department of Transportation  
**Federal Highway Administration**

Research, Development, and Technology  
Turner-Fairbank Highway Research Center  
6300 Georgetown Pike  
McLean, VA 22101-2296

## **FOREWORD**

The concrete paving industry has experienced many changes in the last 15 years. To achieve concrete pavement's full potential in the 21<sup>st</sup> century, the industry has identified trends that call for dramatic, even revolutionary, improvements. With an aim toward a holistic approach, the improvements can best be served by a carefully developed and aggressively implemented strategic plan for research and technology transfer. The Long-Term Plan for Concrete Pavement Research and Technology (CP Road Map) is that plan.

This is volume 1 of two volumes. It provides the background and summary information on the effort that led to the CP Road Map. Sufficient copies of this report are being distributed to provide eight copies to each FHWA Resource Center, five copies to each FHWA Division, and a minimum of eight copies to each State highway agency. Direct distribution is being made to the division offices for their forwarding to the State highway agencies. Additional copies for the public are available from the National Technical Information Service (NTIS), 5285 Port Royal Road, Springfield, VA 22161.

Steven B. Chase, Ph.D.  
Acting Director, Office of Infrastructure  
Research and Development

### **Notice**

This document is disseminated under the sponsorship of the U.S. Department of Transportation in the interest of information exchange. The U.S. Government assumes no liability for the use of the information contained in this document. This report does not constitute a standard, specification, or regulation.

The U.S. Government does not endorse products or manufacturers. Trademarks or manufacturers' names appear in this report only because they are considered essential to the objective of the document.

### **Quality Assurance Statement**

The Federal Highway Administration (FHWA) provides high-quality information to serve Government, industry, and the public in a manner that promotes public understanding. Standards and policies are used to ensure and maximize the quality, objectivity, utility, and integrity of its information. FHWA periodically reviews quality issues and adjusts its programs and processes to ensure continuous quality improvement.

**Technical Report Documentation Page**

1. Report No FHWA-HRT-05-052	2. Government Accession No. N/A	3. Recipient's Catalog No. N/A	
4. Title and Subtitle Long-Term Plan for Concrete Pavement Research and Technology—The Concrete Pavement Road Map: Volume I, Background and Summary		5. Report Date September 2005	
		6. Performing Organization Code N/A	
7. Authors(s) Theodore R. Ferragut, TDC Partners, Ltd.; Dale Harrington and Marcia Brink, Iowa State University		8. Performing Organization Report No.	
9. Performing Organization Name and Address Iowa State University Center for Portland Cement Concrete Pavement Technology ISU Research Park 2901 S. Loop Drive, Suite 3000 Ames, IA 50010		10. Work Unit No. (TRAIS) N/A	
		11. Contract or Grant No. DTFH 61-03-H-00103	
		13. Type of Report and Period Covered	
12. Sponsoring Agency Name and Address Office of Infrastructure Research and Development Federal Highway Administration 6300 Georgetown Pike McLean, VA 22101		14. Sponsoring Agency Code	
15. Supplementary Notes Contracting Officer's Technical Representative: Peter Kopac, HRDI-11			
16. Abstract  The Long-Term Plan for Concrete Pavement Research and Technology (CP Road Map) is a holistic, strategic plan for concrete pavement research and technology transfer. The CP Road Map is a 7- to 10-year plan that includes 12 distinct but integrated research tracks leading to specific products and processes. The resulting improvements will help the concrete pavement industry meet the challenges of, and achieve the industry's full potential in, the 21st century. The plan was developed in close partnership with stakeholders representing all aspects of the concrete pavement community, public and private, and the research will be conducted through partnerships of stakeholders. The CP Road Map is presented in two volumes. Volume I describes why the research plan is needed, how it was developed, and, generally, what the plan includes. Volume I also describes the research management plan that will guide the conduct and implementation of research. Volume II (FWHA HRT-05-053) describes in detail the 12 tracks of research. Each track description includes a general overview, a track goal, track action items, a list of subtracks, and detailed problem statements within each subtrack.			
17. Key Words Concrete pavement, concrete mix design, pavement construction, pavement design, pavement performance, pavement smoothness, equipment automation.		18. Distribution Statement No restrictions. This document is available to the Public through the National Technical Information Service; Springfield, VA 22161	
19. Security Classif. (of this report) Unclassified	20. Security Classif. (of this page) Unclassified	21. No. of Pages 119	22. Price

# SI\* (MODERN METRIC) CONVERSION FACTORS

## APPROXIMATE CONVERSIONS TO SI UNITS

Symbol	When You Know	Multiply By	To Find	Symbol
<b>LENGTH</b>				
in	inches	25.4	millimeters	mm
ft	feet	0.305	meters	m
yd	yards	0.914	meters	m
mi	miles	1.61	kilometers	km
<b>AREA</b>				
in <sup>2</sup>	square inches	645.2	square millimeters	mm <sup>2</sup>
ft <sup>2</sup>	square feet	0.093	square meters	m <sup>2</sup>
yd <sup>2</sup>	square yard	0.836	square meters	m <sup>2</sup>
ac	acres	0.405	hectares	ha
mi <sup>2</sup>	square miles	2.59	square kilometers	km <sup>2</sup>
<b>VOLUME</b>				
fl oz	fluid ounces	29.57	milliliters	mL
gal	gallons	3.785	liters	L
ft <sup>3</sup>	cubic feet	0.028	cubic meters	m <sup>3</sup>
yd <sup>3</sup>	cubic yards	0.765	cubic meters	m <sup>3</sup>
NOTE: volumes greater than 1000 L shall be shown in m <sup>3</sup>				
<b>MASS</b>				
oz	ounces	28.35	grams	g
lb	pounds	0.454	kilograms	kg
T	short tons (2000 lb)	0.907	megagrams (or "metric ton")	Mg (or "t")
<b>TEMPERATURE (exact degrees)</b>				
°F	Fahrenheit	5 (F-32)/9 or (F-32)/1.8	Celsius	°C
<b>ILLUMINATION</b>				
fc	foot-candles	10.76	lux	lx
fl	foot-Lamberts	3.426	candela/m <sup>2</sup>	cd/m <sup>2</sup>
<b>FORCE and PRESSURE or STRESS</b>				
lbf	poundforce	4.45	newtons	N
lbf/in <sup>2</sup>	poundforce per square inch	6.89	kilopascals	kPa
<b>APPROXIMATE CONVERSIONS FROM SI UNITS</b>				
Symbol	When You Know	Multiply By	To Find	Symbol
<b>LENGTH</b>				
mm	millimeters	0.039	inches	in
m	meters	3.28	feet	ft
m	meters	1.09	yards	yd
km	kilometers	0.621	miles	mi
<b>AREA</b>				
mm <sup>2</sup>	square millimeters	0.0016	square inches	in <sup>2</sup>
m <sup>2</sup>	square meters	10.764	square feet	ft <sup>2</sup>
m <sup>2</sup>	square meters	1.195	square yards	yd <sup>2</sup>
ha	hectares	2.47	acres	ac
km <sup>2</sup>	square kilometers	0.386	square miles	mi <sup>2</sup>
<b>VOLUME</b>				
mL	milliliters	0.034	fluid ounces	fl oz
L	liters	0.264	gallons	gal
m <sup>3</sup>	cubic meters	35.314	cubic feet	ft <sup>3</sup>
m <sup>3</sup>	cubic meters	1.307	cubic yards	yd <sup>3</sup>
<b>MASS</b>				
g	grams	0.035	ounces	oz
kg	kilograms	2.202	pounds	lb
Mg (or "t")	megagrams (or "metric ton")	1.103	short tons (2000 lb)	T
<b>TEMPERATURE (exact degrees)</b>				
°C	Celsius	1.8C+32	Fahrenheit	°F
<b>ILLUMINATION</b>				
lx	lux	0.0929	foot-candles	fc
cd/m <sup>2</sup>	candela/m <sup>2</sup>	0.2919	foot-Lamberts	fl
<b>FORCE and PRESSURE or STRESS</b>				
N	newtons	0.225	poundforce	lbf
kPa	kilopascals	0.145	poundforce per square inch	lbf/in <sup>2</sup>

\*SI is the symbol for the International System of Units. Appropriate rounding should be made to comply with Section 4 of ASTM E380. (Revised March 2003)

# TABLE OF CONTENTS

<b>EXECUTIVE SUMMARY .....</b>	<b>1</b>
<b>THE CP ROAD MAP.....</b>	<b>1</b>
<b>WHAT IS UNIQUE ABOUT THE CP ROAD MAP? .....</b>	<b>1</b>
<b>A VISIONARY CHARGE .....</b>	<b>1</b>
<b>DRAWING A NEW MAP FOR CONCRETE PAVEMENTS .....</b>	<b>2</b>
<b>A “Living” Research Database.....</b>	<b>3</b>
<b>Stakeholder Input.....</b>	<b>3</b>
<b>From Stakeholder Input to Plan .....</b>	<b>4</b>
<b>Problem Statements.....</b>	<b>5</b>
<b>Track Integration .....</b>	<b>5</b>
<b>CP ROAD MAP RESEARCH TRACKS .....</b>	<b>5</b>
<b>REACHING THE DESTINATION.....</b>	<b>8</b>
<b>Philosophy for Managing Research .....</b>	<b>8</b>
<b>Governing Structure .....</b>	<b>8</b>
<b>THE CP ROAD MAP TRACKS AND SUBTRACKS.....</b>	<b>9</b>
<b>1. Performance-Based Concrete Pavement Mix Design System (\$30–68 M*).....</b>	<b>10</b>
<b>2. Performance-Based Design Guide for New and Rehabilitated Concrete Pavements (\$41–60 M) .....</b>	<b>10</b>
<b>3. High-Speed Nondestructive Testing and Intelligent Construction Systems (\$20–41 M) .....</b>	<b>10</b>
<b>4. Optimized Surface Characteristics for Safe, Quiet, and Smooth Concrete Pavements (\$25–54 M).....</b>	<b>10</b>
<b>5. Concrete Pavement Equipment Automation and Advancements (\$26–56 M)....</b>	<b>10</b>
<b>6. Innovative Concrete Pavement Joint Design, Materials, and Construction (\$10–15 M) .....</b>	<b>11</b>
<b>7. High-Speed Concrete Pavement Rehabilitation and Construction (\$10–20 M)..</b>	<b>11</b>
<b>8. Long Life Concrete Pavements (\$11–17 M).....</b>	<b>11</b>
<b>9. Concrete Pavement Accelerated and Long-Term Data Collection (\$10–16 M)..</b>	<b>11</b>
<b>10. Concrete Pavement Performance (\$3–4 M).....</b>	<b>11</b>
<b>11. Concrete Pavement Business Systems and Economics (\$21–31 M).....</b>	<b>11</b>
<b>12. Advanced Concrete Pavement Materials (\$11–23 M) .....</b>	<b>11</b>
<b>ORGANIZATION OF VOLUMES I AND II.....</b>	<b>12</b>
<b>HOW CAN YOU PARTICIPATE? .....</b>	<b>13</b>

<b>CHAPTER 1. WHY A LONG-TERM RESEARCH PLAN FOR CONCRETE PAVEMENTS? .....</b>	<b>15</b>
<b>NEW TRENDS, NEW NEEDS.....</b>	<b>16</b>
<b>Materials and Mixes .....</b>	<b>16</b>
<b>Motorists' Expectations .....</b>	<b>16</b>
<b>Shift from Traditional Concrete Pavement Construction .....</b>	<b>17</b>
<b>Capital Squeeze.....</b>	<b>17</b>
<b>Environmental Pressures.....</b>	<b>18</b>
<b>Congestion and Loads .....</b>	<b>18</b>
<b>NEW NEEDS, A NEW GENERATION OF SOLUTIONS.....</b>	<b>19</b>
 <b>CHAPTER 2. CP ROAD MAP DEVELOPMENT PROCESS.....</b>	 <b>21</b>
<b>LITERATURE SEARCH/RESEARCH DATABASE .....</b>	<b>21</b>
<b>BRAINSTORMING EVENTS .....</b>	<b>23</b>
<b>Stakeholders.....</b>	<b>23</b>
<b>Brainstorming Strategies .....</b>	<b>23</b>
<b>PUTTING IT ALL TOGETHER IN THE CP ROAD MAP.....</b>	<b>25</b>
 <b>CHAPTER 3. WHAT DOES THE STRATEGIC ROAD MAP LOOK LIKE? .....</b>	 <b>27</b>
<b>SUMMARY .....</b>	<b>27</b>
<b>PROBLEM STATEMENTS.....</b>	<b>28</b>
<b>RESEARCH PRIORITIES .....</b>	<b>28</b>
<b>Type 1 Tracks .....</b>	<b>28</b>
<b>Type 2 Tracks .....</b>	<b>29</b>
<b>ESTIMATED BUDGET .....</b>	<b>29</b>
<b>TRACK HIGHLIGHTS.....</b>	<b>30</b>
<b>Type 1 Tracks .....</b>	<b>30</b>
<b>Type 2 Tracks .....</b>	<b>38</b>

<b>CHAPTER 4. DESIGN CONSIDERATIONS .....</b>	<b>53</b>
<b>PERFORMANCE-BASED PAVEMENT SYSTEMS .....</b>	<b>53</b>
<b>WHY IS THIS TOPIC IMPORTANT? .....</b>	<b>53</b>
<b>OVERALL DESIGN GOAL .....</b>	<b>53</b>
<b>SPECIFIC DESIGN OBJECTIVES .....</b>	<b>53</b>
<b>RELATING DESIGN OBJECTIVES TO THE HIGHWAY USER.....</b>	<b>54</b>
<b>CRITICAL DESIGN ISSUES .....</b>	<b>54</b>
Models.....	54
Understanding the Fundamentals of Concrete Pavement Response.....	54
Design Reliability.....	55
Feasible Designs for All Occasions.....	55
Efficient Pavement Designs for Low-Volume Local Roads.....	56
Lack of Integration of Design with Materials, Construction, and Rehabilitation ...	56
Design Procedures Deficiency .....	56
Preservation and Rehabilitation Design.....	57
Base and Subbase Foundations and Subdrainage.....	57
New and Innovative Concrete Pavement Design.....	57
Designs for All Types of Underlying Strata .....	57
<b>CHAPTER 5. MATERIALS AND MIXTURES CONSIDERATIONS.....</b>	<b>59</b>
<b>WHY IS THIS TOPIC IMPORTANT? .....</b>	<b>59</b>
<b>OVERALL MATERIALS AND MIXTURES GOAL .....</b>	<b>60</b>
<b>SPECIFIC MATERIALS AND MIXTURES OBJECTIVES.....</b>	<b>60</b>
<b>TOOLS FOR SUCCESS .....</b>	<b>60</b>
<b>CRITICAL MATERIALS AND CONCRETE MIXTURES ISSUES .....</b>	<b>61</b>
Specifications .....	61
Mix Designs .....	61
Modeling.....	62
Materials Compatibility.....	62
Material Changes During Construction.....	63
Durability Design Model.....	63
<b>CHAPTER 6. CONSTRUCTION CONSIDERATIONS.....</b>	<b>65</b>
<b>WHY IS THIS TOPIC IMPORTANT? .....</b>	<b>65</b>
<b>OVERALL CONSTRUCTION GOAL .....</b>	<b>65</b>
<b>SPECIFIC CONSTRUCTION OBJECTIVES.....</b>	<b>65</b>
<b>CRITICAL CONSTRUCTION ISSUES.....</b>	<b>65</b>
Accelerating Construction/Improving Workplace Safety .....	66
Lane Closure and Traffic Management Issues.....	66
Intelligent Construction Systems and Quality Control/Acceptance.....	67
Interaction of Variables .....	67
Variability .....	67
Nondestructive Testing .....	68
Performance Specifications .....	68
Construction Operations and Equipment.....	68

High-Speed/Low-Clearance Construction .....	69
Ensuring Long-Term Performance .....	69
Constructing and Controlling Surface Characteristics .....	69
Joint Sealing.....	69
Improving Competition.....	69

## **CHAPTER 7. PAVEMENT MANAGEMENT AND BUSINESS SYSTEMS**

<b>CONSIDERATIONS .....</b>	<b>71</b>
WHY IS THIS TOPIC IMPORTANT? .....	71
OVERALL PAVEMENT MANAGEMENT AND BUSINESS SYSTEMS GOAL.....	71
PAVEMENT MANAGEMENT AND BUSINESS SYSTEMS OBJECTIVES .....	71
PAVEMENT MANAGEMENT AND BUSINESS SYSTEMS CONSIDERATIONS ....	72
Real-Time Data from Concrete Pavements .....	72
Feedback Data for Continuous Improvement .....	72
Performance Data on Innovations Through Accelerated Test Roads.....	73
Impact of Preservation Activities on Performance and Life .....	73
Economics and Innovative Contracting .....	73
Public-Private Partnerships .....	74
Technology Transfer .....	74

## **CHAPTER 8. RESEARCH MANAGEMENT PLAN .....**

ASSUMPTIONS .....	75
OPERATING PRINCIPLES.....	76
CRITICAL ELEMENTS OF THE RESEARCH MANAGEMENT PLAN.....	76
RESEARCH MANAGEMENT PLAN: A UNIQUE MODEL WITH ROOTS IN THE PAST .....	77
PLAN GOVERNANCE STRUCTURE .....	77
GETTING STARTED.....	80
OPERATING DETAILS .....	80
Executive Advisory Committee .....	80
Research Track Team Leaders .....	81
Sustaining Organizations.....	82
Administrative Support Group.....	83
MORE ABOUT THE EXECUTIVE ADVISORY COMMITTEE .....	83
DATABASE MANAGEMENT: RECHARGING THE BRAIN OF THE CP ROAD	
MAP .....	84
Database Management, Road Map Update, and Research Track Integration .....	84
Software Integration .....	85
Implementation, Coordination, and Training on Research Output.....	85
Partnering and Fund Management .....	86
Concrete Pavement Innovation .....	86
SPECIFIC RESEARCH MANAGEMENT CONSIDERATIONS FOR RESEARCH TRACKS .....	86
Type 1 Research Tracks Management Considerations .....	87
Type 2 Research Tracks Management Considerations .....	93
Cross-Referenced Database Tables .....	94



<b>THREE SPECIAL RESEARCH MANAGEMENT CHALLENGES.....</b>	<b>95</b>
<b>Early Financing and Conduct of Research .....</b>	<b>95</b>
<b>Business System Changes .....</b>	<b>95</b>
<b>Technology Transfer .....</b>	<b>95</b>
<b>GETTING STARTED: NOT BUSINESS AS USUAL.....</b>	<b>96</b>
<b>APPENDIX A .....</b>	<b>99</b>
<b>APPENDIX B .....</b>	<b>101</b>
<b>APPENDIX C .....</b>	<b>107</b>
<b>REFERENCES.....</b>	<b>111</b>

## LIST OF FIGURES

Figure 1. CP Road Map development process.....	22
Figure 2. Advanced labs for advanced mixture designs.....	30
Figure 3. Advanced models for performance-based design.....	32
Figure 4. Technologies for monitoring pavement data and making real-time adjustments during construction.....	34
Figure 5. Optimized pavement surfaces for a safe, quiet, and smooth ride.....	36
Figure 6. Equipment and technology advancements.....	38
Figure 7. Breakthrough techniques for designing and rehabilitating joints.....	40
Figure 8. Modular construction: one of many potential high-speed rehabilitation techniques.....	42
Figure 9. Pavements that perform well for 60 years or more.....	44
Figure 10. Accelerated loading and data collection to improve models and systems.....	46
Figure 11. Systemwide data collection and analysis to support long-term performance.....	48
Figure 12. Innovative business systems.....	49
Figure 13. Innovative concrete materials.....	51
Figure 14. Research management plan.....	79
Figure 15. CP Road Map goal.....	97
Figure 16. Critical issues for tracks 1 and 2.....	101
Figure 17. Critical issues for tracks 3 and 4.....	102
Figure 18. Critical issues for tracks 5, 6, and 7.....	103
Figure 19. Critical issues for tracks 8, 9, and 10.....	104
Figure 20. Critical issues for tracks 11 and 12.....	105

## LIST OF TABLES

Table 1. Estimated budget.....	29
Table 2. Brainstorming (outreach) events.....	99



# EXECUTIVE SUMMARY

## THE CP ROAD MAP

The Concrete Pavement (CP) Road Map is a comprehensive and strategic plan for concrete pavement research that will guide the investment of research dollars for the next several years. It will result in technologies and systems that help the concrete pavement community meet the paving needs of today, and the as-yet unimagined paving challenges of tomorrow. In short, the CP Road Map will result in a new generation of concrete pavements for the 21st century.

## WHAT IS UNIQUE ABOUT THE CP ROAD MAP?

**Strategic**—It combines more than 250 research problem statements into 12 fully integrated, sequential, and cohesive tracks of research leading to specific products that will dramatically affect the way concrete pavements are designed and constructed.

**Innovative**—From the way it was developed, to its unique track structure and cross-track integration, to the plan for conducting the research, the CP Road Map introduces a new, inclusive, and far-reaching approach to pavement research.

**Stakeholder involvement**—This CP Road Map plan is for the Federal, State, and private concrete pavement community. Peers helped create it, so it reflects all needs.

**No cost or time limitations**—In general, it is a 7- to 10-year plan with an estimated overall cost of \$250 million.

**Independent of any one agency or pot of money**—Stakeholders with funds and expertise will pool their resources, jointly conduct and coordinate the research, and apply the results. The plan incorporates innovative, effective research implementation to move useful new products and systems to the field quickly.

## A VISIONARY CHARGE

The Federal Highway Administration (FHWA) and the concrete pavement industry have commissioned a national research plan for the 21st century. Why is such a plan needed?

For most of the 20th century, the same materials—portland cement, high-quality aggregate, and water—were used in pavement concrete, with only minor refinements. It was a fairly forgiving formula that allowed some variations in subgrade quality, construction practices, and other variables without sacrificing pavement performance. For generations, the industry had the luxury of keeping traffic off new concrete pavements for several days, even weeks, while the concrete developed its internal design strength.

In the past 15 years, the industry has experienced more changes than those that occurred in the previous 80 years, and these changes are turning the process of building concrete pavements on end:

- Today's concrete mix designs must integrate a multitude of new, sometimes marginal materials, resulting in serious compatibility problems and reduced tolerance for variations.
- Motorists are more demanding. They will tolerate only minimal road closures and delays due to roadwork, increasing the need for new paving methods that allow road crews to get in, get out, and stay out. And motorists want smoother, quieter pavements, pushing the industry to control pavement surface characteristics.
- Highway agency focus has shifted from building new pavements to rehabilitating and maintaining existing ones, which requires different designs, systems, materials, and equipment.
- Environmental pressures, including traffic congestion and drainage and runoff issues, are affecting mix designs and pavement construction practices.
- Highway budgets are being squeezed at every level. The pavement community simply must do more with less.

In this environment, the old system for constructing concrete pavements is not meeting today's demands. Pavement failures have occurred that were unheard of 25 years ago. The concrete pavement community cannot continue business as usual if it is going to meet the growing demands on highway construction and rehabilitation. The CP Road Map gives the community an opportunity to proactively reinvent itself through research.

## **DRAWING A NEW MAP FOR CONCRETE PAVEMENTS**

The project to develop the Long-Term Plan for Concrete Pavement Technology began in 2001 through an agreement between the Innovative Pavement Research Foundation and a team led by Iowa State University's Center for Portland Cement Concrete Pavement Technology (PCC Center).

In May 2003, FHWA initiated a new agreement with the PCC Center to complete the work. The Transportation Research Board (TRB) Committee for Research on Improved Concrete Pavements acted as the project advisory panel. Twenty percent of total funding for the project was provided by Iowa State University. The concrete pavement industry and State departments of transportation (DOT) provided valuable input to the CP Road Map and support its implementation.

An Iowa State University-led team facilitated development of the CP Road Map. They developed a database of existing research and gathered input, face-to-face, from the highway community. The team identified gaps in research that became the basis for problem statements, which are organized into a cohesive, strategic research plan.

## **A “Living” Research Database**

The research database is a thorough catalog of recently completed and in-progress research projects and their products. If regularly updated and maintained, as recommended in the research management plan (described later in this report), the database will be a valuable resource for many years.

## **Stakeholder Input**

To ensure the adoption and success of the CP Road Map, it was developed through a cooperative process involving high levels of stakeholder teamwork.

Five major brainstorming and feedback sessions were conducted at the following events: the October 2003 meeting of the Midwest Concrete Consortium (MC<sup>2</sup>) in Ames, IA; a special November 2003 regional workshop for eastern and southern stakeholders in Syracuse, NY; the May 2004 meeting of the American Concrete Pavement Association (ACPA) in Kansas City, MO; a special January 2004 regional teleconference for western stakeholders; and, in October 2004, a final meeting of national stakeholders hosted by FHWA at the Turner-Fairbank Highway Research Center in McLean, VA.

Through these events, plus special presentations at more than 20 professional conferences and workshops across the country, more than 400 engineers and managers provided direct input into the CP Road Map.

Participants represented the following entities:

- State and local DOTs.
- FHWA.
- ACPA, including several State chapters.
- Portland Cement Association (PCA).
- American Association of State Highway and Transportation Officials (AASHTO).
- National Ready Mixed Concrete Association (NRMCA).
- TRB/National Cooperative Highway Research Program (NCHRP) committees.
- American Public Works Association (APWA).
- National Association of County Engineers (NACE).
- Contractors.
- Materials suppliers.
- Research universities, especially departments conducting applied research.
- Private concrete testing laboratories.

Input was provided in four broad categories:

- Mixtures and materials.
- Design.
- Construction.

- Pavement management/business systems.

Again and again, stakeholders who participated in these brainstorming events said they needed more and better analysis tools for measuring the hows and whys of pavement failures and successes—that is, to measure pavement performance. Better quality assurance and quality control methods/tools are needed for every stage of the pavement system, particularly mix design, design, and construction. Because variables in each stage affect the others, the methods/tools must be integrated across stages.

From these concepts of pavement performance and systems integration, the following overall vision for the CP Road Map was developed:

By 2015, the highway community will have a comprehensive, integrated, and fully functional system of concrete pavement technologies that provides innovative solutions for customer-driven performance requirements.

Based on this goal and other stakeholder input, dozens of specific research objectives were identified:

- Maximize public convenience.
- Improve the driving experience.
- Integrate design, mixtures and materials, and construction with pavement performance predictions.
- Improve pavement reliability.
- Identify new and innovative business relationships to focus on performance requirements.
- Constrain costs while improving pavement performance.
- Protect and improve the environment.
- Expand opportunities to use concrete pavement.

The objectives were “filtered” through the project team’s database of existing research to determine gaps in research. These gaps became the basis for problem statements.

Approximately 250 problem statements were written, reviewed, and fine tuned. Final versions of the problem statements were added to the research database as work to be accomplished via the CP Road Map.

Research problem statements, projects, budgets, timelines, and research results in the database must be regularly updated. The CP Road Map will succeed only if the database is managed and maintained.

### **From Stakeholder Input to Plan**

Most of the 250-plus problem statements did not neatly fit into just one of the brainstorming categories (mixtures and materials, design, construction, and pavement management/business systems). To capture the cross-categories and the integrated nature of the problem statements, the problem statements were organized into 12, product-focused tracks of research within the



database. This structure encourages various stakeholder groups to step forward as champions for a specific track.

### **Problem Statements**

Each problem statement is a topical summary only. Most problem statements will be further broken down into specific research project statements that provide detailed descriptions of the research to be accomplished, budgets, and timelines. The research management plan (described later in this document) makes research track team leaders responsible for data entry of detailed project statements into the database.

### **Track Integration**

As noted in the 12 brief track descriptions below, research in one track often affects or is affected by research in another track. In the CP Road Map, this interdependence and other critical relationships are outlined in the track and problem statement descriptions. It will be the responsibility of research track team leaders, as described later in this document, to ensure that research is appropriately coordinated and integrated.

Moreover, the research database can be sorted to isolate problem statements on a variety of subjects. For example, several important problem statements related to foundations and drainage systems, maintenance and rehabilitation, and environment advancements are included in various tracks. In the CP Road Map, problem statements related to these particular topics have been listed in separate cross-reference tables.

## **CP ROAD MAP RESEARCH TRACKS**

Each of the CP Road Map tracks is a full research program in itself, with its own budget, 2 to 7 subtracks, and as many as 20 problem statements. Tracks 1 through 9 consist of timed sequences of research leading to particular products that are essential to reaching overall research goals. In the CP Road Map, one subtrack in every phased track is devoted to developing innovative technology transfer, training tools, and methods to ensure that innovative research products are quickly and efficiently moved into practice. Tracks 10, 11, and 12 are not phased because timing is not as critical.

The products developed through the first four tracks may be especially critical to helping the industry achieve the full potential of concrete pavements.

Following is a brief description of each research track:

- 1. Performance-Based Concrete Pavement Mix Design System.** The final product of this track will be a practical yet innovative concrete mix design procedure with new equipment, consensus target values, common laboratory procedures, and full integration with both structural design and field quality control—a lab of the future. This track also lays the groundwork for the concrete paving industry to assume more responsibility for mix designs as State highway agencies move from method specifications to more advanced acceptance

tools. For such a move to be successful, it is important that the concrete paving industry and owner-agencies refer to a single document for mix design state of the art.

**2. Performance-Based Design Guide for New and Rehabilitated Concrete Pavements.**

Under this track, the concrete pavement research community will expand the mechanistic approach to pavement restoration and preservation strategies. This track builds on the comprehensive work done under NCHRP 1–37A (development of the *Mechanistic-Empirical (M-E) Pavement Design Guide*) and continues to develop the models from that key work. The work in this track needs to be closely integrated with track 1.

**3. High-Speed Nondestructive Testing and Intelligent Construction Systems.** This track will develop high-speed, nondestructive quality control systems to monitor pavement properties continuously during construction. As a result, immediate adjustments can be made to ensure the highest quality finished product that meets given performance specifications. Many problem statements in this track relate to both tracks 1 and 2.

**4. Optimized Surface Characteristics for Safe, Quiet, and Smooth Concrete Pavements.**

This track will improve understanding of concrete pavement surface characteristics. It will provide tools for engineers to help meet or exceed predetermined requirements for friction/safety, tire-pavement noise, smoothness, splash and spray, wheel path wear (hydroplaning), light reflection, rolling resistance, and durability (longevity). Each of the functional elements of a pavement listed above is critical. The challenge is to improve one characteristic without compromising another characteristic, especially when it comes to safety of the public.

**5. Equipment Automation and Advancements.** This track will result in process improvements and equipment developments for high-speed, high-quality concrete paving equipment to meet the concrete paving industry’s projected needs and the traveling public’s expectations for highway performance in the future. Examples include the next generation of concrete batching and placement equipment; behind-the-paver equipment to improve curing, surface treatment, and jointing; mechanized ways to place and control subdrains and other foundation elements; equipment to remove/replace the slab in one-pass construction; improved repair processes that decrease the time of operations and provide the workforce and traveling public with less exposure; and methods for evaluating new equipment on actual construction projects.

**6. Innovative Concrete Pavement Joint Design, Materials, and Construction.** Potential products for this track include a new joint design, high-speed computer analysis techniques for joint performance, a more accurate installation scheme, and faster rehabilitation strategies. The problem statements in this track address the basics—joint design, materials, construction, and maintenance activities. The track also specifies research that will help develop breakthrough technologies and extremely high-speed joint repair techniques. This is a crosscutting track to ensure that all topics related to innovative joints are addressed. Much of the proposed research will develop important incremental improvements.

- 7. High-Speed Concrete Pavement Rehabilitation and Construction.** Faster techniques and higher quality can and must be accomplished in the future. This track addresses a series of activities, from the planning and simulation of high-speed construction and rehabilitation, precast and modular options for concrete pavements, and fast-track concrete pavement construction and rehabilitation, to the evaluation and technology transfer of high-speed construction and rehabilitation products and processes developed through research. Some high-speed construction issues will likely be investigated in tracks 1 and 3, and those efforts will be closely coordinated with this track.
- 8. Long Life Concrete Pavements.** The need for pavements that last longer between maintenance, restoration, or rehabilitation is integrated throughout the CP Road Map. However, this track draws attention to some specific research that may address pavement life approaching 60 years or more.
- 9. Concrete Pavement Accelerated and Long-Term Data Collection.** This track provides the infrastructure—such as testing methods and data collection and reporting tools—for a future national program that will plan accelerated loading and long-term data needs, construct test sections, and collect and share data. The problem statements in this track will explore which data are most useful and determine the amount of time needed to collect the data.
- 10. Concrete Pavement Performance.** This track addresses key elements of pavement management and asset management systems. Such systems determine if and how pavements meet performance characteristics for highway agencies and users. Research in this track will determine and address the functional aspects of concrete pavement performance, particularly factors such as tire-pavement noise, friction, smoothness, and others. Research also will provide rapid concrete pavement performance feedback and examine ways to schedule surface characteristics and condition improvements. Developing feedback loops in highway agencies' pavement management systems will be crucial to monitor performance effectively and rapidly.
- 11. Concrete Pavement Business Systems and Economics.** Roles and responsibilities are changing in the highway industry, affecting the way paving projects are designed, bid, built, and maintained. Contractors are being asked to assume more control of the operation and quality control inspections. By including warranty provisions in project contracts, owner-agencies are asking for additional assurance that pavements will be built and will perform as expected. Internationally, many countries have made dramatic changes in project funding methods and in the roles of contractors and suppliers. This track captures some important research that should be considered as this process of transformation continues in the United States. Problem statements cover topics such as contracting options, new technology transfer systems, public-private partnerships, and economic models.
- 12. Advanced Concrete Pavement Materials.** The problem statements in this track address the development of new materials and refine or reintroduce existing advanced materials to enhance performance, improve construction, and reduce waste. Many of the existing materials studied in this track have been used thus far on a small scale or in laboratory evaluations only. Many of them have not been used in the United States but show promise

based on work done in other countries. This track will experiment with such materials on a larger scale and will develop standards and recommendations for their use. The research will foster innovation in the development of additional, new, and innovative concrete pavement materials.

## **REACHING THE DESTINATION**

The CP Road Map is accompanied by a research management plan that outlines a progressive, cooperative approach to managing and conducting the research. Under this plan, organizations identify common interests, partner with each other in executing specific contracts, and, in the end, produce and share a product that is greater than the sum of the parts.

The research management plan emphasizes scope control, phasing of research, reporting, systems integration, voluntary peer review, maintenance of the research database, programwide technology transfer, and assistance to organizations that want to leverage their funds and human resources.

### **Philosophy for Managing Research**

The research management plan is based on these assumptions:

- The CP Road Map is a national research plan, not a plan solely for FHWA, but for State agencies and the industry as well.
- The CP Road Map is not restricted to any single funding source. Publicly financed highway research is decentralized and will probably remain so through the next highway bill.
- Even in a decentralized arena like research, it is possible—indeed, critical—for stakeholder groups to come together voluntarily. Federal, State, and industry research staff and engineers around the country are looking for more opportunities to pool their funds and other resources in win-win situations. The MC<sup>2</sup> is an example of a successful cooperative approach to research.
- The all-too-common disconnection between research results and implementation of those results must be fixed. Communication, technology transfer, and outreach activities must be elevated to the same level of importance as research itself.
- The CP Road Map is too comprehensive and too important for a part-time implementation effort. Managing the overall research program effectively and judiciously will require full-time, dedicated personnel with adequate resources.

### **Governing Structure**

In line with this general philosophy, the research management plan outlines a four-tier system of participation and responsibility: an executive advisory committee, an administrative support group, research track team leaders, and sustaining organizations.

A triparty executive advisory committee, representing FHWA, State DOTs, and industry, will provide broad oversight of the CP Road Map. It will be a decisionmaking and policymaking facilitation group with many responsibilities, including:

- Assembling research track team leaders.
- Promoting partnering arrangements.
- Ensuring adequate integration of research across tracks.
- Developing and implementing a strategy to ensure that software products developed through various research tracks will be compatible with each other.
- Identifying new research program areas.
- Overseeing updates to and maintenance of the research database.
- Developing a comprehensive technology transfer and training program for products of the CP Road Map.
- Developing a communications effort to keep the CP Road Map and its products in front of stakeholders and the public.
- Conducting self-evaluation studies.
- Keeping the momentum focused on outcomes, not just output.

An administrative support group will provide professional management services for the executive advisory committee and, to a lesser degree, the research track team leaders. It will be the “doing” body for coordination and support activities, like maintaining the research database.

Research track team leaders will coordinate and oversee all activities within a specific research track:

- Validating and updating the track.
- Developing broad problem statements into specific, separate research projects, with scopes of work, timelines, and budgets.
- Identifying organizations to conduct or partner in the research.
- Establishing and overseeing subordinate technical expert working groups to guide complex work.
- Ensuring proper integration of work within the track and across track lines.
- Developing status reports.

Sustaining organizations—agencies, consultants, universities, professional associations, and other organizations with specialized interests and skills that are interested in pooling dedicated funds—will assume responsibility for conducting research through cooperation, partnerships, and funding agreements. Some people and organizations will assume multiple roles.

In addition, sustaining organizations conducting research under the CP Road Map may retain full fiscal and technical control of the work under their jurisdictions. The key to successful conduct of the research, however, is cooperation, and the research management plan facilitates and supports cooperative efforts.

## **THE CP ROAD MAP TRACKS AND SUBTRACKS**

The CP Road Map is a 7- to 10-year plan for concrete pavement research consisting of the following tracks and subtracks.

The general range of costs associated with each track represents the time dedicated to the CP Road Map by multiple stakeholders who contributed to its development. The support needed for this effort comes from in-kind services and funding provided by a number of participants including industry organizations, State DOTs, and Federal agencies. These estimates are subject to change as the CP Road Map evolves.

**1. Performance-Based Concrete Pavement Mix Design System (\$30–68 M\*)**

- Portland Cement Concrete (PCC) Mix Design System Development and Integration.
- PCC Mix Design Laboratory Testing and Equipment.
- PCC Mix Design Modeling.
- PCC Mix Design Evaluation and Implementation.

**2. Performance-Based Design Guide for New and Rehabilitated Concrete Pavements (\$41–60 M)**

- Design Guide Structural Models.
- Design Guide Inputs, Performance Models, and Reliability.
- Special Design and Rehabilitation Issues.
- Improved Mechanistic Design Procedures.
- Design Guide Implementation.

**3. High-Speed Nondestructive Testing and Intelligent Construction Systems (\$20–41 M)**

- Field Control.
- Nondestructive Testing Methods.
- Nondestructive Testing and Intelligent Control System Evaluation, and Implementation.

**4. Optimized Surface Characteristics for Safe, Quiet, and Smooth Concrete Pavements (\$25–54 M)**

- Concrete Pavement Texture and Friction.
- Concrete Pavement Smoothness.
- Tire-Pavement Noise.
- Integration of Concrete Pavement Surface Characteristics.
- Evaluation of Products for Concrete Pavement Surface Characteristics.
- Concrete Pavement Surface Characteristics Implementation.
- Other Concrete Pavement Surface Characteristics.

**5. Concrete Pavement Equipment Automation and Advancements (\$26–56 M)**

- Concrete Batching and Mixing Equipment.
- Concrete Placement Equipment.
- Concrete Pavement Curing, Texturing, and Jointing Equipment.
- Concrete Pavement Foundation Equipment.

- Concrete Pavement Reconstruction Equipment.
  - Concrete Pavement Restoration Equipment.
  - Advanced Equipment Evaluation and Implementation.
- 6. Innovative Concrete Pavement Joint Design, Materials, and Construction (\$10–15 M)**
- Joint Design Innovations.
  - Joint Materials, Construction, Evaluation, and Rehabilitation Innovations.
  - Innovative Joints Implementation.
- 7. High-Speed Concrete Pavement Rehabilitation and Construction (\$10–20 M)**
- Rehabilitation and Construction Planning and Simulation.
  - Precast and Modular Concrete Pavements.
  - Fast-Track Concrete Pavements.
  - Rehabilitation and Construction Evaluation and Implementation.
- 8. Long Life Concrete Pavements (\$11–17 M)**
- Pavement Strategy for Long Life Concrete Pavements.
  - Construction and Materials for Long Life Concrete Pavements and Overlays.
  - Long Life Concrete Pavement Implementation.
- 9. Concrete Pavement Accelerated and Long-Term Data Collection (\$10–16 M)**
- Planning and Designing Accelerated Loading and Long-Term Data Collection.
  - Preparation of Data Collection/Testing Procedures and Construction of Test Road.
  - Accelerated Loading and Long-Term Data Collection Implementation.
- 10. Concrete Pavement Performance (\$3–4 M)**
- Technologies for Determining Concrete Pavement Performance.
  - Guidelines and Protocols for Concrete Pavement Performance.
- 11. Concrete Pavement Business Systems and Economics (\$21–31 M)**
- Concrete Pavement Research and Technology Management and Implementation.
  - Concrete Pavement Economics and Life Cycle Costs.
  - Contracting and Incentives for Concrete Pavement Work.
  - Technology Transfer and Publications for Concrete Pavement Best Practices.
  - Concrete Pavement Decisions with Environmental Impact.
- 12. Advanced Concrete Pavement Materials (\$11–23 M)**
- Performance-Enhancing Concrete Pavement Materials.

- Construction-Enhancing Concrete Pavement Materials.
- Environment-Enhancing Concrete Pavement Materials.

## **\$218–405 M Total**

\*All numbers are rounded.

## **ORGANIZATION OF VOLUMES I AND II**

The CP Road Map is published in two volumes. Volume I contains the executive summary, plus eight chapters:

- Chapter 1 describes the background and need for the CP Road Map.
- Chapter 2 tells how the CP Road Map was developed.
- Chapter 3 provides an overview of the 12 tracks of planned research.
- Chapters 4 through 7 describe the critical issues and objectives that the CP Road Map addresses in the areas of design, mixtures and materials, construction, and pavement management/business systems.
- Chapter 8 describes the innovative research management plan that will guide the conduct of research.

Volume II contains the executive summary and describes in detail the 12 tracks of planned research:

- Each track begins with introductory material that summarizes the goal and objectives for the track and the gaps and challenges for its research program.
- A phasing chart is included to show the approximate sequencing of the problem statements in the track.
- A table of estimated costs provides the projected cost range for each problem statement, depending on the research priorities and scope determined in implementation.
- The problem statements within each track are grouped into subtracks. Each subtrack is introduced by a brief summary of the subtrack's focus and a table listing the titles, estimated costs, products, and benefits of each problem statement in the subtrack.
- Each subtrack begins with a framework problem statement in which the subtrack work is planned in more detail.
- The problem statements then follow.

Each problem statement clearly defines tasks that need to be performed to produce a desired product or achieve a desired objective. Each problem statement will need to be developed into appropriate research project statements with detailed descriptions of the research to be accomplished, specific budgets, and definite timelines.

Many conventional concrete pavement topics are integrated across the research tracks in the CP Road Map. Using the CP Road Map database, distinct topic areas can be easily identified and pulled out of the tracks into their own tables. For example, the following three important



research topics are addressed in a number of tracks. Near the end of volume II, cross-reference tables list the relevant problem statements for each of these topics:

- Concrete pavement foundation and drainage.
- Concrete pavement maintenance and rehabilitation.
- Environmental concrete pavement advancements.

### **HOW CAN YOU PARTICIPATE?**

Beginning a long-term research program is a long, slow process. In this case, the CP Road Map provides a framework for moving forward.

Stakeholders in the concrete pavement community are invited to participate:

- To receive a printed copy of the full two-volume CP Road Map, with complete problem statements (available mid-2005), contact Peter Kopac, FHWA, 202-493-3151, [peter.kopac@fhwa.dot.gov](mailto:peter.kopac@fhwa.dot.gov).
- An electronic version of the CP Road Map and the two-volume report will be available on the FHWA Web site in mid-2005. See [www.tfhr.gov/](http://www.tfhr.gov/).
- For additional information, go to [www.tfhr.gov](http://www.tfhr.gov) and search for CP Road Map.



## CHAPTER 1. WHY A LONG-TERM RESEARCH PLAN FOR CONCRETE PAVEMENTS?

For generations, concrete has been the workhorse for long life, dependable pavements. By generally performing well for many years beyond their original design life, concrete pavements have provided a substantial return on taxpayers' investments.

For most of the 20<sup>th</sup> century, the same materials—aggregate, portland cement, and water—were used in concrete for pavements, with only minor refinements. It was a fairly forgiving, high-tolerance formula. Mixes made with portland cement and high-quality aggregates allowed some variations in subgrade quality, construction practices, and other variables without sacrificing pavement performance. For generations, too, the emphasis was on constructing new pavement miles, and the industry had the luxury of keeping traffic off new concrete pavements for several days, even weeks, while the concrete developed its internal maturity and design strength.

Over the past 15 years, however, the concrete pavement industry has experienced more changes than in the preceding 80 years, and these changes are turning the process of building concrete pavements on end. Some of the ongoing environmental, social, and economic trends affecting the industry are that:

- Today's concrete mix designs integrate a plethora of new, sometimes marginal, materials, reducing tolerance for materials variations and sometimes resulting in serious compatibility problems.
- Motorists have become more demanding. They want smoother, quieter pavements than ever before, and they do not want to be delayed by road closures or work zones for road construction or repair. They want paving crews to "get in, get out, and stay out."
- Most of the highway system has been constructed, so the emphasis has shifted from building new miles of pavement to rehabilitating existing ones, requiring a wider variety of concrete pavement solutions.
- A serious squeeze on capital for pavements is reducing dollars available for upfront project costs.
- Growing environmental pressures are affecting mix designs and construction practices.
- Pavements are carrying significantly more and heavier traffic than ever before, and the trend will continue. According to industry projections, a lane-mile of pavement built in 2015 will have to carry 70 percent more trucks than a lane-mile built in 1995.

In this environment, the old system for constructing concrete pavements no longer works. In recent years, pavement failures unheard of 25 years ago have occurred. The industry has tried to stay ahead of the trends, but improvements in concrete pavement construction have been incremental, inconsistently implemented, and sometimes only marginally successful. In the coming decades, changes such as those described above will only increase, as will the consequent challenges for the concrete pavement community.

To achieve concrete pavement's full potential in the 21st century, the industry should respond to these trends soon with dramatic, even revolutionary, improvements. The improvements cannot

be piecemeal. They should be the result of a carefully developed and aggressively implemented strategic plan for research and technology transfer. The CP Road Map is that plan.

## **NEW TRENDS, NEW NEEDS**

The following sections describe in more detail the trends listed above. Changes occurring in the concrete industry are interrelated, exacerbating the resulting challenges.

### **Materials and Mixes**

Perhaps the most significant change in recent years is in concrete pavement mixtures. Mixtures are becoming more and more complex and are no longer so forgiving.

Many factors have led to the use of new materials in concrete. For example, to make fast-track or other special-use mixes, chemical additives are included commonly now in mix designs. Fly ash and slag also are being added to mixtures to replace some of the portland cement and enhance certain concrete mix characteristics, like reduced alkali-aggregate reaction and increased resistance to attack by sulfates in soil and water.

Ironically, though, new materials or additives that solve one problem can cause other, unforeseen problems, often related to materials incompatibility. The host of aggregate, cement, and mineral and chemical admixture sources from which to choose makes it difficult to develop mix designs that perform consistently; concrete can fail with only moderate variations in materials from supplier to supplier. There is no longer any room for error. In addition, complex mixtures that perform satisfactorily under lab conditions can be less predictable under actual field conditions.

The industry needs improved, reliable quality control systems for ensuring predictable, reproducible performance of today's complex mixes, pavement after pavement after pavement.

### **Motorists' Expectations**

Pavement users (including funding providers) require a certain level of pavement functionality and performance. Motorists are demanding quieter and smoother pavements that improve the driving experience and do not adversely affect the communities they abut. Pavement surfaces should be perfected to eliminate joint noise and tire whining, while continuing to provide a safe level of friction and reduced tire hydroplaning and spraying when wet.

Transportation agencies, concrete pavement engineers, materials providers, and contractors need new tools and strategies for better understanding and controlling pavement surface characteristics such as smoothness, friction, noise, spray and drainage, rolling resistance, and visibility. Traffic noise, too, is a growing problem in urban areas. The industry must understand concrete pavement's role in this phenomenon and provide balanced solutions.

In addition, motorists have no patience for long road closures or work zone delays. The speed of completing construction, repair, and rehabilitation work has become a critical issue, with mottos like "fast-track construction" and "get in, get out, and stay out" becoming common industry themes. Needed solutions include better use of available material on the roadway and quicker and timelier inspections.

## **Shift from Traditional Concrete Pavement Construction**

In the past 15 years or so, with most of the highway system built and in service, the industry's emphasis has changed from constructing new pavements to repairing and rehabilitating existing ones. According to a recent study by The Road Information Program, pavements on 25 percent of the Nation's major metropolitan roads—interstates, freeways, and other principal arterial routes—are in poor condition.<sup>(1)</sup> In the next few years, more than 25,000 miles of the Nation's highways will require serious attention. Up to 75 percent of pavements already identified as needing improvement are light-service pavements.

To remain competitive, the concrete pavement industry should be able to deliver affordable alternatives for a variety of road repair, maintenance, and rehabilitation needs. What truly is needed is the next generation of a mix of fixes: a menu of viable, cost effective concrete pavement solutions that provide concrete's durability and strength for the short or very long term.

The industry is already experimenting with different types of concrete overlays—bonded, unbonded, and whitetopping—each distinguished by the type of existing pavement it covers. Because of cost, time required for construction, and misconceptions about overlays, however, these alternatives nationally have had only minimal impact. The industry needs new overlay design approaches, lower cost strategies, and faster construction methods.

The mix of fixes could also include, for example, two-lift construction, in which a thin overlay of superior concrete mixture is placed on a thick layer of lower quality concrete; stop-gap rehabilitation projects; and staged improvements, in which short-term pavements are later used as subbase when their design life is over. Some solutions could focus on improving pavement foundations so that thinner pavements can provide the same level of service as traditional, thicker pavements.

Different mix designs for different solutions exacerbate quality control challenges related to materials compatibility and fast-track construction environments.

## **Capital Squeeze**

The level of funding available for pavement repair and rehabilitation is not keeping pace with needs. In 2004, State and local funding for road and bridge improvements was down 18 percent from 2002 levels, and restraints on domestic budgets are not likely to end anytime soon. This directly relates to the need for a full array of concrete pavement products to provide an affordable mix of fixes that allows agencies to properly distribute limited funds.

Static or reduced public agency funding is spurring the transfer of roles and responsibilities from State and local transportation agencies to the construction industry. This transfer includes a shift from method specifications to end-result, or performance, specifications. Mix designs, quality control, end-result testing, warranties, design-build, etc., require more expertise from the contractor than ever before. Contractors and agencies alike need better tools for monitoring, controlling, and ensuring desired pavement performance.

These tools include software for integrating mix designs with structural designs and construction inspections. They include software for conducting high-speed analyses and prediction of mix performance during the critical 72-hour period when concrete operations have such a significant impact on overall pavement performance. They include new equipment and testing methodologies that will help control the product during construction, reducing variability.

It is difficult to reduce costs while maintaining predictable service. The industry needs better methods and tools for identifying and addressing cost issues, testing different designs, conducting life cycle cost analyses, and using marginal materials.

### **Environmental Pressures**

Pavements also should meet ever-more demanding environmental challenges. For example, rainwater runoff issues are driving the need to develop porous pavements for specific applications, like parking lots and curb and gutter. In cold climates where snow is an issue, the salt brine placed on pavements to improve safety actually may cause premature damage to the concrete.

Quality building materials are harder to come by, and new sources are not being brought online, increasing the use of marginal materials. The cement industry, under pressure to reduce harmful byproducts of portland cement manufacture, is increasing its use of supplementary cementitious materials, including recycled materials like fly ash (captured from exhaust gases of coal-burning electricity generating plants) and slag (tapped from the waste that floats to the top of iron blast furnaces).

As described earlier, using these new or marginal materials requires advancements in mix design, new construction methods that incorporate marginal mix designs, and, especially, quality control systems to ensure that satisfactory performance can be reproduced reliably.

### **Congestion and Loads**

Pavements are the backbone of the Nation's transportation system and are essential to its economic well-being. Virtually all of the goods produced and sold in this country travel on the Nation's highways. From 1970 to 1998, the average daily highway traffic volume increased 130 percent, while average daily loading increased 580 percent.

By 2020, the U.S. population is predicted to grow by 50 million people. Vehicle travel is expected to increase by about 42 percent and heavy truck travel by 49 percent, putting even greater stress on the Nation's roadways. Without additional lane capacity, and with projected increases in truck traffic, a lane-mile of pavement built in 2015 will have to carry 70 percent more trucks than a lane-mile built in 1995.

Clearly, concrete pavements can carry heavy-duty truck traffic, but even this area has room for advancement. For example, the industry needs improved foundation designs that allow for better assignment of loads through the slab and better drainage mechanisms.

As congestion increases, access to facilities for constructing, maintaining, and rehabilitating pavements will become more difficult. Automobiles, trucks, the pavement, and neighborhoods

abutting the pavement will all have to coexist. This will have a dramatic impact on pavement programs, including initial pavement selection, speed of construction, rehabilitation and maintenance strategies, and budgets. Developing concrete pavement systems to address these needs is a critical challenge.

## **NEW NEEDS, A NEW GENERATION OF SOLUTIONS**

The bottom line is that one size no longer fits all. The concrete pavement industry must reinvent itself and develop a generation of pavement solutions for the 21st century.

What exactly would this new generation of solutions look like? How would they be developed? With AASHTO, ACPA, FHWA, PCA, State agencies, universities, and other organizations working relatively independently on specific challenges, how can stakeholders agree on the answers, establish common priorities, reduce duplication of effort, and make the solutions a reality?

To answer these questions, FHWA needs a unique long-term research plan with the following characteristics:

- **Strategic.** The CP Road Map should deliver performance-based concrete pavement systems that dramatically affect the way concrete pavements are designed and constructed. Performance-based concrete pavement systems use sophisticated and objective quality control systems at every step of a pavement project to ensure the desired performance is achieved.
- **Innovative.** The road map should result in revolutionary new technologies and processes for constructing safe, quiet, and durable pavements for a variety of traffic, loading, and other service needs (a mix of fixes) quickly, at minimum cost, and with materials that require higher compatibility standards and controls..
- **Embraced by the entire stakeholder community.** The CP Road Map should be developed by, and reflect the needs of, all stakeholder groups.
- **Not bound by cost or time limitations, or tied to any one agency or pot of money.** The CP Road Map should lead the concrete pavement community to overcome hurdles, pool their resources, and jointly conduct, coordinate, and implement the research over a period of 7 to 10 years.
- **Implementable.** The CP Road Map should include strategies to quickly move useful new products and systems to the field.
- **Accompanied by a research management plan.** The management plan should effectively guide the conduct and coordination of research outlined in the CP Road Map.

The following chapters describe how such a plan was developed, provide an overview of the resulting CP Road Map, and outline an innovative research management plan for conducting the research.





## CHAPTER 2. CP ROAD MAP DEVELOPMENT PROCESS

The team charged with developing the CP Road Map conducted the following activities:

- Completed a literature search and developed a research database.
- Solicited input from the broad concrete pavement community.
- Identified and organized research needs and objectives into a cohesive, strategic research plan.

### LITERATURE SEARCH/RESEARCH DATABASE

The literature search consisted of two parts. First, information about all recently completed and ongoing research projects was entered into a research database. This database later was used as a filter to ensure that the new research plan does not duplicate existing research.

Second, several research and technology plans developed by other organizations were reviewed to identify concepts that should be included in the CP Road Map. These plans included:

- FHWA: *Building for the Future—A Technology Program for Portland Cement Concrete Pavements.*<sup>(2)</sup>
- Innovative Pavement Research Foundation (IPRF): “Creating a New Generation of Pavements.”<sup>(3)</sup>
- *Vision 2030: A Vision for the U.S. Concrete Industry.*<sup>(4)</sup>
- National Academies of Science Report NMAB-484: *Nonconventional Concrete Technologies.*<sup>(5)</sup>
- National Highway Research and Technology Partnership Forum Infrastructure Renewal Working Group: *Infrastructure Renewal Research Agenda.*<sup>(6)</sup>
- Center for Portland Cement Concrete Pavement Technology (PCC Center) Research Committee research plans.
- TRB Committee A2FO1 research plans.
- ACPA research plans.

Although each of these plans was uniquely valuable, none contained a fully integrated, sequential, cohesive series of research statements that would dramatically change the way concrete pavements are designed and built. Many of the plans, however, did include individual research statements that, on their own merit, were incorporated into the CP Road Map planning process and research database. The CP Road Map development process is illustrated in figure 1.

## Research Database

A database of recent and in-progress concrete pavement-related research was developed.

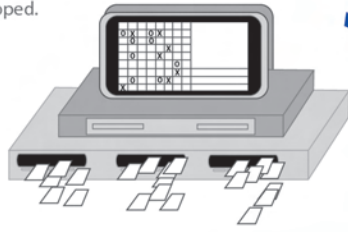

## Pavement Management/Business Systems

## Construction

## Design

## Mix and Materials

## 5 Major Brainstorming Events

Several hundred stakeholders identified critical issues in design, mix and materials, construction, and pavement management/business systems. In a reciprocal brainstorming process, participants at each event finetuned and added to previous discussions.

## Gaps in Research

The research objectives were filtered through the research database to identify gaps in research.

## Research Gaps Determined

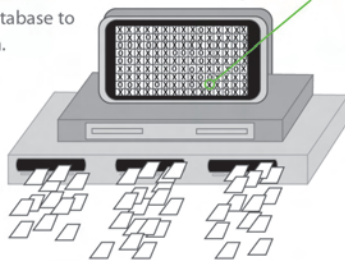

## Research Objectives

The critical issues identified at the brainstorming events were developed into dozens of specific research objectives.

## Problem Statements

Gaps in research became the basis for 250 problem statements.

## Track Integration

Problem statements were finetuned, sorted and resorted, and scheduled into phased tracks of research.



## The 12 Tracks

Track 1 - Mix Design  
Track 3 - Nondestructive Testing  
Track 5 - Equipment Advancements  
Track 7 - Rehabilitation & Construction  
Track 9 - Data Collection  
Track 11 - Business & Economics

Track 2 - Design Guide  
Track 4 - Surface Characteristics  
Track 6 - Innovative Joints  
Track 8 - Long-Life Concrete  
Track 10 - Pavement Performance  
Track 12 - Advanced Materials

Figure 1. CP Road Map development process.

## **BRAINSTORMING EVENTS**

Five major brainstorming and feedback sessions were conducted at the following events: the October 2003 meeting of the MC<sup>2</sup> in Ames, IA; a special November 2003 regional workshop for Eastern and Southern stakeholders in Syracuse, NY; the May 2004 meeting of the ACPA in Kansas City, MO; a special January 2004 regional teleconference for Western stakeholders; and, in October 2004, a final meeting of national stakeholders hosted by FHWA at the Turner-Fairbank Highway Research Center.

### **Stakeholders**

Through these events, in addition to more than 20 presentations at workshops around the country (see appendix A for a detailed list of events), more than 400 engineers and managers representing every stakeholder group provided direct input into the CP Road Map.

Participating stakeholders included:

- State and local DOTs.
- FHWA.
- ACPA, including several State chapters.
- PCA.
- AASHTO.
- NRMCA.
- TRB/NCHRP Committees.
- APWA.
- NACE.
- Contractors.
- Materials suppliers.
- Research universities, especially departments conducting applied research.
- Private concrete testing laboratories.

### **Brainstorming Strategies**

It is easy to talk about soliciting input from stakeholders. But in a project of this size and complexity, it was critical to have a system to help focus stakeholders' brainstorming process. In addition, stakeholders came to the brainstorming events with specific goals or projects already in mind. It was important to help participants look beyond their own pet projects.

Two brainstorming strategies were used. First, participants responded to draft, big-picture vision statements identifying research needed to provide the concrete pavement characteristics that will meet the needs of end users and owners well into the future. Through guided activities, participants evaluated, revised, added to, subtracted from, and prioritized the vision statements. This process helped participants dream big.

Then, in small groups, participants identified specific critical issues in each of the following areas that must be resolved through research to achieve desired pavement characteristics:

- Materials and mixtures.
- Design.
- Construction.
- Pavement management/business systems.

Participants discussed new tools they need and existing ones that need to be improved. They discussed systems that must be in place, including financing and bidding systems. They identified obstacles that must be overcome.

Again and again, stakeholders who participated in the brainstorming events said they needed more and better analysis tools for measuring the hows and whys of pavement failures and successes—that is, for measuring pavement performance. Better quality assurance and quality control methods and tools are needed for every stage of the pavement system, from design through maintenance and rehabilitation. Because variables in each stage affect the other stages, the methods and tools must be integrated across stages.

From these central concepts of pavement performance and systems integration, the following overall vision for the CP Road Map was developed:

*By 2015, the highway community will have a comprehensive, integrated, and fully functional system of concrete pavement technologies that provides innovative solutions for customer-driven performance requirements.*

Based on this goal and stakeholder input at the brainstorming sessions, dozens of specific research objectives were identified. See appendix B for a complete list of objectives and the corresponding research tracks into which the objectives were eventually categorized. In general, they can be categorized as:

- Maximize public convenience.
- Improve the driving experience.
- Integrate design, mixtures and materials, and construction with pavement performance predictions.
- Improve pavement reliability.
- Identify new and innovative business relationships to focus on performance requirements.
- Constrain costs while improving pavement performance.
- Protect and improve the environment.
- Expand opportunities to use concrete pavement.

The objectives were filtered through the database of existing research to determine gaps in research. These gaps became the basis for problem statements. Approximately 250 problem statements were written, reviewed, and fine tuned. Final versions of the problem statements were added to the research database as work to be accomplished via the CP Road Map.

Identifying critical research issues and objectives was an ongoing, reciprocal process. Participants at successive brainstorming events responded to, refined, and prioritized critical issues and objectives identified at previous events. For the duration of this project, participants at

the brainstorming events and stakeholders unable to attend were invited to submit additional feedback and ideas through the project Web site.

## **PUTTING IT ALL TOGETHER IN THE CP ROAD MAP**

FHWA requested a strategic research plan outlining up to a decade of integrated activities, including research, technology development and implementation, and technology transfer, with ample details to guide technical panels that will implement the plan. Therefore, the CP Road Map is a synopsis of research needs outlined in problem statements and organized in tracks of research.

Between brainstorming events, the problem statements were revised and improved constantly. Some were culled completely; others were fine tuned; some closely related concepts were combined, all with feedback from stakeholders. The problem statements were sorted and resorted in a variety of ways to integrate and organize the statements into the most appropriate tracks for facilitating ownership by various stakeholder groups. This ownership will be critical for successful conduct of the research.

The integration process resulted in identifying and developing 12 research tracks. This manageable number of tracks is in line with recommendations from the FHWA panel and encourages the community to focus on research with the highest potential payback. Some tracks closely mimic the trends identified in chapter 1 of this report as driving the need for the CP Road Map.

Each research track was organized into subtracks of research problem statements that, as research is conducted, will lead to the achievement of a major objective or development of a major product. This organizational strategy lends itself to scheduling and strategically integrating related research.

Specific goals, expected outcomes, and estimated budgets were defined for each research track and subtrack. Nine of the 12 tracks were developed with time-sensitive problem statements, carefully phased into a 7- to 10-year sequence of research. These nine tracks actually identify complete research programs in themselves. The three remaining tracks contain problem statements that are not time sensitive and not sequenced; these tracks include several independent, long-range research problem statements.

Several research problem statements were coordinated, or linked, with research in other tracks to ensure an integrated approach to quality control for desired pavement performance. For example, pavement design models are linked to mix design and construction control; the linkages were built into the research database.

At a terminal event in October 2004, stakeholders provided final feedback on the CP Road Map. This event ensured that the CP Road Map's objectives are clear and its goals attainable; the research is a blend of the practical, incremental, and innovative; work priorities are clear; and the implementation strategy is innovative and doable.



## CHAPTER 3. WHAT DOES THE STRATEGIC ROAD MAP LOOK LIKE?

A 10-year research plan of this size and complexity cannot be absorbed in one quick skim-through.<sup>1</sup> This chapter is for readers who do not need all of the details but simply want an overview of the CP Road Map. Following is a summary of the road map, highlights of the research tracks and subtracks, and the general budget and timeline.

### SUMMARY

The CP Road Map consists of more than 250 problem statements organized into 12 topical research tracks:

1. Performance-Based Concrete Pavement Mix Design System.
2. Performance-Based Design Guide for New and Rehabilitated Concrete Pavements.
3. High-Speed Nondestructive Testing and Intelligent Construction Systems.
4. Optimized Surface Characteristics for Safe, Quiet, and Smooth Concrete Pavements.
5. Concrete Pavement Equipment Automation and Advancements.
6. Innovative Concrete Pavement Joint Design, Materials, and Construction.
7. High-Speed Concrete Pavement Rehabilitation and Construction.
8. Long Life Concrete Pavements.
9. Concrete Pavement Accelerated and Long-Term Data Collection.
10. Concrete Pavement Performance.
11. Concrete Pavement Business Systems and Economics.
12. Advanced Concrete Pavement Materials.

The first nine tracks are time phased. The research will be conducted sequentially, and at the end of the track, a final goal (e.g., a fully functional product or products) will have been achieved. The last three tracks are not time sensitive.

The problem statements in each track have been organized into subtracks of specific areas of research. As described in the research management plan (chapter 8), each track will be managed by a track team leader or team leaders with a technical working group. Each track includes its own budget, begins with a framing study in which the work is planned in more detail, and includes specific implementation activities.

The various tracks are integrated in strategic areas. For example, reducing mix performance variability (track 1) will require equipment advances (track 5). Validating and calibrating mix design models (track 1) will require enhanced data (track 9). Constructing long life pavements (track 8) will require new mix and structural design techniques (tracks 1, 2, and 3).

---

<sup>1</sup> See volume II of this report for a detailed description of the CP Road Map and its tracks, subtracks, problem statements, timelines, and budgets.

Three important research topics included in these tracks, but not immediately perceivable, are:

1. Concrete pavement foundation and drainage.
2. Concrete pavement maintenance and rehabilitation.
3. Environmental concrete pavement advancements.

These are described in chapter 8 of this report under “Cross-Referenced Database Tables.”

## **PROBLEM STATEMENTS**

Each problem statement clearly defines the tasks that must be performed to produce a desired product or achieve a desired objective. Because this CP Road Map was not developed for a single budget or funding source, or with a particular client in mind, it was not possible to put this into a format ready for bid.

Developing detailed research statements may take six to eight experts 18 hours to develop, resulting in more than 100 person-hours of time and experience per statement.

It should be noted that many of the problem statements identify products that are self-standing and usable. It is not necessary to complete the entire track to obtain useful and important outputs.

## **RESEARCH PRIORITIES**

Emphasizing any particular track could be at the expense of other equally critical ones. The 12 research tracks were divided into type 1 and type 2 tracks, however, to help communicate a general sense of priorities identified by stakeholders.

Type 1 tracks focus on systemwide quality control and pavement surface characteristics. Participants at the brainstorming events overwhelmingly supported the importance of integrating mix design, structural design, and construction control for enhanced pavement performance. The innovative *2002 Guide for Design of New and Rehabilitated Pavement Structures* developed by NCHRP has prompted pavement engineers to think about pavement performance in a new way.<sup>(7)</sup> The top three tracks of the CP Road Map, therefore, will help lead the way to a new generation of concrete pavement solutions with systemwide quality control processes that ensure pavement performance. Because of the clearly emerging importance of pavement surface characteristics, based on interest in the concrete pavement industry and pressure from the traveling public, the surface characteristics track was included in the type 1 group.

The tracks are categorized as follows:

### **Type 1 Tracks**

1. Performance-Based Concrete Pavement Mix Design System.
2. Performance-Based Design Guide for New and Rehabilitated Concrete Pavements.
3. High-Speed Nondestructive Testing and Intelligent Construction Systems.
4. Optimized Surface Characteristics for Safe, Quiet, and Smooth Concrete Pavements.



## Type 2 Tracks

5. Concrete Pavement Equipment Automation and Advancements.
6. Innovative Concrete Pavement Joint Design, Materials, and Construction.
7. High-Speed Concrete Pavement Rehabilitation and Construction.
8. Long Life Concrete Pavements.
9. Concrete Pavement Accelerated and Long-Term Data Collection.
10. Concrete Pavement Performance.
11. Concrete Pavement Business Systems and Economics.
12. Advanced Concrete Pavement Materials.

## ESTIMATED BUDGET

Table 1 provides an estimated budget per track in millions of dollars for a period of 7–10 years.

Table 1. Estimated budget.

Track	Estimated Cost* (Millions)
1. Performance-Based Concrete Pavement Mix Design System	\$29.80–\$67.80
2. Performance-Based Design Guide for New and Rehabilitated Concrete Pavements	\$40.50–\$59.60
3. High-Speed Nondestructive Testing and Intelligent Construction Systems	\$19.60–\$41.10
4. Optimized Surface Characteristics for Safe, Quiet, and Smooth Concrete Pavements	\$25.40–\$54.25
5. Concrete Pavement Equipment Automation and Advancements	\$25.65–\$56.15
6. Innovative Concrete Pavement Joint Design, Materials, and Construction	\$10.00–\$15.30
7. High-Speed Concrete Pavement Rehabilitation and Construction	\$10.30–\$20.30
8. Long Life Concrete Pavements	\$10.50–\$16.60
9. Concrete Pavement Accelerated and Long-Term Data Collection	\$9.75–\$15.50
10. Concrete Pavement Performance	\$2.70–\$4.15
11. Concrete Pavement Business Systems and Economics	\$21.15–\$31.20
12. Advanced Concrete Pavement Materials	\$11.45–\$23.25
<b>All Tracks</b>	
<b>Total</b>	<b>\$216.80–\$405.20</b>

\*All numbers are rounded.

## TRACK HIGHLIGHTS

### Type 1 Tracks

These first four tracks require considerable integration across track lines. The modeling developed in one track invariably will be used in at least two other tracks to ensure proper analysis of performance.

#### *Track 1. Performance-Based Concrete Pavement Mix Design System*

##### Subtracks

1. PCC Mix Design System Development and Integration.
2. PCC Mix Design Laboratory Testing and Equipment.
3. PCC Mix Design Modeling.
4. PCC Mix Design Evaluation and Implementation.

This track will develop a practical yet innovative concrete mix design procedure with new equipment, consensus target values, common laboratory procedures, and full integration into both structural design and field quality control. As opposed to mix proportioning, mix design engineers a concrete mixture to meet a variety of property or performance targets. The process begins with the definition of the end product, and the various materials are then selected, proportioned, simulated, and optimized to meet the end-product goals. This track will develop mix design rather than mix proportioning. Figure 2 contains an illustration of a lab for developing advanced mixture designs.



Figure 2. Advanced labs for advanced mixture designs.

This ambitious track also lays the groundwork for the concrete paving industry to assume more mix design responsibility as State highway agencies move from method specification to a more advanced acceptance tool. To do this, however, the concrete paving industry and the owner agencies must be able to refer to a single document for state-of-the-art mix design.

The track provides a plan for research in the following areas:

- Integration of volumetric-based, property-based, performance-based, and functionally based mix designs and recycled materials into the mix design system.
- Identification of new and upgraded equipment and test procedures.
- Development of an expert system that connects test results to each other.
- Improved models to predict slab performance.
- Field evaluation and implementation procedures that provide a mechanism for user feedback.
- Technology transfer activities.

### Track Goal

Innovative concrete mix material selections and mix design procedures will produce economical, compatible, and optimized concrete mixes integrated into both structural concrete pavement design and construction control.

### Track Action Items

1. Develop a concrete lab of the future that will give the user a sequence of mix design tests and procedures that integrate structural design and quality control with material selection and proportioning.
2. Develop the tools necessary to predict the compatibility and effectiveness of concrete mixes under specific field conditions before paving begins.
3. Detect potential construction problems early and correct them quickly by using innovative quality control tools.
4. Detect potential long-term durability problems more effectively during both the mix design process and the construction quality control program.
5. Improve the ability to predict concrete mix properties and their relationship to slab behavior and performance (e.g., shrinkage, joint opening, and curing) using the next generation of advanced modeling techniques.
6. Identify and use innovative, nontraditional materials that accelerate concrete pavement construction, maintenance, and rehabilitation and/or extend product life at a fair cost.

### ***Track 2. Performance-Based Design Guide for New and Rehabilitated Concrete Pavements***

#### Subtracks

1. Design Guide Structural Models.
2. Design Guide Inputs, Performance Models, and Reliability.
3. Special Design and Rehabilitation Issues.
4. Improved Mechanistic Design Procedures.
5. Design Guide Implementation.

Under this track, the concrete pavement research community will attempt to develop a mechanistic approach to pavement restoration and preservation strategies. This track builds on the excellent comprehensive work done under NCHRP 1–37A (development of the *Mechanistic-Empirical Pavement Design Guide*).<sup>(8)</sup> The problem statements will continuously improve the

models, designs, rehabilitation efforts, and all aspects of the work done under NCHRP 1–37A. This track relies on a detailed understanding of the *Mechanistic-Empirical Pavement Design Guide*, committing researchers to the power of modeling and predictions. However, the CP Road Map also identifies the need for simplified mix design procedures for cities and counties, as well as a design catalog approach. Because many materials properties are important to design success, it is critical that the research conducted under this track be closely coordinated with that done in track 1 (Performance-Based Concrete Pavement Mix Design System). Figure 3 demonstrates advanced models for performance-based design.



Figure 3. Advanced models for performance-based design.

Empirical approaches to concrete pavement design are effective when the conditions remain nearly the same, the focus is on structural design, and the attention is not on understanding and managing distress or failure modes. The pavement design practice of today is primarily empirical, though the state-of-the-practice is moving toward mechanistic approaches. The primary source of much of today's pavement design is still the American Association of State Highway Officials (AASHO) road test of the 1950s. This one subgrade, one base, one climate, limited traffic design guide was created using better-than-normal construction practices. Data analysis techniques were also fairly basic and the incorporation of reliability was insufficiently understood. Moreover, the AASHO road test did not incorporate many of the concepts and products used in concrete pavement practice today, including concrete overlays, permeable bases, different cements, dowel bar retrofits, and other necessary repairs.

The state-of-the-practice today is moving rapidly toward M-E approaches, particularly with the release of the *Mechanistic-Empirical Pavement Design Guide* and the expressed interest of many States. These M-E approaches will allow the designer to account for new design features and characteristics, many materials properties, changing traffic characteristics, and differing construction procedures (such as curing and day/night construction). The designer also can now consider additional design features and focus more on pavement performance, including limiting key distress types.

In continuing this work, this track not only looks to the next generation of modeling improvements, but also seriously considers the integration of design with materials, construction, presentation, and surface characteristics. This track also explores the development of new high-speed computer analysis tools for optimizing pavement design that can address changes to multiple inputs and thus offer better data on potential life cycle costs and reliability.

### Track Goal

Mechanistic-based concrete pavement designs will be reliable, economical, constructible, and maintainable throughout their design life and meet or exceed the multiple needs of the traveling public, taxpayers, and the owning highway agencies. The advanced technology developed under this track will increase concrete pavement reliability and durability (with fewer early failures and lane closures) and help develop cost effective pavement design and rehabilitation.

### Track Action Items

1. Develop viable (e.g., reliable, economical, constructible, and maintainable) concrete pavement options for all classes of streets, low-volume roads, highways, and special applications.
2. Improve concrete pavement design reliability, enhance design features, reduce life cycle costs, and reduce lane closures over the design life by maximizing the use of fundamental engineering principles through mechanistic relationships.
3. Integrate pavement designs with materials, construction, traffic loading, climate, preservation treatments, rehabilitation, and performance requirements to produce reliable, economical, and functional (noise, spray, aesthetics, friction, texture, illumination) designs.
4. Integrate traditional structural pavement design with materials, construction, traffic loading, climate, preservation treatments, rehabilitation, and performance inputs that will produce reliable, economical, and functional (noise, spray, aesthetics, friction, texture, illumination) designs.
5. Design preservation and rehabilitation treatments and strategies using mechanistic-based procedures that use in-place materials from the pavement structure to minimize life cycle costs and construction and maintenance lane closures.
6. Develop and evaluate new and innovative concrete pavement designs for specific needs (e.g., high traffic, residential traffic, parkways).

### ***Track 3. High-Speed Nondestructive Testing and Intelligent Construction Systems***

#### Subtracks

1. Field Control.
2. Nondestructive Testing Methods.
3. Nondestructive Testing and Intelligent Control System Evaluation and Implementation.

The research community has studied various nondestructive testing (NDT) technologies for nearly 20 years. While this technology is beginning to impact pavement management equipment and some hand-held test equipment in construction technology, NDT technology has not been applied extensively to concrete paving. The advancing technology could benefit both the

construction and inspection teams in several key ways. Figure 4 shows several examples of advancing technologies.



Figure 4. Technologies for monitoring pavement data and making real-time adjustments during construction.

The equipment industry faces both a technical challenge and the challenge of investing in a methodology without being certain of a market. Establishing a working group that properly frames the issues, agrees on the technologies, and prioritizes the work efforts is critical for overcoming this investment challenge.

Both industry and government will benefit from NDT by reducing reliance on slow and sometimes poorly managed small-sample testing programs. NDT technology can also be incorporated into an intelligent construction system (ICS) that automatically adjusts the paving process while informing contractors and inspectors of changes and/or deficiencies in construction. Continuous and real-time sampling will be configured to detect changes to the approved mix design and the preprogrammed line and grade values. NDT technology will also allow industry and government to use the data collected for long-term pavement management and evaluation. In this regard, track 3 has significant links to track 10 (concrete pavement performance).

The NDT/ICS methods developed in this track can measure the following properties that impact concrete pavement durability and performance:

- Pavement depth.
- Horizontal and vertical slab alignment.
- Subgrade support and variability.
- Steel location (dowels and tie bars).
- Concrete strength through the slab.
- Concrete temperature through the slab.

- Moisture loss.
- Smoothness.
- Tire/pavement noise potential.
- Air.

Many problem statements in this track relate to track 1 (Performance-Based Concrete Pavement Mix Design System) and track 2 (Performance-Based Design Guide for New and Rehabilitated Concrete Pavements). Software standards will also ensure that the public can link to any software that the private sector produces.

Finally, human factors are critical for both researching and implementing this track. Pavement engineers, materials testers, and contractors need to understand NDT fundamentals to avoid the black box syndrome—that is, trying to get a technology to do something that they do not understand in principle.

#### Track Goal

High-speed nondestructive quality control can continuously monitor pavement properties during construction to provide rapid feedback. As a result, adjustments made immediately can ensure a high-quality finished product that meets performance specifications.

#### Track Action Items

1. Perform NDT quality control tests and procedures that use continuous and real-time sampling to monitor performance-related concrete mix properties and reduce the number of human inspectors.
2. Improve construction operations by providing continuous and rapid feedback to make changes as immediately during the process.
3. Integrate data collection with materials management and pavement management systems to solve future problems and evaluate performance.

### ***Track 4. Optimized Surface Characteristics for Safe, Quiet, and Smooth Concrete Pavements***

#### Subtracks

1. Concrete Pavement Texture and Friction.
2. Concrete Pavement Smoothness.
3. Tire-Pavement Noise.
4. Other Concrete Pavement Surface Characteristics.
5. Integration of Concrete Pavement Surface Characteristics.
6. Evaluation of Products for Concrete Pavement Surface Characteristics.
7. Concrete Pavement Surface Characteristics Implementation.

FHWA and State highway agencies have learned from sophisticated opinion polling that American drivers value the quality of their ride experience. Over the past 2 decades, concrete pavement engineers have focused on improving pavement smoothness without jeopardizing surface friction or surface drainage characteristics. This difficult but important balancing act has

led to advancements in smoothness indices, longitudinal tining, and measurement equipment, to name a few. However, the relationship between surface texture and surface characteristics, as well as concrete pavement performance, has not yet developed fully. While smoother concrete pavements are being constructed, the relationships between texture, noise, splash and spray, and friction require further study before widely accepted solutions become available. Figure 5 illustrates an optimized pavement surface.



Figure 5. Optimized pavement surfaces for a safe, quiet, and smooth ride.

In some areas of the United States, drivers and residents have demanded a quieter ride and a quieter living experience. These demands often eliminate concrete pavement as a construction option, and in some cases have even led to the overlay of recently constructed concrete pavements. In the Phoenix, AZ, metropolitan area, for example, concrete pavements that have a harsh transverse texture make up nearly all of the freeway system. Because of noise complaints, these pavements are now being overlaid with an open-graded asphalt rubber wearing course. While this may seem radical to some, the approach is not new. Noise has been a major problem in some of the most densely populated areas of Europe for more than a decade. As a result, it has impeded concrete pavement construction there.

Most European nations now place thin asphalt-based wearing courses over their concrete pavements immediately after construction. However, some concrete surfacing solutions have been used successfully. These include thin, open-graded (porous) concrete wearing surfaces as well as exposed aggregate surfaces. Textures including fine longitudinal burlap drag and diamond grinding also are used to reduce noise.

To address noise impacts to highway abutters, FHWA regulations currently dictate the noise mitigation efforts required, if any, for new or expanded highway facilities. To date, these regulations have resulted in questions about whether noise walls are necessary, and if so, what their design should be. At the same time, automobile and tire makers have developed designs that meet more stringent friction (braking) demands, while at the same time reducing interior



noise. The time is quickly approaching, however, when pavement changes will be needed to help reduce noise, and concrete pavement engineers will need to find innovative materials and optimize pavement textures.

To meet this responsibility, the concrete pavement engineer must balance smoothness, friction, surface drainage, splash and spray, and noise to develop economical and long-lasting solutions for concrete pavement surfaces. Any long-term solution must include research and experimentation that examines the integration of these elements into an array of viable incremental solutions. One consideration is developing standardized noise measurement and analysis techniques. Pavement engineers must also better understand fundamental engineering properties to assess noise, friction, and smoothness, isolating better texturing options and tailoring solutions to location, traffic, and renewal requirements. Pavement engineers must understand the functional and structural performance of various solutions over time, as the data from many studies are sufficient to examine the relationships between noise and the other surface characteristics, including pavement durability.

The issues that must be explored include developing various standardized measurement techniques, understanding the tire-pavement interaction with various texturing options, predicting the life expectancy of any solution, and identifying possible repair and rehabilitation strategies for these pavements. Moreover, if noise criteria are ever imposed as design-build criteria, integration with national noise mitigation standards must be considered, and rational and achievable construction specification language must be developed.

### Track Goal

A better understanding of concrete pavement surface characteristics will provide the traveling public with concrete pavement surfaces that meet or exceed predetermined requirements for friction/safety, tire-pavement noise, smoothness, splash and spray, light reflection, rolling resistance, and durability (longevity).

### Track Action Items

1. Develop reliable, economical, constructible, and maintainable concrete pavement surface characteristics that meet or exceed highway user requirements for all classes of streets, low-volume roads, highways, and special applications.
2. Develop, field test, and validate concrete pavement designs and construction methods that produce consistent surface characteristics that meet or exceed highway user requirements for friction/safety, tire-pavement noise, smoothness, splash and spray, light reflection, rolling resistance, and durability (longevity).
3. Define the relationship between wet weather accident rates, pavement texture, and friction demand levels.
4. Determine the design materials and construction methods that produce different levels of short- and long-term surface microtexture, macrotexture, megatexture, and unevenness.
5. Determine the relationship between pavement texture levels (microtexture, macrotexture, megatexture, and unevenness) and surface characteristic performance levels (friction, noise, smoothness, splash and spray, rolling resistance, and light reflectivity).

6. Evaluate and develop high-speed, continuous measurement equipment and procedures for measuring texture, friction, noise, smoothness, splash and spray, rolling resistance, and other key surface characteristics.
7. Develop design and construction guidelines for concrete pavement surface characteristics, protocols, guide specifications, and associated technology transfer products.

## **Type 2 Tracks**

Type 2 tracks focus on diverse advancements, from equipment to construction processes to business and management systems.

### ***Track 5. Concrete Pavement Equipment Automation and Advancements***

#### Subtracks

1. Concrete Batching and Mixing Equipment.
2. Concrete Placement Equipment.
3. Concrete Pavement Curing, Texturing, and Jointing Equipment.
4. Concrete Pavement Foundation Equipment.
5. Concrete Pavement Reconstruction Equipment.
6. Concrete Pavement Restoration Equipment.
7. Advanced Equipment Evaluation and Implementation.

Figure 6 illustrates several equipment and technology advancements.

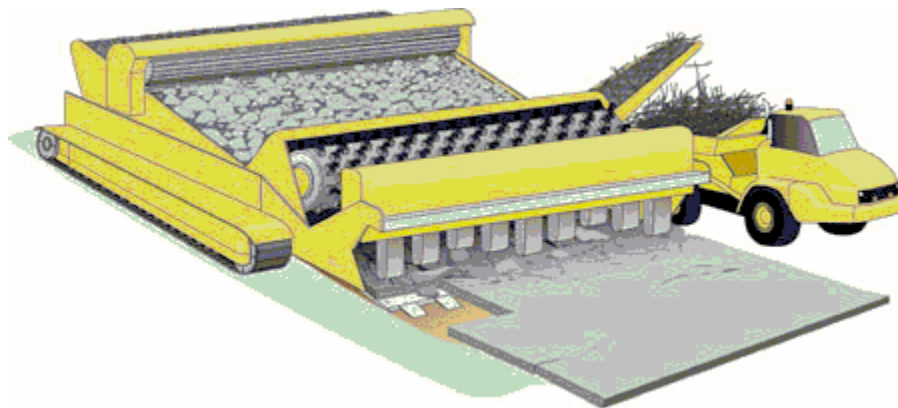

Figure 6. Equipment and technology advancements.

The problem statements in this track propose process improvements and equipment developments for high-speed, high-quality concrete paving equipment. Research on technologies like those listed below is needed to meet the concrete paving industry's projected needs and the traveling public's expectations for highway performance in the future:

- Next generation of concrete batching equipment.
- Next generation of concrete placement equipment that addressed new construction processes.
- Behind-the-paver equipment to improve quality, speed, and cost-effectiveness.
- Mechanized ways to place and control subdrains and other foundation elements.
- Next generation of equipment that will integrate the removal/replacement of the slab in one-pass construction.
- Improved repair processes that decrease the time of operations and expose the workforce and traveling public to less construction.
- Methods for evaluating the new equipment on actual construction projects.

Efforts in the area of equipment automation and advancements will require collaborative partnerships between equipment manufacturers, contractors, and State highway agencies. After equipment concepts have been established, it is hoped that contractors and industry will be willing to invest in the development of new equipment. Involving contractors and industry from the start is essential for ensuring the equipment is practical for actual implementation. This private funding also will help to deploy the new equipment into everyday practice much faster than if development and implementation costs were carried solely by the government.

Stringless, global positioning system (GPS) control of slipform paving equipment is just one example of many pioneering technologies that, if further developed and tested, could provide greater efficiency, lower costs, and increased performance for the concrete paving industry.

### Track Goal

Concrete paving process improvements and equipment advancements will expedite and automate PCC pavement rehabilitation and construction, resulting in high-quality concrete pavements, reduced waste, and safer working environments.

### Track Action Items

1. Develop batching equipment that will produce better quality concrete mixes by optimizing the materials used and allowing for rapid adjustment of mix proportions.
2. Improve paving techniques and equipment to produce higher quality concrete pavements, while optimizing material usage and reducing construction time and processes.
3. Improve techniques for curing, texturing, and jointing concrete pavements, while allowing pavements to be opened to traffic more quickly.
4. Improve equipment and techniques for expedited subbase stabilization and subdrain installation.
5. Develop equipment for rapid in-place reconstruction of concrete pavements using existing/recycled materials.
6. Improve and automate techniques and equipment for rapid concrete pavement restoration.
7. Introduce contractors and owner agencies to new advanced equipment and provide assistance for purchasing such equipment.

## ***Track 6. Innovative Concrete Pavement Joint Design, Materials, and Construction***

### Subtracks

1. Joint Design Innovations.
2. Joint Materials, Construction, Evaluation, and Rehabilitation Innovations.
3. Innovative Joints Implementation.

Concrete has a propensity to crack. Because controlling cracks is essential for pavement performance, joints are an important feature of concrete paving. As the FHWA Technical Advisory on Concrete Pavement Joints (T 5040. 30) explains, “The performance of concrete pavements depends to a large extent upon the satisfactory performance of the joints. Most jointed concrete pavement failures can be attributed to failures at the joint, as opposed to inadequate structural capacity.” (p. 1)<sup>(9)</sup>

Ideal joints must be relatively easy to install and repair, consolidate around the steel, provide adequate load transfer, seal the joint or provide for water migration, resist corrosion, open and close freely in temperature changes, enhance smoothness and low noise, and be aesthetically pleasing. Figure 7 contains a graphic interpretation of the goal in developing these techniques. Joint failure can result in faulting, pumping, spalling, corner breaks, blowups, and transverse cracking (if lockup occurs).

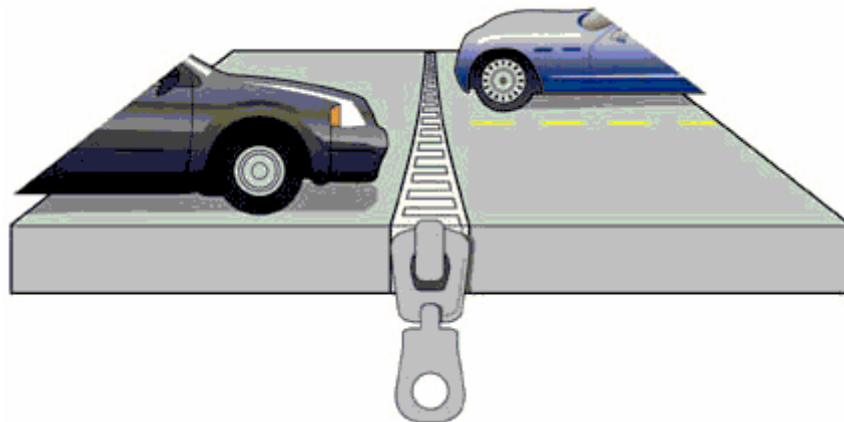

Figure 7. Breakthrough techniques for designing and rehabilitating joints.

The problem statements in this track address new and innovative joint design, materials, construction, and maintenance activities. There is much room in this research for innovative concrete pavement joint design, such as in research addressing the coefficient of thermal expansion and shrinkage issues. Additional incremental improvements to joint design, such as tie bar design for longitudinal joints, are addressed under track 2 (Performance-Based Design Guide for New and Rehabilitated Concrete Pavements). Much of the proposed research in this track

will develop important improvements, though the track also specifies research that will help develop breakthrough technologies. The problem statements also recognize that future joint repair will proceed quickly, and they propose research for accomplishing faster joint repair.

Here are a few of the concepts that will be investigated:

- Private and public sector knowledge and experience will be used to identify ways to enhance jointed pavements.
- Many jointed concrete pavements that have lasted many years without dowels will require retrofitting with dowels to control faulting. Techniques will be explored.
- Doweled joints will be designed to last 60 years in relatively heavy traffic.
- Continuously reinforced concrete pavements will solve the problem of joint lifespan by eliminating the joints entirely.
- Joints for concrete overlays (20-year-and-less performance life) have not been studied sufficiently. The cost of a doweled joint in thin pavement can be exceptionally high for the life expectancy. Research in this track will develop a scaled-down but fully functional joint for this product, with owners specifying a less robust but fully functional joint for the shorter design period.

### Track Goal

This track will identify, develop, and test new and innovative joint concepts for concrete pavements that are more cost effective, reliable, and durable than current alternatives.

### Track Action Items

1. Identify new and innovative alternatives to handling the forming, opening/closing, load transfer, and sealing for transverse and longitudinal concrete pavement joints.
2. Identify criteria for the design, materials, and construction of exceptionally long-lasting joints (e.g., more than 50 years). Also see track 8 (Long Life Concrete Pavements).
3. Determine optimum joint design for concrete overlays.
4. Determine optimum joint design for low-volume, long life pavements.
5. Develop an advanced, high-speed computational model for joint condition analysis that can joint improve design, materials, and construction.
6. Develop fully and field test to determine the cost-effectiveness, reliability, and durability of promising new and innovative joint designs.
7. Develop and validate rapid methodology for evaluating existing joint conditions so that joints can be preserved and repaired.

## ***Track 7. High-Speed Concrete Pavement Rehabilitation and Construction***

### Subtracks

1. Rehabilitation and Construction Planning and Simulation.
2. Precast and Modular Concrete Pavements.
3. Fast-Track Concrete Pavements.
4. Rehabilitation and Construction Evaluation and Implementation.

For nearly 15 years, the concrete pavement industry has confronted both facts and perceptions about concrete pavement construction under high-speed traffic conditions. While the industry's record is generally positive, perceptions still determine concrete use in many situations. The traffic growth data presented in chapter 1 show that, despite the gains made in the past decade, many more miles of pavement will be subject to high-speed rehabilitation and construction conditions.

The next generation of construction and rehabilitation tools combines the software and hardware required to simulate system design and predict problems that might surface during high-speed construction. High-speed computer simulation can troubleshoot a pavement's response to environmental changes as well. Effective construction management, however, remains critical for meeting the goals and objectives of this track.

Future high-speed construction challenges the industry to move away from slipform paving and identify ways to make precast construction a more viable alternative. Precast modular construction might not only replace ultra-high-speed construction but also improve product quality and extend the paving system. Figure 8 illustrates an example of modular construction.

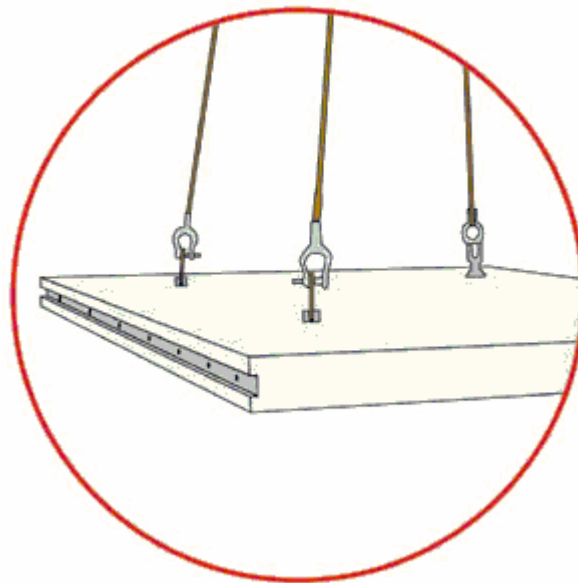

Figure 8. Modular construction: one of many potential high-speed rehabilitation techniques.

Research in this track will include the following areas:

- Planning and simulation for high-speed construction and rehabilitation.
- Precast and modular options for concrete pavements.
- Fast-track concrete pavement construction and rehabilitation.
- Evaluation and technology transfer of high-speed construction and rehabilitation products and processes developed through research.

Some high-speed construction issues are also investigated in other research tracks, and those efforts will be closely coordinated with those in this track. For example, track 1 (Performance-Based Concrete Pavement Mix Design System) and track 3 (High-Speed Nondestructive Testing and Intelligent Construction Systems) contain many elements required in a high-speed option.

#### Track Goal

This track will explore new and existing products and technologies that facilitate high-speed rehabilitation and construction of PCC pavements.

#### Track Action Items

1. Develop planning and simulation tools that allow contractors, designers, and owner agencies to identify potential problems before construction begins and select the most efficient processes.
2. Explore and refine precast and modular pavement technology for new construction, rehabilitation, and maintenance.
3. Refine fast-track construction technologies and techniques and synthesize them into best practice guidelines for contractors, designers, and owner agencies.
4. Provide the means for all contractors, designers, and owner agencies to learn about new high-speed construction and rehabilitation products and technologies.

### ***Track 8. Long Life Concrete Pavements***

#### Subtracks

1. Pavement Strategy for Long Life Concrete Pavements.
2. Construction and Materials for Long Life Concrete Pavements and Overlays.
3. Long Life Concrete Pavement Implementation.

Long life pavements are needed to handle the congestion and traffic loading that the pavements will experience in their lifetime. To meet a 30-year calendar design life, a pavement built in 2005 may need 70 to 100 percent more axle loads per mile than a similar pavement built in 1995. But rather than simply building pavements to handle axle loading, pavement design must address what the public sees—the time between repairs. Figure 9 illustrates this concept.



Figure 9. Pavements that perform well for 60 years or more.

The following research areas needed to design and build long life pavements are developed in this track:

- Definition of long life concrete pavements (including various warrants for longer life, noting that low-volume roadways must be included in this definition and analysis); identification of long life concrete pavement types, design features, foundations, rehabilitation/maintenance strategies, and design requirements.
- A design catalog for long life concrete pavements (thickness should not be a parameter included in this catalog, as thickness requires indepth analyses, but all other details of concrete pavement design that affect long life performance are important).
- Identification of material requirements and tests for long life concrete pavements.
- Strategic application of preservation treatments to preserve long life concrete pavement.
- Quality control/quality assurance (QC/QA) testing standards to ensure long life concrete pavements.
- Evaluation of experimental long life concrete pavements.
- Evaluation of concrete overlays for long life designs.

The research in this track will be coordinated closely with related research integrated across the strategic road map. For example, other research tracks propose the following advancements to achieve long life pavements:

- Performance-related specifications and advanced contracting techniques.
- Understanding and controlling construction variability.
- Advanced quality control tools.
- Advanced life cycle cost analysis (LCCA) procedures.



This track addresses the operational conditions in which pavement performance is defined. For example, a 60-year pavement could be designed in several ways that determine its maintenance schedule:

- No maintenance with total reconstruction at the end of the pavement life.
- Periodic maintenance at 25 years and then at every 5 years thereafter, including surface characteristics maintenance, early foundation repairs, and potential drainage issues.
- Staged construction, in which a 60-year foundation is built and the slab is carpeted with a thin surfacing that can be renewed periodically to maintain surface characteristic performance requirements.
- Staged construction, in which a 60-year foundation is built, but with a wraparound concrete overlay to handle loads on the existing pavement and allow for new pavement for lane increases.

Each of these options can be used in locations that experience light-to-moderate truck traffic today but anticipate long-term growth. However, it is not clear whether the time between fixes for pavements that are already heavily loaded can be extended beyond 25 years.

### Track Goal

The problem statements in this track will identify both conventional and innovative pavement types, design features, foundations, materials, construction QC/QA, and preservation treatments that will reliably provide long service life (e.g., more than 40 years).

### Track Action Items

1. Develop clear and detailed definitions of long life pavements, including information about warrants, required maintenance, a range of low- to high-traffic roadways, and other information.
2. Identify pavement strategies (design, foundation, restoration, and rehabilitation) for long life.
3. Identify design and foundation features that are likely to result in long life concrete pavements.
4. Identify restoration treatments for preserving long life concrete pavements.
5. Identify concrete and other material tests and requirements for long life pavements.
6. Identify QC/QA procedures that will ensure quality long life pavement construction.
7. Construct test highways of the most promising concrete pavement types that include design features, foundations, materials, construction QC/QA, and preservation treatments that will ensure long life concrete pavements.

### ***Track 9. Concrete Pavement Accelerated and Long-Term Data Collection***

#### Subtracks

1. Planning and Design of Accelerated Loading and Long-Term Data Collection.
2. Preparation of Data Collection/Testing Procedures and Construction of Test Road.
3. Accelerated Loading and Long-Term Data Collection Implementation.

Accelerated testing facilities (ATF) provide valuable performance data that allow engineers to improve current procedures and advance the state of the art. Throughout the 1980s and 1990s, many new accelerated testing programs with ATFs were installed. ATFs encourage innovation by eliminating the fear of failure associated with full-scale road testing, since ATFs can test innovations without the possibility of disastrous consequences that might occur on a real highway. ATFs also provide small-scale evaluation of full-scale designs to identify limitations and speed up the implementation of design improvements. At least 24 ATFs currently operate in the United States. Figure 10 conceptually represents such an ATF.

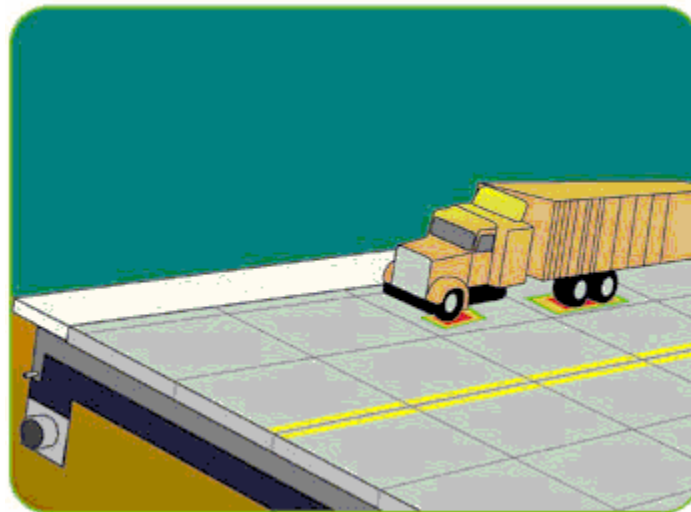

Figure 10. Accelerated loading and data collection to improve models and systems.

Test roads and data collection methods can be developed and expanded further. Additional data are needed for new materials, new test sections, model validation and calibration, innovative joint designs, and surface characteristics advancements. These data can contribute to many of the research tracks in the CP Road Map, which depend on quality data for validation or calibration and require experimental installations or access to long-term data.

This track provides the infrastructure for a future national program that will plan accelerated loading and long-term data needs, construct test sections, and collect and share data. The problem statements in this track will explore areas that will yield useful data and determine the amount of time needed to get it. Additionally, this track will research accelerated durability testing for concrete pavement materials and design.

The problem statements in this track will address:

- Identification of accelerated and long-term data needs.
- Planning and design of accelerated loading and long-term data collection.
- Accelerated and long-term data management and distribution.

- Development of a master plan for conducting accelerated product testing and full-scale road experiments.
- Development of experimental designs and a data collection and performance monitoring plan for accelerated loading and durability testing facilities and full-scale products testing.
- Preparation of data collection and testing procedures.
- Construction of accelerated loading sections and test road sections.

### Track Goal

The research in this track will collect, manage, and analyze concrete pavement performance data that will support the CP Road Map.

### Track Action Items

1. Identify performance data needs for calibrating and validating performance models for jointed plain concrete, continuously reinforced concrete pavements, and other types of concrete pavements.
2. Develop an ATF and full-scale test road program for collecting materials, design, traffic, climate, and performance data from existing and future experimental pavements.
3. Establish reliable experimental testing programs along with testing protocols for ATF and test road programs that include durability testing for materials and design.
4. Collect and analyze relevant test database programs that support the CP Road Map.

## ***Track 10. Concrete Pavement Performance***

### Subtracks

1. Technologies for Determining Concrete Pavement Performance.
2. Guidelines and Protocols for Concrete Pavement Performance.

This track addresses key elements of the pavement management and asset management system. This system determines whether the sum of all the work done meets the required and desired concrete pavement performance characteristics for highway agencies and users.

In the past, concrete pavement performance requirements have focused on serviceability (i.e., ride quality) and friction. However, performance indicators, such as tire-pavement noise, tire spray, hydroplane potential resulting from wheel path wear, light reflection, fuel economy, and the availability of open traffic lanes (i.e., those not closed for construction or maintenance), are now of much greater interest to highway agencies and users. Future concrete pavement designs will be expected to provide for all of these functional performance indicators to produce surfaces and structures that meet the needs of highway agencies and users.

Structural and functional pavement performance is the output from all of the design, materials, and construction processes and can thus be predicted using mathematical and computer models that systematically analyze data to predict pavement performance.

Monitoring concrete pavement performance indicators using pavement management systems will be crucial to highway agencies. Developing a performance feedback loop to provide continuous condition reports will allow prompt improvements to existing pavements that fall short of user needs. Continuously monitoring pavement performance will also help improve concrete pavement design procedures (particularly functional considerations related to surface characteristics), construction standards and specifications, and rehabilitation techniques.

The research in this track will determine and address the functional aspects of concrete pavement performance, particularly factors such as tire-pavement noise, friction, smoothness, and others. Research will also provide rapid concrete pavement performance feedback and consider ways to schedule surface characteristics and conditions improvements. Developing feedback loops in highway agencies' pavement management systems will be crucial to monitor performance effectively and rapidly and suggest improvements that minimize lane closures. Figure 11 illustrates this comprehensive process.

### Track Goal

The research in this track will provide the traveling public with excellent concrete pavement surface characteristics and minimal lane closures for maintenance or rehabilitation over the design life.

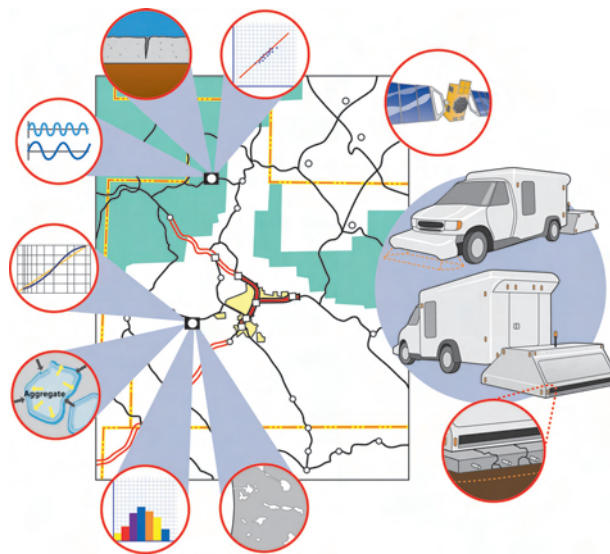

Figure 11. Systemwide data collection and analysis to support long-term performance.

### Track Action Items

1. Develop ways to collect real-time data on concrete pavement conditions, including surface characteristics (friction, noise, distress, smoothness, others), climate parameters (temperature and moisture), traffic loading, moisture sensors beneath the slab, and structural factors using a combination of embedded electronics, high-speed assessment equipment, traffic measurement devices, and performance prediction equations.

2. Determine concrete pavement condition using a new generation of equipment that addresses structural support, smoothness, friction, noise, moisture beneath the slab, drainage, and other factors.
3. Loop concrete pavement performance data back to agency maintenance, planning, traffic, design, materials, and construction units using improved management systems. This feedback will allow the required concrete pavement surface and structural improvements to be scheduled cost effectively and the pavement technology to be improved quickly.
4. Plan and schedule concrete pavement preservation and maintenance activities based on feedback condition and performance data to minimize lane closures and congestion.
5. Optimize the volume, type, and flow characteristics of traffic through long-lasting traffic monitoring sensors embedded in the pavement.

### ***Track 11. Concrete Pavement Business Systems and Economics***

#### Subtracks

1. Concrete Pavement Research and Technology Management and Implementation.
2. Concrete Pavement Economics and Life Cycle Costs.
3. Contracting and Incentives for Concrete Pavement Work.
4. Technology Transfer and Publications for Concrete Pavement Best Practices.
5. Concrete Pavement Decisions with Environmental Impact.

The problem statements in this track address business and economics issues in concrete paving. The research outlined here will quantify the value and benefits of concrete pavements and ensure that an adequate delivery mechanism is in place to supplement the low-bid system. This track, when implemented, will help clarify the relationship between concrete pavements and economic issues, capital availability, risk and risk transfer, and alternative contracting (see figure 12).



Figure 12. Innovative business systems.

The research in this track will develop:

- An administrative support group to provide professional management services for the CP Road Map Research Management Plan.
- An innovative concrete pavement technology procurement program.
- Methods for achieving sustainability with concrete pavements.
- An improved understanding of the economic and systemic impacts of concrete pavement mix-of-fixes strategies for all levels of roadways, from low to very high traffic.
- Advanced methods for concrete pavement LCCA that include user costs.
- Optimized concrete pavement life cycle decisions.
- Innovative contracting methods that consider performance-based maintenance and warranties.
- The next generation of incentive-based concrete pavement construction specifications.
- A concrete pavement best practices manual.
- Accelerated technology transfer and rapid education programs for the future concrete paving workforce.
- An analysis of and recommendations about specific concrete pavement decisions with environmental impacts.

#### Track Goal

The research in this track will clarify the relationship between concrete pavements and economic issues, capital availability, risk and risk transfer, and alternative contracting.

#### Track Action Items

1. Understand more clearly the economics of concrete pavements, fix alternatives, and the cost implications of engineering improvements as they relate to pavement performance.
2. Determine the best combination of concrete pavement solutions (mix-of-fixes) that balances funds, traffic impact, and network efficiency.
3. Develop an array of alternate contracting techniques that enhance the procurement of concrete pavements with a clear determination of risk between the owner and the contractor.
4. Develop optimum technology transfer, training, and outreach for the entire concrete paving workforce that the new generation of efficient, targeted, high-quality, cross-disciplined, and available-on-demand pavements will require.

#### ***Track 12. Advanced Concrete Pavement Materials***

##### Subtracks

1. Performance-Enhancing Concrete Pavement Materials.
2. Construction-Enhancing Concrete Pavement Materials.
3. Environment-Enhancing Concrete Pavement Materials.

If the concrete pavement industry continues to use the same types of materials, the same problems and limitations will persist in concrete pavement applications. Fortunately, innovative

concrete paving materials are being developed continually to enhance performance, improve construction, and reduce waste (see figure 13). The problem statements in this track will develop new materials and refine or introduce existing advanced materials. Many existing materials that the problem statements study have been used thus far only on a small scale, such as in laboratory tests. Most existing materials have not been used in the United States, but have been used successfully in other countries. This track will bring new concrete paving materials into common practice by experimenting with them on a larger scale and developing standards and recommendations for their use. Moreover, this research will foster the development of new and innovative concrete pavement materials.



Figure 13. Innovative concrete materials.

The problem statements in this track are grouped into three subtracks: performance-enhancing, construction-enhancing, and environment-enhancing concrete pavement materials. Performance-enhancing materials will improve pavement durability and long-term performance, perhaps extending pavement life further than conventional materials. Construction-enhancing materials will improve the construction process by reducing material requirements, labor requirements, or construction time. Finally, environment-enhancing materials show promise not only by reducing waste through pavement reclamation, but also for reducing raw consumer and industrial waste. Clearly, many of these materials fit in more than one category. A material that improves the construction process, for example, may also improve pavement durability and performance. Likewise, a material that uses consumer waste may also improve pavement performance.

The emphasis on environment-enhancing materials is significant. Not only are contractors and agencies paying heavily to dispose of reclaimed asphalt and concrete pavement, but other industries are looking for environmentally responsible ways to dispose of industrial and consumer waste to reduce the burden on landfills. Environmental concerns are expected to become more important in the next few decades as landfills fill quickly.

### Track Goal

New materials will be evaluated and existing materials will be refined to improve concrete pavement performance, enhance construction, and lessen environmental impact.

### Track Action Items

1. Improve pavement durability and long-term performance to extend pavement life further than conventional materials.
2. Improve the construction process by reducing material requirements, labor requirements, or construction time.
3. Reduce waste through pavement reclamation.



## **CHAPTER 4. DESIGN CONSIDERATIONS**

### **PERFORMANCE-BASED PAVEMENT SYSTEMS**

Performance-based concrete pavement systems use sophisticated and objective QC/QA systems at every step of a pavement project to ensure the desired performance. Designing for performance is the first critical step. In subsequent phases of paving projects, performance is predicted during mix design to ensure, for example, materials compatibility, then measured regularly during and after mixing and construction to determine to what extent optimums were missed and adjustments are needed.

Such systems require reliable, accurate performance-based prediction and measurement tools. They require tools for responding quickly to needed adjustments. They should be based on more and better history data. They should eliminate, to a significant degree, variabilities and inaccuracies due to human factors.

Chapters 4 through 7 discuss the performance-related considerations related to design, mixture materials and design, construction, and pavement management and business systems that are addressed in the various tracks of the CP Road Map.

Design is the plan and basis for pavement dimensions, joint and reinforcement details, materials selection, mix design, construction, maintenance, preservation, and rehabilitation.

### **WHY IS THIS TOPIC IMPORTANT?**

If pavement design is deficient, the pavement owner will incur extra costs and motorists will experience more lane closures over many years to come, no matter how good the subsequent maintenance and upkeep activities are.

Designers, owner agencies, and roadway users need better tools and innovative ideas for developing improved designs that are more reliable (have a better chance of serving their design lives without premature distress) and economical (provide good benefit-cost ratios for initial construction, preservation, and rehabilitation), as well as functional, constructible, and maintainable. That is, designs should be based on performance.

The CP Road Map will provide tools for performance-based design.

### **OVERALL DESIGN GOAL**

Concrete pavement designs will be performance-based; that is, reliable, economical, constructible, and maintainable throughout their design life while meeting or exceeding the multiple needs of the traveling public, taxpayers, and owning highway agencies.

### **SPECIFIC DESIGN OBJECTIVES**

The overall design goal will be met through several specific objectives:

- Develop viable concrete pavement options for all classes of streets, low-volume roads, highways, and special applications.
- Maximize the use of fundamental engineering principles through mechanistic relationships.
- Integrate traditional structural pavement design with materials, construction, traffic loading, climate, geometrics, preservation treatments, rehabilitation, and performance inputs.
- Design preservation and rehabilitation treatments and strategies using mechanistically based procedures that use in-place materials from the pavement structure.
- Develop and evaluate new and innovative concrete pavement designs for specific needs (e.g., very high traffic, residential traffic, parkways, tunnels).

## **RELATING DESIGN OBJECTIVES TO THE HIGHWAY USER**

These design objectives can be accomplished only if adequate mathematical and computer models exist to make it possible to relate all aspects of design—such as site conditions, design features, and economic analyses—to the functional needs of highway users to successfully develop performance-based, predictive designs. The CP Road Map provides resources to develop these prediction models.

## **CRITICAL DESIGN ISSUES**

The following paragraphs discuss several design issues addressed throughout the research tracks.

### **Models**

These design objectives can be accomplished only by creating adequate models that relate all aspects of design to the needs of highway users. For example, mathematical models already exist that relate site conditions (e.g., natural subgrade, traffic, climate, and existing pavement) to functional requirements (e.g., ride, friction, noise, and fatigue cracking). Of course, other factors like foundation (e.g., base, subbase, and subdrainage) and design features (e.g., shoulders, slab dimensions, and coefficient of expansion of concrete) also affect functional requirements. Mathematical models, therefore, should be available for those relationships.

### **Understanding the Fundamentals of Concrete Pavement Response**

Ever since the first structural response equations were published in 1926 by H.M. Westergaard, interest in engineering-based design of concrete pavements has been intense, demonstrated most recently in the *Mechanistic-Empirical Pavement Design Guide*.<sup>(13)</sup> Although significant progress has been made over the past 75 years in improving mechanistic modeling of pavement structural behavior and deterioration, many fundamental problems still need to be resolved. These problems include, but are not limited to:

- Accurate prediction of structural responses (deflections and stresses) of PCC pavements and overlays under repeated dynamic loading.
- The effect of bonding/slippage between the slab and base layers on structural responses (field measurements required) and how this develops over time.
- Formation, behavior, and deterioration of PCC joints and cracks (including reinforced cracks).

- Prediction of base/subgrade erosion and pumping using tests and models.
- Propagation and deterioration of reflection cracks in PCC pavements.
- Interaction between structural distresses (cracking, pumping, and faulting) and material-related distresses (spalling, D-cracking, alkali-silica reaction).
- True effect of temperature gradients, moisture gradients, and creep on slab structural responses.
- Structural fatigue damage and cracking (of all types) of slabs subject to repeated heavy loadings.

Better understanding of concrete pavement structural responses under a wide range of common structural and climatic conditions will lead to improved designs that will provide more reliable and economical solutions with lower risks of premature failure.

### **Design Reliability**

Of the many variables to be considered when designing pavements to provide a particular level of service, design life is pivotal. Most concrete pavements constructed in the past half century have significantly outlived their intended (designed) years of service and traffic loadings. Rarely does a concrete pavement fail prematurely when both design age and design traffic are considered. This indicates that concrete pavements have been designed to a very high level of reliability. Therefore, estimated first costs and future preservation and rehabilitation costs used in LCCAs likely have been higher than necessary because pavements are lasting longer.

Clearly, in today's pavement type selection environment, it is not desirable to design concrete pavements to a higher-than-needed level of reliability. Rather, design reliability methods should be improved to be more accurate than the current approach, which uses a multiplier on equivalent single-axle loads (ESAL). This is a very great challenge, because so many design, construction, material, traffic loading, and climatic factors affect reliability.

### **Feasible Designs for All Occasions**

Existing procedures (e.g., AASHTO, PCA) have many limitations and deficiencies for designing concrete pavements economically at a desired level of design reliability. While this is true for nearly all situations, it is particularly true for the following conditions:

- Concrete overlays for low truck volume roads and collectors.
- Concrete overlays and pavements subjected to very heavy traffic in various geometric situations with multiple lanes.
- Concrete pavements and overlays for relatively short design lives.
- Concrete reconstruction of existing asphalt and concrete pavements without raising the pavement grade, using existing materials as much as possible for rapid construction.
- Unique widening structural solutions (both overlays and lane additions).
- Concrete pavements and overlays designed to minimize first costs while providing acceptable future performance, reliability, and costs.

## **Efficient Pavement Designs for Low-Volume Local Roads**

Many concrete pavements have been designed on both rural and urban low-volume roadways. Often, these are placed directly on the natural subgrade after some type of preparation. Designing a concrete pavement for low-volume roads is in many ways more challenging than designing high-volume pavements because of the often greater desire for long-lasting pavements (e.g., pavements for an upscale residential area should last a long time). Currently, no performance data exist for these pavements to help verify or improve design. Such data are greatly needed in all major climatic areas because climate has an even greater effect on performance with the slab resting on the subgrade or on a thin granular or treated soil layer.

## **Lack of Integration of Design with Materials, Construction, and Rehabilitation**

One of the major limitations of concrete pavement design is the ability to consider materials, construction, traffic loading, climate, preservation treatments, rehabilitation, and performance requirements simultaneously to produce reliable and economical designs and strategies. This limitation has led to many problems in concrete pavement performance. A design is judged successful only if it performs well after many years of traffic loadings. Increased design capabilities are linked to understanding and knowledge of the construction process as well as material properties. For example, greater joint spacing (e.g., more than 6.1 meters (20 feet)) may work well if construction processes and material selections are compatible with the design. It also may result in excessive slab cracking if large temperature gradients are built in during construction and/or aggregates with a high coefficient of thermal expansion are used in the mix. Only through a major research effort can such an integrated and systematic approach to design be achieved.

## **Design Procedures Deficiency**

Current design procedures, including the widely used AASHTO procedure, are almost completely empirical, so they carry many deficiencies and limitations. The major national effort to develop an M-E-based design procedure under NCHRP 1-37A has been completed and is under consideration and implementation by sponsoring agencies. This design methodology represents a paradigm shift forward in concrete pavement design. It is expected to significantly improve concrete pavement design because it is based on fundamental engineering principles, uses a finite-element model for structural responses, predicts key distress with mechanistic-based models and an incremental damage computation approach, and is calibrated using national performance data.

Nonetheless, successful implementation in many highway agencies will require significant effort and continual improvement or upgrading over the years. One key item might be called a high-speed computer analysis opportunity. This incremental damage approach (in which the increments are brought down to hourly analyses of damage) could address even more aspects of pavement design, such as early opening. These improvements will be identified as time goes on and agencies use the procedure and sponsor research to fund the improvements. Many improvements will be needed in the next 5 to 10 years to provide for and meet all of the design visions in this long-range research plan.

## **Preservation and Rehabilitation Design**

Designing preservation and rehabilitation treatments has always been very difficult, as the design procedures are almost completely empirical. The *Mechanistic-Empirical Pavement Design Guide* will provide mechanistically based procedures to more fully consider the existing pavement and subgrade structure, making it possible to use in-place materials from the pavement structure to minimize life cycle costs and lane closures.<sup>(13)</sup> Implementing this procedure will require a major effort, and many improvements will be needed to introduce it into highway agencies' daily use. In addition, many expansions will be needed to achieve this vision completely.

## **Base and Subbase Foundations and Subdrainage**

There is a significant lack of technical knowledge and ability to design base and subbase courses that provide key benefits for a concrete pavement. These benefits include permanent uniform support, bonding or lack of bonding ability, no erosion over time, economical construction platform for the slab, and subdrainage. Additional material tests are needed for erosion and bonding characteristics. Criteria and tests are needed to determine the adequacy of layers in an existing pavement structure to be used as the base or subbase for a reconstructed concrete pavement. Determinations of required base and subbase layer thicknesses also are needed.

A method is needed to directly, reliably, and economically consider subdrainage of the pavement structure. Do we need costly permeable bases and edge drains? Can they be maintained for many years? Can we design more reliably and more economically without this level of positive subdrainage? How? What type of recycled materials can be used as bases, subbases, and other sublayers in concrete pavement?

## **New and Innovative Concrete Pavement Design**

Ample opportunity exists to develop new and innovative design concepts for concrete pavements. For example, alternative types of pavements such as jointed ultrathin concrete overlays, thin jointed structurally reinforced concrete pavements, thin prestressed concrete pavements, and thin precast concrete pavements have all been constructed and have demonstrated some advantages. Innovations with the greatest potential should be identified and tested so that their benefits and costs are known to determine their viability for certain design situations (e.g., very heavy traffic, special design needs to determine maximum thickness in reconstruction).

## **Designs for All Types of Underlying Strata**

When unusual underlying strata exist that may shrink or expand, concrete pavements often are not used because of the fear of slab cracking. New and innovative ways are needed to design concrete pavements to handle these difficult underlying strata conditions economically and reliably. This also would include construction on bedrock, which often occurs in tunnels and major cuts. Such a stiff foundation may require special joint spacing or other design changes.



## **CHAPTER 5. MATERIALS AND MIXTURES CONSIDERATIONS**

Materials and mixtures considerations include issues related to mix design parameters, materials specifications and selection, mixture proportioning, type and number of admixtures, and more.

### **WHY IS THIS TOPIC IMPORTANT?**

As described in chapter 1, the challenges resulting from today's increasingly complex concrete mixtures are a major reason for developing the CP Road Map. The public demands fast construction and long-lasting pavements, which require specific mix additives and more durable materials. In addition, environmental, social, and economic pressures on the industry have introduced a host of new, sometimes marginal aggregates, cements, and mineral and chemical admixtures. Singly or in combination, these materials can improve pavement performance in specific situations. They also can introduce new, unforeseen problems.

It is expected that in the next decade even more materials options will be available. The industry needs integrated solutions for optimizing complex concrete mixtures to ensure just the right mix for each specific job.

If developed within the right framework, integrated mix optimization solutions will benefit not only materials engineers and suppliers, who face day-to-day materials selection and mix proportioning decisions; they also will benefit everyone involved in the complex sequence of events in a pavement project, from design to construction to inservice maintenance and performance management. Integrating materials and mix proportioning with development of design specifications, for example, might provide a rational basis for a more objective specification, including items such as minimum cement content and pozzolanic replacement. And a better understanding of the interaction among specific mixtures and construction practices and the environment should result in improved quality control during construction. Inservice pavement forensics and pavement inventories can be integrated in this overall process, providing valuable feedback to improve future materials selection and mix proportioning decisions.

The need for new, integrated materials solutions is intensified by changing roles and responsibilities in the highway community. Traditionally, many State DOTs have relied on skilled, experienced staff not only to identify mix design parameters, but also to control mix proportions, type and number of admixtures, and much of the operations based on detailed specifications. The trend is to move these responsibilities to the contractor and specify only performance requirements. State agencies and contractors alike need well-developed national mix proportioning and materials selection guidelines to ensure successful implementation of performance-based specifications.

The CP Road Map clearly identifies the research and implementation steps needed to ensure that the proposed mix design system is technically sound, fully evaluated, and clearly understood by public and private sector engineers, technicians, and contractors through initial and continuing training and outreach programs. An important capability of the mix design system will be its ability to interact fully and provide key inputs to the structural design procedure.

## **OVERALL MATERIALS AND MIXTURES GOAL**

The overall mix and materials goal of the CP Road Map is that innovative concrete mix material selection and mix design procedures will result in economical, compatible, and optimized concrete mixes integrated with both structural design and construction control.

## **SPECIFIC MATERIALS AND MIXTURES OBJECTIVES**

This goal can be reached by achieving the following specific objectives, which are addressed in various tracks of the CP Road Map:

- Develop a sequence of mix design tests and procedures—integrating structural design and quality control with selection and proportioning of materials—that will be the cornerstone of concrete labs of the future.
- Develop the necessary tools to predict the compatibility and effectiveness of concrete mixes under specific field conditions before paving starts.
- Detect potential construction problems early and correct them immediately with innovative quality control tools.
- Detect potential long-term durability problems more effectively during both the mix design process and construction quality control.
- Improve the ability to predict concrete mix properties and how they relate to slab behavior and performance (e.g., shrinkage, joint opening, and curing) using the next generation of advanced modeling techniques.
- Identify and use innovative, nontraditional materials that could accelerate construction, maintenance, and rehabilitation and/or extend product life at a fair cost.

## **TOOLS FOR SUCCESS**

End users' needs are ultimately the driving force for mix design and materials selection and proportioning, because users dictate the functional requirements, or specifications, of the finished pavement. All projects, however, begin with the individual material components of the concrete mix. The proportions and interaction of the materials will influence mix properties like strength and workability. Mix properties dictate production requirements, while production itself affects the as-produced pavement.

Numerous efforts have been made to address individual components of materials selection and proportioning. The CP Road Map is unique in that it includes tasks that link, or integrate, all of the elements of a paving project in a logical fashion. The next generation of materials selection and mix proportioning tools and procedures will therefore integrate a series of laboratory tests, analytical tools, and mechanistic models that will:

- Recommend cement, aggregate, and admixture proportions based on anticipated environmental and loading conditions.
- Predict any potential chemical compatibility, rheology, and handling issues that may affect the mix during construction.
- Predict the ability of the mix to shrink excessively because of normal variations in materials and climate during construction.



- Predict the ability of the mix to withstand the freeze-thaw cycle, alkali-silica reactivity, delayed ettringite formation, d-cracking, and other durability issues.
- Predict the ability of the mix (as a component of the pavement) to withstand spalling, cracking, fatigue, and other service-related problems.
- Predict the ability of the mix to provide functional service: ride, skid, surface drainage, noise, and aesthetics.

## **CRITICAL MATERIALS AND CONCRETE MIXTURES ISSUES**

Following are brief discussions of some critical issues related to materials and mixtures for concrete pavement included in the CP Road Map.

### **Specifications**

Standards drive how concrete pavements are built, including the selection of materials. Material specifications have evolved over time, and typically have become more restrictive. As problems have appeared on various jobs, new specifications commonly were established to attempt to eliminate their recurrence. Unfortunately, the effect of the new specifications on other properties was not considered. This has led specifiers to intentionally seek out materials that meet one condition without knowing if the materials can meet additional conditions. For example, a finely ground cement may meet early-age strength requirements, but lack the required long-term strength gain requirement.

Fortunately, as a result of these issues, this trend has been reversed somewhat. By recognizing that specifiers should focus on the end result rather than on process details, researchers have an opportunity to explore and develop a more performance-based approach to materials selection and concrete mixture proportioning.

Optimizing a mixture in terms of cost, performance, and durability requires mathematical and computer models to relate all variables to each other. For example, the material components and relationships should relate to mix properties so that a mixture with certain properties can be developed by computer before testing for verification in the laboratory. These variables should ultimately be related through models to the functional performance for the highway user. For example, the types of aggregates used in the mixture will in turn affect the friction, noise, and smoothness characteristics of the concrete pavement over the design period.

### **Mix Designs**

For decades, it has been recognized that concrete mix design is really a misnomer. Current methods base proportioning only on highly empirical relationships of mix properties, which are not directly tied to performance or function. The industry needs to explore the selection and proportioning of mixes that ultimately are tied to user demands. Achieving this goal, however, requires a fuller understanding of the connectivity of the following issues:

- **Roles and responsibilities.** Who will execute the mix design? Who will be liable if problems are encountered?

- **Performance prediction.** Can the knowledge base link materials to indicators of pavement performance?
- **Increased demand for durability knowledge at the mix design stage.** Is there enough knowledge to link concrete mix design details to deteriorated concrete? Is it possible to identify which materials or combinations of materials cause this deterioration and separate them from operational issues for given climates?
- **New product evaluations.** Is there a way to assess the durability and performance aspects of new materials? If innovative materials are to be used more commonly, this evaluation will need to be expedited.
- **New test procedures.** Is equipment available to measure the properties identified as most relevant?
- **Economics.** Is it possible to develop a mix design procedure and sequence of tests that are time and cost effective? Is it possible to provide the proper training?
- **Marginal materials.** Is there a place for all grades of materials? Can what normally are considered marginal materials be used in noncritical mix designs and certain paving applications? With many countries moving toward a 100 percent reuse policy, is it possible to have such a policy in concrete paving?
- **Functional demands in the next generation of surface characteristics.** How will mix design procedures address the mix-related aspects of new demands for smoothness, noise, friction, illumination, rolling resistance, surface drainage, and aesthetics?
- **Constructability demands.** Can the materials selected and the ease of constructing be correlated with differing environmental and operational constraints?

## Modeling

The complexity of PCC mixes makes the trial-and-error process of mix design in the laboratory even more time consuming and labor intensive than it already is. Means are needed to model the behaviors of concrete mixes without actually having to mix all of the possible combinations and cast specimens in the laboratory. Work has begun on developing computer simulations of concrete to optimize proportions and properties. This work needs to be continued so that most mix design details can be worked out through such simulations, with only small-scale laboratory followup testing needed to verify predictions. These models should be capable of designing concrete mixes incorporating recycled materials, as well as special mixes for maintenance or rehabilitation activities.

## Materials Compatibility

The ever-increasing complexity of concrete mixtures has made recipe specifications and empirical mix design rules less reliable for obtaining appropriate concretes for high-performance concrete pavements. The range of chemical and mineral admixtures used and the potential for compatibility problems have added to this complexity. Improved tests are needed that better characterize the materials involved in terms of their effect on the performance of the concrete produced. This is particularly true in the case of aggregates, whose potential influence on concrete performance has not been investigated or categorized sufficiently. A suite of tests should be developed to evaluate any waste, byproduct, or recycled material with the potential for use in paving concrete.

## **Material Changes During Construction**

Material components of concrete pavement are tested and approved before pavement construction begins. Often, however, the materials used will change during the course of the project. Substituting materials changes the concrete mix characteristics and can affect its durability. An important future consideration is developing accelerated methods for testing long-term concrete durability. Correlation should be made to current durability tests, as well as to concrete pavement field performance. These tests should be simple enough to use in the field, preferably on a construction site, and produce results in a matter of hours to help workers evaluate the effects of proposed materials changes. Current test methods, such as American Society for Testing and Materials (ASTM) C666, measure freeze-thaw resistance of a concrete sample, but are time consuming and should be performed in a laboratory.

## **Durability Design Model**

The ability to predict the performance of concrete pavements is critical to meeting service life requirements. A comprehensive durability (service life) design model for concrete pavements that fully addresses multiple chemical and physical environments could result in extended structural life, lower life cycle cost, and increased energy efficiency. New families of embedded sensors and monitoring devices should be developed to provide the base data necessary to build and validate these predictive design models.

Future research should develop an integrated system that not only specifies a mix based on empirical relationships, but also takes into consideration all available materials, construction requirements for specific projects, and performance requirements for the finished product. Using a knowledge base, computerized guidelines, and innovative laboratory tests, designers will be able to determine the optimum mix design for each specific project quickly and efficiently.



## **CHAPTER 6. CONSTRUCTION CONSIDERATIONS**

Construction considerations include issues related to equipment, construction operations, and quality control.

### **WHY IS THIS TOPIC IMPORTANT?**

Many key elements that can make or break a concrete paving project are related to construction operations. Although significant emphasis is placed on planning, design, and materials selection for a concrete pavement, several elements of construction operations can also impact the overall quality of the pavement.

### **OVERALL CONSTRUCTION GOAL**

Concrete pavements will be built, rehabilitated, and maintained in way that minimizes negative impacts on the public, meets expected design requirements reliably, and provides immediate quality feedback during operations.

### **SPECIFIC CONSTRUCTION OBJECTIVES**

This goal can be reached by accomplishing the following research objectives:

- Economically build and maintain concrete pavements within any traffic-closing window, including high-speed modular construction for closures of 6 hours or less.
- Develop a rehabilitation strategy that crushes and reprocesses existing pavement materials and uses them in new pavement, minimizing hauling requirements and environmental impacts.
- Develop context-sensitive concrete pavement construction operations that address materials flow (haul), lighting, noise, air, water, and other ecological issues, minimizing the impact on the public.
- Develop rapid (or instantaneous) and continuous feedback on paving variables, including materials and weather, that allow for immediate adjustments to paving operations.
- Develop performance specifications that allow contractors to exercise more innovation in construction material selection, processing, and construction operations, focusing on quality aspects that truly relate to performance.
- Develop graphic aids that allow designers and contractors to use three- and four-dimensional computer technologies (the fourth dimension being time) to “build” concrete paving projects and learn from them before initiating operations.

### **CRITICAL CONSTRUCTION ISSUES**

As with pavement design and materials/mixes, the relationships among various elements and variables of pavement construction should be understood and demonstrated mathematically to optimize pavement performance. Ultimately, users drive construction requirements because they dictate the functional demands and essentially own the facility. Each project starts with basic

variables—such as location, which dictates material availability, weather conditions, and construction windows, among other things. When combined, these basic variables dictate construction schedules and available mix alternatives, which, in turn, dictate the required construction techniques. Construction techniques influence the construction process and ultimately the as-constructed pavement. The as-constructed pavement has certain functional characteristics, which ultimately are accepted or rejected by users. While users do not actually make the decision to accept a finished product, they can apply the political pressure that will ensure their demands are met.

The following pavement construction issues are addressed in various tracks of the CP Road Map.

### **Accelerating Construction/Improving Workplace Safety**

The pressure to “get in, get out, stay out” places a special emphasis on innovative techniques to accelerate highway construction. Concrete paving operations are no exception. If concrete pavements are to remain a competitive and viable alternative in future highway construction, new methods for high-speed construction should be identified, developed, and integrated into the state of the practice.

For example, fast-track paving is not new to the industry, but several methods are being used, most of which have inherent limitations. Nighttime construction is becoming more prevalent to minimize user delays, but adverse psychological impacts on workers and other safety issues related to nighttime construction have been identified. The mantra should be, “get in, *stay safe*, get out, stay out.”

### **Lane Closure and Traffic Management Issues**

Highway users are less tolerant than ever of the temporary inconvenience that highway construction often brings. Innovative techniques are needed for both assessing the impact on the public and optimizing traffic mitigation during construction operations. Computerization is expected to assist in this goal, but additional work needs to be done before reliable optimization methods are adopted.

For contractors, the sequencing and timing of operations also need to be optimized. Contractors commonly face limited resources, including equipment and labor. Techniques should optimize the use of these resources to expedite construction operations at minimal cost. Closely related to this is the demand for more rapid concrete mixing and placement techniques. It has been demonstrated that even modest improvements in concrete placement production rates can significantly accelerate the construction process.

Finally, future research should include cutting-edge technologies, such as precast and prefabricated construction. These technologies have begun to show promise as a means to accelerate construction under certain circumstances.

## **Intelligent Construction Systems and Quality Control/Acceptance**

Public agencies are becoming more sensitive to the quality of concrete pavements immediately and soon after construction. Several technical challenges, however, limit understanding and control of the numerous elements affecting initial quality. Existing products such as FHWA's HIPERPAV™ program show promise as tools to accomplish this goal, but additional work is needed. Future research should address a number of these challenges, using a systems approach to recognize their connection with other elements.

### **Interaction of Variables**

The factors that impact initial quality the most are related to temperature and moisture management. Concrete is a dynamic material, with several complex processes occurring simultaneously in a dynamic environment. The interaction of these variables often can lead to unexpected temperature and moisture conditions in the new concrete slab. These conditions, if severe enough, can compromise the initial quality of the pavement, which can ultimately impact long-term performance. A number of construction operations elements also can affect the temperature and moisture of the concrete, and additional work is needed to understand this complex process.

Other construction variables also have been identified as having an impact on initial pavement quality. For example, the consolidation of concrete as a function of vibration methods can affect dowel-concrete interaction, air void structure, and other factors. Saw cutting is also important. Selecting optimum depth and timing of saw cutting operations for a particular project are still insufficiently understood.

### **Variability**

Variability is arguably the most important element that can impact overall initial pavement quality. Variability is inherent in every aspect of a pavement, including design, materials, environment, and construction. The impacts of construction variability especially need to be better understood. If too much emphasis is placed on controlling the variability of a particular construction aspect, additional cost is introduced into the system. If not enough emphasis is placed on controlling variability, however, the quality of the product can suffer.

Most experts agree that concrete pavement quality is impacted significantly by the quality of construction operations. With pressure to shorten the paving operation window and use less-than-desired materials, the room for error expands. One of the most critical aspects of concrete paving in the future will be rapid and continuous feedback on the numerous variables that drive quality. Variability in weather, support conditions, and concrete material quality ultimately will lead to variability in the end product.

A new concept, ICS, could be the solution. First publicized in preparing the Future Strategic Highway Research Program (F-SHRP) Rapid Renewal Proposed Scope of Work, ICS is closely related to the way intelligent transportation systems help traffic engineers better manage traffic. ICS similarly will allow contractors to better control paving operations. ICS includes the rapid and continuous feedback of measurement data related to pavement quality, and provides tools to

make necessary corrections with predictable results. Before ICS can be fully advanced, however, a host of more fundamental research should be accomplished. ICS can improve contractor process control, improve and permanently record quality control data, and integrate with asset management/pavement management systems.

### **Nondestructive Testing**

NDT of concrete pavements is fundamental to the ultimate success of ICS and warrants extensive study and application. NDT has been used successfully, although not widely, to understand the in situ strength and durability of concrete pavements. A number of techniques are available to predict the properties of early-age concrete shortly after construction, but each technique has inherent benefits and limitations. Future research should further evaluate the use of NDT as a means to assess concrete quality rapidly and accurately.

### **Performance Specifications**

Closely related to the initial quality of concrete pavement after construction is the means by which quality is controlled and ensured. In recent years, FHWA has emphasized developing performance specifications for concrete pavements. Performance specifications recognize the relationship between construction quality and long-term performance. By rationally controlling variables that impact long-term performance, the quality of the final product can be improved. Future research should identify the means of quality control that require further study. In addition, the research should evaluate performance specifications, including warranties, for their benefits and limitations in the concrete pavement industry. Slow to gain acceptance, these alternative means for quality control may prove beneficial to the industry in the long term.

### **Construction Operations and Equipment**

The basic concrete pavement construction operations of today are not significantly different from those of 30 years ago. Concrete batching, transporting, placing, and curing are common elements of the construction process. Depending on the specifics of the project, other elements might include texturing and jointing. While the basic process has not changed, modest advancements have been made, including the use of technology to improve both efficiency and quality.

Future concrete pavement construction, however, should meet a growing set of user-driven demands. For construction, the most pertinent are the demands for quality and minimal delay. Sustainability is becoming a prevalent issue as well, leading to a need for its own unique set of solutions.

New equipment to permit operations such as one-pass paving will help meet these demands. One-pass paving is efficient while minimizing environmental impacts by incorporating 100 percent recycled materials into the process. Efficient NDT techniques also could be incorporated into one-pass paving operations to increase efficiency and ensure a high-quality product by automatically making necessary adjustments.



## **High-Speed/Low-Clearance Construction**

Because of increasing pressures for temporal and spatial limitations on construction, the concrete pavement construction community will require new construction techniques. Precast modular construction, for example, can be used to place a high-quality surface rapidly. While cost certainly will be a consideration, the mounting costs of traffic delays soon will justify the higher placement cost. Rapid-set, high-durability patching also will be required, including placement techniques that reduce the overall time for construction. Construction projects that generate no waste can be achieved only if researchers find ways to use in situ materials without jeopardizing long-term durability and performance. In short, the idea of night paving and daytime trafficking should be considered.

## **Ensuring Long-Term Performance**

Although long-term concrete pavement performance issues are considered in detail in the next section, some construction-related issues are closely related to performance. For example, there is a demand for a better understanding of the required surface preparation for bonded, unbonded, and whitetopping concrete overlays. It has been demonstrated that the methods and quality of preparation of the existing pavement can significantly affect long-term performance, but guidance is needed in selecting optimum techniques. Attention should be given to the impact of surface preparation as it relates to other factors affecting long-term performance.

## **Constructing and Controlling Surface Characteristics**

Concrete pavement texturing is another issue that warrants attention. Many techniques for concrete pavement surface texturing are in use today. Their pros and cons are still being determined, with debate among and within agencies about the performance of various techniques.

## **Joint Sealing**

Another construction issue closely related to long-term concrete pavement performance is joint sealing techniques. For a given method, a number of construction techniques can be used. The impact of joint sealing on long-term pavement performance is an area that needs future research.

## **Improving Competition**

Research on improving the competitive nature of concrete paving in the highway industry is a construction-related issue that is sometimes overlooked. Two topics in particular are contractor training and alternative bidding procedures.

First, it has become increasingly difficult in recent years for contractors to hire and retain qualified labor. This applies to all levels of workers, from engineers to laborers. Additional research should be conducted to identify ways to rapidly and effectively train the concrete paving workforce. This training element is as important as any research and should be considered fundamental to research planning. The industry should remain competitive and viable.

A second topic worth considering is an investigation of alternative bidding procedures. Including elements other than cost into pavement bids could allow for contractor innovation. The resulting innovation could both improve the quality and lower the cost of the final product. As a result, concrete pavements would become more competitive in the highway industry.

## **CHAPTER 7. PAVEMENT MANAGEMENT AND BUSINESS SYSTEMS CONSIDERATIONS**

This chapter considers research-related needs related to monitoring and improving long-term concrete pavement performance and maximizing economic value throughout the pavement's life cycle.

### **WHY IS THIS TOPIC IMPORTANT?**

In the past, pavement performance requirements have focused on serviceability (essentially, ride quality) and friction. Now, performance indicators such as tire/pavement noise, tire spray, potential for hydroplaning resulting from wheel path wear, light reflection, fuel economy, and the availability of open traffic lanes (e.g., not closed for construction or maintenance) are of much greater interest to highway agencies and users. Future concrete pavement designs will be expected to provide all of these functional performance indicators to produce surfaces and structures that meet the needs and desires of highway agencies and users.

Monitoring concrete pavement performance indicators through pavement management systems is expected to be more and more important to highway agencies in the future. It may become necessary to setup a performance feedback loop to provide continuous condition reports, making it possible to effect expeditious improvements to existing pavements not meeting users' needs, as well as to improve the concrete pavement design procedures (particularly functional considerations related to surface characteristics), construction standards and specifications, and rehabilitation techniques.

Research is required immediately on the functional aspects of concrete highway performance, particularly to address a combination of tire-pavement noise, friction, smoothness, and other related factors. Note that an entire research track is devoted to this extremely important topic. Research also is needed for providing more rapid feedback and ways to schedule improvements related to surface characteristics and conditions. A critical need also exists for setting up feedback loops in highway agencies' pavement management systems to monitor performance more effectively and rapidly and suggest improvements that minimize lane closures.

### **OVERALL PAVEMENT MANAGEMENT AND BUSINESS SYSTEMS GOAL**

The traveling public will be provided with excellent pavement surface characteristics and a very high level of lane availability over the design life (i.e., minimal lane closures for maintenance or rehabilitation).

### **PAVEMENT MANAGEMENT AND BUSINESS SYSTEMS OBJECTIVES**

- Develop ways to collect real-time data on pavement condition, including surface characteristics (friction, noise, distress, smoothness, and others), climate parameters (temperature and moisture), traffic loading, and moisture sensors.

- Determine the condition of concrete pavements with a new generation of equipment and sensors that address structural support, smoothness, friction, noise, moisture beneath the slab, drainage, traffic, and other factors.
- Loop performance back to agency units—such as maintenance, planning, traffic, design, materials, and construction—through improved management systems so that required improvements to the concrete pavement surface and structure can be scheduled cost effectively and improvements to pavement technology can be carried out expeditiously over time.
- Use feedback condition and performance data to better plan and schedule preservation and maintenance activities for concrete pavements to minimize lane closures and congestion.
- Facilitate the number, type, and flow characteristics of traffic through long-lasting traffic monitoring sensors embedded in the pavement.
- Better understand the economics of concrete pavements and fix alternatives (for many reasons including innovative contracting needs), as well as the cost implications of engineering improvements as they relate to performance.

## **PAVEMENT MANAGEMENT AND BUSINESS SYSTEMS CONSIDERATIONS**

### **Real-Time Data from Concrete Pavements**

Real-time pavement condition data that can be collected from concrete pavements include surface characteristics (friction, noise, distress, smoothness, and others) and climate, traffic, and structural factors. Data collection methods could include a combination of embedded electronics, high-speed assessment equipment, traffic measurement devices, and performance prediction equations. This program will require a new generation of equipment and standard test methods that address structural support, smoothness, friction, noise, moisture, drainage, and other factors.

Consistently achieving successful pavement performance requires a systematic and integrated approach that considers all key aspects. It is not enough to have good design, construction, and materials selection individually to produce a reliable and cost effective pavement. Even if each activity is done well by itself, it by no means guarantees successful pavement performance under the critical conditions that exist today. Consistently successful performance requires an integrated approach using mathematical models that compute the impact of each factor on stresses and deflections, and predict the damage related to distress and various functional conditions (e.g., smoothness, noise, and friction).

### **Feedback Data for Continuous Improvement**

Pavement management systems do not provide feedback data adequate for improving concrete pavement performance. Many such systems cannot even relate performance-monitoring data to original construction project information and traffic data. This critical gap can be remedied by developing improved data measurement and storage systems that not only provide this information rapidly, but also help analyze it. The goal of these new systems would be to provide rapid feedback both to schedule improvements in response to user feedback and continuously improve design, construction, materials selection, rehabilitation, and other aspects affecting performance.

## **Performance Data on Innovations Through Accelerated Test Roads**

Many aspects of design, construction, materials, and rehabilitation need further validation. Moreover, many innovative ideas are never tested because of the risks and costs of failure. Conducting full-scale testing or, in some cases, testing at existing accelerated loading facilities (ALF), would provide a rapid and efficient means to meet both validation and testing needs. Some performance data, such as information on early opening of a roadway to traffic, can be gathered using ALFs (testing machines in buildings). Other data would need full-scale outdoor traffic testing using regular mixed traffic (similar to the Minnesota Road Research Project (MnROAD)) or special trucks (similar to WesTrack vehicles). This plan would provide an excellent way to test new and innovative ideas for concrete pavement design, construction, and rehabilitation. A significant need exists to both supplement and build on the results from Long-Term Pavement Performance (LTPP) studies and sites such as MnROAD.

## **Impact of Preservation Activities on Performance and Life**

The impact of today's concrete pavement preservation alternatives (e.g., diamond grinding, dowel bar retrofit, and joint and crack resealing) on future life and performance is not fully understood and accepted. Establishing full-scale test sections under actual traffic loadings of innovative preservation activities would provide valuable information to establish the cost and benefits of such activities. These tests would build on information gained through the limited LTPP studies (Specific Pavement Studies (SPS)–4 and SPS–6). Since it is believed that well-timed preservation activities can be used to extend the service life of concrete pavements cost effectively, this is a significant gap that can be filled with appropriate research studies.

## **Economics and Innovative Contracting**

In most markets, concrete pavements are generally considered a high-priced option compared to asphalt solutions when examining initial costs, but are equal or lower when addressing life cycle costs. This is the generally accepted norm given current design procedures. Few tools exist, however, to determine effectively the true initial costs and price of items such as joints, sealers, and tie bars in various designs in specific projects. Most estimating is based on previous bid estimates. In addition, long-term analyses in life cycle costs lack knowledge on which to improve maintenance analyses and user impacts.

Over the past several years, interest has grown in looking at corridors or areas, rather than projects. This requires a new analysis technique that studies pavements at different stages of life, but if examined in a way to mitigate traffic shutdowns, might require multiple fixes on a single project.

In addition, alternative contracting techniques, such as design-build, best value, and warranties have cost implications that have not been studied or consolidated. The need is especially strong to examine the relationship of risk to the concrete pavement designer/builder, and how best to equalize or at least quantify the risk. Also, if use of warranties continues to grow, with or without maintenance requirements, then new bonding, insurance, and guarantee mechanisms need to be explored. Roles between government and industry are changing, so tools need to be developed that equitably evaluate the risks.

## **Public-Private Partnerships**

Interest is growing in public-private partnerships, in which investors consider financing capital expenditures in return for either real or shadow tolls. Pavement costs could run 40 to 60 percent of a capital expenditure, with various options having a major impact when compared to traffic and tolling. Different concrete pavement solutions must be examined to balance initial cost, maintenance, traffic growth, and toll revenues.

## **Technology Transfer**

Information is transferred too slowly to policymakers, engineers, and the concrete paving workforce. The concrete paving industry lacks innovation because of both the return on investment and the considerable time it takes to transfer innovation into practice across the United States.

## CHAPTER 8. RESEARCH MANAGEMENT PLAN

Research plans can debut with great promise, only to fail to capture the imagination and support of the stakeholder community. With no less a mission than reinventing the concrete pavement industry, this research plan must not fail. Therefore, the CP Road Map is accompanied by a unique and bold, yet realistic, research management plan that will keep stakeholders involved and committed to the road map's success.

The research management plan in this chapter:

- Outlines a solid, long-term research management structure.
- Describes the administrative and estimated financial resources needed.
- Identifies potential barriers and critical issues for each research track.
- Suggests strategies, processes, and methods for moving forward with the CP Road Map.

### ASSUMPTIONS

This research management is based on several assumptions:

First, the CP Road Map is a national research plan, not a plan solely for FHWA or any one organization.

Second, the CP Road Map is not restricted to any single funding source. Publicly financed highway research is decentralized and probably will remain so. Public and private organizations that enjoy dedicated funding understandably are hesitant to relinquish fiscal or technical control—but are willing to partner if it is in their self-interest.

Third, even in a decentralized arena like research, it is possible—indeed, critical—for stakeholder groups to come together voluntarily. The CP Road Map itself is an example of the dramatic success that can be accomplished through partnering and cooperation. Federal, State, and industry research staff and engineers around the country are looking for more opportunities to pool their funds and other resources in win-win situations, as has been done in the successful MC<sup>2</sup>. By working together to identify common interests and agreeing to cooperate for the long haul, stakeholders can produce something greater collectively than they can independently.

Fourth, the all-too-common disconnect between research results and implementation of those results should be fixed. Communication, technology transfer, and outreach activities should be elevated to the same level of importance as research itself.

Finally, the CP Road Map is too comprehensive and too important for a part-time management effort. Managing the overall research program effectively and judiciously will require dedicated personnel with adequate resources.

## OPERATING PRINCIPLES

Given these assumptions, the research management plan is based on four principles that will govern conduct of the research:

- **Triparty management.** Overall management of the CP Road Map will be a cooperative effort undertaken by a triparty group of Federal, State, and industry representatives who voluntarily choose to work together.
- **Project coordination.** Organizations with research funding can elect to fund and conduct research independently or to join with others in pooled fund studies or similar pooling mechanisms. Research organizations, however, will make a good-faith effort to share both the scope of work and the research findings to help complete one or more research tracks outlined in the CP Road Map. To this end, FHWA may want to use a portion of its discretionary funding as seed money to promote cooperation and leveraging of funds.
- **Long-term commitment.** Research organizations will make a good-faith commitment to work over the long term to effectively accomplish the goals.
- **Communication, outreach, and training.** Research organizations will inform, communicate, and train the workforce quickly and efficiently throughout the life of the program, accelerating final implementation of the products and promoting a continuing sense of accomplishment and value.

By following these principles, the research management plan will help organizations conduct more research with fewer staff, find new partners, and, most important, deliver new and improved products to their constituents.

## CRITICAL ELEMENTS OF THE RESEARCH MANAGEMENT PLAN

The agreement between FHWA and Iowa State University outlined specific issues that needed to be addressed in the research management plan:

- Research outputs.
- Consensus building—a consortium-type approach.
- Formal outreach and education programs.
- Continuous project management and update of the CP Road Map.
- Integration of cost and performance.
- Barriers to implementation.
- Effective use of the research database.

Each of these issues is thoroughly covered in the research management plan described in the rest of this chapter.



## RESEARCH MANAGEMENT PLAN: A UNIQUE MODEL WITH ROOTS IN THE PAST

In developing this plan for managing research, the team evaluated the research and technology transfer phases of another major, long-term research effort: the Strategic Highway Research Program (SHRP).

Each SHRP phase was managed by a specific organization (the research phase by the TRB SHRP Program Office; the technology transfer phase by FHWA's Office of Technology Application). Each phase had dedicated funding sources, although many technology transfer projects were undertaken using State funds, NCHRP awards, and pooled funds.

Although the broad, ambitious nature of the programs is similar, there are fundamental differences between the SHRP models and the CP Road Map research management plan. The CP Road Map is setup as follows:

- No funds have been dedicated to conduct the research outlined in the CP Road Map, nor is a single large pool of funding desired.
- No single Federal organization or office will manage the work. Instead, a volunteer oversight group representing Federal and State agencies and industry will provide broad management oversight, and the partnering organizations will fund a support services group to do the day-to-day, nuts-and-bolts work.
- The research tracks will be managed by volunteer organizations (universities, DOTs, perhaps industry).
- Research will be conducted by organizations that want to share resources and leverage their own funds.

The FHWA Transportation Pooled Fund Program is similar to the CP Road Map research management plan. Under the pooled fund program, States, universities, and private organizations voluntarily come together to share resources and achieve common goals. Many pooled fund activities have been and are very successful.

Some people think this level of cooperation will not happen—indeed, cannot happen—with a program the size and duration of the CP Road Map. Many stakeholders who have previewed the plan believe otherwise, and that what is needed is a few champions to step forward and get started.

## PLAN GOVERNANCE STRUCTURE

The research management plan puts these principles and critical elements into practice through a four-tier governance system (see figure 14).

1. An **executive advisory committee** consisting of representatives from the Federal government, State agencies, and industry will be responsible for overseeing the CP Road Map.

2. **Research track team leaders** will assume responsibility for coordinating all activities in a specific research track and coordinating across track lines. Track leaders will be active, long-term champions (individuals or organizations) of what are, in essence, 12 individual but related research programs.
3. Core organizations, or **sustaining organizations**, will assume responsibility for conducting specific research within tracks.
4. An **administrative support group** will be responsible for providing professional management services for the CP Road Map, operating chiefly as the administrative arm of the executive advisory committee but also supporting the administrative functions of the research track team leaders and sustaining organizations.

These groups are described in more detail later in the research management plan. First, however, is a brief overview of the way these groups will be organized and work together to begin implementing research as soon as possible.

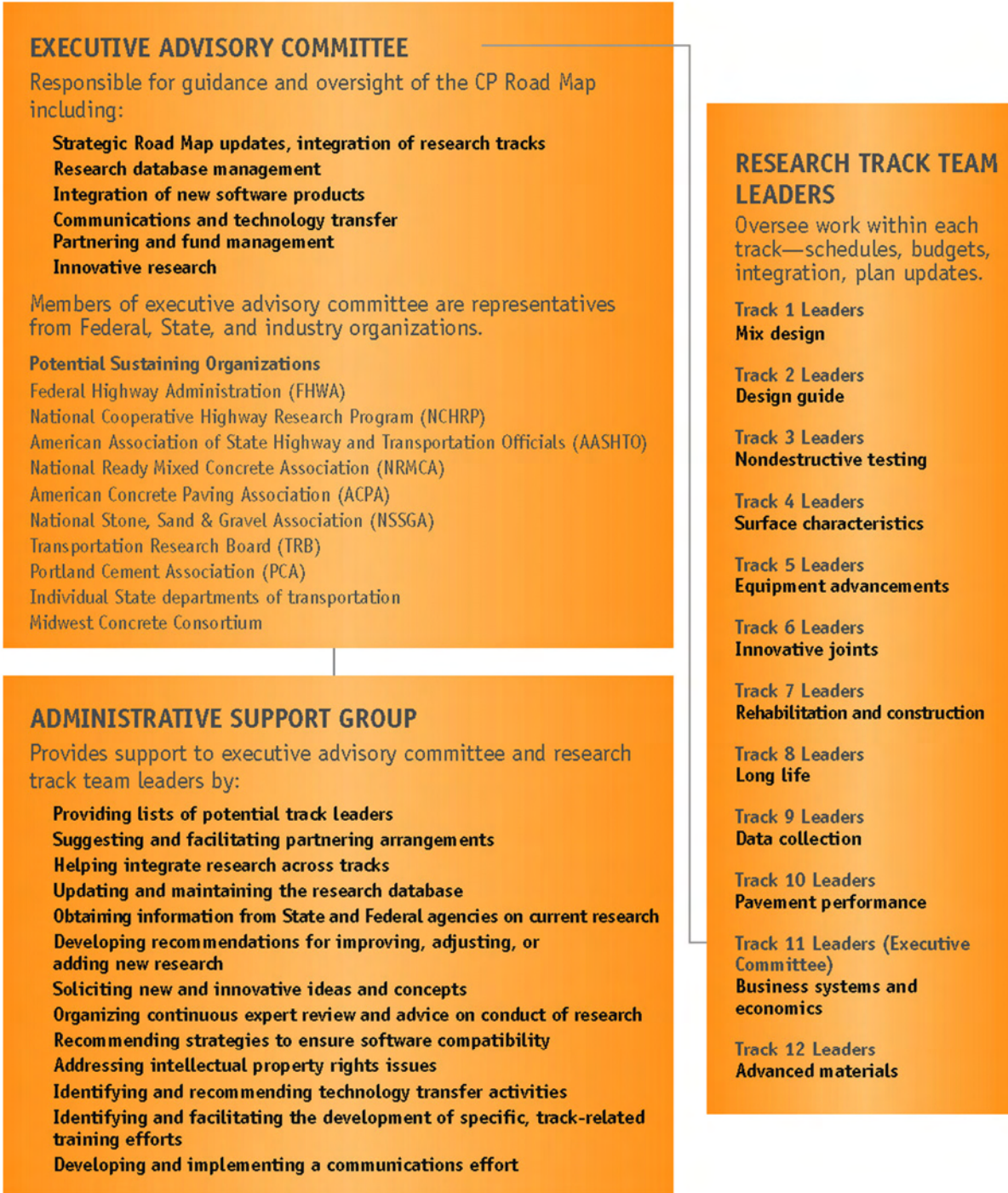

Figure 14. Research management plan.

## **GETTING STARTED**

Research management should begin immediately. If not, the industry risks losing momentum and stakeholder enthusiasm for the CP Road Map. It also risks that the CP Road Map will become obsolete before it gets underway.

The following steps should be taken immediately and completed within 6 months of acceptance of this report:

1. FHWA, industry, and several key DOTs should sponsor a meeting of leaders from organizations interested in participating in the CP Road Map (that is, potential sustaining organizations and track team leaders). This meeting would aim to accomplish the following tasks as soon as possible:
  - Develop and finalize a triparty agreement (industry, FHWA, and State agencies) that validates the CP Road Map, the research management plan, and the commitment to work cooperatively.
  - Determine the executive advisory committee.
  - Identify track team leaders for as many tracks as possible; beginning work on tracks 1 through 4 is especially critical.
  - Fund and identify the administrative support group.
  - Develop a memorandum of understanding and cooperation among the sustaining organizations.
2. Convene the executive advisory committee, track team leaders, and administrative support group to develop an early action plan that identifies work underway, work planned, and critical unfunded work.

In reality, the entire process will start simultaneously and not in sequential steps. Many parties will express interest in specific research projects or tracks. As these organizations step forward, the principles may choose to assume a more managerial role on the executive advisory committee or as track team leaders. In addition, research will be funded continuously. Those who see merit in working together will identify ways to do so.

## **OPERATING DETAILS**

The four governing groups described earlier have separate but coordinating responsibilities.

### **Executive Advisory Committee**

#### ***Membership***

Members of the executive advisory committee should represent the three major interest groups: Federal and State agencies and industry. Each committee member should have appropriate experience, a progressive vision, a serious commitment to the CP Road Map, and a willingness to seek consensus among other organizations and special interests.

Beyond that, it is difficult to define committee membership in detail. The size of the committee depends, in part, on how many organizations believe it is in their best interest to participate. The committee should be balanced, with members representing different backgrounds, experiences, and viewpoints. Committee members should be committed champions in their own right.

Specific representatives may change from time to time, but the committee itself should be prepared to function for at least 2 to 4 years. As the work evolves, the committee should reinvent itself to stimulate continuous enthusiasm and interest.

### ***Responsibilities***

The executive advisory committee should be a decisionmaking, policymaking, and facilitating group with many responsibilities:

- Determine research track team leadership.
- Promote partnering arrangements.
- Ensure adequate integration of research across tracks.
- Develop and implement a strategy to ensure that software products developed through various research tracks are compatible.
- Identify new research program areas.
- Oversee the update and maintenance of the CP Road Map database.
- Develop a communications effort to keep the CP Road Map and its products in front of stakeholders and the public.
- Conduct self-evaluation studies.
- Keep the momentum focused on outcomes, not just output.
- Encourage innovation throughout the process.
- Minimize bureaucracy.

To accomplish these responsibilities, the committee should have a strong, fully funded administrative support group.

The executive advisory committee has one final but closely related responsibility: act as track team leader for track 11. Track 11, Concrete Pavements Business Systems, consists of stand-alone problem statements covering key, crosscutting efforts in the following areas: macroeconomics and life cycle costs, alternative contracting and incentives, environmental business issues, accelerated training programs, and development of major publications such as compendia and white paper series. Track 11 also contains an innovative subtrack on concrete roads of the future. These issues naturally fall within the purview of the executive advisory committee.

### **Research Track Team Leaders**

#### ***Participation***

The research track team leader strategy is a bold and creative way to oversee research. It depends on one or more sustaining organizations (described below) stepping forward to become team leader(s) for each research track. There are no real limits on who can assume track team

leadership. Track leaders could be single organizations, or a working structure consisting of either multiple sustaining organizations or individuals with stature in the concrete industry that want to steer the track toward fulfilling the goals.

### ***Responsibilities***

In addition to cooperating with the executive advisory committee, research track team leaders should provide technical oversight of the actual conduct of research in their area. This oversight should include, but may not be limited to:

- Validating the overall research track and establish its credibility.
- Updating the track as required, including time, budget, and scope of work.
- Identifying organizations that want to conduct or partner in actual research.
- Establishing and overseeing subordinate technical expert working groups as appropriate to guide complex work.
- Ensuring proper integration of discreet research work within the track and across track lines.
- Developing status reports.
- Promoting track communications and outreach efforts.
- Identifying and conducting implementation (technology transfer) activities throughout the research phase.
- Identifying and facilitating the development and conduct of specific track-related training efforts.
- Continuing to solicit new and innovative ideas and concepts related to the track.

Research track team leaders should not develop and issue requests for proposals. Instead, working with the executive advisory committee, they should foster partnerships among organizations willing to pool and leverage dedicated funds to accomplish ambitious research projects within the tracks.

### **Sustaining Organizations**

#### ***Participation***

No single organization has the resources or experience to deliver all of the research suggested in the CP Road Map. However, several national organizations, plus numerous State and local/regional organizations, have research programs related to work outlined in the CP Road Map and, therefore, a vested interest in coordinating their efforts with the CP Road Map and supporting its overall goals. (Many of these groups were represented at one or more of the brainstorming events and provided input and feedback on the CP Road Map.) For purposes of the research management plan, these stakeholders are called “sustaining organizations.” Several potential sustaining organizations are described in appendix C.

#### ***Responsibilities***

Sustaining organizations should assume responsibility for conducting specific pieces of research, generally because they have the specialized interest, skills, or funding. Sustaining organizations will quickly see the benefit of supporting the overall CP Road Map, conducting specific research

in support of the overall goals, and working together to leverage both funding and human resources.

## **Administrative Support Group**

### ***Participation***

Needless to say, the voluntary nature of the governing structure outlined above should be linked to a fairly substantial, funded support mechanism. The fourth tier of the governance system, the administrative support group, is that mechanism. This group should consist of an organization or an expert team with technical and administrative expertise in large program management. Its primary role is facilitation, not control.

### ***Responsibilities***

This group's primary function is to be the administrative arm of the executive advisory committee, research track team leaders, and sustaining organizations. The administrative support group should be the "doing" body for all activities to coordinate the efforts of the groups on a continuing basis. The administrative support group's second function is to provide the communication and outreach services recommended by the executive advisory committee.

### ***Funding***

It is proposed that funding be provided for the administrative support group through the triparty agreement to hire full- and part-time staff.

## **MORE ABOUT THE EXECUTIVE ADVISORY COMMITTEE**

Figure 14 identifies five general functions for which the executive advisory committee, supported by the administrative support group, should be responsible:

1. Database management, CP Road Map update, and research track integration.
2. Partnering, fund management, and contracts.
3. Software integration.
4. Research management, communication, and training.
5. Concrete pavement innovation.

It is suggested that the executive advisory committee also act as research track team leader for track 11, Concrete Pavements Business Systems. The problem statements in track 11 support the committee's work.

As described below, each of these functions is critical to the success of the CP Road Map.

## **DATABASE MANAGEMENT: RECHARGING THE BRAIN OF THE CP ROAD MAP**

In a very real sense, the comprehensive database that accompanies this report is the CP Road Map, or at least its central nervous system. Successful implementation of the CP Road Map depends on a comprehensive approach to database management.

The administrative support group will maintain and update the database, but exact details on who, where, how, and how much should be decided by the executive advisory committee. There are many options, but database management should be based on the following principles:

- Research problem statements, projects, budgets, timelines, and research results in the CP Road Map database should be updated regularly.
- The database should include only those research problem statements, projects, budgets, timelines, and research results related to the CP Road Map as revised and updated during its implementation. (Other databases are better suited to the compilation of all concrete- and concrete pavement-related projects.)
- The database should include all research problem statements, projects, budgets, timelines, and research results related to the CP Road Map. The database should reflect the output as it relates to the accomplishment of each track.
- The projects should be plotted on spreadsheets, with full data in the narrative portion of the database.

The database administrator should provide regular status reports on the entire CP Road Map and specific research tracks. The database's principle audience is the executive advisory committee and research track team leaders. The second audience is sustaining organizations that want to see where proposed research fits into the overall road map. Brief monthly and annual reports on the status of the program should be prepared to keep everyone informed.

A potential third audience is the general researcher or information seeker. Only enough money and effort should be expended to serve the first two audiences. The database is intended to serve the infrastructure of the CP Road Map; it is not intended to serve the general pavement community, for whom other databases are available.

### **Database Management, Road Map Update, and Research Track Integration**

The database includes two elements. The first is a Microsoft<sup>®</sup> Access database that includes all problem statements developed for the CP Road Map. The second is a series of Microsoft Excel spreadsheets that contain the integrated research tracks with time phasing and coded linkage to the problem statements. The spreadsheets also contain budgets.

The database has a search engine that allows users to sort problem statements. This is an important feature for a program of this magnitude.

Keeping the database current is critical to success of the CP Road Map. As research contracts with detailed scopes are identified, they should be added to the database. Likewise, completed contracts and their deliverables should be entered into the database.



A continuously updated database will:

- Provide current status on the execution of all details of the program.
- Lead to recommendations to adjust CP Road Map goals as the program evolves.
- Determine completeness of research related to the goals of both the research tracks and the CP Road Map.
- Provide information to ensure that issues related to integrating research tracks are recognized and addressed.

Without immediate and continuous updating to include ongoing work around the country, the database will quickly become obsolete.

### **Software Integration**

One of the CP Road Map's primary goals is to integrate design, mix, construction, and performance (e.g., to consider project-specific mix, materials, and construction issues when developing pavement design). The executive advisory committee should ensure that the capability exists to link these aspects of concrete pavement projects by exact formulae rather than by subjective personal experience and judgment. Therefore, several CP Road Map research tracks and problem statements focus on continued development of computer models that integrate variables across these lines. The power of integration depends on computer and software power. The goals of several tracks cannot be met without effective software management.

A software policy needs to be developed and implemented to support the integration process. Obviously, no single person, company, or agency should develop all of the software, so some complicated intellectual property right issues may need to be addressed. This should be an early order of business for the executive advisory committee.

### **Implementation, Coordination, and Training on Research Output**

The entire U.S. highway community should be made fully aware of the CP Road Map, including research proposed and projects underway, key findings, and active participants. Strategic short- and long-range marketing strategies for research products should be developed, leading to implementation. Research products will fall into several categories and need to be marketed accordingly. As specific training media are developed, they should be added to the specific track.

More specifically, implementation, coordination, and training should include, but may not be limited to, the following activities:

- Identify products and techniques that are essentially complete and should move to implementation or deployment.
- Promote customer evaluation of products that require local materials and adaptation to regional, State, or specific industry practices.
- Advance promising products and processes through further research, development, testing, and evaluation.

- Provide training to use products, and initiate activities to enhance long-range educational efforts.
- Promote activities by standard-setting organizations such as AASHTO, the American Concrete Institute, and ASTM that enhance the acceptability and credibility of products. This would be especially beneficial in helping to reduce the number of State standards that inhibit regional and national consistency.

Each research track includes funds for outreach and training. The executive advisory committee, however, may recommend a fund strictly for outreach and training, pooling monies from each project. Historically, the cost of implementation and technology transfer activities is estimated at 10 percent of research funds, but in reality implementation costs can vary from 1 to 500 percent of research, making a pool of funds for research results implementation and technology transfer very desirable. Such a pool should be part of the budget for the administrative support group's activities.

### **Partnering and Fund Management**

Partnering efforts should help organizations that wish to participate in the CP Road Map research connect to others with similar interests. To be proactive in generating partners to conduct the research, a dedicated fund for seeding projects may entice sustaining organizations to fund projects. A key responsibility of the executive advisory committee, after the first wave of projects is funded, is to help establish a more detailed seed money management system and ensure its proper implementation.

### **Concrete Pavement Innovation**

The challenge at the outset of this project was to think outside of the box and avoid searching only for incremental improvements. Given the total of research, technology, management, and funding issues addressed in the CP Road Map, this long-term research plan is innovative, challenging, and exciting. In addition, several specific problem statements in the CP Road Map, especially those involving development of new and innovative joints, call for innovation.

In addition, the research management plan includes establishing an innovative research initiative, similar to TRB's Innovations Deserving Exploratory Analysis (TRB-IDEA) programs, that focuses specifically on concrete pavement needs. The innovative research initiative should fund research on promising but unproven innovations with potential for helping to achieve overall goals of the CP Road Map. Establishing such a program should require organizational development, funds, and a matching system.

## **SPECIFIC RESEARCH MANAGEMENT CONSIDERATIONS FOR RESEARCH TRACKS**

As discussed in chapter 3, the 12 research tracks include 9 sequenced, or time-phased, tracks (type 1 tracks) and three tracks in which the sequence of research is not critical (type 2 tracks). The following brief discussion of research management issues within the tracks should help track team leaders get started quickly and efficiently.

## **Type 1 Research Tracks Management Considerations**

Each type 1 research track is, in essence, a complete research program. Each has its own management and research management issues that should be considered, especially early in the process.

Note that many of the tracks and subtracks include a framing problem statement, which becomes a framing study on implementation. The framing study calls for a full examination of the research track that includes formatting it into specific, manageable contract packages, depending on resources available from sustaining organizations.

The next step is to reevaluate the problem statements to ensure that the work is carefully sequenced and reflects a logical progress of research and funding availability. The final step is to expand each research problem statement into a detailed research plan with tasks, funding, and specific objectives.

In several cases, however, the framing study should require developing an actual usable product, such as in track 1 on performance-based mix design. Each framing problem statement is clear in its intent.

### ***Track 1. Performance-Based Concrete Pavement Mix Design System***

This track has several important research management issues to address. First, the framing study calls for developing a first cut of the future mix design procedure, using current consensus documentation. It proposes that State DOTs and industry assemble the best mix of design and laboratory practices in an organized way, using today's technology and the following steps:

- Initiate consensus building among critical parties.
- Document and validate best practices.
- Validate new business models with the eventual transfer from DOT-controlled method specifications to end-result and performance specifications.
- Eliminate variations among DOTs in mix areas that are not border-sensitive.
- Provide a framework for followup and integrated research work—"plug 'n play." This framework also should provide a consistent mix design process for researchers to use in other projects. This will help reduce the wait for the completed product.
- Provide for integration with the proposed (track 2) performance-based design guide.
- Develop initial target values related to concrete pavement mix designs.
- Establish AASHTO (or industry) as the standard-setting and control organization for future research, similar to Superpave<sup>®</sup>.
- Link this work to personnel training and begin the conversion process.
- Simplify the laboratory certification process by reducing the number of minor variations in the test procedures between borders.

Another critical point is to agree on a specification format for the new tests and procedures that should be developed. The AASHTO provisional standards process could be adopted as the model.

While not necessary, it would be extremely beneficial for the research track team leaders to have access to mix design laboratories and commit to evaluating new tests and procedures as soon as they come online. It is important that procedures and test equipment coming out of the research be validated by two or more additional laboratories. This should accelerate knowledge transfer and provide onsite expertise on many new procedures. It also would be advantageous to have two or three other laboratories, such as FHWA or NRMCA, involved in this track.

A critical element of this track is continuing FHWA's work on mix optimization and the MC<sup>2</sup>'s pooled fund study on mix designs. Both efforts need to be included; they should provide considerable insight into any additional research that might need to be added to the track.

### ***Track 2. Performance-Based Design Guide for New and Rehabilitated Concrete Pavements***

This track has several critical research management issues. First, as discussed earlier in the report, this track builds on the latest version of continuing the development of models, integrating design with mix design and construction specifications, and improving reliability and the validation/calibration process. This is extremely complicated work and will require a close working relationship with current activities under the *Mechanistic-Empirical Pavement Design Guide*, accelerated testing for validation and calibration, and specific software integration issues.

Second, AASHTO's Joint Task Force on Pavements historically has been the lead organization for developing the guide, while FHWA has financed many of the model development contracts. It is not clear which organization is best suited to manage this track. Most probably, it would be a combination of the two organizations, plus a major university with faculty deeply involved in concrete pavement modeling and design.

As new and updated models are developed, the software should be structured so these advanced models can be plugged in. Appropriate software protocols for the research products should be investigated.

The *Mechanistic-Empirical Pavement Design Guide* focuses on the continued advancement of material properties and linkage with track 1, the mix design track. Both tracks show many model development activities. Ensuring compatibility and detecting gaps and overlaps is a role for the executive advisory committee through its systems integration function.

Concrete pavement overlay design now is divided into categories based on the type of existing pavement structure—whitening, bonded, unbonded, etc. The new guide is intended to retire these terms and use only the term "concrete overlays." Multifaceted foundations should be treated as inputs. This should result in one design procedure. In practice, there are many pavements with multiple layers of both concrete and asphalt, making the conventional terms difficult to apply.

Elsewhere in the CP Road Map are projects to develop a mechanistic approach to concrete pavement restoration techniques, a design catalog, and improved low-volume road designs.

### ***Track 3. High-Speed Nondestructive Testing and Intelligent Construction Systems***

This track is probably the most challenging of the CP Road Map. It calls for identifying, researching, experimenting with, and adopting a full series of nondestructive tests for both handheld testing equipment and automation of the paving operation. The framing study is truly critical, and much like the mix design track, should require significant coordination with both the equipment and sensor companies.

The objectives of the intelligent construction equipment are to:

- Improve construction operation efficiency with early detection of potential problems.
- Provide continuous inspection that should reduce the dependency on small samples and onsite inspectors.
- Provide a long-term record for asset management systems.

If these goals are accomplished, concrete pavement construction technology should become more critical than any other highway construction operation.

Three framing studies are included in the track. The objective of each is to develop a detailed architecture for both hand-held and equipment-mounted test equipment. They could be combined into one study, but the differing objectives of each framing study are critical. The first study calls for a full investigation of both current NDT technology and sensor technologies in other industries. Sensor advancements in the manufacturing industries are accelerating at a rapid rate. Radio frequency identification technology, for example, should be understood and defined within the context of concrete pavement technology.

The second framing study structures the work with equipment manufacturers to develop a long-term, mutually beneficial research and development program, the scale of which may be unprecedented. This requires a clear understanding of the objectives, technology, application, and economics. The track team leadership could be facilitated by a State DOT and an equipment manufacturer.

The questions that should be addressed in all these framing studies are important:

- What is the real potential and effectiveness of the proposed technology?
- Do we have or can we get the human factor upgraded to understand, use, and maintain the new technology?
- Should the industry provide cooperative funding?
- What are the intellectual property issues and are they surmountable?
- How should we tackle software compatibility and integration with DOT systems and between equipment systems?

It would be extremely helpful in the framing study to develop a schematic and a three-dimensional, wall-mounted presentation of a fully automated and sensed concrete pavement operation, including aggregate crushing, storage, moisture, gradation, batching, transporting, placing, finishing, and opening to traffic. This would effectively outline the research details, help organize the concepts, and market the ideas to potential vendors.

#### ***Track 4. Optimized Surface Characteristics for Safe, Quiet, and Smooth Concrete Pavements***

This track probably represents the newest addition to the concrete pavement industry's needs. The need for intensive research on noise generated by tire/pavement interaction was raised 12 years ago when FHWA and AASHTO conducted a study of European concrete pavement technology through the International Technology Scanning Program, but there has been no coordinated research effort in the United States until now. Noise research that addresses the highway abutters and elevates the driver's experience is needed. The track, however, promotes research in all surface characteristics areas—friction, smoothness, noise, lateral drainage, spray, and rolling resistance—and suggests a balanced approach. Engineers will need to know more about megatexture, macrotexture, and microtexture and how each impacts specific surface characteristics. This track includes research on mix designs to meet predetermined values and innovative construction equipment to produce consistent field values.

Track team leaders must insist on long-term solutions for the noise element of the track and not be distracted by early pressures to develop a quick-fix solution. It also is important that measuring equipment be defined early in the process to ensure that data can be collected and analyzed properly. Eventually, the noise issue should be linked to noise mitigation strategies, which may link specific pavement solutions to the noise mitigation solution. This would require that a threshold value be established for pavement rehabilitation. Another critical factor is to determine whether pavement noise threshold values should apply to rural pavements, urban pavements, or all pavements, and if a solution for drivers can be found, as well.

The track also includes a full series of issues related to smoothness and friction. A critical issue with friction is tort liability and the setting of threshold values. This issue has been a deterrent to conducting more open research and technology sharing. In a truly performance-driven pavement design, setting various thresholds for factors like loadings, noise, friction, and spray over the service life of the pavement could expose authorities to public and possibly legal challenges, should any of the thresholds be exceeded. This is especially true for setting friction thresholds.

#### ***Track 5. Concrete Pavement Equipment Automation and Advancements***

Research management of this track is similar to the NDT/ICS track in that cooperation with the equipment manufacturers is critical. It is possible that the two tracks would be managed by the same group. This track, however, will focus on developing a clear description of each new or upgraded piece of equipment and determining if there is sufficient market to justify the product development costs. Equipment manufacturers constantly discuss the chicken-and-egg concept on equipment development: If they develop it, will there be a market? If there is market, they will develop it. The track will require a paradigm shift in market definition with more pressure on DOTs to help define the future and make it a reality.

As a first step, a pool of DOTs interested in this track could partner with contractors from their local concrete paving industry to review and provide input into the early planning process. This should help raise awareness, establish a potential market, and identify any barriers (such as specification impediments) that would impede the research. Another key step is to develop contract language to allow experimentation with the new equipment on active construction projects. With enough commitment from DOTs to provide cooperative partnering and sufficient

sites, equipment manufacturers should be better able to decide if the chicken-and-egg discussion is resolved.

Within the framing study, the track team leaders may want to examine in detail the French Charter of Innovation system of partnering with equipment manufacturers. This system is a joint-venture approach in which the government, equipment manufacturers, and contractors work collectively to advance equipment.

### ***Track 6. Innovative Concrete Pavement Joint Design, Materials, and Construction***

With the cost of joints running 12 to 20 percent of the cost of concrete pavements, and joints being the primary driver of maintenance and rehabilitation, a blend of new performance data and incremental improvements in construction practices could have significant payoff. Many such projects are included in the track. The track also addresses the need for breakthrough thinking on designing, constructing, and repairing joints. One idea to explore is bottom-up cracking (as opposed to joint sawing) through frames fastened to the subgrade. There are undoubtedly many more.

Track team leaders should strive for a balance in the overall program. The challenge on long life pavements is to design and place a dowel configuration that will last 50 to 60 years with minimal maintenance. This is nearly double the current life on even moderately loaded pavements.

On shorter life pavements—thin overlays, for example—the challenge is to find a solution somewhere above the load transfer provided by aggregate interlock and a full dowel assembly. Is there a dowel design with a lower initial cost that meets the performance requirements, something in the more moderate 20-year life? And would the pavement design culture allow use of this shorter life assembly to save initial costs?

The track includes an innovative joint design competition. A strong, competitive program could address both long- and short-term issues. The competition also will look for fresh ideas on joint design that break away from the one-size-fits-all dowel bar.

### ***Track 7. High-Speed Concrete Pavement Rehabilitation and Construction***

Two national initiatives, NCHRP 20–58(1), “Accelerating the Renewal of America’s Highways” and the FHWA Highways for LIFE (Long Lasting, Innovative, and Fast Construction of Efficient and Safe Highway Infrastructure) program, will influence this track. The specific problem statements included in the track could fit easily into either program, should they be funded and evolve as expected. There should be close coordination among the three programs.

A timeline is included for these activities, but they could have been treated as independent items. The precast and modular subtrack for example, could easily be developed as an independent track. The track team leaders should consider this in their planning; they may find that a small but important group of States would rally better around a smaller effort. Also, the mix projects could be placed under the performance-based mix design track.

An important project is the simulation and constructability effort. It is difficult to capture all of the important items learned on a project, so constructability reviews are helpful in applying

experience from the field to the next project. This has great education merit, as well. Industry and DOTs could gain insight into traffic management, plant and haul routes, waste disposal, and other issues that would help show how concrete paving operations could be conducted in different scenarios.

### ***Track 8. Long Life Concrete Pavements***

The concept of long life pavements was difficult for many participants in the brainstorming sessions to grasp. Many factors come into play, including high initial costs for difficult-to-estimate traffic and land management changes for a 60-year period.

At one of the first brainstorming sessions, participants defined a long life pavement as a “no-fix-required” pavement that would last 50 to 60 years with relatively heavy loads throughout its life. The participants quickly modified this definition to allow for planned surface renewal with multiple grindings or the addition of a thin overlay.

A more pragmatic definition eventually evolved that called for planned maintenance between 10 and 30 years, followed by a fairly heavy joint repair and possibly an overlay to take the total pavement life to 60 years. Another definition called for a mandatory strong foundation with a thinner slab designed for 20 years of service. This would be followed by the construction of a wraparound slab that would provide service for an additional 30 to 40 years. This alternative would reduce the high initial cost, but provide for the future.

Before starting this research track, the track team leaders should use this input to clearly define a long life pavement with the following factors:

- Long-term foundation and drainage at initial construction with service life of 50 to 60 years or beyond.
- Improvements to the functional requirements only (surface improvements).
- Predetermined staged construction for the slab.
- Some major rehabilitation, but only if it can be done at very high speed and be limited to the slab only.

Applications that seem appropriate are not just sections with heavy truck traffic. Sections with heavy motor vehicle traffic and relatively light truck traffic loadings that show extremely high user costs during repairs could be an application for a long life pavement. The cost-effectiveness of long life solutions is not clear for facilities already at peak volume with heavy truck loadings.

Another potential application is rural sections with light traffic volume today and projected high truck traffic in the future, but several questions should be addressed. Is there enough confidence in traffic estimates and land management to justify the higher initial cost expenditure? Will planners consider the heavier initial construction cost in the statewide planning process, which subtly dictates so many pavement sections?

Continuously reinforced concrete pavements (CRCP) should be considered in long life solutions for heavy-duty pavements, but few States use the technology routinely. It would take



considerable effort to reenergize CRCP, but it should be considered, because it has a solid performance record in many locations.

Finally, the cost issue should be addressed in any final application of long life principles. The challenge is not simply to add more bells and whistles, but to add value and performance without increasing the cost significantly. Increasing life and controlling costs are imperative if long life pavements are to have a role in pavement selection.

### ***Track 9. Concrete Pavement Accelerated and Long-Term Data Collection***

Current legislation limits the LTPP program to the experiment designed in the early 1980s. No new sections or parameters are accepted into the study. This is not expected to change in the next legislation. In addition, only a handful of the 24 accelerated pavement testing (APT) facilities in the United States are capable of testing concrete pavements. The framing study would analyze all of the APTs, identify those willing and able to evaluate concrete, and link them into a consortium of users. FHWA met with 13 APT owners in July 2004. All were interested in partnering, but specific topics and partnering details will be discussed in future meetings.

There also is a need to design and build experimental sections on active roadways with live traffic. Much has been learned from the LTPP program and the SPS. The keys to building local sections are well-known and include construction tolerances, sensor placement, loadings and environmental data. Track team leaders should clearly address the experimental design and services to support that design before undertaking the experiment.

### **Type 2 Research Tracks Management Considerations**

Type 2 research tracks generally do not have time conditions. Each track is an organized collection of stand-alone problem statements under a specific topic.

### ***Track 10. Concrete Pavement Performance***

These projects address technical issues related to pavement management tools. The problem statements were restricted to issues dealing with concrete pavements and network data collection and analysis systems. They are important projects in that they will close the feedback system to design.

### ***Track 11. Concrete Pavement Business Systems and Economics***

Track 11 is unique in that its conduct dovetails with and supports the work of the executive advisory committee. Therefore, it is suggested that the executive advisory committee assume team leadership for track 11.

### ***Track 12. Advanced Concrete Pavement Materials***

Problem statements in this track are of specific interest to the concrete pavement community and provide a basis for creating the next generation of potential products for select situations. Many of these issues originated in other research planning documents and continue to be worthy of serious consideration. If any is considered especially relevant, it should be moved into an

appropriate type 1 research track, if possible, and managed appropriately. Unlike other type 2 tracks, the advanced materials projects could lead to fully developed independent tracks if the first round of research is fruitful.

### **Cross-Referenced Database Tables**

Many participants in the brainstorming events described in chapter 2 were disappointed not to see research tracks dealing specifically with foundations and drainage, pavement maintenance and rehabilitation, and environmental issues. The primary challenges related to these topics actually are being addressed in various research tracks.

As an example, the research database has been sorted to isolate problem statements related to these three critical areas; the CP Road Map presents these problem statements not only in their appropriate tracks but also in cross-referenced tables. (When research is conducted in the CP Road Map, the database manager will be able to perform additional sorts on a number of topics.)

#### ***Database Table 1. Concrete Pavement Foundation and Drainage***

The foundation effort is clearly a critical part of the performance-based design and NDT/ICS tracks. The executive advisory committee may want to work with the geotechnical community to identify additional specialty foundation and drainage research needs applicable to concrete pavements.

#### ***Database Table 2. Concrete Pavement Maintenance and Rehabilitation***

These problem statements are incorporated in many tracks of the CP Road Map. Because maintenance and rehabilitation issues are very important to the concrete pavement community, the project team seriously considering including a separate track devoted to these topics. In the end, however, subsuming these topics under the 12 functional track topics was deemed the best approach. This database table helps stakeholders see how and where maintenance and rehabilitation research topics are built into the sequence of research in several tracks.

#### ***Database Table 3. Environmental Concrete Pavement Advancements***

This category might have been a full track if the United States had a definition of sustainability that included global issues related to pavements. Addressing the gamut of concrete pavement-related environmental and energy issues, from cement and stone production through construction and recycling, was beyond the scope of this pavement research effort. As the CP Road Map stands, however, it includes several problem statements related to environmental advancements in the concrete pavement industry.

The key to improving the environmental record of concrete pavements is to find ways to reuse aggregates and fines in concrete pavements. This is definitely the higher use of raw materials and is within the industry's grasp.

The executive advisory committee may want to revisit the idea of an environmental track. With the advent of the M-E approach to pavement design, it may be beneficial to look at materials characteristics based on modulus and stiffness type values. Many State DOTs now require

recycled materials to meet all of the conditions of virgin materials. However, work done in Germany and other places shows that recycled materials could perform exceptionally well under a stiffness or modulus criteria. This approach diminishes the importance of tests such as Los Angeles abrasion, fractured faces, and gradation, and relies more on plate load testing to determine structural adequacy.

The committee may want to work with existing programs that address environmental issues. The Environmental Council of Concrete Organizations, for example, could be more mainstreamed with the highway community. These and similar organizations should be examined thoroughly for scope of work, research funding, training, etc., that could be pulled into the CP Road Map.

### **THREE SPECIAL RESEARCH MANAGEMENT CHALLENGES**

Three issues should be particularly important to the executive advisory committee: ensuring initial projects are begun quickly, supporting significant changes to business systems, and focusing on technology transfer. Many of these critical, initial issues are addressed in track 11, so the executive advisory committee should begin its work as team leader for that track as soon as possible.

#### **Early Financing and Conduct of Research**

Industry leaders should validate quickly the credibility of the CP Road Map and demonstrate their own commitment to work cooperatively to fund and implement it. Research track team leaders should begin at least one project in each track as quickly as possible. In addition, each track should be updated as soon as possible to show new starts and other ongoing work being accomplished by agencies across the country, including FHWA, Iowa State University, and State DOTs.

#### **Business System Changes**

The CP Road Map recognizes a significant transfer of roles and responsibilities from State DOTs to industry. To succeed, such a transfer requires a new business model—that is, a new way for DOTs and industry to do business together. This model should include pavement economics, capital availability, risk and risk transfer, warranties, innovative contracting, incentives, and standards ownership.

The first objective is to determine the best combination of concrete pavement solutions (mix of fixes) that balances funds, traffic impact, and network efficiency. The second is to take advantage of an array of alternate contracting techniques that could enhance the procurement of concrete pavements with an improved determination of risk between the owner and the contractor.

#### **Technology Transfer**

During brainstorming events, the speed at which new technology is applied was discussed. Stakeholders were concerned about the slowness of communicating research results to agencies and industry, as well as the slowness of industry to accept new ideas and technologies. They

were especially concerned about the lack of technology transfer and training materials for the workforce.

Effective technology transfer strategies will be critical for every research project that comes out of the CP Road Map, but particularly in the mix design and NDT/ICS tracks, where research results eventually will impact the job of every person on the construction site.

One stand-alone project under track 11 is to develop an expedited technology transfer plan. The executive advisory committee should encourage action in this area as soon as possible and monitor it continuously. Marketing and technology transfer resources available through projects such as FHWA's Task 65 on technology transfer and deployment of the Concrete Pavement Technology Program should be built into the technology transfer plan.

### **GETTING STARTED: NOT BUSINESS AS USUAL**

Beginning a long-term research program is a slow process. For 3 years, the Iowa State University-led team has been working closely with stakeholders to enlist support. Now FHWA should begin a strong research management effort.

The research tracks are ambitious but achievable. The research management plan is sound. Together, they identify what needs to be done and how to succeed to achieve the goal of the CP Road Map:

*By 2015, the highway community will have a comprehensive, integrated, and fully functional system of concrete pavement technology that provides innovative solutions for customer-driven performance requirements.*

Peer review, coordination, leveraging, and partnering are all valid strategies. For this plan to work, however, champions must step forward and join together, believing in the synergy the CP Road Map can generate (see figure 15). The executive advisory committee, supported by the administrative support group, and the research track team leaders should be true champions.

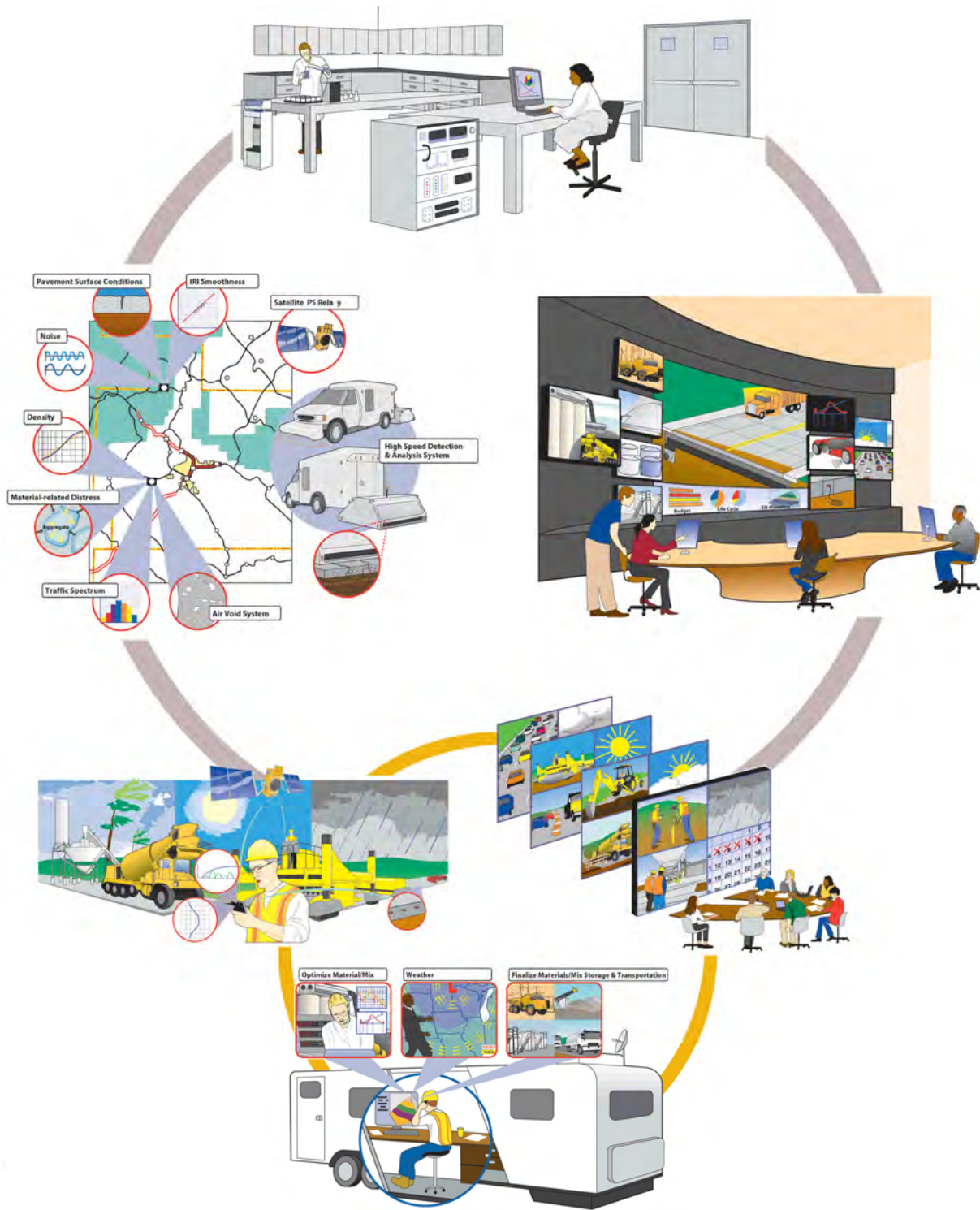

Figure 15. CP Road Map goal.



## APPENDIX A

### BRAINSTORMING EVENTS

Table 2 lists the brainstorming events and their respective dates.

Table 2. Brainstorming (outreach) events.

Date	Event
January 2002	TRB Annual Meeting (Session 345 and Subcommittees A2E01, ASF01, A2E06)
January 2002	Nebraska Concrete Pavement Association Annual Meeting
February 2002	Iowa Concrete Paving Association Annual Meeting
February 2002	Michigan Concrete Paving Association Annual Meeting
March 2002	Virginia Concrete Workshop
March 2002	TRB Committee for Improved Concrete Pavements
March 2002	Iowa Ready Mix Association Annual Meeting
April 2002	International Center for Aggregate Research
April 2002	Iowa State University PCC Center Advisory Board Meeting
April 2002	IPRF Panel Meeting
May 2002	FHWA, Turner-Fairbank Highway Research Center
June 2002	ACPA State Chapter Executive Meeting
June 2002	TRB (Subcommittee A2F01)
March 2003	TRB Concrete Pavement Research Team Presentation
August 2003	AASHTO Subcommittee on Materials

Table 2. Brainstorming (outreach) events, continued.

Date	Event
July 2003	FHWA, Turner-Fairbank Highway Research Center
July 2003	National Ready Mixed Concrete Pavement Association Meeting
July 2003	ACPA Summer Meeting
October 2003	Midwest Brainstorming Session (in conjunction with MC <sup>2</sup> , ACPA, and Iowa Concrete Paving Association)
November 2003	Center for Advanced Cement Based Materials Research
November 2003	Eastern States Brainstorming Session (in partnership with ACPA chapters)
December 2003	ACPA Annual Convention
January 2004	TRB Annual Meeting
January 2004	Pennsylvania Concrete Conference
January 2004	Western States Teleconference
February 2004	Iowa Concrete Paving Association Annual Meeting
March 2004	Missouri-Kansas ACPA Chapter Annual Workshop
May 2004	ACPA State Chapter Executive Meeting
October 2004	FHWA, Turner-Fairbank Highway Research Center



## APPENDIX B

### CRITICAL ISSUES AND OBJECTIVES IDENTIFIED AT BRAINSTORMING EVENTS

Critical Issues/Objectives	M/M	D	C	PM/BS	
Develop a concrete lab of the future that will give the user a sequence of mix design tests and procedures that integrate structural design and quality control with material selection and proportioning.	✓	✓	✓		<b>Track 1</b> Performance-Based Concrete Pavement Mix Design System (MD)
Develop the tools necessary to predict the compatibility and effectiveness of concrete mixes under specific field conditions before paving begins.	✓				
Detect potential materials-related construction problems early and correct them on the fly using innovative quality control tools.	✓		✓		
Detect potential long-term durability problems more effectively during both the mix design process and the construction quality control program.	✓		✓	✓	
Improve the ability to predict concrete mix properties and their relationship to slab behavior and performance (e.g., shrinkage, joint opening, and curing) using the next generation of advanced modeling techniques.	✓			✓	
Identify and use innovative, nontraditional materials that accelerate concrete pavement construction, maintenance, and rehabilitation and/or extend product life at a fair cost.	✓		✓	✓	
Develop viable (e.g., reliable, economical, constructible, and maintainable) concrete pavement options for all classes of streets, low-volume roads, highways, and special applications.		✓	✓	✓	<b>Track 2</b> Performance-Based Design Guide for New and Rehabilitated Concrete Pavements (DG)
Improve concrete pavement design reliability, enhance design features, reduce life cycle costs, and reduce lane closures over the design life by maximizing the use of fundamental engineering principles through mechanistic relationships.		✓	✓	✓	
Integrate pavement designs with materials, construction, traffic loading, climate, preservation treatments, rehabilitation, and performance requirements to produce reliable, economical, and functional (noise, spray, aesthetics, friction, texture, illumination) designs.	✓	✓	✓	✓	
Design preservation and rehabilitation treatments and strategies using mechanistic-based procedures that use in-place materials from the pavement structure to minimize life cycle costs and construction and maintenance lane closures.	✓	✓	✓	✓	
Develop and evaluate new and innovative concrete pavement designs for specific needs (e.g., high traffic, residential traffic, parkways).		✓			

**Critical issues identified at outreach events—regarding materials and mix designs (MM), design (D), construction (C), and pavement management and business systems (PM/BS)—were developed into specific objectives (i.e., what do we want to accomplish?).**

Figure 16. Critical issues for tracks 1 and 2.

Critical Issues/Objectives	M/M	D	C	PM/BS	
					<b>Track 3</b> High-Speed Nondestructive Testing and Intelligent Construction Systems (ND)
Perform NDT quality control tests and procedures that use 100 percent sampling to monitor performance-related concrete mix properties and reduce the number of human inspectors.	✓		✓		
Improve construction operations by providing the high-speed, continuous information used to make changes on the fly.			✓		
Integrate data collection with materials management and pavement management systems to solve future problems and evaluate performance.	✓		✓	✓	
					<b>Track 4</b> Optimized Surface Characteristics for Safe, Quiet, and Smooth Concrete Pavements (SC)
Develop reliable, economical, constructible, and maintainable concrete pavement surface characteristics that meet or exceed highway user requirements for all classes of streets, low-volume roads, highways, and special applications.		✓	✓		
Develop, field test, and validate concrete pavement designs and construction methods that produce consistent surface characteristics that meet or exceed highway user requirements for friction/safety, pavement-tire noise, smoothness, splash and spray, wheel path wear (hydroplaning), light reflection, rolling resistance, and durability (longevity).		✓	✓		
Define the relationship between wet-weather accident rates, pavement textures, and friction demand levels.				✓	
Determine the design materials and construction methods that produce different levels of short- and long-term surface microtexture, macrotexture, megatexture, and unevenness.	✓		✓	✓	
Determine the relationship between pavement surface texture levels (microtexture, macrotexture, megatexture, and unevenness) and surface characteristic performance levels (friction, noise, smoothness, splash, spray, rolling resistance, and light reflectivity).				✓	
Evaluate and develop high-speed, continuous measurement equipment and procedures for measuring texture, friction, noise, smoothness, splash, spray, rolling resistance, and other key surface characteristics.				✓	
Develop design and construction guidelines for concrete pavement surface characteristics, protocols, guide specifications, and associated technology transfer products.			✓		

Figure 17. Critical issues for tracks 3 and 4.

Critical Issues/Objectives	M/M	D	C	PM/BS	
Develop batching equipment that will produce better quality concrete mixes by optimizing the materials used and allowing for rapid adjustment of mix proportions.		✓	✓		<b>Track 5</b> Concrete Pavement Equipment Automation and Advancements (EA)
Improve paving techniques and equipment to produce higher quality concrete pavements, while optimizing material usage and reducing construction time and processes.		✓	✓		
Improve techniques for curing, texturing, and jointing concrete pavements, while allowing pavements to be opened to traffic quicker.				✓	
Improve equipment and techniques for expedited subbase stabilization and subdrain installation.	✓		✓	✓	
Develop equipment for rapid in-place reconstruction of concrete pavements using existing/recycled materials.				✓	
Improve and automate techniques and equipment for rapid concrete pavement restoration.				✓	
Introduce contractors and owner-agencies to new advanced equipment and provide assistance for purchasing such equipment.			✓		
Identify new and innovative alternatives to handling the forming, opening/closing, load transfer, and sealing for transverse and longitudinal concrete pavement joints.			✓		<b>Track 6</b> Innovative Concrete Pavement Joint Design, Materials, and Construction (IJ)
Identify criteria for the design, materials, and construction of exceptionally long-lasting joints (e.g., more than 50 years). Also see track 8 (Long Life Concrete Pavements).	✓	✓	✓	✓	
Determine optimum joint design for concrete overlays.		✓			
Determine optimum joint design for low-volume, long-life pavements.		✓			
Develop an advanced, high-speed computational model for joint condition analysis that can joint improve design, materials, and construction.	✓	✓	✓		
Develop fully and field test to determine the cost effectiveness, reliability, and durability of promising new and innovative joint designs.		✓		✓	
Develop and validate rapid methodology for evaluating existing joint conditions so that joints can be preserved and repaired.				✓	
Develop planning and simulation tools that allow contractors, designers, and owner-agencies to identify potential problems before construction begins as well as the most efficient processes.			✓		<b>Track 7</b> High-Speed Concrete Pavement Rehabilitation and Construction (RC)
Explore and refine precast and modular pavement technology for new construction, rehabilitation, and maintenance.	✓	✓	✓	✓	
Refine fast-track construction technologies and techniques and synthesize them into best practice guidelines for contractors, designers, and owner-agencies.		✓			
Provide the means for all contractors, designers, and owner-agencies to learn about new high-speed construction and rehabilitation products and technologies.		✓			

Figure 18. Critical issues for tracks 5, 6, and 7.

Critical Issues/Objectives	M/M	D	C	PM/BS	
Identify pavement strategies (design, foundation, restoration, and rehabilitation) for long life.		✓	✓	✓	<b>Track 8</b> Long-Life Concrete Pavements (LL)
Identify design and foundation features that are likely to result in long-life concrete pavements.		✓	✓	✓	
Identify restoration treatments for preserving long-life concrete pavements.			✓	✓	
Identify concrete and other material tests and requirements for long-life pavements.	✓			✓	
Identify QC/QA procedures that will ensure quality long-life pavement construction.	✓	✓	✓	✓	
Construct test highways of the most promising concrete pavement types that include design features, foundations, materials, construction QC/QA, and preservation treatments that will ensure long-life concrete pavements.	✓	✓	✓	✓	
Identify performance data needs for calibrating and validating performance models for jointed plain concrete, continuously reinforced concrete pavements, and other types of concrete pavements.				✓	<b>Track 9</b> Concrete Pavement Accelerated and Long-Term Data Collection
Develop an ALF and full-scale test road program for collecting materials, design, traffic, climate, and performance data from existing and future experimental pavements.				✓	
Establish reliable experimental testing programs along with testing protocols for ALF and test road programs.				✓	
Collect and analyze relevant test database programs that support the Strategic Road Map.				✓	
Develop ways to collect real-time data on concrete pavement conditions, including surface characteristics (friction, noise, distress, smoothness, others), climate parameters (temperature and moisture), traffic loading, moisture sensors beneath the slab, and structural factors using a combination of embedded electronics, high-speed assessment equipment, traffic measurement devices, and performance prediction equations.				✓	<b>Track 10</b> Concrete Pavement Performance (PP)
Determine concrete pavement condition using a new generation of equipment that addresses structural support, smoothness, friction, noise, moisture beneath the slab, drainage, and other factors.				✓	
Loop concrete pavement performance data back to agency maintenance, planning, traffic, design, materials, and construction units using improved management systems. This feedback will allow the required concrete pavement surface and structural improvements to be scheduled cost-effectively and the pavement technology to be improved quickly.	✓	✓	✓	✓	
Plan and schedule concrete pavement preservation and maintenance activities based on feedback condition and performance data to minimize lane closures and congestion.			✓	✓	
Optimize the volume, type, and flow characteristics of traffic through long-lasting traffic monitoring sensors embedded in the pavement.				✓	

Figure 19. Critical issues for tracks 8, 9, and 10.

Critical Issues/Objectives	M/M	D	C	PM/BS	
Understand more clearly the economics of concrete pavements, fix alternatives, and the cost implications of engineering improvements as they relate to pavement performance.				✓	<b>Track 11</b> Concrete Pavement Business Systems and Economics (BE)
Determine the best combination of concrete pavement solutions (mix-of-fixes) that balances funds, traffic impact, and network efficiency.				✓	
Develop an array of alternate contracting techniques that enhance the procurement of concrete pavements with a clear determination of risk between the owner and the contractor.				✓	
Develop optimum technology transfer, training, and outreach for the entire concrete paving workforce that the new generation of efficient, targeted, high-quality, cross-disciplined, and available-on-demand pavements will require.				✓	
					<b>Track 12</b> Advanced Concrete Pavement Materials (AM)
Improve pavement durability and long-term performance to extend pavement life further than conventional materials.	✓			✓	
Improve the construction process by reducing material requirements, labor requirements, or construction time.	✓		✓	✓	
Reducing waste through pavement reclamation.	✓			✓	

Figure 20. Critical issues for tracks 11 and 12.



## APPENDIX C

### OVERVIEW OF POTENTIAL SUSTAINING ORGANIZATIONS

**Federal Highway Administration (FHWA).** FHWA has internal committees that define, execute, and monitor its contract and in-house concrete pavement projects. FHWA manages some discretionary funding and has the freedom to establish and execute scopes of work in the national interest. It also manages and oversees earmarked funds, with each fund differing in its flexibility. The FHWA research program is organized and administered by the Office of Pavement Technology in cooperation with the Turner-Fairbank Highway Research Center and the Resource Center. Additional pavement work is done by the Office of Asset Management. FHWA has some flexibility in working with State DOTs and industry in establishing scopes of work. Technical proposals generally are developed by FHWA staff. Once the contract is underway, technical working groups can be assembled to provide guidance to FHWA. Currently, FHWA is guided broadly by the Concrete Pavement Technology Program (CPTP). It is expected that FHWA will replace elements of the CPTP with elements of the CP Road Map. FHWA also works with States to develop and implement studies under the Transportation Pooled Fund Program. These studies can accept private sector monies as well.

**American Association of State Highway and Transportation Officials (AASHTO).** Several AASHTO subcommittees and task forces are involved in concrete pavement technical issues, including the Joint Task Force on Pavements and the subcommittees on Materials, Construction, and Maintenance. FHWA normally acts in either a secretarial or liaison role for these groups. Industry may observe and comment on committee activities but has no formal role. From time to time, these committees develop long-range plans. For example, the Subcommittee on Construction prepares a research plan about every 10 years, The Joint Task Force on Pavements periodically holds strategic planning meetings.

**Transportation Research Board (TRB) Committee for Research on Improved Concrete Pavement for Federal-Aid Highways.** Until recently, this committee advised FHWA on planning and conducting the concrete pavement program outlined in the Transportation Equity Act for the 21st Century (TEA-21). The committee's functions were to (1) gather information from interested State and Federal government agencies, materials suppliers, the construction industry, and highway users; (2) develop recommendations for a research plan; and (3) provide continuing expert review and advice on conducting the program. This committee was recently disbanded, primarily because of funding shortfalls. It is not clear whether FHWA will reform or reconstitute this committee. The proposed executive advisory committee for the CP Road Map research management plan expands on the scope of work that this TRB committee performed during its tenure.

**National Cooperative Highway Research Program (NCHRP).** NCHRP is administered by TRB and sponsored by individual State DOTs. Support is voluntary and funds are drawn from the States' Federal-Aid Highway Program apportionment of State Planning and Research (SPR) funds. Furthermore, the funds can be spent only for administering problem statements approved

on ballot by at least two-thirds of the States, as represented by the AASHTO Standing Committee on Research. Concrete pavement research statements are introduced by a State(s), FHWA, an AASHTO committee, or a TRB committee. Industry solicits support from an individual State DOT, which in turn submits the statement. NCHRP does not manage programs. Assuming it administers a series of concrete pavement-related projects, however, NCHRP will be an important sustaining member.

**American Concrete Pavement Association (ACPA).** ACPA has a research committee that identifies and fosters support for specific research items related to the industry's agenda and its own long-range plan. State DOTs and FHWA are invited to observe and participate. Voting is restricted to members, although ACPA's work generally is by consensus. The association has been involved in many elements of the CP Road Map development. An association representative would be a welcomed participant on the CP Road Map's executive advisory committee.

**National Ready Mixed Concrete Association (NRMCA).** NRMCA's research program is managed under the Ready Mixed Concrete Research Foundation. Established in 1991, this foundation identifies research, issues requests for proposals, issues grants or contracts, and develops training packages. To date, little research has been done specifically for concrete pavements, but several tracks or subtracks in the CP Road Map may be of particular interest to NRMCA, especially in mix design, innovative equipment, and NDT/ICS. It is also hoped that NRMCA will participate in new laboratory testing and evaluation programs.

**Portland Cement Association (PCA).** PCA has a long history of conducting research, both with its wholly owned laboratory and through grants to other concrete-related associations or entities. This organization also may be interested in several subtracks in the CP Road Map, especially in the mix design track.

**National Stone, Sand, and Gravel Association (NSSGA).** NSSGA represents the crushed stone, sand, and gravel (aggregate) industries. Its membership accounts for 90 percent of the crushed stone and 70 percent of the sand and gravel produced annually in the United States. More than 3 billion tons of aggregate were produced in the United States in 2001 at a value of about \$14.5 billion. In 1992, NSSGA's funding arm (Aggregates Foundation for Technology, Research, and Education (AFTRE)) established the International Center for Aggregates Research (ICAR) at the University of Texas at Austin and Texas A&M University. ICAR is active on a wide range of aggregate research applications, including portland cement concrete, hot mix asphalt, and base courses. A cooperative research agreement between AFTRE and FHWA is now underway. This joint program, funded 75 percent by Federal money, sponsors aggregate research in multiple end-use applications.

**Midwest Concrete Consortium (MC<sup>2</sup>) and Southeast Concrete Alliance Network.** Regional organizations such as these provide very effective research coordination and technology transfer roles. These groups identify specific research of interest to their members, solicit pooled funds, and conduct the research. Many regional pooled funds also include funds from FHWA, industry, and others. These are excellent vehicles for using both public and private funds as one source of funding.



**Iowa State University’s Center for Portland Cement Concrete Pavement Technology (PCC Center).** In April 2000, the Iowa Board of Regents authorized formation of the PCC Center. It is a private, public, and university sector partnership that includes the Iowa Concrete Paving Association, Iowa DOT, Iowa State’s Department of Civil, Construction, and Environmental Engineering, and Iowa State’s Center for Transportation Research and Education. The PCC Center focuses research on critical needs of the PCC industry and delivers the best findings, methods, and processes to people who will use them.

Working with its advisory board and standing committees, the PCC Center seeks sustainable support within and outside of Iowa. The staff works with foundations and organizations to identify potential future partners and funding sources and to help develop an understanding of research, technology, and training priorities. Funding for specific projects comes from many sources, including Federal-aid pooled funds from around the country. The PCC Center is the lead in the Material and Construction Optimization for Prevention of Premature Pavement Distress in PCC Pavements project, an FHWA pooled fund project with 16 States and the private sector contributing funds.

**State DOTs.** Each State DOT is allotted Federal funds by formula for research (SPR funds). These funds traditionally have been used to conduct research for local needs. Many State DOTs have relationships with one or more State universities. DOTs may use these funds to participate in pooled fund studies.



## REFERENCES

1. *Bumpy Roads Ahead: Cities with the Roughest Rides and Strategies to Make our Roads Smoother*, The Road Information Program, Washington, DC, April 2004.
2. *Building for the Future—A Technology Program for Portland Cement Concrete Pavements*, FHWA, March 1999, as updated.
3. “Creating a New Generation of Pavements,” *Roads & Bridges*, April 2000.  
[www.roadbridges.com/rb/index.cfm/powergrid/rfah=%7Ccfap=/CFID/928902/CFTOKEN/69580450/fuseaction/showArticle/articleID/1651](http://www.roadbridges.com/rb/index.cfm/powergrid/rfah=%7Ccfap=/CFID/928902/CFTOKEN/69580450/fuseaction/showArticle/articleID/1651) *Summary of Identified Research Priorities*, Center for Portland Cement Concrete Pavement Technology Research Committee, 2001.
4. *Vision 2030: A Vision for the U.S. Concrete Industry*, U.S. Department of Energy, January 2001. [www.eere.energy.gov/industry/imf/pdfs/concrete\\_vision.pdf](http://www.eere.energy.gov/industry/imf/pdfs/concrete_vision.pdf).
5. *Nonconventional Concrete Technologies, Renewal of the Highway Infrastructure*, National Academies of Science Report NMAB–484, National Materials Advisory Board, Commission on Engineering and Technical Systems, National Research Council, Washington, DC, 1997.
6. *Infrastructure Renewal Research Agenda*, National Highway Research and Technology Partnership Forum, Infrastructure Renewal Working Group, February 1, 2001.  
[http://gulliver.trb.org/publications/rtforum/infrastructure\\_final.pdf](http://gulliver.trb.org/publications/rtforum/infrastructure_final.pdf).
7. Halin, P., *2002 Guide for Design of New and Rehabilitated Pavement Structures*, NCHRP Project 1–37A., February 2004. <http://www4.trb.org/trb/crp.nsf/All+Projects/NCHRP+1-37A>.
8. *Mechanistic-Empirical Pavement Design Guide*, NCHRP 1–37A, March 2004.
9. “Technical Advisory on Concrete Pavement Joints,” FHWA, T 5040.30, November 30, 1990. [www.fhwa.dot.gov/legsregs/directives/techadvs/504030a.htm](http://www.fhwa.dot.gov/legsregs/directives/techadvs/504030a.htm).

