

# Regional ITS Architecture Guidance

## Developing, Using, and Maintaining an ITS Architecture for Your Region

**Version 2.0**  
**July 2006**

**Revised and expanded  
with added focus on  
Use and Maintenance**

Remote  
Traveler  
Support

Personal  
Information  
Access

Info  
Se  
Pr

Wide Area Wireless Communications

Vehicle

Transit  
Vehicle

Commercial  
Vehicle

Emergency  
Vehicle

Vehicle to Vehicle Communications



U.S. Department of Transportation  
Federal Highway Administration  
Federal Transit Administration

**Notice**

This document is disseminated under the sponsorship of the Department of Transportation in the interest of information exchange. The United States Government assumes no liability for its contents or use thereof.

# Executive Summary

Rapid advances in information processing and communications technology have created new opportunities for transportation professionals to deliver safer and more efficient transportation services, and to respond proactively to increasing demand for transportation services in many areas and mounting customer expectations from coast to coast. However, many of these new opportunities are predicated upon effective coordination between organizations - at both an institutional and technical level. To encourage and enable this coordination, the USDOT has developed the National ITS Architecture and related tools to help identify and exploit these opportunities for cost-effective cooperation. This document is one such tool -- it describes how to develop a regional ITS architecture, which will be a cornerstone of planning for effective inter-agency coordination and for deployment and operation of technology-based projects.

In 1997, Congress passed the Transportation Equity Act for the 21<sup>st</sup> Century (TEA-21) to address the need to begin to work toward regionally integrated transportation systems. In January 2001, FHWA published a rule (ITS Architecture and Standards) and FTA published a companion policy to implement section 5206(e) of TEA-21. This Rule/Policy seeks to foster regional integration by requiring that all ITS projects funded from the Highway Trust Fund be in conformance with the National ITS Architecture and officially adopted standards. "Conformance with the National ITS Architecture" is defined in the final Rule/Policy as using the National ITS Architecture to develop a "regional ITS architecture" that would be tailored to address the local situation and ITS investment needs, and the subsequent adherence of ITS projects to the regional ITS architecture.

This ITS Architecture and Standards Rule/Policy continues under the current SAFETEA-LU federal transportation act. SAFETEA-LU emphasizes, among other things, congestion mitigation, real-time system management information systems, and planning and approaching transportation operations from a regional perspective. In Section 1201.c of the SAFETEA-LU legislation, State and local governments are required to address information needs and data exchange associated with highway and transit information and monitoring systems when developing or updating their regional ITS architectures. In addition, Section 6001 of SAFETEA-LU mandates that large metropolitan areas (population greater than 200,000) establish a congestion management process (CMP) that provides for effective management and operation of the transportation system within the region. The CMP is something that can be greatly enhanced by receiving archived ITS travel data, among other data points, generated by a deployed ITS network. During the stakeholder identification process, the ITS architecture should include this planning need for ITS data throughout the region. ITS architectures provide support in these areas as stakeholders analyze their implementation.

This document is a guide for transportation professionals who are involved in the development, use, or maintenance of regional ITS architectures. The document

describes a process for creating a regional ITS architecture with supporting examples of each architecture product. In its discussion of the uses of the regional ITS architecture, the document presents an approach for mainstreaming ITS into the transportation planning and project development processes.

The guidance is structured around the process shown in Figure ES-1. Within the document, section 2 provides an overview of the process and sections 3 through 6 describe the regional ITS architecture development process in detail. Regional ITS architecture use is discussed in section 7 and maintenance of the architecture is discussed in section 8.

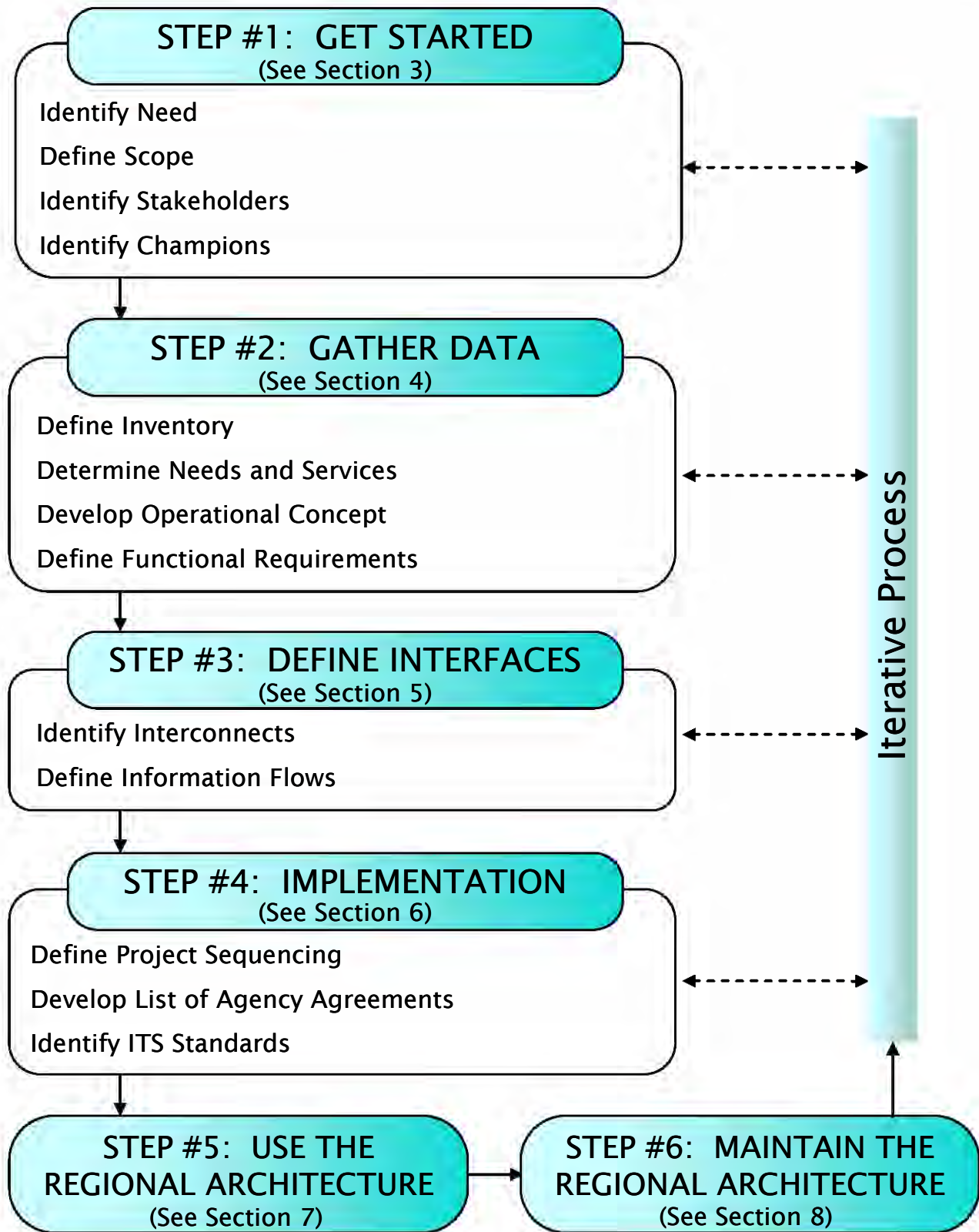

**Figure ES-1: Regional ITS Architecture Development, Use, and Maintenance**

The guidance covers each of the major steps shown in the figure:

**Get Started:** The regional ITS architecture effort begins with a focus on the institutions and people involved. Based on the scope of the region, the relevant stakeholders and one or more champions are identified, the team that will be involved in architecture development is organized, and the overall development effort is planned.

**Gather Data:** Once the stakeholders are involved and a plan is in place for assembling their input into a consensus regional ITS architecture, the focus shifts to the ITS systems in the region. At this step, the existing and planned ITS systems in the region are inventoried, the roles and responsibilities of each stakeholder in developing, operating, and maintaining these ITS systems are defined, the ITS services that should be provided in the region are identified, and the contribution (in terms of functionality) that each system will make to provide these ITS services is documented.

**Define Interfaces:** Once the ITS systems in the region are identified and functionally defined, the existing and planned interfaces between these systems are defined. First, the connections (or “Interconnects”) between systems are identified, and then the information that will be exchanged on each of the interfaces is defined.

**Implementation:** Once the system interfaces are defined, additional products can be defined that will guide implementation of the projects that will flow from the regional ITS architecture. These include a sequence of projects, a list of needed agency agreements, and a list of standards that can be considered for project implementation.

**Use the Regional ITS Architecture:** The real success of the regional ITS architecture effort hinges on effective use of the architecture once it is developed. The regional ITS architecture is an important tool for use in transportation planning, programming, and project implementation. It can identify opportunities for making ITS investments in a more cost-effective fashion. This step is where the benefits are realized.

The results of the transportation planning process - the plans and programs - are an important input to the development of a regional ITS architecture. Once a regional ITS architecture is created, it can be used by stakeholders in planning their ITS projects to support regional goals. It can be used to maximize appropriate integration of projects identified by the planning process. The relationship between the regional ITS architecture and transportation planning is on-going and iterative. The planning process and related outputs also refine the architecture over time as feedback is incorporated as part of architecture maintenance.

For the region’s Metropolitan Planning Organization (MPO) and for other area-wide and statewide planning agencies, the regional ITS architecture provides information for updating the Long Range Plan, the Transportation Improvement Program (TIP) and other capital plans. It will also provide information for use in other planning studies and activities, including the Congestion Management Plan, Corridor and Sub-Area Studies, performance-monitoring activities, transit development plans, and other locally defined



studies or plans. For statewide planning agencies, it will provide information for updating the Statewide TIP, the State Implementation Plan (SIP), and other statewide or multi-region plans and studies.

Once ITS projects are programmed, the regional ITS architecture provides a starting point for project development. It provides initial inputs to support concept of operations, requirements, and design of ITS projects. The regional ITS architecture improves continuity across the project lifecycle, from planning through project development and operations.

**Maintain the Regional ITS Architecture:** As ITS projects are implemented, new ITS priorities and strategies emerge through the transportation planning process, and the scope of ITS expands and evolves to incorporate new ideas, the regional ITS architecture will need to be updated. A maintenance plan is used to guide controlled updates to the regional ITS architecture baseline so that it continues to accurately reflect the region's existing ITS capabilities and future plans.

Two appendices provide additional background information that may be useful to some readers. Appendix A discusses the tools that may be useful in developing the regional ITS architecture, and Appendix B is a glossary of terminology used in this document.

# Table of Contents

<b>1</b>	<b>INTRODUCTION</b> .....	<b>1</b>
1.1	What is an ITS Architecture?.....	2
1.2	The Goal of a Regional ITS Architecture.....	4
1.3	Using a Regional ITS Architecture .....	5
1.4	USDOT Policy.....	7
1.5	How This Document is Organized.....	7
<b>2</b>	<b>DEVELOPING A REGIONAL ITS ARCHITECTURE</b> .....	<b>10</b>
<b>3</b>	<b>GET STARTED</b> .....	<b>14</b>
3.1	Identify Need.....	16
3.2	Define Scope .....	19
3.3	Identify Stakeholders .....	26
3.4	Identify Champion(s).....	33
<b>4</b>	<b>GATHER DATA</b> .....	<b>36</b>
4.1	Define Inventory.....	38
4.2	Determine Needs and Services.....	49
4.3	Develop Operational Concept .....	58
4.4	Define Functional Requirements .....	66
<b>5</b>	<b>DEFINE INTERFACES</b> .....	<b>73</b>
5.1	Identify Interconnects.....	75
5.2	Define Information Flows.....	84
<b>6</b>	<b>IMPLEMENTATION</b> .....	<b>93</b>
6.1	Project Sequencing.....	95
6.2	Develop List of Agency Agreements .....	109
6.3	Identify ITS Standards .....	116
<b>7</b>	<b>USING A REGIONAL ITS ARCHITECTURE</b> .....	<b>125</b>
7.1	Use for Transportation Planning.....	128
7.2	Use for Programming/Budgeting/Capital Planning.....	147
7.3	Use in Project Implementation.....	154
<b>8</b>	<b>MAINTAINING A REGIONAL ITS ARCHITECTURE</b> .....	<b>179</b>
8.1	Why a Regional ITS Architecture Needs to Be Maintained.....	181
8.2	Maintenance decisions .....	183
8.3	Maintenance Process .....	190
<b>A</b>	<b>REGIONAL ITS ARCHITECTURE TOOLS</b> .....	<b>204</b>
A.1	Hypertext View.....	205
A.2	Databases.....	207
A.3	Turbo Architecture .....	207
<b>B</b>	<b>ARCHITECTURE MAINTENANCE RESOURCES</b> .....	<b>212</b>
B.1	Sample Change Management Forms .....	212
B.2	Architecture Maintenance Plan Outline.....	214
B.3	Real-World Examples.....	215
<b>C</b>	<b>GLOSSARY</b> .....	<b>233</b>
<b>D</b>	<b>ACRONYMS</b> .....	<b>246</b>



## List of Figures

Figure 1: Regional ITS Architecture Development, Use, and Maintenance.....	11
Figure 2: Regional ITS Architecture scope for the Delaware Valley RPC .....	23
Figure 3: Adjacent/Overlapping Regions.....	24
Figure 4: Stakeholder Identification and Involvement Over Time .....	27
Figure 5: Grouping ITS Elements into General Inventory Elements.....	41
Figure 6: Florida DOT District 3 Inventory by Stakeholder Excerpt .....	45
Figure 7: Inventory Details for a Florida DOT District 3 ITS Element .....	46
Figure 8: Florida DOT District 3, Extended Subsystem Diagram .....	47
Figure 9: Example list of Regional Needs .....	54
Figure 10: ATMS Market Packages Identified to Support Needs .....	55
Figure 11: ITS Element Report with Market Package Instances .....	56
Figure 12: Roles and Responsibilities View in Turbo Architecture .....	64
Figure 13: Equipment Package Report showing Functional Requirements.....	70
Figure 14: Functional Areas Selection in Turbo Architecture .....	71
Figure 15: Functional Requirements Selection in Turbo Architecture .....	71
Figure 16: Turbo Architecture Functional Requirements Report (partial) .....	72
Figure 17: Greater Yellowstone Rural ITS Architecture Interconnect Diagram .....	80
Figure 18: Albuquerque Regional ITS Architecture Interconnect Diagram.....	81
Figure 19: DVRPC Regional ITS Architecture Flow Diagram.....	89
Figure 20: Example of an Information flow Diagram Interface Specification .....	90
Figure 21: Information Flows in a Market Package Instance Diagram .....	92
Figure 22: Georgia Statewide Architecture Project Sequencing Report.....	101
Figure 23: Market Package Instance for Project 3 .....	105
Figure 24: Regional Standards Plan Content .....	120
Figure 25: Candidate ITS Standards Excerpt for <i>road network condition</i> .....	122
Figure 26: Vermont ITS Standards Plan Excerpt .....	123
Figure 27. Project Plans Excerpt for Eugene-Springfield .....	124
Figure 28: Using the Regional Architecture.....	127
Figure 29: ITS Architecture and the Transportation Planning Process.....	129
Figure 30: San Diego Long Range Plan Excerpt – IMTMS .....	136
Figure 31: Enhancing Regional ITS Architecture Use over Time .....	139
Figure 32: ITS Architecture and ITS Strategic Plans .....	140
Figure 33: Other Planning Activities .....	142
Figure 34: Congestion Management Process .....	143
Figure 35: Safety Planning and the ITS Architecture .....	145
Figure 36: ITS Project Programming/Budgeting/Capital Planning.....	147

Figure 37: Metropolitan Transportation Commission ITS Projects Designation .....	149
Figure 38: AMATS Project Sponsor Checklist.....	149
Figure 39: Rhode Island State Planning Commission ITS Project Scoring .....	149
Figure 40: NYSDOT Project Programming Process.....	152
Figure 41: Using the ITS Architecture in Project Implementation .....	155
Figure 42: Architecture and Location-Specific Projects .....	160
Figure 43: Systems Engineering Approach .....	162
Figure 44: Systems Engineering and Traditional Project Development .....	164
Figure 45: Rule/Policy Systems Engineering Analysis Requirements .....	165
Figure 46: Using the Architecture to Support Systems Engineering.....	166
Figure 47: Example Maine DMS Project Architecture Subset .....	169
Figure 48: Architecture Use for Concept of Operations.....	170
Figure 49: DMS Project Example Diagram.....	172
Figure 50: Architecture Use in System Requirements Development.....	173
Figure 51: Project System Requirements Analysis .....	173
Figure 52: Architecture Use in Project Design.....	174
Figure 53: Example DMS Project Architectural Design .....	175
Figure 54: Providing Feedback to the Regional ITS Architecture .....	177
Figure 55: VDOT Project Architecture Submittal Form.....	178
Figure 56. Process for Change Identification .....	195
Figure 57. Sample Configuration Identification Document .....	200
Figure 58: Index Page of the National ITS Architecture Hypertext View .....	205
Figure 59: Diagram of Entry Points to the National ITS Architecture.....	206
Figure 60: Representative Market Package Graphic.....	206
Figure 61: Turbo Architecture Customize Tab.....	209
Figure 62: Sample Architecture Flow Diagram.....	210
Figure 63: Sample Turbo Architecture Report.....	211

## List of Tables

Table 1: Candidate Stakeholders .....	29
Table 2: Franklin, TN TOC Stakeholders .....	31
Table 3: Regional ITS Architecture Champions .....	35
Table 4: Vermont Statewide ITS Architecture Roles and Responsibilities.....	63
Table 5: Roles and Responsibilities Output from Turbo Architecture .....	64
Table 6: Minnesota Statewide Architecture Metro TMC Interconnects.....	82
Table 7: Minnesota Statewide Architecture Information Flows (Draft).....	91
Table 8: Eugene-Springfield ITS Plan Proposed Projects (excerpts) .....	104
Table 9: SJTPO (MPO) Project Definition and Sequencing (excerpt) .....	105
Table 10: Chittenden County MPO Recommended ITS Projects .....	106
Table 11: Chittenden County MPO ITS Project Description .....	107
Table 12: Types of Agreements .....	111
Table 13: Southeast Nebraska Regional ITS Architecture Agreements .....	114
Table 14: Franklin TOC Relevant Standards Excerpt.....	121
Table 15: DMS Project Functional Requirements (Partial List) .....	174
Table 16: DMS Project ITS Standards .....	175
Table 17. Examples of Configuration Items to Consider .....	194
Table 18: National ITS Architecture Databases .....	207
Table 19: Sample Change Request Form .....	213
Table 20. Sample Change Log Entry .....	214

## Section

## 1

# Introduction

Intelligent Transportation Systems have been defined as: “the application of advanced sensor, computer, electronics, and communication technologies and management strategies—in an integrated manner—to improve the safety and efficiency of the surface transportation system”. This definition encompasses a broad array of systems and information processing and communications technologies. In order to fully incorporate ITS into the surface transportation network, ITS must be “mainstreamed” into the overall transportation planning and project development processes that exist in each state and metropolitan region of the country.

In 1997, Congress passed the Transportation Equity Act for the 21<sup>st</sup> Century (TEA-21) to address the need to begin to work toward regionally integrated transportation systems. In January 2001, FHWA published FHWA Rule 940 (23 CFR Part 940), and FTA published a companion policy, to implement section 5206(e) of TEA-21. This Rule/Policy seeks to foster regional integration by requiring that all ITS projects funded from the Highway Trust Fund be in conformance with the National ITS Architecture and officially adopted standards. “Conformance with the National ITS Architecture” is defined in the final Rule/Policy as using the National ITS Architecture to develop a “regional ITS architecture” that would be tailored to address the local situation and ITS investment needs, and the subsequent adherence of ITS projects to the regional ITS architecture. The Rule/Policy remains in effect with the most recent SAFETEA-LU surface transportation authorization act and includes new provisions and considerations. Section 1201.c of the SAFETEA-LU legislation requires State and local governments to address information needs and data exchange associated with highway and transit information and monitoring systems when developing or updating their regional ITS architectures. Section 6001 of SAFETEA-LU mandates that large metropolitan areas (population greater than 200,000) establish a congestion management process (CMP). This process needs to provide for effective management and operation of the transportation system within the region. The CMP is something that can be greatly enhanced by receiving archived ITS travel data, among other data points, generated by a deployed ITS network. During the stakeholder identification process, the ITS architecture should include this planning need for ITS data throughout the region. ITS architectures provide support in these areas as stakeholders analyze their implementation.

The objective of this document is to provide guidance on the development, use, and maintenance of regional ITS architectures. The document presents a process for creating a regional ITS architecture and provides sample

outputs of each aspect of the regional ITS architecture. In its discussion of the uses of the regional ITS architecture the document presents an approach for mainstreaming ITS into the planning and project development processes. Although this document focuses on regional ITS architecture it recognizes that the real value of this architecture is as a tool to support the planning and project development processes.

Transportation planning is an ongoing, iterative process, whose goal is making quality, informed decisions pertaining to the investment of public funds for regional transportation systems and services. A regional ITS architecture (created with the use of the planning information already developed) can be a powerful tool for planning the regional integration of transportation systems. Indeed the very process of creating a regional ITS architecture can enhance regional planning by bringing together a diverse array of agencies and stakeholders to discuss future transportation needs and how these needs might be met by ITS.

This document is intended for anyone who is involved, or will be involved in the development, use or maintenance of regional ITS architectures. Because of the detailed nature of the discussion of the architecture development process and architecture outputs, the document is most applicable for those transportation professionals who will lead or play a key role in the development or use of a regional ITS architecture.

Although this document provides guidance on the entire process, those that have already accomplished many of the process steps, including those that already have completed a regional ITS architecture, may also find the document to be useful. Stakeholders who are coming in at a later step will find a wealth of best practices information and examples from around the country that may influence their on-going regional ITS architecture-related activities.

Is knowledge of architecture in general or the National ITS Architecture in specific required to read and use this document? Not if the reader wishes to gain a general understanding of the process of developing and using a regional ITS Architecture. But to understand the details of the process of developing an architecture, and to actually develop a regional ITS architecture using the process, the reader should have some baseline knowledge of the National ITS Architecture.

## 1.1 What is an ITS Architecture?

An **architecture** defines a framework within which a system can be built. It functionally defines what the elements of the system do and the information that is exchanged between them. An architecture is important because it allows integration options to be considered prior to investment in the design and development of the elements of the system. An architecture is

functionally oriented and not technology specific, which allows the architecture to remain effective over time. It defines “what” must be done, not “how” it will be done. The functions the system performs remain the same while technology evolves.

Intelligent Transportation Systems (ITS) are interrelated systems that work together to deliver transportation services. Integration of these systems requires an architecture to illustrate and gain consensus on the approach to be taken by a group of stakeholders regarding their particular systems. An **ITS Architecture** defines the systems and the interconnections and information exchanges between these systems.

The primary components of an ITS Architecture are Subsystems and Information Flows:

- **Subsystems** are individual pieces of the overall Intelligent Transportation **System** that perform particular functions such as managing traffic, providing traveler information, or responding to emergencies. Subsystems can be associated with particular organizations such as departments of transportation, information service providers, or public safety agencies. They are sources and/or users of information provided by other subsystems within or on the boundary of the ITS Architecture. Subsystems include center systems, field components, vehicle equipment, and traveler devices that participate in ITS.
- **Information flows** define information that is exchanged between subsystems such as traffic information, incident information, or surveillance and sensor control data. They depict ITS integration by illustrating the information links between subsystems. In ITS, this integration is not only technical but institutional as well. The system interfaces that are defined require cooperation and shared responsibilities on the part of the owners and operators of each participating system.

Two different types of ITS Architectures are discussed in this document:

- **National ITS Architecture:** The National ITS Architecture is a general framework for planning, defining, and integrating ITS. It was developed to support ITS implementations over a 20-year time period in urban, interurban, and rural environments across the country. The National ITS Architecture is available as a resource for any region and is maintained by the USDOT independently of any specific system design or region in the nation.



- **Regional ITS Architecture:** A regional ITS architecture is a specific regional framework for ensuring institutional agreement and technical integration for the implementation of ITS projects in a particular region.

This document describes a process for defining a regional ITS architecture using the National ITS Architecture as a resource. There are numerous advantages to using the National ITS Architecture as the basis for creating a regional ITS Architecture. Primary among these is a significant savings of time and cost because the National ITS Architecture represents a very complete framework of ITS services, has already undergone considerable stakeholder review, and has a variety of tools to assist the user in creating a regional ITS architecture. These tools will be further discussed in later sections of this document.

A thorough understanding of the terms and concepts of the National ITS Architecture is important to key stakeholders who are involved in the creation of a regional ITS architecture using the process described in this document. In providing guidance on this process, the document makes liberal use of these terms and concepts, so this knowledge is required for the reader to fully understand the guidance provided.

For those readers who are unfamiliar with the National ITS Architecture, all the terms that are used in this document are defined in Appendix B. This is probably sufficient for the reader who wishes to gain a general understanding of the process of developing and using a regional ITS Architecture. To understand the details of the process of developing a regional ITS architecture, and to actually develop a regional ITS architecture using the process, the reader should have some introductory training in the National ITS Architecture. Additional information on the National ITS Architecture as well as information on available training can be found at the FHWA's ITS Joint Program Office website: <http://www.its.dot.gov/arch/index.htm>.



## 1.2 The Goal of a Regional ITS Architecture

State and local governments and transportation organizations apply transportation tools to address transportation issues on a regional basis. Each region has unique needs and is affected, in some manner, by neighboring regions. ITS is one of these transportation tools. It harnesses the valuable information generated by various subsystems within and around a region to better manage and operate the transportation system as a whole.

The purpose of developing a regional ITS architecture is to illustrate and document regional integration so that planning and deployment can take place in an organized and coordinated fashion. Typically, a region contains multiple transportation agencies and jurisdictions. These may have both



adjoining and overlapping geographies, but the common thread for all of the agencies is the need to provide ITS solutions to transportation problems such as traffic congestion and safety hazards. It is important that these solutions be provided economically, utilizing public funds in a responsible manner.

Regional integration allows for the sharing of information and coordination of activities among regional transportation systems to efficiently and effectively operate. Regional integration may also have a synergistic effect on transportation systems (e.g. information from one system may be used by another system for a different purpose. An example of this would be transit AVL data being used by a freeway management center as probe data to obtain speed information on freeway segments traveled by the transit vehicles.) A regional ITS architecture illustrates this integration and provides the basis for planning the evolution of existing systems and the definition of future systems that facilitate the integration over time.

For the private sector, opportunities exist to develop information systems providing value-added services to the traveling public. Participating in the development of a regional ITS architecture can highlight needs for data integration between public and private partners. It can also identify ways in which public sector agencies can benefit from information that the private sector has.

This regional integration can only take place with the participation and cooperation of the organizations within a region. These stakeholders must work together to establish a regional ITS architecture that reflects a consensus view of the parties involved. A regional ITS architecture's most important goal is institutional integration; providing a framework within which regional stakeholders can address transportation issues together.

## **1.3 Using a Regional ITS Architecture**

A regional ITS architecture is a useful tool for planning and implementing ITS within a region. From a planning perspective, the regional ITS architecture defines the ITS that the regional stakeholders wish to realize over a given timeframe. This plan for ITS in the region will be realized in an incremental fashion as funding and/or technology is available and institutional issues are resolved. ITS projects are defined to achieve the regional plan, using the regional ITS architecture to properly and efficiently define projects so that they build upon one another.

A regional ITS architecture can identify opportunities for making ITS investments in a more cost-effective fashion, by utilizing inter-agency cooperation during planning, implementation, and operation of these ITS projects.

## **Where does the Regional ITS Architecture fit within Transportation Planning?**

Transportation planning is an ongoing, iterative activity. The results of the transportation planning process – the plans and programs – are an important input to the development of a regional ITS architecture. Once a regional ITS architecture is created, it can assist stakeholders in planning their ITS projects to support regional goals. It is a tool for use in the planning process to maximize appropriate integration of projects identified by the planning process. The planning process and related outputs also help refine the architecture over time by providing feedback that is incorporated as part of architecture maintenance. Ideally, the transportation planning process improves the architecture at the same time that the architecture informs and improves the transportation planning process.

Due to the regional and local variations in the practice of transportation planning, local stakeholders must decide how best to incorporate the regional ITS architecture and the products produced during its development into the Transportation Planning Process, and vice versa.

For the region's Metropolitan Planning Organization (MPO) and for other area-wide and statewide planning agencies and authorities, the regional ITS architecture will provide information for updating the Long Range Plan, the Transportation Improvement Program (TIP) and other capital plans. It will also provide information for use in other planning studies and activities, including the Congestion Management Plan, Corridor and Sub-Area Studies, performance-monitoring activities, transit development plans, and other locally defined studies or plans. For statewide planning agencies, it will provide information for updating the Statewide TIP, the State Implementation Plan (SIP), and other statewide or multi-region plans and studies.

Once ITS projects are programmed, the regional ITS architecture provides a starting point for project development. It provides initial inputs to support the systems engineering process including the establishment of the concept of operations, requirements, and high-level design and test planning of ITS projects. The regional ITS architecture improves continuity across the project lifecycle, from planning through project development and operations.

The regional ITS architecture can also be useful to private companies contemplating ITS investments, by helping them understand long-range and short-range ITS planning goals of the local public sector agencies, plus the technical and institutional context in which any private investments would be made.

In Transportation Planning, a regional ITS architecture has its greatest impact on institutional integration. It provides a structure around which discussions can take place among regional stakeholders to gain consensus on the

direction of ITS. It implies roles and responsibilities for each stakeholder involved to realize the benefits of ITS within the region.

## 1.4 USDOT Policy



On January 8, 2001, the US Department of Transportation published the FHWA Final Rule and FTA Policy, which implement section 5206(e) of the Transportation Equity Act for the 21<sup>st</sup> Century (TEA-21). The Final Rule/Policy, effective April 8, 2001, explains and defines how Section 5206(e) is to be implemented. TEA-21 required ITS projects funded through the highway trust fund to conform to the National ITS Architecture and applicable standards. The intention of the Rule/Policy is to foster the deployment of integrated regional ITS systems.

Because it is highly unlikely that the entire National ITS Architecture would be fully implemented by any single metropolitan area or State, the Rule/Policy requires that the National ITS Architecture be used to develop a local implementation or “regional ITS architecture” that would be tailored to address the local situation and ITS investment needs. The region is defined by local participants and is based on the needs for information sharing and coordination. It can be a metropolitan area, a state, a multi-state area, or a corridor.

The Rule/Policy requires that if a region is already deploying ITS projects, then a regional ITS architecture must be developed within four years of the effective date of the Rule/Policy (by April 8, 2005). If a region has not yet deployed an ITS project then a regional ITS architecture must be developed within four years of the deployment of the initial ITS project in the region. The intention of the new Rule/Policy is to foster integration of the deployment of regional ITS systems.

This guide makes frequent reference to the Rule/Policy requirements for regional ITS architectures, describing how the specific process steps and products relate to the Rule/Policy. In addition to the regional ITS architecture requirements, the Rule/Policy also includes requirements for ITS Project Implementation and Project Administration, which are not addressed in detail by this document.



Further information on the Intelligent Transportation System Architecture and Standards Policy/Rule can be found at [http://www.ops.fhwa.dot.gov/its\\_arch\\_imp/policy.htm](http://www.ops.fhwa.dot.gov/its_arch_imp/policy.htm).

## 1.5 How This Document is Organized

Section 2 of the document identifies a candidate regional ITS architecture development process. Sections 3 through 6 elaborate on steps within the

overall process and identify examples of the products of the process. Section 7 discusses regional ITS architecture use and section 8 addresses maintenance of a regional ITS architecture.

### About the Examples

The examples that are used throughout the document were drawn from actual regional ITS architectures that have been developed for small, medium, and large metropolitan areas and rural regions around the country. In a few cases, examples were created to illustrate a process step or output when a real example was not available. A few of the real world examples were created prior to publication of the Rule/Policy on Architecture and Standards, but the examples that are included meet the intent of the guidance.

### About the Icons

This document uses icons to highlight different kinds of information. The icons can help you find particular types of information within the document.



This icon identifies suggestions that may improve the regional ITS architecture development effort or the quality of the products that are generated. Usually based on actual experience, these are ideas that have worked in the past.



This icon flags warnings. In contrast to tips, these are problems that have been encountered that you should avoid. Also frequently based on actual experience, these are ideas that have NOT worked in the past.



This icon signals ITS resources that offer additional information related to regional ITS architectures. Normally, a specific web site address and/or an Electronic Document Library number are provided for these resources. If you don't find the resources you need here, the "ITS Resource Guide" is an excellent general source of information. It is available on-line at <http://www.its.dot.gov/guide.htm>.



This icon highlights references to the FHWA Final Rule and FTA Policy on ITS Architecture and Standards. These are normally specific references to paragraphs that are most relevant to the particular process step or product. Additional information on the Rule/Policy is available at: [http://www.ops.fhwa.dot.gov/its\\_arch\\_imp/policy.htm](http://www.ops.fhwa.dot.gov/its_arch_imp/policy.htm).



This icon identifies information about the National ITS Architecture. Specific information is provided on different parts of the National ITS Architecture and how they apply to particular regional ITS architecture development steps. Visit [http://www.its.dot.gov/arch/arch\\_howto.htm](http://www.its.dot.gov/arch/arch_howto.htm) for information on how to order a CD-ROM and a variety of other links and current National ITS Architecture news and information. An on-line version of the Architecture is available at <http://www.its.dot.gov/arch/index.htm>. Several training courses

on the National ITS Architecture are available from the National Highway Institute. See <http://www.nhi.fhwa.dot.gov/> for more information.



This icon is used to flag security-related information in the document. Security is an important factor to consider throughout the regional ITS architecture development. Identified passages explain where security may impact steps in the regional ITS architecture development process.



This icon is associated with specific information on the Turbo Architecture software tool. Normally, the passage explains how Turbo Architecture can be used to support a particular step in the regional ITS architecture development process.

Turbo Architecture is an interactive software program that allows transportation professionals to use the information defined in the National ITS Architecture to create a regional or project architecture that reflects the transportation needs of the region. Additional information about Turbo Architecture, including information on how to obtain a copy, is contained in Appendix A. A Turbo Architecture training course is offered through the National Highway Institute. See <http://www.nhi.fhwa.dot.gov/> for more information.

## Section

## 2

# Developing a Regional ITS Architecture

This section provides an overview of a representative regional ITS architecture development process. In subsequent sections, each step in the process is described in more detail, defining the major activities, identifying the important inputs and outputs, and providing tips, resources, and cautionary advice that reflect lessons that have been learned in development of many regional ITS architectures over the past several years.

Development of a regional ITS architecture actually occurs in the context of broader regional planning, programming, and project development processes. The relationship between the regional ITS architecture development process described in this section and the regional planning and programming processes is described in detail in sections 1.1 and 7.2. The relationship between the regional ITS architecture and the project implementation process is described in section 7.3.



Many different processes can be used to develop a regional ITS architecture. The objective of this section is NOT to define a single process that should be universally adopted. If you have a process that works, and it generates all the products that are required by the final rule/policy, then feel free to continue to use your process. If you don't have an existing process, then the process described in this section can be a good starting point for tailoring a regional ITS architecture development process that best meets your needs.

Figure 1 shows six general steps in the “lifecycle” of a regional ITS architecture. In the first four steps, the regional ITS architecture products are developed and then these products are used and maintained in steps 5 and 6. The development process begins with basic scope definition and team building and moves through increasingly detailed steps, culminating in specific products that will guide the “implementation” of the regional ITS architecture. An overview of each step in the process follows:

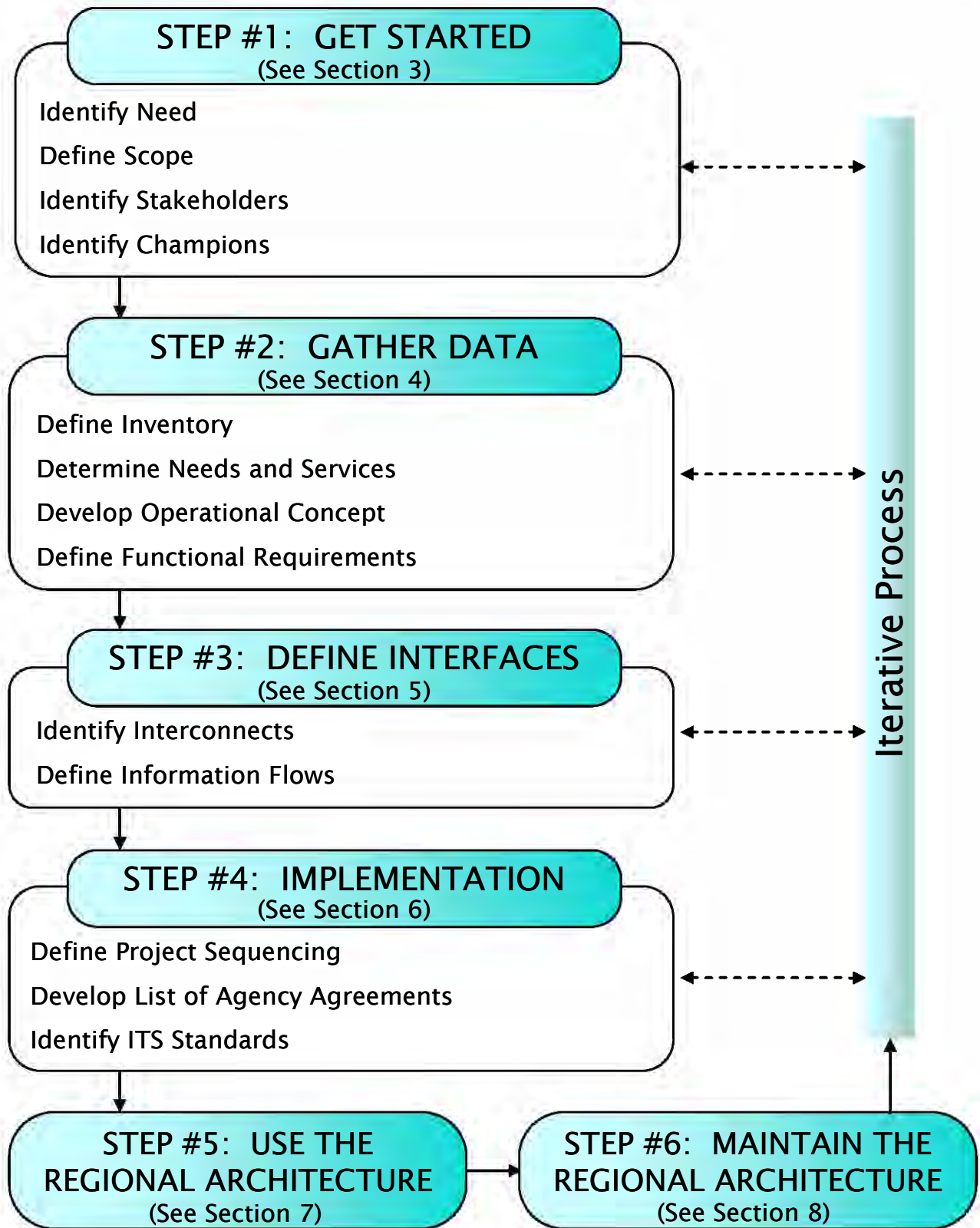

Figure 1: Regional ITS Architecture Development, Use, and Maintenance



**Get Started:** The regional ITS architecture effort begins with a focus on the institutions and people involved. Based on the scope of the region, the relevant stakeholders are identified, one or more champions are identified, the team that will be involved in architecture development is organized, and the overall development effort is planned. This step defines “who” will be involved with (and served by) the architecture and how the regional ITS architecture development will be structured.



Although a regional ITS architecture development effort is much smaller than a major construction project in terms of financial expenditure, an architecture development effort is institutionally complex because it is so inclusive. Architecture development planning, particularly for outreach and consensus building, is an important factor in a successful regional ITS architecture development. Allow sufficient time for this outreach and consensus building when planning the overall effort.

**Gather Data:** Once the stakeholders are involved and a plan is in place for assembling their input into a consensus regional ITS architecture, the focus shifts to the ITS systems in the region. At this step, the existing and planned ITS systems in the region are inventoried, the roles and responsibilities of each stakeholder in developing, operating, and maintaining these ITS systems are defined, the ITS services that should be provided in the region are identified, and the contribution (in terms of functionality) that each system will make to provide these ITS services is documented.

**Define Interfaces:** Once the ITS systems in the region are identified and functionally defined, the existing and planned interfaces between these systems are defined. First, the connections (or “Interconnects”) between systems are identified, and then the information that will be exchanged on each of the interfaces is defined.

**Implementation:** Once the system interfaces are defined, additional products can be defined that will guide implementation of the projects that will flow from the regional ITS architecture. These include a sequence of projects, a list of needed agency agreements, and a list of standards that can be considered for project implementation.

**Use the Regional ITS Architecture:** The real success of the regional ITS architecture effort hinges on effective use of the architecture once it is developed. The regional ITS architecture is an important tool for use in transportation planning and project implementation. It can identify opportunities for making ITS investments in a more cost-effective fashion. This step is where the benefits are realized.

**Maintain the Regional ITS Architecture:** As ITS projects are implemented, the region’s needs evolve, and new services are added to the National ITS

Architecture that weren't originally considered, the regional ITS architecture will need to be updated. A maintenance plan is used to guide controlled updates to the regional ITS architecture baseline so that it continues to accurately reflect the region's existing ITS capabilities and future plans.

While this may look like a sequential process where each step is completed before beginning the next, the actual development process is normally iterative and tasks will frequently be performed in parallel. For example, in step #1, the scope of the region may be adjusted as new stakeholders are identified and they begin to suggest changes to the regional boundary. Similarly, new stakeholders are frequently identified as the inventory for the region is defined, causing iteration between step #2 and step #1. It is also common for changes to the inventory to be made as interfaces are defined, causing iteration between steps #3 and #2. This "two steps forward and one step back" progression is a normal part of the process.



### **Security Considerations**

The regional ITS architecture development effort provides an important opportunity to address security early in the planning process. Experience shows that security can be a stumbling block in systems integration if it isn't considered early in the process. The regional ITS architecture should address security so that the integration opportunities that are identified do not adversely impact the mission-readiness of the regional transportation system. The regional ITS architecture provides a natural starting point for a top-level security policy and strategy for a secure regional transportation system.



Version 5.0 of the National ITS Architecture added focus on security and included a Security Document that provides background information, a list of resources, and specific guidance for addressing security in a regional ITS architecture. This document is available at:

<http://www.iteris.com/itsarch/documents/zipped/security.zip>.

# Section 3

## Get Started

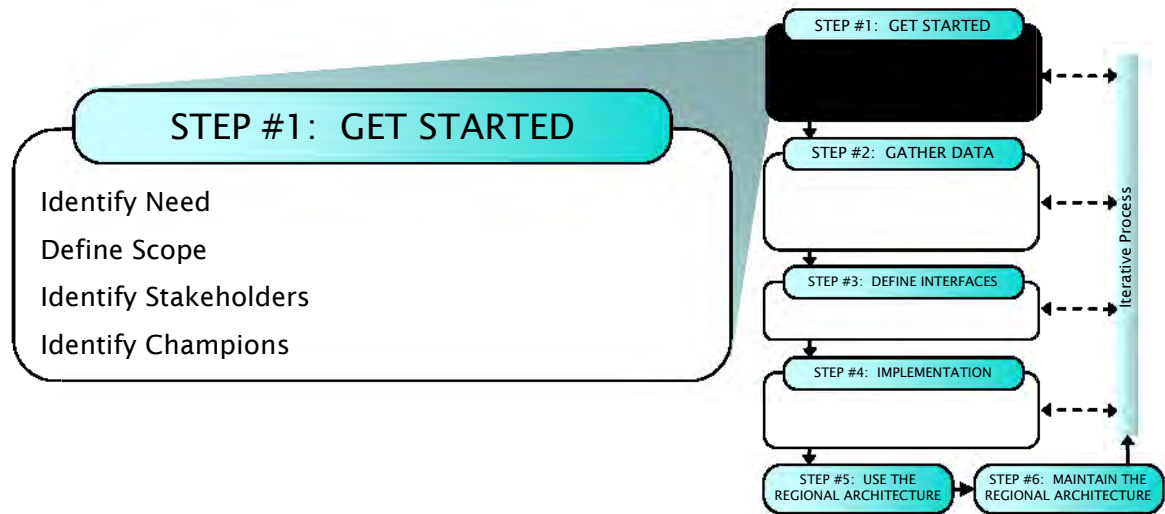

This section describes the first step in the regional ITS architecture development process – “Get Started”.

The regional ITS architecture effort begins with a focus on the institutions and people involved. Based on the scope of the region, the relevant stakeholders are identified and a plan to engage them is developed, one or more champions are identified, the team that will be involved in architecture development is organized, and the overall development effort is planned with particular focus on outreach and consensus building.

In this section, the four “Get Started” process tasks are described in more detail. Each task description begins with a one page summary that is followed by additional detail on the process, relevant resources and tools, a general description of the associated outputs, and example outputs where they are available. Each task description also includes tips and cautionary advice that reflect lessons that have been learned in development of regional ITS architectures over the past several years.

**STEP #1: GET STARTED - Identify Need**

<p><i>These tasks may be performed in parallel.</i></p>	<ul style="list-style-type: none"> <li>● <b>Identify Need</b></li> <li>● Define Scope</li> <li>● Identify Stakeholders</li> <li>● Identify Champion(s)</li> </ul>
<p><b>OBJECTIVES</b></p>	<ul style="list-style-type: none"> <li>● Assess need for regional ITS architecture</li> <li>● Define regional ITS architecture boundaries</li> </ul>
<p><b>PROCESS</b> <i>Key Activities</i></p>	<p><u>Assess Need and Ability</u></p> <ul style="list-style-type: none"> <li>● Determine if ITS technologies are being implemented.</li> <li>● Determine if ITS projects are planned for the region.</li> <li>● Evaluate system integration opportunities in the region</li> <li>● If a regional ITS architecture is needed, assess in-house skills and determine if additional assistance is required.</li> <li>● Build awareness in the region of the benefits of a regional ITS architecture through outreach and education and garner support for its development.</li> </ul> <p><u>Build Consensus</u></p> <ul style="list-style-type: none"> <li>● Build consensus in the region on the decision to develop a regional ITS architecture</li> <li>● Emphasize the benefits, rather than the rule/policy requirements</li> </ul>
<p><b>INPUT</b> <i>Sources of Information</i></p>	<ul style="list-style-type: none"> <li>● Transportation Improvement Program (TIP)</li> <li>● The Long Range Transportation Plan (“<i>the Plan</i>”)</li> <li>● ITS Strategic Plans and other ITS Plans</li> <li>● ITS Outreach and Educational Resources</li> </ul>
<p><b>OUTPUT</b> <i>Results from Process</i></p>	<ul style="list-style-type: none"> <li>● Decision to initiate a regional ITS architecture development effort.</li> </ul>

## 3.1 Identify Need

In this step, the decision to develop a regional ITS architecture is made. Through this decision process, the development and maintenance of a regional ITS architecture is established as a shared objective by the transportation planning and operating agencies in the region.



Requirements for developing a regional ITS architecture are identified by FHWA Rule 940.9 and FTA National ITS Architecture Policy Section 5.

### 3.1.1 Process

A regional ITS architecture is required by the FHWA Rule/FTA Policy for regions that have deployed, or will be deploying, ITS projects. An examination of the deployed ITS systems, the plans for future ITS deployments, and system integration opportunities in the region will establish if the rule/policy applies and a regional ITS architecture is required. While the rule/policy establishes a clear “requirement” for a regional ITS architecture for many regions, the real “need” for a regional ITS architecture is based more on its utility in ITS project planning and implementation.

The most important reason to develop a regional ITS architecture is that it can help the region to efficiently plan for and implement more effective ITS systems. Thus, the ultimate objective is not to develop a regional ITS architecture that complies with a federal rule or policy, but to develop a regional ITS architecture that can really be used by the region to guide ITS implementation. A regional ITS architecture that includes all the products specified by the rule/policy but is never used by the region is not of real benefit to the region or US DOT. To meet the requirements of the rule/policy, the regional ITS architecture must be used to measure conformance of ITS projects on an on-going basis and be maintained as regional ITS requirements evolve.

The decision to proceed then should actually be based on a clear understanding and commitment by planning agencies, operating agencies, and key decision makers in the region that a regional ITS architecture is needed and will be put to good use. This implies that a decision to proceed should be accompanied by significant outreach and education on the benefits of ITS and system integration and the important role that a regional ITS architecture can play in developing these integrated systems.

### 3.1.2 Resources and Tools



There are many good resources available that can support the outreach and education effort that may be required to realize the benefits of a regional ITS architecture. USDOT has published an “ITS Resource Guide” that lists over

300 documents, web sites, training courses, software tools, and points of contact covering all aspects of ITS, including the National ITS Architecture and regional ITS architectures. An online version of this guide is available at <http://www.its.dot.gov/guide.htm>.

## STEP #1: GET STARTED – Define Scope

<i>These tasks may be performed in parallel.</i>	<ul style="list-style-type: none"> <li>• Identify Need</li> <li>• <b>Define Scope</b></li> <li>• Identify Stakeholders</li> <li>• Identify Champion(s)</li> </ul>
<b>OBJECTIVES</b>	<ul style="list-style-type: none"> <li>• Define the general scope of the regional ITS architecture.</li> </ul>
<b>PROCESS</b> <i>Key Activities</i>	<p><u>Define the Regional ITS Architecture Scope</u></p> <ul style="list-style-type: none"> <li>• Review geographic boundaries of key stakeholders, major ITS projects and special “air quality conformity” issues. Consider the Metropolitan Planning Area boundary in metropolitan areas.</li> <li>• Provide boundary information to the stakeholders for consideration</li> <li>• Collect information on surrounding regional ITS architectures and consider how this regional ITS architecture will fit with others in the area.</li> <li>• Define a timeframe for what will be included in the regional ITS architecture (<i>e.g., five, ten, or twenty year planning horizon</i>).</li> <li>• Determine the basic scope of the services that will be covered. For example, determine if the regional ITS architecture should define commercial vehicle related services.</li> <li>• Include security objective(s) in scope if desired by stakeholders</li> </ul> <p><u>Build Consensus</u></p> <ul style="list-style-type: none"> <li>• Actively solicit feedback on preliminary regional ITS architecture boundary, timeframe, and service scope decisions.</li> <li>• Agree on preliminary scope in order to begin the process. <i>Remember, the scope can be refined as you proceed.</i></li> </ul>
<b>INPUT</b> <i>Sources of Information</i>	<ul style="list-style-type: none"> <li>• Geographic boundaries for key regional transportation projects and/or services that utilize ITS.</li> <li>• Stakeholder(s) agency “operational or service area” boundaries.</li> <li>• Transportation Improvement Program (TIP)</li> <li>• The Long Range Transportation Plan (“<i>the Plan</i>”)</li> <li>• Geographic boundaries of surrounding Regional Architectures.</li> <li>• Scope of overlapping regional ITS architectures</li> </ul>
<b>OUTPUT</b> <i>Results from Process</i>	<ul style="list-style-type: none"> <li>• A description of the region including geographic boundaries, timeframe, and service scope.</li> </ul>



## 3.2 Define Scope

The process of developing a regional ITS architecture begins with a definition of the region. The fundamental scope for the regional ITS architecture is established with the definition produced in this step.

### 3.2.1 Process

The general scope of a regional ITS architecture can be defined in three ways:

- 1) **Geographic Area:** Define the geographic area covered by the architecture. What cities, counties, states, corridors, or other special areas does it include?
- 2) **Timeframe:** Define the planning timeframe that the regional ITS architecture will address. Should the architecture encompass systems and services that are implemented over the next five, ten, or twenty years?
- 3) **Service Scope:** Specify the general categories of services that are included. For example, should the architecture cover commercial vehicle services?



Tips

Don't invest too much time trying to define the region perfectly the first time. Remember that developing a regional ITS architecture is an iterative process, and the definition of the region can be adjusted as the regional ITS architecture begins to take shape. The stakeholders should make a first cut at defining the region and then update the geographic area, timeframe, and service scope as new stakeholders are identified, new integration opportunities are considered, and the ultimate uses for the regional ITS architecture are discussed in more detail.

### Geographic Area

Ideally, the geographic scope of a region should be established so that it encompasses all systems that should be integrated together. In practice, it is sometimes difficult to determine where to draw the line so that the regional ITS architecture is inclusive without expanding to the point that the effort becomes unmanageable and consensus is difficult to achieve. While this is frequently called a "geographic" area, it is usually a political map that is being partitioned, defining a region along existing institutional boundaries.



Rule/Policy

The rule/policy states that metropolitan areas must consider the metropolitan planning area (MPA) as a minimum size for a region. The MPA is a good place to start since this boundary normally encompasses most integration opportunities and it coincides with the geographic region used for transportation planning. If the MPA is not the right boundary for a metropolitan regional ITS architecture, then a different geographic area can be specified, with rationale.

Service boundaries and special conformity boundaries should also be taken into consideration when determining the regional boundary:

**Service Boundaries:** Regional transportation agencies and other stakeholders each have geographic areas that they serve (e.g., transit services, toll authorities, etc.). These service boundaries should be considered when defining the geographic boundary for the regional ITS architecture. In metropolitan areas, these service boundaries may go outside the metropolitan planning area and influence the regional ITS architecture boundary.

**Special Conformity Boundaries:** In regions where there are special conformity issues like Air Quality, special conformity boundaries may also be considered. For example, ITS projects that are implemented to meet air quality goals within an air quality conformance boundary may require integration with other projects in the region. This suggests that the air quality conformance boundary may also be considered in establishing the geographic area covered by the regional ITS architecture.

Also consider the scope of other regional ITS architectures when defining the boundary. Where there are adjoining or overlapping regional ITS architectures, coordinate with the other region(s) to reach agreement on how common systems or interfaces will be represented in the two (or more) regional ITS architectures. For example, many states have created statewide ITS architectures that must be taken into account by the metropolitan area architecture(s) in those states. A few agencies have also created their own agency architectures that focus on internal agency interfaces, creating additional levels of architecture definition that should be taken into account in establishing architecture scope.



Special care is required when regional ITS architectures do overlap. Caution should be used whenever the same ITS element or interface is included in more than one regional ITS architecture. Unless automated methods like a relational database or Turbo Architecture are used, it is almost certain that some difference or ambiguity will arise in the two (or more) representations of the same architecture definition. Whenever possible, it is a good idea to define the ITS element or interface in one architecture and reference the one “authoritative” definition in all other regional ITS architectures.

### **Timeframe**

The regional ITS architecture should look far enough into the future so that it serves its primary purpose of guiding the efficient integration of ITS systems over time. While there is no required minimum, the most appropriate timeframe can be established based on how the regional ITS architecture will be used. Making the timeframe too short reduces the value of the regional ITS architecture as a planning tool. Making the timeframe too long increases the effort involved since very long range forecasts are difficult to make and subject to reevaluation and change.

- **5 Year Horizon:** A regional ITS architecture with a five year horizon will likely be easier to bound and define, but this relatively short timeframe may not include significant system integration opportunities that can be anticipated by the region's stakeholders and should be considered in future projects.
- **10-Year Horizon:** A ten-year horizon is long enough to include most of the system integration opportunities that can be clearly anticipated by the region's stakeholders. This timeframe is sufficient to support Transportation Improvement Program (TIP) generation and guide project implementation.
- **20-Year Horizon:** A 20-year time horizon is long enough to include all integration opportunities that may be included in the long range Transportation Plan.



A rough 5-, 10-, or 20-year approximation of the timeframe is enough to begin the process. The initial timeframe can then be reevaluated and changed as the regional ITS architecture takes shape.

As the regional ITS architecture is defined, the timeframe is normally a secondary consideration when determining whether to include a particular ITS element or interface. It is usually best to include the interfaces that are clearly supported by the stakeholders, even if these consensus interfaces push the envelope of the timeframe that was initially selected. In other words, the timeframe should be adjusted as necessary to match the vision of the stakeholders. It shouldn't be used to precisely constrain the stakeholders to near-term options since it is difficult to anticipate exactly when a well-supported idea will be implemented. Viable integration opportunities should be included in the regional ITS architecture and then reevaluated periodically as the regional ITS architecture is maintained over time.

### Service Scope

While specific identification of ITS services occurs later in the process, general decisions can be made immediately based on the scope of other regional ITS architectures. For example, if a statewide ITS architecture is defining commercial vehicle services, the 511 traveler information system, and the electronic toll collection system for the state, then any other regional ITS architectures in the state may decide to reference the statewide architecture for these services.



Avoid defining the same ITS services in multiple regional ITS architectures. The redundancy will cause difficulty in maintaining regional ITS architectures so that they are always consistent and complicate architecture use in the region.



### **Security Considerations**

A high-level security policy statement may be included in the formative scope of the regional ITS architecture that will guide architecture development in subsequent steps. Establishing the basic need for security at the outset is particularly important where regional ITS architectures rely on participation and support from public safety, emergency management, and other organizations where security is critical. Different organizations will be willing to accept different levels of risk; the security policy statement is an initial shared statement that can encourage organizations to participate in the regional ITS architecture development and subsequent integration projects.

### **3.2.2 Region Definition Output**

The definition of a region will specify the geographic area of coverage, typically using a map and a supporting textual description. The timeframe and service scope of the regional ITS architecture can also be defined to more completely document the scope of the region.

### **3.2.3 Region Definition Examples**

Many different types of “regions” have been defined in the regional ITS architectures that have been developed to date. Architectures have been developed for all of the following types of geographic areas:

- One or more counties or equivalent state political subdivisions.
- One or more municipalities (e.g. cities, townships, etc.)
- State DOT District(s)
- Metropolitan Planning Areas
- A corridor (or Thruway or Turnpike)
- One or more states
- A specific “service region”.

The last category is defined by a particular service or group of services. Service regions include tourist areas like the Greater Yellowstone region and international border areas like Western New York and Southern Ontario (the “Buffalo-Niagara Bi-National Regional ITS Architecture”). The service region may have a specific scope of ITS Services; for example, a larger regional ITS architecture that focuses on traveler information.

Two examples illustrate some of the types of regions that can be defined. The first example region was defined by the Delaware Valley Regional Planning Commission (DVRPC), which is the Metropolitan Planning Organization for the nine-county Philadelphia region. The region is essentially the nine-county MPO region expanded to include interfaces to ITS systems outside the region. The region is shown in the map in Figure 2.



**Figure 2: Regional ITS Architecture scope for the Delaware Valley RPC**

The second example, illustrated in Figure 3, shows the approximate geographic scope of three regional ITS architectures under development in the central valley in Northern California and adjacent mountain regions. The Sacramento Regional ITS Architecture covers the Sacramento metropolitan area and surrounding cities including all of Sacramento County, portions of Yolo County and portions of Placer County. The Tahoe Gateway Counties ITS Strategic Deployment Plan includes Nevada County, Sierra County, Placer County and El Dorado County. The Tahoe Basin ITS Strategic Plan incorporates parts of two states (California and Nevada) and five counties (Carson City, Douglas, El Dorado, Placer and Washoe) and the town of Truckee, located in Nevada County. The boundaries of these architectures overlap, requiring a commitment and open lines of communication between the three projects.



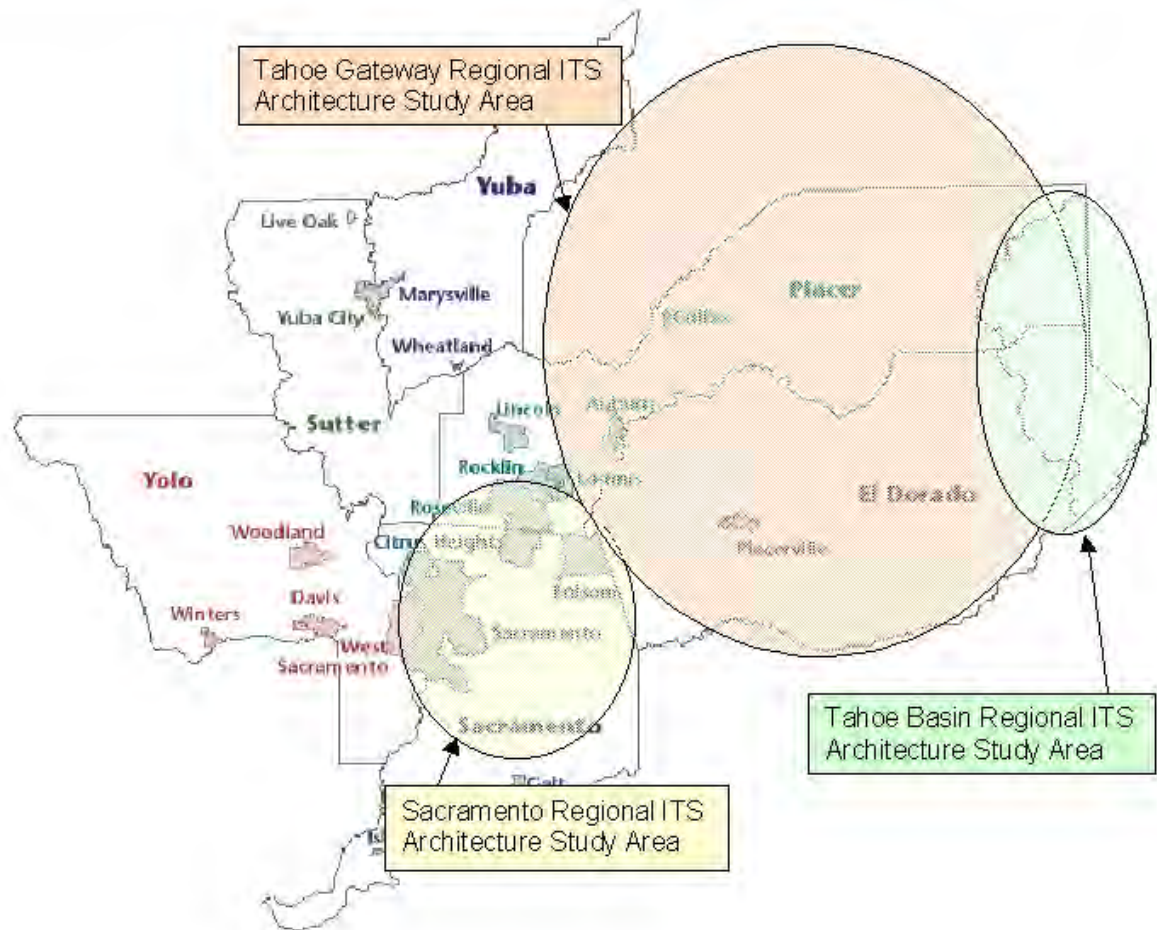

Figure 3: Adjacent/Overlapping Regions

**STEP #1: GET STARTED - Identify Stakeholders**

<p><i>These tasks may be performed in parallel.</i></p>	<ul style="list-style-type: none"> <li>• Identify Need</li> <li>• Define Scope</li> <li>• <b>Identify Stakeholders</b></li> <li>• Identify Champion(s)</li> </ul>
<p><b>OBJECTIVES</b></p>	<ul style="list-style-type: none"> <li>• Identify and engage stakeholders that own or operate ITS systems and other agencies that have an interest in regional transportation issues (<i>e.g., MPOs, etc</i>)</li> <li>• Build broad-based support for the regional ITS architecture.</li> </ul>
<p><b>PROCESS</b> <i>Key Activities</i></p>	<p><u>Outreach to Stakeholders</u></p> <ul style="list-style-type: none"> <li>• Prepare educational materials that provide examples of successful ITS projects and benefits of ITS and ITS architecture. These materials will help you demonstrate benefits to stakeholders and gain support for the regional ITS architecture.</li> <li>• Use ITS working groups already in place to engage potential stakeholders. Facilitate initial meetings among core stakeholders involved in surface transportation and regional planning.</li> <li>• Look outside immediate peers to identify new stakeholders.</li> <li>• Identify additional stakeholders from referrals by stakeholders already participating in the process.</li> </ul> <p><u>Build Consensus</u></p> <ul style="list-style-type: none"> <li>• Schedule ongoing meetings and/or provide a consistent mechanism for communication to/from agencies responsible for the overall transportation program.</li> <li>• Address issues as they arise by using the consensus building process to make decisions about projects, ITS regional goals, etc.</li> </ul>
<p><b>INPUT</b> <i>Sources of Information</i></p>	<ul style="list-style-type: none"> <li>• ITS educational and outreach resources</li> <li>• Existing working group rosters, various participant lists</li> <li>• Key stakeholder representatives from local transportation departments (cities, counties, states), public safety agencies, private companies, ...</li> </ul>
<p><b>OUTPUT</b> <i>Results of Process</i></p>	<ul style="list-style-type: none"> <li>• Identification of participating agencies and other stakeholders</li> </ul>



## 3.3 Identify Stakeholders

The success of the regional ITS architecture depends on participation by a diverse set of stakeholders. In this step, the stakeholders in the regional surface transportation system are identified and the process of encouraging their participation in the regional ITS architecture development process is initiated.



Identification of participating agencies and stakeholders is one of the required components of a regional ITS architecture as identified in FHWA Rule 940.9(d)2 and FTA National ITS Architecture Policy Section 5.d.2.

### 3.3.1 Stakeholder Identification Process

Regions will vary dramatically in the degree to which the surface transportation system stakeholders are aware of ITS. In regions that have already implemented substantial ITS systems, the stakeholders have already been working together on many of the issues that will be addressed during regional ITS architecture development. As a result, these regions usually have existing ITS committees that will be a natural forum to kick-off the regional ITS architecture development.

Other regions will require more significant education and outreach efforts about ITS in general and the merits of a regional ITS architecture in particular to assemble and motivate enough stakeholders. When preparing education and outreach material to introduce stakeholders to the regional ITS architecture, it is a good idea to use local project examples that may already be familiar. If local examples are not available, a variety of excellent material is available from USDOT and other sources.

Educating the right people is important – frequently the education and outreach efforts will target the management levels in an organization where decisions can be made to commit valuable personnel resources to support the architecture development effort. Without management support, it will be difficult or impossible for those with a working knowledge of ITS in the region to participate effectively in the regional ITS architecture effort.

It is often best to start with a core stakeholder group and then add participants to the core group over time. The core stakeholders group would itself be a diverse group with representation from each major agency and from both planners and system operators. This core group provides continuity to the development effort and an important set of contacts for the champion(s) and architecture developer(s). Including too many stakeholders at the start can hinder regional ITS architecture development progress and discourage people with limited vested interest in the process. Although the architecture effort should be very inclusive, a region may have better initial success if they are able to build consensus among the stakeholders that plan/own/operate ITS systems first before adding others into the decision making process.



Figure 4 shows a conceptual view of how stakeholders are added over time to the core stakeholder group. The core group is used to kick-off the effort. The number of active, participating stakeholders increases as the architecture development effort begins to generate more detailed and varied products that require broad review and support. The number of active stakeholders may then begin to taper off as reviews are completed, comments are incorporated, and “completed” regional ITS architecture products are published. This same strategy of engagement can be used, but probably on a smaller scale, for periodic maintenance activities that follow.

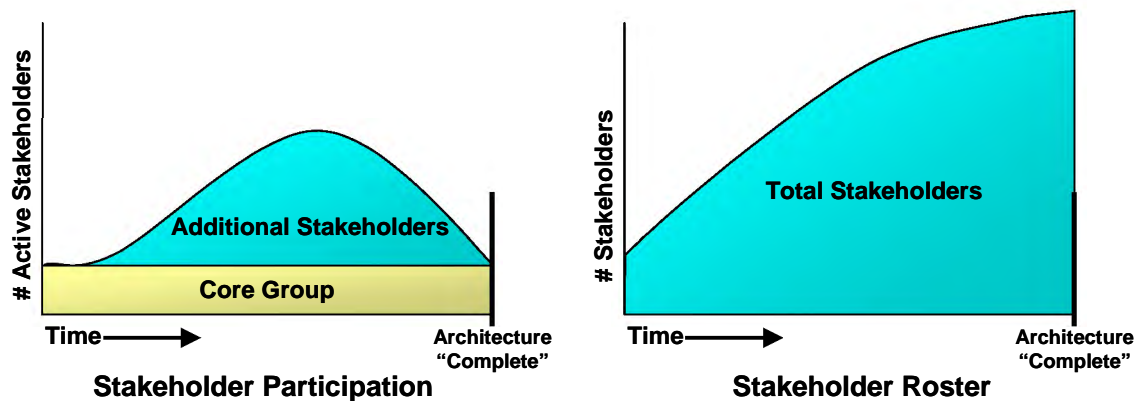

**Figure 4: Stakeholder Identification and Involvement Over Time**

While the number of active stakeholders begins to taper as the workload is reduced, the graph on the right shows that the total number of stakeholders will continue to increase over time, as different specialties and agencies participate in different parts of the architecture and different steps in the process. The perspective of the graph on the right is that once you are a stakeholder, you are always a stakeholder, although you may not actively participate beyond a specific milestone in the process. Over time, all relevant stakeholders in the region are engaged, just not all at once at the beginning of the architecture development effort.

If it is decided to initially limit the number of participants to a core group as depicted in Figure 4, set a timeframe to add others so that the architecture reflects the broader interests of the region. Table 1 in section 3.3.2 provides a list of potential stakeholders to consider.

As additional stakeholders are added to the process, it may be a good idea to retain a core group that meets regularly and have a broader group that is included at selected milestones in the regional ITS architecture development. It is critical that all stakeholders participate enough in the process that they understand the architecture and feel some ownership of the process and the regional ITS architecture that is developed. It is important to continually encourage and validate participation of stakeholders in the development process.



It is also important to focus stakeholder participation appropriately. For example, both planners and system operators will participate in the process, but with substantially different focus. System operators may be more interested in the operational concepts, functional requirements, and interface definitions, while the planners may have more substantial input while identifying transportation needs and services and project sequencing. Other individuals with specialized knowledge will be needed to assist in development of the list of agreements and list of required ITS standards. As the “stakeholder roster” is developed, consider the various areas of expertise that are required and use your stakeholder resources selectively. Different stakeholders should be engaged in different parts of the process, consistent with their expertise and interests.

Encouraging broad participation from many agencies, companies, and special interests in the region will occasionally bring people into the process who aren’t really stakeholders in the regional transportation system. If the representative doesn’t have, or plan to have, a system that should be integrated within the architecture timeframe or an interest in the surface transportation system as a whole (e.g., planners, the tourist industry, other special interests), then the representative is probably NOT really a stakeholder, will have little to contribute, and may ultimately grow frustrated with the process. It is best to understand the role of each potential new stakeholder in the surface transportation system at the outset and determine how they may contribute before significant time is invested. The objective is to be inclusive without wasting the time of those who do not have a vested interest.



Recognize and respect that everyone’s time is limited. Draw participants into the process without bogging them down. Some useful techniques to encourage people with demanding schedules to participate are to make sure everyone gets plenty of time to review documents, and schedule short meetings with teleconferencing options. This will help retain participants that may otherwise give up on the architecture effort due to other commitments.



### 3.3.2 Tools and Resources

Many good education and outreach resources are available to support efforts to encourage stakeholder participation in ITS-related efforts. USDOT has published an “ITS Resource Guide” that lists over 300 documents, web sites, training courses, software tools, and points of contact covering all aspects of ITS, including ITS architecture. An online version of this guide is available at <http://www.its.dot.gov/guide.htm>.



Applicable National ITS Architecture resources include a training course and technical information that has been used to assist in identification of stakeholders in the past. The National ITS Architecture training course is provided by the National Highway Institute (Course # 137013, <http://www.nhi.fhwa.dot.gov/>). The subsystems and terminators defined in

the physical architecture provide a good categorization of the various systems and stakeholders that can be considered in developing a list of stakeholders for the regional ITS architecture development. To access an on-line version of the Architecture, visit <http://www.its.dot.gov/arch/index.htm>.



Stakeholder lists may be entered directly into Turbo Architecture. Each stakeholder includes a name and a description and a variety of other information. Turbo can generate a stakeholder report and export stakeholder information to support the stakeholder output described in section 3.3.3.

The list of stakeholders identified in Table 1 includes the range of stakeholders that have participated in regional ITS architecture development efforts around the country. The table makes a good checklist of *possible* stakeholders that may be involved in your regional ITS architecture.

**Table 1: Candidate Stakeholders**

<b>Transportation Agencies</b>	<ul style="list-style-type: none"> <li>• State Departments of Transportation (DOT)</li> <li>• Local Agencies (City &amp; County)               <ul style="list-style-type: none"> <li>○ Department of Transportation</li> <li>○ Department of Public Works</li> </ul> </li> <li>• Federal Highway Administration (FHWA)</li> <li>• State Motor Carrier Agencies</li> <li>• Toll/Turnpike Authorities</li> <li>• Bridge/Tunnel Authorities</li> <li>• Port Authorities</li> <li>• Department of Airport or Airport Authority</li> </ul>
<b>Transit Agencies/Other Transit Providers</b>	<ul style="list-style-type: none"> <li>• Local Transit (City/County/Regional)</li> <li>• Federal Transit Administration</li> <li>• Paratransit Providers (e.g., Private Providers, Health/Human Services Agencies)</li> <li>• Rail Services (e.g., AMTRAK)</li> <li>• Intercity Transportation Services (e.g., Greyhound)</li> </ul>
<b>Planning Organizations</b>	<ul style="list-style-type: none"> <li>• Metropolitan Planning Organizations (MPOs)</li> <li>• Council of Governments (COGs)</li> <li>• Regional Transportation Planning Agency (RTPA)</li> </ul>
<b>Public Safety Agencies</b>	<ul style="list-style-type: none"> <li>• Law Enforcement               <ul style="list-style-type: none"> <li>○ State Police and/or Highway Patrol</li> <li>○ County Sheriff Department</li> <li>○ City/Local Police Departments</li> </ul> </li> <li>• Fire Departments               <ul style="list-style-type: none"> <li>○ County/City/Local</li> </ul> </li> <li>• Emergency Medical Services</li> <li>• Hazardous Materials (HazMat) Teams</li> <li>• 911 Services</li> </ul>
<b>Other Agency Departments</b>	<ul style="list-style-type: none"> <li>• Information Technology (IT)</li> <li>• Planning</li> <li>• Telecommunications</li> <li>• Legal/Contracts</li> </ul>

<b>Activity Centers</b>	<ul style="list-style-type: none"> <li>• Event Centers (e.g. sports, concerts, festivals, ski resorts, casinos, etc.)</li> <li>• National Park &amp; US Forest Services</li> <li>• Major Employers</li> <li>• Airport Operators</li> </ul>
<b>Fleet Operators</b>	<ul style="list-style-type: none"> <li>• Commercial Vehicle Operators (CVO) <ul style="list-style-type: none"> <li>◦ Long-Haul Trucking Firms</li> <li>◦ Local Delivery Services</li> </ul> </li> <li>• Courier Fleets (e.g., US Postal Services, Federal Express, UPS, etc.)</li> <li>• Taxi Companies</li> </ul>
<b>Travelers</b>	<ul style="list-style-type: none"> <li>• Commuters, residents, bicyclists/pedestrians</li> <li>• Tourists/Visitors</li> <li>• Transit Riders, others</li> </ul>
<b>Private Sector</b>	<ul style="list-style-type: none"> <li>• Traffic Reporting Services</li> <li>• Local TV &amp; Radio Stations</li> <li>• Travel Demand Management Industry</li> <li>• Telecommunications Industry</li> <li>• Automotive Industry</li> <li>• Private Towing/Recovery Business</li> <li>• Mining, Timber or Local Industry Interest</li> </ul>
<b>Other Agencies</b>	<ul style="list-style-type: none"> <li>• Tourism Boards/Visitors Associations</li> <li>• School Districts</li> <li>• Local Business Leagues/Associations</li> <li>• Local Chambers of Commerce</li> <li>• National Weather Services (NWS)</li> <li>• Air &amp; Water Quality Coalitions</li> <li>• Bureau of Land Management (BLM)</li> <li>• Academia Interests, local Universities</li> <li>• National and Statewide ITS Associations (e.g. ITS America, ITE ITS members, etc.)</li> <li>• Military</li> </ul>

### 3.3.3 Stakeholder Identification Output

This output identifies stakeholders who participated in the development of the regional ITS architecture by:

- Participating in stakeholder meetings and workshops.
- Reviewing and commenting on draft documents.
- Providing input to describe their systems and future plans.
- Participating in earlier regional ITS architecture activities whose products were used in the development of the current regional ITS architecture.

The purpose of this output is to record the stakeholder participation in the development of the regional ITS architecture and document the consensus process that was used in the regional ITS architecture development.

The actual documentation can take many forms, but a straightforward approach is to build a simple table or database with fields identifying the agency, company or interest group, transportation area, and possibly key participant contact information. This table can then be sorted by agency, company or interest group to check if each agency, company or interest

group has adequate representation in the regional ITS architecture consensus development process.

### 3.3.4 Stakeholder Identification Example

Table 2 is a basic list of stakeholders that was prepared for an ITS architecture for the Franklin Tennessee Traffic Operations Center (TOC). It identifies each stakeholder agency that is related to the TOC and the systems that relate to each stakeholder agency. This is the complete stakeholder list for this small regional ITS architecture. The list of stakeholders will be considerably larger than this for most metropolitan regions.

**Table 2: Franklin, TN TOC Stakeholders**

Stakeholder Name	Responsible for these systems in the Architecture
City of Franklin Engineering Department	Storm Water Management System
	Franklin TOC_Personnel
	Franklin TOC_Roadside Equipment
	Franklin Parking Management System
	Franklin TOC
Franklin Police Department	Emergency Vehicles
	Franklin Police Dispatch_Personnel
	Weather Service
	Franklin Police Dispatch
Tennessee DOT	Nashville Regional Transportation Management Center
Franklin Transit	Franklin Transit System
	Transit Vehicles
TMA Group	Franklin TMA Kiosks
City of Franklin Streets Department	Construction and Maintenance
Community Access Television	Media
City of Franklin	Event Promoters
	Franklin Website
City of Murfreesboro	Murfreesboro TOC
Traveling Public	User Personal Computing Devices
Williamson County	Williamson County Emergency Management System
Nashville MPO	Regional Planning System



**STEP #1: GET STARTED - Identify Champion(s)**

<p><i>These tasks may be performed in parallel.</i></p>	<ul style="list-style-type: none"> <li>• Identify Need</li> <li>• Define Scope</li> <li>• Identify Stakeholders</li> <li>• <b>Identify Champion(s)</b></li> </ul>
<p><b>OBJECTIVES</b></p>	<ul style="list-style-type: none"> <li>• Identify one or more key persons to lead the regional ITS architecture development.</li> <li>• Obtain broad-based buy in and support from stakeholders.</li> </ul>
<p><b>PROCESS</b> <i>Key Activities</i></p>	<p><u>Looking for Champion(s)</u></p> <ul style="list-style-type: none"> <li>• Champions for the region are probably already visible because they are proactive in the field of ITS, visionary about the future of ITS, and frequently already manage ITS projects.</li> <li>• Champion must be a stakeholder, so they have a vested interest in the outcome.</li> <li>• More than one champion can be identified from different agencies or stakeholder groups:             <ul style="list-style-type: none"> <li>○ Transportation agencies (Traffic, transit, toll authorities, etc.) that support ITS because it meets their operational needs.</li> <li>○ Public safety agencies who can bring in other public safety stakeholders.</li> </ul> </li> </ul> <p><u>Champion Skills</u></p> <ul style="list-style-type: none"> <li>• Understanding of the subject (regional ITS architecture including familiarity with the National ITS Architecture),</li> <li>• Knowledge of local ITS systems and projects</li> <li>• Vision for interconnectivity, partnership, and regional integration,</li> <li>• Consensus builder (facilitator), and</li> <li>• Executive level access to resources to gain support for various regional efforts.</li> </ul> <p><u>Building Consensus</u></p> <ul style="list-style-type: none"> <li>• Initiate a scheduled meeting time and place to work on the Regional Architecture, set agendas for meetings and allow opportunity for each stakeholder to provide input to the process.</li> </ul>
<p><b>INPUT</b> <i>Sources of Information</i></p>	<ul style="list-style-type: none"> <li>• Not Applicable.</li> </ul>
<p><b>OUTPUT</b> <i>Results of Process</i></p>	<ul style="list-style-type: none"> <li>• Strong leadership that has broad-based regional stakeholder support and an effective problem resolution mechanism for ITS projects.</li> </ul>

## 3.4 Identify Champion(s)

In this step, the champion(s) that will lead the regional ITS architecture development effort are identified. The champion(s) drive the process that must occur in order to develop a regional ITS architecture and build consensus at each step of the development. Without strong leadership, consistent meetings and a plan for completion of tasks, many of the participants will quickly become busy with other daily responsibilities.

### 3.4.1 Process of Identifying Champions

Many regions have already developed a team of ITS stakeholders that meet on a regular basis. Chances are that the champion(s) have already been identified by the fact that they are leading the regional efforts through an ITS Task Force, Technical Advisory Committee or the fact that they are already leading a major ITS project in the region. Adding regional ITS architecture consensus building to whatever “hat” these people are already wearing will be a natural transition. The process of identifying a champion or champion(s), and developing a task force to put the regional ITS architecture together should be woven into the existing regional planning process for ITS if one is already underway.

Champions are usually not voted-in; they are selected “on the job” in the course of working together. In many regions, a single champion will be identified. If there are several people who rise to the occasion, several champions can be identified that take turns leading the meetings or agree upon some shared responsibilities that will keep everyone engaged. A champion’s skills include:

- Understanding of the subject (regional ITS architecture including familiarity with the National ITS Architecture),
- Knowledge of local ITS systems and projects
- Vision for interconnectivity, partnership, and regional integration,
- Consensus builder (facilitator), and
- Executive level access to resources to gain support for various regional efforts.

The skill level that is needed in each area will vary depending on the technical and institutional maturity of the region. A more technically mature region may have many people with existing knowledge of the National ITS Architecture, but require increased skills in consensus building to pull various interests together. In institutionally mature areas that are growing in ITS technology, it may be a strong vision that guides the process. All of the identified skills are important for a strong successful champion along with the knowledge of when to use them.

No one individual is likely to possess all the knowledge and skills required to develop a regional ITS architecture. To be successful, the champion(s) must draw on the knowledge and skills of a diverse set of stakeholders. The



champion is primarily a facilitator and manager and is not normally the one that actually defines the architecture – the stakeholders are.

**A Champion must be a Stakeholder.** It would be very difficult, if not impossible, for someone who did not have a vested interest in the outcome to be the champion for a regional ITS architecture development effort. A stakeholder who is already recognized in the region will best be able to take ownership and invest the time necessary to manage the regional ITS architecture development. FHWA, FTA, consultants, vendors and others are great participants, consultants may even do a lot of the detailed analysis and legwork in a regional ITS architecture effort, but for regional long-term benefit, they should not be champions.



Tips

Identifying more than one Champion from varying backgrounds and disciplines (e.g., public safety, transit, state DOT, city and/or county traffic engineering) can be a benefit. A small group of people with diverse backgrounds and contacts can strengthen the regional ITS architecture product by improving stakeholder participation, encouraging agency buy-in, and facilitating access to the information and resources necessary to support architecture development. Where several champions are identified, they may form a steering committee (which could also include representation from others such as FHWA/FTA) that manages by consensus or advises and supports a leader who actually manages the development and maintenance effort.

Section 3.3.1 introduced the idea of a core stakeholder group that would be involved throughout the architecture development effort. This group might be the small group of “champions” described in the previous paragraph, or it could be a larger group. No one model will encompass all regional ITS architecture development efforts. Each region must decide how they wish to organize their efforts. The key is that there is a group of stakeholders who plays a key role throughout the architecture development effort.



Caution

Champions will probably come and go over the evolution of developing and maintaining the regional ITS architecture, and certainly will change over the life of regional ITS system implementation and expansion. The task of the Champion, like other leadership responsibilities, takes significant time. Dividing the work among a few champions will limit the turnover and ease the transition when one person leaves. It is important that good meeting minutes and records of action items are kept so that new champions will have some guidance regarding when, where, and why decisions were made.

### 3.4.2 Examples

Champions are identified based on the people involved, the priorities of the participating agencies, and a range of other factors that are unique to each region. Because the factors involved are so specific to a region, it is unlikely that information on past champions will influence the selection of future

champions in other regions. Nevertheless, it is interesting to look at the agency affiliation and titles of champions that have been identified. Table 3 shows some of the champions that have supported regional ITS architecture efforts in recent years. The table shows that a significant majority of champions have worked for either the state DOT or MPO.

**Table 3: Regional ITS Architecture Champions**

<b>Region</b>	<b>Champion</b>
Albany, NY	Assistant Regional Traffic Engineer – NYSDOT
Atlanta, GA	Senior Planner – Atlanta Regional Commission
Austin, TX	Traffic Engineer – TXDOT Austin
Chicago, IL	ITS Program Manager – IDOT
Cleveland, OH	Work Zone & Traffic Control Engineer – Ohio DOT
<i>Detroit, MI</i>	Senior Engineer – SEMCOG
Hartford, CT	Supervising Engineer – ConnDOT
Honolulu, HI	Executive Director – Oahu Metropolitan Planning Organization
Indianapolis, IN	INDOT
Kansas City, KS	Manager, Transportation Programs – Mid-America Regional Council
Little Rock, AR	Engineer – Metroplan
Long Island, NY	Inform ODS Director – NYSDOT R-10
Milwaukee, WI	TOC Assistant Manager, WisDOT
Oklahoma City, OK	Associate Planner, ACOG
Omaha, NE	Transportation Technology Engineer – Nebraska Department of Roads
Pittsburgh, PA	Transportation Planner, Southwestern Pennsylvania Regional Planning Commission
Portland, OR	Regional Traffic Engineer – ODOT
Providence, RI	TMC Manager – RIDOT
Rochester, NY	ITS Coordinator – NYSDOT
Sacramento, CA	Senior Analyst – Sacramento Council of Governments
St. Louis, MO	TIC Manager – MoDOT
State College, PA	Risk Management/ITS Administrator – PennDOT 2-0

Section  
**4**

# Gather Data

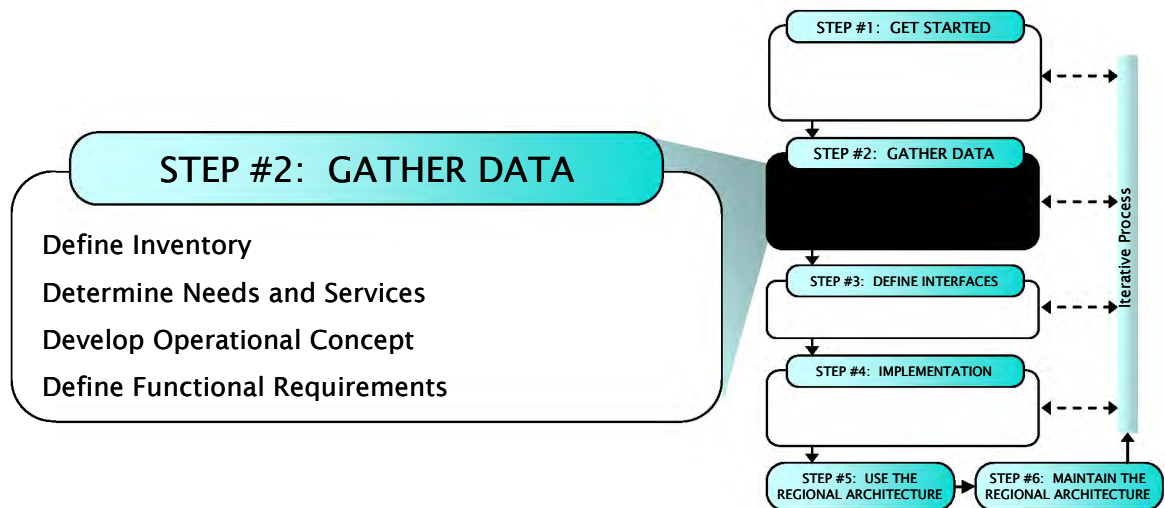

This section describes the second step in the regional ITS architecture development process – “Gather Data”.

In this step, the data necessary to build a regional ITS architecture is assembled. An inventory of the ITS elements in the region is taken, the roles and responsibilities of each stakeholder in developing, operating, and maintaining the ITS elements is documented, the ITS services that should be provided in the region are identified, and the contribution (in terms of functionality) that each ITS element will make to provide these ITS services is documented.

In this section, the four “Gather Data” process tasks are described in more detail. Each task description begins with a one page summary that is followed by additional detail on the process, relevant resources and tools, a general description of the associated outputs, and example outputs where they are available. Each task description also includes tips and cautionary advice that reflect lessons that have been learned in development of regional ITS architectures over the past several years.

## STEP #2: GATHER DATA – Inventory Systems

<p><i>These tasks may be performed in parallel.</i></p>	<ul style="list-style-type: none"> <li>• <b>Define Inventory</b></li> <li>• Determine Needs and Services</li> <li>• Develop Operational Concept</li> <li>• Define Functional Requirements</li> </ul>
<p><b>OBJECTIVES</b></p>	<ul style="list-style-type: none"> <li>• <i>Identify existing and planned ITS elements in the region.</i></li> <li>• <i>Build stakeholder awareness of these ITS elements.</i></li> </ul>
<p><b>PROCESS</b> <i>Key Activities</i></p>	<p><u>Prepare</u></p> <ul style="list-style-type: none"> <li>• Locate inventory data that may already be documented in Regional ITS Plans (e.g., EDPs), ITS studies, ITS Project documentation, RFPs, and any other relevant documents.</li> </ul> <p><u>Define Inventory</u></p> <ul style="list-style-type: none"> <li>• Use collected inventory data to create an initial inventory. Focus on the “centers” first.</li> <li>• Review the initial inventory with key stakeholders and collect additional inventory information.</li> <li>• Document the associated organization(s), high-level status (e.g., existing or planned), and a brief description for each element in the inventory,</li> <li>• Map each inventory element to the National ITS Architecture subsystems and terminators.</li> <li>• Use the National ITS Architecture mapping to identify inventory gaps and identify additional inventory items to fill the gaps.</li> </ul> <p><u>Build Consensus</u></p> <ul style="list-style-type: none"> <li>• Facilitate a broad review of the draft inventory and incorporate comments.</li> <li>• <i>Stakeholders can check with other departments in their agencies to verify the inventory for their agency is complete and accurate.</i></li> </ul>
<p><b>INPUT</b> <i>Sources of Information</i></p>	<ul style="list-style-type: none"> <li>• Stakeholders</li> <li>• ITS Plans and Studies (Various)</li> <li>• TIP, STIP, SIP, Transportation Plan, Congestion Management Plan, Commercial Vehicle Safety Plan, etc.</li> </ul>
<p><b>OUTPUT</b> <i>Results of Process</i></p>	<ul style="list-style-type: none"> <li>• Inventory of existing and planned ITS elements in the region.</li> </ul>

## 4.1 Define Inventory

Each stakeholder agency, company, or group owns, operates, or maintains ITS systems in the region. In this step, a comprehensive inventory of “ITS elements” is developed that represent these systems, based on existing inventories and stakeholder input.



An inventory of existing and planned ITS elements supports development of interface requirements and information exchanges with these ITS elements as required in FHWA Rule 940.9(d)6 and FTA National ITS Architecture Policy Section 5.d.6.

### 4.1.1 Inventory Process

The process of creating an inventory of ITS elements starts with collecting existing inventory information. This can often provide an excellent jumpstart to the inventory definition. In addition to existing plans, studies, and project documentation, adjacent or overlapping regional ITS architectures are a good source for inventory information. A portion of the inventory in these architectures will often be relevant, saving time and improving consistency between adjacent or overlapping architectures. *It is best to develop a partial inventory based on these resources prior to engaging a large number of stakeholders to make best use of stakeholder time.*

It is helpful to establish a naming convention before assembling the inventory. For example, the names that are used in the inventory should start with a standard prefix since the inventory will frequently be viewed and managed as an alphabetized list of names. Prefixes can be a concise and consistent reference to the stakeholder (e.g., XYZ Transit), a reference to the location (City ABC), or any other standard prefix that will group similar ITS elements when the inventory is sorted by name. By establishing and using a naming convention at the outset, the inventory will be easier to read and manage, and there will be less rework later to rename and reorganize the inventory after it is assembled.



When building an inventory, focus first on the “centers” since they are typically involved in the majority of inter-agency and public/private interfaces that need the most attention. Focus next on the field, vehicle, and traveler ITS elements where there is some opportunity for integration. Next consider other ITS elements that are in the region that may interface with ITS. Airports, asset management systems, and special event centers are examples of ITS elements in the region that may provide integration opportunities and should be included in the inventory. Finally, consider centers in adjacent regions, like the TMC in the adjacent state. The objective is to identify the ITS elements in the region that will allow integration opportunities to be identified and considered later in the process. Unless the

region has unique needs, don't include ITS elements in the inventory for people (e.g., traffic operations personnel) or environmental terminators (e.g., roadway environment). The focus should be on the systems in the region that may be integrated. Systems with no potential for integration (e.g., an isolated traffic signal in a remote community) need not be included in the inventory.

Working closely with the stakeholders as the inventory is expanded and refined improves the quality of the inventory and increases stakeholder awareness of the existing and planned transportation systems in the region. Many different mechanisms may be used to gather stakeholder input including workshops, smaller meetings, telephone surveys, e-mail, and web-based interactions. Plan to use one or more of these mechanisms to verify and improve the inventory with stakeholder feedback. It may be helpful to engage a few key stakeholders initially and then encourage a broader review once the inventory is substantially complete.

The inventory should cover the geographic, timeframe and services scope specified for the region. The inventory, representing many existing and planned systems that may be implemented over ten or twenty years, can be developed in a single pass or in multiple passes. For example, you might start with an inventory of existing ITS elements, then add planned elements (i.e., elements that have been programmed), and finally add future elements that may be implemented towards the end of the established timeframe.

### Security Considerations



The regional ITS inventory that is compiled should be reviewed to identify critical assets – systems that, if lost, would jeopardize the ability of the regional transportation system to provide a primary function or threaten public safety. Any existing regional analysis of critical assets can be used as a starting point, if available. In later steps, the regional ITS architecture will be organized to protect these critical assets and security services. Security mechanisms will be defined to isolate these critical assets from non-critical assets. The security analysis associated with each National ITS Architecture subsystem can provide an input to the identification of the security-critical elements in the ITS inventory.

### 4.1.2 Inventory Resources and Tools



In addition to existing plans, studies, and project documentation that may be available in the region, the ITS Deployment Tracking Database (<http://www.itsdeployment.its.dot.gov>) may also be used as a source of existing ITS inventory information. This database contains information on ITS deployments in metropolitan areas based on surveys of metropolitan areas and states.



The National ITS Architecture subsystems and terminators can be used to organize the ITS elements in the inventory. For example, Traffic Operations Centers and Public Safety Communications Centers may be associated with the Traffic Management Subsystem and Emergency Management Subsystem respectively. This association, or “mapping” to the National ITS Architecture establishes an important connection between the regional ITS architecture and the National ITS Architecture. The subsystems and terminators can also serve as a checklist that may be used to identify gaps in the inventory. The subsystems and terminators are defined in the Physical Architecture on the architecture CD-ROM and web sites.



*Turbo Architecture* was specifically designed to support development of ITS inventories. Turbo provides interview questions and forms that can be used to rapidly develop an ITS Inventory for a region.

### 4.1.3 Inventory Output

A regional ITS architecture inventory is a list of all existing and planned ITS elements in a region as well as non-ITS elements that provide information to or get information from the ITS elements. The focus should be on those elements that support, or may support, interfaces that cross stakeholder boundaries (e.g., inter-agency interfaces, public/private interfaces).

There is wide latitude in the types of ITS elements that may be included and the level of granularity that should be specified in an inventory. Although every inventory will vary based on the unique needs of the region, several general “best practices” guidelines can be offered to those preparing an inventory.



In general, the inventory should be managed so that it is as small as possible while still supporting the goal of identifying all key integration opportunities in the region. For example, instead of identifying separate inventory elements for each type of field equipment (e.g., separate elements for VMS, signal, camera, etc.), consider identifying a single inventory element that includes all of the field equipment as depicted in Figure 5.



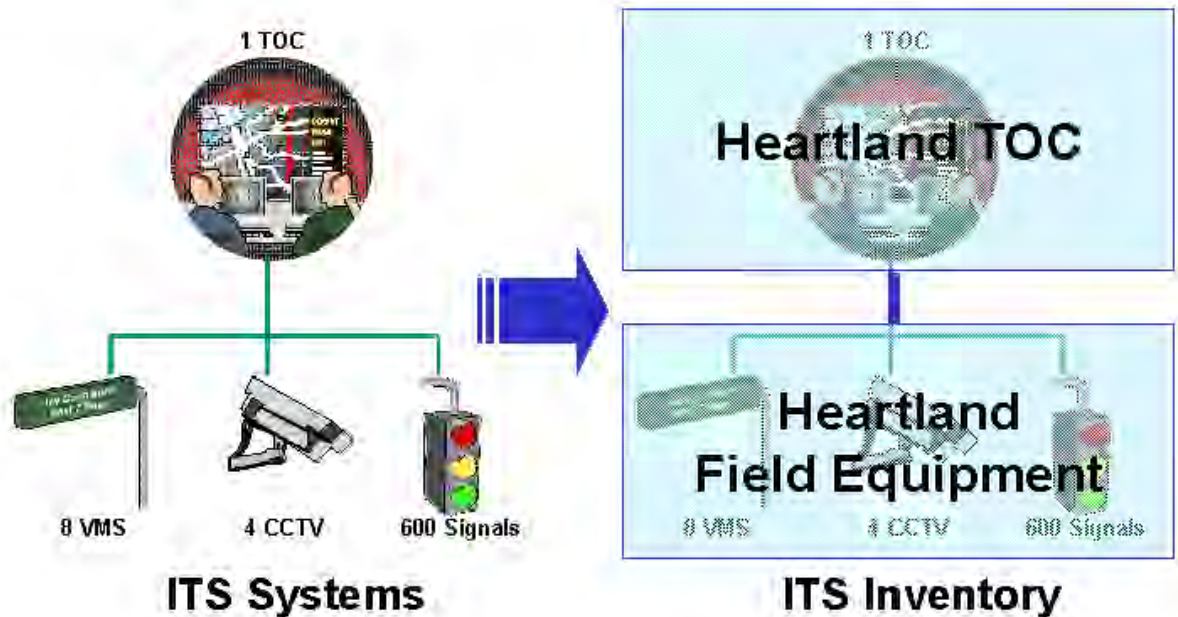

**Figure 5: Grouping ITS Elements into General Inventory Elements**

Of course, ITS elements cannot be grouped into general elements indiscriminately. Multiple ITS elements can be safely grouped into a single inventory element if they exchange the same types of information with the same elements, and if they will be deployed for the same function over time. (E.g. message signs for a freeway and message signs for transit traveler information at a bus stop probably should be identified as separate ITS elements because of the very different requirements for these ITS elements.) The grouping works in Figure 5 because all the Heartland field equipment interfaces exclusively with the Heartland TOC, and for example, might be part of a single freeway management system deployment project. If some of the field equipment was actually owned and operated by another agency, then it might be best to identify a separate ITS element for that equipment group.

Another consideration is that when ITS elements are grouped in the inventory, the potential interfaces between these elements are lost (e.g., any potential interface between different types of Heartland field equipment is lost with the grouping in Figure 5). Again, the grouping in Figure 5 is acceptable because the interface between field equipment is (presumably) not a significant regional interface. The last issue is the affect that that grouping has on ITS standards identification later in the process. Due to the grouping, the combination of ITS standards that support Dynamic Message Signs, CCTV Control, and Signal Control will all be associated with the interface to the combined Field Equipment Element. This means that the ITS standards information for the element must be interpreted and used carefully to ensure that device-specific standards are identified and used properly later in the process. As long as the ITS element grouping is done with these issues in



mind, recent experience indicates that grouping will save regional ITS architecture development time with little or no impact to the quality and utility of the final architecture.



The level of granularity in the inventory can vary within a single regional ITS architecture. For example, larger systems in a major metropolitan area may be explicitly identified (e.g., “District 8 Freeway Management Center”), but smaller systems may be represented more broadly with a few general ITS elements (e.g., “Municipal Police Dispatch Centers”). The approach of “rolling up” smaller systems into a general inventory element suggests that these systems should integrate with other regional elements in a consistent fashion. A detailed list of the agencies and systems represented by the general ITS element can be included in the definition for the element.

An inventory may include a few ITS elements that are outside the defined scope of the region. For example, a Statewide ITS Architecture inventory may include ITS element(s) representing operations centers in adjacent states where there are important interfaces to these operations centers. These “inter-regional” interfaces should be coordinated across regional ITS architectures to avoid duplicate and/or conflicting definitions of the same interface. The names of the ITS elements in both regional ITS architectures must be identical when they represent the same system, and the interfaces defined in both regional ITS architectures should be identical when they describe the same information exchange across regional ITS architecture boundaries.

Each element in an inventory will normally include a name, associated stakeholder(s), a concise description, general status, and the associated subsystems or terminators from the National ITS Architecture. This core information may be supplemented with specific location information, points of contact, other references, and various implementation details as needs dictate. The region should establish the information that is required for each inventory element based on the needs of the region and available resources.

The fields that are normally included for each inventory element are described in the following paragraphs.

**Element Name:** Each element name should be selected with several criteria in mind. Most importantly, the selected name should be easily recognizable by the stakeholders. Preferably, the name will be the “common usage” name for the element in question, or at least be in terms that are familiar to the stakeholders.



While they may not seem important at the outset, naming conventions are a big help, particularly for large inventories. As discussed earlier, standard prefixes (e.g., “City ABC” or “County”) ensure that related elements are sorted

together when the inventory is alphabetized. The name of the element immediately follows the prefix to complete the element name. It is best to use the same names when referring to the same types of elements or equipment. For example, avoid using “roadside assets”, “field equipment”, and “roadway systems” for three different inventory elements covering similar field equipment for three different traffic agencies. Pick a name (e.g., “Field Equipment”) that the stakeholders like, and then use it consistently where possible (e.g., “City ABC Field Equipment”, “City XYZ Field Equipment”, “XDOT Field Equipment”). Consistent names make the architecture easier to understand, maintain, and use.

Including a stakeholder prefix and system name in each ITS element name can make the names fairly long. Abbreviations and acronyms are a big help in keeping the names short enough so that they fit in the various diagrams and tables that will be used to publish the inventory. Care should be taken, though, to ensure that all of the abbreviations and acronyms make sense to the stakeholders.

**Associated Stakeholders:** While stakeholders can participate in the consensus of any part of the regional ITS architecture, they often are most interested in the inventory elements that they own, operate, or maintain. Documenting the association between stakeholders and ITS elements is useful since it allows stakeholders to rapidly identify their own elements. This association helps individual stakeholders make the most effective use of their time. If individual stakeholders don’t have time to review the entire regional ITS architecture, they might still be able to review all sections that involve their associated agency, company or interest group, as identified by the associated stakeholder.



**Description:** While it may be tempting to include very detailed information in the element description when it is available (e.g., the numbers and types of controllers included in a particular ITS element), remember that this level of detail will increase the level of effort required to maintain the regional ITS architecture later. In general, the architecture inventory should not specify technologies or manufacturers since this information is subject to change and incidental to the purpose of the regional ITS architecture. Limit the information to what is required for the stakeholders to recognize the element and its role (i.e., “what does it do?”) in the regional ITS architecture. Where a general element is used to represent many systems, the description could include an explicit list of these systems. Additional detailed information that is compiled can be archived separately for later use.

**Associated Subsystems/Terminators:** Each regional ITS architecture inventory element should be mapped to one or more National ITS Architecture subsystems and/or terminators. This association must be created because it will lead to identification of functional requirements for the

ITS element, and architecture flows and supporting ITS standards in later steps. Occasionally, an element will be truly unique and not represented in the National ITS Architecture at all. In this case, no National ITS Architecture association is created. This is a perfectly valid approach, but it does mean that the functionality, architecture flows, and standards that are identified later for the element will not have a basis in the National ITS Architecture.

#### **4.1.4 Inventory Examples**

Although inventories all tend to include approximately the same information, many different ways to document this information have been devised. Excerpts from three different inventory presentations are included in this section to illustrate some of the ways that inventories have been documented.

##### **Example 1: Inventory Summary Sorted by Stakeholder Name**

An inventory summary can be presented in tabular form as shown in an excerpt from the Florida District 3 regional ITS architecture in Figure 6. The table is sorted by stakeholder name so that stakeholders can easily find the elements that are associated with their agency, company or user group. For example, a City of Pensacola employee could rapidly see that there are four elements in the regional ITS architecture that are associated with his or her agency: City of Pensacola Field Equipment; City of Pensacola Traffic Operations Center; FDOT District 3 Escambia/Santa Rosa County RTMC, and Pensacola Regional Airport. (Note that “FDOT D3/Pensacola/Escambia Cty/Santa Rosa Cty” is a named stakeholder group that includes the *City of Pensacola* as well as *Escambia County*, *FDOT District 3*, and *Santa Rosa County*.)

Stakeholder	Element
Airport Authorities	<a href="#">Air Freight Terminals</a>
Airport Authorities	<a href="#">Regional Airports</a>
Amtrak	<a href="#">Amtrak Passenger Train Terminal</a>
Apalachee Regional Planning Council	<a href="#">Apalachee RPC Traffic Database</a>
Archived Data Users	<a href="#">Archived Data User Systems</a>
Bay County	<a href="#">Bay County Field Equipment</a>
Bay County	<a href="#">Bay County Transportation Management Center</a>
Bay County	<a href="#">Panama City - Bay County International Airport</a>
Bay County Transportation Planning Organization	<a href="#">Bay County Transit Operations</a>
Bay County Transportation Planning Organization	<a href="#">Bay County Transit Vehicles</a>
CHEMTREC	<a href="#">CHEMTREC</a>
City of Gulf Breeze	<a href="#">City of Gulf Breeze Field Equipment</a>
City of Gulf Breeze	<a href="#">City of Gulf Breeze Traffic Management Center</a>
City of Milton	<a href="#">City of Milton Field Equipment</a>
City of Pensacola	<a href="#">City of Pensacola Field Equipment</a>
City of Pensacola	<a href="#">City of Pensacola Traffic Operations Center</a>
City of Pensacola	<a href="#">FDOT District 3 Escambia/Santa Rosa County RTMC</a>
City of Pensacola	<a href="#">Pensacola Regional Airport</a>
City of Port St. Joe	<a href="#">Port St. Joe</a>
City of Tallahassee	<a href="#">City of Tallahassee Field Equipment</a>

**Figure 6: Florida DOT District 3 Inventory by Stakeholder Excerpt**

### Example 2: Detailed Inventory Information Presentation

Figure 7 shows more comprehensive inventory information for a particular ITS element: “FDOT District 3 Escambia/Santa Rosa County RTMC” (note that RTMC means “Regional Traffic Management Center”), in the FDOT District 3 regional ITS architecture. This figure shows the element status, a brief description of the element, who the owning/operating stakeholder is, and a listing of the National ITS Architecture entities (subsystems and terminators) to which the element is mapped.

ITS Element: FDOT District 3 Escambia/Santa Rosa County RTMC	
Description:	This operations center will provide traffic management services covering the city of Pensacola, Escambia County, and Santa Rosa County. Other colocated stakeholders include FHP, MCCO, City of Gulf Breeze, and City of Milton.
Status:	Planned
Stakeholder:	FDOT D3/Pensacola/Escambia Cty/Santa Rosa Cty
Mapping:	Emergency Management Traffic Management Maintenance and Construction Management

**Figure 7: Inventory Details for a Florida DOT District 3 ITS Element**

### **Example 3: Subsystem Diagram Inventory Presentation**

The association or mapping between regional ITS architecture elements and the National ITS Architecture is also frequently depicted in an extended version of the “Subsystem Diagram” as illustrated in Figure 8. This diagram is also taken from the FDOT District 3 regional ITS architecture. Here, the generic subsystem diagram is expanded so that each subsystem (and terminator, even though they are not normally shown in a subsystem diagram) is associated with specific inventory elements in Florida DOT District 3.



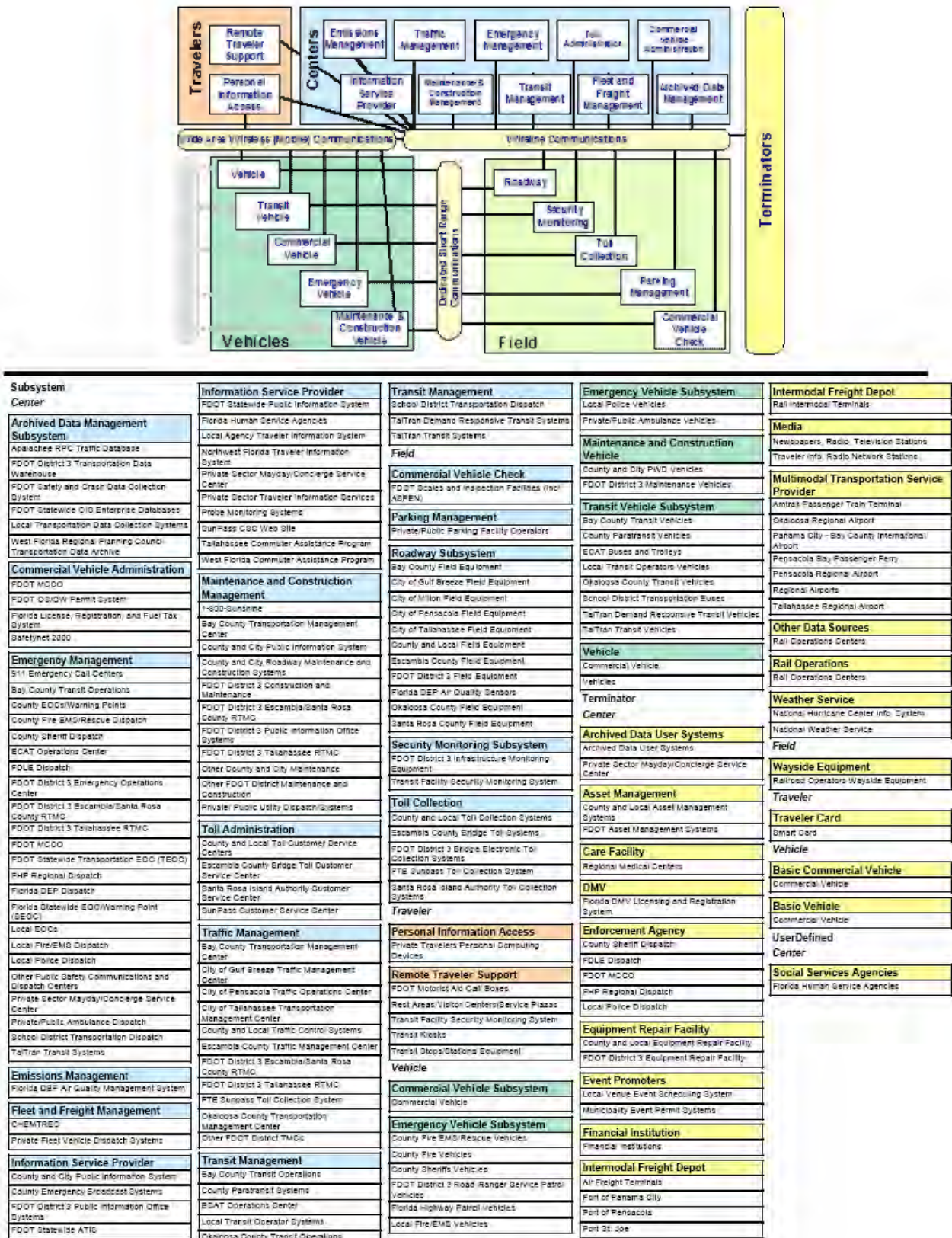

Figure 8: Florida DOT District 3, Extended Subsystem Diagram

**STEP #2: GATHER DATA - Needs and Services**

<p><i>These tasks may be performed in parallel.</i></p>	<ul style="list-style-type: none"> <li>• Define Inventory</li> <li>• <b>Determine Needs and Services</b></li> <li>• Develop Operational Concept</li> <li>• Define Functional Requirements</li> </ul>
<p><b>OBJECTIVES</b></p>	<ul style="list-style-type: none"> <li>• <i>Identify regional needs and determine the ITS services that should be implemented to address those needs.</i></li> <li>• <i>Build consensus on regional needs and service priorities.</i></li> </ul>
<p><b>PROCESS</b> <i>Key Activities</i></p>	<p><u>Prepare</u></p> <ul style="list-style-type: none"> <li>• Review regional needs and ITS services data that may be documented in ITS Plans (e.g., EDPs), ITS studies, transportation plans, ITS Project documentation, etc.)</li> <li>• Collect needs from key stakeholders including operators, maintainers, and users of the transportation system.</li> </ul> <p><u>Document Needs and Services</u></p> <ul style="list-style-type: none"> <li>• Document regional needs</li> <li>• Identify candidate services that will address those needs.</li> <li>• Schedule and conduct reviews to review the needs and candidate services</li> <li>• Document the needs and services for the region.</li> <li>• Associate services with each element in the ITS inventory.</li> </ul> <p><u>Building Consensus</u></p> <ul style="list-style-type: none"> <li>• Build consensus on needs and services for the region.</li> <li>• Focus discussions on those services that require group buy-in.</li> </ul>
<p><b>INPUT</b> <i>Sources of Information</i></p>	<ul style="list-style-type: none"> <li>• Stakeholders</li> <li>• Planning Studies (e.g., transportation plans, ITS Early Deployment Plans, other ITS plans, etc.)</li> <li>• TIP, STIP, SIP, Congestion Management Plan, Commercial Vehicle Safety Plan, etc.</li> </ul>
<p><b>OUTPUT</b> <i>Results of Process</i></p>	<ul style="list-style-type: none"> <li>• Documented regional needs and ITS service priorities</li> <li>• The association between specific ITS services and supporting ITS elements in the region.</li> </ul>

## 4.2 Determine Needs and Services

In the previous step, an inventory of the existing and planned ITS elements in the region was developed. In this step, the ITS services that should be provided by these elements to address regional needs are identified. This is the first step in determining what the ITS elements should do tomorrow that they do not do today. It provides each agency an opportunity to look at the region's transportation system from the highest level and confirm that their goals and desires are consistent with the rest of the transportation community.



An understanding of the regional needs and ITS services supports development of interface requirements and information exchanges with planned and existing ITS elements as required in FHWA Rule 940.9(d)6 and FTA National ITS Architecture Policy Section 5.d.6.

### 4.2.1 Needs and Services Definition Process

#### Identify Needs

Before ITS services can be prioritized for the region, the problems with the regional transportation system and the associated needs of the operators, maintainers, and users of the system must be understood. In many cases, regional needs will already be documented in one or more existing plans or studies. Even when they are not formally documented in one place, the operators, maintainers, and users of the system generally understand the region's needs. Needs are identified by collecting this information from existing documents and supplementing this information with stakeholder input.

Both ITS plans and traditional transportation plans should be reviewed for needs and services information. Transportation long range plans typically discuss economic and social trends and how the infrastructure should be built to meet the region's needs. Many of these long term policies and goals are directly related to the needs and services that guide a regional ITS architecture. For example, if major new facilities are planned for the region, then it is appropriate to plan to add ITS services into those new facilities. If the region is making major investments in enhancing transit service, these enhanced services should be reflected in the regional ITS architecture.

The needs collected from this documentation review can then be reviewed and refined with key stakeholders in the region. It is best to start with a candidate list of needs when gathering stakeholder input. If a set of needs for the region has not been documented, a representative list of candidate needs can be used to start the discussion. Based on stakeholder input, the region's



needs are documented before (or sometimes at the same time that) ITS services are considered. Ideally, needs are developed prior to developing ITS services, but in some practical scenarios, an iterative process is followed. As needs are better understood by stakeholders through discussion of ITS services, stakeholders can then more precisely document their needs.



It is common to find transportation solutions embedded in lists of regional transportation needs. When identifying needs, it is important to help stakeholders to define their needs in terms of problems that need to be solved (e.g., “Improve security around key transportation infrastructure”) rather than as specific solutions (e.g., “Install CCTV cameras and a 24/7 monitoring center”). The solutions are developed through the architecture development and project systems engineering analysis steps that follow. It is important not to jump to a solution prematurely at this early step in the analysis.

### **Determine Services – User Services and Market Packages**

ITS services are the things that can be done to improve the efficiency, safety, and convenience of the regional transportation system through better information, advanced systems and new technologies. ITS services are prioritized for the region based on the documented regional needs.

The first task is to determine the initial list of ITS services that will be reviewed and prioritized for the region. ITS services can be described in a variety of ways – the most common lists of ITS services are the “User Services” and “market packages”.

Thirty-three *User Services* covering a wide breadth of surface transportation needs have been defined. User services are generally a technology neutral and architecture neutral statement of services. User services identify what a regional intelligent transportation system must do, but do not say how functions will be allocated to ITS elements or how ITS elements will communicate with each other to address those needs. This is in direct contrast to *Market Packages*.

Market packages have been used as the initial list of ITS services by many regional ITS architectures. Market packages provide a service-oriented view of the National ITS Architecture that identify the pieces of the architecture that are required to implement a particular service. There are a few compelling reasons to use market packages to identify services:

1. They are well documented, including high-level graphics, brief descriptions, and detailed definitions based on the National ITS Architecture physical architecture.

2. They offer more granularity than User Services, allowing more precise service choices to be made.
3. Turbo Architecture uses market packages, so the transition to Turbo Architecture is much easier if market packages are used.



While market packages are a good place to start, it would be a mistake to limit the ITS service choices to the list of predefined market packages since some services that are important to the region may not be defined in the National ITS Architecture market packages. For example, in the Greater Yellowstone regional ITS architecture development, new market packages were developed for six additional rural ITS services that were important to the Yellowstone region but not represented in the National ITS Architecture at the time that this regional ITS architecture was developed (e.g., Animal-Vehicle Collision Counter Measures). Other regions have added services like red light enforcement, flood monitoring, and over-dimension vehicle permitting coordination to the services identified by the National ITS Architecture.

Beginning with a list of market packages or an alternative list of ITS services, services should be identified that:

1. Are currently provided by the ITS elements in the region,
2. Will be provided once planned projects are implemented, or
3. Address regional needs and may be implemented in the future.

Stakeholder input on each of these choices should be actively solicited, preferably in a direct forum like a brainstorming session or workshop. Remember that the focus for this task is on identifying the important ITS services; avoid getting bogged down in the specifics of how those services will be provided in this process step.



To make best use of stakeholder representative time, focus group discussion on ITS services that require group buy-in. ITS services that can be implemented by a single agency require less discussion than ITS services that require integration between different stakeholders' ITS elements. For example, the decision to deploy a Surface Street Control service is an individual decision for a particular traffic agency, and may not be a priority for group discussion. In contrast, the decision to deploy Transit Signal Priority requires consensus by traffic and transit agencies and should be agreed to by all parties. Individual agency service choices can be coordinated offline if time is short.

It is usually appropriate to focus the discussion on services that have public sector involvement. Market packages that are exclusively private sector with no public sector interfaces (e.g., some autonomous vehicle safety and guidance market packages) can generally be excluded.

Every ITS service selected for the region should be associated with one or more inventory elements that supports or will support that service. Each of these associations should be reviewed and approved by stakeholders associated with the regional ITS elements. This association between ITS services and ITS stakeholders will be the starting point for operational concepts, which will be defined in the next process task.

#### 4.2.2 Tools and Resources



Many different resources discuss “needs” in the context of ITS and surface transportation planning. One such source is “Integrating Intelligent Transportation Systems within the Transportation Planning Process” (EDL #3903, [http://www.itsdocs.fhwa.dot.gov/JPODOCS/REPTS\\_TE/30F01!.PDF](http://www.itsdocs.fhwa.dot.gov/JPODOCS/REPTS_TE/30F01!.PDF)) This document discusses the relationship between transportation goals, problems, and needs. Other resources provide detailed information on the benefits of ITS that can be used to determine the ITS services that will address regional needs. The Program Assessment Section of the ITS Joint Program Office Website is a good place to start your search for benefits information (<http://www.benefitcost.its.dot.gov/>).



Both market packages and user services provide a service-oriented view of ITS that can be used to support ITS service selection and definition. Both are included in the National ITS Architecture documentation. The “User Services Document” can be found on the National ITS Architecture website at <http://www.iteris.com/itsarch/html/menu/documents.htm>. Market Packages are also documented on the National ITS Architecture website (<http://www.iteris.com/itsarch/html/mp/mpindex.htm>), that provides wealth of information that can support market package selection including tables that relate market packages to transportation problems and solutions, ITS Goals, and user services. Each market package includes a market package graphic, one or more transaction set diagrams, a description, and a detailed listing of the subsystems, terminators, equipment packages, and architecture flows that are included.



Turbo Architecture directly supports market package selection and association of ITS elements that support the market package. Multiple “market package instances” may be created when the same market package is implemented multiple times in the same region. Turbo uses these market package choices to generate an initial architecture based on the underlying National ITS Architecture definition for each market package. Turbo can also generate or export market package choice information consistent with the output guidelines provided below.

#### 4.2.3 Needs and Services Output

The output of this process step is a list of regional needs and the ITS services that will be implemented in the region.

## Needs

Needs should be documented completely, including a record of the agencies and/or areas(s) in the region that have the need. For example, specify “alleviate congestion in work zones, freeway interchanges, and CBD” rather than simply identifying “alleviate traffic congestion” as a regional need. This detail will be helpful when assigning ITS services to inventory elements.



Even more detail could be added at the discretion of the region (e.g., “alleviate recurring congestion on SB I-5 to SB SR-55 interchange during morning peak”), but remember that this additional detail will be subject to change and increase maintenance on the regional ITS architecture. This level of detail is not necessary for the regional ITS architecture where needs and services only have to be isolated to the agency or ITS element level. This level of detail would be necessary to support more detailed project definitions.

## ITS Services

This documentation identifies each ITS service that is, or will be implemented in the region. For example, if market packages are used, the output would identify each market package name, its status in the region (e.g., existing, planned, or not planned), a list of the regional elements that will implement the market package, and any special notes concerning tailoring or issues associated with the market package. Some regions have added a priority rating to the market package that reflects the stakeholders’ prioritization of the various service options.

### 4.2.4 Needs and Services Examples

An example of a list of needs (from the *Colorado DOT Region 4 ITS Plan, February 16, 2004*) in a region is shown in Figure 9. In general, the identified needs are scoped at a high and appropriate level, e.g., “improved management of road closures” or “ice detection and control”. This statement of needs is architecture neutral.



A few of the listed needs in this example (e.g., “Greater density of weather stations and pavement sensors”) specify a solution. One good technique for determining the underlying need when a stakeholder identifies a specific solution as a need is to ask the stakeholder “why” several times to better understand the underlying need. In this case, do the users want more weather stations to detect storm cells that cause localized flooding, predict icing and warn drivers, monitor snowfall and proactively manage snow removal, or to satisfy some other need? If you can identify and document the underlying transportation need, then all viable solutions can be considered in subsequent steps.

<p><b>Corridor Improvement Problems</b></p> <ul style="list-style-type: none"> <li>• Greater density of traffic count stations</li> <li>• Greater availability of vehicle detection data</li> <li>• Greater density of weather stations and pavement sensors</li> <li>• En-route traffic conditions information (DMS, HAR) along key corridors and in urban areas</li> <li>• Traffic cameras at key interchanges</li> <li>• Synchronized and interconnected traffic signals on state highways</li> <li>• Speed warnings at hazardous locations</li> <li>• Anti-icing systems at hazardous locations</li> <li>• Support for protection of key infrastructure</li> </ul>
<p><b>Advanced Public Transportation Systems Problems</b></p> <ul style="list-style-type: none"> <li>• Electronic fare coordination between agencies</li> <li>• Multi-modal coordination with other transit agencies</li> <li>• Online trip planning services</li> <li>• Transit Signal Priority</li> <li>• Fee collection management at parking facilities</li> <li>• Traffic, incident and weather conditions data from other transportation agencies</li> </ul>
<p><b>Safety and Incident Management Problems</b></p> <ul style="list-style-type: none"> <li>• Improved highway-rail intersection safety</li> <li>• Regional incident management planning and routing</li> <li>• Improved management of road closures</li> </ul>
<p><b>Parking Management Problems</b></p> <ul style="list-style-type: none"> <li>• Parking management system in Estes Park</li> </ul>
<p><b>Center-to-Center Communications Problems</b></p> <ul style="list-style-type: none"> <li>• Improved data sharing between agencies</li> <li>• Communications infrastructure plan to accommodate ITS systems</li> </ul>
<p><b>Traveler Information Problems</b></p> <ul style="list-style-type: none"> <li>• Increased dissemination of congestion information, incident information, construction and roadway closures information</li> </ul>
<p><b>Emergency Management Problems</b></p> <ul style="list-style-type: none"> <li>• Routing for emergency vehicles during congestion, incidents, and around train blockages</li> <li>• Protective measures for critical infrastructure</li> </ul>
<p><b>Maintenance and Construction Management Problems</b></p> <ul style="list-style-type: none"> <li>• Construction zone management and routing</li> <li>• Ice detection and control</li> <li>• Improved tracking and data collection from maintenance and emergency vehicles</li> </ul>
<p><b>Archived Data Management Problems</b></p> <ul style="list-style-type: none"> <li>• Improved ease of access to interagency transportation data</li> </ul>

**Figure 9: Example list of Regional Needs**

The same regional ITS architecture that had the list of needs shown in Figure 9, also selected market packages against the user needs; some of the selected market packages (for the ATMS related needs) are shown in Figure 10.

Market Package Name	Brief Description
<i>Network Surveillance</i>	Collects information from field devices (detectors, CCTV, etc.) for monitoring of roadway conditions.
<i>Surface Street Control</i>	Provide traffic signal control.
<i>Freeway Control</i>	Control of devices installed along freeways, including control of cameras and dynamic message signs.
<i>HOV Lane Management</i>	Manages HOV lanes by coordinating freeway ramp meters and connector signals with HOV lane usage signals.
<i>Traffic Information Dissemination</i>	Supports Dynamic Message Signs and Highway Advisory Radio.
<i>Regional Traffic Control</i>	Provides for the sharing of traffic information and control among traffic management centers to support a regional control strategy.
<i>Incident Management System</i>	Detects incidents and provides links between transportation and emergency management centers to exchange information.
<i>Traffic Forecast and Demand Management</i>	Use of historical traffic data to predict future demand.
<i>Electronic Toll Collection</i>	Use of electronic "tags" to collect tolls and process violations without requiring motorists to stop.
<i>Emissions Monitoring and Management</i>	Monitors individual vehicle emissions and provides general air quality monitoring using distributed sensors to collect the data.
<i>Standard Railroad Grade Crossing</i>	Manages highway traffic at highway-rail intersections where rail operational speeds are less than 80 miles per hour.
<i>Railroad Operations Coordination</i>	Provides an information link between rail operations and traffic management centers and emergency dispatch.
<i>Parking Facility Management</i>	Provides monitoring and management of parking facilities.
<i>Regional Parking Management</i>	Supports coordination between parking facilities to enable regional parking management strategies.
<i>Speed Monitoring</i>	Monitors speeds of vehicles on roadways. DMS can then be used to post a safe speed reminder.
<i>Roadway Closure Management</i>	Support for remotely controlled gates or barriers that close off roads in unsafe conditions, plus camera surveillance and traveler information.

**Figure 10: ATMS Market Packages Identified to Support Needs**

Other regional ITS architectures include tables that document the ITS services using market package instances that were selected and customized for the region. In the Florida DOT District 3 Regional ITS Architecture, each ITS element in the region has a report that shows in which market package instances they participate. The report for the City of Gulf Breeze Field Equipment is shown in Figure 11. This report shows that this ITS element participates in six market package instances, including two instances of market package *ATMS01 – Network Surveillance*.



ITS Element: City of Gulf Breeze Field Equipment	
Description:	Represents the ITS field equipment operated by the City of Gulf Breeze, including traffic signals, vehicle detectors, CCTV cameras, dynamic message signs, etc., to control and monitor traffic.
Status:	Existing
Stakeholder:	City of Gulf Breeze
Mapping:	Roadway Subsystem
Interfaces:	<div data-bbox="212 625 496 800" style="border: 1px solid purple; padding: 5px; display: inline-block; text-align: center;"> <p><b>Context Diagram</b></p> </div> <a href="#">City of Gulf Breeze Traffic Management Center</a> <a href="#">ECAT Buses and Trolleys</a> <a href="#">FDOT District 3 Escambia/Santa Rosa County RTMC</a> <a href="#">Railroad Operators Wayside Equipment</a>
Market Packages:	<a href="#">APTS7 - Multi-modal Coordination</a> <a href="#">ATMS01 - Network Surveillance</a> <a href="#">ATMS01 - Network Surveillance</a> <a href="#">ATMS03 - Surface Street Control</a> <a href="#">ATMS06 - Traffic Information Dissemination</a> <a href="#">ATMS13 - Standard Railroad Grade Crossing</a>
Equipment Packages:	<a href="#">Roadway Basic Surveillance</a> <a href="#">Roadway Signal Controls</a> <a href="#">Roadway Signal Priority</a> <a href="#">Roadway Traffic Information Dissemination</a> <a href="#">Standard Rail Crossing</a>

**Figure 11: ITS Element Report with Market Package Instances**



**STEP #2: GATHER DATA - Operational Concept**

<p><i>These tasks may be performed in parallel.</i></p>	<ul style="list-style-type: none"> <li>• Define Inventory</li> <li>• Determine Needs and Services</li> <li>• <b>Develop Operational Concept</b></li> <li>• Define Functional Requirements</li> </ul>
<p><b>OBJECTIVES</b></p>	<ul style="list-style-type: none"> <li>• Identify current and future stakeholder roles and responsibilities in the implementation and operation of regional ITS elements.</li> <li>• Achieve buy-in on these roles/responsibilities, laying groundwork for future agency agreements.</li> </ul>
<p><b>PROCESS</b> <i>Key Activities</i></p>	<p><u>Prepare</u></p> <ul style="list-style-type: none"> <li>• Gather existing documents that identify responsibilities in multi-agency scenarios. For example, Incident Management Plans.</li> </ul> <p><u>Develop Operational Concept</u></p> <ul style="list-style-type: none"> <li>• Build on the ITS Inventory by identifying the agency, company, or institution that currently implements, operates, and maintains each inventory element that will support inter-agency or public/private interfaces. Augment the stakeholder list where necessary.</li> <li>• Develop several relevant operational scenarios that require cooperation among a broad array of stakeholders. Major incidents and special events are good scenarios that involve a majority of stakeholders.</li> <li>• Convene a meeting/workshop where stakeholders can walk through prepared scenarios and identify current roles and opportunities for enhanced cooperation/integration in the future.</li> <li>• Document each stakeholder’s current and future responsibilities in each scenario</li> <li>• Collect key findings into a high level Operational Concept</li> </ul> <p><u>Build Consensus</u></p> <ul style="list-style-type: none"> <li>• Issues will surface during operational concept development. Identify and document key issues that can’t be resolved.</li> </ul>
<p><b>INPUT</b> <i>Sources of Information</i></p>	<ul style="list-style-type: none"> <li>• Inventory and Needs and Services from previous task.</li> <li>• Any documents that identify roles and responsibilities</li> </ul>
<p><b>Output</b> <i>Results of Process</i></p>	<ul style="list-style-type: none"> <li>• Operational Concept documentation for the region.             <ul style="list-style-type: none"> <li>• Overview of How ITS services are Provided</li> <li>• Roles and Responsibilities</li> </ul> </li> </ul>

## 4.3 Develop Operational Concept

The inventory identifies the stakeholders that are associated with each ITS element in the region. In this step, each stakeholder's current and future roles and responsibilities in the operation of the regional services are defined in more detail. The operational concept documents these roles and responsibilities for selected transportation service areas relevant to the needs of the region, and optionally for specific operational scenarios. It provides an "executive summary" view of the way the region's stakeholders will work together to provide ITS services.



An operational concept that identifies the roles and responsibilities of participating agencies/stakeholders is one of the required components of a regional ITS architecture as identified in FHWA Rule 940.9(d)3 and FTA National ITS Architecture Policy Section 5.d.3.

### 4.3.1 Operational Concept Development Process

This is the process step where integration opportunities in the region are first documented, with particular focus on stakeholder involvement. The objective is not to formally define each ITS element or specify detailed integration requirements. This will come in later steps. The objective in this step is to identify current and future organizational roles in the regional transportation system. As with the other regional ITS architecture products, exactly how the operational concept information is gathered and expressed will vary from region to region.

The level of detail that is included in the operational concept will also vary from region to region. Some operational concepts will focus on a definition of each stakeholder's general role in providing the transportation services in the region. More detailed operational concepts may include a more detailed discussion of how stakeholders will interact to provide specific transportation services, possibly in specific scenarios. Stakeholder review and iteration is an important part of the process as initial concepts are expanded and refined.

Perhaps the most critical factor in the success of the Operational Concept process step is stakeholder involvement. The ultimate objective is not to create a table of roles and responsibilities, but to have the stakeholders suggest, review and tangibly buy in to these decisions so that they are owners of the operational concept. In later steps, these roles and responsibilities will form a basis for inter-agency agreements.

One of the significant challenges in developing an operational concept for a regional ITS architecture is the sheer scale and diversity of the systems and organizations that are included. It would be almost impossible to write a single contiguous operational concept that covers "a day in the life" of the regional surface transportation system.

One way to meet this challenge is to define several operational concept role and responsibility areas, each area covering a particular aspect of the transportation system. For example, a series of focused operational concepts could be developed that each address a particular ITS service.



In most cases, you will want to use the same structure in your operational concept that you used to determine services and needs for the region. For example, if market packages were used to prioritize services and needs, then operational concepts should be developed for the market packages that were identified as important to the region. A concise operational concept could be developed for each selected market package with emphasis on those market packages that require broad coordination across organizations. For example, “Incident Management” and “Regional Traffic Control” both require broad inter-agency coordination and may require more focus in the operational concept than a market package like “Network Surveillance”, since the latter has comparatively few inter-agency interfaces and a narrower focus.



A common source of frustration when discussing roles and responsibilities with stakeholders at this early stage is that the discussions can be too conceptual to really engage many people. To better engage stakeholders in the process, consider using real operational situations, or scenarios, to guide the discussion. For example, a large winter storm or hazardous material spill can provide vivid context to a discussion of the roles and responsibilities of stakeholders in the region. Create a scenario or scenarios that the stakeholders in the region are vitally interested in and then use the scenarios to encourage discussion and make the operational concept documentation more accessible.

One way to use a scenario-based approach is to organize a meeting where a facilitator walks key stakeholders through the events of a prepared scenario. At each step in the scenario, the facilitator works with the group to determine:

1. Current roles and responsibilities. For example, the state DOT currently faxes daily lane closure information to the counties, the major metropolitan city in the region, and the media.
2. What are the problems? For example, lane closure information tends to be very dynamic. Many agencies that could use the data don't receive it (e.g., emergency medical services).
3. What are the opportunities? For example, enhance coordination of longer-term closures between agencies. Collect closure information for the region in one place and make this available to all operating agencies as well as the traveling public.

The facilitator should be prepared for more “opportunities” to be identified than can be thoroughly addressed in real-time. A common approach is to list all the ideas and then prioritize a few to flesh out with an operational concept.

To finish the above example, the facilitator might follow up and determine who would implement and operate the proposed road closure information system, who would be its customers, and who would provide closure information to it.

A forum like this is a good opportunity to verify that the stakeholders are supportive and prepared for the changes that will occur if the operational concepts are implemented. A range of issues, mostly non-technical, will often arise during the development of an operational concept, and they should be documented and resolved if possible. Among many effective strategies for issue resolution, it is often worthwhile to select a facilitator who has no vested interest in the issue to help steer those involved towards a win-win solution.

### Security Considerations



From a security perspective, there are roles and responsibilities associated with making sure the security objectives are met. These roles and responsibilities can also be established as part of the operational concept, leveraging on organizations in the region that have specific interest and expertise in information security.

### 4.3.2 Operational Concept Resources and Tools



User Services are service-oriented descriptions of ITS which include some information that may be relevant to regional ITS architecture operational concepts. For example, the user service documentation includes a high-level operational concept for each user service. As discussed earlier, the National ITS Architecture User Services are documented in the “User Services Document” which can be found on the National ITS Architecture website (<http://www.iteris.com/itsarch/html/menu/documents.htm>).



The National ITS Architecture includes Market Packages, which can also be used as a basis for operational concept development. Basic market package information is accessible in hypertext format on the National ITS Architecture website. The National ITS Architecture documentation set also includes a “Theory of Operations” associated with each Market Package that describes in detail how transportation services are provided by the National ITS Architecture. This document is also a good resource for those developing operational concepts for a region, since the issuing of messages in response to receiving specific information inputs in the Theory of Operations can be the initial basis for stakeholder roles and responsibilities.



Finally, as discussed earlier, Turbo Architecture has an “Ops Concept” tab to aid the user in developing an operational concept based on the selected market packages and assignment of ITS elements to those market packages. Turbo will help the analyst to identify role and responsibility areas, select

stakeholders that have roles and responsibilities in each area, and write roles and responsibilities for each selected stakeholder.

### 4.3.3 Operational Concept Output

The operational concept for a regional ITS architecture identifies operational roles and responsibilities.



It is usually best to keep the operational concept at a fairly high level, assigning general roles and responsibilities to organizations rather than specific departments or individuals. If the operational concept is too detailed, it can actually hinder efforts since the more detailed data will be less certain and subject to change at this early stage. The more detailed concepts should be deferred until the implementation phase of a specific project.

#### Operational Roles and Responsibilities

One effective way to organize the operational roles and responsibilities is by ITS service – using either user services or market packages to structure the output. For each ITS service, the operational concept provides a general view of how the service will be performed in the region and each stakeholder's roles and responsibilities in providing that service. In addition, the major areas of coordination between stakeholders can be documented. This is helpful because it will support the interface definitions and institutional agreements that are identified in later steps.

When documenting the roles and responsibilities for each ITS service, it's important to realize that an ITS service can often be implemented in several different ways. For example, emergency vehicle signal preemption can be implemented in at least two ways:

- An emergency vehicle can directly preempt a signal using direct communications between the vehicle and equipment at the intersection.
- Alternatively, the dispatch center associated with the emergency vehicle can communicate with the traffic management center that controls the signal and request preemption on behalf of the vehicle. The traffic management center can then remotely preempt the signal.

While the first alternative has been around longer, the second alternative could be attractive to regions that already have AVL implemented in their emergency vehicles and have a closed-loop signal control system in place. The operational concept should explore alternative concepts like this example and document choices for the region. For example, an operational concept for emergency vehicle signal preemption might select the first alternative, and then identify the roles and responsibilities of the public safety and traffic management agencies that would participate in the service. Where a firm

choice cannot be made, several alternative concepts can be retained for future analysis.

### Implementation Roles and Responsibilities

This portion of the operational concept includes a clear identification of the implementation and maintenance responsibilities for each of the stakeholders in the region.



More detailed information can be provided where the ITS elements are shared and the lines of responsibility are more complicated. For example, roles and responsibilities could be documented in a *responsibility matrix* showing shared resources on one axis and stakeholders on the other. Each cell would identify the stakeholder's responsibility for the shared resource.

#### 4.3.4 Operational Concept Examples

Operational concepts can be documented in many different formats including textual descriptions, tables, and graphics. Each region is encouraged to review these examples and identify an approach that best meets their needs.

##### Example 1: Roles and Responsibilities using a simple table

The roles and responsibilities for stakeholders in the Vermont Statewide ITS Architecture are documented in a table, of which Table 4 is a partial view for one service, Incident Management. This operational concept documents the roles and responsibilities for transportation service areas, associated with high level user services. For each high level transportation service area, each relevant stakeholder is identified, and their specific operational roles and responsibilities are documented.



##### Example 2: Roles and Responsibilities using Turbo Architecture

The roles and responsibilities for the North Dakota Regional ITS Architecture were developed using Turbo Architecture. Figure 12 shows the Ops Concepts tab for this regional ITS architecture, with all the role and responsibility areas expanded, and with one stakeholder "NDDOT Operations" selected in one role and responsibility area "Freeway Management for ND Statewide". As can be seen on the right side of the figure, the analyst drafted two statements of roles and responsibilities for this stakeholder in this role and responsibility area. Table 5 shows the partial roles and responsibilities report derived from this Turbo Architecture database. Note that the third row of this table has the roles and responsibilities illustrated in Figure 12.



**Table 4: Vermont Statewide ITS Architecture Roles and Responsibilities**

Transportation Service	Stakeholder	Roles/ Responsibilities
Incident Management	Vtrans Operations Division	<ul style="list-style-type: none"> <li>Perform network surveillance for detection and verification of incidents</li> <li>Provide incident information to travelers via traffic information devices on expressways (e.g. DMS and Highway Advisory Radios-HAR)</li> <li>Enter incident information into CARS</li> <li>Provide maintenance resources for incident response and cleanup on state owned freeways and arterials.</li> <li>Coordinate maintenance resource response to incident with VSP and county public safety.</li> </ul>
	Vermont State Police	<ul style="list-style-type: none"> <li>Receive emergency calls from cell phones for incidents.</li> <li>Receive emergency calls from municipalities and unincorporated areas within jurisdiction of individual communications center.</li> <li>Dispatch State Patrol vehicles for incidents on freeways and state controlled arterials.</li> <li>Coordinate incident response with Vtrans, other state agencies, county sheriff and municipal public safety.</li> <li>Provide incident information to traffic and public safety agencies.</li> <li>Input incident information into CARS</li> </ul>
	Municipal Public Safety	<ul style="list-style-type: none"> <li>Receive landline emergency calls for incidents (for those municipalities with 9-1-1 centers)</li> <li>Perform incident detection and verification for arterial streets within municipalities in the region.</li> <li>Dispatch Police, Fire, and EMS to incidents within the municipalities.</li> <li>Coordinate incident response for incidents within the municipality.</li> </ul>
	Regional Public Safety	<ul style="list-style-type: none"> <li>Receive emergency calls for incidents within jurisdictions of 9-1-1 center.</li> <li>Dispatch Police, Fire, and EMS to incidents within the jurisdiction</li> <li>Coordinate maintenance resources in response to incident with municipal service departments.</li> <li>Provide incident information to traffic and other public safety agencies.</li> </ul>
	Municipal Engineering Departments	<ul style="list-style-type: none"> <li>Perform incident detection and verification for arterial streets in the municipality through video surveillance (future).</li> <li>Coordinate incident response with Municipal Public Safety (Police, Fire, and EMS).</li> <li>Operate Dynamic Message Signs on city arterials to inform travelers of incidents (future)</li> <li>Coordinate maintenance resources for incident response with Municipal Service Departments.</li> </ul>
	Municipal Service Departments	<ul style="list-style-type: none"> <li>Provide maintenance resources in response to incidents on municipal arterials</li> <li>Coordinate maintenance resources in response to incident with municipal and regional public safety.</li> </ul>
	CCTA/ GMTA/ Marble Valley	<ul style="list-style-type: none"> <li>Provide incident information (originating from vehicle operators) to regional and municipal public safety agencies.</li> </ul>

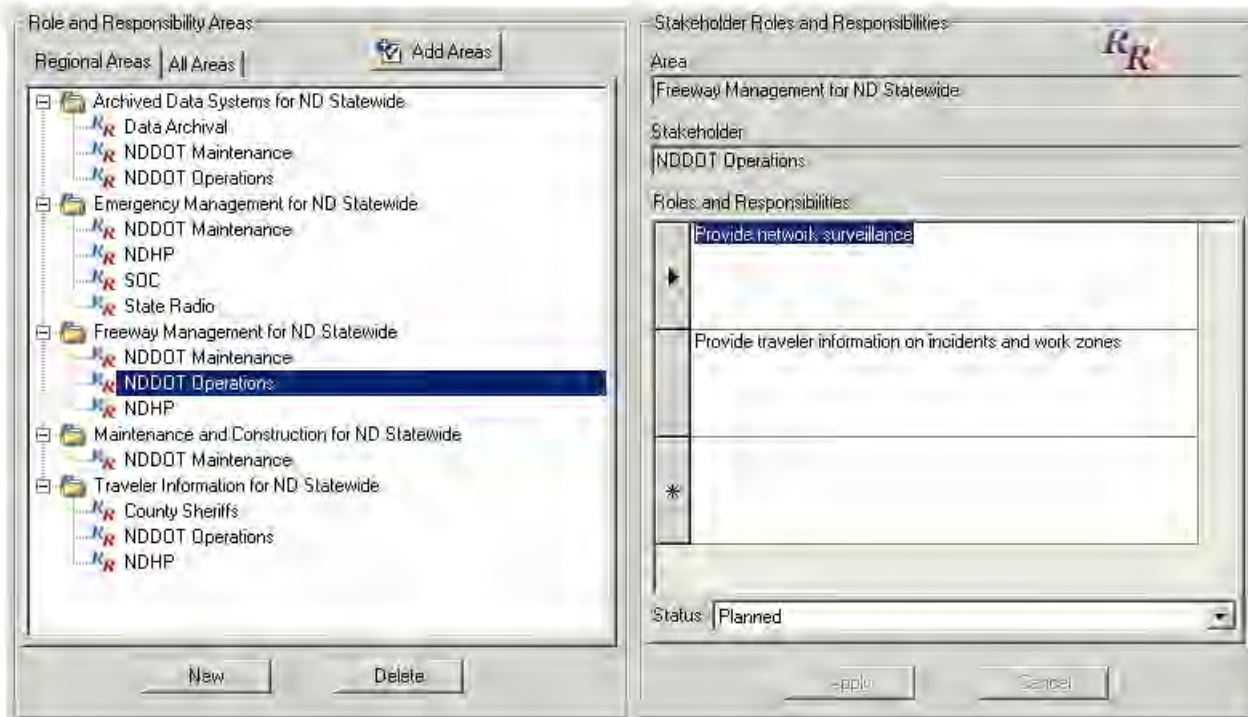

Figure 12: Roles and Responsibilities View in Turbo Architecture

Table 5: Roles and Responsibilities Output from Turbo Architecture

NDDOT Operations			
RR Area	RR Area Market Package	Roles and Responsibilities	Status
Archived Data Systems for ND Statewide	AD2: ITS Data Warehouse	a. Provide traffic data for archival	Planned
Freeway Management for ND Statewide	ATMS01: Network Surveillance ATMS06: Traffic Information Dissemination ATMS19: Speed Monitoring	a. Provide traveler information on incidents and work zones	Existing
		b. Provide network surveillance	Planned
Traveler Information for ND Statewide	ATIS1: Broadcast Traveler Information ATIS2: Interactive Traveler Information	a. Provide traveler information using ND 511, DMS, and NDDOT Traveler Information webpage	Existing

**STEP #2: GATHER DATA -Functional Requirements**

<p><i>These tasks may be performed in parallel.</i></p>	<ul style="list-style-type: none"> <li>• Define Inventory</li> <li>• Determine Needs and Services</li> <li>• Develop Operational Concept</li> <li>• <b>Define Functional Requirements</b></li> </ul>
<p><b>OBJECTIVES</b></p>	<ul style="list-style-type: none"> <li>• <i>Develop a high-level description of the required functionality for each ITS element in the inventory.</i></li> </ul>
<p><b>PROCESS</b> <i>Key Activities</i></p>	<ul style="list-style-type: none"> <li>• Determine the level of functional requirements specification that is appropriate for the region.</li> <li>• Identify the ITS elements that require functional requirements definition. ITS elements that are on the boundary of ITS (e.g., financial institutions) do not have to be functionally defined since they are not bound by (or even aware of) the regional ITS architecture.</li> <li>• Build on the ITS service choices and operational concept to define functional requirements, focusing on those with regional implications.</li> <li>• Use the National ITS Architecture (Subsystems, market packages, equipment packages and functional requirements) if desired to support the functional requirements development.</li> <li>• Using the information gathered in the previous steps, document the functions required to support the services the stakeholders decided to provide for the region.</li> </ul> <p><u>Building Consensus</u></p> <ul style="list-style-type: none"> <li>• Stakeholders should participate in the functional requirements development so that the functions are accurately defined and the stakeholders support the requirements that will be levied on their ITS elements.</li> </ul>
<p><b>INPUT</b> <i>Sources of Information</i></p>	<ul style="list-style-type: none"> <li>• Inventory, ITS services, and operational concept identified in previous steps.</li> <li>• Information exchanges defined in following steps if more detailed functional requirements are to be defined.</li> </ul>
<p><b>OUTPUT</b> <i>Results of Process</i></p>	<ul style="list-style-type: none"> <li>• Documented functional requirements for each ITS element in the inventory</li> </ul>

## 4.4 Define Functional Requirements

In this step, the tasks or activities (the “functions”) that are performed by each ITS elements in the region are defined, documenting the share of the work that each ITS elements will do to provide the ITS services. (Recall that ITS elements can be associated with one or more subsystems or terminators from the National ITS Architecture. Functional requirements are associated with the ITS elements that are associated with one or more subsystems. Terminators do not have functional requirements in a regional ITS architecture. When we refer to ITS elements in this section, we are referring to ITS elements that are associated with one or more National ITS Architecture subsystems.)



Functional requirements are one of the required components of a regional ITS architecture as identified in FHWA Rule 940.9(d)5 and FTA National ITS Architecture Policy Section 5.d.5.



Don't assume that the federal requirement for “system functional requirements” is an implied mandate to use structured analysis methods to develop each ITS element in the region. The functional requirements are high-level descriptions of what the ITS elements will do, not detailed design requirements. A region can choose to develop their ITS elements using object-oriented analysis, functional analysis, or whatever methodology they choose. The real objective of a regional ITS architecture is to clearly define interfaces and the responsibilities on both sides of the interface, and keep the implementation details (and methodology) used by any particular ITS element as transparent as possible.

### 4.4.1 Functional Requirements Process

Before writing the first functional requirement, determine the appropriate level of detail for the functional requirements. The level of detail is established for each regional ITS architecture based on the needs of the region. It's up to you!

While some regions may have unique objectives that demand more detailed specifications, very detailed functional requirements specifications within a regional ITS architecture can be counterproductive. Detailed specifications will increase the regional ITS architecture development and maintenance effort and they aren't really required until project definition begins. Unless there are special circumstances in your region, consider keeping the functional requirements specifications at a high level in the regional ITS architecture, and let the experts in the particular application area develop more detailed specifications when it is time to actually design and build projects.

In general, the functional requirements should be easy to write because they should follow directly from the ITS service decisions, operational concept, and interface choices made in other process steps. If many arbitrary decisions

are required to complete the functional requirements, there is probably excessive detail in the requirements.

To begin to zero in on the right level of detail, think about the motivation for writing the functional requirements in the first place. You are trying to specify the things that an ITS element must do in order to “hold up its end of the bargain” in the regional ITS architecture. Even if it is high-level, the specification must still be complete. That is, it must list all the things that the ITS element must do. Also, it shouldn’t list things that the ITS element is not required to do.

Let’s consider an example where the stakeholders have decided that the State DOT TMC will make CCTV camera images available to several different operational users in the region. An extremely high level specification for the State DOT TMC could be that the TMC “shall manage traffic”. This functional requirement is clearly too vague because it doesn’t tell the State DOT that it has to share CCTV camera images, and it may also imply that the State DOT should perform traffic management functions that were never intended. On the other extreme, the specification might go too far and start to identify performance requirements or specify technology. The functional requirements should only specify WHAT the ITS element has to do; they should not specify performance (how fast, how many) or how the ITS element will implement this capability. An appropriate set of functional requirements for this example might be:

- The State DOT TMC shall make CCTV camera images available to operational users (list here) and the media.
- The State DOT TMC shall provide the capability to selectively disable camera images, preventing their distribution to the media in special circumstances.
- The State DOT TMC shall selectively provide access to camera control (pan, tilt, zoom) to the operational users.



Tips

Another consideration is the scope or visibility of the requirements. Consider limiting the requirements to functions that have regional impact. Returning to the CCTV camera image example, the state DOT may also want to save camera images for a limited time for its own internal purposes and then discard them. This functionality does not have to be specified in the regional ITS architecture because it has no impact beyond the State DOT. If the State DOT does not implement this function, there will be no negative impact on the ITS integration for the region. Following this guideline, most of the functions that will be specified will focus on supporting interfaces between ITS elements.



Tips

As a rule of thumb, an ITS elements functional requirements and interface definition should be specified at about the same level of detail. For example, an ITS element that generates and receives 10 different information flows might include about the same number of functional requirements that describe the high-level functions that are performed to exchange this



information. As will be seen in Section 5, the architecture flows defined by the National ITS Architecture represent the typical level of detail used in regional ITS architecture interface definitions. For example, “incident information” is an architecture flow that is used in most regional ITS architectures. Since the architecture flow identifies incident information in general, the functional requirements should be at about the same level of detail and generally specify each ITS element’s responsibility for incident information sharing. The requirements need not specify more detailed functions (e.g., who will time stamp the incident, how will a measure of incident severity be assigned and modified) that deal with more detailed components of a particular information flow. To improve consistency in the level of detail between functional requirements and interface definition, the architect may iterate between the two process steps. This iteration is a normal part of the process.

Functional requirements do not have to be written for every element in the inventory. As discussed in section 4.1, an inventory will normally include elements on the boundary of ITS that don’t directly provide transportation services, but do exchange information with ITS elements. The classic example of an inventory element that is on the boundary is a financial institution that interfaces with ITS elements to support financial transactions. In general, a regional ITS architecture should include functions for ITS elements and should not include functions for ITS elements on the boundary.

An architectural boundary must be established to determine where functional requirements are needed. There are several ways to establish this boundary.

1. Perhaps the best approach is to consider whether each ITS element in the inventory will be implemented or enhanced with ITS projects implemented by the region’s stakeholders. ITS elements that are implemented or enhanced with ITS projects are inside the ITS boundary and should include functional requirements. This may be the most definitive criteria for a regional ITS architecture boundary since this reflects one of the best uses for functional requirements...they are a starting point for ITS project specification.
2. Is the ITS element in this region, or in another region that is subject to the requirements of another regional ITS architecture? ITS elements in other regions probably should not be functionally specified.
3. Consider the services that are provided by the ITS element. If the ITS element provides surface transportation-related services, then it is probably inside the architecture boundary and should be supported by functional requirements.
4. Review how the ITS element was mapped to the National ITS Architecture. ITS elements that map only to National ITS Architecture terminators may be on the boundary; ITS elements that map to National ITS Architecture subsystems may be inside the boundary and include functional requirements. This approach works as long as the regional ITS architecture boundary exactly coincides with the National ITS Architecture boundary, but this is sometimes not the case. Apply this rule only in conjunction with the above criteria.



## Security Considerations



In conjunction with functional requirements definition, security requirements can also be defined that identify security constraints and functions that will protect the confidentiality, integrity, and availability of the connected systems and the data that will pass between them. The initial security requirements will be iterated and refined in subsequent steps as the regional architecture is fully defined and implemented in stepwise fashion, project by project. In general, the security requirements included in the regional ITS architecture will focus on those requirements associated with system integration and sharing of data between systems. Each individual system will still have responsibility for protecting the systems and data within their own domain. These internal system requirements are normally not the focus of the regional ITS architecture.

### 4.4.2 Functional Requirements Resources and Tools



The National ITS Architecture is a good source for functional requirements that may be selectively used in a regional ITS architecture. The physical architecture includes general descriptions for each subsystem that provide an overall summary of what ITS elements do. At the next level of detail, equipment packages include more precise descriptions of the functionality required for each service that a subsystem supports. Each equipment package also includes a set of functional requirements that can be adopted as is or modified to meet the specific needs of the region. All levels of descriptions are linked in the hypertext architecture on the web site and CD, allowing easy navigation between the levels of detail. The National ITS Architecture is available on CD-ROM and on-line at <http://www.its.dot.gov/arch/index.htm>.



Turbo Architecture directly supports functional requirements specification based on the selection of market packages and allocation of ITS elements to those market packages. Turbo will help the analyst select “functional areas” for each ITS element that exactly correspond to National ITS Architecture equipment packages. For each functional area that is selected, a menu of functional requirements are presented that can be selected and/or modified, based on actual stakeholder needs.

### 4.4.3 Functional Requirements Outputs

High-level textual functional requirements can be prepared that describe WHAT each ITS element does to support the ITS services that have been selected for the region. The requirements are a list of “shall statements” that define each major function that is performed by the ITS element, focusing on those functions that have implications for regional integration..

#### 4.4.4 Functional Requirements Examples

This section presents two examples of functional requirements, one example based on using equipment package functional requirements without editing, and another that uses Turbo to customize the functional requirements.

##### Example 1: Functional Requirements directly from Market Package selected Equipment Packages

Earlier, in Figure 11, we observed the ITS Element Report for the Gulf Breeze Field Equipment ITS Element in the Florida DOT District 3 regional ITS architecture. Based on this ITS elements mapping as a Roadway Subsystem, and the market packages with which this ITS element is associated, the five Equipment Packages were selected in the bottom of this report. Each of these equipment packages then have a set of functional requirements associated with their own reports. See for example Figure 13 which shows the equipment package report for the first equipment package “Roadway Basic Surveillance”. This report shows the 5 functional requirements associated with this equipment package taken directly from the National ITS Architecture.

Equipment Package: Roadway Basic Surveillance	
Description:	This equipment package monitors traffic conditions using fixed equipment such as loop detectors and CCTV cameras.
Included In:	County and Local Field Equipment
Functional Requirements	<p>1 - The field element shall collect, process, digitize, and send traffic sensor data (speed, volume, and occupancy) to the center for further analysis and storage, under center control.</p> <p>2 - The field element shall collect, process, and send traffic images to the center for further analysis and distribution.</p> <p>3 - The field element shall collect, digitize, and send multimodal crossing and high occupancy vehicle (HOV) lane sensor data to the center for further analysis and storage.</p> <p>4 - The field element shall return sensor and CCTV system operational status to the controlling center.</p> <p>5 - The field element shall return sensor and CCTV system fault data to the controlling center for repair.</p>

**Figure 13: Equipment Package Report showing Functional Requirements**

##### Example 2: High-Level Functional Requirements using Turbo Architecture

In Figure 14, we are viewing the requirements tab in Turbo Architecture using the ND Statewide ITS Architecture. Here, functional areas have been automatically selected based on Market Packages and ITS elements that have been selected for some of the functional areas. In this example, the “Collect Traffic Surveillance” functional area has the “NDDOT Operations” ITS element selected. Highlighting the NDDOT Operations element and selecting the Requirements button brings up the screen in Figure 15, where the analyst can select from the menu of related functional requirements. In this example, the analyst has only chosen two of the nine possible functional requirements.

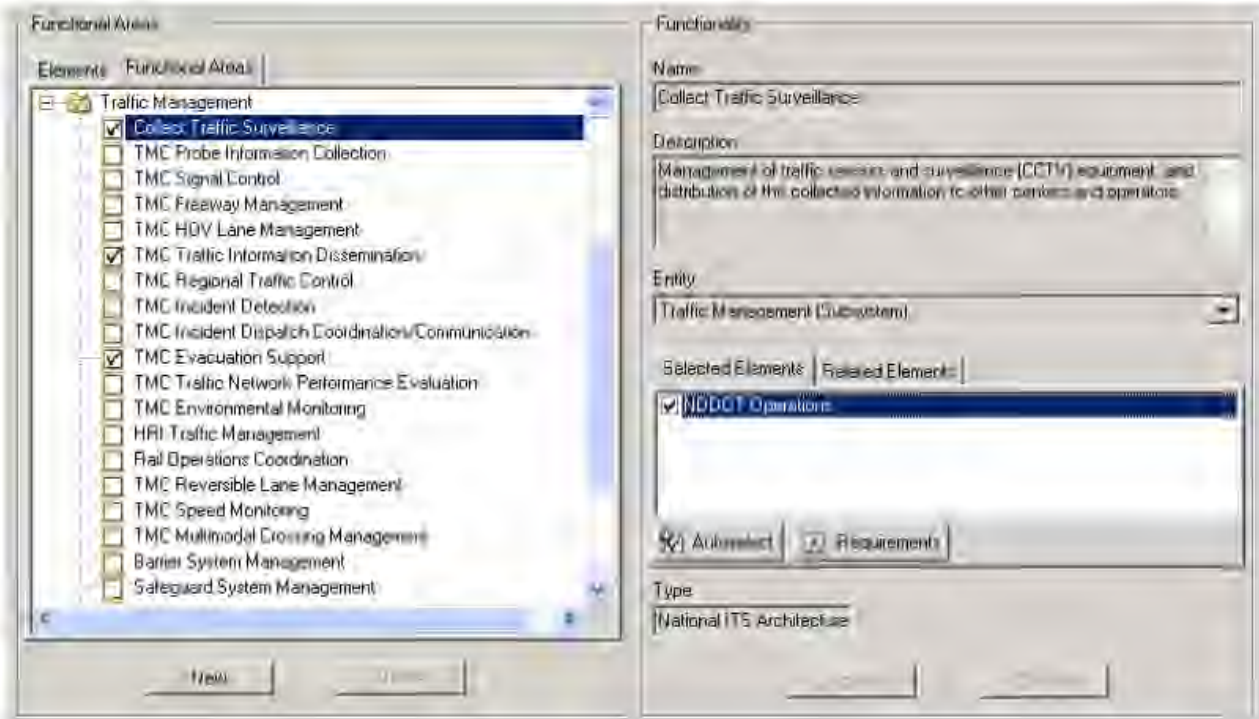

Figure 14: Functional Areas Selection in Turbo Architecture

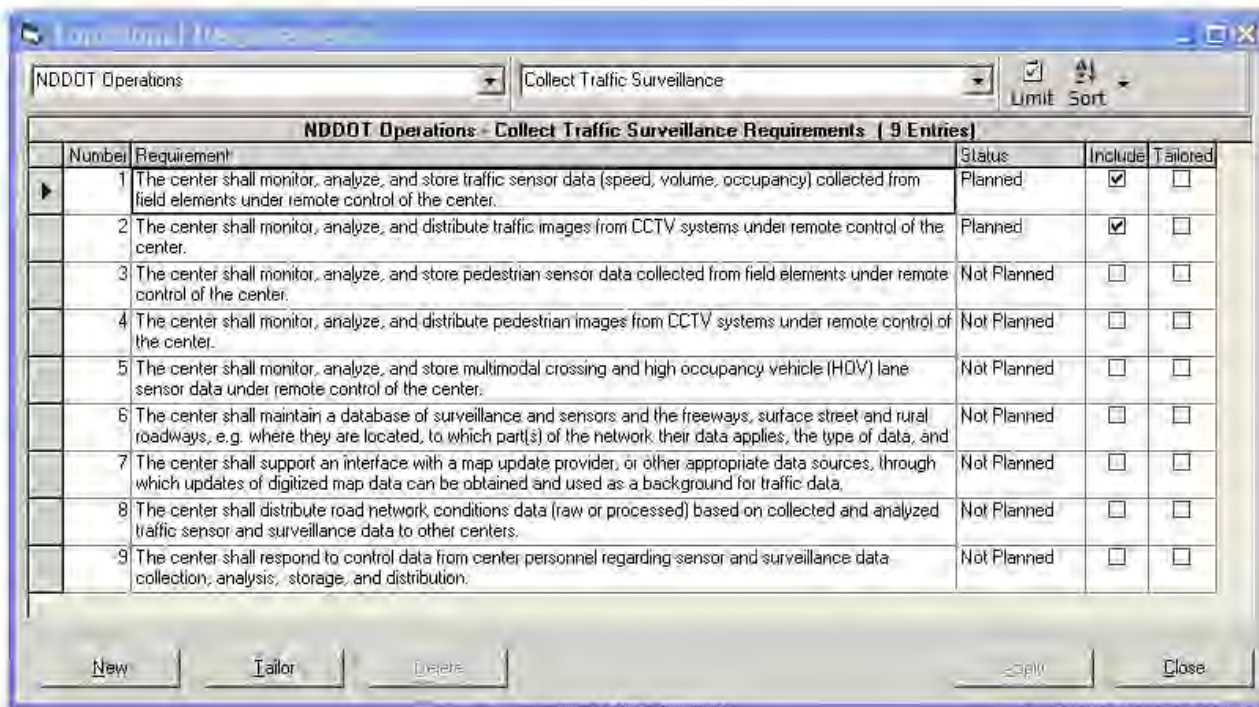

Figure 15: Functional Requirements Selection in Turbo Architecture

Finally, the fragment of the Functional Requirements report from the ND Statewide final report is shown in Figure 16. The selected functional requirements from Figure 15 are reported here.

<i>Element: NDDOT Operations:</i>		
<i>Entity: Traffic Management</i>		
<i>Functional Area: Collect Traffic Surveillance</i>		
Management of traffic sensors and surveillance (CCTV) equipment, and distribution of the collected information to other centers and operators.		
<i>Requirement:</i>	1 The center shall monitor, analyze, and store traffic sensor data (speed, volume, occupancy) collected from field elements under remote control of the center.	Planned
<i>Requirement:</i>	2 The center shall monitor, analyze, and distribute traffic images from CCTV systems under remote control of the center.	Planned

Figure 16: Turbo Architecture Functional Requirements Report (partial)

Section  
**5**

# Define Interfaces

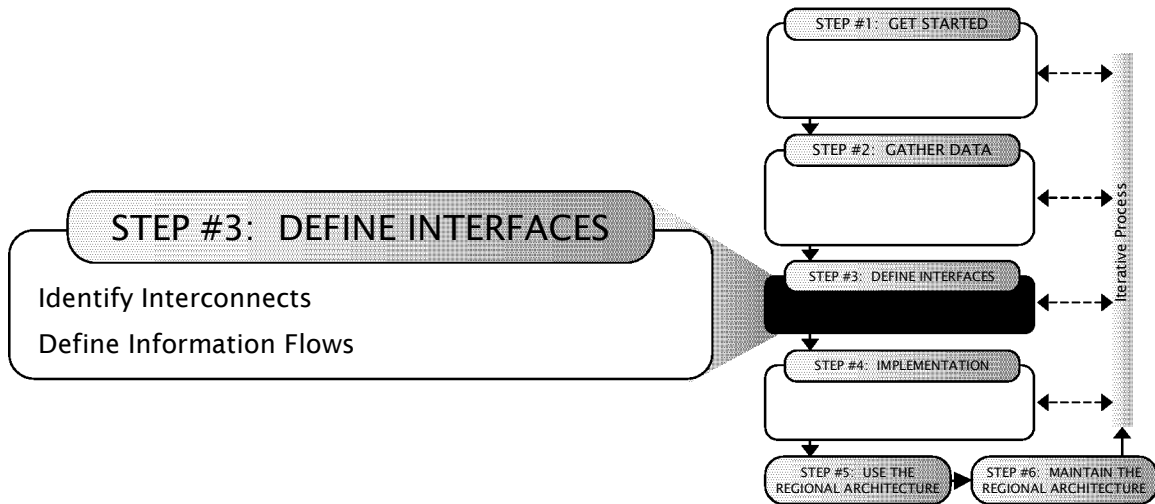

This section describes the “Define Interfaces” step in the regional ITS architecture development process.

At this point, the ITS elements in the region have been identified and defined in terms of the functions that they perform. In the “Define Interfaces” step, these elements are interconnected and the information that flows between the elements is defined. These interface definitions build on the general integration strategy that was described in the operational concept developed in the previous step.

In this section, the “Identify Interconnects” and “Define Information Flows” process tasks are described in detail. Each task description begins with a one page summary that is followed by additional detail on the process, relevant resources and tools, a general description of the associated outputs, and example outputs where they are available. Each task description also includes tips and cautionary advice that reflect lessons that have been learned in development of regional ITS architectures over the past several years.



### STEP #3: DEFINE INTERFACES -Interconnects

<p>These tasks may be performed in parallel or in sequence.</p>	<ul style="list-style-type: none"> <li>• <b>Identify Interconnects</b></li> <li>• Define Information Flows</li> </ul>
<p><b>OBJECTIVES</b></p>	<ul style="list-style-type: none"> <li>• Identify and document the existing and planned connections between ITS elements in the region.</li> <li>• Ensure the stakeholders associated with each interface agree with the connections that are identified.</li> </ul>
<p><b>PROCESS</b> <i>Key Activities</i></p>	<p><u>Prepare</u></p> <ul style="list-style-type: none"> <li>• Review existing connections between ITS elements</li> </ul> <p><u>Identify Connections</u></p> <ul style="list-style-type: none"> <li>• Based on the inventory, services, operational concept, and functional requirements, identify inventory elements that will exchange information.</li> <li>• Consider whether existing person-to-person connections may evolve into automated interfaces between ITS elements.</li> <li>• Document the high-level status for each connection (existing or planned).</li> <li>• Use the National ITS Architecture to identify potential connections; add custom connections as necessary.</li> </ul> <p><u>Build Consensus</u></p> <ul style="list-style-type: none"> <li>• Review connections and ensure stakeholders agree with the identified interfaces for their ITS elements.</li> <li>• Change connections and iterate until stakeholders are satisfied with the interconnections.</li> </ul>
<p><b>INPUT</b> <i>Sources of Information</i></p>	<ul style="list-style-type: none"> <li>• Stakeholders</li> <li>• Current regional communications or network architecture strategy, ITS Plans and Studies, TIP, STIP, SIP, etc.</li> <li>• Inventory of existing and planned ITS elements in the region (from Step #2).</li> <li>• Regional needs and services, operational concept, and functional requirements (from Step #2)</li> </ul>
<p><b>OUTPUT</b> <i>Results of Process</i></p>	<ul style="list-style-type: none"> <li>• List of existing and planned interconnects in the region.</li> </ul>



## 5.1 Identify Interconnects

This is one of the defining moments in the regional ITS architecture development process. The region's elements have been defined, the regional needs and services are understood, and an operational concept has identified the integration opportunities in the region in a broad sense. In this step, the connections between ITS elements are identified, creating a "framework for integration" that will support the exchange of information between ITS elements.



Interface requirements and information exchanges with planned and existing elements are a required component of the regional ITS architecture as identified in FHWA Rule 940.9(d)6 and FTA National ITS Architecture Policy Section 5.d.6.

### 5.1.1 Interconnect Process

The inventory, needs and services, operational concept, and functional requirements lay the groundwork for evaluation of which ITS elements should connect to each other. Based on this information and any documentation that may describe existing communications in the region, a preliminary set of connections can be identified.

All that is being identified at this point are connections or "interconnects" between ITS elements. The specific information that is exchanged on each interconnect is not defined until the next step in the process.



While this two-step "interconnects and then information flows" process for defining interfaces is not mandatory, experience shows that it is usually faster and easier to define interconnects first before specifying information exchanges. One reason to start with interconnects is that there are many more potential information exchanges than there are interconnects. The difference may be an order of magnitude – for example, 1000 potential interconnects vs. 10,000 potential information flows in a regional ITS architecture. Typically, only 20-30% (or approximately 200 to 300) of the valid interconnects will actually be selected for the region, effectively reducing the number of information flows that must be considered by 70-80%. Clearly, it is an iterative process, but use this Interconnect step to filter out all of the unwanted connections as early in the process as possible.

Note that an exception to starting with interconnects is when a regional ITS architecture is being maintained or updated. In this case, small revisions to the regional ITS architecture information flows based on corrections, revised stakeholder needs or updated status of information flows (e.g. from *planned* to *existing*) may be most efficiently made by going directly to the "define information flows" editing step. However, when completely new stakeholder

requirements or needs involve the addition of new ITS elements associated with new services or new connections between ITS elements that never shared information before, starting with the “identify interconnects” step may still be useful and effective.

Beginning with a preliminary set of interconnects, the stakeholders involved assess whether the interconnects would help support the needs and services of the region. Consider whether the connection exists today, or whether it is planned for the future. Often, a communications or network architecture is already in place between major “centers” in the region. Make sure the network can accommodate the connections identified in this step.



When most of the major stakeholders are present, concentrate primarily on evaluating the potential connections between centers, as those are most likely to cross agency or public/private boundaries. Since an agency typically owns its own center and respective roadside or vehicle assets, the connections to those items really require only the evaluation of the affected stakeholder, and not the stakeholder group at large. Consider handling these non center-to-center interconnections outside of general region-wide meetings.

Consider the existing connections between various stakeholder agencies, companies, or groups as the regional ITS architecture interconnects are defined. Many of these existing connections will be voice communications between people, either by telephone or face-to-face due to co-location of agencies such as public safety and traffic management agencies. There are two different schools of thought on how these interconnects between people should be shown in the regional ITS architecture:

1. Some regional ITS architectures only show the exchange of data between ITS elements. These architectures focus on technical integration of elements, so they do not include voice interfaces that have no potential for conversion to, or augmentation with, data communications between two elements. In this case, only voice connections between people that may someday be supplanted or supported by data connections between elements are shown in the architecture as planned interconnects.
2. In other regional ITS architectures, the stakeholders have decided to show existing voice communications between elements, even where those connections will not be replaced by, or supplemented with, data communications in the foreseeable future. These architectures document the institutional integration as well as the technical integration in the region.

Each region should decide how voice communications should be handled in the architecture. If voice-only connections are identified in the architecture, then they should be distinguished from the data connections to avoid confusion. When voice communications are identified that “will never be replaced with data communications”, the benefits of data communications can be discussed with the group – the speed, reliability, and ability to distribute data to many points are powerful motivations for augmenting voice communications with data communications on many interfaces over time.

### Security Considerations



The interfaces between ITS elements can pose security issues that should be identified prior to project implementation. Security boundaries and the interfaces to critical assets can be identified as part of the interconnect definition in the regional ITS architecture.

- *Security Boundaries:* Each ITS element may be governed by its own security policy – perhaps an overall policy for the organization or a specific policy for the system, or both. The interfaces between these ITS elements represent security boundaries between the different governing security policies that should be identified and addressed. Interfaces between secure and insecure systems should be identified.
- *Critical Assets:* In particular, the interfaces to any ITS element identified as critical should be partitioned to limit interfaces and permit only a deliberate flow of authorized information between the critical element and other ITS elements in the region. Security concerns may result in the reduction of architecture flows or interconnects to and from critical ITS elements in the regional ITS architectural framework.

### 5.1.2 Interconnect Tools



The National ITS Architecture identifies connections between architecture entities (subsystems and terminators). Since the ITS Inventory created in Step #2 included the mapping of each element to a National ITS Architecture entity, the framework of interconnects offered by the National ITS Architecture can serve as a starting point by identifying potential connections between each of those ITS elements. It is recommended that these connections be evaluated based on the services, or “market packages”, the region desires to support.



Turbo Architecture was designed to identify connections between ITS elements in the inventory that support selected services or “market packages”. Although the tool identifies all potential connections between ITS elements based on the National ITS Architecture, it pre-selects those connections required to support the desired services. The tool facilitates selection or elimination of connections during stakeholder meetings by providing customization tables with a checkbox for each potential connection.

Careful assignment of ITS elements to market packages assists Turbo Architecture in pre-selecting interconnects more accurately. In general, the more closely the market package matches the desired regional service, the better Turbo's interconnect pre-selection algorithms will work.

### 5.1.3 Interconnect Output

A regional ITS architecture set of interconnects is a collection of all existing and planned interconnects between ITS elements in the region. This output should include each pair of interconnected ITS elements, together with the high-level status of that interconnection (e.g., existing or planned). A brief description or assumptions may be added if desired.

Regional ITS architecture interconnects can be shown as a list of ITS element pairs, indicating those that are included in the regional architecture, or as a diagram that allows one to see the connections "at a glance". Since maintenance of the regional ITS architecture is important, it's advisable to select a form that is easily maintained.



A particularly useful means for displaying the interconnections is a diagram showing all of the connections between ITS elements in the region. For large inventories, this may prove too cumbersome to maintain and for these, consider including only "center" type ITS elements (Traffic Operations Center, Transit Operations Center, etc.) in the diagram.

A subset of the interconnect list can be presented as a diagram for each stakeholder, illustrating all of the connections between the stakeholder's element(s) and other ITS elements in the region. This has proven to be an invaluable explanatory tool for illustrating the benefits of creating a regional ITS architecture to agency or company executives.

### 5.1.4 Interconnect Examples

Regional ITS architecture interconnects have been published in a variety of tabular and graphical formats. The range of outputs that have been published reflect a spectrum of choices in the tradeoff between output legibility/accessibility and ease of development and maintenance. Custom diagrams are easy to understand, but somewhat difficult to develop and maintain. On the other end of the spectrum, a simple list of interconnects is easy to generate, but somewhat difficult to decipher for the uninitiated. The following examples illustrate the range of interconnect outputs that can be generated.

**Example 1: High-Level Interconnect Diagram**

Figure 17 shows an example high-level interconnect diagram for the Greater Yellowstone Rural ITS (GYRITS) Priority Corridor. The diagram presents the key interconnects in the region in an easy-to-understand format. A format like this is attractive and accessible to stakeholders, but it requires more development and maintenance effort than the computer-generated examples that follow.

As with all general presentations of interconnects, Figure 17 also may imply more connectivity than will actually be used in a region. For example, a reader might infer that “transit operations centers” can communicate with “emergency vehicle systems” because the “Trunked/Dedicated Radio Systems” communications is shown as a common wide area wireless resource for the region. Of course, the regional implementation will not include (and may actively preclude) this option. As long as care is taken in interpreting a high-level interconnect diagram, it can be one of the most useful top-level explanations of architecture connectivity.



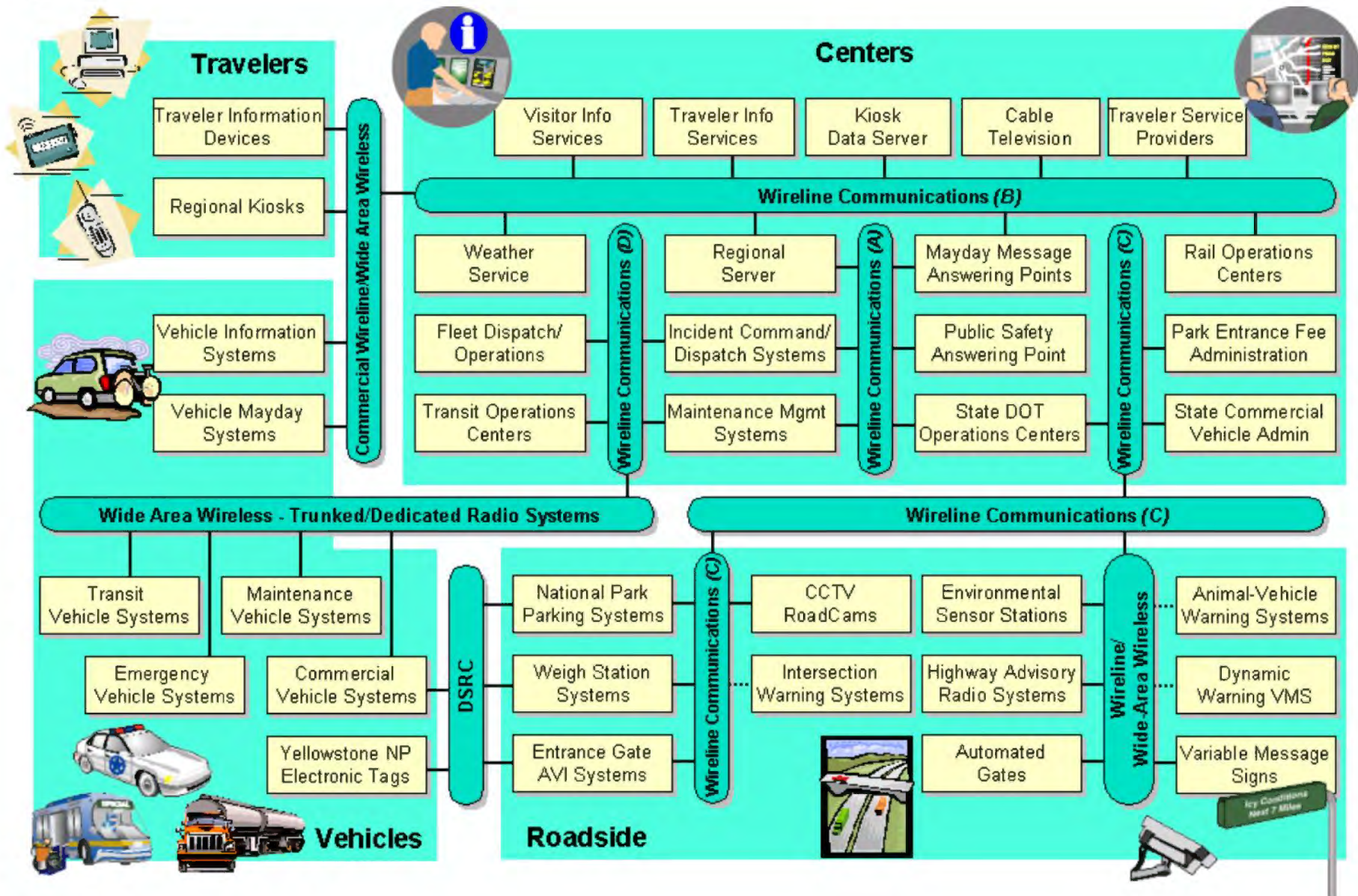

Figure 17: Greater Yellowstone Rural ITS Architecture Interconnect Diagram





**Table 6: Minnesota Statewide Architecture Metro TMC Interconnects**

Element	Element	Status
Broadcast Information Providers	Metro TMC	Existing
Data Center	Metro TMC	Planned
Division of Emergency Management Center	Metro TMC	Planned
Electrical Services Center	Metro TMC	Existing
Emergency Management Vehicle	Metro TMC	Existing
Event Promoters	Metro TMC	Existing
Inter-jurisdictional Traffic Management System	Metro TMC	Existing
Local Signal Center	Metro TMC	Planned
Maintenance Dispatch Center	Metro TMC	Existing
Metro TMC	Metro TMC_Roadside Equipment	Existing
Metro TMC	Metro Traffic Engineering Center	Existing
Metro TMC	National Weather Service	Existing
Metro TMC	Road Weather Information Center	Existing
Metro TMC	State Patrol Dispatch Centers	Planned
Metro TMC	TOCC	Existing
Metro TMC	Traveler Information Center	Planned

**STEP #3: DEFINE INTERFACES –Information Flows**

<p><i>These tasks may be performed in parallel or in sequence.</i></p>	<ul style="list-style-type: none"> <li>Identify Interconnects</li> <li><b>Define Information Flows</b></li> </ul>
<p><b>OBJECTIVES</b></p>	<ul style="list-style-type: none"> <li>Identify the information to be exchanged between elements.</li> <li>Verify that the stakeholders that provide and consume the information agree with the identified information exchanges.</li> </ul>
<p><b>PROCESS</b> <i>Key Activities</i></p>	<p><u>Define Information Flows</u></p> <ul style="list-style-type: none"> <li>Based on the interconnect decisions made by the stakeholders and the services, operational concept, and functional requirements created in Step #2, define the actual information content (information flows) exchanged on each interface.</li> <li>Document the high-level status for each information flow (existing or planned).</li> <li>Use the National ITS Architecture to identify potential information to be exchanged (termed “information flows”).</li> <li>Identify auxiliary information flows that are not defined in the National ITS Architecture, but are important to your region.</li> </ul> <p><u>Validate Operational Concepts and Functional Requirements</u></p> <ul style="list-style-type: none"> <li>While discussing the actual information to be exchanged, verify that assumptions made during creation of the initial operational concept and functional requirements remain valid.</li> </ul>
<p><b>INPUT</b> <i>Sources of Information</i></p>	<ul style="list-style-type: none"> <li>Stakeholders</li> <li>Interface Communications Documents (ICD) from all stakeholders’ elements, ITS Plans and Studies, project design documentation, etc.</li> <li>Regional services and needs, operational concept, and functional requirements (from Step #2)</li> <li>Interconnections (from Step #3)</li> </ul>
<p><b>OUTPUT</b> <i>Results of Process</i></p>	<ul style="list-style-type: none"> <li>Definition of Information to be exchanged between ITS elements in the region.</li> </ul>

## 5.2 Define Information Flows

Once stakeholders have agreed to exchange information between their respective ITS elements, the next step is to define the actual information that flows between the ITS elements in order to support the region's desired services.



Interface requirements and information exchanges with planned and existing systems is a required component of the regional ITS architecture as identified in FHWA Rule 940.9(d)6 and FTA National ITS Architecture Policy Section 5.d.6.

### 5.2.1 Information Flow Process

Now that the stakeholders have reached consensus on the interconnectivity of the ITS elements in the inventory, they must define the information that must be exchanged, given the services to be supported.

Each information flow is fully described by a source element (where the information originates), a destination element (where the information is sent) and a descriptive name for the information itself. The high-level status of the information flow (e.g., existing or planned) should also be documented.

In addition to the timeframe specified earlier in the process, stakeholders should discuss the criteria that will be used to make information flow status assignments. What is the status assignment if...

- the information flow will evolve from voice to data exchange in the desired timeframe?
- the design (including specification of ITS standards) is complete, but actual deployment has not begun?
- funding is already programmed (assured)?

Although each region can define their own criteria for flow status assignments, a reasonable approach is to consider whether the regional ITS architecture will have any impact on the information flows that are somewhere between "existing" and "planned" because implementation has started. For example, if the interface design is complete and ITS standards decisions have already been made, then the information flow may be considered to be "existing" with respect to the regional ITS architecture, even if the interface may not yet be operational. Following this criteria, information flows that can be influenced by the regional ITS architecture are designated as planned. Flows for interfaces that have already been designed are identified as existing. This approach has the added benefit of extending the "grace period" after the architecture is completed when the flow status will still be accurate



when compared to criteria that only consider whether the interface is operational.

For flows that do not exist, consider including gradations of “planned” flows. For example, “planned within 5 years”, “planned within 10 years”, and so forth.

It is often helpful to review the operational concept and services established earlier, and envision the possible scenarios in which information is exchanged. This exercise often brings to light any gaps in understanding the operational concept since it reconciles the information sent by the source ITS element with the information expected by the destination ITS element.



When most of the stakeholders are present, concentrate primarily on evaluating the information flows between centers, as those are most likely to cross agency or public/private boundaries. Since an agency typically owns its own center and respective roadside or vehicle assets, the information flows on those internal agency interfaces really require only the evaluation of the affected stakeholder, and not the stakeholder group at large. Consider handling these non center-to-center information flows outside the general meeting.

Many regions use “hubs” to tie centers together that share information. For example, all public safety agencies in a region might be connected to an “incident information and mutual aid” network. All information exchanges between the public safety agency elements would go through this hub, facilitating region-wide sharing of information between agencies.

In some regions, the stakeholders think of the hub as a key component of the regional transportation system and feel it is important to include the hub in the regional ITS architecture. Explicitly including hubs in the regional ITS architecture has an ancillary benefit in that architectures that include hubs normally have fewer connections and information flows to define and maintain than equivalent architectures that depict point to point connections between all elements served by a hub. Other regions may decide that a “hub” is really a part of the communications infrastructure implementation and therefore should not be reflected in the interfaces defined in the architecture. Both views are valid. The region’s stakeholders must decide which interpretation is best for their architecture.



There are a couple of factors to consider when deciding whether hubs should be included in the regional ITS architecture. One factor to consider is the functionality that the hub includes; a hub that implements ITS functions (e.g., data fusion) should probably be included in the regional ITS architecture while hubs that only implement communications functions (e.g., routing, protocol conversion, and data security) may be excluded at the stakeholders’

discretion. This brings us to the most important factor in making this decision: Meeting stakeholders' expectations for the architecture by making sure that it reflects the stakeholder's "natural" view of the elements in the region. If the hub is largely transparent to the transportation professionals and other stakeholders, then it probably should be transparent in the architecture. If it is viewed as an integral part of the overall regional system, then it should be included as an important part of the architecture.



When hubs are included in a regional ITS architecture, a few key points should be documented. First, clearly define the element as a hub and include the functions that it performs in the definition. Second, document any specific interconnectivity constraints (e.g., a given public safety agency can NOT talk to another public safety agency using the hub in the above example) so that these selective connectivity requirements are not masked by the broad general connectivity that is suggested by a hub.



### Security Considerations

As information flows are identified, they should be examined with respect to the security objectives. By evaluating each information flow against the objectives, the most sensitive information is identified that should be afforded special security protections when the systems are integrated. The National ITS Architecture includes a basic assessment of each information flow against three security objectives that can be used to support this process. In conjunction with the security objectives, specific threats associated with the information flows can be identified, using the general threat categories identified in the National ITS Architecture as a starting point for an analysis that identifies specific threats to information transfers between ITS elements in the region.



### 5.2.2 Information Flow Resources and Tools

The National ITS Architecture identifies information flows between architecture entities (subsystems and terminators). In the National ITS Architecture terminology, information flows are referred to as "architecture flows". Since the Inventory created in Step #2 of the regional ITS architecture development process included the mapping of each element to a National ITS Architecture entity, the framework of architecture flows offered by the National ITS Architecture can serve as a starting point by identifying information to be potentially exchanged between each of those ITS elements. It is recommended that these information flows be evaluated based on the market packages, or services, the region desires to support.

Where architecture flows from the National ITS Architecture are not adequate to reflect stakeholder requirements, create new stakeholder-defined architecture flows.





Turbo Architecture identifies potential information flows, just as it created interconnects for the previous process step. The tool will identify (but not necessarily select) all potential information flows between ITS elements based on the National ITS Architecture. Turbo Architecture will also select a set of information flows based upon the market packages selected. Careful assignment of ITS elements to market packages assists Turbo Architecture in selecting information flows more accurately. In general, the more closely the market packages match the desired regional service, the better Turbo's default information flow selection will be. The tool facilitates selection or elimination of information flows during stakeholder meetings by providing customization tables with a checkbox for each potential flow.

When market package instances are used and ITS elements are correctly associated with the market package instances, Turbo can be used to show the interconnects or information flows for one market package instance at a time, which greatly facilitates the "customization" of these market package instances. Market package instances can also be printed graphically one instance at a time, facilitating use of market package instances in regional ITS architecture development and maintenance.

### 5.2.3 Information Flow Output

A regional ITS architecture defines all existing and planned information flows between ITS elements in the region. The information flow output should include all connected source and destination ITS elements, a descriptive name for the information flowing between them, and a high-level status of that information flow (existing or planned). A brief description or assumptions may be added if desired.



The diagram formats that work well for interconnects generally also work well for information flows, except that the number of ITS elements shown in the diagram will need to be limited to ensure legibility. There is no one-size-fits-all formula for picking the elements that should go on a particular diagram. The key is to pick natural subsets of the regional ITS architecture that are of a manageable (and presentable) size and then generate diagrams for those subsets. There are three types of subsets of information flows that have proven to be most useful in recent regional ITS architecture work:

1. Show flows between all of a particular stakeholder's ITS elements, such as a Traffic Operations Center, Roadside Field Equipment, Traffic Report Website, and Operations Personnel.
2. Show flows between a given stakeholder's "center" element and all other elements in the regional inventory.
3. Show all flows between "center" elements in the inventory. Large or highly interconnected inventories should be broken down into small subsets so that the diagrams are legible.

### 5.2.4 Information Flow Examples

Information flows for a regional ITS architecture can be shown as a list of source, destination, and information flow “triplets” or as a diagram that shows the same information exchanges as directed flows. In developing information flow outputs, the developer is faced with a classic “ease of development” versus “ease of use” decision. Since regional ITS architectures include many information flows, it is important to make the outputs as easy to develop and maintain as possible. The trade-off is that more automated outputs (tables or auto-generated diagrams) may be more difficult to use, particularly for the uninitiated, than custom crafted diagrams. The appropriate output format should be decided by balancing these considerations against the available resources and the amount and type of use that is anticipated for each output.

#### **Example 1: Custom Information Flow “Context” Diagram**

Figure 19 is an example of an information flow diagram taken from the Delaware Valley Regional Planning Commission (DVPRC) regional ITS architecture. The diagram shows the PENNDOT District Traffic Control Center in the “context” of all the interfaces and information flows that it will support. The shapes each represent a National ITS Architecture entity (subsystems in squares, terminators in ovals), and the lines connecting them are labeled architecture flows; the DVPRC opted to identify high priority flows (solid lines) and medium priority flows (dashed lines). Note that once the inventory elements and information flows have been mapped to National ITS Architecture entities and architecture flows, the latter terminology is typically used; therefore, these “information flow diagrams” are often called “architecture flow diagrams”. This diagram represents an investment of some time to handcraft the connections and add color to make the diagram attractive and easy to understand.

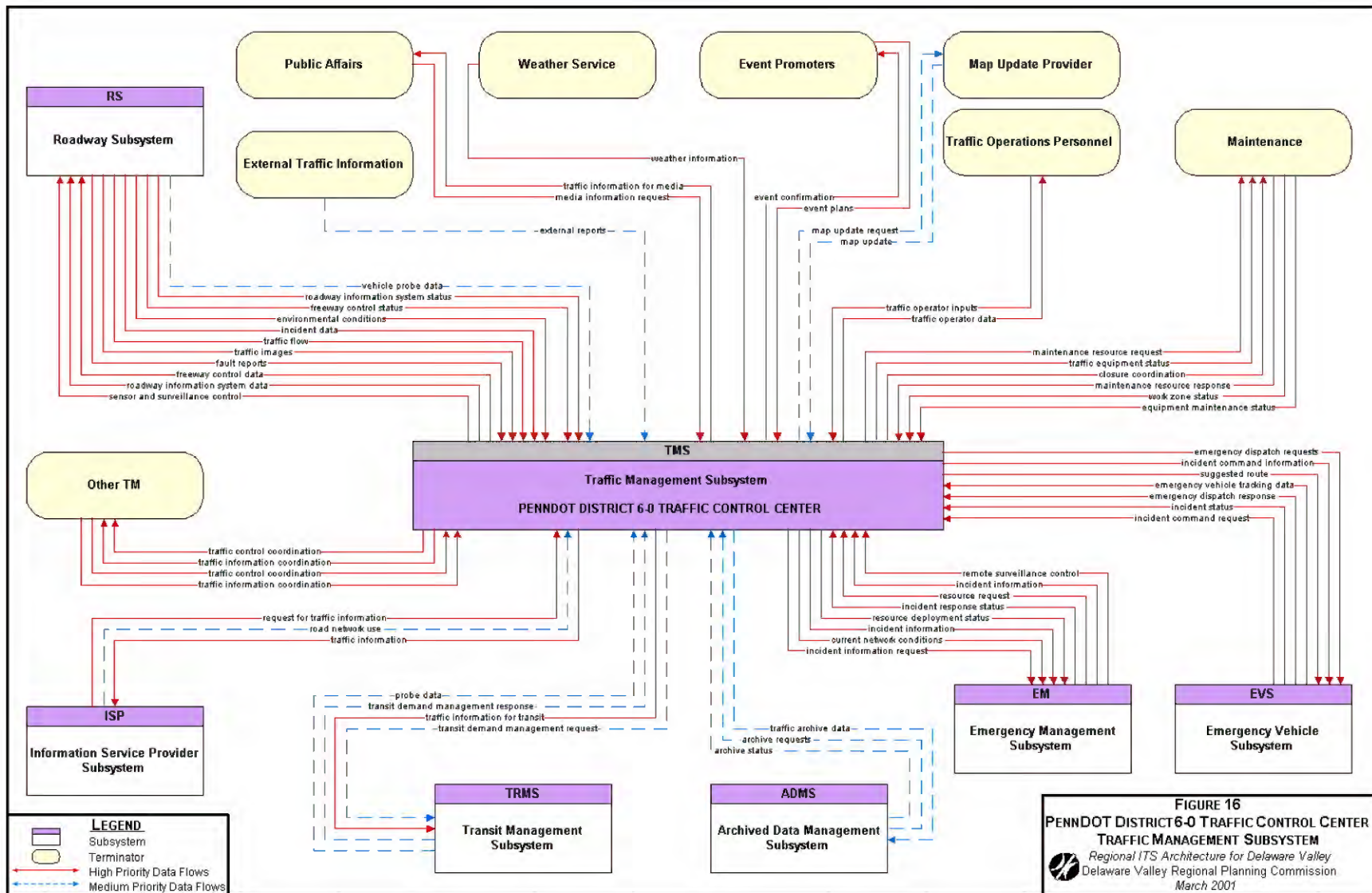
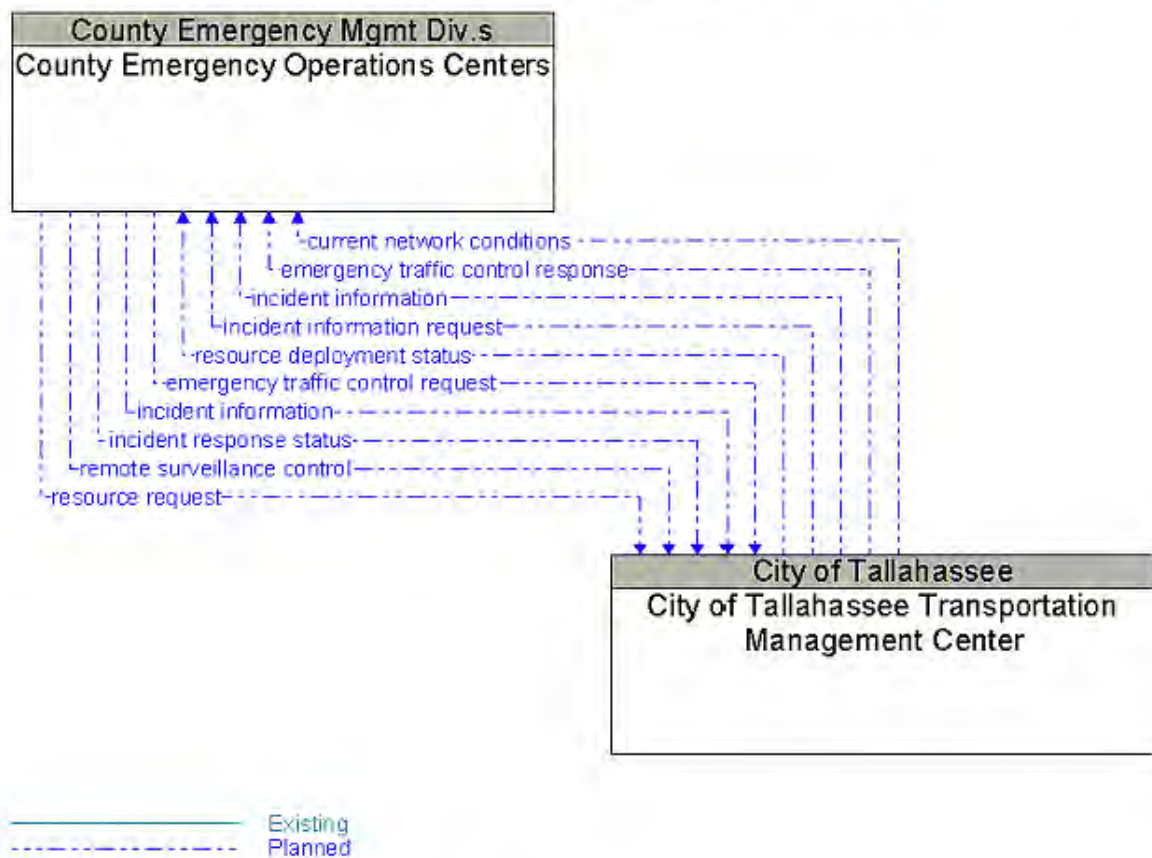

Figure 19: DVRPC Regional ITS Architecture Flow Diagram

**Example 2: Auto-Generated Interface Specification Diagram**

The example from the FDOT District 3 regional ITS architecture in Figure 20 shows the interface between the County Emergency Operations Centers and the City of Tallahassee Transportation Management Center. Note that each information flow is indicated as existing or planned using the solid/dashed line convention, and completely defined below the diagram as well. The diagram in this case is a standard Turbo Architecture diagram that can be automatically generated for any two elements in the Turbo inventory.

**City of Tallahassee Transportation Management Center  
TO County Emergency Operations Centers**



**Architecture Flow Definitions**

**current network conditions** (Planned)   
 Current traffic information, road conditions, and camera images that can be used to locate and verify reported incidents, and plan and implement an appropriate response.

**Figure 20: Example of an Information flow Diagram Interface Specification**

### Example 3: Tabular Presentation of Information Flows

Information flows can also be presented in a table, as shown in the example from the Minnesota Statewide Architecture in Table 7. The table shows the source, destination, information flow name, and flow status for information flows that will be received by the Metro TMC. The table also includes a flow description derived from the architecture flow descriptions in the National ITS Architecture. This table was generated from a Turbo Architecture database.

**Table 7: Minnesota Statewide Architecture Information Flows (Draft)**

Source	Flow Name	Flow Description	Destination	Status
Broadcast Information Providers	external reports	Traffic and incident information that is collected by the media through a variety of mechanisms (e.g., radio station call-in programs, air surveillance).	Metro TMC	Existing
Broadcast Information Providers	media information request	Request from the media for current transportation information.	Metro TMC	Existing
Data Center	archive coordination	Catalog data, meta data, published data, and other information exchanged between archives to support data synchronization and satisfy user data requests.	Metro TMC	Planned
Data Center	archive requests	A request to a data source for information on available data (i.e. "catalog") or a request that defines the data to be archived. The request can be a general subscription intended to initiate a continuous or regular data stream or a specific request intended to initiate a one-time response from the recipient.	Metro TMC	Planned
Data Center	archive status	Notification that data provided to an archive contains erroneous, missing, or suspicious data or verification that the data provided appears valid. If an error has been detected, the offending data and the nature of the potential problem are identified.	Metro TMC	Planned
Division of Emergency Management Center	incident response coordination	Incident response procedures, resource coordination, and current incident response status that are shared between allied response agencies to support a coordinated response to incidents. This flow also coordinates a positive hand off of responsibility for all or part of an incident response between agencies.	Metro TMC	Planned
Division of Emergency Management Center	incident response status	Status of the current incident response including traffic management strategies implemented at the site (e.g., closures, diversions, traffic signal control overrides).	Metro TMC	Planned
Electrical Services Center	work zone status	Status of maintenance work zone.	Metro TMC	Existing
Emergency Management Vehicle	emergency dispatch response	Request for additional emergency dispatch information (e.g., a suggested route) and provision of en-route status.	Metro TMC	Existing
Emergency Management Vehicle	emergency vehicle tracking data	The current location and operating status of the emergency vehicle.	Metro TMC	Planned
Emergency Management Vehicle	incident command request	Request for resources, commands for relay to other allied response agencies, and other requests that reflect local command of an evolving incident response.	Metro TMC	Existing



### Example 4: Market Package Instance Diagrams

An alternative method for identifying information flows between ITS elements is to use the National ITS Architecture market package diagrams and delete the undesired flows and add stakeholder-defined flows. This is a helpful approach when used in conjunction with the Operational Concepts because it places the information flows in the context of a service to be provided. Many market packages illustrate multiple architectural operational concepts to address a particular service, and therefore, the packages must be customized to illustrate only the option selected by the stakeholders. Figure 21 shows how Florida DOT District 3 customized the “ATMS18 – Road Weather Information System” market package by adding a Fog and Smoke Detection/Warning System and supporting architecture flows. Although these flows already existed elsewhere in the National ITS Architecture, they were not originally included in this market package.

Added Flow	Source	Destination
roadway information system status	District 3 Field Equipment	FDOT District 3/FHP Pensacola Transportation Management Center
roadway information system data	FDOT District 3//FHP Pensacola Transportation Management Center	District 3 Field Equipment
driver information	District 3 Field Equipment	Driver

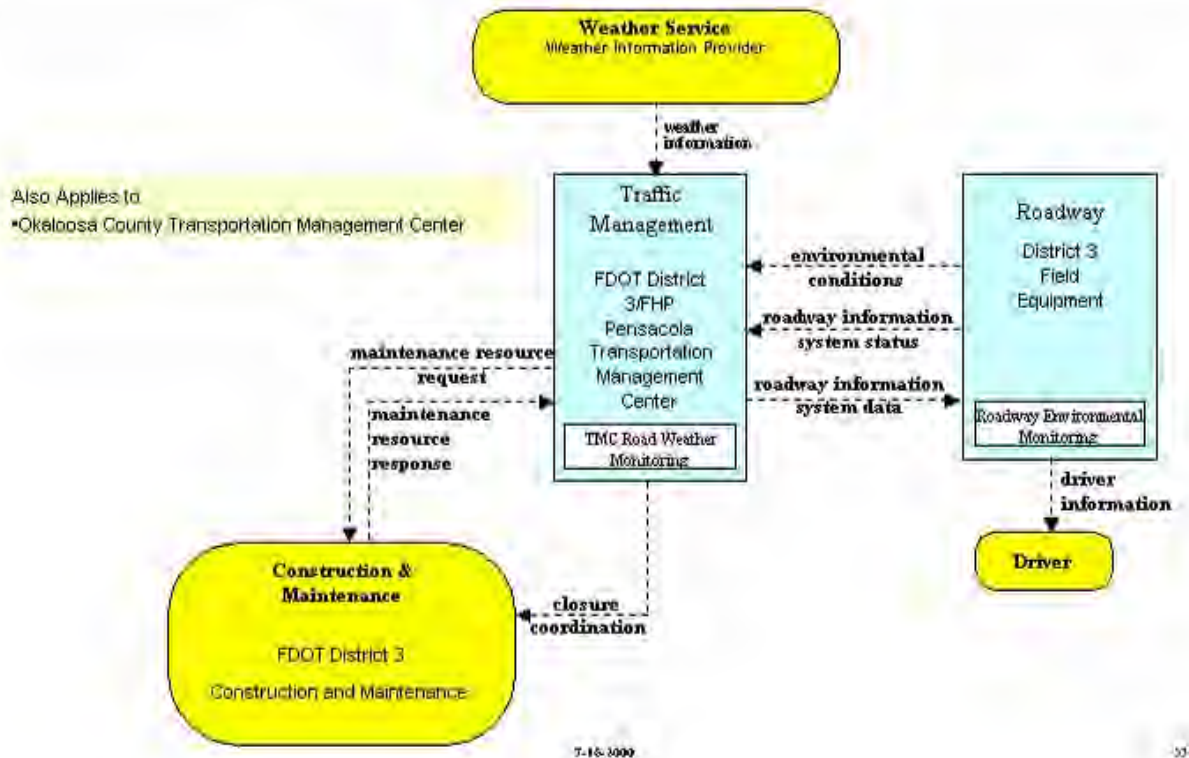
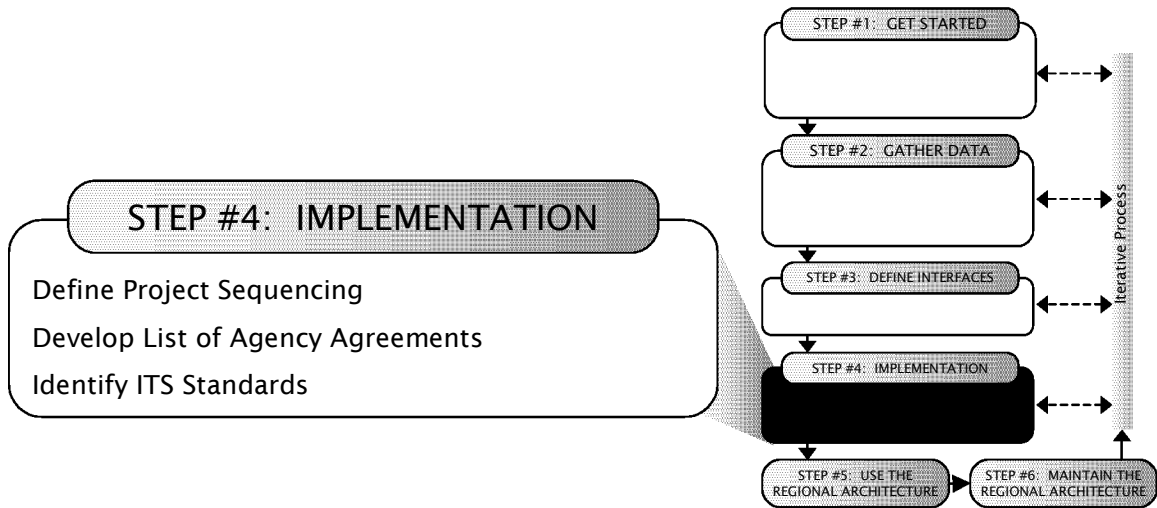

Figure 21: Information Flows in a Market Package Instance Diagram



Section  
**6**

# Implementation



This section describes the “Implementation” step in the regional ITS architecture development process.

In the “Implementation” step, the regional ITS architecture framework is used to define several additional products that will bridge the gap between regional ITS architecture and regional ITS implementation. These products define the series of staged projects, enabling agency agreements, and supporting ITS standards that will support progressive, efficient implementation of ITS in the region.

In this section, the three “Implementation” process tasks are described in more detail. Each task description begins with a one page summary that is followed by additional detail on the process, relevant resources and tools, a general description of the associated outputs, and example outputs. Each task description also includes tips and cautionary advice that reflect lessons that have been learned in development of regional ITS architectures over the past several years.

**STEP #4: IMPLEMENTATION -Project Sequencing**

<p><i>These tasks may be performed in parallel</i></p>	<ul style="list-style-type: none"> <li>• <b>Define Project Sequencing</b></li> <li>• Develop List of Agency Agreements</li> <li>• Identify ITS Standards</li> </ul>
<p><b>OBJECTIVES</b></p>	<ul style="list-style-type: none"> <li>• Create an efficient sequence of ITS projects based on regional needs and project readiness. Build consensus around the defined project sequence</li> </ul>
<p><b>PROCESS</b> <i>Key Activities</i></p>	<p><u>Define Project Sequence</u></p> <ul style="list-style-type: none"> <li>• Gather initial project sequence information from existing documents.</li> <li>• Define ITS projects for the region in terms of the regional ITS architecture. Define details of near term projects including identifying specific locations.</li> <li>• Evaluate each ITS project, considering:             <ul style="list-style-type: none"> <li>○ Costs and Benefits</li> <li>○ Technical Feasibility</li> <li>○ Institutional Issues</li> <li>○ Readiness (agreements in place, funding available...)</li> </ul> </li> <li>• Identify the dependencies between ITS projects based on the inventory, functional requirements, and interfaces. Identify projects that must be implemented before other projects can begin.</li> <li>• Develop an efficient project sequence that takes the feasibility, benefits, and dependencies of each project into account.</li> </ul> <p><u>Build Consensus</u></p> <ul style="list-style-type: none"> <li>• Similar to traditional planning, project sequencing is a consensus building process and should not be viewed as a ranking of projects. Stakeholders should begin with existing planning documents and focus on short, medium and long term planning decisions.</li> </ul>
<p><b>INPUT</b> <i>Sources of Information</i></p>	<ul style="list-style-type: none"> <li>• Documents: TIP, STIP, SIP, short-range stakeholder agency plans, the regional Long Range Plan, ITS Deployment (or Strategic or Master) Plans, Congestion Management Studies, and Regional Concept for Transportation Operations. ITS project dependency chart for the region or by agency if available.</li> </ul>
<p><b>OUTPUT</b> <i>Results of Process</i></p>	<ul style="list-style-type: none"> <li>• A documented sequence of projects, which can be used as input to the TIP, STIP, and other capital planning documents.</li> </ul>

## 6.1 Project Sequencing

The regional ITS architecture is “implemented” with many individual ITS projects and private sector initiatives that occur over years, or even decades. In this process step, a sequence, or ordering, of ITS projects that will contribute to the integrated regional transportation system depicted in the regional ITS architecture is defined.

One of the significant differences between ITS projects and conventional transportation projects is the degree to which information, facilities, and infrastructure can be shared between ITS projects. For example, a 511 Traveler Information System project may use information that is collected by previous instrumentation projects that collect traffic data and a CAD integration project that provides current traffic incident information. The regional ITS architecture provides a new way to look at these ITS project relationships or “dependencies”. Project dependencies can be used to identify project elements that must be implemented before other projects can begin. By taking these dependencies into account, an efficient sequence can be developed so that projects incrementally build on each other, saving money and time as the region invests in future ITS projects.

Both the traditional planning process and the regional ITS architecture process have the same goal: to use a local knowledge, consensus process to determine the best sequence of projects to create a transportation network that best meets the needs of the people of the region.



A sequence of projects required for implementation is required in FHWA Rule 940.9(d)6 and FTA National ITS Architecture Policy Section 5.d.6.

### 6.1.1 Project Sequencing Process

#### Collect Existing ITS Project Sequencing Data

Projects are currently sequenced, or ordered, in planning documents like ITS deployment, strategic, or master plans that identify short, medium and long-term projects for a region. The TIP/STIP may include ITS related projects. At a higher level, long range plans may identify regional initiatives or priorities related to ITS. The first step in the ITS project sequencing process is to review these plans, identify the ITS projects that are already prioritized as short, medium and long term, and then use this as a starting point.



Beginning the ITS project sequencing task with the sequence already included in applicable transportation plans is the best way to make sure that the completed project sequencing product will be relevant to planners and factored into future transportation plans. This two-way relationship between the regional ITS architecture products and the applicable regional planning

documents is critical to mainstreaming the regional ITS architecture into the transportation planning process. The relationship between the regional ITS architecture and the transportation planning process is described in more detail in Section 7.

When a regional ITS architecture is updated, the same analysis applies. Review updated versions of the same planning documents that were used when the regional ITS architecture was originally developed. In particular, plan to update the status of projects as they are implemented over time.

### **Define ITS Projects**

A regional architecture should identify projects to deploy the elements, services, and interfaces included in the architecture. The list of existing projects collected in the previous step should be expanded to cover the entire architecture. Prior to the development of regional architectures, some regions developed ITS Deployment Plans (a.k.a. Strategic Plans, Master Plans, etc.) to guide ITS deployment in the region. The Plans identified ITS projects for the region. The definition of projects in a regional architecture is similar to the development of such plans.

Since an architecture has a long time horizon, it may be difficult to define specific projects for the future, but nearer term projects should be defined in as much detail as possible so that they can flow directly into the regional programming or agency budgeting processes as discussed in Section 7. For nearer term projects, details of the project should be defined including the project location. While specific field device locations are typically determined later in the project development process, the project coverage area should be specified at the outset since this impacts project scope, cost, and project sequencing priorities. For example, a project for deployment of CCTV could be defined to cover specific corridor(s) of roadway(s) if the specific location of the cameras will be determined as part of the project.

For projects in the longer term, it may not be possible to identify specific projects but rather categories of projects such as “ramp metering installations”, “transit and traffic management information sharing”, and “evacuation management system”. These categories or even larger groups of projects can be defined as regional initiatives which can be included in long range plans as presented in Section 7.1.

In addition to defining projects at differing levels of detail, it is important to realize that it may take a series of projects to deploy an ITS system. For example, a traffic management center (TMC) may require a project to plan the center including developing a concept of operations, a project to design the facility, and a project to construct it. As another example, ITS components such as surveillance cameras, message signs, signals, and ramp meters are not typically deployed across a region in a single project but

in phases by roadway corridors. Since nearer term projects must feed into programming and budgeting processes, the phases of such projects should be identified in the project sequencing.

An architecture and the projects defined in it should not be fiscally constrained as in a TIP/STIP. An architecture is a plan for the future that would provide the ITS services desired for the region. The plan can be deployed as funding becomes available. It is critical not to plan and identify projects just for today's funding as funding availability varies due to policy changes and other issues.

Before the regional ITS architecture can be used to identify project dependencies, each ITS project must be defined in terms of the regional ITS architecture. This means that the ITS elements, the functional requirements, the interfaces, and the information flows from the regional ITS architecture that are relevant to the ITS project must be identified.

An ITS project typically provides a service or closely related group of services in a region. If an ITS project is easily represented by one or more market package instances that represent these services, it may simplify use of the regional ITS architecture in project documentation later. Defining ITS projects in terms of ITS elements, information flows, and functional requirements is part of the iterative development of the regional ITS architecture and maintenance of the architecture as discussed in Section 8.

The regional ITS architecture can be used to address many of the requirements associated with the systems engineering analysis for projects. Essentially, the part of the regional ITS architecture that will be implemented with each project is carved out, providing a head start for project definition:

- The identification of agency roles and responsibilities can come from the operational concept developed as part of the regional ITS architecture. This operational concept can either serve as a starting point for a more detailed definition, or possibly provide all the needed information.
- Requirements definition can be initiated by using the regional ITS architecture functional requirements applicable to the project.
- The regional ITS architecture includes a map to ITS standards and the project mapping to the regional ITS architecture can extract the applicable ITS standards for the project.

The use of the regional ITS architecture to support ITS project definition is further discussed in section 7.



The systems engineering analysis required for ITS projects is defined in FHWA Rule 940.11 and FTA National ITS Architecture Policy Section 6.

## Evaluate ITS Projects

Each ITS Project should be evaluated in terms of anticipated cost and benefits and to determine whether there are any institutional or technical issues that will impede implementation. In addition, the evaluation may take into account agency and public support for each project and other qualitative factors that will impact the actual sequence in which projects are deployed. When updating a regional ITS architecture, cost estimates can be updated based on newer technology or investments that may not have existed when the architecture was developed or last revised.

*Cost:* Rough cost estimates for each planned project are an input to a realistic project sequence that takes financial constraints into account. Cost estimates should include both non-recurring (capital costs) and recurring (operations and maintenance) costs. Where possible, regions should use their own cost data as a basis. Cost basis information and assumptions should be documented to facilitate adjustment as additional data becomes available.

*Benefits:* The anticipated benefits for the planned projects can also be used as an input to project sequencing. An estimate of benefits normalized by anticipated costs is a common figure of merit that can be used to identify ITS Projects that are the best candidates for early implementation. Both qualitative and quantitative safety and efficiency benefits may be estimated based on previous experience either within the region or in other regions that have implemented similar projects.

*Technical and Institutional Feasibility:* Each project can be evaluated to determine whether it depends on untested technologies or requires institutional change. Any impediments should be factored into the project sequence.



Documentation and tools are available to support analysis of benefits and costs to support ITS project sequencing. The USDOT JPO has an ITS Benefits Database and Unit Cost Database website that can be found at <http://www.benefitcost.its.dot.gov/>. In addition to the databases, the website contains several documents highlighting ITS benefits. A tool developed by USDOT is the Intelligent Transportation System Deployment Analysis System (IDAS), a sketch-planning software analysis tool for estimating the benefits and costs of more than 60 types of ITS investments. Information on IDAS is available at <http://ops.fhwa.dot.gov/trafficanalysistools/idas.htm>.

## Identify Project Dependencies

With each ITS project defined in terms of the regional ITS architecture, the relationships between projects can be more easily identified:



- Where ITS projects share an information flow, there is an “information dependency” between the project that generates the information and the project that receives the information.
- Where ITS projects implement related functions on the same ITS element, there may be a “functional dependency” between the two projects. For example, certain core functions (e.g., surveillance) must be implemented before more advanced functions (e.g., incident verification).

In addition to the dependencies identified in the regional ITS architecture, ITS projects are also dependent on many other factors including the data or policy decisions that support the projects. For example, transit applications may be held up by the development of a bus stop inventory. A regional traveler information system may be held up by the lack of a regional base map. A regional fare system may be held up by a lack of consensus on regional fare policies. These types of dependencies should also be recognized and factored into the project sequence.

### **Define Project Sequence**

A project sequence defines the order in which ITS projects should be implemented. A good sequence is based on a combination of transportation planning factors that are used to prioritize projects (e.g., identify early winners) and the project dependencies that show how successive ITS projects can build on one another.

Sometimes, many other factors influence the actual sequence of projects, so that developing an absolute rank ordering of projects is impractical during development or update of a regional ITS architecture. For example, the final decision about which projects will be funded may be made by the policy board of an MPO, which will not consider these decisions until after the regional ITS architecture is complete. In these cases, it may be reasonable to simply allocate projects to a rough timeframe such as short, medium, and long term. These allocations should still be based on the project evaluations and project dependencies. In three regional ITS architectures recently developed in New Jersey, this allocation was made to three timeframes: short term defined as “less than 5 years”, medium term (“5-10 years”), and long term (“greater than 10-years”).

In most cases, the first projects in the project sequence will already be programmed and will simply be extracted from existing transportation plans. Successive projects will then be added to the sequence based on the services and other components of the architecture and other planning factors.



As a sequence of projects is developed, also consider opportunities for including ITS projects in traditional transportation construction and maintenance projects that are planned for the region. Frequently, ITS elements can be efficiently included in traditional transportation projects;

these potential efficiencies should be considered and reflected in the ITS project sequencing. For example, dependencies between the traditional transportation project and the ITS projects can be identified and the sequence can be aligned so that the ITS project is deployed at the same time as the associated construction and maintenance project. While efficiencies can be realized by synchronizing ITS projects with traditional transportation projects, it may be desirable to keep the capital improvements and ITS improvements contractually distinct so that separate funding can be used and/or that the lower cost, but possibly higher risk, ITS improvements can be more closely monitored and managed.

The sequencing of projects in a regional architecture is similar to the development of an ITS Deployment Plan (a.k.a. Strategic Plan, Master Plan, etc.) that were developed prior to the development of regional architectures. When a regional architecture is developed, some regions incorporate the details of such plans within the architectures as the project sequencing while other regions prefer to maintain separate documents for the architecture and deployment plans. In the later case, the deployment plan should be referenced in the regional architecture so that it is clear that there is a connection between the projects contained in the plan and the architecture.

When a regional ITS architecture is being updated, note projects that have been implemented since the regional ITS architecture was developed or last updated. These projects should be updated (e.g., update project status to “Existing” or “Completed”) and removed from the project sequencing. Completed project definitions may be retained within the regional ITS architecture as a record of implemented projects, depending on the needs of the region.

The real objective in defining a project sequence is to use the sequence as an aid in developing a more efficient sequence of projects in the transportation planning process. The project sequence documentation must be coordinated with the transportation planners and factored into the various transportation plans for the region for it to be of benefit. Additional information on use of the project sequencing output is presented in Section 7.

### 6.1.2 Project Sequencing Resources and Tools

The National ITS Architecture “Market Packages” documentation on the Internet (<http://www.iteris.com/itsarch/html/mp/mpindex.htm>) and the Market Packages document (<http://www.iteris.com/itsarch/html/menu/documents.htm>) includes an extensive market package dependency analysis that identifies the important functional and information dependencies between market packages. This analysis may be a useful reference when performing the similar project dependency analysis discussed in this section. A discussion of “Early



Winner” market packages is also included in the referenced document. In this discussion, market packages are evaluated for technical and institutional feasibility, general costs and benefits, and several other criteria that may be consulted as projects are sequenced based on similar factors.



For more information on coordinating ITS projects with traditional transportation projects, see “Guidance on Including ITS Elements in Transportation Projects” from FHWA’s Office of Travel Management (EDL document #13467, [http://www.itsdocs.fhwa.dot.gov//JPODOCS/REPTS\\_TE/13467.pdf](http://www.itsdocs.fhwa.dot.gov//JPODOCS/REPTS_TE/13467.pdf))



Turbo Architecture simplifies the task of relating regional ITS architectures and ITS projects. Turbo assists the operator by maintaining the detailed relationships between the region and supporting projects. It includes a report that identifies differences between the regional ITS architecture and related projects, and tools that automate the migration of changes between regional and project ITS architectures. Projects can be assigned an arbitrary “timeframe” and a structured status of up to seven user defined values that can be used to prepare a project sequencing report. An example of the Turbo Architecture project sequencing report for a few projects in the Georgia Statewide Architecture is shown in Figure 22

Project Name	Timeframe
<i>Status:</i> Planned	
<b>511 Interactive Traveler Information System</b>	a (0-5 years)
<i>Description:</i> Lead Stakeholder: GDOT TO Related Service(s): ATIS2, EM10	
<i>Status:</i> Planned	
<b>Albany Joint TCC Network Surveillance System</b>	a (0-5 years)
<i>Description:</i> Lead Stakeholder: Albany and GDOT District 4 Related Service(s): ATMS01	
<i>Status:</i> Planned	
<b>Albany Joint TCC Signal Control Upgrade</b>	a (0-5 years)
<i>Description:</i> Lead Stakeholder: Albany and GDOT District 4 Related Service(s): ATMS03	
<i>Status:</i> Planned	
<b>Albany Transit Maintenance System Upgrade</b>	a (0-5 years)
<i>Description:</i> Lead Stakeholder: Albany Transit Related Service(s): APTS6	
<i>Status:</i> Planned	
<b>Albany Transit Security System</b>	a (0-5 years)
<i>Description:</i> Lead Stakeholder: Albany Transit Related Service(s): APTS5	
<i>Status:</i> Planned	

**Figure 22: Georgia Statewide Architecture Project Sequencing Report**

### 6.1.3 Project Sequencing Output

#### Identification of Project Sequencing Dependencies

It is beneficial to document the ITS project dependencies that influence the project sequencing. This analysis identifies the information and functional

dependencies between projects based on the regional ITS architecture and any other external dependencies that affect the project sequence. Each project should list all other projects that it is dependent on and describe the nature of the dependency. The dependency description could be a narrative description, a categorization (e.g., functional or information dependency), or both.

### **Identification of Project Sequencing based on Local Priorities**

Building on the project dependencies, this output defines an actual sequence of projects (or allocation of projects to timeframes) by factoring in local priorities, financial constraints, special requirements and objectives (e.g. modal shift priorities) that will influence the actual sequencing of projects. As discussed before, the project sequence can be documented in a variety of forms ranging from a simple listing of projects categorized as short, medium, and long-term through PERT charts that provide a detailed accounting of all project dependencies with a timescale overlay that indicates when projects will be implemented.

#### **6.1.4 Project Sequencing Examples**

These two examples illustrate first, the analysis that can be done and summarized for projects to support assigning priority to the projects or allocating them to a timeframe, and second, the association of ITS projects to the regional ITS architecture.

##### **Example 1: Eugene-Springfield ITS Plan Proposed Projects**

Table 8, extracted from the “Regional ITS Operations & Implementation Plan for The Eugene-Springfield Metropolitan Area (November 2003)” documentation, provides a table of ITS projects. This example illustrates the analysis done on projects to allocate them to a priority or timeframe. Each project in this example includes a brief description, which in some cases decomposes the project to subprojects with different but related scopes. Each project (or subproject) is assigned a priority (which corresponds to allocating the project to a timeframe). Projects are cross-referenced to the local MPO TIP (the Central Lane MPO) where the project is already programmed. Project dependencies are identified, as well as estimates of capital and operations/maintenance cost, expected benefits and technical/institutional feasibility issues.

##### **Example 2: South Jersey Transportation Planning Organization (MPO) Project Sequencing:**

Table 9, extracted from the South Jersey Transportation Planning Organization (SJTPO MPO) regional ITS architecture, identifies transit ITS projects for the region and allocates them to short, medium, and long-range implementation horizons. This example illustrates how ITS projects are tied to the regional ITS architecture ITS elements, functions and information flows.

Each project is associated with one or more market package instances from the regional ITS architecture, which are specifically identified in the table. These market package instances identify the specific ITS elements in the project as well as the information flows for those ITS elements. Figure 23 shows the market package instance identified for Project 3 in Table 9.



One issue with the market package instance in Figure 23 is that it's unlikely that all of the identified capabilities and information sharing that is shown will actually be implemented with a single ITS paratransit project. While a program is currently in place to fund this project for the county and municipal transit agencies in the region (described briefly in Table 9), these distinct agencies may access those funds on their own individual schedules according to their own capital plans. Also, as the traffic management agencies identified in the market package instance build or update their TOCs, they will be able to supply the "road network conditions" information flow to the transit management subsystems (and many other centers) that are ready (or become ready) to receive this information. In summary, it is important to understand that a market package instance may not be implemented all at once, but rather it is a guide to agencies that implement the associated service over multiple projects so that as the service is deployed, it is deployed in a regionally consistent way.

### **Example 3: Chittenden County Recommended ITS Projects:**

Table 10 extracted from the Chittenden County Regional ITS Architecture developed by the Chittenden County Metropolitan Planning Organization, sequences ITS projects for the county over the short, medium and long term. Each project is defined in detail on project description tables as shown in Table 11. The projects are defined at varying levels of detail. The shorter term projects are defined in greater detail including specific locations (e.g. U.S. Route 7 – Shelburne Road Smart Corridor). Recognizing that the projects will be deployed over time, the projects are broken into phases which were scheduled and for which cost, benefits, etc. were better estimated.



Table 8: Eugene-Springfield ITS Plan Proposed Projects (excerpts)

Project Number	Project Title	Project Description	Priority	Sequency to Related Projects	Project Dependencies	Capital Costs / O&M Costs	Expected Benefits	Technical and Institutional Feasibility
<b>Travel &amp; Traffic Management (TM)</b>								
ES-TM-01	Regional Virtual Transportation Operations Center (TOC)	Project will determine the functional requirements for systems interfaces to traffic, 911, transit management agencies, emergency management agencies, the NWTOC in Salem, and regional field devices.	M	ODOT Statewide TOC Software Project. TM project relates to most of the Travel & Traffic Management projects included in this plan.	Depends on the planned communications installed between the NWTOC and ODOT District 5. Also depends on communications installed to field devices.	\$200,000 \$125,000	<ul style="list-style-type: none"> <li>Information sharing capabilities</li> <li>Back-up capabilities</li> <li>More effective traffic management, incident management, and maintenance management</li> <li>Safety and efficiency improvements</li> </ul>	Requires communications between City of Eugene, City of Springfield, Lane County, ODOT District 5, and the NWTOC.
ES-TM-02	Regional Freeway Surveillance and Management	Project will develop and deploy an integrated multi-jurisdictional regional freeway surveillance and management system that provides for traffic-responsive freeway control and sharing of roadside subsystems.	H, M, L	See Related ES-TM-02 Projects	See Related ES-TM-02 Projects	See Related ES-TM-02 Projects	<ul style="list-style-type: none"> <li>Integration of multi-jurisdictional freeway and arterial systems</li> <li>Improved safety and efficiency of freeways, thereby reducing delay and emergency response times</li> <li>More effective traffic management, incident management, and maintenance management</li> <li>Timely and cost-effective complaint response</li> <li>Increase in information available to travelers</li> </ul>	See Related ES-TM-02 Projects
ES-TM-02A	I-5 Freeway Surveillance and Management	Project includes the installation of the following devices on I-5: <ul style="list-style-type: none"> <li>CCTV Cameras</li> <li>DMS</li> <li>System-Wide Ramp Meters &amp; System Detection</li> <li>Collis Warning System</li> </ul>	H, M, L H, M L H	TransPlan Project #250 & 600 ES-TM-02*	Requires communications connection to the NWTOC and ODOT District 5.	\$4,000,000 \$125,000	<ul style="list-style-type: none"> <li>Improvements at I-5/Beltline Hwy can be incorporated with planned capital improvements.</li> </ul>	
ES-TM-02B	Beltline Highway Freeway Surveillance and Management	Project includes CCTV cameras, DMS, system-wide ramp meters, and system detection on the following corridors: <ul style="list-style-type: none"> <li>River Rd to I-5</li> <li>Barger Rd to HWY Expressway</li> <li>Wy 1<sup>st</sup> Ave to Barger Rd</li> </ul>	H M L	TransPlan Project #112, 400, 500, 600, 607, 623 & 650 ES-TM-02C	Requires communications connection to the NWTOC and ODOT District 5.	\$6,000,000 \$175,000	<ul style="list-style-type: none"> <li>Parts of this project can be incorporated with planned capital improvements</li> <li>through DMS and the TripCheck web site</li> <li>Availability of additional volume, speed, and occupancy data</li> </ul>	
ES-TM-02C	Eugene-Springfield Highway (OR 126) Freeway Surveillance and Management	Project includes the installation of the following field devices: <ul style="list-style-type: none"> <li>CCTV Cameras</li> <li>DMS</li> <li>System-wide Ramp Meters &amp; System Detection</li> </ul>	H, M L	TransPlan Project #66, 621 & 235 ES-TM-02B	Requires communications connection to the NWTOC and ODOT District 5.	\$2,000,000 \$100,000	<ul style="list-style-type: none"> <li>Parts of this project can be incorporated with planned capital improvements.</li> </ul>	
ES-TM-02D	I-105 Freeway Surveillance and Management	Project includes CCTV cameras, DMS, system-wide ramp meters, and system detection at the following locations: <ul style="list-style-type: none"> <li>Della Hwy Interchange</li> <li>Coburn Rd Interchange</li> </ul>	M, L M, L	TransPlan Project #151 ES-TM-02B	Requires communications connection to the NWTOC and ODOT District 5.	\$1,620,000 \$40,000	<ul style="list-style-type: none"> <li>Parts of this project can be incorporated with planned capital improvements.</li> </ul>	
ES-TM-02E	Della Highway Freeway Surveillance and Management	Project includes CCTV cameras, ramp meters, and system detection.	M	TransPlan Project #200	Requires communications connection to the NWTOC and Lane County.	\$600,000 \$5,000	<ul style="list-style-type: none"> <li>The close proximity of Lane County offices in Della Highway will cut down communications costs.</li> </ul>	
ES-TM-03	Regional Arterial Surveillance and Management	Project will develop and deploy an integrated multi-jurisdictional regional arterial surveillance and management system that provides for traffic-responsive corridor management and sharing of roadside subsystems.	H, M, L	See Related ES-TM-03 Projects	See Related ES-TM-03 Projects	See Related ES-TM-03 Projects	<ul style="list-style-type: none"> <li>Integration of multi-jurisdictional arterial systems</li> </ul>	See Related ES-TM-03 Projects



**Table 9: SJTPO (MPO) Project Definition and Sequencing (excerpt)**

Southern Transit Projects						
	Project Name	Regionally Significant Project	Market Package	Market Package Diagram#	Timeframe (S/M/L)	Programmed Project(s)
1	DRBA Cape May Lewes/Cape May Seashore Tracking (APTS)	√	APTS1 Transit Vehicle Tracking	APTS1-2	S	
2	Private Transit/Demand Responsive Vehicle Tracking (APTS)	√	APTS1 Transit Vehicle Tracking	APTS1-5	S	
3	South New Jersey Municipal/County Demand Response Transit Operations	√	APTS3 Demand Response Transit Operations	APTS3-4	S	Job Access and Reverse Commute Program
4	NJDOT and NJT Bus Operations South Transit Information Exchange (APTS)	√	APTS7 Multimodal Coordination	APTS7-6 and 8	S	
5	NJDOT Central & NJT Bus Operations South Transit Information Exchange (APTS)	√	APTS7 Multimodal Coordination	APTS7-7	S	
6	Cross County Connection TMA (APTS)		APTS2 Transit Fixed-Route Operations	APTS2-03	S-M	
7	Cross County Connection TMA Demand Response Transit Operations (APTS)		APTS3 Demand Response Transit Operations	APTS3-3	S-M	Job Access and Reverse Commute Program; Section 5310
8	SJTA Demand Response Transit Operations (APTS)		APTS3 Demand Response Transit Operations	APTS3-2	S-M	Job Access and Reverse Commute Program; Section 5310
9	SJTA Transit Security (APTS)		APTS5 Transit Security	APTS5-06	S-M	
10	Cross County Connection TMA Vehicle Tracking (APTS)		APTS1 Transit Vehicle Tracking	APTS1-1	M	
11	South New Jersey Municipal/County Vehicle Tracking (APTS)		APTS1 Transit Vehicle Tracking	APTS1-1	M	

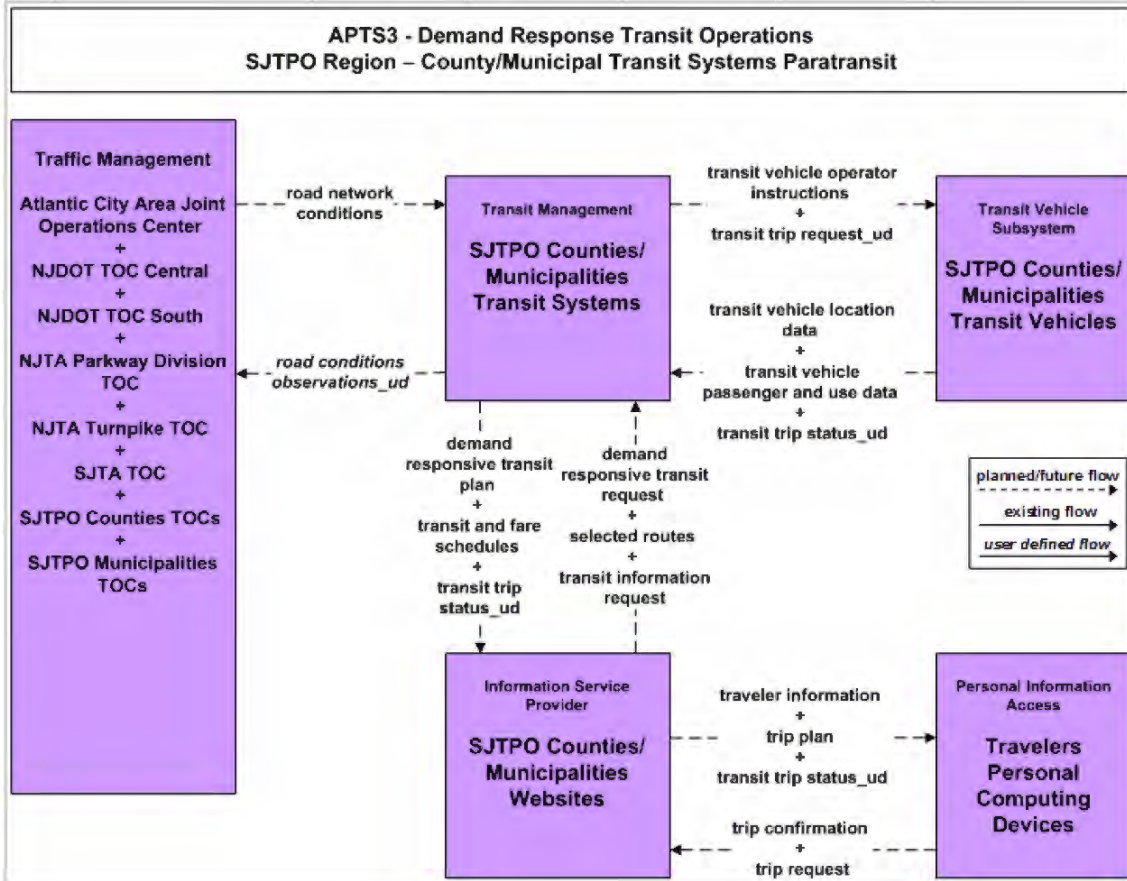

**Figure 23: Market Package Instance for Project 3**

Table 10: Chittenden County MPO Recommended ITS Projects

Project Title	ITS Project No.	Estimated Cost	Deployment Schedule	Lead Agency
U.S. Route 7 – Shelburne Road Smart Corridor	ITS-001	Phase I: \$207k Phase II: \$653k	Phase I and II: Short-Term Phase III: Long-Term	VTrans
U.S. Route 7 – Shelburne Road Smart Corridor Northern Extension	ITS-002	Phase I: \$566k Phase II: \$50k Phase III: \$24k	Medium Term – build on success of initial Shelburne Road project	VTrans
Interstate 89/189 ATMS	ITS-003	Phase I: \$735k Phase II: \$46k Phase III: \$55k	Phase I and II: Short-Term	VTrans
Chittenden County Urban Traffic Management System	ITS-004	Phase I: \$483k Phase II: \$366k	Medium Term – Phase 1: 3 years, Phase 2: 4 years	CCMPO / VTrans
Circumferential Highway ATMS	ITS-005	Phase I: \$458k Phase II: \$24k	Phase I and II: Medium-Term	VTrans
Southern Connector ATMS	ITS-006	Phase I: \$484k Phase II: \$24k	<i>Medium</i> Phase I in Concert with road construction	City of Burlington
Traffic Management Information Center (TMIC) Enhancements	ITS-007	\$364k	Medium Term (5 years) to coordinate individual projects	VTrans
Transit Automatic Vehicle Location (AVL)	ITS-008	Phase I: \$271k Phase II: \$260k	Phase I - High priority project for regional transit Phase II – medium term (3 years) Phase III – Long Term (6 years)	CCTA /SSTA
Integrated Fare Management	ITS-009	Phase I: \$75k Phase II: \$229k Phase III: \$1.686k	Medium priority to take advantage of current investments being made by CCTA (5-10 years)	CCTA
Transit Traveler Information System	ITS-010	Phase I: \$91k Phase II: \$84k Phase III: \$222k	Phase I- Near Term Phase II- in concert with broad AVL deployment (3 years) Phase III- Long term (> 5 years)	CCTA
Regional Traveler and Tourism Information System	ITS-011	Phase I: Web \$210k Phase II: Kiosks \$231k	Medium-Term (Within 5 years) to build on momentum created by initial projects	Vtrans
U.S. Route 15 ITS Improvements	ITS-012	Phase I: \$342k Phase II: \$216k Phase III: \$24k	Medium Term	Vtrans

**Table 11: Chittenden County MPO ITS Project Description**

<b>Project Title</b>	U.S. Route 7-Shelburne Road Smart Corridor
<b>CCMPO Project Number</b>	ITS-001
<b>Project Objectives</b>	Provide traveler information to increase user-friendliness Mitigate construction-phase traffic impacts Collect traffic planning and operations data Monitor operation of median U-turn lanes Expedite movement of emergency vehicles (Phase II) Improve long-term traffic management (Phase II)
<b>ITS Functional Areas</b>	Advanced Traffic Management Systems Advanced Traveler Information Systems Emergency Management Systems ITS Planning and Data Archiving
<b>Geographic Extents</b>	U.S. Route 7 corridor, Towns of Shelburne and South Burlington. Subsequent phases might include key traffic signals in the southern portion of the City of Burlington.
<b>Estimated Cost</b>	Phase I: \$207k + \$25k O+M/year Phase II: \$653k + \$65k O+M/year
<b>Anticipated Benefits</b>	Mitigation of construction congestion Improved construction management Real-time traveler information Improvement in travel time reliability More effective incident detection and management Reduced travel times and vehicle emissions Increased modal split to commuter rail Emergency vehicle prioritization Enhanced planning data collection
<b>Lead Agency</b>	VTrans
<b>Other Key Participants</b>	Towns of Shelburne City of South Burlington City of Burlington Emergency Service Providers CCTA (bus transit) Vermont Transportation Authority (rail)
<b>Deployment Considerations</b>	Significant interagency/interproject coordination Implications of VT privacy laws for CCTV cameras
<b>Deployment and Phasing Options</b>	Phase I: Construction Phase Traffic Management Phase II: Permanent ITS Infrastructure/ Corridor Signal Coordination Phase III: Integration with Regional ITS Systems
<b>Funding Opportunities</b>	Shelburne Road Reconstruction Funds CMAQ
<b>Prioritization</b>	<i>Early Success Opportunity</i> Phase I and II: Short-Term (Within 5 years) Phase III: Long-Term (5+ years)

**STEP #4: IMPLEMENTATION – Agency Agreements**

<p><b>These tasks may be performed in parallel</b></p>	<ul style="list-style-type: none"> <li>• Define Project Sequencing</li> <li>• <b>Develop List of Agency Agreements</b></li> <li>• Identify ITS Standards</li> </ul>
<p><b>OBJECTIVES</b></p>	<ul style="list-style-type: none"> <li>• Develop a list of required agreements between agencies.</li> <li>• Ensure all stakeholders are aware of the required agreements and their status.</li> </ul>
<p><b>PROCESS</b> <i>Key Activities</i></p>	<p><u>Prepare</u></p> <ul style="list-style-type: none"> <li>• Research each agency’s records to determine if there are agreements in place that can be amended to include specific ITS operations.</li> </ul> <p><u>Create List of Agreements</u></p> <ul style="list-style-type: none"> <li>• Whenever possible, utilize existing standard agreements for operations, integration, funding, etc.</li> <li>• Evaluate what kind of agreement is needed and build consensus with each of the stakeholders involved:             <ul style="list-style-type: none"> <li>○ Handshake Agreement</li> <li>○ Memorandum of Understanding</li> <li>○ Interagency Agreements</li> <li>○ Intergovernmental Agreements</li> <li>○ Operational Agreements</li> <li>○ Funding Agreement w/ project scope and operations.</li> </ul> </li> </ul> <p><u>Build Consensus</u></p> <ul style="list-style-type: none"> <li>• Agreements take a long time to execute. Build consensus early with simple agreements like MOUs while final agreements are being developed.</li> </ul>
<p><b>INPUT</b> <i>Sources of Information</i></p>	<ul style="list-style-type: none"> <li>• Existing operational, intergovernmental, interagency and/or funding agreements between ITS element operating and user stakeholders.</li> <li>• Existing process and procedures for executing agreements between agencies.</li> <li>• Operational concept, interconnects, and project sequencing outputs from the regional ITS architecture.</li> </ul>
<p><b>OUTPUT</b> <i>Results of Process</i></p>	<p>A list of agreements (<i>existing and new</i>) required for operations, including those affecting ITS project interoperability.</p>

## 6.2 Develop List of Agency Agreements

Agreements among the different stakeholder agencies and organizations are required to realize the integration shown in the regional ITS architecture. In this step, a list of the required agreements is compiled and new agreements that must be created are identified, augmenting agreements that are already in place.



Any agreements (existing or new) required for operations, including at a minimum those affecting ITS project interoperability, utilization of ITS related standards, and the operation of the projects identified in the regional ITS architecture are required in FHWA Rule 940.9(d)4 and FTA National ITS Architecture Policy Section 5.d.4.

### 6.2.1 List of Agreements Process

Each connection between elements in the regional ITS architecture represents cooperation between stakeholders and a potential requirement for an agreement. Of course, this doesn't mean that hundreds of connections in the architecture will require hundreds of new agreements. One agreement may accomplish what is necessary to support many (or possibly even all) of the interfaces identified in the architecture. The number of agreements and the level of formality and structure of each agreement will be determined by the agencies and organizations involved. In many cases, agreements will already exist that can be extended and used to support the cooperative implementation and operation of ITS elements in the region.

At this step, a list of required agreements is compiled. Note that all that is required at this point is a list of the agreements, not the agreements themselves. The detailed work, including the preparation and execution of the identified agreements will be performed to support ITS project implementation later in the process. Although the agreements are not actually developed at this point, a fairly detailed understanding of the existing agreements in the region and the various options for structuring new agreements are critical to composing a realistic list of agreements.

Start by gathering existing stakeholder agreements that support sharing of information, funding, or specific ITS projects. Review each agreement and determine whether the existing agreement can be amended or modified to include additional new requirements for cooperation identified in the regional ITS Architecture. Decide if current agreements are sufficient until more specific operational agreements are identified in the future. If not, perhaps a handshake agreement or a simple Memorandum of Understanding (MOU) will suffice in the interim.



Armed with the operational concept, knowledge of the types of ITS elements scheduled for deployment (based on the TIP and the Project Sequencing from the regional ITS Architecture) and the information that needs to be exchanged, stakeholders should coordinate with other stakeholders with whom they are planning to exchange information and reach consensus on the agreements that will be required. Compile a list of the required agreements and prioritize those agreements that support near-term implementations.

The owners or operators of the elements that will be integrated should determine the types of agreements that are needed. Most organizations have a legal department or contracts division that already has approved operational agreements, funding agreements, etc. When possible, try to use an approved process to reduce the time needed to develop, review, and execute agreements.



In an emerging trend in ITS project implementation, many public agencies are working together with private companies (e.g., Information Service Providers and the media) to deliver services to the public. Responding to this trend, agreements needed for implementation of ITS projects aren't limited to agreements between public agencies. In many regions, agreements make public sector CCTV camera images available to the private sector for media use in traffic reporting. In other regions, agreements allow private sector CCTV camera images to be made available to the public sector for incident detection and surveillance, saving the public sector the cost of the cameras and their maintenance. These cameras may be located on public right-of-way, which also requires agreements for use of right-of-way.

There is considerable variation between regions and among stakeholders regarding the types of agreements that are created to support ITS integration. Some common types of agreements are shown in Table 12.



Avoid being “technology prescriptive” in the initial agreements whenever possible since technology changes rapidly. The technology selected during the planning phase may well change as the project nears the final design phases. Being too specific regarding technology can require numerous changes to any agreement throughout the life of the project. Of course, there are times when technology is non-negotiable – the region may have an agreement to use a specific standard or a legacy system must continue to be supported or the region has already made significant investments in a particular technology. In such cases, the agreements should reflect the technology decisions that have been made by the stakeholders of the region.



**Table 12: Types of Agreements**

Type of Agreement	Description
Handshake Agreement.	<ul style="list-style-type: none"> <li>• Early agreement between one or more partners</li> <li>• Not recommended for long term operations.</li> </ul>
Memorandum of Understanding.	<ul style="list-style-type: none"> <li>• Initial agreement used to provide minimal detail and usually demonstrating a general consensus.</li> <li>• Used to expand a more detailed agreement like a Interagency Agreement which may be broad in scope but contains all of the standard contract clauses required by a specific agency.</li> <li>• May serve as a means to modify a much broader Master Funding Agreement, allowing the master agreement to cover various ITS projects throughout the region and the MOUs to specify the scope and differences between the projects.</li> </ul>
Interagency Agreement	<ul style="list-style-type: none"> <li>• Between public agencies (e.g., transit authorities, cities, counties, etc.) for operations, services or funding</li> <li>• Documents responsibility, functions and liability, at a minimum.</li> </ul>
Intergovernmental Agreement.	<ul style="list-style-type: none"> <li>• Between governmental agencies (e.g., <i>Agreements between universities and State DOT, MPOs and State DOT, etc.</i>)</li> </ul>
Operational Agreement	<ul style="list-style-type: none"> <li>• Between any agency involved in funding, operating, maintaining or using the right-of-way of another public or private agency.</li> <li>• Identifies respective responsibilities for all activities associated with shared elements being operated and/or maintained.</li> </ul>
Funding Agreement	<ul style="list-style-type: none"> <li>• Documents the funding arrangements for ITS projects (<i>and other projects</i>)</li> <li>• Includes at a minimum standard funding clauses, detailed scope, services to be performed, detailed project budgets, etc.</li> </ul>
Master Agreements.	<ul style="list-style-type: none"> <li>• Standard contract and/or legal verbiage for a specific agency and serving as a master agreement by which all business is done. These agreements can be found in the legal department of many public agencies.</li> <li>• Allows states, cities, transit agencies, and other public agencies that do business with the same agencies over and over (e.g., cities and counties) to have one <i>Master Agreement</i> that uses smaller agreements (e.g., <i>MOUs, Scope-of-Work and Budget Modifications, Funding Agreements, Project Agreements, etc.</i>) to modify or expand the boundaries of the larger agreement to include more specific language.</li> </ul>

Rather than a focus on technology in early cooperative agreements, the focus should be on the scope-of-service and specific agency responsibilities for various components of the service. Describe the high-level information that each agency needs to exchange in order to meet the goals and expectations of the other rather than defining how the delivery of that information will occur.

The process may begin with something as simple as a handshake agreement. But, once interconnections and integration of systems begin, agencies may want to have something more substantial in place. A documented agreement will aid agencies in planning their operational costs, understanding their respective roles and responsibilities, and build trust for future projects. Formal agreements are necessary where funding or financial arrangements are defined or participation in large regionally significant projects is required.

The process of building consensus for a project agreement can build on the process of developing the regional ITS architecture: achieving regional consensus on needs, services, roles and responsibilities, and the architectural requirements on ITS elements, their functional requirements, information flows and standards for encoding the information flows. Once these institutional and technical issues have been agreed to, the foundation for the institutional agreements is in place.

In addition to the architecture elements identified above that can go into an agreement, deployment issues need to be considered and agreed to as well. For example: Who builds? Who operates? Who maintains? How are costs and/or revenues shared? How will liability be allocated? These sometimes very hard problems are often the most time consuming elements of an agreement.

A key benefit of developing a regional architecture based on a consensus process is that the transportation goals and solutions are identified early, so that these sometimes more difficult issues can be approached as soon as possible.



Agreements can take a long time to execute. Many regions have reported that three years is the average amount of time to build consensus, develop the contract(s), gather signatures, and execute the agreement. Plan accordingly. Begin the agreement process early, even if it is just a Memorandum of Understanding, while a more robust agreement is being developed.

Agreements are time sensitive. Gain consensus and a commitment to schedule before the Agreement is circulated. This is especially important when executive-level changes impact the agencies strategic direction. One administration may be supportive and committed to sign a regional agreement

and the next may not understand or simply may have a different funding agenda. Educating new stakeholders to the regional integration of ITS project process can take valuable time that has a domino affect on other agencies with regard to executing an Agreement.

### **6.2.2 List of Agreements Output**

This output will be a list of required agreements, including both existing and planned agreements that need to be put into place. Each list entry identifies the agreement title, the stakeholders involved, the type of agreement that is anticipated, high level status (existing or planned), and a detailed and concise statement of the purpose of the agreement. Each entry should also reference the regional ITS architecture in some way. For example, identify the name of a project that is mapped to the regional ITS architecture for project level agreements, an interface or set of interfaces for a specific information exchange agreement, or possibly an ITS element in the inventory. The exact nature of the reference to the regional ITS architecture is highly dependent on the nature and scope of the agreement. If specific ITS standards are being considered for the interface, it's helpful to include this information as well. In many cases, a general commitment to "compatible interfaces" and use of a general standards family is sufficient for initial agreements.

### **6.2.3 List of Agreements Examples**

The following example, shown in Table 12, is a partial list of agreements taken from the Southeast Nebraska Regional ITS Architecture for the City of Lincoln. This regional ITS architecture identifies required agreements based on the projects developed for the region.

**Table 13: Southeast Nebraska Regional ITS Architecture Agreements**

SENEARCH Project	Stakeholders	Agreement Type(s)	Agreement Status	Agreement Objectives
<p>Vehicle Location Project Coordination &amp; Cooperation</p>	<ul style="list-style-type: none"> <li>• NDOR</li> <li>• City of Lincoln</li> <li>• Star Tran</li> <li>• Lancaster County</li> </ul> <p>Local City &amp; County Agencies Metro Area Transit (Omaha)</p>	<p>Memorandum of Understanding (MOU)</p>	<p>Planned</p>	<p><b>MOU:</b> The MOU should describe agency intentions to cooperate and agency expectations and roles for cooperative development of vehicle tracking, hardware, software and communication infrastructure. Several SENEARCH Projects include provision of vehicle location and tracking systems. Agreements between stakeholders for individual projects should be undertaken within the framework of this agreement. SENEARCH vehicle tracking projects include:</p> <ul style="list-style-type: none"> <li>• City of Lincoln Emergency Vehicle Improvements</li> <li>• Local Emergency Vehicle Improvements</li> <li>• NDOR Maintenance Vehicle Tracking</li> <li>• City of Lincoln Maintenance Vehicle Tracking</li> <li>• Local County Maintenance Vehicle Tracking</li> <li>• Star Tran AVL</li> <li>• School Bus Tracking</li> <li>• Local Transit Vehicle Tracking</li> </ul> <p>The Star Tran AVL Project has received a Federal Appropriation and will be the first project implemented. While this funding cannot be used for broader planning, design or implementation, development of the Star Tran AVL should be implemented with ability for regional expansion if that proves to be cost-effective versus other solutions.</p>
<p>Emergency Management Coordination</p>	<p>Primary stakeholders:</p> <ul style="list-style-type: none"> <li>• City of Lincoln</li> <li>• Lancaster County</li> <li>• Local City &amp; County Agencies</li> <li>• Local Media</li> </ul> <p>Secondary stakeholders:</p> <ul style="list-style-type: none"> <li>• NDOR</li> <li>• NSP</li> <li>• NEMA</li> <li>• ARNG</li> </ul>	<p>Memorandum of Understanding (MOU)  Operational Agreements (OA)</p>	<p>Some inter-local agreements for sharing resources between agencies already exist. Updates or new agreements may be needed</p>	<p><b>MOU:</b> The MOU should address agency intentions, expectations and roles. The MOU should recognize NDOR, NEMA, NSP and ARNG as secondary stakeholders. <b>OA:</b> An incrementally developed OA should address how agencies will actually work together for information sharing, operations, maintenance, etc. The primary purposes of the agreements are to describe agency expectations and roles for information and resource sharing across jurisdictional boundaries. SENEARCH projects that should be addressed within Emergency Services Coordination agreements include: Infrastructure Security Monitoring Local Emergency Management Computer-Aided Dispatch City of Lincoln Emergency Vehicle Improvements Local Emergency Vehicle Improvements The operating agreement will also recognize NDOR, NEMA, NSP and ARNG as secondary stakeholders.</p>

**STEP #4: IMPLEMENTATION - Identify ITS Standards**

<p><b>These tasks may be performed in parallel</b></p>	<ul style="list-style-type: none"> <li>• Define Project Sequencing</li> <li>• Develop List of Agency Agreements</li> <li>• <b>Identify ITS Standards</b></li> </ul>
<p><b>OBJECTIVES</b></p>	<ul style="list-style-type: none"> <li>• Educate stakeholders on the use of ITS Standards.</li> <li>• Identify the ITS Standards that support the interfaces identified in the regional ITS architecture.</li> </ul>
<p><b>PROCESS</b> <i>Key Activities</i></p>	<ul style="list-style-type: none"> <li>• Using the Information Flows identified in Step #3, identify the relevant ITS standards for the region</li> <li>• Assess ITS standard maturity and establish agreements for use of interim standards where necessary</li> <li>• Identify other regional and/or statewide standards that might apply</li> </ul> <p><u>Building Consensus</u></p> <ul style="list-style-type: none"> <li>• Educate stakeholders on the importance of standards, especially with respect to cost, risk, and interoperability issues both within a region and when connecting to neighboring regions.</li> <li>• Build regional commitment to consider and deploy ITS standards-conformant system interfaces.</li> </ul>
<p><b>INPUT</b> <i>Sources of Information</i></p>	<ul style="list-style-type: none"> <li>• Regional Information Flows (Step #3)</li> <li>• USDOT web site (<a href="http://www.standards.its.dot.gov/">http://www.standards.its.dot.gov/</a>) that provides ITS Standards status, deployment-based outreach information, and lessons learned.</li> <li>• Standards Development Organizations (AASHTO, ITE, NEMA, SAE, IEEE, ASTM, ANSI and APTA), including websites, online technical discussions, and lessons learned</li> <li>• Interface Control Documents (ICD) from all stakeholders' systems to identify standards currently in place.</li> </ul>
<p><b>OUTPUT</b> <i>Results of Process</i></p>	<ul style="list-style-type: none"> <li>• Report containing a tailored list of ITS Standards (or interim standards) for each information flow in the regional architecture</li> <li>• Report listing each information flow in the regional architecture with a corresponding list of selected ITS Standards (or interim standards where necessary)</li> <li>• Plan or Strategy for how ITS Standards will be evaluated and implemented as ITS is deployed in the region</li> </ul>

## 6.3 Identify ITS Standards

In this step, applicable ITS standards (or interim standards) are identified for each information flow in the regional ITS architecture. Establishing regional and national standards for exchanging information among ITS elements is important not only from an interoperability point of view; it also reduces risk and cost since a region can select among multiple vendors for deployment products. The ITS community recognized these advantages and therefore encouraged Standards Development Organizations (SDOs) to create ITS standards between the most critical ITS element interfaces.



A report identifying ITS Standards supporting regional and national interoperability is a required component of the regional ITS architecture as identified in FWHA Rule 940.9(d)7 and FTA National ITS Architecture Policy Section 5.d.7.

### 6.3.1 ITS Standards Process

ITS Standards address interfaces between ITS elements, so prior to this step, the stakeholders should have reached consensus on the information flows between each pair of ITS elements in the region. A set of standards can be identified for many of these information flows.



The first step is to educate the stakeholders regarding ITS Standards. Consider arranging an ITS Standards training course for the region. Take a look at the ITS Standards that are currently in development; descriptions and monthly status for each ITS Standard can be found at the USDOT ITS website at <http://www.standards.its.dot.gov/>. Also included on this website are contact numbers, standards advisories, fact sheets, deployment lessons learned, peer-to-peer support, and outreach material as well as links to websites maintained by the various Standards Development Organizations. For standards that are not published, it is advisable to contact the working group chair to learn about the current status of the standard as well as the advantages and disadvantages of implementing the standard before it is published.

There are some basics to know prior to examining the list of ITS Standards. In general, each information flow has up to three types of standards that are relevant: a message set standard, a data element standard, and communications protocol standards. Especially in the area of communications protocols, there are various technology choices that a region can make. Making the best choices depends on multiple factors, including throughput (how much data must be transmitted or received on the interface), network topology (how the ITS systems are connected together), infrastructure (fiber optic lines, leased land lines, etc.), and communications services (publish/subscribe, etc.), among others. At this point in the process, educate the stakeholders sufficiently to identify the potential ITS Standards



for each interface, but leave final technology choices to the communications experts during project implementation. Typically, these decisions are made as part of the Plans, Specifications and Estimates (PS&E) for each project.

Review the standards currently used by the stakeholders. It's possible that many industry standards are already in use in the region. Encourage stakeholders to examine their existing interfaces and determine whether this is indeed the case. Discuss options for converting or translating these interfaces to ITS standards over time.

In determining when and how to incorporate ITS standards for a given interface, it's critical to understand the relative maturity of the standards. For each potential standard, consider asking:

- Has the ITS standard been approved or published by the SDOs?
- Has the ITS standard been adopted by multiple vendors or system integrators?
- Has the ITS standard been tested, either informally by the vendor, or through the formal ITS Standards Testing Program funded by FHWA?
- Is there an amendment to the ITS standard or is a new version currently in the works, and if so, how much of the standard will change as a result?

Along with understanding ITS Standards and how they might apply to the region, consider also what others are doing. There may be decisions regarding certain standards made by a DOT that are to be applied across the entire state. Also, look at what neighboring jurisdictions and states may be doing. Working together and sharing resources will reduce risk for everyone and increase the integration between systems across the state and between states.

Prior to initiating implementation of a given ITS standard, consult early public sector deployers and discuss the lessons they learned. This will help gauge the maturity of the standard, and better quantify any deployment risks that may be involved.

Regions should create a regional standards strategy or plan that shows how the region will migrate toward ITS standards conformance. As part of that effort, stakeholders should reach consensus on an interim approach if the ITS standards applicable to the region's interfaces are not yet mature. It is usually better to implement the relevant parts of an ITS Standard than to ignore it.



Schedule meetings to keep stakeholders informed regarding Standards. Assign various Stakeholders to report on different Standards so that it isn't

too much a burden on one stakeholder or the champion(s). Build consensus and support for sharing this task and document stakeholder responsibilities.

In addition to the interface standards that are being defined for ITS, a range of other regional standards may be considered that would facilitate interoperability and implementation of the regional ITS architecture. For example, standard base maps, naming conventions, measurement characteristics, georeferenced location standards, and organizational structure identifiers can all facilitate the meaningful exchange of information between systems in the region. These types of regional standards should also be considered and can be included in the standards documentation at the discretion of the region.



The Rule/Policy requires, where appropriate, that federally funded ITS projects use ITS standards that are adopted by the USDOT. No ITS standards have been adopted by the USDOT as of April 2006 but over 100 ITS standards are in development and/or published by various Standards Development Organizations (SDO). As an SDO-approved standard matures and its market expands, USDOT may decide to adopt it through a formal rulemaking process. Consult the USDOT web sites on ITS standards (<http://www.standards.its.dot.gov/>) and ITS architecture and standards conformity ([http://www.ops.fhwa.dot.gov/its\\_arch\\_imp/policy.htm](http://www.ops.fhwa.dot.gov/its_arch_imp/policy.htm)) sites for the latest information.



### 6.3.2 ITS Standards Resources and Tools

The National ITS Architecture provides a list of all ITS Standards applicable to each information flow (or “architecture flow”). The title, document number, and responsible SDO are included for each flow.



Turbo Architecture provides an ITS Standards Report based on all of the architecture flows selected in the region. The report lists all standards associated with each architecture flow, either sorted by standard or by interface. Select the specific ITS standards that reflect the regional standards strategy. When using Turbo Architecture, try to minimize the number of user-defined architecture flows unique to the region. Since ITS Standards are created using the National ITS Architecture as a framework, ITS Standards have only been created for the interfaces identified by that framework. As a result, you’ll be on your own when you need to determine how to standardize those user-defined interfaces.



Turbo Architecture 3.0 and later versions provide the user with the capability to add standards and map them to information flow triplets (source, destination and information flow name). In addition, Turbo Architecture now allows the various groups of ITS standards to be tailored to reflect the

region's strategy. For example, the user may remove standards that will not be deployed in the region from Turbo output displays and reports.

Many of the SDOs maintain websites where you can download interim copies or order published copies of ITS standards, obtain status information, take a look at other regions in the midst of deploying ITS standards, obtain contact numbers, and participate in various technical question and answer groups. The USDOT ITS website contains links to the majority of these sites. At this time, many ITS standards are free of charge to deployers.

### **6.3.3 ITS Standards Output**

Every regional ITS architecture must include a list of ITS standards to be compliant with the Rule/Policy. It is also important to have a plan for how the region will migrate towards use of these standards over time.

#### **ITS Standards List**

The ITS Standards report should identify all selected Standards for each information flow in the region. The standards list should include ITS standards and any other standards that are used or are candidates for use in the region.

The list should not be constrained so that it includes only the default list of ITS standards that are included in Turbo Architecture; other standards should be included as appropriate. For example, many states have defined XML and web services-based interfaces to support their CVISN deployments. Other regions have agreed on a regional standard for emergency vehicle signal preemption. Standards that have been selected in the region to support ITS implementation should be included in the region's standards list, whether or not they are in the default list of ITS standards.

The list should also be tailored so that it does not include standards that will not be used in the region. For example, a region that has opted to use XML, SOAP, and web services exclusively for center to center communications should remove CORBA and DATEX-ASN standards from their list of applicable standards.

#### **ITS Standards Plan**

For best results, a region should move beyond a list of potentially relevant standards to define a plan for how the region will migrate to use relevant standards over time. A plan is important because standards implementation is a regional issue, not an issue that can be completely or efficiently addressed by individual project sponsors.

An ITS Standards Plan defines the current status of the region with respect to standards use, specifies where standards should be used in the region (building on the standards list described above), and defines a migration path

from where the region is to where the region would like to be. Like ITS itself, ITS standards will be implemented incrementally in the region as standard interfaces are implemented through a series of ITS projects. Interim approaches should also be documented for interfaces that will not be supported by mature ITS standards in the deployment timeframe. For example, the interim approach could identify current regional standards and show a migration path toward use of ITS standards once they become available. The ITS Standards Plan should also reflect any other factors that might affect regional standards deployment such as a statewide standards strategy, or current and planned use of ITS standards by adjacent regions. An outline of the key content of a standards plan is included in Figure 24.

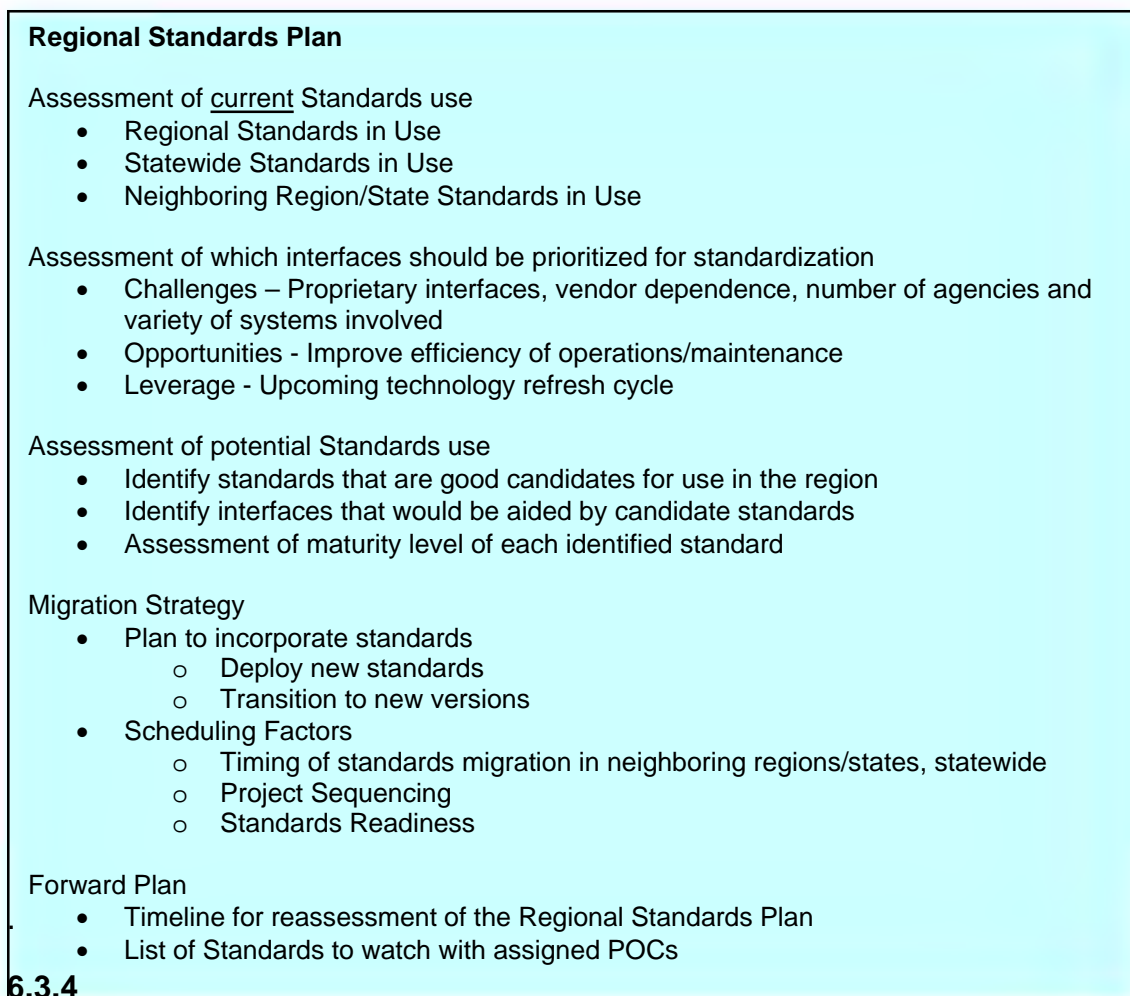

**Figure 24: Regional Standards Plan Content**

### 6.3.5 ITS Standards Examples

ITS standards reports are a common component of regional ITS architecture documentation. One of the key challenges for this particular output is finding a way to present this large body of information (multiple standards for every

information flow) in a concise, useful format. Two example outputs are presented in this section.

The first example is an excerpt from a “Relevant Standards Activities” report based on the Franklin, Tennessee TOC ITS architecture, shown in Table 14. In this output, each relevant ITS standard is identified along with the interfaces that it supports. By listing interfaces rather than individual information flows, the length of the report is reduced considerably. The more detailed information flow to standards mapping information is maintained in a Turbo Architecture database.

**Table 14: Franklin TOC Relevant Standards Excerpt**

SDO	Standard Title	Source	Destination
SAE	Advanced Traveler Information System (ATIS) General Use Standards Group	Franklin TOC	Franklin Parking Management System
		Franklin TOC	Franklin TMA Kiosks
		Franklin TOC	Franklin Transit System
		Franklin TOC	Franklin Website
		Franklin TOC	Media
		Franklin TOC	User Personal Computing Devices
ITE	Standard for Functional Level Traffic Management Data Dictionary (TMDD) and Message Sets for External TMC Communication (MS/ETMCC)	Franklin TOC	Construction and Maintenance
		Franklin TOC	Event Promoters
		Franklin TOC	Franklin Police Dispatch
		Franklin TOC	Franklin Transit System
		Franklin TOC	Franklin Website
		Franklin TOC	Media
		Franklin TOC	Murfreesboro TOC
Franklin TOC	Nashville RTMC		

In the second example, shown in Figure 25, an on-line hypertext presentation is used to organize the standards information for the FDOT District 3 regional ITS architecture. This excerpt from their web page shows a portion of the standards information for the “road network conditions” information flow. A separate web page like this is available for every flow in their architecture. (Note that this list of ITS standards has not yet been tailored for the region). The hypertext presentation allows rapid access to a concise report of the standards associated with each information flow.



## Final DRAFT Florida District 3 Regional ITS Architecture

Menu	Architecture Flow: road network conditions			
State Home	Description:			
Region Home	Current and forecasted traffic information, road and weather conditions, traffic incident information, and other road network status. Either raw data, processed data, or some combination of both may be provided by this architecture flow. Information on diversions and alternate routes, closures, and special traffic restrictions (lane/shoulder use, weight restrictions, width restrictions, HOV requirements) in effect is also included.			
Stakeholders	Communications Standards:			
ITS Inventory	NTCIP C2C	AASHTO-17	File Transfer Protocol (FTP) Application Profile	NTCIP 2303
Inventory by Stakeholder	NTCIP C2C	AASHTO1-9	Application Profile for CORBA (AP-CORBA)	NTCIP 2305
Inventory by Entity	NTCIP C2C	AASHTO-20	Application Profile for DATEX-ASN (AP-DATEX)	NTCIP 2304
Sausage Diagram	NTCIP C2C	AASHTO-21	Octet Encoding Rules (OER) Base Protocol	NTCIP 1102
Market Packages by Functional Area				
Market Packages by Stakeholder				
Market Package Descriptions				

**Figure 25: Candidate ITS Standards Excerpt for road network condition**

The state of Vermont included a Standards Plan as one of the components of its Statewide ITS Plan. A brief excerpt of the Standards Plan is shown in Figure 26. This document is meant to support managers, planners, specification writers, and project managers from transportation agencies in the State of Vermont. The Plan identifies current practices and recommends a standards development process and guidelines for evaluating all existing and future ITS technology and systems deployed.

An example from the Eugene-Springfield metropolitan area in Oregon shows a partially tailored list of standards that is organized by projects. Figure 27 is an excerpt from their “Regional ITS Operations & Implementation Plan for the Eugene-Springfield Metropolitan Area, Chapter 7: Deployment Plan.” In their deployment plan they discuss how and when projects will be deployed to implement the components of their regional ITS architecture. For major near-term projects, the ITS standards that pertain to that project are listed along with a description, funding, and other information. This method narrows the focus from over 100 ITS standards to just the ones that are relevant to the stakeholders that are concerned with that one project.



Vermont Statewide ITS Plan Update Standards Plan	
<b>1.2 Purpose</b>	<p>This document is a guide to develop a process to deploy systems using ITS standards in the State of Vermont. This document will review the life cycle of ITS Standards in the development and deployment of ITS projects in Vermont, starting with a project's genesis in a regional or Statewide ITS architecture, how to use the architecture to determine applicable standards, how to use the systems engineering process to determine functional requirements, then how to determine what ITS standards, if any, to use in an ITS project. The document will then guide the reader on how to specify the ITS standards, including how to test the use of the standard.</p> <p>The key to this document, however, is that VTrans already has a project development process in place. This document will review that existing process, indicating where and how ITS standards fit into that process. The document will make suggestions and recommendations how the existing project development process may be altered to better accommodate and include ITS standards into the process.</p> <p>What will the document NOT do? This document will not actually alter the VTrans project development process. Suggestions and recommendations will be made, but VTrans must address the suggested changes with staff in the affected departments of the agency</p> <p>This document will also not specify or recommend an ITS standard for adoption for the State of Vermont. The selection and adoption of an ITS standard should be based on an analysis of the needs and requirements for the State, which is not included in this Scope of Work. Once the needs and requirements have been determined, an ITS standard that best meets those needs and requirements should be selected and included in the project specifications. An ITS standard should not be adopted first, then checked if the needs and requirements can be met by the standard.</p>
<b>1.3 Report Organization</b>	<p>This document is separated into nine (9) chapters to support the various audience for this</p>

**Figure 26: Vermont ITS Standards Plan Excerpt**

Note that in some cases, specific ITS standards have already been identified by the region (e.g., NTCIP 1205: Object Definitions for Closed Circuit Television (CCTV) Camera Control). In other cases, the region still needs to decide which communications standards will best meet the needs of the project, which will be determined during the design phase. For example, the project designer will determine whether point to point or point to multipoint communications are required, determine whether direct RS-232 communications or FSK modems will be used, and select either NTCIP 2101, NTCIP 2102, or NTCIP 2103 accordingly. The regional ITS architecture standards list includes all three viable options and preserves the choice for the project designer.



<b>I-5 Bridge Security</b>	
Project ES-TM-13	1 of 1
<p style="text-align: center;"><b>Purpose</b></p> <p>To monitor activity on the McKenzie River and Willamette River I-5 bridges.</p>	 <p style="text-align: center;">Willamette River I-5 Bridge (Source: ODOT)</p>
<p style="text-align: center;"><b>Existing Problems</b></p> <ul style="list-style-type: none"> <li>■ Homeland security threats to the nation's bridges</li> <li>■ Limited alternate routes, particularly to the north at the McKenzie River bridge, in the event of bridge incapacitation</li> </ul>	
<b>Stakeholder(s)</b>	
<p>Primary: ODOT- Traffic Mgmt</p> <p>Secondary: Oregon State Police</p>	
<b>Description</b>	
 <p style="font-size: small;">©2003, MapQuest.com, Inc. ©2003, Navigation Technologies</p>	<p><b>To monitor bridges for suspicious activity:</b> Deploy CCTV cameras and a security detection system (i.e. boundary penetration sensors, volumetric motion sensors, point sensors) on the McKenzie and Willamette River bridges. The FHWA plans to issue a technical advisory during 2004 on how to implement available and applicable technology for bridge security. Field equipment should be linked to the Northwest Transportation Operations Center (NWTOC) and the Oregon State Police Dispatch in Salem.</p>
<p style="text-align: center;"><b>Communications Requirements</b></p> <p>Communications will be required between any cameras or security system detectors and the Northwest TOC.</p>	<p style="text-align: center;"><b>ITS Standards</b></p> <ul style="list-style-type: none"> <li>■ IEEE P1454</li> <li>■ NTCIP 1101, 1102, 1103, 1201, 1205, 1206, 1208, 1209, 2001, 2101, 2102, 2103, 2104, 2201, 2202, 2301, 2302, 2303</li> </ul>

Figure 27. Project Plans Excerpt for Eugene-Springfield

Section  
7

## Using a Regional ITS Architecture

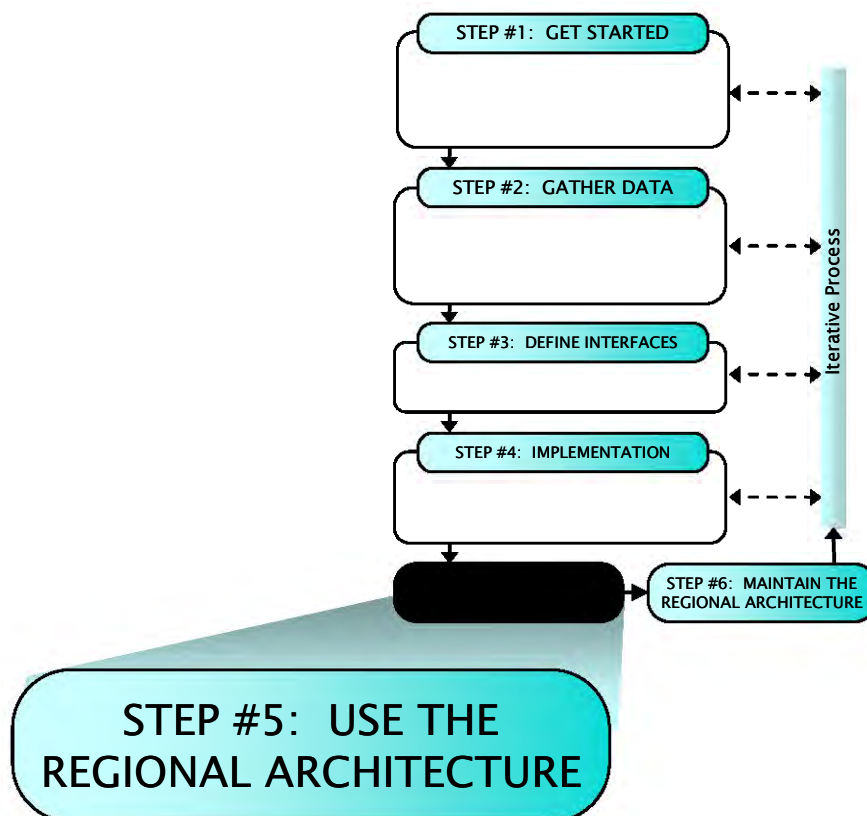

The regional ITS architecture was developed in the previous four sections. Now that you have a regional ITS architecture, this section describes ways that the architecture can be used.

In earlier sections, as the regional ITS architecture was developed, the transportation planning process and planning documents were key inputs at each step in the architecture development process. In Sections 7.1 and 7.2, ways that transportation planners can use the regional ITS architecture as an integral part of the transportation planning process are discussed. For transportation designers and implementers, ways that the regional ITS architecture can be used to support the implementation of transportation projects that involve ITS elements are covered in Section 7.3.

## STEP #5: USE THE REGIONAL ARCHITECTURE

	<ul style="list-style-type: none"> <li>• Support Transportation Planning</li> <li>• Support Programming/Budgeting/Capital Planning</li> <li>• Support Project Implementation</li> </ul>
<b>OBJECTIVES</b>	<ul style="list-style-type: none"> <li>• <i>Fully incorporate ITS elements into the region's transportation planning and programming processes.</i></li> <li>• Support the definition of ITS projects that fully consider the integration opportunities defined in the regional ITS architecture.</li> </ul>
<b>PROCESS</b> <i>Key Activities</i>	<p><u>Support Planning Processes</u></p> <ul style="list-style-type: none"> <li>• <i>Long Range Planning:</i> A regional ITS architecture can support these efforts by promoting increased stakeholder participation and promoting system and inter-jurisdictional integration.</li> <li>• <i>ITS Strategic Planning:</i> Outputs of a regional ITS architecture can serve as the basis for these plans, with additional effort required to define issues such as funding, system management and operation, and regional technology choices.</li> <li>• <i>Other Planning Activities:</i> A regional ITS architecture can support planning activities such as Congestion Management Process, Safety Planning, Freight Planning, Security Planning, and Operations Planning .</li> </ul> <p><u>Support Programming/Budgeting</u></p> <ul style="list-style-type: none"> <li>• <i>Transportation Improvement Programming:</i> The regional ITS architecture can support the selection of projects identified in programming/budgeting documents through its project definition and sequencing recommendations.</li> <li>• <i>Capital Planning/Budgeting:</i> Projects from a regional architecture that will require agency funds need to be fed into the capital planning/budgeting process.</li> </ul> <p><u>Support Project Implementation</u></p> <ul style="list-style-type: none"> <li>• <i>Project Implementation:</i> The regional ITS architecture can support key system engineering analysis activities.</li> </ul>
<b>INPUT</b> <i>Sources of Information</i>	<ul style="list-style-type: none"> <li>• Regional ITS Architecture</li> <li>• Project Architectures or ITS Project Plans</li> </ul>
<b>OUTPUT</b> <i>Results of Process</i>	<ul style="list-style-type: none"> <li>• Planning products that fully incorporate ITS elements into the regional, statewide, and agency plans and programs/budgets.</li> <li>• Programming documents and capital plans that identify efficient sequences that reflect ITS Project dependency and sequencing recommendations.</li> <li>• Project implementation based on the regional ITS architecture that considers the integration opportunities inherent in the architecture.</li> </ul>



The overall organization of this section is shown in Figure 28. Planning processes are used to identify projects whose implementation will respond to regional needs. These projects are placed in programming documents such as a Transportation Improvement Program (TIP) in order to secure funding for the projects. Once funded, the projects are implemented. The regional ITS architecture supports all three of these major steps – planning, programming, and implementation – as described in this section.

Use of the architecture throughout the project lifecycle is both a benefit and a challenge. It is a benefit since architecture use at each step improves continuity between the transportation planning process and the projects that are ultimately implemented. Serving all three major steps, with their varied perspectives and needs, is also a key challenge for the regional architect. The challenge is to create a regional ITS architecture and supporting processes and documentation that is high-level enough to support long range planning and detailed enough to provide direction to project implementers. Section 7 provides the best available information and guidance for meeting these challenges and productively using the architecture in your region.

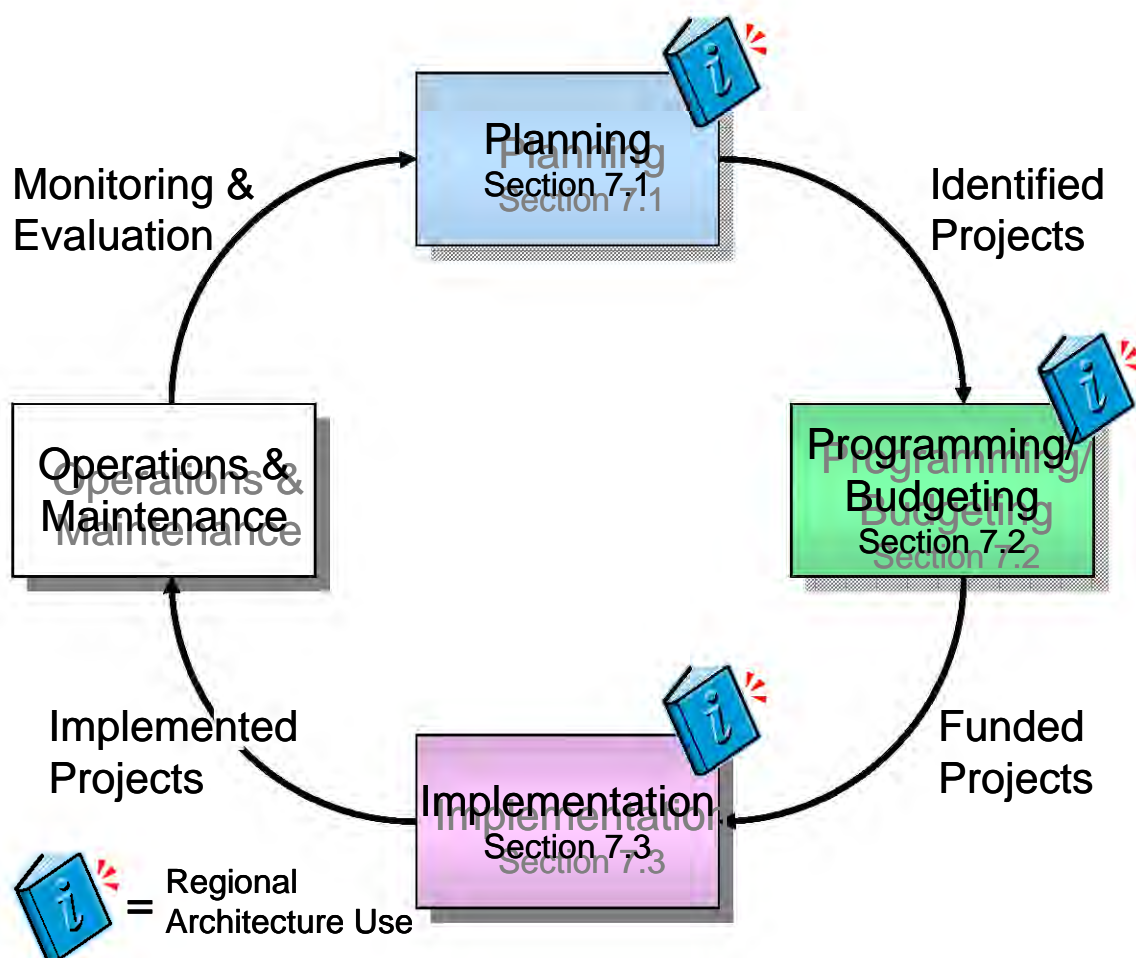

Figure 28: Using the Regional Architecture

## 7.1 Use for Transportation Planning

This section provides guidance on using a regional ITS architecture as part of transportation planning. Due to regional and local variations in the practice of transportation planning, this guidance represents a wide range of options available to each state, region, or agency rather than a single recommendation. There is no need to fundamentally change the planning processes in the region to use the architecture. The regional ITS architecture is a tool that can be used to support planning for ITS within the context of existing transportation planning processes. Local stakeholders must decide how best to incorporate the regional ITS architecture and the products produced during its development into their transportation planning process.

The goal of the planning process is to make quality, informed decisions pertaining to the investment of public funds for regional transportation systems and services. Using the regional ITS architecture to support these planning activities is an important step in the mainstreaming of ITS into the traditional decision-making of planners and other transportation professionals. As shown in the previous steps in the architecture development process, transportation plans and programs are important inputs to the development of a regional ITS architecture. Once an architecture is complete, it can feed detailed ITS-specific information back into the planning process.

Figure 29 shows some of the key steps in the transportation planning process. These steps will be elaborated on in following sections. The process is driven by a regional vision and set of goals. These drive transportation improvement strategies that are a mix of capital improvements and operational improvements. The planning organizations evaluate and prioritize the various strategies, and the resulting output is a document called the Long Range Transportation Plan (or sometimes Transportation Plan or Regional Transportation Plan). This plan is the key output of long range planning. The Long Range Transportation Plan feeds the Programming function which produces the Transportation Improvement Program (See Section 7.2 for a discussion of this effort.) Once a project is programmed then project development can begin (see section 7.3 for a discussion of this step). All of these steps occur with a variety of critical factors and inputs as shown in the figure. A regional ITS architecture may support each step in this process. Support for the Long Range Planning steps is discussed in Section 7.1.1 below. In addition to the long range planning document there may be planning documents created that are ITS specific, such as an ITS Strategic Plan. These types of plans and their connection to the regional ITS architecture are discussed in Section 7.1.2 below. Finally, support for other planning activities, such as freight or operations planning will be discussed in Section 7.1.3 below.



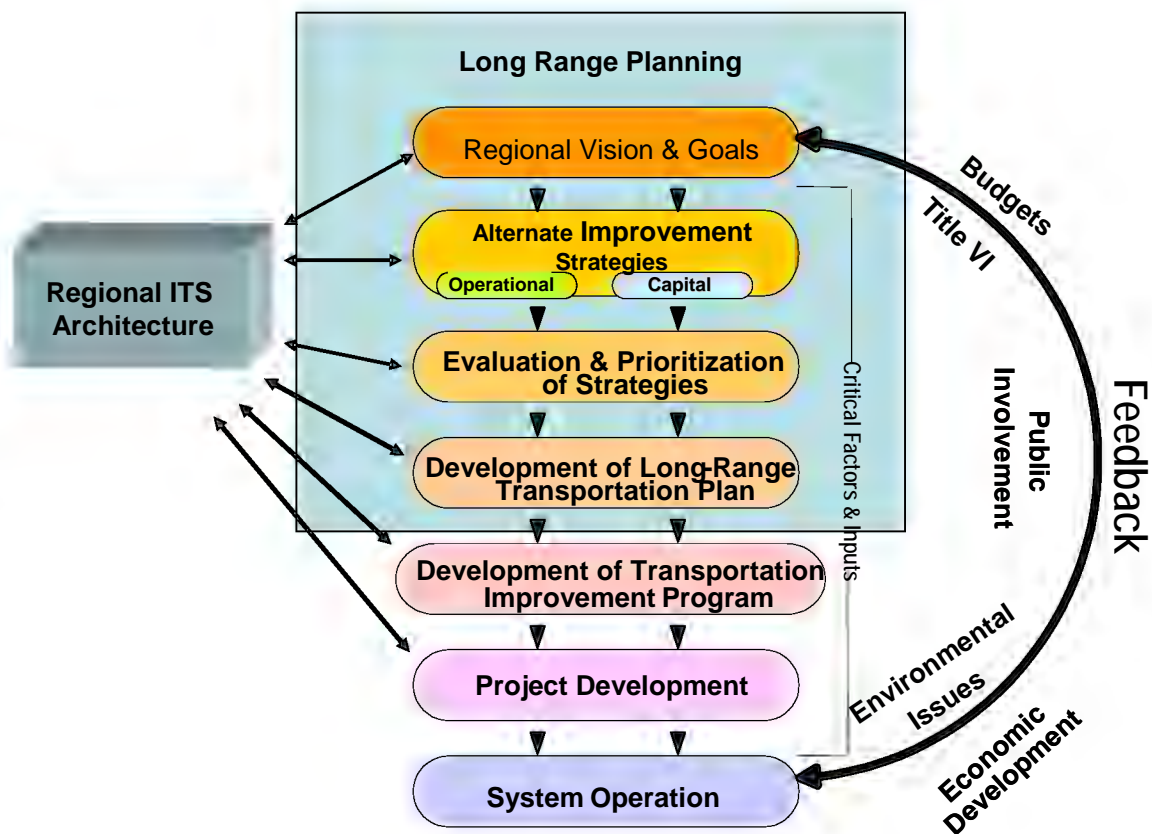

**Figure 29: ITS Architecture and the Transportation Planning Process**

### 7.1.1 Long Range Planning

In the traditional transportation planning process, the Long Range Plan is the output product of the process for long-range planning. Across the country, this plan is called various names including Regional Transportation Plan (RTP), Long-range Transportation Plan (LRTP) or just Long-range Plan (LRP). In this document it will be referred to as the “Long Range Plan”, “The Plan”, or LRP. The Plan documents the policy direction for the region and describes how transportation projects and programs will be implemented over a 20-year (or longer) period. It must be updated periodically by each state and metropolitan area. The regional ITS architecture can serve as a direct input to the plan. In some cases the regional ITS architecture might be incorporated into the plan itself. Leading up to the publishing of the plan are a variety of planning activities, as shown in Figure 29, which the architecture can also support.

The long range plan is the expression of a state or metropolitan area’s long-range approach to constructing, operating, and maintaining the multimodal transportation system. It is the policy forum for balancing transportation investments among modes, geographic areas, and institutions. A regional ITS architecture is related to both the statewide transportation plan, the metropolitan transportation plan, and agency long range plans.

How can a Regional ITS Architecture support the transportation planning process? In the following basic ways that will be expanded upon below:

- The services described in the Regional ITS Architecture can provide the basis for operational strategies that can be used to improve the transportation system to meet the region's vision and goals.
- The Regional ITS architecture can be used to support evaluation and prioritization of strategies in two ways. The first is through the definition in the architecture of archiving and data collection systems that support collecting the data needed for evaluation. The second is through the detailed definition of ITS projects and their sequencing that can be used to support prioritization efforts.
- The definition of an integrated transportation system described by the Regional ITS Architecture can support a key element of the transportation plan- for example the element "operations and management of the transportation system".
- The process of developing and maintaining a Regional ITS Architecture can help to enhance the linkage between operations and planning through closer involvement of a wider array of stakeholders from both of these areas of transportation.

One of the first steps in using a regional ITS architecture to support transportation planning is to determine the regional ITS architecture(s) that apply to the planning area. In most cases, there is a single architecture that corresponds to the state or metropolitan planning area and the choice is obvious. In a few areas around the country, more than one regional ITS architecture may apply. For example, the metropolitan Washington area, spanning the District of Columbia and portions of northern Virginia and Maryland, has two regional ITS architectures: 1) a regional ITS architecture developed by the Metropolitan Washington Area Council of Governments (MWACOG) that focuses on inter-agency relationships and 2) a Northern Virginia (NOVA) regional ITS architecture that was developed by VDOT. Where more than one architecture applies, it is important to understand the relationship between each architecture and the transportation planning process and document this understanding of how each architecture will be used. It is also critical to coordinate the potentially overlapping architectures to minimize redundancy and ensure they are consistent. See section 3.2 for more information on defining architecture scope.

### **Operational Strategies**

The planning process usually begins with a regional vision and goals. These goals are often very high level statements such as "preserve the transportation system" or "enhance public safety and security" (these are two of the six goals in the California Transportation Plan 2025). These high level goals are then further defined as objectives, policies, or strategies. As shown in Figure 29, the strategies are primarily capital improvements or operational

improvements. The Regional ITS Architecture can provide an array of potential operational improvements through the services that are defined in it. As an example, the following strategy (supporting the goal of preserving the transportation system) is contained in the California Transportation Plan:

*Use technology, innovative techniques, and new materials to enhance the life of the transportation system, provide safer work sites, enhance productivity, and provide real-time construction and maintenance information, including anticipated delays, to enable the traveler to plan their trip and avoid work zones.*

This strategy borrows from several of the services contained in the California statewide ITS architecture, including work zone management, traffic information dissemination, broadcast traveler information, and interactive traveler information. Additional examples of strategies with their roots in the Regional ITS Architecture can be found in other LRPs and overall this represents one way for the Regional ITS Architecture to be used in the planning process.

Strategies that have traditional transportation projects as their primary solution, may add ITS elements or services as a part of the overall strategy solution. For example, to reduce congestion, a corridor is planned for widening. This project could also include incorporation of ITS elements and services to better manage the upgraded corridor.



The selection of services to support strategies will be simplified for the planning organization if the Regional ITS Architecture has a needs section that provides a mapping from the needs (including the goals of the Long Range Plan) to the more detailed services of the architecture.

## Strategy Evaluation and Prioritization

Transportation planners use a variety of tools to evaluate and prioritize the various strategies for transportation improvement. Central to this evaluation is the concept of performance measures, which focus attention on the operating performance of the transportation system. The Regional ITS Architecture (and to an even greater extent the ITS Strategic Plan described below) can provide performance measures for Operations and Management capabilities provided by ITS services. The performance measures and data collection defined in the regional ITS architecture can provide access to 24/7 data, providing the planning organization the ability to measure non-recurring congestion, travel times and travel time reliability, and other aspects of system performance and service reliability across all modes.

The Regional ITS Architecture provides a guide for the archiving of transportation data including the collection of data from various ITS operational systems. These archiving capabilities revolve around regional examples of the National ITS Architecture entity, Archived Data Management

Subsystem. Furthermore the Regional ITS Architecture will have regional examples of ITS services such as ITS Data Mart (collection of historical data from a single source) and ITS Data Warehouse (collection of historical data from multiple aspects of transportation). These regional examples of these services describe connections and information that can be useful to planners in performing their evaluation and prioritization efforts. While the automation of data collection for archiving is usually a future activity (or project), the discussions that occur during the development of the Regional ITS Architecture often present additional opportunities for data sharing that can occur immediately even before projects for the automation of data sharing are implemented. This sharing of data between operations and planning, as well as the coordination that occurs in the development of the Regional ITS Architecture are examples of linkages between Planning and Operations. The concept of linkage between these two disciplines figures prominently in the FHWA Planning for Operations effort ( see <http://plan4operations.dot.gov/default.asp>). A complete treatment of these opportunities is included in the FHWA publication: *Opportunities for Linking Planning and Operations*. This publication can be found at [http://www.ops.fhwa.dot.gov/publications/lpo\\_ref\\_guide/index.htm](http://www.ops.fhwa.dot.gov/publications/lpo_ref_guide/index.htm).

FHWA has made available several software tools to support the evaluation and prioritization of ITS related strategies developed as part of the planning process. These tools include:

- IDAS (ITS Deployment Analysis System) is a software tool developed by the Federal Highway Administration that can be used in planning for Intelligent Transportation System (ITS) deployments. State, regional, and local planners can use IDAS to estimate the benefits and costs of ITS investments – which are either alternatives to or enhancements of traditional highway and transit infrastructure. IDAS can currently predict relative costs and benefits for more than 60 types of ITS investments. For more information see <http://idas.camsys.com/>.
- DYNASMART-P (Dynamic Network Assignment-Simulation Model for Advanced Roadway Telematics- Planning version) is a software tool developed for traffic operations planning applications under Federal Highway Administration's Dynamic Traffic Assignment (DTA) research program. DYNASMART-P combines (1) dynamic network assignment models, used primarily in conjunction with demand forecasting procedures for planning applications, and (2) traffic simulation models, used primarily for traffic operations studies. For more information see <http://www.dynasmart.umd.edu/>.
- SCRITS (SCReening for ITS) is a spreadsheet analysis tool for estimating the user benefits of Intelligent Transportation Systems (ITS). It is intended as a sketch-level or screening-level analysis tool for allowing practitioners to obtain an initial indication of the possible benefits of various ITS applications. For more information see <http://www.fhwa.dot.gov/steam/scrits.htm>.

Regional ITS Architecture outputs, specifically the project sequencing output may also be useful to planning staff as an aid to evaluation and prioritization of strategies. The architecture provides a short-term and long-term, multi-modal view of the ITS systems in the region. It provides the details of the transportation services and functions that can be provided by the stakeholders via ITS projects. The regional ITS architecture also illustrates the interfaces necessary between transportation systems to meet the transportation needs of the region. Finally it translates these details to the definition of a set of projects to be implemented. Usually these projects are grouped by timeframe (e.g. short term, medium term, long term). Key to its usefulness for the strategy evaluation and prioritization (as well as for the LRP as discussed below) is that this list of projects goes well beyond the short term projects that get included in the TIP (see Section 7.2 for a discussion of how the architecture can be used in developing this program element.) The project sequencing contains information for each project that may be useful to the evaluation or prioritization of the projects including:

- Stakeholders
- Cost
- Benefits
- Mapping to ITS Services

Note that this project sequencing is not a replacement for prioritization, but rather, an input to the prioritization process. In some regions, prioritization may already have occurred and be reflected in the project sequencing outputs.

A Regional ITS Architecture provides a guide for how ITS projects can be deployed to satisfy the vision and goals defined as part of the planning process. The regional ITS architecture provides the details on how ITS can be deployed to meet and satisfy the strategies and transportation services identified for the region. These details may include the interfaces, the operational concepts and agreements necessary to implement the strategies and transportation services. With these details, ITS projects can be more clearly defined, funded, and implemented to satisfy the regional goals.



One useful approach when developing the project sequencing is to view the long range projects along the line of strategies that can be expressed in terms that will facilitate their inclusion in the LRP. This higher level definition of projects (as compared to the more detailed descriptions contained in the TIP) is a closer fit to the needs of transportation planners and can support both evaluation efforts as well as provide material for the LRP.

### **Long Range Plan**

One of the primary motives for ITS, and the regional ITS architecture, is the need for more effective management of existing transportation infrastructure. Many regions can no longer rely on adding capacity to keep pace with

increasing demand. Instead, they are relying on more effective, integrated management of the existing infrastructure. Recognizing this need, many regions are beginning to include a section of the plan on “Management and Operations”, which can be defined as an integrated approach to optimize the performance of existing infrastructure through the implementation of multimodal, intermodal, and often cross-jurisdictional systems, services, and projects. The recently passed law, “Safe, Accountable, Flexible, Efficient Transportation Equity Act: A Legacy for Users” or “SAFETEA–LU”, emphasizes the need to include Management and Operations in each region’s Long Range Plan. According to the legislation (Section 6001 (i)) metropolitan planning areas must include “operational and management strategies to improve the performance of existing transportation facilities to relieve vehicular congestion and maximize the safety and mobility of people and goods.” The regional ITS architecture can provide the technical underpinning to this portion of the Long Range Plan.

One of the primary purposes of the Regional ITS Architecture is to define how an integrated transportation system (of ITS elements) might evolve in a region. To do this the architecture describes elements (e.g. various ITS assets) that are interconnected to provide operations and management of the transportation system. The architecture development and maintenance process provides an accessible way for transportation planners to become more focused on integrated management and operations. Operations practitioners have a vision for how this integrated transportation system might evolve, and express this via the details of the architecture.

A Management and Operations section should be considered in all LRPs that are related to regional ITS architectures – including agency plans, metropolitan area plans, and statewide plans. This LRP section makes the connection between the integrated system plan of the architecture and the overall transportation planning process. The section can serve as a description (at the level of detail appropriate to the LRP) of the ITS portion of the regional transportation vision. Some regions will include their Regional ITS Architecture explicitly as a part of this section in the LRP while others just include it by reference.

An example of this type of inclusion is taken from the 2030 Metro Vision Regional Transportation Plan (for the Denver metropolitan region): Under the System Management and Operational Improvements element they have the following: “Personnel and technology are necessary to “actively” manage the transportation system to assure efficient and effective day-to-day operations. This class of actions generally falls under the umbrella of Intelligent Transportation Systems (ITS).” The section then summarizes the key initiatives or areas of their Regional ITS Architecture.

Another approach used in many LRP’s is to have a separate section (or subsection) devoted to ITS. The North Jersey Transportation Planning Authority, in their Regional Transportation Plan, has a subsection on ITS activities in the region as part of the chapter on Implementation. This plan



also has a summary of the regional ITS architecture as an appendix that is referenced in the ITS subsection.

Since the Regional ITS Architecture can directly support the development of the Long Range Plan (as well as the evaluation activities that are used for the development of the plan), it is recommended that the Regional ITS Architecture be formally adopted by the regional planning organization. This adoption should ideally occur at the close of the initial development of the Regional ITS Architecture. There are a couple of benefits to formally adopting the Regional ITS Architecture. Formal adoption adds credibility to the Regional ITS Architecture, allowing planners to use aspects of the architecture with the knowledge that the region has agreed to the architecture. Formal adoption also encourages additional rigor in the architecture maintenance process. There are situations where this recommendation will not be practical due to institutional complexities or due to the ITS architecture having a distinctly different (e.g. larger) geographic scope than the regional planning organization.



When the architecture is used to support development of the LRP, it is a good practice to align major maintenance updates of the architecture with the LRP update schedule, ideally updating the architecture some months prior to the creation of the LRP update. Minor updates of the architecture are suggested more frequently (e.g. yearly) to align with programming activities (discussed in Section 7.2).



In order to further define the connection between the regional ITS architecture and the LRP, it is recommended that the regional needs, objectives, goals, or policies described in the LRP be tied to the ITS services (or other aspects of the architecture). This might be done as part of an ITS Strategic Plan (see following discussion), or as an augmented output of the Needs and Services section discussion in Chapter 4. Making this explicit connection between the architecture and the larger transportation planning language will help to advance the concepts of the “technical” architecture into the planning context.

The Mobility 2030 Transportation Plan for the San Diego Region actually includes the regional ITS architecture in a way that is representative of what many regions have done. This LRP includes a “System Management” chapter that focuses on management of existing facilities using ITS technologies. The chapter references the regional ITS architecture, which is actually included in the LRP as a separate technical appendix. The System Management chapter includes refined graphics like Figure 30 that present the integration opportunities identified in the architecture in a non-technical, approachable representation suitable for decision makers and the general public.



Many regions have recognized that the regional ITS architecture benefits from “executive summary” level descriptions and graphics that present the integration opportunities identified in the architecture in an accessible way. These graphics can be used in the architecture documentation and included

in higher level documents such as the LRP that will be read by many who are not well versed in ITS architecture.



Figure 30: San Diego Long Range Plan Excerpt – IMTMS

The ongoing maintenance of the architecture (which is covered in Section 8) is often the responsibility of the regional planning organization. The same organization is also frequently responsible for establishing the processes for architecture use in planning, programming, and project implementation. When this is the case, it is recommended that architecture use and

maintenance be included as one of the work elements in the Unified Planning Work Plan document (UPWP) or in the Simplified Statement of Work for the planning organization. The UPWP is required for metropolitan areas of greater than 200,000 population and defines the MPO's short-term (1–2 year) planning priorities within a metropolitan planning area. The Simplified Statement of Work is a similar plan which is created by smaller regions. By establishing the process, tools, and support for architecture use and maintenance in these plans, the MPO can ensure financial support for these critical activities.

### **Stakeholder Involvement**

A Regional ITS Architecture provides a vision of how Intelligent Transportation Systems (ITS) and ITS projects can be deployed to satisfy the goals and objectives outlined in the Long Range Plan. Key to the development and maintenance of the Regional ITS Architecture is the involvement of a wide array of stakeholders. Based upon the scope of the architecture, this set of stakeholders can (and should) extend beyond the agencies traditionally focused on development of the Long Range Plan. Stakeholders such as public safety, commercial vehicle operations, tourism agencies, media, and private sector transportation service providers may be involved in the architecture development (and maintenance) effort.

The architecture development effort has a second beneficial effect on stakeholder involvement in the planning process. The architecture serves as a focal point for coordination and collaboration between planning and operations practitioners. It can also help to engage operations managers in regional planning. The architecture defines specific services, interconnections, and projects on a time horizon that is usually commensurate with the LRP timeframe. By encouraging the operations practitioners to plan an evolution of their systems well beyond the current set of projects, it connects their long term thinking with that of the transportation planners. The regional ITS architecture is one of the opportunities for improving the connection between planning and operations. A complete treatment of these opportunities is included in the FHWA publication: *Opportunities for Linking Planning and Operations*.

Although the central purpose of a regional ITS architecture is to provide structure to the technical components and allow the interdependencies between systems to be identified, a regional ITS architecture can also make a significant contribution to mobilizing stakeholders. One reason for this is that a regional ITS architecture serves as a visible demonstration of the institutional dependencies that exist in a region and how agencies can benefit from each other's activities.

Since the regional architecture includes a complete accounting of the current and planned ITS inventory, it can serve as a discussion point for all stakeholders to gain buy-in and make their needs known and accommodated. Since effective applications of ITS often cross modal or institutional

boundaries, an architecture can help stakeholders identify areas where resources and funding can be leveraged via inter-agency cooperation.

To the extent that transportation planning and architecture development encourages team building and dialogue, it is likely that the collaboration established through the architecture effort could be used to address other, non-architecture related issues. In addition to further motivating traditional planning participants, a regional ITS architecture can help identify and engage new participants.



It is an excellent idea to have the committee that was formed to undertake architecture development (and which might have responsibility for architecture maintenance- see the following chapter) to also take a leading role in overseeing the use of the architecture in the planning process. In many regions this committee is a part of, or reports to the MPO and so is naturally engaged in the transportation planning process. As it moves to the roles of monitoring maintenance and use this committee may evolve to slightly different agency participation, or to different personnel within a given agency (e.g. an agency's operations planner might be the committee member during architecture development, but the agency's technical expert might be the representative at this later phase).

The previous discussion of how the Regional ITS Architecture supports LRP development may initially have limited applicability given the current state of the regional ITS architecture and the current structure of the LRP. However, the regional ITS architecture (and the ITS Strategic Plan discussed below) will be periodically updated (see the discussion of Architecture Maintenance in Section 8) to support updates of the LRP. At each update of the architecture consider changes to the architecture outputs that will provide improved support to the LRP. Figure 31 illustrates this idea of evolving the Regional ITS Architecture (and any corresponding ITS Strategic Plan) to improve its usefulness in supporting the LRP.

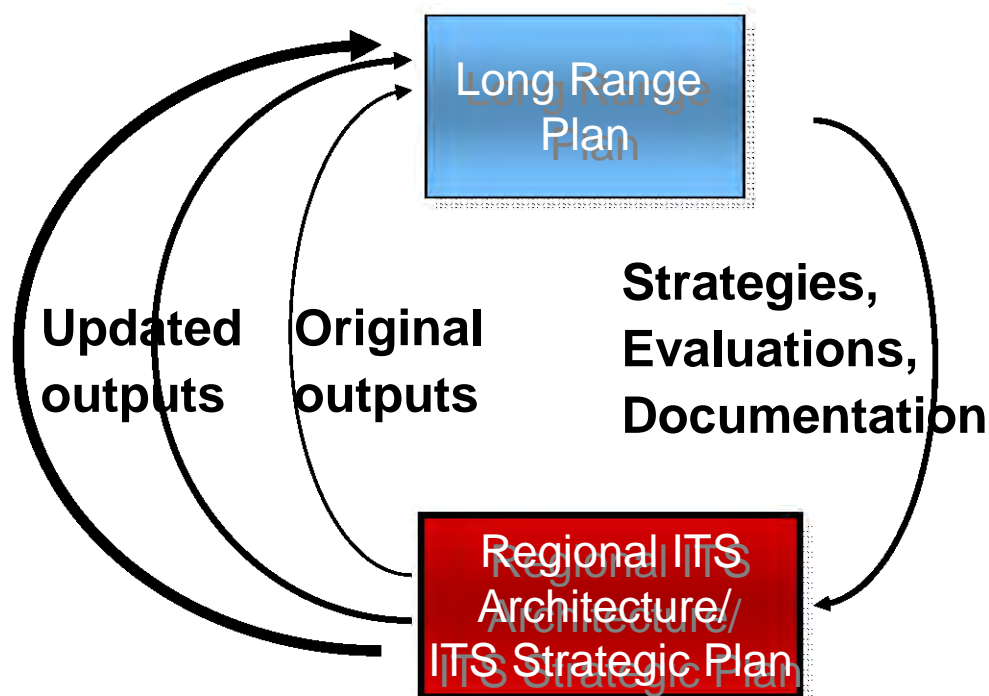
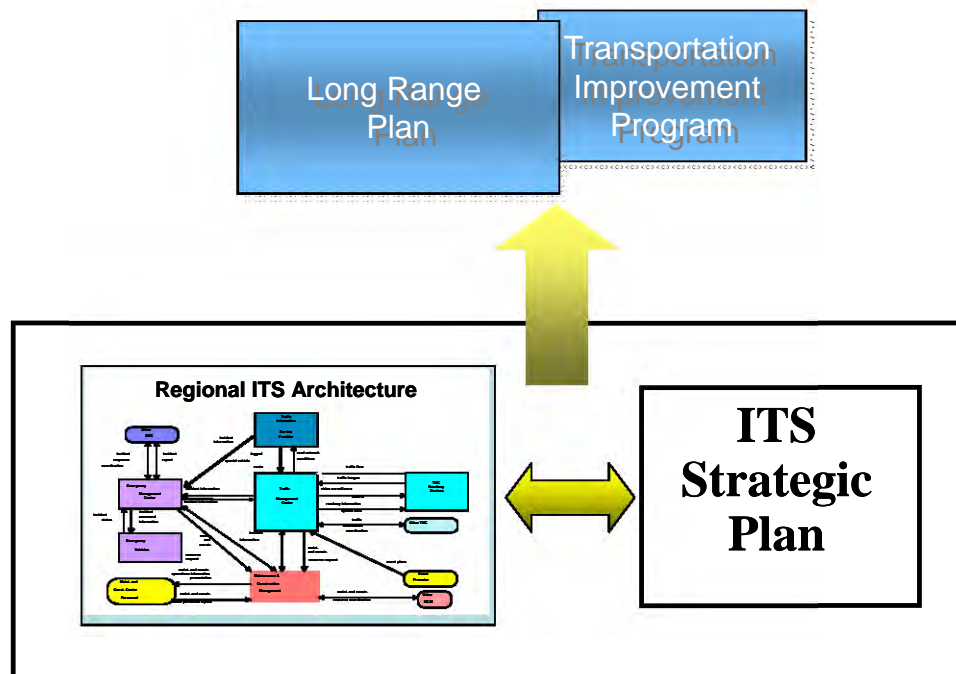

**Figure 31: Enhancing Regional ITS Architecture Use over Time**

### 7.1.2 ITS Strategic Plans

An ITS Strategic Plan (sometimes known as a ITS Strategic Assessment or ITS Deployment Plan) is a guide for implementation of ITS in a region. These plans may result as a part of the overall regional ITS architecture development effort, or may be the product of separate efforts. In the former case, the ITS Strategic Plan may be one of several documents produced during the architecture development. In some cases the regional ITS architecture is just a part of a larger effort and the architecture may represent a portion of the overall ITS Strategic Plan documentation. In more recent examples where the ITS Strategic Plan was created via a separate effort, the regional ITS architecture is referenced in the plan. Figure 32 shows that in whatever form or relationship exists between the architecture and the ITS strategic plan, these efforts can be used to support both the LRP and the Transportation Improvement Program which is covered in the Section 7.2.





**Figure 32: ITS Architecture and ITS Strategic Plans**

Why have regions created ITS Strategic Plans? There is no requirement (e.g. the Policy/Rule requirements for regional ITS architecture) for an ITS Strategic Plan, but many regions have found this a useful way to define their ITS needs and provide input to the formal planning process. Regions have used this plan as a bridge between the details of the regional ITS architecture and the transportation planning discussion contained in the Long Range Plan.

Often the ITS Strategic Plan includes several of the architecture outputs. The most common architecture outputs contained in the plans are the project sequencing and list of agreements discussed in Chapter 6.

What distinguishes these plans is that they usually contain elements that go beyond the set of requirements found in the Policy/ Rule. Some of the elements that are often included in ITS Strategic Plans (and the reasons these additional elements can help provide a better linkage between the ITS architecture and the regional transportation plans) are:

- **ITS Vision:** This short statement of why the region is deploying ITS can serve as a tie-in to the larger transportation vision that is articulated in the Long Range Plan.
- **Needs, Goals, and Objectives addressed by ITS:** Defining the needs, goals, or objectives (or in some areas policies) that ITS will address provides a direct connection to the needs, goals, or objectives that are the basis of the Long Range Plan. Tying the ITS deployments to larger transportation issues of the region is an excellent way to inject ITS projects into the regional planning process.



- **Strategies for ITS deployment:** Transportation planning tends to articulate “strategies” for regional transportation. The Regional ITS Architecture as described in the previous sections tends to have specific elements, services, information exchanges and projects as its outputs. What is missing in the usual list of architecture outputs is a strategy for how ITS will be deployed over time. Many regions add this to their ITS Strategic Plans.
- **Funding considerations:** Funding sources and funding requirements for ITS deployments may be considered. In order to make these funding assessments, some deployment considerations must be evaluated. Issues of funding system operations and maintenance are especially important to ITS deployments, and consideration of this topic may be included.
- **Detailed project definitions:** The regional ITS architecture may identify general regional projects that are then defined with additional specificity in the strategic plan. For example, a single general surveillance project for a metropolitan area may be split into several phased projects that add instrumentation to different parts of the metropolitan area over time. The location-specific projects may be defined so they are coordinated with other planned capital improvements or simply to stage the implementation so the highest-priority locations are instrumented first as funds become available. The more detailed location-specific project definitions are required to support accurate cost estimates.
- **Gaps in planned projects:** The Regional ITS Architecture suggests elements, services, and information exchanges that will be implemented over the timeframe selected for the architecture. The projects listed in the architecture invariably implement only a subset of the parts of the architecture. Identification of the “gaps” between the project list and the architecture, along with a prioritization of the gaps can result in a very useful understanding of where additional projects might be needed to address priority needs.
- **Benefits Analysis:** Since transportation projects are ultimately “scored” with some factoring of cost/benefit as the projects move to the programming stage, having a discussion of the benefits that accrue from ITS projects can assist in understanding the benefit part of the cost/benefit equation for these projects. This discussion of cost/ benefits could be a part of the Project Sequencing output or a part of a Strategic Plan, depending on the approach taken by the region.
- **Communications Plan:** The architecture focuses on transportation services, but the supporting communications infrastructure to support these services is critical to the successful implementation of ITS projects. Consequently some regions will create communications plans as part of their strategic plans to identify the issues, strategies, and regional solutions surrounding this important aspect of ITS deployments.

The common thread in the topics given above is the desire to better connect ITS deployments (as described in the regional ITS architecture) to the transportation planning process (as described by the LRP). The Strategic

Plan focuses on Management and Operations strategies (because that is the primary focus of ITS services), which are a required aspect of the LRP.



Regions should consider the content and organization of their LRP and develop an explicit connection between the goals, objectives, or policies of the LRP and the regional ITS architecture. This may involve going beyond the basic Policy/Rule definition (e.g. developing one or more of the topics listed above) but it will allow a clearer connection between their architecture and the planning process. Whether this takes the form of a separate ITS Strategic Plan or is contained in architecture documentation is entirely at the discretion of the region.

### 7.1.3 Other Planning Activities

As shown in Figure 33, several other planning activities provide inputs to the long range plan. These planning activities can also be supported by outputs of the regional ITS architecture as described below.

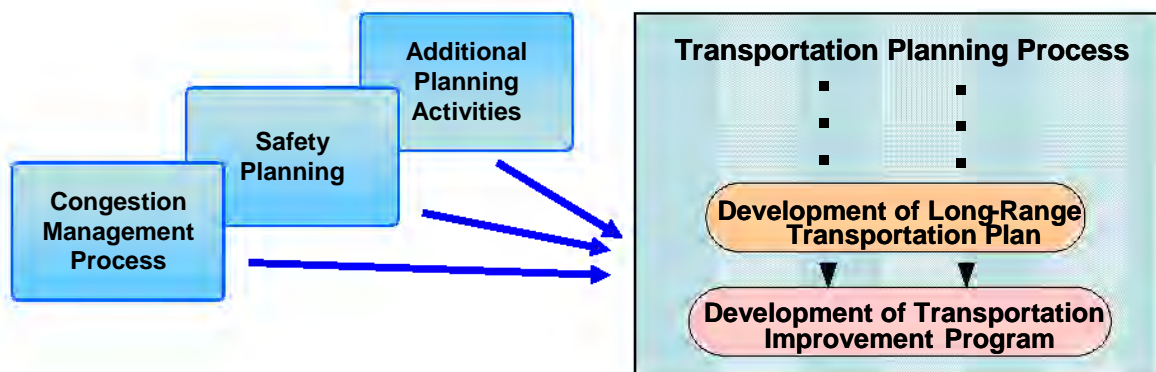

**Figure 33: Other Planning Activities**

#### Congestion Management Process

SAFETEA-LU defines the congestion management process (CMP) as: “Within a metropolitan planning area serving a transportation management area, the transportation planning process under this section shall address congestion management through a process that provides for effective management and operation, based on a cooperatively developed and implemented metropolitan-wide strategy, of new and existing transportation facilities eligible for funding under this chapter and title 23 through the use of travel demand reduction and operational management strategies.” The requirements for CMP were not changed by the new law, and would be familiar to planners under its old name- congestion management system. Figure 34 shows an overview of the steps involved in this process as well as the places where linkages can exist to the Regional ITS Architecture.

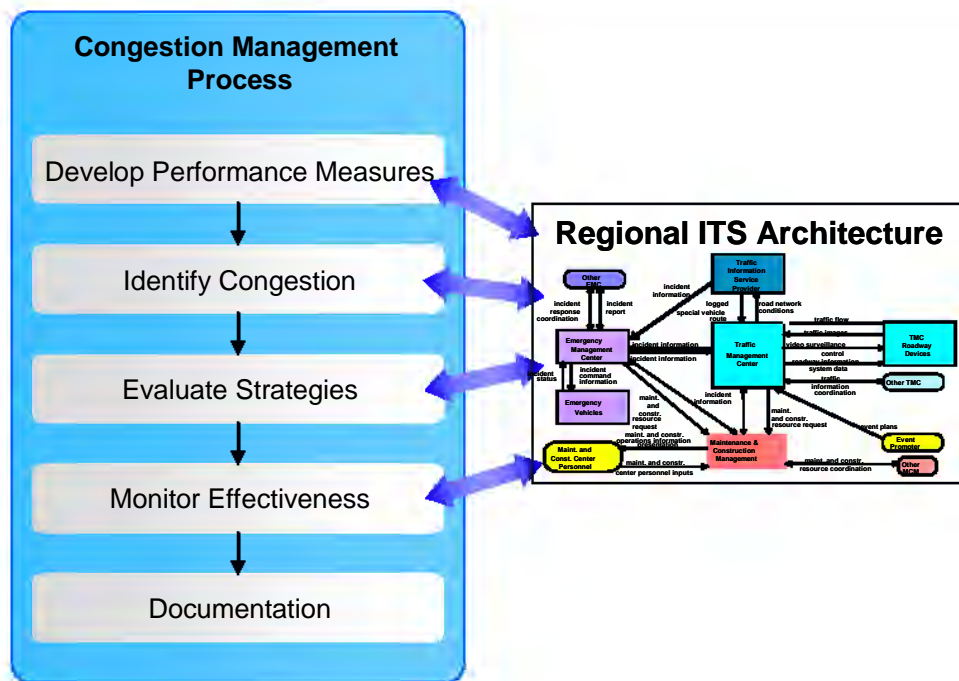

**Figure 34: Congestion Management Process**

The following will highlight the key steps in the CMP process and how the regional ITS architecture might support these activities.

The initial step in the process is to develop performance measures for the region that define the congestion and ways to mitigate it. These measures will be used to identify congestion and to support the evaluation of the effectiveness of congestion reduction strategies. The regional ITS architecture can define operational data sources that can be used to perform the measurement activities. In addition the architecture defines a set of interfaces that can support performance measurement. It is suggested that the performance measures consider not only recurring congestion, but non-recurring congestion. This latter issue is something that ITS related strategies are particularly good at addressing

In order to define the extent and duration of congestion as well as determine the causes of congestion, data collection or traffic monitoring capabilities must be implemented. Many of these data collection capabilities, either existing or new, represent ITS capabilities, and as such should be included in the regional ITS architecture. Where projects need to be implemented to provide data collection or traffic monitoring capabilities the regional ITS architecture, through the project sequencing output will provide the definition of the project.

The next step in the congestion management process is to define and evaluate travel demand reduction and operational management strategies to reduce congestion. These represent a subset of the overall regional strategies mentioned as part of the planning process shown in Figure 29.

And as such the regional ITS architecture defines services that can be included in the toolbox of ITS congestion management strategies.

Monitoring the effectiveness of the strategies selected requires evaluation of the efficiency and effectiveness of implemented congestion management actions. Some of these actions represent ITS projects that are described by the regional ITS architecture. Evaluation implies assessment of performance measures through capabilities such as data collection or traffic monitoring, and as stated above many of these capabilities would be defined in the regional ITS architecture, both from a description of the systems and interfaces and from the definition of the projects implemented to provide the capabilities.

Finally, the CMP involves documentation of the above steps (and their results), as well as definition of a process for periodic assessment of the efficiency and effectiveness of implemented strategies, in terms of the area's established performance measures.

These CMP steps provide outputs that support development of both Long Range Transportation Plans (described earlier) and Transportation Improvement Program (TIP), described in the next section.

### **Safety Planning**

SAFETY-LU introduced a new core Federal-aid funding program called the Highway Safety Improvement Program (HSIP), whose goal is to achieve a significant reduction in traffic fatalities and serious injuries on all public roads. This section of SAFETY-LU (1401) mandates that to access the funds from this program a state must create a Strategic Highway Safety Plan that identifies and analyzes safety problems and opportunities for correcting these safety problems. This safety plan is meant to be the result of consensus among a wide array of stakeholders including:

- a highway safety representative of the Governor of the State;
- regional transportation planning organizations and metropolitan planning organizations,
- representatives of major modes of transportation
- state and local traffic enforcement officials;
- representatives conducting Operation Lifesaver
- representatives conducting a motor carrier safety program
- motor vehicle administration agencies; and
- other major State and local safety stakeholders;

The plan should “address.. Engineering, management, operation, education, enforcement, and emergency services elements (including integrated, interoperable emergency communications) of highway safety as key factors in evaluating highway projects” (Section 1401(6) I).

The regional ITS architecture can support the development of these plans in several ways as shown in Figure 35:

- Stakeholder interaction
- Definition of safety related services
- Definition of projects to implement these safety services

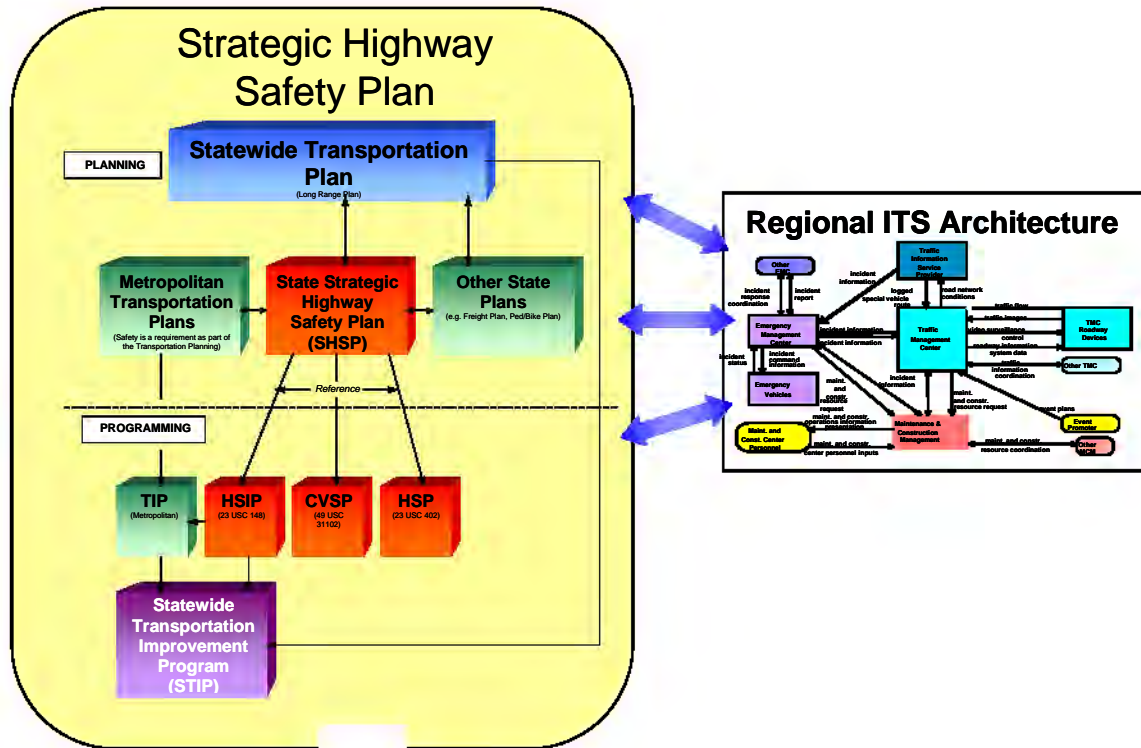

**Figure 35: Safety Planning and the ITS Architecture**

The list of stakeholders involved in the development of the plan includes many stakeholders involved in the development of the regional ITS architecture. The process of creating an architecture brings these various stakeholders together and facilitates communications and consensus between them, which can be useful for the development of the safety plan.

Some (but by no means all) of the solutions to safety problems that are included in the strategic highway safety plan are ITS services contained in the regional ITS architecture, which will contain a description of the systems, interfaces, and information flows that define the service. The outputs of the regional ITS architecture could be used directly in the safety plan to describe the ITS related solutions.

Finally, the project sequencing output of the regional ITS architecture contains projects that address safety issues, and information from the project sequencing can be used in the development of the safety plan.

**Additional Planning Activities**

There are several additional planning activities commonly performed at the regional or statewide level that can be supported by a regional ITS architecture. These include:

- Freight planning
- Security planning
- Operations planning

Many states and MPOs address freight planning as part of their long range planning efforts. Some take a more active approach by building statewide or metropolitan pictures of freight movement through the development of stand alone, integrated, multimodal freight plans. Still others have begun to develop analytical tools or freight data collection programs to develop freight performance measures or to help guide freight policy and transportation investment decisions. However addressed, freight planning covers the basic planning process steps identified in Figure 29 - identify goals (or needs), develop strategies to meet these goals or needs, evaluate the strategies, and document the recommended strategies. A regional ITS architecture may be of use in performing these steps if the architecture considered freight related services. In that case it would be used in a similar way to the discussion found in Section 7.1.1 Long Range Planning. In addition the commercial vehicle operations aspects of the architecture may be useful as a source of information on stakeholder, services, interfaces, and information flows that indirectly affect freight management.

Security planning may address many aspects of security including information security, operational security, personnel security, and security management. Information security deals with securing the origin, transmittal and destination of the information. Operational Security is responsible for protecting transportation assets against both physical and environmental threats. Personnel security is responsible for ensuring that transportation personnel do not inadvertently or maliciously cause harm to ITS assets and have proper training in the event there is a security-related incident. Security management provides the underpinnings for the other security areas and addresses among other things system security policy. A regional ITS architecture identifies security related services that would be applicable to the development of these types of plans.

Operations planning includes things like the planning for the level of investment needed in individual agencies, covering areas like Safety Service Patrols, Personnel, Maintenance Operations, Transit Operations, etc. The Regional ITS Architecture (or ITS Strategic Plan) can support aspects of these plans through the project sequencing output or through the description of services contained in the architecture.



## 7.2 Use for Programming/Budgeting/Capital Planning

Regional and statewide programming and agency capital planning (a.k.a. budgeting) involve identifying and prioritizing ITS projects. The result is funded projects. These processes are shown in Figure 36.



**Figure 36: ITS Project Programming/Budgeting/Capital Planning**

Using a regional ITS architecture to define an ITS project links the objectives and needs of the region identified in the architecture with the ITS deployed in the field. In a region, ITS projects are deployed by many organizations including the State Department of Transportation, transit agencies and many local agencies and authorities. If projects of the various organizations are defined from the same reference point, the regional ITS architecture, then coordination begins in the initial planning and funding phase.

ITS projects in a region may be funded by a variety of sources. ITS projects that are funded with federal funds are programmed by Metropolitan Planning Organizations (MPOs) and State DOTs with input from transportation agencies in the region. All organizations in a region, whether they use federal funds to deploy ITS or not, perform short term planning via their capital planning (i.e. budgeting) process.

### ***Architecture Use in Programming Federal Funds:***

The Transportation Improvement Program (TIP) is a staged, multiyear, intermodal program of transportation projects that is consistent with the long range transportation plan for a metropolitan area. At the statewide level there is a corresponding Statewide TIP (STIP) that is consistent with the long range statewide transportation plan. The TIP/STIP assigns federal funding to a prioritized list of specific projects to be constructed over a several-year period (usually three to six years) after the programs approval.

As discussed in Section 7.1, a regional ITS architecture can be adopted as part of or by reference in the Long Range Transportation Plan (LRTP). If this is the case, ITS projects should flow from the LRTP into the TIP in the same fashion as capital projects.

Whether the regional ITS architecture is incorporated into the LRTP or not, the architecture can be used to define ITS projects that are submitted for federal funding. In some regions, ITS projects in the TIP/STIP are not defined in much detail. Sometimes merely a placeholder for ITS projects is included. A benefit to using a regional architecture to define ITS projects is that the projects can be specified in greater detail thereby allowing more realistic estimates of the costs, benefits, schedule, etc.

The process for defining projects differs across the nation. In many regions, project sponsors (i.e. DOT, transit agencies, local agencies, etc.) submit projects to the planning agency for potential funding. Project sponsors should base the projects submitted on the needs of the region. As ITS needs were defined in the regional ITS architecture, the architecture can be used to define ITS projects as described below.



When project sponsors submit ITS projects for programming, some planning agencies require that the sponsors submit architecture-related information about the project. Some agencies merely require yes/no questions to be answered regarding the project's inclusion in the regional architecture while others request more detailed information such as the elements, services, and/or interfaces of the architecture to be deployed in the project. If an ITS project is submitted which is not included in or is not consistent with the regional architecture, a justification for the project should be required. If it is justified, the impacted stakeholders support the project, and the project is funded, the regional architecture should be revised to incorporate the project.

In the TIP/STIP, projects that contain ITS elements should be designated as ITS projects so that projects sponsors are aware of the associated requirements from the FHWA/FTA Rule/Policy. The Metropolitan Transportation Commission identifies ITS projects in their TIP (within their TIP software system, WEB FMS) as shown in Figure 37. The Anchorage Metropolitan Area Transportation Solutions (AMATS) has a checklist for project sponsors and the section on programming is shown in Figure 38.

The programming process involves prioritizing projects and using federal funds to fund the top priority projects. Each region has a process for prioritizing projects. The regional ITS architecture can be useful in this process as it reflects the vision for ITS in the region so a factor in prioritization should be how well a project fits within the regional architecture. In some regions, projects (of some categories) are allotted additional points if they include elements or interfaces of the architecture. For example, the Rhode Island State Planning Commission assigns points to projects that enhance their ITS network based on the scale shown in Figure 39.

1a. Is your project an Intelligent Transportation System (ITS) project or does it include ITS components? If you answer YES please also answer 1b and 1c. Y <input type="checkbox"/> N <input type="checkbox"/> Help/ info ⓘ
1b. Does your project have the potential to be a ' <i>major</i> ' ITS project? Y <input type="checkbox"/> N <input type="checkbox"/> Help/ info ⓘ
1c. Is your project included the Bay Area Regional ITS Architecture? Y <input type="checkbox"/> N <input type="checkbox"/> Help/ info ⓘ

**Figure 37: Metropolitan Transportation Commission ITS Projects Designation**

<p><b><u>Step One: Planning / TIP Development</u></b></p> <p><b><u>Project Agency Sponsors Agree to Comply with Federal ITS Regulations</u></b></p> <p>When a project is nominated or added to the AMATS Transportation Improvement Program (TIP), project agency sponsors will provide answers to the following questions in the <u>Project Information Packet during the project nomination process</u>:</p> <ol style="list-style-type: none"> <li>Does my project include any ITS elements? *</li> <li>Does my project use funds from the federal highway trust fund (including the mass transit account) now and/or in the future? If you are not sure, consult with the AMATS Coordinator.</li> <li>Does the project sponsor agree to comply with the federal ITS requirements?</li> </ol> <p>If the answer is YES to the first two questions, then your project <u>must</u> comply with federal requirements or AMATS could be subject to loss of funding. Project agency sponsors must agree to comply with the federal requirements. The agreement will be documented as specified by AMATS. Proceed to Step Two. If the answer is yes to the first question, but no to the second, project agency sponsors are <i>encouraged</i> to use the steps recommended in this Checklist to foster a more efficient system.</p> <ol style="list-style-type: none"> <li>ITS means electronics, communications, or information processing used singly or in combination to improve the efficiency of a surface transportation system.</li> </ol>
---

**Figure 38: AMATS Project Sponsor Checklist**

<p>g. Enhances Intelligent Transportation System network</p> <p>5 points: provides hardware and/or monitoring equipment to implement Rhode WAYS Strategic Deployment Plan or RIPTA ITS Plan (bus fareboxes, vehicle locators, etc.)</p> <p>1-4 points: installation of fiber-optic cable on off-system highway; enhances dissemination of information; provides for shared use of equipment already in place</p> <p>0 points: no ITS elements are part of the project</p> <p>negative points: project is on a RhodeWAYS route that calls for ITS equipment, but equipment not provided</p>
--

**Figure 39: Rhode Island State Planning Commission ITS Project Scoring**



A regional architecture may better support programming if the project sequencing and related architecture elements are updated on a maintenance schedule that supports the TIP cycle. The architecture should be updated prior to a project submittal request so that it can be used by project sponsors to identify projects. If thorough updates to the architecture are to correspond to LRTP updates, less major revisions to the architecture can be made to correspond to the TIP cycle.

### ***Architecture Use in Organization Capital Planning:***

All agencies including State DOTs, transit agencies, local municipalities, etc. use a budgeting process to allocate funds to projects. A regional ITS architecture should include the existing and planned elements of all stakeholders and how they are or will be interfaced with other ITS elements in the region. Therefore, all organizations can use the architecture to define ITS projects, as defined below, and feed them into their budgeting process.



Many ITS improvements are implemented as part of larger capital improvement projects. As traditional capital projects are defined and programmed, it is important to identify the associated opportunities for efficient ITS implementation. The regional ITS architecture is a record of the ITS implementation planned by each agency that can be used to identify these opportunities. Some agencies are considering policies to review each capital project to determine if ITS measures should be included before the project moves forward. Many agencies do this type of review as good practice, but these opportunities would be identified more consistently and “carry more weight” if this check was formally defined and required by an established policy. For example, Georgia DOT is incorporating such reviews to their Plan Development Process that sets the procedures and steps for administering Federal-Aid projects from project identification through construction award.

### ***Architecture Use to Identify and Define Projects:***

A regional ITS architecture includes a sequence of projects as described in Section 6. Projects from the architecture should feed into the programming and/or capital planning processes.

Some agencies and regions have created and used ITS Strategic Plans to define ITS projects. A strategic plan determines the ITS vision of the agency or region and how the vision will be deployed. A strategic plan identifies location-specific projects and the timeframe for deploying them. Typically an implementation plan for deploying the projects is defined. ITS projects are taken directly from the plan and submitted for funding (with Federal or other funds.)

As the projects defined in a regional ITS architecture are sequenced and have defined characteristics (See Section 6 on Project Sequencing for

information on defining projects), just as in an ITS strategic plan, organizations can use the architecture to define ITS projects to be submitted for funding from any source.

To obtain funding, a project sponsor must define a proposed ITS project. The information contained in a regional ITS architecture can be used to define projects with more detail in order to better scope them and establish project budget requirements.

Some potential ways a regional ITS architecture can be used to define an ITS project include:

- Review the list of stakeholders to identify those that should be involved with the project and those that are or may be impacted.
- Use the stakeholder roles and responsibilities defined in the operational concept to clearly define the roles and responsibilities of the stakeholders involved in the project.
- Review the relevant service(s) (i.e. market package(s)) to identify elements potentially directly or indirectly associated with the project and recognizing potential partners to share development costs, material and/or labor, facilities, etc.
- Use the defined interfaces between ITS elements to identify current and future integration opportunities.
- Utilize the sequence of projects to gain insight into the timelines and dependencies of a project with others including identifying opportunities to coordinate with capital projects.
- Apply the project description of the project sequencing including costs and benefits, technical feasibility, potential institutional issues and readiness to clearly define the project.
- Gain a thorough understanding of the elements and interfaces included in a project to more accurately estimate project budgets.

***Keys for Success (Process Recommendation):***

The most challenging issue to be addressed in the integration of a regional ITS architecture into the project planning process is the fact that there is more than one planning process in a region. Coordination is critical between the State Department of Transportation, MPO(s), and all organizations in their respective programs, budgets, and/or capital plans.

Another critical issue is coordination of Federally and non-Federally funded projects in a region. In many regions, non-Federally funded projects are generally not included in the TIP/STIP. A regional ITS architecture should contain all ITS elements and projects within the scope of the regional ITS architecture irrespective of funding source. As the ITS Architecture enables understanding and coordination of all ITS related projects for all stakeholders in the region, stakeholders can benefit from using an ITS Architecture to plan, program, and deploy all ITS projects not just those that are Federal funded and therefore, must meet the Rule/Policy requirements..



Agencies that sponsor integration projects that are identified in the regional ITS architecture may face several hurdles. Involvement by multiple agencies may add perceived risk to the project and the benefits from the project may be more regional in nature and difficult to quantify as hard savings for a particular agency. The region can offset these hurdles by promoting integration projects to encourage support from individual agency project sponsors. For example, the Maricopa County Area Governments (MAG) MPO has a documented process for ITS project prioritization that favors ITS integration projects that are identified in the ITS strategic plan and support multiple agencies. A prioritization process like this that favors integration projects with regional benefits can help to offset the hurdles faced by individual agency project sponsors.

To ensure ITS is deployed based on the regional vision contained in a regional ITS architecture, a process for local and regional planning and funding of projects based on the regional ITS architecture should be established. Policies and procedures to incorporate ITS projects in the programming/budgeting processes could be set or a group of various ITS stakeholders could be assigned the responsibility for monitoring the deployment of ITS in the region. The processes for deploying projects differs in every region so the process to best support ITS deployment based on the architecture should be adapted to the region's processes.

As an example, the New York State DOT (NYSDOT) has developed a process illustrated in Figure 40 (from their Dec 7, 2005 "Best Practices for ITS Standards" report):

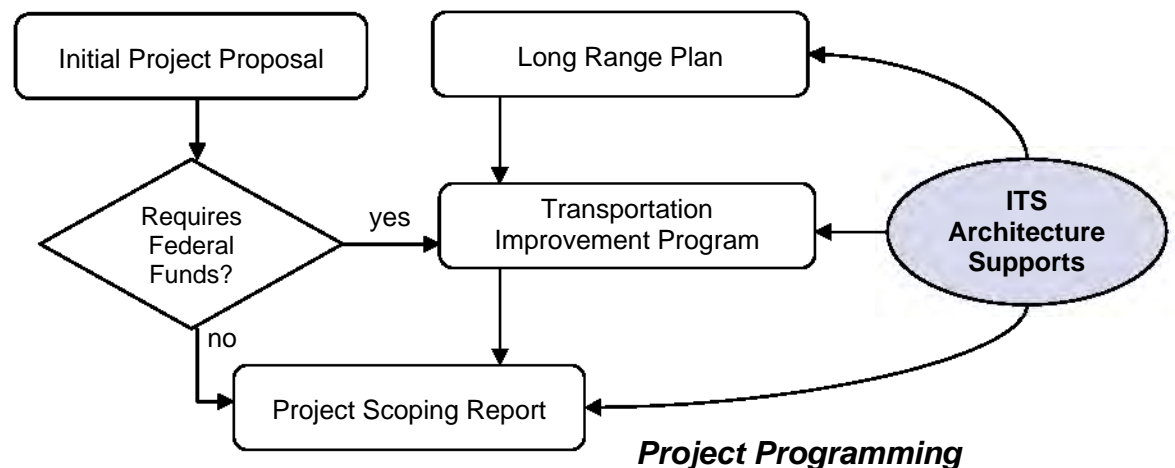

**Figure 40: NYSDOT Project Programming Process**

The "Initial Project Proposal" and "Project Scoping Report" are NYSDOT documents, and the LRP and TIP are local MPO documents. The Project Scoping Report is prepared for all funded projects, irrespective of the source of funds. Also, in any case, the project scoping report will describe ITS elements with interfaces and information flow interfaces that are inherited



from the regional ITS architecture. Although not shown in the figure, planning, programming, and project scoping activities also provide feedback to the ITS architecture since the evolving plans, programs, and project definitions should be reflected in future architecture maintenance activities.

## 7.3 Use in Project Implementation

Once an ITS project has been funded and implementation begins, there is a natural tendency to focus on the programmatic and technical details of the project to be implemented and lose sight of the broader regional context for the project. Using the regional ITS architecture as a basis for project implementation provides this regional context. It provides each project sponsor the opportunity to view their project in the context of surrounding systems. It prompts the sponsor to think about how their project fits within the overall transportation vision for the region. It identifies the integration opportunities that should be considered and provides a head start for the systems engineering analysis that is required for ITS projects.

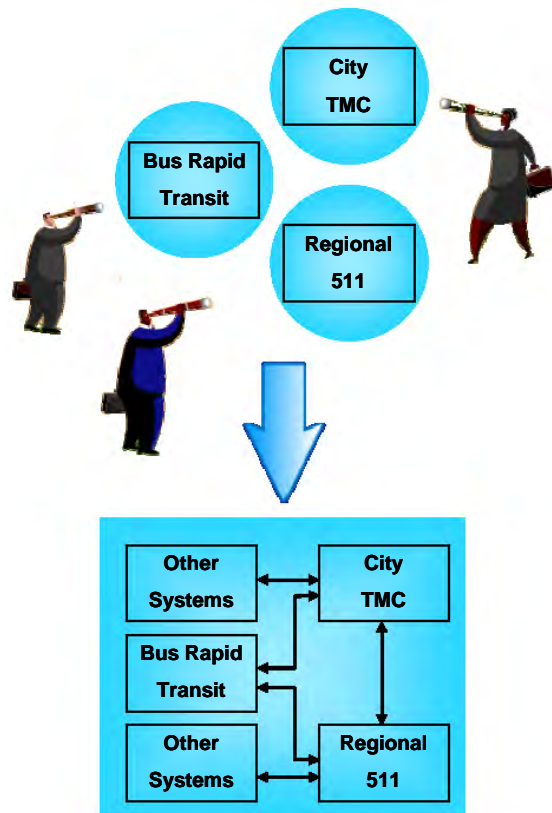

Due to these potential benefits, the Rule/Policy requires the regional ITS architecture to be used for project implementation. Specifically, FHWA Rule 940.11.c.1 and FTA National ITS Architecture Policy Section 6.c.1 require identification of the portion of the regional ITS architecture that is implemented by each ITS project.



### 7.3.1 Project Development Lifecycle

As described in previous sections, transportation projects are identified and funded through transportation planning and programming/budgeting phases. Funded projects are then implemented using a project development process that will vary with the type of project. For example, ITS projects that install field equipment (e.g., installation of variable message signs) use a process that is very close to the traditional project development process shown in Figure 41. ITS projects that include hardware and software development and integration will require additional systems engineering analyses that can be thought of as extensions to the traditional project development process.

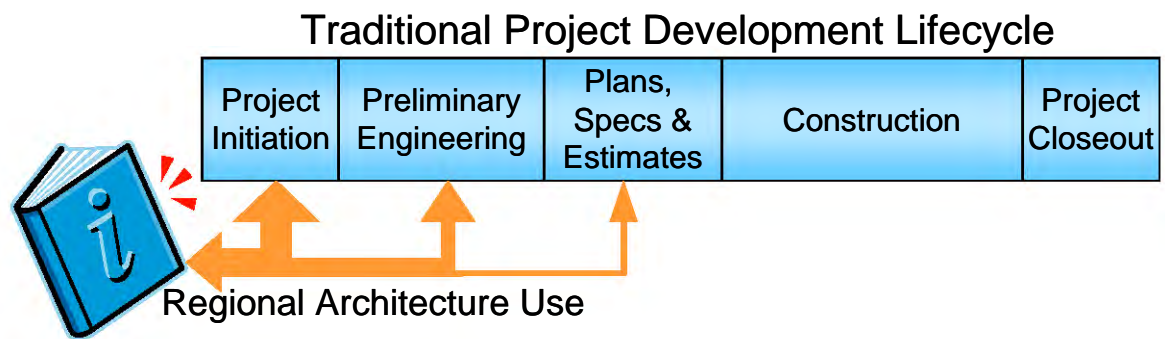

**Figure 41: Using the ITS Architecture in Project Implementation**

While project development processes vary from state to state and from organization to organization in each state, the transportation project development process tends to have the same major steps.

- **Project Initiation** – At this step, the project manager is identified, the project team is assembled, and the project development is planned. A high-level definition of the project is developed, costs are estimated, and the required forms and checklists are completed to garner approval for the project from the sponsoring and funding agency(ies). For FHWA and FTA, this is a critical point in the process where approval to proceed is given and federal funds are obligated. For the project sponsor, this is the best opportunity to consider integration opportunities and use the regional ITS architecture to inform the initial project scoping and definition. The regional ITS architecture can be used to define the project’s scope at this step – identifying the involved stakeholders and high-level roles and responsibilities, the portion of the regional ITS architecture to be implemented, and where in the project sequencing the project is identified.
- **Preliminary Engineering** – In the traditional capital project development process, environmental, right-of-way, and other studies are performed depending on the type of project. These studies result in better understanding of the project requirements and constraints. ITS projects that include a construction component will require these same studies as well as additional engineering analyses to fully specify the project requirements for the ITS portion of the project. The regional ITS architecture can contribute to these preliminary engineering analyses since it includes high-level functional requirements and interface definitions that can be used as a starting point. Note that from a federal aid perspective, “preliminary engineering” also includes PS&E. PS&E is split out separately here to differentiate between requirements and design steps in the traditional development process.
- **Plans, Specifications, and Estimates** – The detailed design for the project, complete with detailed project specifications, estimates of material needs, and associated costs are documented. In a traditional construction project, this process step provides companies with all the information they need to develop an accurate bid. Construction

elements within an ITS project will also require traditional design documentation (i.e., layout sheets, plan and elevation views, cross-section details, etc.). Design documentation is also required for the hardware and software components in an ITS project, but it takes the form of high level design, interface specification, and detailed hardware and software specifications. The architecture provides some input at this step, including information about ITS standards that may be relevant to the project.

- Construction – The project is built. For a traditional transportation project, this is construction of the actual physical improvement. For an ITS project, this includes the implementation of the actual hardware, software, and enabling products (e.g., manuals, operating procedures, and training). This step also includes inspection of the physical improvement(s) and integration and testing of the implemented system(s).
- Project Closeout – After final inspection/testing, the completed project is accepted, as-built plans are created, and a project history file is completed.

As shown, the best opportunity for use of the regional ITS architecture is early in the development process when the project is initiated and preliminary engineering is performed. The architecture is most valuable as a scoping tool that allows a project to be broadly defined and shown in a regional context. In later steps, when the project scope is firmly established and the project is defined in increasing detail, there is less opportunity to use the high-level definitions included in the regional ITS architecture. More detailed guidance for using the regional ITS architecture at each step in the project development process is defined later in this section.

### **Project Development Roles**

There are several distinct roles to consider when developing an approach for architecture use in your region. These roles include:

- Project Sponsor – This is the agency or group that advocates for a project and is responsible for project development. This could be any agency in the region – cities, counties, state DOT, public safety agencies, etc.
- Architecture Maintainer – This is the agency responsible for supporting and maintaining the regional ITS architecture. This is typically an MPO or State DOT.
- Project Manager – The individual with responsibility for project delivery, who manages the project so that it meets schedule and cost requirements and satisfies customer needs.
- Project Team – The people that work on the project including staff from the participating agency (or agencies), consultants, and contractors.
- FHWA/FTA Division Office – The division office is responsible for administration, oversight, and technical assistance for projects that use highway trust funds, ensuring that these projects meet federal requirements, including the FHWA Rule/FTA Policy.

### Architecture Use Challenges and Solutions

Regions must address a few challenges if the regional ITS architecture is to be used effectively to support project development. Across the country, regions are each encountering the same challenges and best practices are beginning to emerge that will encourage beneficial use of the architecture. Six challenges and their corresponding solutions are described below.

1. **Challenge:** While architecture maintenance responsibilities normally rest with a single agency, many agencies in a region are Project Sponsors that will need to use the architecture.

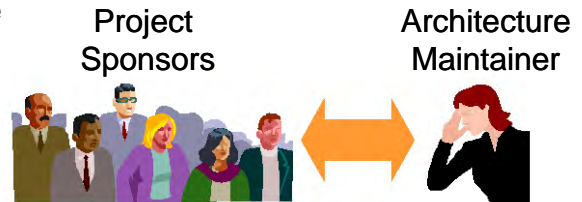

**Solution:** If it is to be used, the regional ITS architecture must be readily available to all Project Sponsors in the region. The latest version of the architecture should be available in a location readily accessible to all Project Team members. An architecture web page that provides access to the latest architecture information and resources is ideal. The form of the regional ITS architecture documentation should allow easy cut-and-paste into project documentation.

2. **Challenge:** Each of these Project Sponsor agencies has its own development process that must be adapted to use the regional ITS architecture if architecture use is to be systematic in the region.

**Solution:** The points at which the architecture should be used in project development should be formally documented for the state or region. In particular, an early checkpoint should be identified where the Project Team should have considered the architecture as the project scope is established so that integration opportunities are considered for each ITS project. A later checkpoint should be established where the Project Team should have verified that the as-designed project is consistent with the architecture and identified any regional ITS architecture changes that would be required to achieve this consistency.

### Example Architecture Use Checkpoints

Project Initiation	Preliminary Engineering	Plans, Specs & Estimates	Construction	Project Closeout
--------------------	-------------------------	--------------------------	--------------	------------------

◆ Architecture used to define project scope?

◆ Architecture reflects as-designed project?

The FHWA/FTA Division Office should play a leading role in defining these points in the process, integrating architecture use requirements with existing federal oversight requirements. Such top-down inclusion is the only way to ensure systematic architecture use by all Project Sponsors in the region.

The Puget Sound Regional Council maintains a “Developing Your ITS Project” web page at [http://www.psrc.org/projects/its/devp\\_projects.htm](http://www.psrc.org/projects/its/devp_projects.htm) that defines a four step process for developing an ITS project that uses the Puget Sound Regional ITS Architecture and meets Rule/Policy requirements. The page includes links to resources that project teams can use to define their ITS project.

3. **Challenge:** The Project Manager and Project Team may have little or no experience with the regional ITS architecture. While the architecture development process is inclusive, smaller agencies may not have participated, and only a few individuals from participating agencies actually develop expertise with the architecture. Staff turnover can further dilute architecture expertise over time.

**Solution:** Although not everyone will be an architecture expert, at least one member of every Project Team must be able to effectively use the architecture. If the Project Team does not have this expertise, then technical assistance must be provided by the Architecture Maintainer, FHWA/FTA Division office, or another resource to identify the relevant portion of the architecture for the project. To facilitate architecture use, the region should make the architecture as easy to use as possible, document instructions for use in project implementation, and make technical assistance and training available to Project Teams.

- a. The architecture documentation should be reviewed with a critical eye towards ease of use by Project Teams and revised as necessary to better support this critical use. Regions may find that their architecture is technically sound but should be revised so that it can be more easily used by Project Teams. In particular, it should be easy for users to navigate from one part of the architecture documentation (e.g., a particular inventory element) to other related parts (e.g., functional requirements, stakeholders, and interfaces).

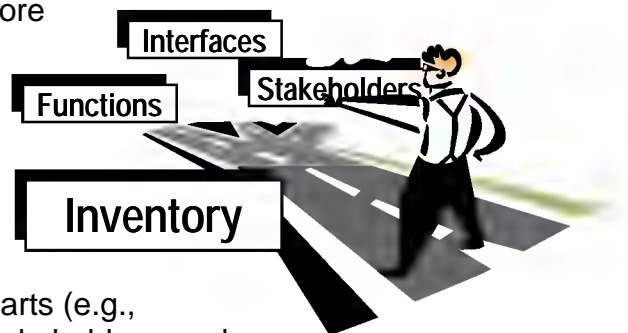

- b. The architecture should be supported by a roadmap for architecture use that can be used by each Project Team. The roadmap for architecture use includes step-by-step instructions for how the region’s architecture documentation should be used for project development.



- c. Turbo Architecture can be used to identify the portion of the regional ITS architecture that is included in a project, if the Project Team has access to Turbo Architecture and is familiar with its use. While this is an excellent way to use the architecture, it is unlikely that every Project Team will have access to the Turbo Architecture software or be able to use it without some training. The region must account for Project Teams that may not have Turbo Architecture expertise when establishing their process for architecture use.
  - d. Ease of use should be coupled with an effective technical assistance program that allows Project Teams to get the assistance that they need when they have a question about architecture use. As technical assistance is requested and provided, it is a good idea to continue to enhance the documentation available to every Project Team with a set of frequently asked questions and answers that can further facilitate future use.
  - e. Larger agencies should consider having an ITS specialist that can participate on ITS-related Project Teams and support architecture use as well as appropriate application of the systems engineering process and ITS standards. The ITS specialist becomes another specialist in the range of environmental, legal, and technical experts that are included on the Project Team, depending on the type of project.
  - f. Training in the region's ITS architecture, with focus on how to use the regional ITS architecture, should be available to Project Sponsors. This guidance document and the National ITS Architecture training course include general information on architecture use that could be used as a starting point and tailored to focus on the region's architecture and ITS project development process.
  - g. To ensure expertise by consultant members of the Team, include RFP requirements for knowledge/experience with regional ITS architecture and its use in ITS project procurements.
4. **Challenge:** ITS projects are location specific and the regional ITS architecture is normally defined at a higher level. For example, many different projects may implement field equipment that is generally represented with a single inventory element in the regional ITS architecture as shown in the comparison of Washington State DOT regional ITS architecture inventory elements with Washington State DOT transportation projects in Figure 42. As shown, there are many



Virginia DOT offers an interactive hands-on 1-day Training Course on Using the Northern Virginia (NOVA) ITS Architecture. This course is intended for project managers, planners, and system developers who plan, develop, and deploy ITS projects in Northern Virginia. See <http://www.vdot-itsarch.com/nova/training/training.htm>

projects that are implementing transportation improvements in the region covered by the two WSDOT field equipment elements.

### WSDOT Inventory



**The Gap**



### WSDOT Projects



**Figure 42: Architecture and Location-Specific Projects**

**Solution:** In order to effectively use the architecture, the Project Team must bridge the gap between the higher-level regional ITS architecture and the relatively specific definition of a particular project. The different levels of abstraction are a potential stumbling block that should be addressed in the region's guidance for architecture use. For example, the project block diagram in a concept of operations may be more specific than what is represented in the regional ITS architecture, but still traceable to the regional ITS architecture.



While it is sometimes beneficial, you should proceed with caution when adding detail to your regional ITS architecture so that it more precisely depicts individual projects. For example, a city may deploy field equipment with ten different projects over the course of several years. It is probably a mistake to include ten different inventory elements in the regional ITS architecture that specifically represent the equipment in each anticipated project. This would add too much detail to the regional ITS architecture and make it more difficult to maintain.

5. **Challenge:** Some ITS projects do not use the Highway Trust Fund and are not subject to the Rule/Policy requirements. Projects developed exclusively with local funds and projects developed by non-transportation agencies (e.g., public safety agencies) fall into this category. For these projects, use of the architecture is strictly voluntary and can only be motivated by the potential benefits of use.

**Solution:** Information on the benefits of architecture use should be available to every project sponsor, not only those who sponsor projects that use the Highway Trust Fund. Some agencies, such as Virginia DOT, have developed a user guide that encourages architecture use for ITS projects, whether or not Highway Trust Funds are used. To coordinate public safety projects, SANDAG, the San Diego MPO, has established a public safety committee that coordinates planning for public safety integration projects with SANDAG. The architecture

maintenance activity should periodically update the architecture to reflect other ITS projects that have been implemented so that the architecture continues to accurately reflect ITS implementation in the region.

6. **Challenge:** Some common projects that are categorized as ITS, like signal synchronization projects, impact only a single agency system and have lesser need to use the regional ITS architecture.

**Solution:** The purpose of the architecture use and systems engineering analysis requirements for ITS projects is to reduce technical risk and increase the likelihood of project success. Since the inherent risk in an ITS project varies significantly depending on the nature of the project, the Rule/Policy allows the systems engineering analysis to be tailored commensurate with project scope. Projects that will benefit most from architecture use include:

- Multi-modal or multi-jurisdictional projects that connect systems from different agencies.
- New system developments that must consider future integration requirements.

Projects that are inherently limited in scope will benefit less from architecture use, such as:

- Installation of isolated rural traffic signals and other projects that have no reasonable opportunity for future integration
- System expansions that add no new interfaces and no new functionality (e.g., adding additional CCTV cameras to an existing system)
- Projects that enhance current system operation, but add no new interfaces or functionality (e.g., signal synchronization projects)

There is some potential benefit from architecture use on even the simplest ITS projects. For example, signal synchronization projects may benefit from architecture use in regions where integration of adjacent traffic signal systems is planned. The FHWA/FTA Division Office determines how the Rule/Policy should be applied to different types of ITS projects in the region. For example, the California Division Office has established oversight procedures that require architecture use for all ITS projects, but only require direct oversight for higher risk “major” ITS projects. Some regions have established graduated processes where more detailed architecture use is suggested for more complex projects. For example, Virginia DOT has established guidelines for architecture use that require project architectures for more complex projects that include more than three stakeholders. An early project initiation checkpoint should include information about the project that allows project type and complexity to be determined so appropriate architecture use and systems engineering analysis processes can be defined.

### 7.3.2 Systems Engineering for ITS Projects

The regional ITS architecture provides a starting point for systems engineering analyses that are performed during ITS project development. Systems engineering is an interdisciplinary approach for systems development that is used in many different industries because it contributes to project success. Every ITS project manager wants a successful project, where “success” is measured by:

1. the cost and schedule performance of the project.
2. how well the implemented system ultimately satisfies the needs of the people who use it.

The primary benefit of systems engineering is that it will reduce the risk of schedule and cost overruns and increase the likelihood that the system will meet the user’s needs. Other frequently cited benefits include:

- better system documentation
- better stakeholder participation
- shorter project cycles
- resilient systems that can evolve without major redesign
- increased component reuse
- more predictable outcomes

Figure 43 is a systems engineering “V” model that graphically depicts the systems engineering approach. The core systems engineering project development processes that are the focus of this section are enclosed in a dashed box at the center of the “V”.

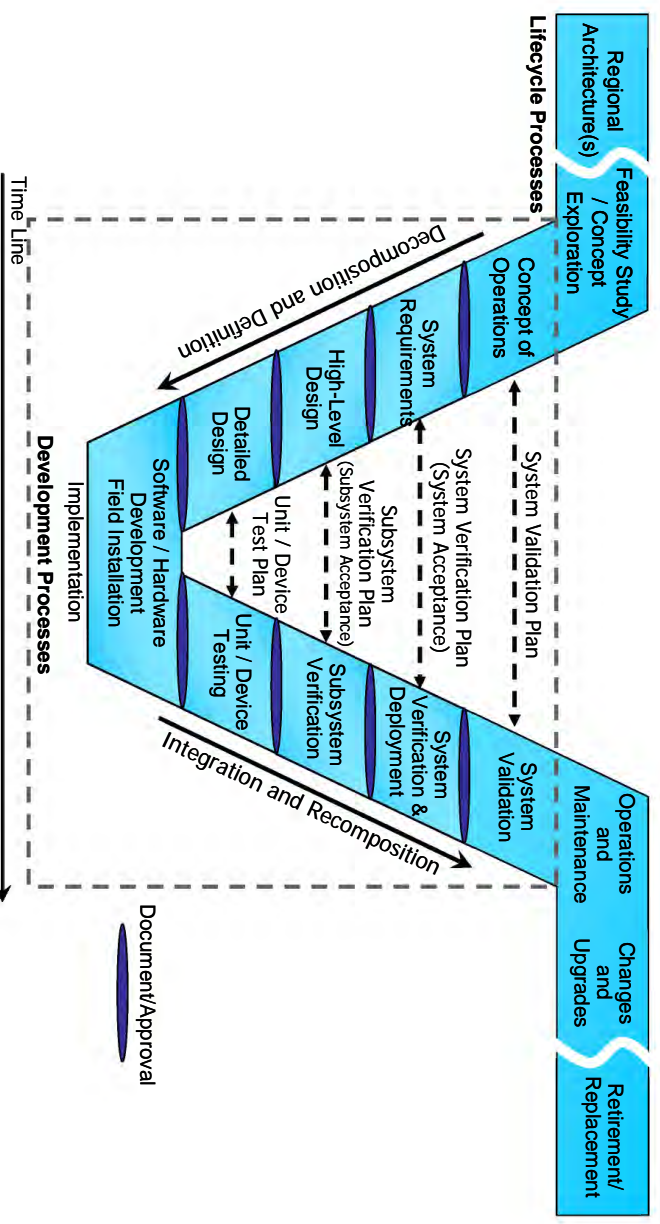

Figure 43: Systems Engineering Approach

The “V” diagram also includes two wings that show the broader project lifecycle from initial project identification at the beginning of the lifecycle through system retirement or replacement at the end of the lifecycle. An important aspect of the systems engineering process is that the entire project lifecycle is considered during project development.

A systems engineering approach requires up-front planning and system definition so that the project requirements are identified and documented, before technology choices are made and the system is implemented. On the left side of the diagram, the system definition progresses from a general user view of the system to a detailed specification of the system design. As development progresses, a series of documented baselines are established that support the following steps. For example, a consensus concept of operations supports system requirements development. A baseline set of system requirements then supports system design. The hardware and software are implemented during coding and fabrication shown at the bottom of the diagram, and then the components of the system are integrated, tested, and verified in iterative fashion on the right. Ultimately, the completed system is validated to measure how well it meets the user’s needs. Significantly, there is traceability from one step to the next and also traceability between steps on both sides of the diagram since the system definition that is generated on the left is used to verify the system on the right. The user needs that are identified in the very first step of the process are used to validate the completed system as part of system validation.

In addition to the process steps identified in the “V”, there are several cross-cutting activities that contribute to successful projects. Development of a systems engineering management plan (SEMP), configuration management, risk management, and project monitoring and control are all best practices that are associated with systems engineering that will benefit ITS projects.

Following a system engineering approach during implementation of ITS projects is a key requirement of the Rule/Policy. However, providing guidance for systems engineering is beyond the scope of this document. For additional resources or training on system engineering, refer to the ITS Resource guide, (<http://www.resourceguide.its.dot.gov/>), the NHI website (<http://www.nhi.fhwa.dot.gov/>), or the International Council on Systems Engineering (INCOSE) website (<http://www.incose.org>) for more information. In addition to these national systems engineering resources, several states have developed systems engineering guidance for ITS projects including the Systems Engineering Guidebook for ITS, created by the FHWA California Division and Caltrans ([http://www.dot.ca.gov/research/se\\_guidebook\\_ver1-12\\_14\\_05.pdf](http://www.dot.ca.gov/research/se_guidebook_ver1-12_14_05.pdf)) and the Florida DOT Systems Engineering Management Plan ([http://www.dot.state.fl.us/TrafficOperations/ITS/Projects\\_Deploy/SEMP.htm](http://www.dot.state.fl.us/TrafficOperations/ITS/Projects_Deploy/SEMP.htm)).



### **Systems Engineering and the Traditional Project Development Process**

As it evolved through a century of building roads and public transit systems, the transportation project delivery process used by most agencies today









For additional resources or training on ITS procurement, refer to the ITS Resource guide, (<http://www.its.dot.gov/itsweb/guide.htm>) or the NHI website: <http://www.nhi.fhwa.dot.gov/> for more information.

### Rule/Policy Systems Engineering Analysis Requirements

US DOT recognized the potential benefit of a systems engineering approach and included requirements for a systems engineering analysis for ITS projects in the FHWA Rule/FTA Policy. The Rule/Policy requires a system engineering analysis to be performed for ITS projects that are funded through the highway trust fund. As shown in Figure 45, the Rule/Policy specifies seven requirements that the systems engineering analysis must include **at a minimum**. The systems engineering analysis requirements in the Rule/Policy focus on the first few steps of the systems engineering approach. The regional ITS architecture can be used to support the Rule/Policy requirements as well as the broader systems engineering approach that is recommended for ITS projects.

In California, a “Systems Engineering Requirements Form” or SERF must be completed by the project sponsor at Project Initiation. This form, included in the Caltrans Local Assistance Procedures Manual, includes one question for each of the seven systems engineering requirements in Rule 940.11, including the requirement to map the project into the regional ITS architecture. The SERF checklist is a streamlined form only one or two pages long, but it is enough to ensure that each project sponsor determines the mapping between the project and the regional ITS architecture and the project plan will address the other systems engineering requirements of the rule. **Virginia DOT** has also implemented a Systems Engineering and Architecture Compliance (Rule 940) checklist for use in Northern Virginia.

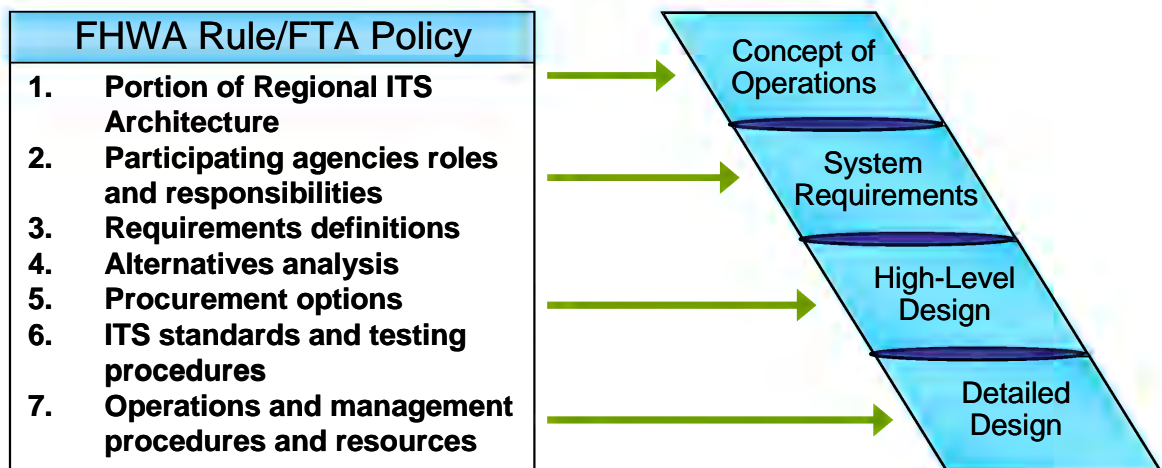

Figure 45: Rule/Policy Systems Engineering Analysis Requirements



Since every regional ITS architecture is a bit different, each architecture's utility in supporting the systems engineering process will vary. For example, regional ITS architectures that include tailored functional requirements will provide a better starting point for project system requirements definition than regional ITS architectures that have fewer generic requirements. The region should take a candid look at the utility of their regional ITS architecture in the project implementation process and refine it over time so that it provides the best possible support for each project sponsor's systems engineering process.

#### **7.3.4 Mapping Your ITS Project to the Regional ITS Architecture**

In order to use the regional ITS architecture to support project development, the portion of the regional ITS architecture that will be included in the project must be identified. This is a key step in architecture use because this is when the ITS project will be viewed in the broader context of the regional ITS architecture. This is when the services, functionality, and integration opportunities envisioned in the region are reviewed and considered as the basic scope of the project is defined. This step is also required to meet the FHWA Rule/FTA Policy. While the components that should be identified as part of this "subset" are not specified by the Rule/Policy, the following components, taken together, precisely define the scope of the project in terms of the regional ITS architecture:

- Inventory Elements
- Functional Requirements
- Information Flows

These three components define the system(s) that will be created or impacted by the project, the functionality that will be implemented, and the interfaces that will be added or updated.

If integration opportunities are to be considered, the regional ITS architecture should be used as early in the project development lifecycle as possible. The architecture should be reviewed before firm project cost estimates are established, while there is still opportunity to adjust the scope to accommodate the functionality and interfaces identified in the regional ITS architecture. This opportunity may occur before or after programming/budgeting, depending on how specifically the ITS project is defined in the TIP/STIP or other programming/budget document.

#### **Finding the Right Components**

It can be difficult to find the components that apply to a project, particularly if the Project Team is unfamiliar with the regional ITS architecture. The best approach for identifying the portion of the regional ITS architecture for a particular project will vary since each regional ITS architecture is defined a bit differently. There are a few logical entry points to the regional ITS architecture that may be of use to the Project Team – chances are that one of these approaches will work best in your region.

### *Start with Transportation Services*

Transportation services, which are typically represented as market packages, are an excellent way to begin to isolate the portion of the regional ITS architecture that may apply. By identifying the service that the project performs and finding this service in the list of market packages included in the regional ITS architecture, the portions of the architecture related to that service can be identified and then tailored for the project. Note that in most cases, the market package will have to be further refined to precisely match the scope of the project.

### *Start with Project Sequencing*

The connection between the regional ITS architecture and ITS projects is clearest if the project to be implemented is identified in the project sequencing portion of the regional ITS architecture documentation. If the project is identified and explicitly related to the regional ITS architecture in the project sequencing section, then this is probably the best entry point for the Project Team to use. If the project is not included in the project sequencing documentation, then feedback should be provided to the Architecture Owner so that the architecture can be updated to reflect the range of projects that are actually being implemented in the region.

### *Other Starting Points*

Depending on the architecture documentation, the Project Team could locate the target system(s) in the list of inventory elements or identify the stakeholder(s) associated with the project in the list of stakeholders. Depending on the linkages in the architecture documentation, one of these entry points can be used to find the portion of the regional ITS architecture that is most relevant to the project to be implemented.



In order to facilitate use by numerous Project Teams, each region should define a roadmap for architecture use that takes advantage of the strengths of their specific regional ITS architecture. The roadmap should identify the best entry point(s) (e.g., Market Packages, Project Sequencing, Inventory Elements, etc.) for that architecture, how to locate the relevant item in the list, and how to navigate to other related items in the architecture documentation.

### **Considering Additional Integration Options**

In almost every case, the regional ITS architecture will identify integration opportunities that will not be included in the current project. Integration options may be deferred for many reasons – agencies on both sides of the interface may not be ready, there may not be sufficient funding or time available to implement everything, supporting infrastructure may not yet be completed, a necessary standard may not be available, implementing too much at once may incur too much complexity/risk, etc.

It is important to explore these integration opportunities so that they are accounted for and supported in the project design, even though they may not be implemented with that specific project. The ultimate goal is to make ITS

deployment as economical as possible by considering how this project will support future projects over time. To support this goal, future integration options that may impact the project design should be identified and considered in the project development. For example, additional stakeholders may be involved in the current project to ensure that future requirements are identified and factored into the current project design.

**Example Output**

The subset of the regional ITS architecture that is included in the project can be shown in a series of simple tables or a diagram from Turbo Architecture, as shown in Figure 47. This figure identifies the inventory elements and interfaces that will be implemented by the Maine DMS project. Functional requirements that are relevant to the project would also be extracted. A subset of these requirements are shown later in this chapter, in Table 15.

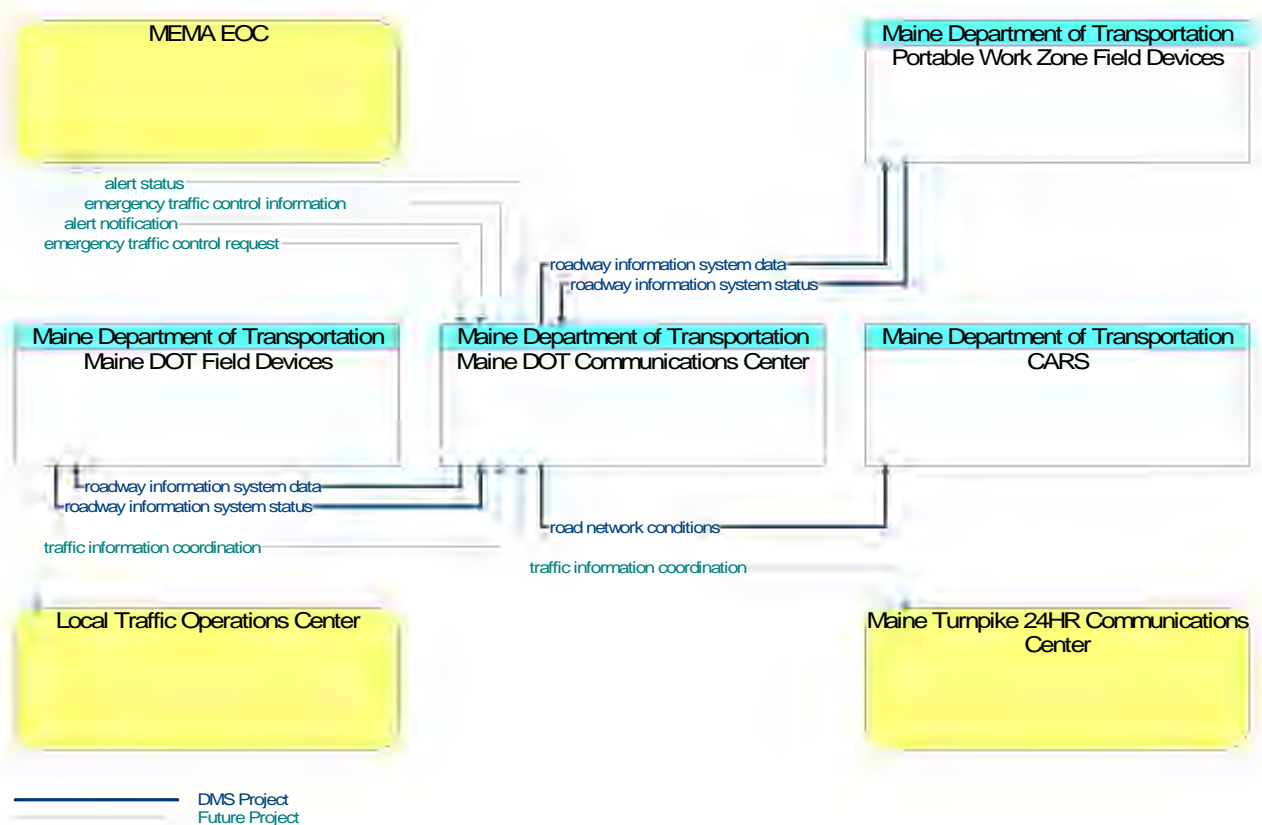

**Figure 47: Example Maine DMS Project Architecture Subset**

As shown in the figure, the DMS project will include both portable and fixed dynamic message signs (represented as field devices in the regional ITS architecture), control software in the MaineDOT Communications Center, and an interface to the Condition Acquisition and Reporting System (CARS) so that sign information can be distributed as traveler information. Future interfaces that are related to DMS operation from the regional ITS architecture including coordination with local cities to coordinate traffic diversions, coordination with the MEMA EOC to support use of the signs in



emergencies, and coordination with the Maine Turnpike are also included in the diagram for context, although they are not included in this project.



It is a good idea to include additional interfaces that are closely related to the project, as shown in the previous example. This gives some context for the project and conveys information to the project team about how this project will fit with other future projects. Where this is done, the documentation should be clear about the subset that is actually included in the current project. It is also important not to include too much additional information – the goal is to include only components that are in some way relevant to this particular project, particularly those that may influence project design decisions.



If Turbo is used, then a project ITS architecture can be specified that collects together all the relevant portions of the architecture for that project. See the Turbo Architecture User’s Manual and Turbo Architecture training course that is offered through the National Highway Institute (<http://www.nhi.fhwa.dot.gov/>) for more information.

### 7.3.5 Use in Concept of Operations Development

A well-defined regional ITS architecture provides a good starting point for developing a concept of operations (ConOps) for an ITS project. The purpose of the ConOps is to clearly convey a high-level view of the project to be developed that each project stakeholder can understand. The components of the regional ITS architecture provide a high-level description of the ITS systems in the region, which can often be directly incorporated into a project ConOps. Several of the regional ITS architecture components can be used, as shown in Figure 48, which relates the regional architecture to a typical outline for a ConOps based on the industry standard, ANSI/AIAA G-043-1992. The ConOps for an ITS project should include this information and many more details specific to the project as described in the following paragraphs.

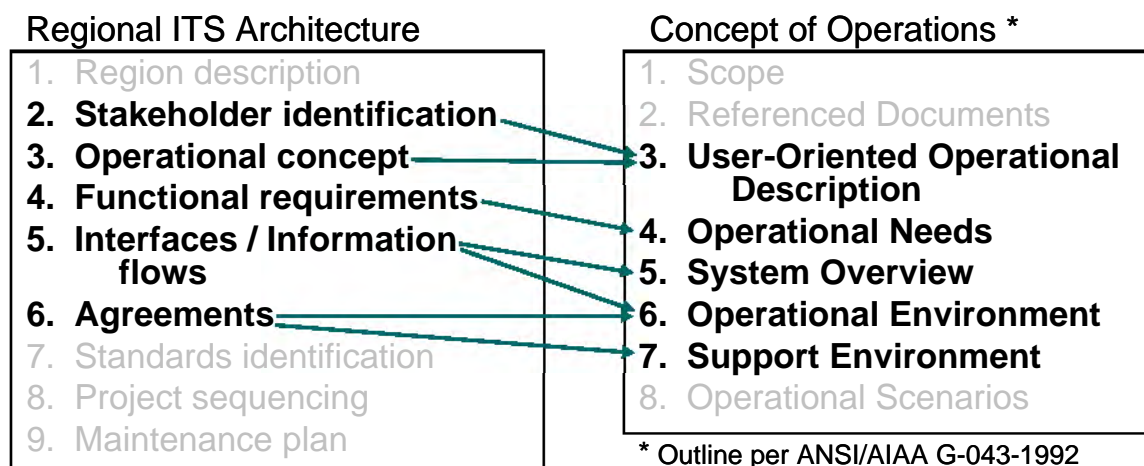

**Figure 48: Architecture Use for Concept of Operations Stakeholder Identification**



A ConOps should describe the system from the perspective of each stakeholder. The relevant stakeholders that are identified in the regional ITS architecture are a good starting point for the list of stakeholders considered in the ConOps. The Project Team may need to add stakeholders or provide additional specificity for selected stakeholders. For example, in the Maine DMS Project, the “MaineDOT” stakeholder identified in the regional ITS architecture is further distinguished into separate MaineDOT divisions – Planning, Maintenance and Operations, and Information Services because each MaineDOT division has a distinct role in the project.

### **Operational Concept**

The agency roles and responsibilities that are specified in the ConOps can be derived from the operational concept that is included in the regional ITS architecture. This operational concept can serve as a starting point for a more detailed definition of the operational roles that are described in the ITS Project ConOps.



The specification of participating agencies’ roles and responsibilities is a required part of the Systems Engineering Analysis as specified in the Rule/Policy.

### **Functional Requirements**

The high-level functional requirements that are defined in the regional ITS architecture are frequently defined at a level that is commensurate with the operational needs that should be defined in the ConOps. The operational needs that are defined in the ConOps then provide a basis for the project requirements that are defined later in the systems engineering process. The high-level requirements from the regional ITS architecture can be included in the ConOps and modified and expanded as necessary so they represent the operational needs of the specific project.

### **Interfaces / Information Flows**

The ConOps includes a high-level project description that is normally supported by a high-level system block diagram. This system description can be based on the interfaces and information flows that are extracted from the regional ITS architecture. Depending on the regional ITS architecture and the nature of the project, the project description that is derived from the regional ITS architecture should be refined so that it is as easy to understand as possible in the ConOps. For example, Figure 49 is a block diagram for the example Maine DMS project that is derived from the regional ITS architecture diagram in Figure 47, but it is specifically focused on the DMS project (e.g., “DMS” is used rather than “Field Equipment” and controllers that are hidden in the regional ITS architecture are shown).

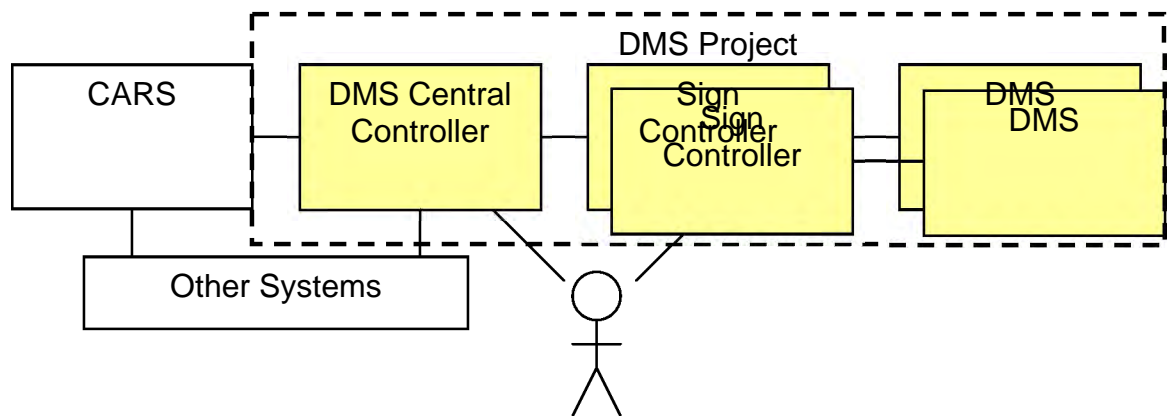

**Figure 49: DMS Project Example Diagram**

The relationship to the regional ITS architecture that is developed for each project (see paragraph 7.3.3) should also be included in the ConOps. If the ANSI/AIAA outline is used for the ConOps, this information would logically fit in the Operational Environment paragraph, or the outline could be tailored and a specific “Relationship to the Regional ITS Architecture” paragraph could be added.

### **Agreements**

System integration is as much an institutional challenge as it is a technical systems engineering exercise. The regional ITS architecture identifies regional agreements that may be relevant to the project. Necessary agreements should be identified for the project and listed in either the project plan or the ConOps. If the ANSI/AIAA outline is used, the list of agreements would logically fit in either the operational environment or support environment sections. The location of the list of agreements isn’t so important as long as it is included in the document and the project plan addresses the creation of the necessary agreements. If necessary agreements are not represented in the regional ITS architecture, feedback should be provided to the Architecture Maintainer.

### **7.3.6 Use in System Requirements Development**

The functional requirements and interfaces defined in the regional ITS architecture can be used to support system requirements definition as shown in Figure 50. The functional requirements associated with the inventory element(s) that are included in the project can be scanned to identify requirements that cover the required functionality for the project. These functional requirements can be one of the inputs to system requirements definition. In addition to the functional requirements, the project interfaces that are identified in the regional ITS architecture should also be supported by system requirements associated with each interface.

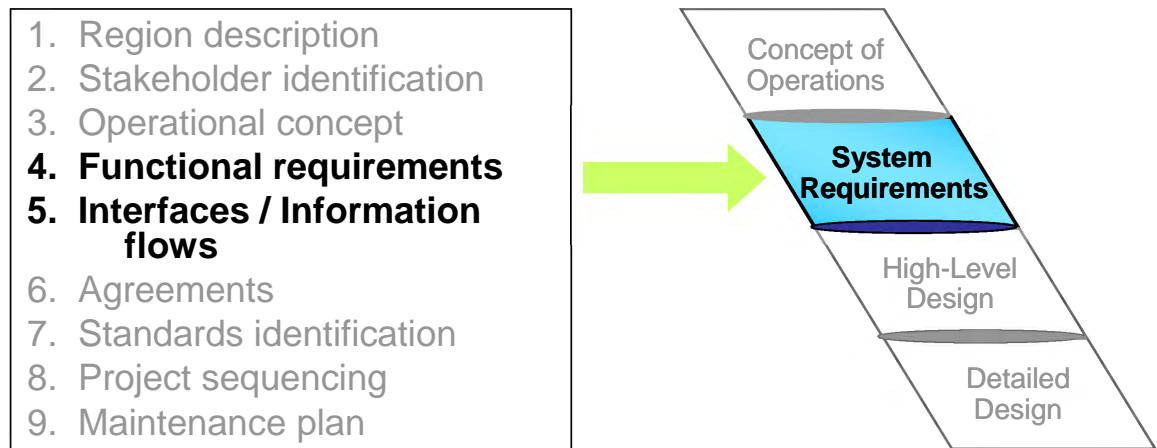

**Figure 50: Architecture Use in System Requirements Development**

Of course, the project’s system requirements should be defined in greater detail than the high-level functional requirements that are included in the regional ITS architecture. The system requirements should also address performance, development, operations and maintenance, and other requirements that are typically not included in a regional ITS architecture as shown in Figure 51. While the requirements included in the regional ITS architecture are only a starting point, it is better to start with these requirements than it is to start from scratch. By starting with the regional ITS architecture requirements, the Project Team can get a head start and also maintain continuity between the regional ITS architecture and the region’s projects.

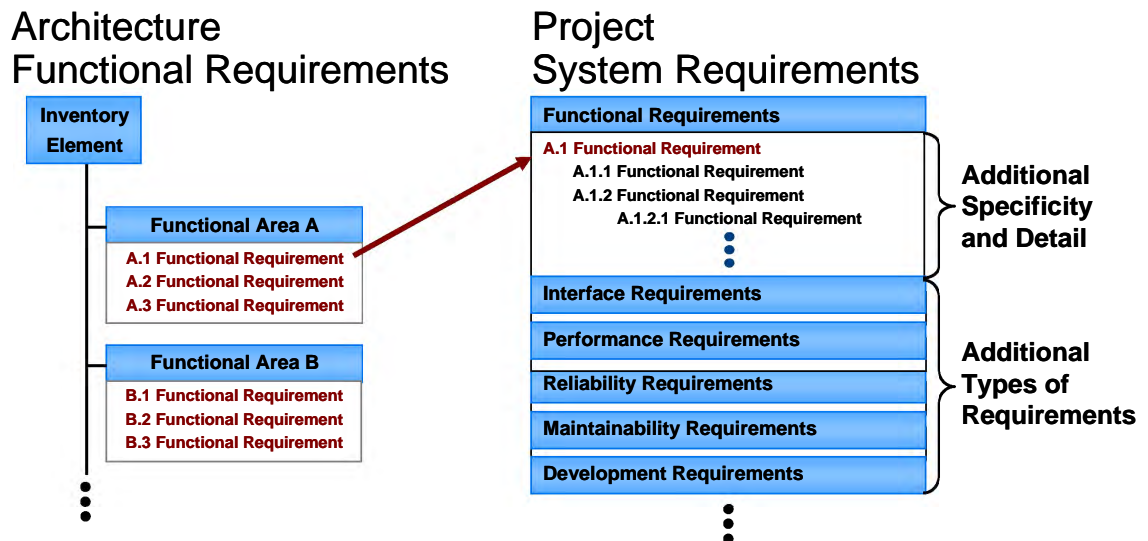

**Figure 51: Project System Requirements Analysis**



Requirements definitions are a required part of the Systems Engineering Analysis as specified in the Rule/Policy.

The functional requirements associated with the project may be extracted and

used as shown in the excerpt of requirements associated with the Maine DMS project in Table 15.

**Table 15: DMS Project Functional Requirements (Partial List)**

Element	Functional Area	ID	Requirement
MaineDOT Communications Center	TMC Traffic Information Dissemination	1	The center shall remotely control dynamic messages signs for dissemination of traffic and other information to drivers.
MaineDOT Communications Center	TMC Traffic Information Dissemination	3	The center shall collect operational status for the driver information systems equipment (DMS, HAR, etc.).
MaineDOT Communications Center	TMC Traffic Information Dissemination	4	The center shall collect fault data for the driver information systems equipment (DMS, HAR, etc.) for repair.

Each of these requirements from the regional ITS architecture would then be expanded into detailed functional requirements. For example, the single requirement to control the DMS signs that is included in the regional ITS architecture could be a high-level requirement that is expanded into many requirements for message definition, message management, message display, message scheduling, and message prioritization.

**7.3.7 Use in Project Design**

The regional ITS architecture can be used by project designers as the starting point for the project high-level design and to identify the ITS standards that may be applicable to the project as shown in Figure 52.

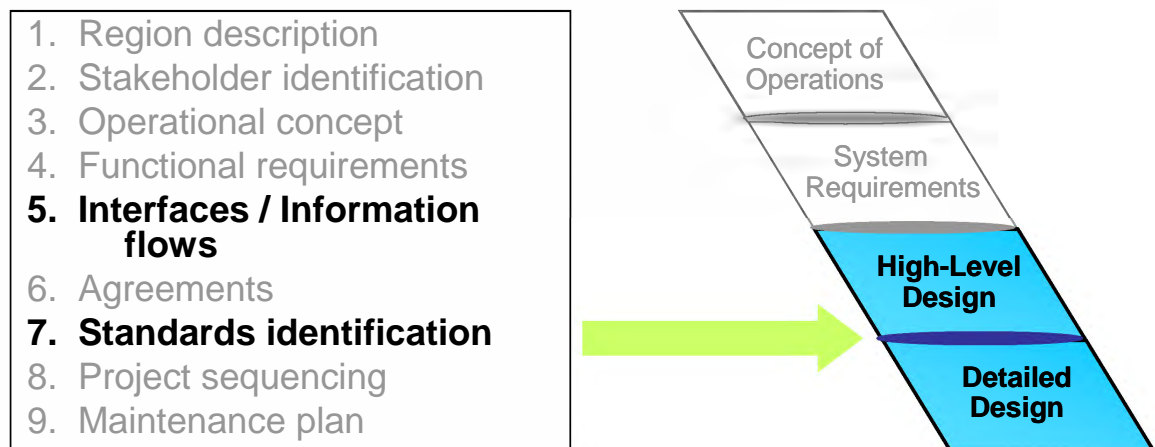

**Figure 52: Architecture Use in Project Design**

The subset of the regional ITS architecture identified in paragraph 7.3.3 forms the basis for the high-level or architectural design for the project. The subset of the regional ITS architecture should identify the key inter-agency interfaces (if any) that the project must support as well as major system interfaces. The project architectural design then adds significant detail, but retains traceability back to the architecture framework, as shown for the example Maine DMS project in Figure 53. By developing an architectural design for the project that maps back to the regional ITS architecture, there is traceability through the process, connecting planning and implementation.

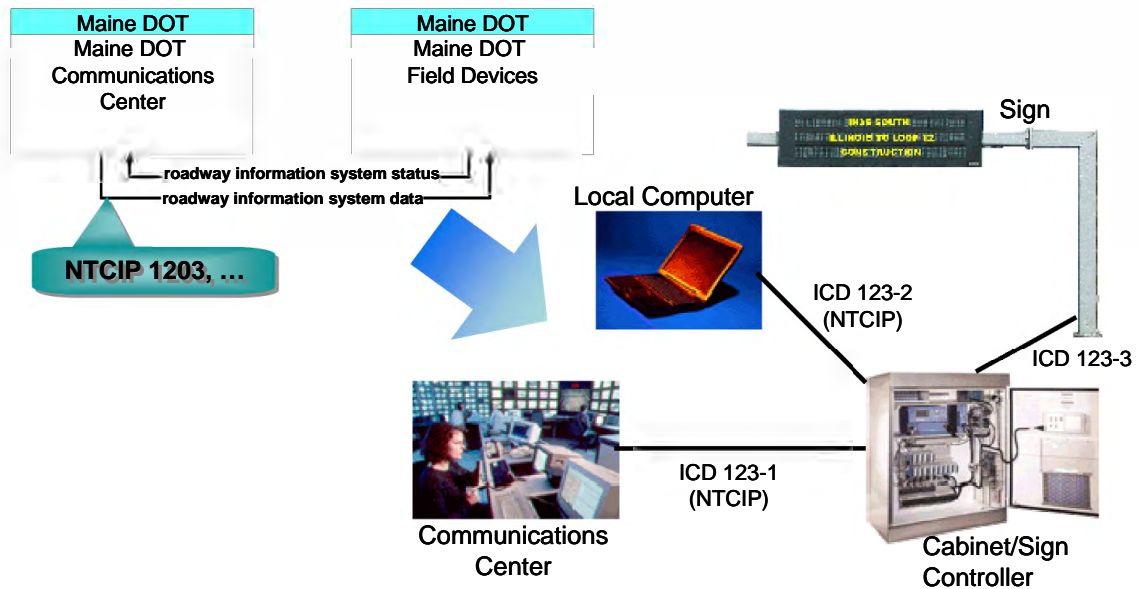

**Figure 53: Example DMS Project Architectural Design**

The regional ITS architecture includes a map to ITS standards that can be used to identify the applicable ITS standards for the project. For example, the standards that are identified in the regional ITS architecture for the example Maine DMS project are shown in Table 16.

**Table 16: DMS Project ITS Standards**

Document ID	Standard Title
NTCIP 1101	Simple Transportation Management Framework (STMF)
NTCIP 1102	Base Standard: Octet Encoding Rules (OER)
NTCIP 1103	Simple Transportation Management Protocol (STMP)
NTCIP 1201	Global Object Definitions
NTCIP 1203	Object Definitions for Dynamic Message Signs
NTCIP 2101	Point to Multi-Point Protocol Using RS-232 Subnetwork Profile
NTCIP 2102	Subnet Profile for PMPP Over FSK modems
NTCIP 2103	Subnet Profile for Point-to-Point Protocol using RS 232
NTCIP 2104	Subnet Profile for Ethernet
NTCIP 2201	Transportation Transport Profile

Document ID	Standard Title
NTCIP 2202	Internet (TCP/IP and UDP/IP) Transport Profile
NTCIP 2301	Application Profile for Simple Transportation Management Framework (STMF)
NTCIP 2302	Application Profile for Trivial File Transfer Protocol
NTCIP 2303	Application Profile for File Transfer Protocol (FTP)

The standards that are identified in the architecture are only a starting point for the project design specification. Typically, only a subset of the identified standards will actually be used in the project and substantial detail must be included in the specification to identify the portions of the standard that are relevant to the particular procurement.

Some regions have created standards plans as part of their architecture that define the approach for incorporating standards into ITS projects over time. If such a plan exists, it should be consulted for guidance on standards implementation. Feedback should also be provided to the regional architecture maintenance organization if the standards plan does not accurately reflect the preferred use of standards on the project. Section 6.3.3 describes ITS standards plans in more detail.



Several resources describe how to specify ITS standards requirements for ITS procurements. The ITS Standards Program web site includes the most current information on ITS standards, including available deployment resources (<http://www.standards.its.dot.gov>).



The specification of applicable ITS standards is a required part of the Systems Engineering Analysis as specified in the Rule/Policy.

### 7.3.8 Providing Feedback to the Architecture Maintainer

Project Teams that use the architecture will be one of the most significant sources for regional ITS architecture maintenance changes. As projects are implemented, they will be mapped to the architecture, and a significant portion of the architecture will be closely reviewed in the process. Each region should define a mechanism that allows each Project Team to provide comments to the architecture with minimal time investment. Many of the components of the regional ITS architecture may be improved through feedback from architecture use, as shown in Figure 54. As discussed in paragraph 7.3.1, a checkpoint in the process should be identified where each project reviews the as-built project design and submits any comments to the regional ITS architecture, in the same way that as-built plans are submitted for traditional construction projects.

There are a few key steps that can be taken to implement a good architecture feedback process and ultimately improve the quality of the regional ITS



architecture. First, there must be some rigor to the process that supports architecture feedback so that architecture feedback isn't forgotten in the rush to complete the project. Second, good configuration management practices are required, both for the project development team and the architecture maintainer so that needed changes are captured, accrued, and properly incorporated over time. Regional ITS Architecture maintenance is discussed in detail in Section 8.

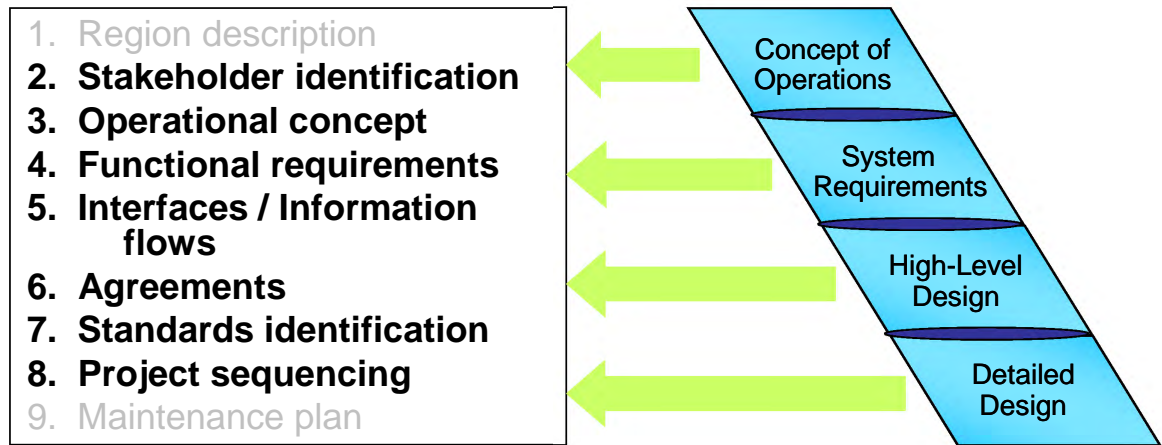

**Figure 54: Providing Feedback to the Regional ITS Architecture**

Several regions have implemented on-line forms and e-mail links that make it easier for Project Teams to provide architecture feedback. For example, VDOT provides an on-line form for architecture comments on their Northern Virginia (NOVA) ITS Architecture web site. Another form (see Figure 55) allows Project Sponsors to easily notify the NOVA Architecture Team leader of new Project Architectures that should be reflected in the NOVA Architecture. Architecture maintainers can also use programming documents, capital plans, project documentation, and general knowledge and involvement in the region to identify architecture impacts from ITS projects that may not be reported.



Section  
8

## Maintaining a Regional ITS Architecture

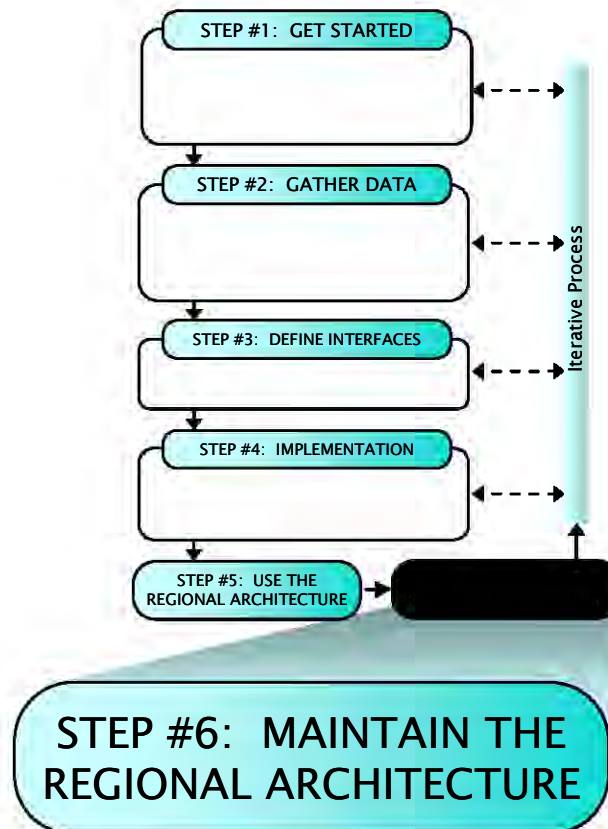

This section discusses various options and considerations associated with on-going maintenance of the architecture products. This includes detailing the responsibilities and procedures that need to be considered as an architecture is used and maintained over time. The regional ITS architecture is not a static set of outputs. It must change as plans change, ITS projects are implemented, and the ITS needs and services evolve in the region.

Much as ITS systems require planning for operations and maintenance, a plan should be put in place during the original development of the regional ITS architecture to keep it up to date.

## STEP #6: MAINTAIN THE REGIONAL ARCHITECTURE

	<ul style="list-style-type: none"> <li>• Determine maintenance responsibilities</li> <li>• Define the architecture baseline</li> <li>• Define the change management process</li> <li>• Develop an architecture maintenance plan</li> <li>• Maintain the architecture per the plan</li> </ul>
<b>OBJECTIVES</b>	Develop and implement procedures and responsibilities for maintaining regional ITS architecture in the region.
<b>PROCESS</b> <i>Key Activities</i>	<ul style="list-style-type: none"> <li>• Determine who will be responsible for architecture maintenance. What individual or group of individuals will be responsible for maintaining the architecture? Also who will support the effort, and who will manage or have oversight for the maintenance effort?</li> <li>• Define the architecture baseline. What outputs/ documents will be maintained? Will you maintain only the databases or the graphic representations of the architecture as well?</li> <li>• Define the change management process. How will changes be introduced and by whom? How often will changes to the architecture baseline be performed? Who will evaluate the changes for inclusion into the baseline? What group will review the change recommendations and make the decisions on what changes are accepted and which are not? Who will actually modify the architecture baseline?</li> <li>• Develop an Architecture Maintenance Plan. This plan will document the process and provide a framework for the architecture maintenance activity.</li> <li>• Maintain the architecture per the plan. Identify, analyze, approve, incorporate, and communicate changes to the architecture baseline, per the plan. Refine the plan over time so that it continues to accurately reflect the region's architecture maintenance process.</li> </ul>
<b>INPUT</b> <i>Sources of Information</i>	<ul style="list-style-type: none"> <li>• Last approved version of the regional ITS architecture</li> </ul>
<b>OUTPUT</b> <i>Results of Process</i>	<ul style="list-style-type: none"> <li>• Architecture Maintenance Plan</li> <li>• Updated architecture baseline</li> </ul>

The regional ITS architecture is described by a set of outputs discussed in Sections 3 through 6 of this document. These sections have suggested a process for creating the original set of outputs that represent the regional ITS architecture. This section will examine the process of maintaining the architecture. This process is really one of continual improvement and evolving with the region as its stakeholders make use of the architecture and a region's needs grow and change, guided by the principles of Configuration Control and Change Management. Some of the key aspects of the process, which are covered in more detail below are:

- Understand why the architecture needs to be maintained
- Determine who will be responsible for architecture maintenance
- Define the architecture baseline
- Define the change management process
- Document the process in a Maintenance Plan.



The development of an architecture maintenance plan and the implementation of a program to maintain the architecture is also a requirement of the ITS Architecture and Standards Final Rule/ Final Policy, which says: *“The agencies and other stakeholders participating in the development of the regional ITS architecture shall develop and implement procedures and responsibilities for maintaining it, as needs evolve within the region.”*

As ITS projects are implemented, the regional ITS architecture will need to be updated to reflect new ITS priorities and strategies that emerge through the transportation planning process, to account for expansion in ITS scope, and to allow for the evolution and incorporation of new ideas. A maintenance process should be detailed for the region, and used to update the regional ITS architecture. This maintenance process should be documented as part of the initial development of the regional ITS architecture in a regional ITS architecture maintenance plan. The goal of the maintenance plan is to guide controlled updates to the regional ITS architecture baseline so that it continues to accurately reflect the region's existing ITS capabilities and future plans.

Note that the process of architecture maintenance covered in this white paper is meant to apply to a wide range of regional and statewide ITS architecture developments. Each architecture development effort will need to tailor the process to meet the needs and resources of their particular region.

## 8.1 Why a Regional ITS Architecture Needs to Be Maintained

The regional ITS architecture is not static. It must change as plans change, ITS projects are implemented, and the ITS needs and services evolve in the region. The regional ITS architecture must be maintained so that it continues

to reflect the current and planned ITS systems, interconnections, and other aspects of architecture. The following list includes many of the events that may cause change to a regional ITS architecture:

- **Changes in Regional Needs.** Regional ITS architectures are created to support transportation planning in addressing regional needs. Over time these needs can change and the corresponding aspects of the regional ITS architecture that address these needs may need to be updated. These changes in needs should be expressed in updates to planning documents such as the Regional Transportation Plan, the TIP, and the ITS Strategic Plan.
- **New stakeholders.** New stakeholders become active in ITS and the regional ITS architecture should be updated to reflect their place in the regional view of ITS elements, interfaces, and information flows. Why might new stakeholders emerge? The stakeholders might represent new organizations that were not in place during the original development of the regional ITS architecture. Or maybe the geographic scope of the architecture is being expanded, bringing in new stakeholders. Or maybe additional transportation modes or transportation services are being considered that interface with the systems of additional stakeholders.
- **Changes in scope of services considered.** The range of services considered by the regional ITS architecture expands. This might happen because the National ITS Architecture has been expanded and updated to include new user services or to better define how existing elements satisfy the user services. A regional ITS architecture based on an earlier version of the National ITS Architecture should take into consideration these changes as the regional ITS architecture is updated. The National ITS Architecture may have expanded to include a user service that has been discussed in a region, but not included in the regional ITS architecture, or was included in only a very cursory manner. Changes in the National ITS Architecture are not of themselves a reason to update a regional ITS architecture, but a region may want to consider any new services in the context of their regional needs.

The National ITS Architecture and Turbo Architecture are not updated on a set schedule but on the basis of the program's configuration control process that reviews and analyzes stakeholder inputs and works with US DOT to schedule when the updates should be incorporated. Updates to the National ITS Architecture and Turbo will be publicized on the ITS Joint Program Office (JPO) Architecture web site: <http://www.its.dot.gov/arch/index.htm>.

- **Changes in stakeholder or element names.** An agency's name or the name used to describe their element(s) undergoes change.



Transportation agencies occasionally merge, split, or just rename themselves. In addition element names may evolve as projects are defined. The regional ITS architecture should be updated to use the currently correct names for both stakeholders and elements.

- **Changes in other architectures.** A regional ITS architecture covers not only elements and interfaces within a region, but also interfaces to elements in adjoining regions. Changes in the regional ITS architecture in one region may necessitate changes in the architecture in an adjoining region to maintain consistency between the two. Architectures may also overlap (e.g. a statewide ITS architecture and a regional ITS architecture for a region within the state) and a change in one might necessitate a change in the other.

There are several changes relating to project definition that will cause the need for updates to the regional ITS architecture.

- **Changes due to Project Definition or Implementation.** When actually defined or implemented, a project may add, subtract or modify elements, interfaces, or information flows from the regional ITS architecture. Because the regional ITS architecture is meant to describe the current (as well as future) regional implementation of ITS, it must be updated to correctly reflect how the developed projects integrate into the region.
- **Changes due to Project Addition/Deletion.** Occasionally a project will be added or deleted through the planning process or through project delivery and some aspects of the regional ITS architecture that are associated with the project may be expanded, changed or removed.
- **Changes in Project Priority.** Due to funding constraints, or other considerations, the planned project sequencing may change. Delaying a project may have a ripple effect on other projects that depend on it. Raising the priority for a project's implementation may impact other projects that are related to it.

The above reasons for possible changes in the regional ITS architecture baseline may happen frequently or infrequently, depending upon the region and the specifics of the original regional ITS architecture development effort. This should be taken into account as one set of factors in determining how often to update the regional ITS architecture.

## 8.2 Maintenance decisions

The purpose of maintaining a regional ITS architecture is to keep it current and relevant, so that stakeholders will use it as a technical and institutional reference when developing specific ITS project plans. A key characteristic of

a successful regional ITS architecture is *consensus*; that is, the notion that each stakeholder has and continues to buy-in to the architecture as the model for how ITS elements have been deployed in a region, and more importantly how future ITS elements should be deployed in the region.

Each of the maintenance decisions discussed in this section are primarily in support of keeping the regional ITS architecture relevant to the ITS planning and deployment of ITS projects as resources become available. As conditions in a region naturally evolve, an effective regional ITS architecture maintenance process will also evolve the regional ITS architecture so that it “keeps up” with the evolving conditions, and maintains the characteristic consensus that ensures stakeholders will find it relevant and a benefit to use.

The decisions that will be discussed are:

- **Who:** Who will lead and implement the maintenance effort?
- **When:** On what schedule will the regional ITS architecture change?
- **What:** What parts of the regional ITS architecture will be maintained?

### 8.2.1 Who will maintain the Regional ITS Architecture?

Who will maintain the Regional ITS Architecture? This is perhaps one of the most crucial maintenance decisions for a regional ITS architecture. To maintain a consensus regional ITS architecture, to some extent *all* stakeholders will need to participate, but typically one or two agencies will take the lead responsibility to maintain the regional ITS architecture.



An important concept is that the responsibility for architecture maintenance should not be delegated to an individual person, but should instead be assigned to an agency or institutional group in the region.

Often an individual may be, or may have been, a champion in the development of a regional ITS architecture, and that’s fine. But maintenance is recurring, and necessarily is a long-term effort. The responsibility may be delegated to an individual at any given time, but the overall responsibility should be a stated role of an institution or agency in the region. In this way the responsibility transcends the variabilities that can impact an individual person’s activities and career. Sometimes this responsibility will be shared by agencies. This is the case with the Inland Empire maintenance plan from California (see Appendix C.3.1) that provides for the maintenance responsibility to be assumed jointly by four key agencies in the region.

#### Issues in determining maintainer

Two key considerations in selecting a maintainer are described below.

1. Does the maintainer have the necessary skills and resources to maintain the regional ITS architecture?

Maintaining a regional ITS architecture utilizes a range of skills. In order to properly evaluate changes to the architecture the maintainer must have staff that is knowledgeable of the existing regional ITS architecture. This implies a detailed technical understanding of the various parts of the architecture and how changes would affect each part. Also required is an understanding of transportation systems in the region (although this understanding can reside jointly in the group of agencies/ stakeholders who participate in the maintenance process). Finally, the maintainer agency needs to have staff with an understanding of the tools used to create (and to update) the architecture. This might include for example, knowledge of the Turbo Architecture tool, if that is used to hold some of the architecture information. The agency responsible for maintaining the architecture needs to have the skills within its own organization or consider acquiring the skills. In either case, the agency needs the necessary funding to support the maintenance effort.

Having the resources to maintain a regional ITS architecture may mean that the stakeholders using the regional ITS architecture have to share in the costs to acquire these resources, even though one specific agency may commit to maintain staff or contract the skill set necessary.

2. Does the maintainer have the mission and authority to maintain the full stakeholder and functional scope of the regional ITS architecture?

The agency that maintains a regional ITS architecture ideally is one that has broad functional responsibilities across the full scope of the regional ITS architecture. In this case, “scope” represents the geographic area of the region, the transportation functions in the region, and the timeframe for deployment of new ITS elements and interfaces in the region.

A natural maintainer for many regions is the Metropolitan Planning Organization (MPO). Very often the scope of the MPO will match (or nearly match) the scope of the regional ITS architecture. This is the case in the Northeastern Illinois maintenance plan—the responsible agency for maintenance is the MPO in the region (CATS). This is also true for the Oahu Regional ITS Architecture, where Oahu Metropolitan Planning Organization will assume the maintenance responsibility. Both of these plans can be found in Appendix C. In cases where the MPO does not possess the resources to manage the effort, or in cases where there is no MPO (e.g. if the region is rural in nature) alternate maintainers might be identified. Some other possibilities for maintainer organizations are:

- State Department of Transportation (DOT). A State DOT might take responsibility for maintaining the regional ITS architecture. This particular approach may make the most sense in rural regions where the ITS functions are largely the responsibility of the state DOT. But it could also apply to regions that have limited resources

available in the MPO or other local planning organization or where the “region” is an entire state.

- **Transportation Authorities.** These entities manage transportation infrastructure using a business model that may be relatively independent of those agencies more aligned with the MPO business model. If a Transportation Authority is a stakeholder in a regional ITS architecture, then an agreement between the Authority and the MPO may be necessary to carry on the appropriate maintenance of their common regional ITS architecture.
- **Regional ITS Committees:** Regions often have some institutional framework that make decisions about integration, ITS issues, operations, or procurement. Many areas in the United States address this issue by creating an ITS Committee, Working Group, ITS Program Committee, or Operations Task Force. This institutional group could be responsible for the architecture maintenance.

When one agency or institution takes responsibility for architecture maintenance, they may use agreements to create a management or oversight function (e.g. a “regional ITS architecture maintenance committee” or “regional ITS architecture maintenance board”) to oversee regional ITS architecture maintenance work, which would have representation from the key stakeholders to the agreement. This group might be given management authority over the maintenance process. In this way, the stakeholders are investing in and controlling their own regional ITS architecture, and they will have direct responsibility for the quality of the product.

### **What group will assist the maintainer in evaluating and approving changes?**

Another decision that must be made is who will support the maintainer in evaluating and approving changes to the architecture. This should be a group of representatives of key stakeholders, ideally members from the areas of traffic, transit, public safety, and maintenance. This group might be a carryover from a committee or body that consisted of key stakeholders in the development of the architecture, or it could be a newly constituted group, or it might be a form of the Regional ITS Committee described above. These groups have many names, but one common trait – they often include both technical and managerial representatives of the key transportation agencies in the region. As an example, the Inland Empire maintenance plan calls out the creation of a new group—the Architecture Maintenance Team—with representation from key stakeholders. The Oahu Regional ITS Architecture Report calls out an existing group—the ad hoc ITS Technical Task Force—to support the maintenance activity.

The group responsible for evaluating and approving changes to the architecture may be a group that has some coordinating authority for integration of systems in the region. However there is no need for the group to have legal or contracting authority. They will be serving as a vehicle for consensus.

### **8.2.2 When will the architecture be updated?**

Another way to describe *when* the architecture will be updated is to consider what “timetable” will be used for making updates or changes to the architecture. There is no set timetable that will apply to every region. The timetable chosen will depend on several factors including how the regional ITS architecture is used and the funding/ staffing available for the task.

How often will the regional ITS architecture be modified or updated? There are two basic approaches to update interval: periodic maintenance and exception maintenance. Each has their advantages and disadvantages. They are not mutually exclusive, and an approach could be developed that is a combination of the two basic models.

- **Periodic Maintenance.** This approach ties the maintenance of the regional ITS architecture to one of the recurring activities of the transportation planning process. For example, if an MPO is the lead maintenance agency for a region, it’s natural that the regional ITS architecture would be updated at the same frequency as the regional transportation plan is updated (every three to five years) or the Transportation Improvement Program is updated (at least every two years). The update of the architecture could occur prior to or following the transportation planning document update. If the architecture update precedes the update to the planning document the revised architecture could serve as an input to the planning update. The drawback to this approach is changes in support of ITS projects may not be updated into the regional ITS architecture on a timely basis. Publication and versioning costs are minimized for the periodic maintenance approach since there is a new version only once in the maintenance cycle.
- **Exception Maintenance.** This approach considers and makes changes to the regional ITS architecture in a process that is initiated as needed. This is very convenient for Rule 940 consistency issues, but may be more costly than a periodic process (where requests for changes are queued until they are all addressed at once). Publication and versioning costs are dependent on the frequency of changes made to the regional ITS architecture.
- **Combined Periodic and Exception Maintenance.** This approach is the most responsive to stakeholder needs, and perhaps the most likely to succeed with regard to usage of the regional ITS architecture,

however, it implies the greatest cost. Specific stakeholder requests are dispatched immediately, and a more thorough process of analysis is periodically applied to discover and incorporate new ITS requirements.

Note, the above discussion relates to ‘how often’ the architecture is updated. A complementary discussion regarding whether the update involves incremental changes or is an update of the full baseline will be provided in section 4.2.

### **8.2.3 What will be maintained?**

What aspects of the regional ITS architecture will be maintained? Those constituent parts of a regional ITS architecture that will be maintained are referred to as the “baseline”. This section will consider the different “parts” of the regional ITS architecture and whether they should be a part of the baseline.

One of the benefits of a regional ITS architecture is to enable the efficient exchange of information between ITS elements in a region and with elements outside the region. Efficiency refers to the economical deployment of ITS elements and their interfaces. The result of these ITS deployments should be contributions to the safe and efficient operation of the surface transportation network. Each of the components in the regional ITS architecture below have a role in this economy, and appropriate effort should be levied to maintain them.

#### *Description of Region*

This description includes the geographic scope, functional scope and architecture timeframe, and helps frame each of the following parts of a regional ITS architecture. Geographic scope defines the ITS elements that are “in” the region, although additional ITS elements outside the region may be necessary to describe if they communicate ITS information to elements inside the region. Functional scope defines which services are included in a regional ITS architecture. Architecture timeframe is the distance (in years) into the future that the regional ITS architecture will consider. The description of the region is usually contained in an architecture document, but may reside in a database containing aspects of the regional ITS architecture, and should certainly be a part of the baseline.

#### *List of Stakeholders*

Stakeholders are key to the definition of the architecture. Within a region they may consolidate or separate, and such changes should be reflected in the architecture. Furthermore, stakeholders that have not been engaged in the past might be approached through outreach to be sure that the regional ITS architecture represents their ITS requirements as well. The stakeholders should be described in architecture documentation (and



may also reside in a database representing aspects of the regional ITS architecture). Their listing and description should be part of the baseline.

#### *Operational Concept*

It is crucial that the operational concepts (which might be represented as roles and responsibilities or as customized market packages) in a regional ITS architecture accurately represent the consensus vision of how the stakeholders want their ITS to operate for the benefit of surface transportation users. These should be reviewed, and if necessary, changed to represent both what has been deployed (which may have been shown as “planned” in the earlier version of the regional ITS architecture) and so that they represent the current consensus view of the stakeholders. Many of the remaining maintenance efforts will depend on the outcome of the changes made here. The operational concept will reside in the architecture documentation (and possibly in a diagramming tool if a customized market package approach is used) and should be part of the baseline.

#### *List of ITS Elements*

The inventory of ITS elements is a key aspect of the regional ITS architecture. Changes in stakeholders as well as operational concepts may impact the inventory of ITS elements. Furthermore, recent implementation of ITS elements may change their individual status (e.g. from planned to existing). The list of elements is often contained in architecture documentation, and is key information in any architecture database. It is a key aspect of the baseline.

#### *List of Agreements*

One of the greatest values of a regional ITS architecture is to identify where information will cross an agency boundary, which may indicate a need for an agency agreement. An update to the list of agreements can follow the update to the Operational Concept and/or interfaces between elements. The list of agreements will usually be found in the architecture documentation. This listing should be a part of the baseline.

#### *Interfaces between Elements (interconnects and information flows)*

Interfaces between elements define the “details” of the architecture. They are the detailed description of how the various ITS systems are or will be integrated throughout the timeframe of the architecture. These details are usually held in an architecture database. They are a key aspect of the architecture baseline, and one that will likely see the greatest amount of change during the maintenance process.

#### *System Functional Requirements*

High-level functions are allocated to ITS elements as part of the regional ITS architecture. These can serve as a starting point for the functional definition of projects that map to portions of the regional ITS architecture. Because of the level of detail, these are usually held in spreadsheets or

databases, but may be included in the architecture document. They are a part of the baseline.

#### *Applicable ITS Standards*

The selection of standards depends on the information exchange requirements. As projects are implemented and standards are chosen for a project they need to be reflected back in the regional ITS architecture so that other projects can benefit from the selections made. In addition, the maintenance process should consider how ITS standards may have evolved and matured since the last update, and consider how any change in the “standards environment” may impact previous regional standards choices (especially where competing standards exist). For example, if XML based Center-To-Center standards reach a high level of maturity, reliability and cost-effectiveness, then a regional standards technology decision may be made to transition from investments in other standards technologies (e.g. CORBA to XML). The description of the standards environment for the region, as well as the details of which standards apply to the architecture should be part of the baseline.

#### *Project Sequencing*

While project sequencing is partly determined by functional dependencies (e.g. “surveillance” must be a precursor to “traffic management”), the reality is that for the most part project sequences are local policy decisions. Project sequences should be reviewed to make sure that they are in line with current policy decisions. Furthermore, policy makers should be informed of the sequences, and their input should be sought to make the project sequences in line with their expectations. This is crucial to avoiding the regional ITS architecture becoming irrelevant. The project sequencing should be included in the architecture documentation and may also be held in a spreadsheet or database. These should be part of the architecture baseline.



In addition to the components of the architecture being maintained above, it is also important to document the resources that were used along the way to develop the architecture – the Region’s Transportation Plan, TIP, ITS Strategic Plans, various studies, as well as other regional ITS architecture. Document these other resources – their titles, dates or versions, and where they can be found so that future maintainers can understand some of the background that supported the development of this regional ITS architecture and remember that changes to those documents may affect the architecture.

## **8.3 Maintenance Process**

This section describes the regional ITS architecture maintenance process. The process described below is based upon the more general discipline of Configuration Management. This section will first present a short summary of configuration management, and then describe the process of maintaining a regional ITS architecture, drawing connections between the general discipline

and the specific application of it for maintaining a regional ITS architecture. The maintenance process described in this section is a suggested or example process for the maintenance of regional ITS architecture. The process presented can be applied to the maintenance of any regional ITS architecture, but should be tailored to fit the size and scope of the particular architecture. The process should also be tailored so that it fits within the region's transportation planning processes (e.g., the Regional Transportation Plan update process).

### 8.3.1 Configuration Management Overview

Configuration management is defined as: "A management process for establishing and maintaining consistency of a product's performance, functional, and physical attributes with its requirements, design and operational information throughout its life" and can be applied to the development of any system. In the context of regional ITS architecture it is a process for establishing and maintaining consistency of the architecture's information content throughout its life. In general, the configuration management process consists of five major activities:

- **Configuration management planning** – before you start, there are some decisions that need to be made about what needs to be controlled within a product configuration, when you establish a controlled configuration, how you change a controlled configuration, and what amount of effort you're going to expend in managing configurations. In the context of maintaining a regional ITS architecture this corresponds to the architecture maintenance plan.
- **Configuration identification** – identifying the *configuration items* that need to be independently identified, stored, tested, reviewed, used, changed, delivered and/or maintained. Identifying the configuration items and what identifiers will be used is part of the architecture maintenance plan.
- **Configuration control** – the control of which changes are made to the configuration baseline and when and how they are made.
- **Configuration status accounting** – keeping track of the state of all configuration items, all pending proposed changes, and all approved changes to configuration items
- **Configuration audits** – verifying consistency of configuration documentation against the product. In the context of a regional ITS architecture this includes verifying that different representations of the architecture (e.g. document and database) match.

These activities are performed throughout the life of the development and operation of systems.



There are some additional resources that provide more detail and some specific tools and techniques for implementation of configuration management. These may provide additional information in adapting the information presented here to address specific regional needs.

- TMC Pooled-Fund Study Configuration Management for Transportation Management Systems – Final Report September 2003 ([http://tmcpfs.ops.fhwa.dot.gov/cfprojects/new\\_detail.cfm?id=24&new=2](http://tmcpfs.ops.fhwa.dot.gov/cfprojects/new_detail.cfm?id=24&new=2)).
- A Guide to Configuration Management for Intelligent Transportation Systems – April 2002 ([http://www.itsdocs.fhwa.dot.gov/JPODOCS/REPTS\\_TE/13622.html](http://www.itsdocs.fhwa.dot.gov/JPODOCS/REPTS_TE/13622.html)).

### 8.3.2 Architecture Maintenance Process

The process of maintaining a regional ITS architecture involves managing change, and can be described using the activities summarized in the previous discussion of configuration management.

#### CM Planning

Before the maintenance activity begins the parameters of the activity must be identified and the details of the process must be determined. These parameters, defining who will maintain the architecture, when the architecture will be updated, and what will be the baseline maintained have been described in Section 8.2. These decisions and the maintenance process itself should be defined in an architecture maintenance plan, which is the primary output of the configuration management planning activity. The maintenance plan may be a separate document or part of the larger regional ITS architecture document. The plan should be created during the initial development of the regional ITS architecture. If it was not then the process should be defined and documented as soon as possible. The maintenance plan should also be a part of the architecture baseline described below.

#### *Who*

The maintenance plan should identify who will be responsible for the maintenance effort and what group of stakeholders will review and approve changes to the architecture baseline. In addition to defining who will be involved in maintenance a description of each agencies roles and responsibilities may be included. The Oahu Regional ITS Architecture Report provides just such details on roles and responsibilities.

#### *When*

The maintenance plan should also identify the timetable for regional ITS architecture updates. As discussed in 8.2.2, there are several options for this timeline. The other timing decision that should be identified in the maintenance plan is when to set the baseline and begin the maintenance process. In the case of regional ITS architectures, the first release of the architecture after its initial development would normally constitute the initial baseline. This is the point at which the architecture is ready for distribution

and use, and the point at which potential changes to the architecture may begin to develop.

#### *What*

The maintenance plan should clearly identify what will be maintained- i.e. the architecture baseline. Section 8.2.3 discussed the parts of the regional ITS architecture that should be maintained. In fact, these parts are contained in databases (e.g. a Turbo Architecture database), spreadsheets, drawing files (e.g. PowerPoint or Visio), Hypertext Markup Language (HTML) files for a web site, and documents. Defining the architecture baseline is defining exactly what documents, databases, etc. will be maintained.

In addition to these architecture outputs, source documents that were used to produce the regional ITS architecture outputs may also be important to identify. Some of these documents will be the subject of later revision and maintaining a consistency between the architecture and the other efforts is important. For example, if the regional ITS architecture inventory was derived from a number of individual stakeholder inventory documents, then the date and version numbers of those source documents should be considered for inclusion in your list of controlled items. Other examples of these source documents might include early deployment study reports, strategic deployment plans, and inventory tracking reports. It is important that the dates of reports and any version numbers associated with the reports are recorded as part of the configuration that is controlled. This way, subsequent releases of these documents would trigger an analysis to determine how the changes are best propagated through the rest of the controlled items in order to maintain a consistent configuration. It's also necessary to record where these are stored – at which agency, on which data server, web site or other storage location.

The versions of software tools that were used to produce the architecture might also be included in the set of configuration items. These might include the Turbo Architecture software and the version of the National ITS Architecture used. For these tools, the important thing to record as part of the configuration is the version number and date of release. Subsequent updates to the tools and databases would trigger a change analysis.

A final consideration that goes into the definition of the architecture baseline is how you plan to use the architecture. Will market package diagrams be an important source of interfaces for project definition? Or will interconnect diagrams be used? Or will project developers go directly to the database representation for their detailed definition? Considering some of these alternatives will help you decide which representations of the architecture are most important to your region.

Table 17 shows some examples of the items that might be selected for the architecture baseline.

**Table 17. Examples of Configuration Items to Consider**

Turbo Architecture Databases Regional ITS Architecture Documentation Maintenance Plan (if a separate document) List of documents used in developing architecture or with which the architecture should be consistent:	Planning Documents Inventory Tracking Documents Turbo Architecture Software Version National ITS Architecture Version
--	--

The definition of baseline will depend greatly on the scope and complexity of the regional ITS architecture effort. For small efforts the baseline might consist of only a database, an architecture summary document (which would include the maintenance plan) and the version of National ITS Architecture (and possibly Turbo Architecture) used for the development.

### *How*

Once the Who, When, and What are established, deciding *how* to change the baseline needs to be considered. Change is inevitable. The goal of configuration management is not to keep changes from occurring, but to permit changes in a controlled fashion, ensuring that all configuration items are consistent with their descriptions at all times. Due to the nature of a regional ITS architecture (i.e. a set of documentation and databases rather than an actual system of software and hardware), there are two basic approaches that could be taken to updating the baseline. The first is *incremental change* based upon individual change requests. The second is a *full baseline update* based upon a periodic revisiting of the entire architecture. In the latter case all the architecture outputs are revisited and modified based upon stakeholder inputs, using much the same process as was used in the original development of the architecture.

The process of changing the baseline can be broken into the steps shown in Figure 56. The following sections will consider each process step as it might be applied to both approaches to architecture maintenance. The formality or amount of effort that goes into these process steps will depend upon the scope and complexity of the regional ITS architecture.



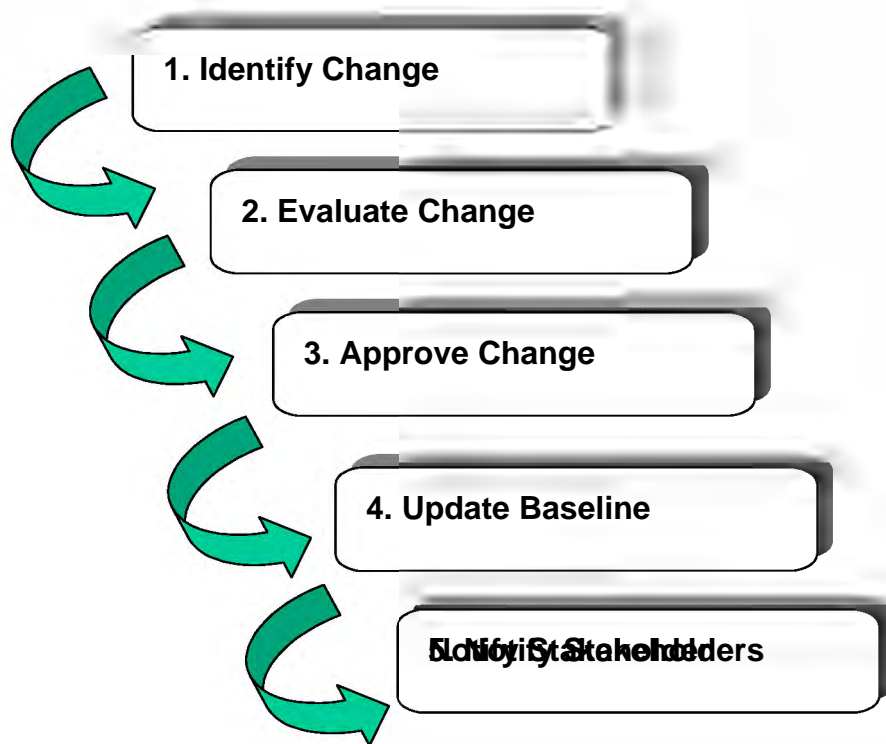

**Figure 56. Process for Change Identification**

#### 1. Identify Change

The primary aspects of change identification are:

- Who can suggest a change?
- How is the change request documented?

Each architecture effort will need to make a decision about who can initiate a change request. In some areas the selected answer will be “anyone”. This approach is called out in the Inland Empire maintenance plan. Allowing anyone to initiate a change is conducive to the development of a “consensus” architecture because it empowers all stakeholders to provide inputs. However the approach does have a drawback – if literally anyone can input requests the region runs the risk of being overrun by requests that will tax scarce resources to review and decide upon proposed changes. An alternative approach that may be attractive to some larger regions is to limit who can make change requests to members of the maintenance committee/board or members of other key ITS committees. This effectively means that any change suggested has the approval of a key stakeholder. This approach is planned in the Northeastern Illinois maintenance plan. This has the added benefit of spreading the resources needed to generate or evaluate changes among the group.

The plan might also address when a change request should be made. For example, the Oahu maintenance plan lays out detailed directions for inclusion of ITS projects in the TIP, identifying when changes to the

regional ITS architecture need to be made in order for a project to be funded through the TIP. Also the plan might identify the types of changes that will be made to the architecture. The Oahu plan identifies administrative amendments that do not require Policy Committee approval and non-administrative amendments that do require Policy Committee approval.

It is recommended that a simple change request form be created that contains at least the following information:

- Name of change
- Description of change
- Rationale for change
- Originator name or agency
- Originator contact information
- Date of origination

As part of the configuration management process this information should be maintained in a change log (or change database) that would add the following additional fields of information

- Change number (some unique identifier)
- Change disposition (accepted, rejected, deferred)
- Change type (minor or significant)
- Part of baseline affected (could be check boxes for document, database, web site, and not known)
- Disposition comment
- Disposition date



There are many ways the above change forms can be implemented. The form could be on a regional architecture website for download by anyone submitting a change. A less formal alternative would be for a change request to be submitted as an email containing the key information above. The formality in the process creates an audit trail of all changes considered as well as a record of those approved, those rejected, and those deferred. This audit trail can come in handy in future assessments of proposed enhancements or changes to the systems.

The above description of initiating changes applies to individual change suggestions that might arise from review of the architecture by a stakeholder or from the impact of individual projects. In the case of a full baseline update of the regional ITS architecture, this could be handled by a summary change request indicating the nature of the update and referencing the stakeholder interactions that will generate a set of changes.

## 2. Evaluate Change

When using the incremental change approach to maintenance, each change request needs to be evaluated to determine what impact it has upon the architecture baseline. This evaluation could be required of the person proposing the change, or it could be performed by someone else

(possibly the person, or group of people responsible for maintaining the architecture). Since a proper evaluation of a change requires detailed knowledge of the aspects of the regional ITS architecture baseline that are affected: it is usually a better idea to have someone on the maintenance committee (or their staff) do the evaluation. If the proposal for architecture modification has an impact on other stakeholders, someone from the maintenance committee should contact the stakeholders to confirm their agreement with the modification. If the issue warrants it, a stakeholders meeting or teleconference to discuss the modification may be held. In the case of a full baseline update, the change evaluation happens through stakeholder consensus as part of the overall update.

### 3. Approve Change

When using the incremental change approach, the changes should be presented to the maintenance committee along with recommendations to approve, defer, or reject them. This could be handled informally through email, or through periodic face-to-face meetings. The maintenance plan should identify how change approval will occur and any procedures that will be used to make the decisions. Should approval require unanimous consensus of all members of the committee? Approval of all stakeholders affected by the change? Or just a majority of the committee members? Which procedure is used depends greatly on the nature of consensus building in the region. Approval of affected stakeholders is a good approach and one that may fit a wide range of conditions. For example, if a change to an interconnection between the traffic management center and the transit center is suggested, then approval by the appropriate traffic and transit agency represents consensus on the change and should be all that is needed for approval. Unanimous consent is not recommended as it is the hardest to maintain (and may slow down the process considerably due to trying to get all parties to respond, or come to meetings). In the case of full baseline update, the approval comes from the stakeholder inputs obtained when each architecture input is revised.

### 4. Update Baseline

This activity involves putting the changes into the architecture baseline documents, web files, and databases. This requires much the same skills and techniques used in creating the initial baseline. When using the incremental change approach, all the changes would be entered by one or more assigned personnel, and then checked per the process described in the maintenance plan. When using the full baseline update, new versions of documents, web files, and databases would be circulated to stakeholders for a wider review. In addition, the change log would be updated to describe the actual change made and the version identification of all architecture baseline material would be updated as described in the maintenance plan. In some cases, the changes might be held until there is sufficient volume to make the changes efficiently.

## 5. Notify Stakeholders

The final part of the maintenance process is to notify stakeholder of the changes or updates to the architecture. This applies equally to incremental change and full baseline update approaches. In order to perform this notification, the maintaining organization should create and keep up to date a contact list for all stakeholders represented in the architecture. As part of the maintenance process, this contact list should be reviewed and updated periodically to identify changes in personnel or changes in contact information (e.g. phone numbers or email addresses). The task of actually notifying the stakeholders of changes may be handled in a variety of ways ranging from hard copy to e-mail to websites. Each approach has its strengths and weaknesses, and what is best for the region will be based on the current methods of communicating. A suggested approach that may meet a wide range of needs is to identify a website where information about the architecture is available and have a place on that website to provide notification of changes. This could be coupled with email notification to the stakeholder list that a change has occurred and to access the information on the website. As part of the note (as well as on the website) it would be good to provide the new version and date of baseline items, as well as a short summary of the changes.

### **Configuration Management Resources**

What resources are needed to perform configuration management? In the context of maintenance of a regional ITS architecture, the same personnel skills that are used to work with the National ITS Architecture and possibly the Turbo architecture tool will be used in managing the configuration items that are included in the configuration management plan. In addition to human resources, there will be the need to have file servers, web sites, or other central locations to store electronic copies of configuration items. These must be “read-only” and protected so that changes are not made to released versions of the databases and documents. Any required changes require a new version number/date and hence a new copy of the configuration item separate from the previous version.

### **Configuration Identification**

Each configuration item must have a unique identifier associated with it. The identifier for the item should be marked on it in some fashion, so that the item can be identified without error and tracked. In the context of regional ITS architecture maintenance, this can be accomplished by suffixing a version number and date in the file name for a database file or electronic document, or it can be physically marked on a printed document. The identifier can also be included in a header or footer for documents and diagrams. In this way, everyone who reads the materials or looks at the database (using Turbo Architecture, for example) will know which version they are reviewing.

It also makes sense to have a controlled document that lists all of the configuration items and the versions that constitute that baseline in time. Maintenance history can also be included. Any interdependencies between the items are worth recording. There are several reasons for this. First, you

want to be able to know what items you have under configuration control and be able to locate them. Marking them with a unique identifier makes it possible to do that. Second, you want to be able to track the status of each item as it changes. Third, if a change is made to one of your configuration items, you want to be able to determine the impact of that change on the other items.

### **Configuration Control**

Configuration control refers to the process of identifying, evaluating and approving changes (as laid out in the architecture maintenance plan) and then updating the baseline and all associated documentation. Any additions after the initial release/baseline will be noted with a changed version number and date to the relevant identifiers. This must also include an update and new version of the overall configuration item list that documents the current versions of all configuration items.

In the case of a regional ITS architecture the baseline consists of databases, documents, and possibly other supporting outputs such as spreadsheets or drawing files. The process of configuration control and of updating these can become challenging since there is likely to be more than a single representation of the same information. For example, if a database contains the architecture inventory and an architecture document contains a table that lists this inventory- these two representations of the same information need to be kept in sync. Eliminating this kind of duplication is not really an option because a database representation of the architecture is needed to manage to large number of elements and connections, but some form of documentation is also required to make the information more understandable and usable for the stakeholders. The solution is to be aware of the duplication and to put in place a plan to manage it. Because of the potential for changes affecting multiple parts of the baseline, the changes in each part of the baseline should be coordinated with updates in other parts of the baseline. This is particularly true when using the incremental change approach to architecture maintenance.



In the incremental change approach, it is also possible to allow the database version of the information to change more frequently than the documentation. This might be appropriate if the form of the information used most often by stakeholders is the database (e.g. in the mapping of regional ITS architecture to projects). This could be handled by notes in the configuration item list.

### **Configuration Status Accounting**

Configuration status accounting is the process of ensuring that all of the relevant information about an item – documentation and change history – is up to date and as detailed as necessary. This includes the status of all pending changes. A primary goal of configuration status accounting is to disseminate configuration item information necessary to support existing and future change control efforts. A typical configuration status accounting system involves establishing and maintaining documentation for the entire life cycle of

an item. Status accounting is ideally carried out in conjunction with change control.

The primary benefit of configuration status accounting is that it provides a methodology for updating all relevant documentation to ensure that the most current configuration is reflected in the configuration identification database. It accounts for the current status of all proposed and approved changes. The goal of configuration status accounting is to provide decision makers with the most up-to-date information possible. Having the most recent information about a change item or including how the changes were implemented helps to reduce research efforts in future change control activities whether implementing a new change or rolling back a change that had a negative or unexpected impact. To report status, a format similar to that shown in Figure 57 might be used:

<b>Metropolis Regional ITS Architecture Configuration Identification Document – Revision 2 June 3, 2003</b>		
<b><i>Turbo Architecture Databases</i></b>		
<b>Configuration Item</b>	<b>File Version</b>	<b>Location / Point Of Contact</b>
Metropolis Regional Architecture Database	Metropolis-reg-20a-6-3-2003.tbo	Metro MPO – James Dean – 727-999-1234
Metropolis Project Architecture Database	Metropolis-proj-10-5-23-2003.tbo	Metro MPO – James Dean – 727-999-1234
Calneva Statewide Architecture Database	Calneva-sw-10-5-15-2003.tbo	Calneva DOT – Georgia Plains – 907-234-7890
<b><i>Planning Documents</i></b>		
<b>Configuration Item</b>	<b>Report Version</b>	<b>Location / Point Of Contact</b>
Metropolis Strategic ITS Plan	Version 1.0 – 5-1-2003	Metro MPO – James Dean – 727-999-1234
Metropolis Traffic Signal Upgrade Project	January 31, 2003	Metropolis DOT – Bill Murphy – 727-855-0012

**Figure 57. Sample Configuration Identification Document**

For a small regional ITS architecture, the only configuration items might be a document and a Turbo database. This would mean that configuration status accounting amounts to reporting on the version of the two configuration items (e.g. ruralRegArchV1-6-3-03.tbo and ruralRegionarchV1-7-3-03.doc are the latest versions of the “rural region ITS architecture”). Reporting this status could be done by phone call, letter, email or fax to interested stakeholders just to let them know that these files are still the latest. When using the incremental change approach, the other thing typically reported during status accounting would be the list of pending changes to the regional ITS architecture, and for a small region there may not be very many changes typically encountered and these may be very infrequent. So, in addition to identifying the latest version of the architecture, the region might report that there have been 2 changes received from stakeholder A and B that these haven’t been implemented yet but are expected to be worked on in the next 6 months. When using a full baseline update approach pending changes are



collected but probably not reported until summarized in the change log that occurs when the full baseline is updated.

### **Configuration Audits**

In the general discipline of configuration management, configuration verification and audit is the process of analyzing configuration items and their respective documentation to ensure that the documentation reflects the current situation. In the case of a regional ITS architecture the configuration items *are* the documentation. Hence this step in the process becomes a rather simple one that can look at two aspects of the architecture:

- Verifying the correctness of the configuration status accounting report.
- Verifying that different representations of the architecture information (e.g. the database and document) are in sync.

This type of audit is most applicable when using the incremental change approach (which may result in many small updates to configuration items, but is also a good idea to perform at the end of the effort in the full baseline update.

### **8.3.3 Effort required for maintenance**

How much effort must be expended to maintain a regional ITS architecture? That is dependent on several factors:

- How much activity is there that would involve use of the architecture? The more it is used to support planning and project development activities, the greater the level of changes it will probably see. Is the region going through a major update to their long range plan? Is there a high-level of investment in technology in the region? Is the project activity concentrated in one department or agency or is it spread across several agencies in the region?
- What is the approach being used for architecture maintenance? Is it incremental changes or full baseline update?
- What is the maintenance update cycle? Are changes being incorporated on a regular basis or is revision of the architecture happening once every planning cycle?
- What is the size and complexity of the architecture? The larger the architecture the greater the effort in maintaining it.

To identify the effort required consider several maintenance scenarios:

1. The maintaining organization collects change requests and reviews them with the maintenance committee on a periodic (e.g. quarterly) basis.

How many changes are collected in each period is very dependent on use of the architecture (how much is it being looked at while

stakeholders are using it) as well as the complexity of the architecture (how many elements or connections could be changed). Creating a change request should be a small time investment for any submitter (e.g. under an hour of time). There is a small time investment of the maintaining organization to log the changes. Periodically, changes would be evaluated and presented to the maintenance committee. Evaluating each change will take only a small time investment. A maintenance committee meeting of a couple hours will dispose of the changes. The amount of effort required to update the baseline will be a function of the scope of the change (e.g. adding a new stakeholder, inventory items and connections will take longer than changing the status of a few information flows). Again, the amount of effort for the activities described above is dependent on the number of changes being considered.

2. The maintaining organization collects change requests and holds them until an update occurs X years after the initial architecture is completed.

This scenario is very similar to the previous one (in terms of time required for each change). The primary difference would be the number of changes to be incorporated. Again the amount of effort will be highly dependent on such things as the level of ITS investment in the region. One way to limit the amount of effort required in the evaluation and approval part of the process is to have maintainer staff produce a summary of changes and recommended outcomes (approve, defer, or reject). This will allow the maintenance committee to focus on only those changes requiring significant stakeholder consensus when it meets.

3. At the update cycle stakeholders are brought back together for one or more workshops to review and update the architecture.

This is the full baseline update approach. In this approach, additional time will be spent getting some subset of the stakeholders together in one or more workshops to review the architecture. A series of changes will naturally flow from these meetings that can be incorporated en masse into the architecture. The level of effort required for these meetings will be dependent on how many meetings are planned and how much effort will be required to present the architecture to the stakeholders.

So how much will it cost? We all have to answer to the realities of budgeting and planning which forces us all to the bottom line. The cost of maintaining a regional ITS architecture depends on how you are going to use it. As you can see from the discussion above, the cost of paying someone to update the database, web site, and documents may be trivial compared to the cost of all of the stakeholders' time reviewing and approving changes. Think about the scenarios above and decide what maintenance approach your region will

likely follow. Based on that decision you can then decide whether to allocate some financial resources to your future budgets to cover the cost of maintenance – personnel, equipment, contractors, etc. If the regional ITS architecture is going to be maintained by the MPO, then they should consider making architecture maintenance a work item in their Unified Planning Work Program (UPWP).



In 2005, FHWA developed the “Regional ITS Architecture Maintenance Resources: Technical Advisory,” that went into more detail on the topic of the resources required to maintain an ITS architecture – staffing, training, time, etc. Go to the FHWA Architecture Implementation page, [http://www.ops.fhwa.dot.gov/its\\_arch\\_imp/index.htm](http://www.ops.fhwa.dot.gov/its_arch_imp/index.htm), click on “Resources” and find the link to the Technical Advisory.

## Appendix

## A

## Regional ITS Architecture Tools

Several tools are available that make the job of developing a regional ITS architecture easier. This appendix describes three of the tools that are most frequently used in regional ITS architecture development: the National ITS Architecture Hypertext View, National ITS Architecture Databases, and Turbo Architecture.

Gone are the days when you needed a bookshelf full of documents to access the information in the National ITS Architecture. Today, the National ITS Architecture is published on a widely distributed CD-ROM and on the web. Both the CD-ROM and the Web Site still contain the National ITS Architecture documents – as PDF formatted electronic documents – but the really useful “tools” to the regional ITS architecture developer are two additional views of the Architecture that are also included on the CD-ROM and Web Site: a Hypertext View and a Database view. Both of these views include all of the components of the National ITS Architecture, including the subsystems, terminators, equipment packages, market packages, and architecture flows that are used to support regional ITS architecture development.

While the architecture hypertext and database views provide very efficient and powerful ways to access the National ITS Architecture information, they are general-purpose tools that include no built-in features specifically for regional ITS architecture development. Turbo Architecture is a software tool that was developed specifically to support regional ITS architecture and project architecture development and maintenance.

**Obtaining the Tools and Training:** The National ITS Architecture Hypertext View and Databases are available on CD-ROM and on the Internet at <http://www.its.dot.gov/arch/index.htm> - click on “National ITS Architecture web site”. The National ITS Architecture CD-ROM can be ordered by emailing [ITSPUBS@igate.fhwa.dot.gov](mailto:ITSPUBS@igate.fhwa.dot.gov). There is no charge for this CD. There may be differences between the content on the CD-ROM and on the web site. The web site is used to display the latest version of the National ITS Architecture and may include hypertext or databases that are more recent than what is contained on the CD-ROM.

The Turbo Architecture software tool can be obtained from McTrans by visiting their web site at <http://www-mctrans.ce.ufl.edu/featured/turbo/> or by calling (352) 392-0378, leaving voice mail at (800) 226-1013, or sending e-mail to [mctrans@ce.ufl.edu](mailto:mctrans@ce.ufl.edu). National ITS Architecture and Turbo Architecture training courses are offered by the National Highway Institute (NHI). Visit the NHI web site (<http://www.nhi.fhwa.dot.gov/>) for more information.

## A.1 Hypertext View

The Hypertext View of the National ITS Architecture provides immediate, interconnected access to all the components of the National ITS Architecture definition. The same Hypertext View is included on both the CD-ROM and the Web Site. The Web Site always presents the latest official version of the National ITS Architecture. The CD provides convenient access to a specific version of the National ITS Architecture hypertext.

The Hypertext view is the first (default) view that is presented on the Web Site. The same view is accessed when the CD-ROM inserted or by selecting the *index.htm* file from the top-level directory on the CD. The system will then bring up the default web browser software and present a window that resembles the one shown in Figure 58.

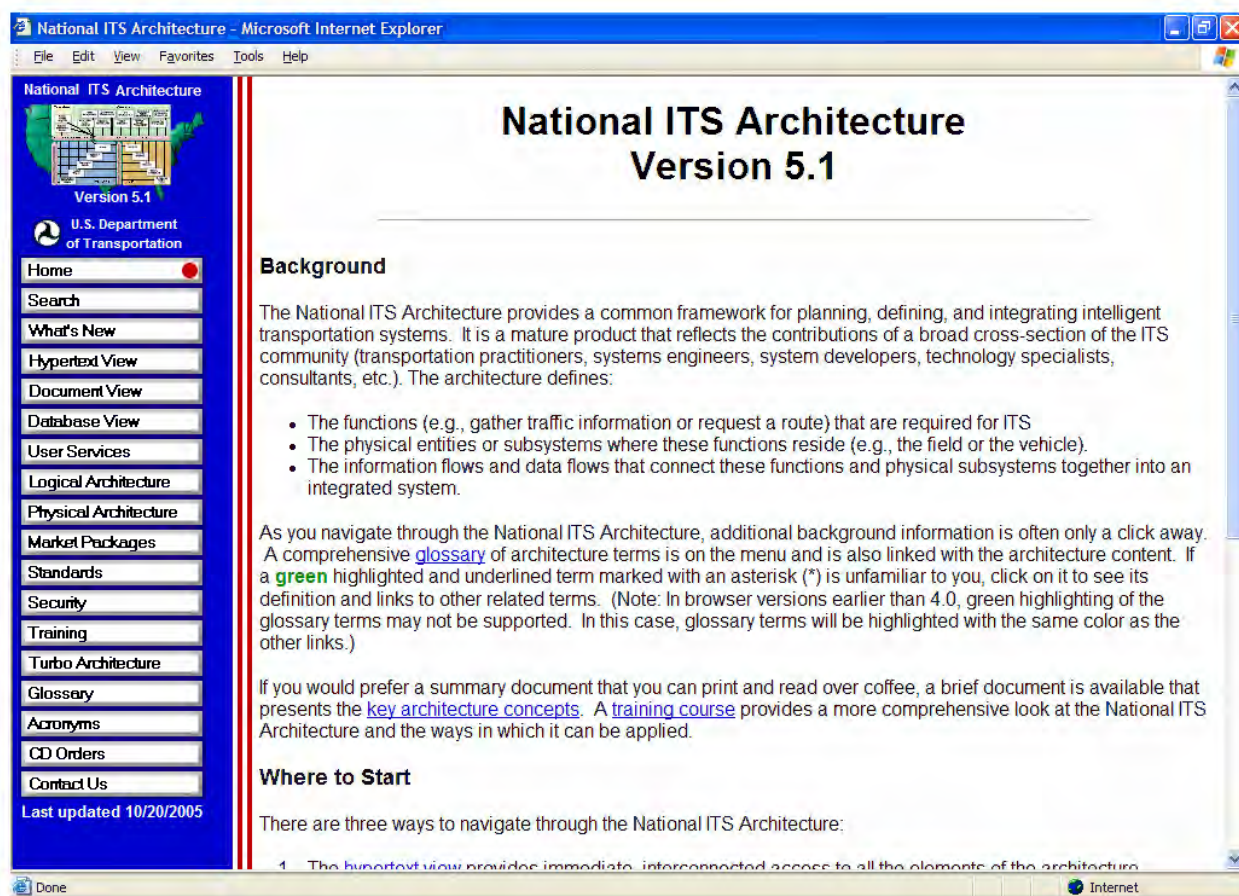

**Figure 58: Index Page of the National ITS Architecture Hypertext View**

By clicking on the *Hypertext View*, a diagram is provided (as shown in Figure 59), that identifies each of the components of the National ITS Architecture. Users may select any aspect of the Architecture by clicking on the various highlighted parts of the diagram: User Services, Processes, Data Flows, Physical Entities, Architecture Flows, Equipment Packages, Market Packages, and Standards.

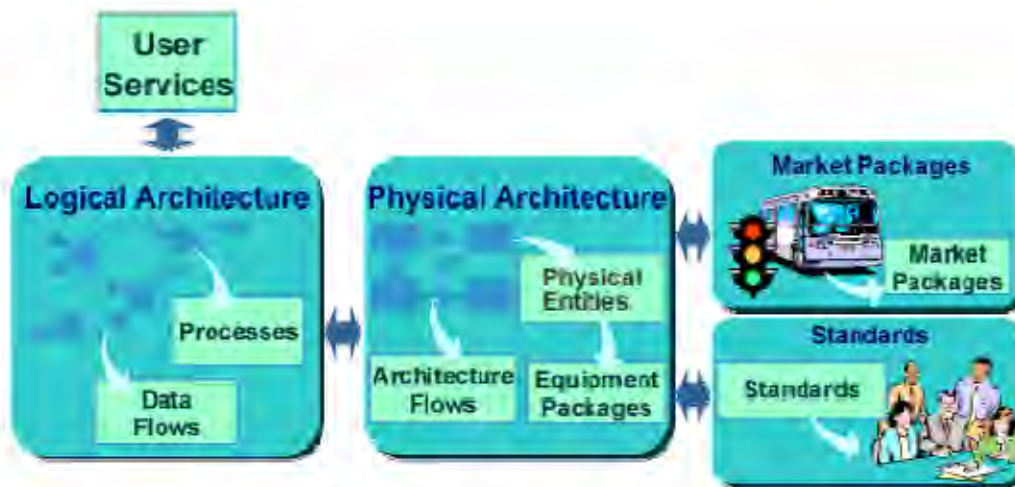

Figure 59: Diagram of Entry Points to the National ITS Architecture

The Hypertext view defines all of the components of the architecture, including textual descriptions that are accompanied by graphics for many of the components. For example, Figure 60 shows a graphical representation of a market package for multi-modal coordination.

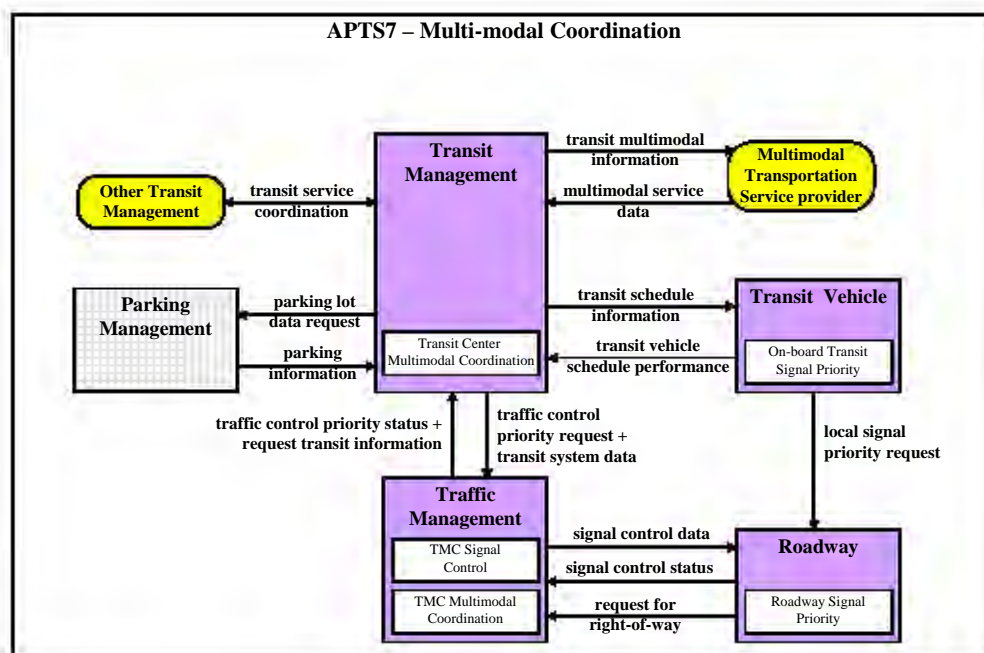

Figure 60: Representative Market Package Graphic

Both text and graphics (in Windows Meta File (WMF) format) can be copied and pasted to support regional ITS architecture definition. The real power of the hypertext view is in the thousands of links between components that allow the user to easily move from one component to any related component with a click of the mouse. For example, the definitions of all subsystems, architecture flows, equipment packages (including functional requirements), and transaction set diagrams that are associated with a particular market package are just a click away.



The Hypertext view is easy to navigate through and provides a familiar web browser interface. Its extensive linked presentation of the National ITS Architecture provides a quick reference guide for use when developing a regional ITS architecture.

## A.2 Databases

For those stakeholders that are familiar with Microsoft® Access, the database view of the National ITS Architecture provides several databases that contain the same content as the hypertext view. The databases that are available on the web site and the CD-ROM are shown in Table 18. Using Microsoft® Access, specialized queries, forms, and reports can be developed to select relevant portions of the Architecture and to display the selected portions in various formats. This is the Architecture in its raw form without the benefit of formatting and linkage contained in the Hypertext version. The databases can be the most flexible and powerful tools available to the regional ITS architecture developer, but they require significant knowledge of Microsoft® Access and the underlying National ITS Architecture database schemas.

**Table 18: National ITS Architecture Databases**

Database	Description
Logical Architecture	Defines all the processes, data flows, and data stores in the Logical Architecture.
Physical Architecture	Defines all subsystems, terminators, equipment packages, interconnects, and architecture flows in the Physical Architecture and their connection with the Logical Architecture components.
Market Packages	Defines the market packages and their relationship to the subsystems, terminators, equipment packages, and architecture flows in the Physical Architecture.
SDOMAP	Defines the relationship between ITS standards and the Physical Architecture. Each ITS standard is identified and mapped to all related architecture flows in this database. This database includes the mapping of architecture flows that have not yet been standardized to standards development categories such as DSRC, Transit Communications, etc.
Security	Defines the functional security areas of the National ITS Architecture as well as security service considerations for securing ITS subsystems and architecture flows through a determination of the applicable security threats and objectives.

## A.3 Turbo Architecture

The Turbo Architecture™ tool is a high-level, interactive software program that assists transportation planners and system integrators, both in the public and private sectors, in the development of regional and project architectures using the National ITS Architecture as a reference. Turbo Architecture™ allows a user to:

- Create a Regional Architecture,
- Create a Project Architecture when no Regional Architecture exists,

- Create a Project Architecture from an existing Regional Architecture, and/or
- Merge a previously-defined Project Architecture into an existing Regional Architecture.

Turbo Architecture™ includes features that support the FHWA Rule 940 and FTA Policy for Regional ITS Architectures and Standards. Final Rule features added to Turbo Architecture include:

- Functional Requirements Support
- Project Sequencing Support
- Operational Concept (i.e. Roles and Responsibilities)
- Additional Fields in Regional Description to fully define an architecture's scope
- Support for List of Agreements
- User Tailored List of Standards

The “Turbo Conversion” utility automatically converts existing Turbo databases so they are consistent with the latest version of the National ITS Architecture. This tool provides users a convenient way to migrate their older architectures to take advantage of the new architecture features. The automated portion of the conversion process requires only a minute or two. Specialized conversion reports document all architecture changes that were made during the conversion so the user retains full control over their architecture.

Turbo Architecture™ helps the user integrate multiple project architectures both with each other and with a regional architecture. In addition, Turbo Architecture™ provides an *initial start* toward both architecture development and consistency with the National ITS Architecture. Proper use of the Turbo Architecture™ tool, however, requires the Turbo Architecture™ user to be familiar with the National ITS Architecture.

The user enters their region- or project-specific information into the tool, and generates an architecture that can be customized to their needs. There are two ways to initially enter information into Turbo Architecture™: via an interview or directly into tabular forms. The interview guides the user through a series of questions and options that result in the creation of a transportation systems inventory and a set of services. The user may also go directly to a pair of tabular forms to create this initial inventory and set of services. In either case, this information initiates the development of an ITS architecture.

Once this initial data input is complete, the user can begin to customize their architecture, which is a necessary next step. Both the interview and tabular forms help the user identify and extract the pertinent National ITS Architecture pieces they require. In addition, Turbo Architecture™ allows the user to map and tailor local system names and descriptions to match local needs, services and systems. The user can also extend their architecture beyond entities and interfaces defined in the National ITS Architecture by adding their own information flows and entities for those areas not covered by the National ITS Architecture.

Figure 61 shows an example of the Interfaces Tab for a Project Architecture that is part of a larger Regional Architecture.

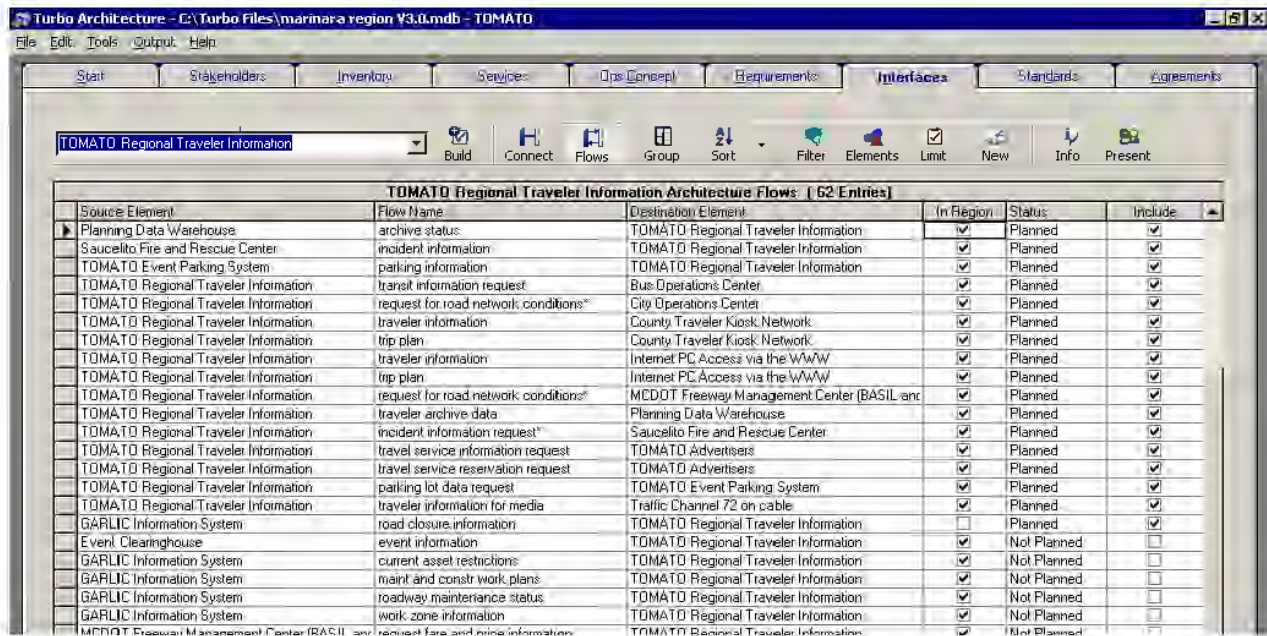

Figure 61: Turbo Architecture Customize Tab

Once the architecture has been customized, there is the issue of how to present the information to stakeholders. Turbo Architecture™ answers this need with multiple useful output reports and diagrams that are available for display and printing. The underlying information describing the architecture is also available for exporting as data sets, which can be further analyzed. Figure 62 shows an example output—an Architecture Flow Diagram of the elements and information flows from a Regional Traveler Information Center to users and other centers in the region.

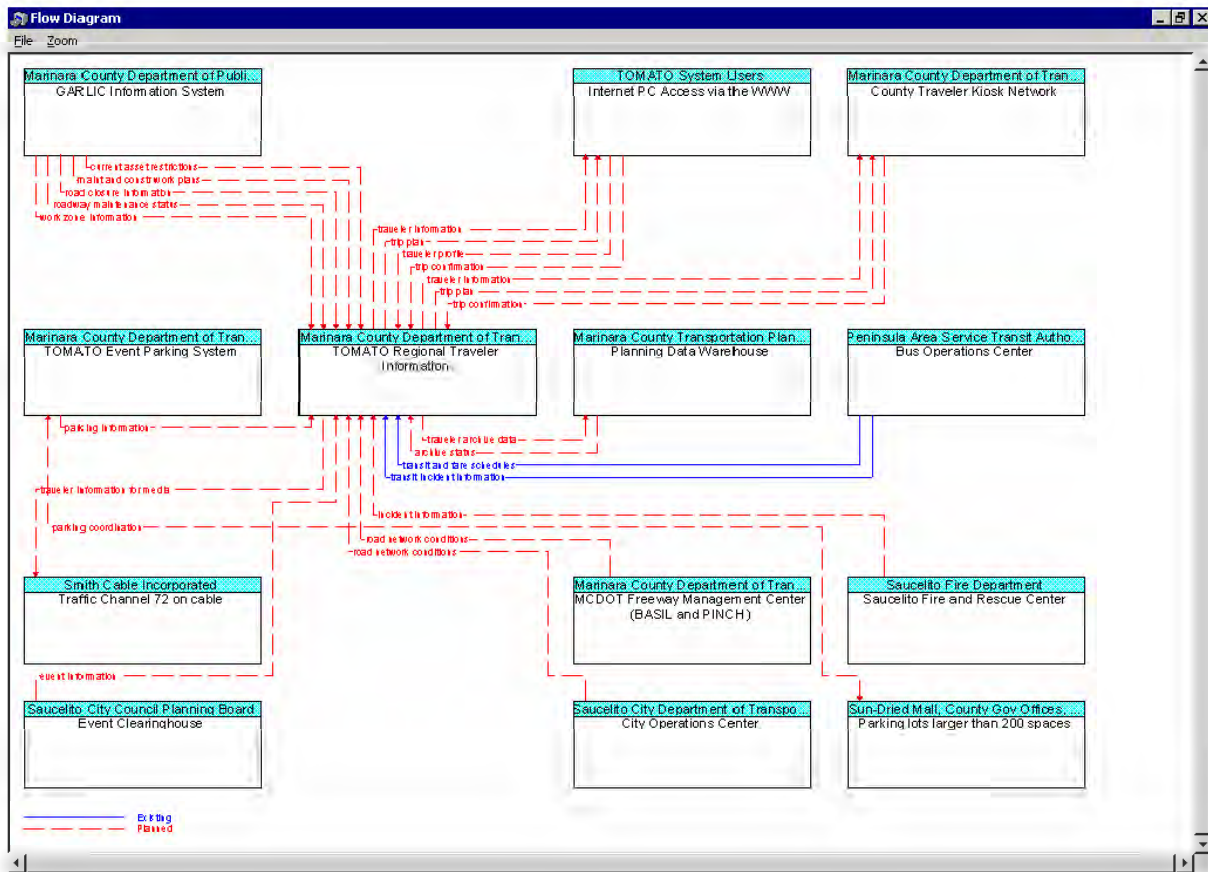
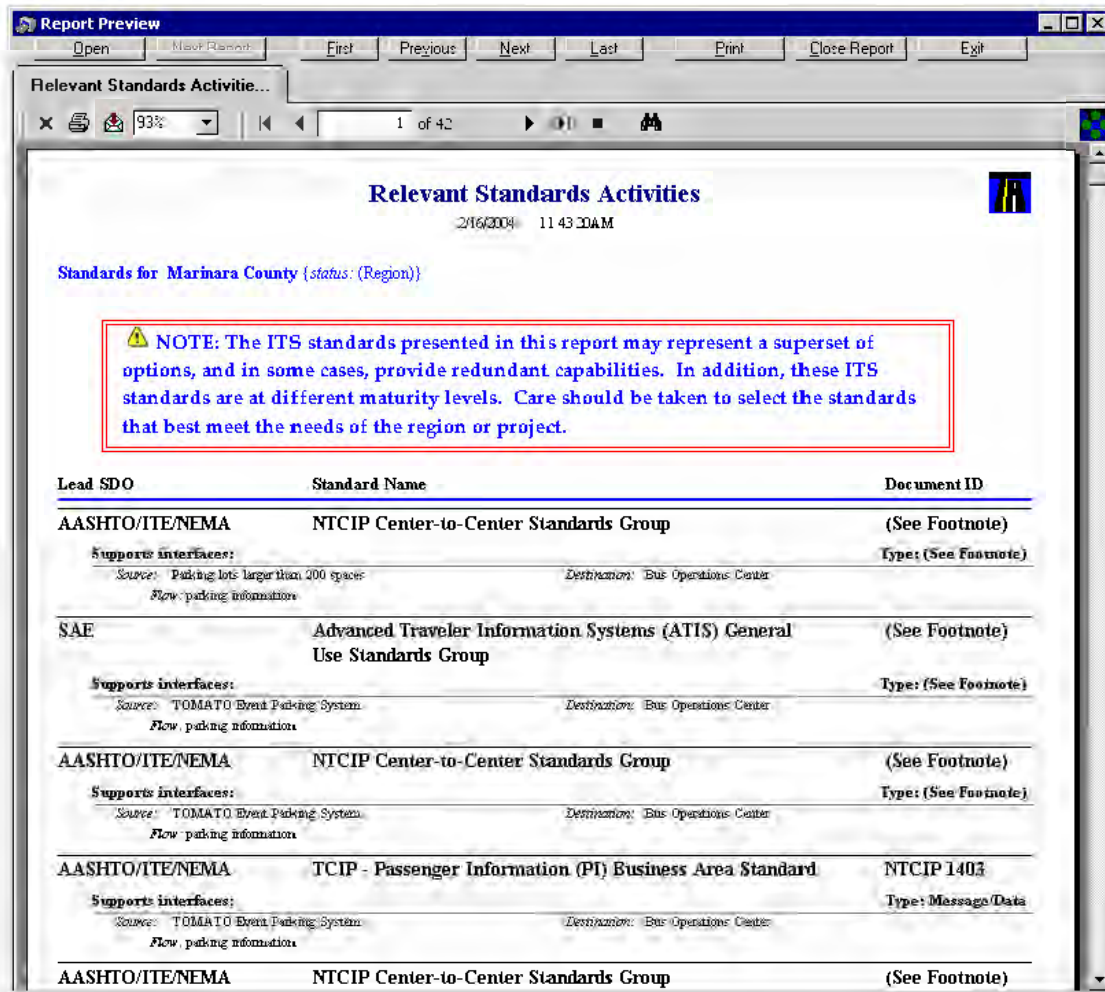

Figure 62: Sample Architecture Flow Diagram

Figure 63 shows an example report available from Turbo Architecture™. This particular report, Relevant Standards Activities, identifies which ITS standards the region or project may want to consider as they implement specific interfaces of their architecture.

Turbo Architecture™ helps the user integrate multiple project architectures with each other and with a regional architecture. In a single file the user can create a single regional architecture and multiple project architectures.



**Figure 63: Sample Turbo Architecture Report**

## Appendix **B** Architecture Maintenance Resources

This Appendix contains resources that support the maintenance of regional ITS architectures:

1. Change management forms
2. Maintenance plan outline
3. Sample maintenance plans, real-world examples from the Inland Empire of California, Northeast Illinois, and Oahu, Hawaii

1.

### **B.1 Sample Change Management Forms**

The following are examples of change request form and change log entries indicating the type of information one might expect to find in these forms.



**Table 19: Sample Change Request Form**

<b>Change Title:</b>	MTA element connection updates	<b>Date of Origination:</b>	1/12/04
<b>Description of Suggested Change:</b>	Add an element to the architecture for MTA Police Dispatch. The MTA Police Dispatch should have connections to MTA Fixed Route Dispatch, MTA Paratransit Dispatch, and the corresponding transit vehicles. The MTA Police Dispatch should also interface with City Public Safety Dispatch and County Public Safety Dispatch. The new element participates in the following Services: Transit Security Emergency Response		
<b>Rationale for Change:</b>	The current regional ITS architecture does not include all of the elements and connections that are important for the transit agency		
<b>Originator:</b>	Joan Smith		
<b>Originator</b>	<b>Telephone:</b>	xxx-xxx-xxxx	
	<b>email:</b>	jsmith@mta.com	
<i>To be filled out by Maintaining Organization</i>			
<b>Change #</b>			
<b>Change Disposition</b>	<b>Accept</b>	<b>Reject</b>	<b>Defer</b>
<b>Baseline Affected:</b>			
<b>Disposition Comment:</b>			
<b>Disposition Date:</b>			

**Table 20. Sample Change Log Entry**

Change #	Change Description	Change Originator	Change Disposition	Disposition Date	Baseline Affected	Change Type	Disposition Comment
Some unique identifier such as 2004.01 to indicate the first change cataloged in 2004.	This could be a copy of the suggested change above, or might be an expanded description. This field might also point to a white paper that details the change.	Copy of name from above	Field with set of choices such as Accept, Reject, Defer. Filled in once the CCB has decided on the change	Date of Disposition	List of baseline documents/ outputs that will be affected by change. This could be a set of columns-one for each part of baseline with check boxes.	Categorize change-might use minor/ major, or something similar.	A field for comments regarding the change or its disposition.

## B.2 Architecture Maintenance Plan Outline

The following provides an example outline for an architecture maintenance plan that follows the guidance given in this document. The exact form and content of each region's plan should be tailored to meet the needs and resources of the region.

- 1- Introduction
- 2- Roles and Responsibilities (for maintaining the architecture)
- 3- Timetable
- 4- Architecture Baseline
- 5- Change management process
  - Identifying changes
  - Evaluating changes
  - Approving changes
  - Updating baseline
  - Notifying stakeholders

## B.3 Real-World Examples

The following provides several real world examples of architecture maintenance plans—the first is for Inland Empire California, the second for Northeastern Illinois, and the third is for Oahu, Hawaii. They are all fairly recent, so no actual change activity has been performed, but each group of stakeholders has indicated their intent to use the maintenance plans for updates to their respective regional ITS architectures. In the case of Northeastern Illinois, the maintenance plan has been formally approved by the MPO's Policy Committee.

### 8.3.4 B.3.1 Inland Empire, California

The following maintenance plan was developed as part of the Inland Empire ITS Architecture in June 2003.

#### *Start of Inland Empire Example*

---

##### *8.2 Architecture Maintenance*

The Inland Empire Area regional ITS architecture should be modified as plans and priorities change, ITS projects are implemented, and the ITS needs and services evolve in the region. The Inland Empire Area ITS Architecture was developed with a ten-year time horizon. As the architecture is updated, it will be extended further into the future. The goal of maintaining the architecture is to keep an up-to-date regional ITS architecture that is accessible and easily used for deploying ITS in the Inland Empire area.

The key aspects of the maintenance process, which are defined in this section are:

- Who is responsible for architecture maintenance?
- What has to be maintained?
- When will the architecture be updated (how often)?
- What is the process by which architecture will be modified/changed?

##### *8.2.1 Who is responsible for Architecture Maintenance?*

Just as a group of Stakeholders were key to the development of the Inland Empire Area Architecture, it is imperative that Stakeholders stay involved in the on-going maintenance. Once regional architecture has been completed and approved by all participating agencies, an Inland Empire Architecture Maintenance Team should be developed that has at least one representative from SANBAG, RCTC, SCAG, Caltrans Traffic Operations and Caltrans Transportation Planning, as appropriate (a mix of planning and operations personnel could serve on this Team). This Maintenance Team should make modification decisions together with each of the four agencies (SANBAG, RCTC, SCAG and Caltrans) having one vote in regional decisions for modifying the architecture. In order to ensure that the architecture stays up-to-date, the first action of this Team should be to determine which agency (SANBAG, RCTC, SCAG, or Caltrans) will take formal responsibility for making physical changes toward maintaining the architecture. This leadership role could also rotate on an annual basis for an equal share of responsibility and accountability or, if agreed upon, one agency can take responsibility for the formal database maintenance.

### 8.2.2 What has to be maintained?

There are several different parts and reports that make up the Inland Empire Regional Architecture. Some require more frequent updates than others, but the entire document will need a periodic review for consistency with regional vision and goals. The current version of Regional ITS Architecture will be established as the baseline Architecture and maintenance time frames identified in this Chapter will begin upon completion.

The Inland Empire Area regional ITS architecture is stored in Microsoft Access databases and is represented through a set of outputs including reports and diagrams. The most significant portions of the architecture will be maintained through updates in the electronic database using TurboArchitecture™. Additionally, the Inland Empire area regional ITS architecture contains several other documents that should be updated at regular intervals:

- Project Sequencing Report as needed
- Operational Concept as needed
- Functional Requirements as needed
- List of Agency Agreements as needed

To aid the Inland Empire in architecture version document control, the filename of the database should contain the date on which the architecture was updated. This will allow the current version to be easily identified.

The following information should be maintained in the TurboArchitecture™ databases:

- Description of the Region
- List of Stakeholders, including key contact information
- Inventory of existing and planned ITS systems in the region
- Documented regional needs and ITS services associated with supporting systems in the region (Market Packages)
- Existing and planned interconnects and information flows for the region.

Outputs such as interconnect and architecture flow diagrams, inventory lists, Stakeholders lists and other diagrams and reports can be produced by a member of the Maintenance Team from TurboArchitecture™ outputs, so they are by-products of the architecture database. These outputs can be updated as necessary for meetings or outreach activities.

### 8.2.3 When will the Architecture be updated (how often)?

Depending upon the outcome of the SCAG Regional Architecture efforts, the Turbo Architecture™ databases from each of the subregions could become an appendix to the RTP and, as the RTP undergoes a formal update once every three years, the architecture could undergo any major modifications at that time. This will be a natural result of the architecture being stream lined into the regional planning process to ensure that the Architecture continues to accurately represent the region. The operational concept, system functional requirements, project sequencing list, and the list of agency agreements represent high-level views of the Inland Empire Area architecture and do not necessarily need to be modified each time a revision is made to the architecture. However, these documents will be modified as the architecture is broadened to address new needs and services or on an *as needed* basis.

### 8.2.4 What is the process by which the Architecture will be modified/changed?

Because changes can arise from many sources, and very likely will arise from some sources outside the technical expertise of a single agency, it is a good idea for a group of people from different Stakeholder areas to be involved in maintenance of the architecture. Representatives

from traffic, transit, emergency management, and other key Stakeholders from the team that developed the architecture should provide input to the Maintenance Team for review. Each county has a Technical Advisory Committee (TAC), comprised of the City and County staff, as well as other ITS Stakeholders. These monthly meetings are an ideal place to remind agencies of the architecture, and for the TACs to be a point of contact to discuss ITS architecture updates and processes. Getting input from the Stakeholders guarantees that the architecture continues to reflect the desires of the Stakeholders in the region.

To allow Stakeholders to use the architecture for their planning and deployment activities, the current architecture database should be available from the Inland Empire Maintenance Team. For easy access, other regional Stakeholders should be notified by e-mail when the architecture database and all other current documentation has an exact location or website from which to be accessed.

In addition to maintaining the architecture, this maintenance plan should be reviewed periodically for required changes. This maintenance plan was developed during the initial development of the Inland Empire Area Regional ITS Architecture. Use of the architecture and modifications to it may differ from what was anticipated. Revising the plan will ensure that the goal of architecture maintenance is realized.

### *8.3 The Change Management Process*

The change management process is the procedure for modifying the Architecture. It specifies how changes are identified, how often they will be made, and how the changes will be defined, reviewed, implemented and released.

#### *8.3.1 How Changes Are Identified*

The Inland Empire Area regional ITS architecture was created as a consensus view of what ITS systems the Stakeholders in the region have currently implemented and what systems they plan to implement in the future. The architecture will need to be updated to reflect changes resulting from project implementation or resulting from the planning process itself. There are many actions that may cause a need to update the architecture.

- Changes for Project Definition. When actually defined, a project may add, subtract or modify elements, interfaces, or information flows of the regional ITS architecture. Because the architecture is meant to describe not only ITS planned for the region, but also the current ITS implementations, it should be updated to correctly reflect the deployed projects.
- Multiple Agency Stakeholders. There are several generic Stakeholders in the Inland Empire Area architecture. These generic Stakeholders group multiple Stakeholders from the region.
- For example, small municipal transit agencies are all identified under one regional ITS element identified as "Small Municipal Transit Agencies". As Stakeholders can be better identified that are covered by these generic Stakeholders terms, the descriptions of these Stakeholders will be added to the Architecture. As their respective elements plan and deploy ITS systems, they should be added as separate elements and Stakeholders in the architecture.
- Changes for Project Addition/Deletion. Occasionally a project will be added, deleted or modified during the planning process. When this occurs, the aspects of the regional ITS architecture associated with the project have to be added, deleted or modified.
- Changes in Project Status. As projects are deployed, the status of the architecture elements, services and flows that are part of the project will have to be changed from

planned to existing. Elements, services and flows will be considered to exist when they are substantially complete in that they have been turned on, tested and are currently being used.

- Changes in Project Priority. Due to funding constraints, technological changes or other considerations, a project planned of the region may be delayed or accelerated. Such changes will need to be reflected in the Inland Empire Area ITS Architecture.
- Changes in Regional Needs. Over time the needs in a region can change and the corresponding aspects of the regional ITS architecture will have to be updated. While the Inland Empire Area ITS Architecture was developed with input from several Stakeholders in the region, not all Stakeholders could or wanted to participate. As ITS deployment increases and benefits of integration are realized, additional Stakeholders will become interested in ITS, the architecture should be updated to reflect their place in the regional view of ITS. The systems they operate and their interfaces will have to be added or revised.

Additionally, the National ITS Architecture itself is a living resource of information and in order to keep a life of at least 20 years into the future, it is expanded and updated from time to time to include new user services or refine existing services. In recent years the National ITS Architecture users asked that maintenance and construction activities be included in the architecture and with national security issues that have arisen since September 11, 2001, in order to address homeland security in transportation systems new security and emergency management entities are being added. How these changes in the national "template" effect the Inland Empire Area regional ITS architecture should be considered as the Regional Architecture is updated. The National ITS Architecture may have expanded to include a user service that has been discussed in a region, but not been included in the regional ITS architecture, or been included in only a limited manner.

### *8.3.2 How Often Changes Are Made?*

A comprehensive architecture update will be completed every three years, concurrent with the update of the RTP. The comprehensive update would include involving new Stakeholders, reviewing services planned for the area, and other items, as appropriate.

Minor revisions, such as changes in the status of an information (architecture) flow between Stakeholders, can be made as the information is known or even on an annual basis. Minor changes can be made by members of the Maintenance Team with consensus among themselves.

In future updates of the Regional Architecture for the Inland Empire Regional ITS Architecture it is recommended that the Architecture Maintenance Team consider documenting traceability between needs to market packages, operational concepts, functional requirements and projects.

### *8.3.3 Change Definition, Review, Implementation, and Release*

Any Stakeholders in the Inland Empire region can propose a change to the regional architecture. Stakeholders should inform the Inland Empire Maintenance Team of the status of any projects with ITS aspects. To properly maintain the architecture, Inland Empire Maintenance Team should be informed not only of when projects are planned; but also when projects are completed or when changes made during design or construction impact the regional architecture.

Stakeholders should propose changes in writing to the Inland Empire Maintenance Team. Proposals should clearly define the architecture aspects to be added, deleted or revised. The



reasons for proposed modifications should be given. Each proposal should include contact information for the person proposing the change so he or she can be contacted if questions arise.

Each proposed modification will be reviewed and considered by the Inland Empire Maintenance Team who at the same time, will consider timing issues as they relate to the RTP and RTIP approval update process. If the proposal for architecture modification has an impact on other Stakeholders, someone from the Team will contact the Stakeholders to confirm their agreement with the modification. If the issue warrants it, a Stakeholders meeting to discuss the modification may be held. If consensus in favor of the modification is reached, the Maintenance Team member who is identified as the "keeper of the databases" should make the revision in the architecture database.

Once the regional architecture has been modified, the Stakeholders in the region should be notified. The Inland Empire Maintenance Team should maintain a list of Stakeholders and their contact information. The Stakeholders should be notified of architecture updates and informed on how to obtain the latest version of the architecture.

*End of Inland Empire Example*

---

**8.3.5 B.3.2 Northeastern Illinois**

The following maintenance plan was approved by the CATS Policy Committee in June 2003 and incorporates part of the documentation of the Northeastern Illinois Regional ITS Architecture from December 2002.

*Start of NE Illinois Example*

---

**Northeastern Illinois Regional ITS Architecture Maintenance Plan**

*The Need for a Maintenance Plan*

The Northeastern Illinois Regional ITS Architecture is not a static set of outputs. It must change as plans change, as ITS projects are implemented, and as the ITS needs and services evolve in the region.

This architecture maintenance plan for northeastern Illinois supplements the Regional ITS Architecture. The maintenance plan defines:

- Who will maintain the architecture
- What will be maintained (specific documents and databases)
- How it will be maintained (i.e. what configuration control process will be used)

The regional ITS architecture is created as a consensus view of what ITS systems the region's stakeholders have implemented and what systems they plan to implement in the future. The regional architecture will need to be updated to reflect various changes:

- Changes in Project Definition – When actually defined, a project may add, subtract or modify elements, interfaces, or information flows from the regional ITS architecture. Because the regional ITS architecture is meant to describe the current (as well as future) regional

implementation of ITS, it must be updated to correctly reflect how the developed projects integrate into the region.

- Changes for Project Addition/Deletion – Occasionally a project will be added or deleted through the planning process and some aspects of the regional ITS architecture that are associated with the project may be expanded, changed or removed.
- Changes in Project Priority – Due to funding constraints, or other considerations, the planned project sequencing may change. Delaying a project may have a ripple effect on other projects that depend on it. Raising the priority for a project's implementation may impact the priority of other projects that are dependent upon it.
- Changes in Regional Needs – Transportation planning is done to address regional needs. Over time these needs can change and the corresponding aspects of the regional ITS architecture that addresses these needs may need to be updated.
- Changes due to New Stakeholders – New stakeholders may come to the table and the regional ITS architecture should be updated to reflect their place in the regional view of ITS elements, interfaces, and information flows.
- Changes to reflect National ITS Architecture Revisions – The National ITS Architecture may be expanded and updated from time to time to include new user services or better define how existing elements satisfy the user services. These changes should also be considered as the regional ITS architecture is updated. For instance, the National ITS Architecture may have expanded to include a user service that has been discussed in a region, but not been included in the regional ITS architecture, or been included in only a cursory manner.

#### *The Maintenance Plan Process*

##### *Who will be responsible for updating the regional architecture?*

Responsibility for maintenance of the Northeastern Illinois Regional ITS Architecture will lie with the Chicago Area Transportation Study (CATS). As the Metropolitan Planning Organization, the CATS Policy Committee provides a forum for regional stakeholders to develop and maintain the regional architecture. In addition, CATS has organized committees and task forces to address components of the regional transportation system. The Advanced Technology Task Force (ATTF) is charged with such an oversight role with respect to ITS.

##### *How will potential changes to the architecture be identified?*

Implementers will self-certify that their projects are consistent with the regional architecture or will request changes in the architecture to maintain consistency. Any ITS project or project with ITS components must be submitted to CATS. Only member organizations of the CATS Policy Committee will be allowed to recommend potential changes to the regional architecture. A simple change request form will be used to document the request and it will be added to a change database maintained by CATS staff.

##### *Who decides if a change to the regional architecture is necessary?*

CATS staff, in coordination with the agency proposing the change, will assess what impact the proposed change has upon the current regional architecture. This assessment will then be passed on to the ATTF, which will serve as a Change Control Group responsible for reviewing and approving changes to the current architecture. A subgroup of the ATTF may be selected to perform technical reviews for the Change Control Group.

##### *How are the changes formally approved?*

The list of recommended changes developed by the ATTF will be submitted first to the CATS Work Program Committee and then to the CATS Policy Committee for approval. Only after acceptance by the Policy Committee are the recommended changes formally approved.

*Who will implement the changes to the regional architecture?*

CATS staff will update the regional ITS architecture using the list of changes approved by the Policy Committee.

*When will the regional architecture be updated?*

Updates of the regional architecture will be coordinated with updates of the Regional Transportation Plan on a three-year cycle.

#### *Maintenance Process Summary*

Details of the architecture maintenance process, including the configuration control documentation, are under Section 12 of the Northeastern Illinois Regional ITS Architecture Documentation. The maintenance plan for the regional architecture can be summarized using the following steps:

1. Requests for changes to the regional ITS architecture are received.
2. Change requests are reviewed by the ATTF and a list of recommended changes is developed.
3. The list of recommended changes must be formally approved by the CATS Work Program Committee and then by the Policy Committee.
4. CATS staff will update the regional ITS architecture using the approved list of changes.

*Excerpt from Section 12 of the Northeastern Illinois Regional ITS Architecture Documentation that describes the baseline and the configuration control process.*

#### *12.2 Architecture Baseline*

Establishing an architecture baseline requires clear identification of the architecture products that will be maintained, including specific format and version information. For the Northeastern Illinois Regional ITS Architecture the following outputs are recommended as the architecture baseline:

- Architecture Document (this document)
- Turbo Architecture Database
- Regional ITS Architecture Web pages

Regarding the Architecture document, it is recommended that the source document, in Microsoft Word format, be held by CATS, while a PDF version of the document be created for general distribution. Also that a version number and date be included inside the cover page.

Regarding the Turbo Architecture Database, it is recommended that CATS maintain a zipped version of the final delivered Northeastern Illinois Regional ITS Architecture database. The name, date, and size of the database file inside the zipped file should be entered into an architecture log as version 1.0 of the architecture.

Regarding the web site, a CD-ROM version of the final web site should be maintained by CATS. It is further recommended that the version number of the architecture be entered somewhere on the home page of the web site so that the version being viewed is immediately identifiable.

#### *12.3 Configuration Control*

Once the baseline is defined, the process for making changes to this baseline must be established. The change management process specifies how changes are identified, how often they will be made, and how the changes will be reviewed, implemented, and released.

*How Changes are Identified* -- This involves two issues-

- who can identify a change to the architecture and
- how will the change request be documented.

For a region as large as Northeastern Illinois, the question of who can make change requests is an important one. If literally anyone can input requests the region runs the risk of being overrun by requests that will tax scarce resources to review and decide upon. On the other end of the spectrum, if too much formality or paperwork are added to the process then many valid or needed changes may go unexpressed. The recommendation is that only members of the ATTF be allowed to identify potential changes. This effectively means that any change suggested has the approval of a member of the task force. This has the added benefit of spreading the resources needed to generate or evaluate changes among the group.

As to how the change request should be documented—it is recommended that a simple change request form be created that contains at least the following information

- Name of change
- Description of change
- Part of baseline affected (could be check boxes for document, database, web site, and not known)
- Rationale for change
- Originator name or agency
- Date of origination

This information will ultimately be added to a change database (recommended to be maintained by CATS personnel) that will add the following additional fields of information

- Change number (some unique identifier)
- Change disposition (accepted, rejected, deferred)
- Change type (minor or significant)
- Disposition comment
- Disposition date

*How often Changes are Made* -- It is recommended that the first update to the architecture baseline be made approximately a year after completion of the initial version. Depending upon the amount of change requests submitted, this could be anything from a minor update to correct errors found to a more significant update to include changes in stakeholders, elements, and connections. Also some changes could be deferred until the next major update of the architecture. It is recommended that a major review and update of the architecture (including possibly additional stakeholder meetings) be performed in the 6 months prior to the update of the Regional Transportation Plan. This will allow an updated version of the architecture to be used as the basis for the RTP update. Additional minor revisions of the baseline could be considered on a yearly basis.

*Change Review, Implementation, and Release* -- The general steps in the change review process are:

1. Define changes per the recommendations given above.
2. Assess the impact of the change. Someone needs to evaluate the change and determine what impact it has upon the architecture baseline. There are three options for who performs this evaluation
  - a. the person proposing the change (i.e. the member of the ATTF that brings it forward)
  - b. a staff member of CATS (the agency responsible for architecture maintenance) or

- c. a contractor through some architecture support contract.

Each of these options has positive and negative implications. The first option will work well for minor changes (e.g. changes in status, connections, or descriptions). However, it does require each submitting person to have sufficient knowledge of the architecture to suggest appropriate solutions. The second option requires the architecture knowledge to be available through CATS personnel. Their long-term availability to perform the work is a possible risk. The third implies contracting for the necessary expertise, so has the negative of additional cost associated with it.

3. Provide a recommendation to the Change Control Group. For proper change control some group should be assigned responsibility for reviewing and approving changes to the baseline. The recommendation is that a subgroup of the ATTF be appointed for this purpose. This Change Control Group (sometimes referred to as a Configuration Control Board) should be lead by the individual responsible for maintaining the architecture (or by one of the individuals if it is a group activity). The job of the Group is to decide what changes go into the architecture baseline. This could be done through periodic meetings (say quarterly), through electronic correspondence, or a combination of both. A recommendation is that minor changes be handled through monthly email distribution and approval, while major changes or areas of disagreement be handled at the periodic face to face meetings. It is important to maintain the consensus nature of the architecture by having a group of core stakeholders agree on changes.
4. The Change Control Group makes a decision. Either it accepts the change, rejects it, or asks for additional evaluation.
5. The decision is implemented. If the decision is to accept the change, then the appropriate portions of the architecture baseline are updated (per the schedule discussed above) and an updated architecture baseline is defined.

The time required to perform this configuration control process will be a direct function of the number of changes suggested to the architecture, which will be driven by how much the architecture is being used. It is suggested that the process be reviewed within the first year and fine-tuned to most appropriately address the level of change that has occurred.

### *End of NE Illinois Example*

---

### **8.3.6 B.3.3 Oahu, Hawaii**

The following are excerpts from the Oahu Regional ITS Architecture Procedures and Responsibilities Report, dated October 2003. Chapters 2, 3, 4, and parts of 6 are included below.

### *Start of Oahu Example*

---

## **2 Policy on ITS Architecture Maintenance**

Part (f) of 23 CFR 940.9 states that “the agencies and other stakeholders participating in the development of the regional ITS architecture shall develop and implement procedures and responsibilities for maintaining it, as needs evolve within the region.” In conjunction with this, the *Oahu Regional ITS Architecture* includes a policy statement as part of its Integration Strategy to meet this regulation. Policy A.5 states, “The region will establish a method for

maintaining the ITS Architecture to ensure that eligibility for Federal transportation funding is maintained.”

This policy does not dictate the ITS architecture maintenance procedure, but supports the region in the development of a maintenance approach. Maintenance of the architecture includes:

- Assessing proposed ITS projects against the ITS architecture to determine if they are consistent and to determine if changes should be made to the architectures to reflect architecture flows proposed in the projects.
- Periodically updating the regional ITS architecture to ensure that the *Oahu Regional ITS Architecture* does not become obsolete. The number of years between updates depends on several factors- including the rate at which ITS is deployed, the number and types of changes made to the National ITS Architecture and standards, changed circumstances that result in new needs that may be met using ITS, and the rate of change of ITS technologies and systems available in the marketplace.

Most regions identify a group that would convene, when required, to perform/ oversee the two activities noted above. Fortunately, the OMPO Policy Committee has already established an *Organizational Structure for Addressing ITS Policy Issues* (see Appendix A) in which it identifies an ad hoc ITS Task Force to deal with technical ITS issues. (The role of this task force is described in Section 4 of this document).

Key activities, as described in the Integration Strategy, that are suggested in this policy include:

1. All partner agencies need to identify candidates for the ad hoc ITS Task Force that will focus on Architecture Maintenance. The Task Force will need to determine which agency will be the leader of the group, or if leadership will rotate among key partner agencies. The leader will be responsible for convening the larger group when necessary.
2. Partner agencies need to identify funding sources that can be used to fund regional ITS architecture maintenance activities, if funding is required.

### **3. OMPO ITS Organizational Structure**

The maintenance of the ORITSA architecture utilizes the existing structure as established and as stated in the *Organizational Structure for Addressing ITS Policy Issues*. (See Appendix A for a complete copy of the document.) Each of the functions for the respective committees listed is described along with their areas of responsibility.

#### **3.1 Policy Committee**

Function: To serve as ITS policy decision-maker

Areas of Responsibility:

- a. Prioritize Oahu’s ITS projects under the 3-C planning process, regardless of funding source
- b. Endorse the federal funding of Oahu’s ITS projects
- c. Endorse general city-state coordination, agreements, or other interests
- d. Promote legislation to assist in the development and implementation of a fully integrated and coordinated ITS system.

#### **3.2 Technical Advisory Committee**

Function: To serve as a technical resource to the Policy Committee



**Areas of Responsibility:**

- a. Identify potential policy issues to Policy Committee
- b. Make recommendations to Policy Committee on ITS policy issues
- c. Make technical (non-policy) ITS decision in areas impacting city and state jurisdictions
- d. Document ITS planning activities in the Overall Work Program (OWP)
- e. Provide resources to inform Citizen Advisory Committee (CAC) of policy issues when public input is needed

**3.3 ITS Technical Task Force****Composition:**

- a. Technical Advisory Committee (TAC) agency representatives
- b. Ad hoc members as required by the agenda
- c. FHWA representative

Function: To serve as the ITS technical expert arm of the TAC

**Areas of Responsibility:**

- a. Be a forum for agencies to discuss and report progress on ITS activities
- b. Identify potential policy issues to TAC for Policy Committee action
- c. Resolve technical issues regarding implementation
- d. Identify technical issues not resolved by the ITS Technical Task Force which must be forwarded up to TAC for TAC action
- e. Develop pros, cons, and recommendations for TAC

**3.4 Citizen Advisory Committee**

Function: to provide public input to the Policy Committee

**Areas of Responsibility:**

- a. Chair to determine whether public input, through the CAC, will be sought
- b. Make recommendations to Policy Committee when public input is sought

**3.5 OMPO Staff**

Functions: To coordinate and promote discussions on potential policy issues within the OMPO process; and to advise the Policy Committee

**Areas of Responsibility**

- a. Participate in the ITS Technical Task Force, TAC, and CAC
- b. Identify potential policy issues

**4 ad hoc ITS Task Force****4.1 Membership**

Because the ITS Technical Task Force allows for ad hoc members, this will be the venue utilized for the maintenance of the Oahu Regional ITS Architecture. The standing task force members will be from the following OMPO participating agencies.

- Department of Transportation Services (DTS)
- Department of Transportation (DOT)
- Department of Planning and Permitting (DPP)
- Department of Business, Economic Development and Tourism (DBEDT)
- FHWA

As needed, members from the following agencies will be invited to participate on the Task Force:

- Department of Design and Construction (DCC)
- Department of Information Technology (DIT)
- Federal Motor Carrier Safety Administration (FMCSA)
- FTA
- Honolulu Emergency Services Department (HESD)
- Honolulu Fire Department (HFD)
- Honolulu Police Department (HPD)
- Oahu Civil Defense Agency (OCDA)
- Etc.

See Appendix C of this document for contact information

#### 4.2 *Role of the ad hoc ITS Technical Task Force*

With respect to maintaining the *Oahu Regional ITS Architecture*, the role of the ad hoc ITS Technical Task Force will be to:

- Assess proposed ITS projects against the ITS architecture to determine if they are consistent, and to determine if changes should be made to the architecture to reflect architecture flows proposed in the projects.
- Assess the regional ITS architecture to ensure that the *Oahu Regional ITS Architecture* does not become obsolete and to recommend changes to update the *Oahu Regional ITS Architecture*.

Meetings of the ad hoc ITS Technical Task Force will be convened, at a minimum, annually, and with the development of each Transportation Improvement Program (TIP). In addition, if ITS projects are added through amendments to the TIP, each non-administrative amendment of the TIP will also trigger a meeting of the ad hoc ITS Technical Task Force.

#### 4.3 *Role of OMPO Staff*

OMPO shall initially assume chairmanship of the ad hoc ITS Technical Task Force. Under its chairmanship, OMPO shall be responsible for convening meetings as needed. OMPO shall maintain the *Oahu Regional ITS Architecture* and will be responsible for the maintenance of the master copy of the Turbo Architecture. (Refer to Appendix D for a description of Turbo Architecture) Updates of any changes to the *Oahu Regional ITS Architecture* will be provided to the ad hoc ITS Technical Task Force.

#### 4.4 *Role of Agencies*

Agencies that are making modifications to the *Oahu Regional ITS Architecture* will be responsible for coordinating with OMPO to convene meetings of the ad hoc ITS Technical Task Force and providing the group with appropriate information of the proposed changes. They will also be responsible for determining the agencies that will be participating on the ad hoc ITS Technical Task Force. Changes that are agreed to by the ad hoc ITS Technical Task Force shall be documented by the proposing agency through a technical memorandum and in Turbo Architecture. City and State agencies are the only entities that can make a change to the *Oahu Regional ITS Architecture*; private organizations will need to work with a sponsoring agency in an effort to make a change to the *Oahu Regional ITS Architecture*.

#### 4.5 Turbo Architecture

Agencies that require Turbo Architecture can obtain a copy of the software through OMPO. OMPO will program the request as part of its OWP. See Appendix D for a description of Turbo Architecture, as obtained from the National ITS Architecture website.

## 6 Modifying the Architecture

This section describes detailed procedures for ITS projects that are found in the TIP and TIP amendments. Administrative and non-administrative amendments to the *Oahu Regional ITS Architecture* are described.

### 6.1 ITS Projects Proposed for Programming in the TIP

At the time when projects are being considered for inclusion in the TIP, the ad hoc ITS Technical Task Force shall meet to determine which projects can be considered TIS projects. Of those projects, the ad hoc ITS Task Force shall then determine, by the approach outlined in Figure 1, whether they are consistent with the *Oahu Regional ITS Architecture*.

#### 6.1.1 Is the project included in or consistent with the Oahu Regional ITS Architecture?

If the project is determined by the ad hoc ITS Technical Task Force to already be included in or consistent with the *Oahu Regional ITS Architecture*, then the project will be considered for inclusion into the TIP. If the project is found to be inconsistent with the *Oahu Regional ITS Architecture*, then the next question will be answered.

#### 6.1.2 Does the project require communications links or data sharing between two or more agencies?

If the projects is an ITS project and communication links or data sharing occurs within the proposing agency only (not between two or more agencies), then the project will be considered for inclusion into the TIP. However, if the projects requires communication links or data sharing between two or more agencies, then the project is defined, by default, as a regional project and will need to go through the process to determine whether the projects should be included in the *Oahu Regional ITS Architecture*.

#### 6.1.3 Will the Oahu Regional ITS Architecture be amended prior to its start or as part of the project scope of work?

If, as part of the projects scope of work, the *Oahu Regional ITS Architecture* will be amended, then the project will be considered for inclusion into the TIP. If there are no plans to amend the *Oahu Regional ITS Architecture* as part of the project scope of work or as part of the project, then the project is not eligible for inclusion in the TIP.

As part of the project scope of work, the following procedures are to be followed:

1. The proposing agency will work with the ad hoc ITS Technical Task Force to determine how the *Oahu Regional ITS Architecture* should be amended.
2. The proposing agency will make a presentation to the TAC, and then to the Policy Committee, that details the amendment, including the following information:
  - Market package(s) to be added to the *Oahu Regional ITS Architecture*;
  - Agencies that will be part of the market package; and
  - List of anticipated communication and data exchanges that will transpire between agencies.

Figure 1: ITS Projects and the draft TIP – Determining Consistency with the Oahu Regional ITS Architecture

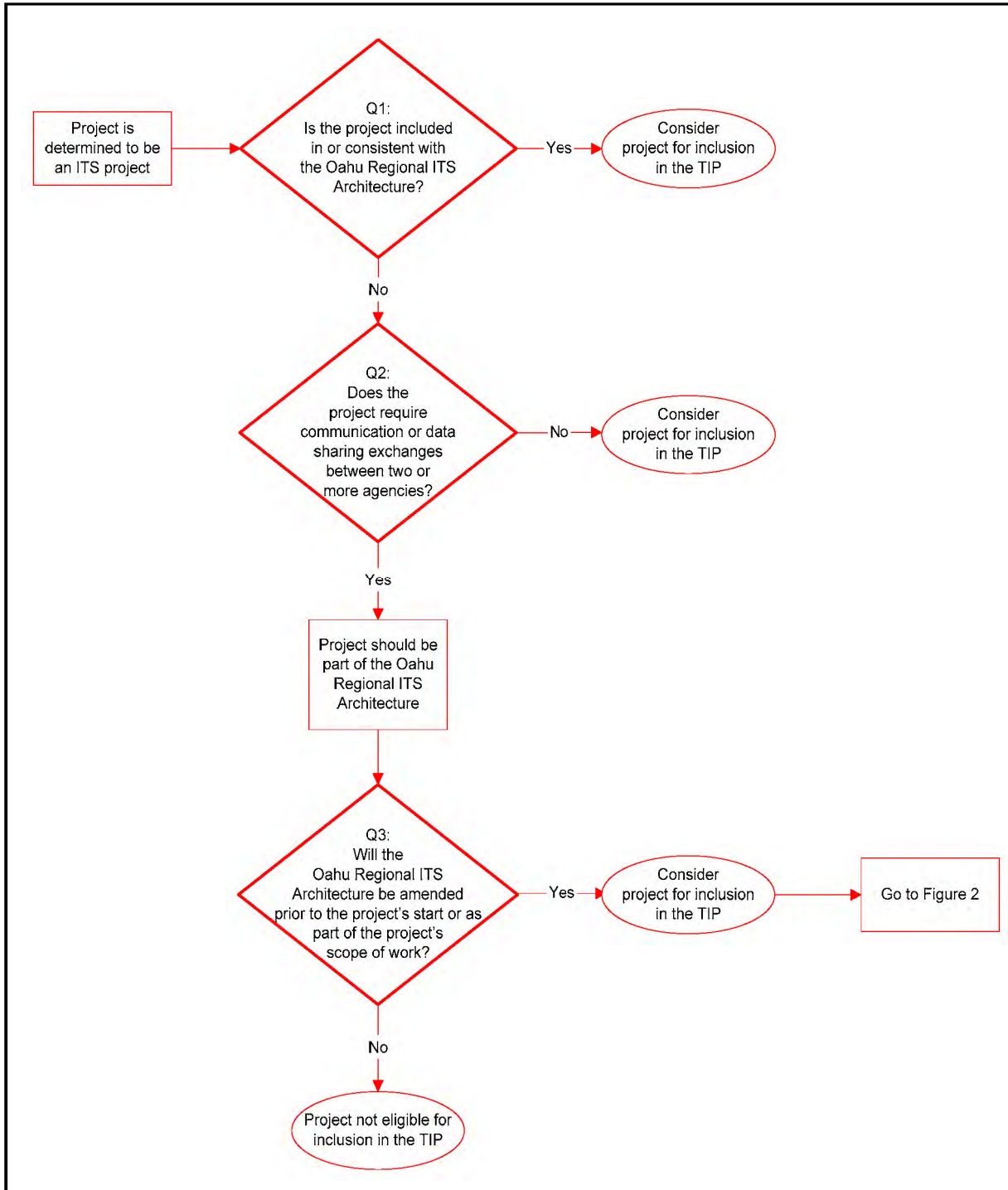

6.1.4 Documentation

The agency proposing change will prepare a short report on behalf of the ad hoc ITS Technical Task Force, that lists the ITS projects that are eligible for inclusion in the TIP. This report will be

submitted to the OMPO staff member responsible for the TIP. An example of this report can be found in Appendix B.

## 6.2 Amending the Oahu Regional ITS Architecture

There are two types of amendments that can be made to the *Oahu Regional ITS Architecture*: administrative and non-administrative.

### 6.2.1 Administrative Amendments

Administrative amendments do not require Policy Committee action and can be done by agency staff and the ad hoc ITS Technical Task Force. These amendments will amend the communication and data exchanges in the market packages of the *Oahu Regional ITS Architecture*. As of April 2003, there were six market packages in the *Oahu Regional ITS Architecture*. These are:

- ITS Virtual Data Warehouse (AD3)
- Broadcast Traveler Information (ATIS1)
- Regional Traffic Control (ATMS07)
- Incident Management (ATMS08)
- Emergency Response (EM1)
- Emergency Routing (EM2)

#### 6.2.1.1 Role of Agency and Task Force

Agency staff, as appropriate, will evaluate each proposed ITS projects to determine if the projects is consistent with the *Oahu Regional ITS Architecture*. For example, if DTS is proposing an ITS project, then DTS will be responsible for determining if the project is consistent with the *Oahu Regional ITS Architecture*.

The project will be considered consistent with the *Oahu Regional ITS Architecture* if it is part of one of the six market packages listed in Section 6.2.1. The proposing agency will work with the ad hoc ITS Technical Task Force to document the communications and data exchanges between agencies.

If the agency finds the project to be consistent, and the communications flows are documented as “existing”, then no action by the agency staff is required.

If the project is consistent, and the communication flows are documented as “planned”, then agency staff shall prepare a technical memorandum to inform OMPO that the *Oahu Regional ITS Architecture* needs to be updated. Documentation of these exchanges will be provided by the proposing agency in two forms:

1. Technical memorandum that details each of the added or changed communication and data exchanges; and
2. Updated Turbo Architecture file.

#### 6.2.1.2 Role of OMPO Staff

OMPO staff shall notify its participating agencies and appropriate ad hoc ITS Technical Task Force agency representatives, and incorporate agency changes to the *Oahu Regional ITS Architecture* and in the Turbo Architecture master file.

If a consultant is being retained to assist the agency in the development of the project, this shall be included as one of the talks and deliverables as specified in the contract.

### 6.2.2 Non-Administrative Amendments

Non-administrative amendments require Policy Committee action. If the project is not part of one of the six market packages previously listed, an amendment to the *Oahu Regional ITS Architecture* will be required.

#### 6.2.2.1 Role of Agency and Task Force

If the ITS project is inconsistent with the *Oahu Regional ITS Architecture*, the proposing agency will coordinate with the chair of the ad hoc ITS Technical Task Force to convene a meeting of the ad hoc ITS Technical Task Force to propose an amendment to the *Oahu Regional ITS Architecture*. The agency that is proposing the amendment will identify, in writing, the other City and State agencies that should be invited to participate in the ad hoc ITS Technical Task Force meeting. Note that the agencies involved will be dependent on the type of project that is being proposed.

The proposing agency will work with the ad hoc ITS Technical Task Force to determine how the *Oahu Regional ITS Architecture* should be amended. When the decision has been made, the proposing agency will make a presentation to the Technical Advisory Committee that details the amendment, including the following information:

- Market package(s) to be added to the *Oahu Regional ITS Architecture*;
- Agencies that will be part of the market package; and
- List of anticipated communication and data exchanges that will transpire between agencies.

#### 6.2.2.2 Role of the TAC

The TAC will be asked to recommend that the Policy Committee endorse the proposed amendment to the *Oahu Regional ITS Architecture*. If the TAC does not make such a recommendation, the project will be forwarded to the Policy Committee with the TAC's reasons for not recommending the Policy Committee endorse the proposed amendment noted. The proposing agency, at that time, can decide how it would like to proceed (e.g., leave proposal as is; amend proposal; fund project with local money; etc.)

If the TAC does recommend that the Policy Committee endorse the amendment, it may make suggestions for the agency to modify the proposal. The proposing agency will work with the ad hoc ITS Technical Task Force to incorporate these modifications before making a presentation to the Policy Committee.

#### 6.2.2.3 Role of the Policy Committee

The Policy Committee will be asked to endorse the proposed amendment. If it does not endorse the amendment, the project is not eligible for federal funds through the TIP process. If the Policy Committee does endorse the amendment, the project can be considered for inclusion in the TIP.

#### 6.2.2.4 Role of Proposing Agency

The proposing agency will work with the ad hoc ITS Technical Task Force to document the communication and data exchanges between agencies. Documentation of these exchanges will be provided by the proposing agency in two forms:

1. Technical memorandum that details each of the added or changed communication and data exchanges; and
2. Updated Turbo Architecture file.



#### *6.2.2.5 Role of OMPO Staff*

Upon receipt of the documentation of changes and the updated Turbo Architecture file, OMPO staff will incorporate them into the *Oahu Regional ITS Architecture* and maintain the master files.

Figure 2 outlines the process for amending the *Oahu Regional ITS Architecture*.

Figure 2: Amending the Oahu Regional ITS Architecture

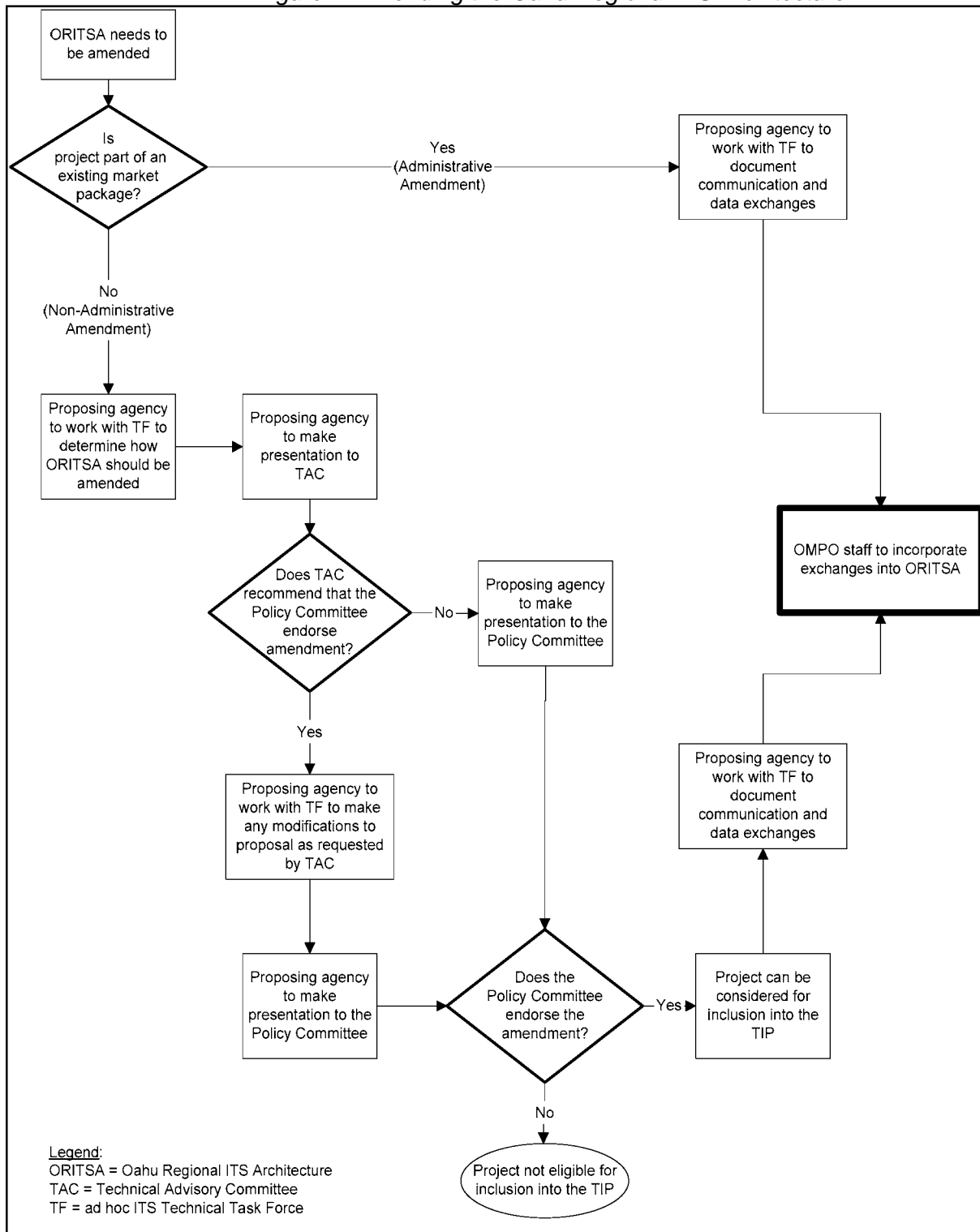

End of Oahu Example



## Glossary

### ***Architecture***

A framework within which a system can be built. Requirements dictate what functionality the architecture must satisfy. An Architecture functionally defines what the pieces of the system are and the information that is exchanged between them. An Architecture is functionally oriented and not technology specific which allows the Architecture to remain effective over time. It defines “what must be done,” not “how it will be done”.

### ***Architecture Baseline***

The clear identification of the architecture products that will be maintained, including specific format and version information. Changes to the Architecture Baseline must follow an approved change management process typically documented in a Maintenance Plan. The Architecture Baseline will change over time as the Architecture is revised.

### ***Architecture Flow***

Information that is exchanged between Subsystems and Terminators in the Physical Architecture view of the National ITS Architecture. Architecture Flows are the primary tool that is used to define the Regional ITS Architecture Interfaces. These Architecture Flows and their communication requirements define the Interfaces, which form the basis for much of the ongoing Standards work in the National ITS program. In this document, the terms “information flow” and “architecture flow” are used interchangeably.

### ***Architecture Interconnect***

Communications paths that carry information between Subsystems and Terminators in the Physical Architecture view of the National ITS Architecture. Several different types of Interconnects are defined in the National ITS Architecture to reflect the range of Interface requirements in ITS. The majority of the interconnects are various types of communications links that are defined in the communications layer. Four different types of communications links are defined: Fixed-Point to Fixed-Point, Wide Area Wireless, Dedicated Short Range Communications, and Vehicle to Vehicle communications. In addition to these types, several specialized Interconnects are also defined to reflect other Interface requirements, including human interface (e.g., what the system user sees and hears) and physical/environmental (e.g., what the ITS sensors sense).

## ***Center Subsystems***

Subsystems that provide management, administrative, and support functions for the transportation system. The Center Subsystems each communicate with other centers to enable coordination between modes and across jurisdictions. Some examples of center subsystems are Traffic Management, Transit Management, Commercial Vehicle Administration, Planning, Emissions Management, Toll Administration, Emergency Management, Information Service Provider, and Fleet and Freight Management. One of four general Subsystem classes defined in the National ITS Architecture.

## ***Champion***

Person or persons who serve as a point-of-contact and provide leadership in the development, use, and maintenance of a Regional ITS Architecture.

## ***Communications Hub***

A communications hub facilitates communications connectivity between regional ITS architecture systems. Hubs normally provide communications and server functions and may or may not provide transportation-related functions such as data fusion.

## ***Congestion Management Plan***

Document that describes the strategy that will be used to prevent deterioration of Congestion Management System (CMS) performance.

## ***Congestion Management System (CMS)***

TEA-21 required that each Transportation Management Area (see definition of TMA) develop a CMS that provides for effective management of new and existing transportation facilities through the use of travel demand reduction and operational management strategies. This was replaced by a Congestion Management Process in SAFETEA-LU.

## ***Corridor/Sub-area Study***

Also known as “Major Investment Studies,” these studies are used to flesh out transportation strategy and project recommendations on a geographic basis. A Corridor or Sub-area is a context for evaluating how specific transportation conditions, problems, and needs should be addressed within the defined geographic area. A wide range of multimodal strategies, including ITS, are considered as candidate solutions for those problems.

## ***Data Flow***

Data flows represent a pipeline along which information of known composition is passed. Data Flows are modeled in the Logical Architecture view of the National ITS Architecture. Data Flows represent data flowing between Processes or between a

Process and a terminator. A Data Flow is shown as an arrow on a Data Flow Diagram and is defined in a Data Dictionary Entry in the Logical Architecture, including a textual description of the Data Flow and any lower level data elements that make up the Data Flow. Data flows are aggregated together to form high-level Architecture Flows in the Physical Architecture view of the National ITS Architecture.

### ***Data Flow Diagram***

The diagrams in the Logical Architecture view of the National ITS Architecture that show the functions that are required for ITS and the data that moves between these functions. Only four different symbols are used on the diagrams. Circles represent the Processes or functions that do the work. Arrows represent the Data Flows that show how data moves through the system. Parallel lines represent Data Stores that represent “data at rest” in the system. Finally, rectangles represent the terminators that define the Architecture boundary. A hierarchy of these diagrams depict the ITS functionality and Data Flow requirements in successively greater detail.

### ***Dedicated Short Range Communications (DSRC)***

A wireless communications channel used for close-proximity communications between vehicles and the immediate infrastructure. It supports location-specific communications for ITS services such as toll collection, transit vehicle management, driver information, and automated commercial vehicle operations. One of the types of Architecture Interconnects defined in the National ITS Architecture.

### ***Element***

This is the basic building block of Regional ITS Architectures and Project ITS Architectures. It is the name used by the Stakeholders to describe a system or piece of a system.

### ***Equipment Package***

Equipment Packages are the building blocks of the Physical Architecture Subsystems. Equipment Packages group like Processes of a particular Subsystem together into an “implementable” package. The grouping also takes into account the User Services and the need to accommodate various levels of functionality. Since Equipment Packages are both the most detailed elements of the Physical Architecture view of the National ITS Architecture and tied to specific Market Packages, they provide the common link between the interface-oriented Architecture definition and the deployment-oriented Market Packages.

### ***Federal Highway Administration (FHWA)***

An agency of the United States Department of Transportation that funds highway planning and programs.

**Federal Transit Administration (FTA)**

An agency of the United States Department of Transportation that funds transit planning and programs.

**Field Subsystems**

One of four general classes of Subsystems defined in the National ITS Architecture. This class includes the intelligent infrastructure distributed along the transportation network which perform surveillance, information provision, and control functions. This includes ITS field equipment on roadway facilities as well as ITS equipment at parking facilities, toll systems, security monitoring systems, and commercial vehicle check systems that are also at or near the roadside.

**Fixed-Point to Fixed-Point Communications**

A communications link serving stationary entities. It may be implemented using a variety of public or private communications networks and technologies. It can include, but is not limited to, twisted pair, coaxial cable, fiber optic, microwave relay networks, spread spectrum, etc. In Fixed-Point to Fixed-Point (FP2FP) communication the important issue is that it serves stationary entities. Both dedicated and shared communication resources may be used. One of the four types of Architecture Interconnects defined in the National ITS Architecture.

**Functional Requirements**

A description of WHAT a system must do to address the needs or provide the services that have been identified for the region. The description should use formal “shall” language and document the functions in terms that the stakeholders, particularly the system implementers, will understand. In a Regional ITS Architecture, the Functional Requirements focus on the high-level requirements that support regional integration. For a project ITS architecture, these are broken down into more detailed requirements to fully understand the functionality of the system.

**Highway Trust Fund (HTF)**

Established as a federal mechanism for financing the accelerated highway program, the HTF is a source of funds from which ISTEA, TEA-21, and now SAFETEA-LU authorizes expenditures.

**Hub**

See Communications Hub.



***Information Flow***

Information that is exchanged between Subsystems and Terminators in the Physical Architecture view of the National ITS Architecture. In this document, the terms “Information Flow” and “Architecture Flow” are used interchangeably.

***Institutional Integration***

Institutional Integration represents the process of combining existing and emerging institutional constraints and arrangements. Integration is at least two-fold in a region; technical integration involves the functional act of integration while institutional integration addresses the agency and/or regional environment for integration. Both are necessary components for interoperable systems.

***Intelligent Transportation System (ITS)***

Electronics, communications, and information processing used singly or integrated to improve the efficiency or safety of surface transportation.

***ITS Architecture***

Defines an Architecture of interrelated systems that work together to deliver transportation Services. An ITS Architecture defines how systems functionally operate and the interconnection of information exchanges that must take place between these systems to accomplish transportation Services.

***ITS Project***

Any project that in whole or in part funds the acquisition of technologies or systems of technologies that provide or significantly contribute to the provision of one or more ITS User Services.

***ITS Strategic Plan***

A guide for long term implementation of ITS in the state, metropolitan area, or region. A Strategic Plan will normally include identifying regional transportation needs and then defining ITS Elements to be implemented over time, aimed at meeting those needs. A regional ITS architecture is typically a core component of an ITS Strategic Plan.

***Interconnect***

See Architecture Interconnect.

***Interface***

The connection between two systems. In the regional ITS architecture, an interface is described by the architecture interconnect – the line of communications between the

two systems – and the information flows that define the types of information that will be shared over the interconnect.

### ***Intermodal Surface Transportation Efficiency Act of 1991 (ISTEA)***

Legislative initiative by the United States Congress that restructured funding for transportation programs. ISTEA authorized increased levels of highway and transportation funding and an increased role for regional planning commissions/MPOs in funding decisions. The Act also requires comprehensive Regional and Statewide long-term Transportation Plans and places an increased emphasis on public participation and transportation alternatives.

### ***Inventory***

See System Inventory.

### ***Joint Program Office (JPO)***

The office of the United States Department of Transportation established to oversee and guide the multi-modal National Intelligent Transportation Systems program.

### ***Legacy System***

Existing transportation systems, communications systems, or institutional processes.

### ***Lifecycle***

A term used when denoting a progression through a series or sequence of differing stages of development.

### ***Logical Architecture***

The Logical Architecture view of the National ITS Architecture defines what has to be done to support the ITS User Services. It defines the Processes that perform ITS functions and the information or Data Flows that are shared between these Processes. The Logical Architecture was developed using Structured Analysis techniques and consists of Data Flow Diagrams, Process Specifications, and Data Dictionary Entries. The Logical Architecture is not technology specific, nor does it dictate a particular implementation. This implementation independence makes the Logical Architecture accommodating to innovation, scalable from small-scale implementations to large regional systems, and supportive of widely varied system designs.

### ***Maintenance Plan***

Description of configuration control and update guidelines for Regional and/or Project ITS Architectures. The primary purpose of the Maintenance Plan is to maintain an Architecture Baseline.

**Major ITS Project**

Any ITS project that implements part of a regional ITS initiative that is multi-jurisdictional, multi-modal, or otherwise affects regional integration of ITS systems.

**Market Package**

Market Packages identify the pieces of the Physical Architecture that are required to implement a particular transportation Service. They provide an accessible, service oriented, perspective to the National ITS Architecture. They are tailored to fit – separately or in combination – real world transportation problems and needs. Market Packages collect together one or more Equipment Packages that must work together to deliver a given transportation Service and the Architecture Flows that connect them and other important external systems.

**Memorandum of Understanding (MOU)**

Institutional agreement that contains a description of the level of effort and integration details necessary for sharing information between ITS elements. An MOU can also address sharing of equipment, maintenance, enforcement, operations, control, etc. An MOU can be used to create a more detailed agreement such as an Interagency, Intergovernmental, Operational, Funding or Master Agreement.

**Metropolitan Planning Organization (MPO)**

The forum for cooperative decision making for the metropolitan planning area.

**Metropolitan Transportation Plan**

This document is the official metropolitan, intermodal transportation plan that is developed through the regional transportation process.

**National ITS Architecture**

A common, established framework for developing integrated transportation systems. The National ITS Architecture is comprised of the Logical Architecture and Physical Architecture, which satisfy a defined set of User Services. The National ITS Architecture is maintained by the United States Department of Transportation (USDOT).

**National Program Plan**

Jointly developed by the USDOT and ITS America with substantial involvement from the broader ITS community. The purpose of the National Program Plan was to guide the development and deployment of ITS. It defined the first 29 User Services that were the basis for the National ITS Architecture development effort.

## ***Operational Concept***

An operational concept identifies the roles and responsibilities of participating agencies and stakeholders. It defines the institutional and technical vision for the region and describes how the system will work at a very high-level, frequently using operational scenarios as a basis.

## ***Physical Architecture***

The Physical Architecture is the part of the National ITS Architecture that provides agencies with a physical representation (though not a detailed design) of the important ITS Interfaces and major system components. The principal elements in the Physical Architecture are the Subsystems and Architecture Flows that connect these Subsystems and Terminators into an overall framework. At the next level of detail, the Physical Architecture identifies Equipment Packages for each Subsystem and assigns Processes identified in the Logical Architecture to these Equipment Packages. Similarly, the Data Flows from the Logical Architecture are grouped together and assigned to Architecture Flows.

## ***Physical Entities***

Persons, places, and things that make up an intelligent transportation system. In the physical architecture, an entity represents a National ITS Architecture subsystem or terminator.

## ***Process***

A function or activity identified in the Logical Architecture view of the National ITS Architecture that is required to support the ITS User Services. The Logical Architecture presents Processes in a top-down fashion beginning with general Processes (e.g., “Manage Traffic”) that are then decomposed into more detailed Processes (e.g., “Provide Traffic Surveillance”, “Monitor HOV Lane Use”). General Processes are defined in terms of more detailed Processes using Data Flow Diagrams. The most detailed Processes are defined in Process Specifications (Pspecs).

## ***Process Specification (Pspec)***

The textual definition of the most detailed Processes identified in the Logical Architecture view of the National ITS Architecture. The Process Specification includes an overview, a set of functional requirements, a complete set of inputs and outputs, and a list of the User Service requirements that are satisfied by the Pspec.

## ***Project ITS Architecture***

A framework that identifies the institutional agreement and technical integration necessary to define an ITS project and its interfaces with other ITS projects and systems.

## ***Project Sequencing***

The order in which projects are deployed. An important part of the transportation planning process is the sequence or order that ITS projects are deployed. The Regional ITS Architecture provides a new way to look at these ITS projects relationships or “dependencies”. By taking these dependencies into account, an efficient sequence can be developed so that projects incrementally build on each other.

## ***Pspec***

Abbreviation for Process Specification.

## ***Region***

The geographical area that identifies the boundaries of the Regional ITS Architecture and is defined by and based on the needs of the participating agencies and other Stakeholders. In metropolitan areas, a Region should be no less than the boundaries of the metropolitan planning area.

## ***Regional ITS Architecture***

A specific, tailored framework for ensuring institutional agreement and technical integration for the implementation of ITS projects or groups of projects in a particular Region. It functionally defines what pieces of the system are linked to others and what information is exchanged between them.

## ***Safe, Accountable, Flexible, Efficient Transportation Equity Act – A Legacy for Users (SAFETEA-LU)***

Passed in 2005, this act reauthorizes federal surface transportation programs through the end of FY2009. SAFETEA-LU is the successor to TEA-21.

## ***Service Boundaries***

The geographic boundary of a specific service or agency that provides a service. An example is the service area of a transit agency. The transit agency provides services only within the defined boundary.

## ***Stakeholders***

Anyone with a vested interest or “stake” in one or more transportation elements within a regional ITS architecture. This includes public agencies, private organizations, special interests, and the traveling public.

## ***Standards***

Documented technical specifications sponsored by a Standards Development Organization (SDO) to be used consistently as rules, guidelines, or definitions of characteristics for the interchange of data. A broad array of ITS Standards is currently

under development that will specifically define the Interfaces identified in the National ITS Architecture.

### ***State Implementation Plan (SIP)***

A document required to be prepared periodically by each state that contain one or more “air-quality non-attainment” areas that describes specific projects that will be constructed and/or operated over the next several years.

### ***Statewide Transportation Improvement Program (STIP)***

This is a document prepared by each state that is a staged, multi-year, statewide, intermodal program of transportation projects which is consistent with the Statewide Transportation Plan and planning processes and Metropolitan Transportation Plans, TIPs and processes.

### ***Statewide Transportation Plan***

This document is the official statewide, intermodal transportation plan that is developed through the statewide transportation process.

### ***Subsystem***

The principal structural element of the Physical Architecture view of the National ITS Architecture. Subsystems are individual pieces of the Intelligent Transportation System defined by the National ITS Architecture. Subsystems are grouped into four classes: Centers, Field, Vehicles, and Travelers. Example Subsystems are the Traffic Management Subsystem, the Vehicle Subsystem, and the Roadway Subsystem. These correspond to the physical world: respectively traffic operations centers, automobiles, and roadside signal controllers. Due to this close correspondence between the physical world and the Subsystems, the Subsystem interfaces are prime candidates for standardization.

### ***Subsystem Diagram***

A diagram which depicts all Subsystems in the National ITS Architecture and the basic communication channels between these Subsystems. This diagram, sometimes informally referred to as a “Sausage” diagram, is a top-level Architecture Interconnect diagram. Variations of this diagram are sometimes used to depict Regional ITS Architectures at a high level.

### ***System***

A collection of hardware, software, data, processes, and people that work together to achieve a common goal. Note the scope of a “system” depends on one’s viewpoint. To a sign manufacturer, a dynamic message sign is a “system”. To a state DOT, the same sign is only a component of a larger Freeway Management “System”. In a Regional ITS



Architecture, a Freeway Management System is a part of the overall surface transportation “system” for the region.

### ***System Inventory***

The collection of all ITS-related Elements in a Regional ITS Architecture.

### ***Systems Engineering***

An interdisciplinary approach and means to enable the realization of successful systems. Systems engineering is a systematic approach that focuses on defining customer needs and required functionality early in the development cycle, documenting requirements, then proceeding with design synthesis and system validation while considering the complete problem.

### ***Terminator***

Terminators define the boundary of an Architecture. The National ITS Architecture Terminators represent the people, systems, and general environment that interface to ITS. The Interfaces between Terminators and the Subsystems and Processes within the National ITS Architecture are defined, but no functional requirements are allocated to Terminators. The Logical and Physical Architecture views of the National ITS Architecture both have exactly the same set of Terminators.

### ***Transit Development Plan***

This document is prepared by the transit agency and identifies transit needs and the changes in services and systems that are recommended to better meet those needs. It will feed information to both the Transportation Plan and the Transportation Improvement Program (TIP).

### ***Transportation Equity Act for the 21<sup>st</sup> Century (TEA-21)***

Passed in 1997 by Congress to address the need to begin work toward regional integration of transportation systems. TEA-21 was the successor reauthorization of the ISTEA legislation and has now been succeeded by SAFETEA-LU.

### ***Transportation Improvement Program (TIP)***

This is a document prepared by each Metropolitan Planning Organization (MPO) listing projects to be funded with FHWA/FTA funds for the next one to three year period. It is consistent with the Metropolitan Transportation Plan.

### ***Transportation Management Area (TMA)***

All urbanized areas over 200,000 in population and all other areas that request designation.

### ***Transportation Plan***

Also called the “Long Range Transportation Plan”, this plan defines the state or metropolitan area’s long-term approach to constructing, operating, and maintaining the multi-modal transportation system.

### ***Traveler Subsystems***

Equipment used by travelers to access ITS services pre-trip and en-route. This includes services that are owned and operated by the traveler as well as services that are owned by transportation and information providers. One of four general Subsystem classes defined in the National ITS Architecture.

### ***Turbo Architecture***

An automated software tool used to input and manage System Inventory, Market Packages, Interconnects and Architecture Flows with regard to a Regional ITS Architecture.

### ***United States Department of Transportation (USDOT)***

The principal direct Federal funding agency for transportation facilities and programs. Includes the Federal Highway Administration (FHWA), the Federal Transit Administration (FTA), the Federal Railroad Administration (FRA), the Federal Motor Carrier Safety Administration (FMCSA), and others.

### ***User Service***

User Services document what ITS should do from the user’s perspective. A broad range of users are considered, including the traveling public as well as many different types of system operators. User Services, including the corresponding user service requirements, form the basis for the National ITS Architecture development effort. The initial User Services were jointly defined by USDOT and ITS America with significant Stakeholder input and documented in the National Program Plan (NPP). The concept of user services allows system or project definition to begin by establishing the high level services that will be provided to address identified problems and needs. Over time, new or updated User Services will continue to be developed and the National ITS Architecture will be updated to support these User Service changes.

### ***User Service Requirement***

A specific functional requirement statement of what must be done to support the ITS User Services. The User Service Requirements were developed specifically to serve as a requirements baseline to drive National ITS Architecture development. The User Service Requirements are not requirements to system/architecture implementers, but rather are directions to the National ITS Architecture development team.

### ***Vehicle Subsystems***

Covers ITS related elements on vehicle platforms. Vehicle Subsystems include general driver information and safety systems applicable to all vehicle types. Three fleet Vehicle Subsystems (Transit, Emergency, and Commercial Vehicles) add ITS capabilities unique to these special vehicle types. One of four general Subsystem classes defined in the National ITS Architecture.

### ***Vehicle-to-Vehicle Communications***

Dedicated wireless system handling high data rate, low probability of error, line of sight communications between vehicles. Advanced vehicle services may use this link in the future to support advanced collision avoidance implementations, road condition information sharing, and active coordination to advanced control systems. One of the four types of Architecture Interconnects defined in the National ITS Architecture.

### ***Wide Area Wireless Communications***

A communications link that provides communications via a wireless device between user and an infrastructure based system. Both broadcast (one-way) and interactive (two-way) communications services are grouped into wide-area wireless communications in the National ITS Architecture. These links support a range of services in the National ITS Architecture including real-time traveler information and various forms of fleet communications. One of the four types of Architecture Interconnects defined in the National ITS Architecture.

# Appendix D Acronyms

<b>AASHTO</b>	American Association of State Highway and Transportation Officials	<b>COG</b>	Council of Governments
<b>ABS</b>	Antilock Brake System	<b>CONOPS</b>	Concept of Operations
<b>AD</b>	Archived Data	<b>COTR</b>	Contracting Officer Technical Representative
<b>ADA</b>	Americans with Disabilities Act	<b>CSP</b>	Communication Service Provider
<b>ADMS</b>	Archived Data Management Subsystem	<b>CV</b>	Commercial Vehicle
<b>ADUS</b>	Archived Data User Service	<b>CVAS</b>	Commercial Vehicle Administration Subsystem
<b>AFD</b>	Architecture Flow Diagram	<b>CVCS</b>	Commercial Vehicle Check Subsystem
<b>AHS</b>	Automated Highway System	<b>CVISN</b>	Commercial Vehicle Information Systems and Networks
<b>AID</b>	Architecture Interconnect Diagram	<b>CVO</b>	Commercial Vehicle Operations
<b>AMPS</b>	Advanced Mobile Phone System	<b>CVS</b>	Commercial Vehicle Subsystem
<b>ANSI</b>	American National Standards Institute	<b>DAB</b>	Digital Audio Broadcast
<b>APTS</b>	Advanced Public Transportation System	<b>DD</b>	Data Dictionary
<b>ASP</b>	Application Service Provider	<b>DDE</b>	Data Dictionary Element
<b>ASTM</b>	American Society for Testing and Materials	<b>DFD</b>	Data Flow Diagram
<b>ATC</b>	Automatic Train Control, Advanced Transportation Controller	<b>DGPS</b>	Differential Global Positioning System
<b>ATIS</b>	Advanced Traveler Information System	<b>DMS</b>	Dynamic Message Sign
<b>ATM</b>	Asynchronous Transfer Mode	<b>DMV</b>	Department of Motor Vehicles
<b>ATMS</b>	Advanced Traffic Management System	<b>DOD</b>	Department of Defense
<b>AVCS</b>	Advanced Vehicle Control System	<b>DOT</b>	Department of Transportation
<b>AVI</b>	Automated Vehicle Identification	<b>DRE</b>	Disaster Response & Evacuation
<b>AVL</b>	Automated Vehicle Location	<b>DSRC</b>	Dedicated Short Range Communications
<b>AVO</b>	Automated Vehicle Operation	<b>DTA</b>	Dynamic Traffic Assignment
<b>CAA</b>	Clean Air Act	<b>DVD</b>	Digital Video Disc
<b>CAD</b>	Computer Aided Dispatch	<b>E9-1-1</b>	Enhanced 9-1-1
<b>CASE</b>	Computer Aided Systems Engineering, Computer Aided Software Engineering	<b>ECPA</b>	Electronic Communications Privacy Act
<b>CCTV</b>	Closed Circuit TV	<b>EDI</b>	Electronic Data Interchange
<b>CD</b>	Compact Disc	<b>EDL</b>	Electronic Document Library
<b>CDMA</b>	Code Division Multiple Access	<b>EDP</b>	Early Deployment Plan
<b>CDPD</b>	Cellular Digital Packet Data	<b>EM</b>	Emergency Management Subsystem
<b>CD-ROM</b>	CD Read Only Memory	<b>EMC</b>	Emergency Management Center
<b>CMS</b>	Changeable Message Sign, Congestion Management System	<b>EMMS</b>	Emissions Management Subsystem
<b>CMP</b>	Congestion Management Process	<b>EMS</b>	Emergency Medical Services
		<b>EPA</b>	Environmental Protection Agency
		<b>ESMR</b>	Enhanced SMR
		<b>ETA</b>	Expected Time of Arrival

<b>ETS</b>	Emergency Telephone Services	<b>ITS-A</b>	Intelligent Transportation Society of America
<b>ETTM</b>	Electronic Toll and Traffic Management	<b>IVHS</b>	Intelligent Vehicle Highway Systems
<b>EVS</b>	Emergency Vehicle Subsystem	<b>IVIS</b>	In-Vehicle Information System
<b>FARS</b>	Fatal Accident Reporting System	<b>JPO</b>	Joint Program Office
<b>FCC</b>	Federal Communications Commission	<b>LAN</b>	Local Area Network
<b>FHWA</b>	Federal Highway Administration	<b>LCD</b>	Liquid Crystal Display
<b>FIPS</b>	Federal Information Processing Standard	<b>LED</b>	Light Emitting Diode
<b>FMC</b>	Freeway Management Center	<b>LEO</b>	Low-Earth Orbit satellite system
<b>FMCSA</b>	Federal Motor Carrier Safety Administration	<b>LPD</b>	Liability and Property Damage
<b>FMS</b>	Fleet and Freight Management Subsystem	<b>LRMS</b>	Location Reference Messaging Standard
<b>FOT</b>	Field Operational Test	<b>LRP</b>	Long Range Plan
<b>FPR</b>	Final Program Review	<b>LRTP</b>	Long Range Transportation Plan
<b>FTA</b>	Federal Transit Administration	<b>MAN</b>	Metropolitan Area Network
<b>FTP</b>	File Transfer Protocol	<b>MCMS</b>	Maintenance and Construction Subsystem
<b>GIS</b>	Geographic Information System	<b>MCO</b>	Maintenance and Construction Operations
<b>GPS</b>	Global Positioning System	<b>MCVS</b>	Maintenance and Construction Vehicle Subsystem
<b>HAR</b>	Highway Advisory Radio	<b>MDI</b>	Model Deployment Initiative
<b>HAZMAT</b>	HAZardous MATerial(s)	<b>MIS</b>	Major Investment Studies
<b>HOV</b>	High Occupancy Vehicle	<b>MMDI</b>	Metropolitan MDI
<b>HRI</b>	Highway Rail Intersection	<b>MMI</b>	Man-Machine Interface (or Interaction)
<b>HSR</b>	High Speed Rail	<b>MOE</b>	Measure Of Effectiveness
<b>HTF</b>	Highway Trust Fund	<b>MOU</b>	Memorandum of Understanding
<b>HTML</b>	Hypertext Markup Language	<b>MPA</b>	Metropolitan Planning Area
<b>HTTP</b>	Hypertext Transfer Protocol	<b>MPH</b>	Miles per Hour
<b>HUD</b>	Head-Up Display	<b>MPO</b>	Metropolitan Planning Organization
<b>IBC</b>	International Border Clearance	<b>MTP</b>	Metropolitan Transportation Plan
<b>IBC</b>	International Border Clearance Document/Drawing	<b>NAAQS</b>	National Ambient Air Quality Standards
<b>ICD</b>	Interface Control Document/Drawing	<b>NAV</b>	Navigation
<b>IDAS</b>	ITS Deployment Analysis System	<b>NEMA</b>	National Electrical Manufacturers Association
<b>IFB</b>	Invitation for Bid	<b>NHI</b>	National Highway Institute
<b>IP</b>	Internet Protocol	<b>NHPN</b>	National Highway Planning Network
<b>IPR</b>	Interim Program Review	<b>NHTSA</b>	National Highway Traffic Safety Administration
<b>ISO</b>	International Standards Organization	<b>NII</b>	National Information Infrastructure (aka Information Superhighway)
<b>ISP</b>	Information Service Provider	<b>NPRM</b>	Notice of Proposed Rule Making
<b>ISTEA</b>	Intermodal Surface Transportation Efficiency Act		
<b>IT</b>	Information Technology		
<b>ITE</b>	Institute of Transportation Engineers		
<b>ITI</b>	Intelligent Transportation Infrastructure		
<b>ITS</b>	Intelligent Transportation Systems		

<b>NTCIP</b>	National Transportation Communications for ITS Protocol	<b>SONET</b>	Synchronous Optical Network
<b>OEM</b>	Original Equipment Manufacturer	<b>SOV</b>	Single Occupancy Vehicle
<b>OSI</b>	Open Systems Interconnection	<b>SOW</b>	Statement of Work
<b>OTP</b>	Operational Test Plan	<b>SQL</b>	Structured Query Language
<b>PC</b>	Personal Computer	<b>SSR</b>	Standard Speed Rail
<b>PCS</b>	Personal Communications System	<b>STIP</b>	Statewide Transportation Improvement Program
<b>PDA</b>	Personal Digital Assistant	<b>STMF</b>	Simple Transportation Management Framework
<b>PE</b>	Preliminary Engineering	<b>STMP</b>	Simple Transportation Management Protocol
<b>PIAS</b>	Personal Information Access Subsystem	<b>STP</b>	Statewide Transportation Plan
<b>PMS</b>	Parking Management Subsystem	<b>TAS</b>	Toll Administration Subsystem
<b>PS&amp;E</b>	Plans, Specifications, and Estimates	<b>TCIP</b>	Transit Communications Interface Profiles
<b>PSPEC</b>	Process Specification	<b>TCP</b>	Transport Control Protocol
<b>PSTN</b>	Public Switched Telephone Network	<b>TCS</b>	Toll Collection Subsystem
<b>PTS</b>	Positive Train Separation	<b>TDM</b>	Travel Demand Management
<b>R&amp;D</b>	Research and Development	<b>TDMA</b>	Time Division Multiple Access
<b>RDS</b>	Radio Data Systems	<b>TEA-21</b>	Transportation Equity Act for the 21st Century
<b>RDS-TMC</b>	Radio Data Systems incorporating a Traffic Message Channel	<b>TIP</b>	Transportation Improvement Program
<b>RFP</b>	Request For Proposal	<b>TM</b>	Traffic Management
<b>RFQ</b>	Request for Quotation	<b>TMA</b>	Transportation Management Area
<b>RS</b>	Roadway Subsystem	<b>TMC</b>	Traffic Management Center
<b>RTA</b>	Regional Transit Authority	<b>TMDD</b>	Traffic Management Data Dictionary
<b>RTP</b>	Regional Transportation Plan	<b>TMS</b>	Traffic Management Subsystem
<b>RTPA</b>	Regional Transportation Planning Agency	<b>TOC</b>	Traffic Operations Center
<b>RTS</b>	Remote Traveler Support Subsystem	<b>TRB</b>	Transportation Research Board
<b>RWIS</b>	Road Weather Information System	<b>TRMC</b>	Transit Management Center
<b>SAE</b>	Society of Automotive Engineers	<b>TRMS</b>	Transit Management Subsystem
<b>SAFETEA-LU</b>	Safe, Accountable, Flexible, Efficient Transportation Equity Act: A Legacy for Users	<b>TRT</b>	Technical Review Team
<b>SC</b>	Single Click	<b>TRVS</b>	Transit Vehicle Subsystem
<b>SDO</b>	Standards Development Organization	<b>UDP</b>	User Datagram Protocol
<b>SDP</b>	Strategic Deployment Plan	<b>UPWP</b>	Unified Planning Work Plan
<b>SEMP</b>	Systems Engineering Management Plan	<b>USDOT</b>	United States Department of Transportation
<b>SIP</b>	Statewide Implementation Plan	<b>USR</b>	User Service Requirement
<b>SMR</b>	Specialized Mobile Radio	<b>VMS</b>	Variable Message Sign
<b>SNMP</b>	Simple Network Management Protocol	<b>VRC</b>	Vehicle/Roadside Communications
		<b>VS</b>	Vehicle Subsystem
		<b>WAN</b>	Wide Area Network
		<b>WIM</b>	Weigh-in Motion
		<b>WWW</b>	World Wide Web



1. Report No. FHWA-HOP-06-112		2. Government Association No.		3 Recipient's Catalog No.	
4. Title and Subtitle: Regional ITS Architecture Guidance developing, using, and maintaining an ITS Architecture for your region			5. Report Date: July 2006		
			6. Performing Organization Code		
7. Author(s): National ITS Architecture Team			8. Performing Organization Report No.		
9. Performing Organization Name and Address Iteris, Inc. 1515 S. Manchester Ave. Anaheim, CA 92802			10. Work Unit No. (TRAIS)		
			11. Contract or Grant No. DTFH61-01-C-00023		
12. Sponsoring Agency Name and Address Department of Transportation, Office of Operations HOTM Room 3404 400 Seventh Street SW Washington, DC 20590			13. Type of Report and Period Covered		
			14. Sponsoring Agency Code		
15. Supplementary Notes: Lee Simmons - Contracting Officer Technical Representative					
16. Abstract  The Regional Intelligent Transportation System (ITS) Architecture Guidance Document is written for those involved in the development, use, or maintenance of regional ITS architectures. It describes a process for creating a regional ITS architecture with supporting examples of each product and discusses mainstreaming ITS into the planning and project development processes. This update expands upon the topics of Using and Maintaining a regional ITS architecture.					
17. Key Word Intelligent Transportation Systems, ITS, Architecture, Planning			18. Distribution Statement: No Restrictions. This document is available to the public.		
19. Security Classif. (of this report) Unclassified		20. Security Classif. (of this page) Unclassified		21. No. of Pages 260 (including front cover page not the back cover)	22. Price \$0.00

Department of Transportation, Office of Operations  
HOTM Room 3404  
400 Seventh Street SW  
Washington, DC 20590  
Toll-Free "Help Line" 866-367-7487  
[www.ops.FHWA.dot.gov](http://www.ops.FHWA.dot.gov)  
Publication No. FHWA-HOP-06-112  
EDL-14317  
July 2006